

The Mushrush - Beckton
Main Event
Nov. 9, 2009

- View and bid and from both locations -

12:00 MT
1:00 CST

WYOMING HEADQUARTERS

1 Beckton
Red Angus

Foundation Herd of the Red Angus Breed

Cam & Sal Forbes
37 Beckton Drive
Sheridan, WY 82801
(307) 674-6095
(307) 674-8162
beckton@wave.com

Selling
300
Red Angus
Females!

125 Registered
150 Commercial
Includes 140 Bred Heifers

Plus 25
Two-year-old+
Bulls

KANSAS HEADQUARTERS

MUSHRUSH
RED ANGUS

*Pen after pen, year after year...
THEY WORK!*

2346B N Rd.
Strong City, KS 66869
Joe (620) 273-8581
Bob (620) 273-8604
www.MushrushRedAngus.com

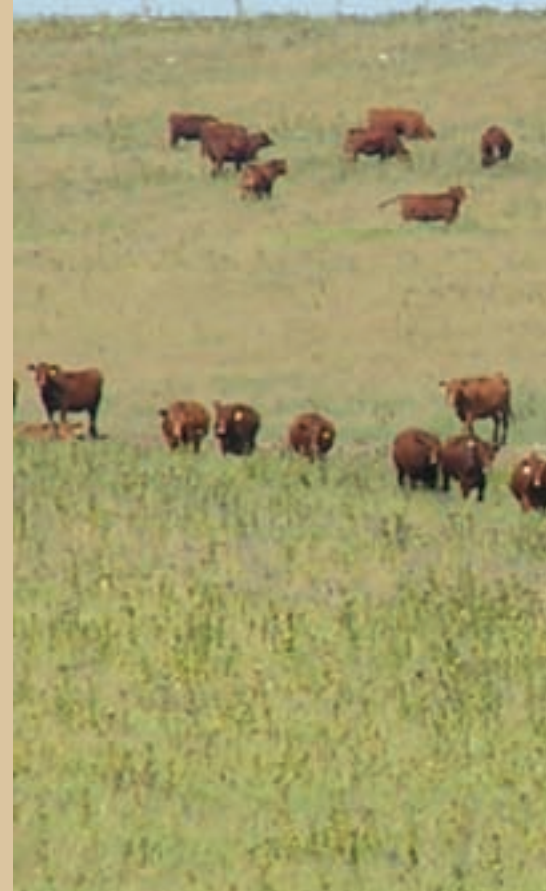

Accommodations

Sheridan, Wyoming

Holiday Inn, 307.672.8931, \$72
Best Western, 307.674.7421
Days Inn, 307.672.2888
Comfort Inn, 307.672.5098
Super 8 Motel, 307.672.9725

Cottonwood Falls, Kansas

Grand Central Hotel, 620.273.6763, \$99
Strong City, Kansas
Prairie Fire Inn, 620.273.6356, \$35-40
Emporia, Kansas (25 miles)
Various chain motels

Transportation

Sheridan, Wyoming (15 minutes)

Great Lakes Airlines, Avis car rental

Billings, Montana (2½ hours)

Various airlines, rental cars

Kansas City, Missouri (2½ hours)

Various airlines, rental cars

Wichita, Kansas (1½ hours)

Various airlines, rental cars

Free Delivery

Registered sale animals from either sale location will be transported to the other sale location at our expense, so these cattle can be picked up at either sale location without cost to the buyer. If the buyer prefers, we can deliver any animals within the continental U.S. Registered females will be delivered for \$200 per stop plus \$75 for each additional female after the first, to the same location; and Registered bulls for \$300 per stop plus \$100 for each additional bull after the first, to the same location. Bulls may be combined with females for any one location. Commercial females will be delivered at cost, and we are happy to arrange transportation and combine loads to minimize cost.

Sight-Unseen Purchase (by mail or phone)

If you are unable to attend the sale, we can help you select the animals to fit your needs. Give us a phone call, letter, fax or e-mail (please refer to the back cover), and we can make arrangements to handle bidding according to your directions. Cattle are bought at the lowest price, and satisfaction is guaranteed on animals purchased sight unseen. Many of our repeat customers buy their bulls and heifers this way.

To provide us adequate time to assist you, please contact us before noon of the day prior to the sale.

Payment

Payments can be made with cash, check payable to Beckton Stock Farm or Mushrush Red Angus, or Visa/Mastercard on sale day.

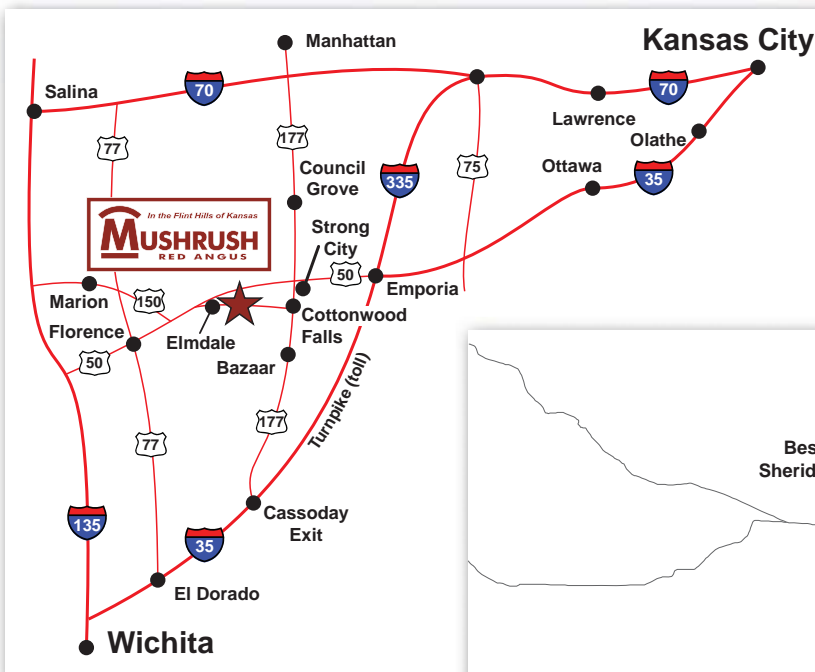

◀ From Elmdale

One mile East on the paved county road across Cottonwood River bridge to top of the hill. Turn left (North) to get to the barn. Watch for the overhead sign to your left.

◀ From Cottonwood Falls

Turn west on Main Street (first street south of the river bridge). Continue west for four miles. The sale barn overlooks a valley to your right. There is an overhead

From Sheridan ▶
Ten miles West on the paved county road 331 (Loucks Street) from Main Street. Turn right to get to the barn.



The Main Event

Two Powerful Red Angus Offerings, Two Locations, One Great Sale

The industry's first ever dual-site production sale! Watch and bid at Mushrush Red Angus Ranch or at Beckton Red Angus-or at home through DV Auction.

Monday, November 9, 2009
12 o'clock Mountain / 1 pm Central

125 Registered Females - 75 Bred Heifers and 50 Bred Cows
145 Commercial Females - 65 Bred Heifers and 80 Bred Cows
25 Bulls from our own breeding program

Beckton Red Angus

9½ miles West of Sheridan, Wyoming
Sale Day Phone: 307.674.6095 / 673.1104



Cam and Trish Forbes

Mushrush Red Angus

1 mile East of Elmdale, Kansas
Sale Day Phones: 620.340.7461 / 341.0745



Joe and Connie Mushrush

Beckton Red Angus is the Red Angus breed's founding herd. Started in 1945, it has since maintained the longest continuous performance testing and improvement program in the industry. Ninety-five per cent of our cattle sell to commercial producers, so our genetic selection program has always been able to produce cattle which will work for the commercial cattle person. There are no other cattle with this long history of performance-based genetic selection, so that today we believe our cattle do more things better.

Mushrush Red Angus has been in the cattle business for over 50 years and in the Red Angus business since 1982. In 1999, we joined with Beckton to offer you a good selection of predictable Red Angus genetics from two herds. Commercial cattle people at heart, we breed them the way we would want them if we were investing in Red Angus genetics for a commercial herd today.

This sale will be broadcast live on the internet.

DVAuction
Broadcasting Real-Time Auctions
Real time bidding & proxy bidding available.

Commercial Females sell first, followed by Registered Females and Bulls in Catalog Order

Additional Sale Information

How The Sale will Work

Mushrush's offering will be on display at their sale facility near Elmdale, Kansas. The Beckton offering will be on display at their Sheridan, WY sale facility. All sale cattle have been videotaped prior to Nov. 9th. In addition, the sale will be broadcast over the internet at DVAuction.com

If you wish to view the sale over the internet you must be a registered viewer at DVAuction.

If you wish to bid over the internet you must register as a buyer at DVAuction for this sale. Watch and bid online for free!

To register:

Visit **www.dvauction.com** and complete "register" & "applying to bid". DVAuction staff will contact you to let you know that you have been approved to bid. Please contact Dan Broz at 402-649-3172 or 402-474-5557 with any questions.

We recommend that you apply to bid 24 hours prior to the sale-every attempt will be made to complete your application in a timely manner.

Note: You must have high speed internet access (DSL, T1, or Broadband) to be able to bid during the sale.

You may view the sale and bid on the entire offering at either sale facility

Sale Representatives



Jerry Gliko
Western Livestock
Journal
406.656.2515



Alan Sears
Western Livestock
Reporter
970-454-3986



Tommy "T.V." Jones
Record Stockman
307.632.5118



Curt Cox
Wyoming Livestock
Roundup
307.630.4604

Brett Spader
DVAuction
785.633.5512

Guy Peverly
High Plains Journal
785.456.4390

Doug Paull
Stock Exchange
303.722.7600



Auctioneer Roger Jacobs
406.698.7686

Additional Notes

- ▶ Commercial Females sell first, followed by Registered Females and Bulls in catalog order.
- ▶ All animals are registered with the Red Angus Association of America, and registration certificates will be transferred to the new owners.
- ▶ All bulls selling have passed a rigorous fertility exam that included live semen evaluation, scrotal measurements, and reproductive tract examinations. All females were pregnancy tested by licensed veterinarians and were determined to be bred and to have sound reproductive tracts.
- ▶ Both herds have had a comprehensive herd-wide health program which includes vaccinations for 7-Way, IBR, BVD, PI3, BRSV, Lepto, and ivermectin or dectomax. The heifers are also vaccinated for brucellosis and vibrio.

Catalog Table of Contents

Cattle Programs & Management	4	Beckton Program Bulls	34-39	Beckton Reference Sires	46-53
Registered Females	5-31	Sale Terms & Conditions	40	Sire Bloodline Charts	54-55
Commercial Females	32-33	Mushrush Reference Sires	41-45	Lot-Tag Cross Ref	56



Dear Red Angus Enthusiasts,

The Forbes and Mushrush families are excited to invite you to our 2009 Main Event sale. Due to the technology of DV Auction we are able to provide you this exiting offering at either sale facility or from the comfort of your own home. As far as we know this is the industry's first ever dual site production sale.

Commercial cattlemen everywhere are searching for ways to reduce costs. They are finding that the easiest is through the use of low maintenance genetics such as those in this sale. Both herds continue to have the lowest Maintenance Energy EPD's of any major Red Angus herds. Both have been selecting for efficient cattle for many years. You can spend years trying to duplicate our results or you can add these already tested, proven genetics today! If you study the catalog you will notice that not only are the ME's the best in the industry, but calving ease, fertility, and carcass quality are added benefits as well.

The cattle industry continues to reduce inventory and is poised for a major economic recovery. Judicious use of low cost genetics such as those available here will have dramatic results at that time.

We invite you to either location on the ninth of November. The Mushrush offering will be on display at the Elmdale, Kansas sale facility and the Beckton offering will be on display at Sheridan, Wyoming. You may participate in the auction at either location. See the catalog for information on delivery options and for purchasing sight unseen with satisfaction guaranteed. If we can be of service, please give Cam or Joe a call.

Sincerely,

The Forbes and Mushrush families

Cattle Programs and Management

The Program - Efficiency

The goal for the Beckton and Mushrush programs has always been to develop breeding seedstock which offer increased levels of performance for the commercial cattleman. Increased performance does not mean maximizing weight and size, which have already reached the upper limit of economic value for the packer and consumer. It does, however, mean increasing performance related to calving percentage and weaning percentage;

and increasing performance related to cow maintenance requirements and “pounds of calf per acre” efficiency.

We select for growth, restricting birth weight and cow size creep, and multiplying each incremental change rapidly throughout our entire cowherd and all of our bloodlines. The overall key to success is simply that we have been making steady progress in multiple traits, and doing it consistently over a very long period of time.

The Program - Management

One Bull – the Simple Solution is the Best Solution

Keeping replacement heifers sired by Beckton and Mushrush genetics is the quickest way to limit cow size creep and to moderate cow size for the future. We get calving ease, growth, and moderate-sized replacements, all with the same bull while Breeding it into the cow herd.

Quietness and Ease of Handling

The necessity of record keeping means that our cattle will be handled much more than commercial cows. This benefits our seedstock customers because our cattle will be quieter and easier to handle. Good disposition is one of our most valued traits. Cattle are used to being handled horseback, with the 4-wheeler and on foot.

The Program - Additional Facts

Birth weight

- ▶ We have never used high birth weight sires in any part of our program, so big birth weights are rare.
- ▶ We get the pay weight, but with lower birth weights and greater calving ease.
- ▶ Full production from heifers. We use the same bulls on heifers and cows.

Hardiness

- ▶ Cows from both herds are true unpampered ‘range cows’ running in large native pastures. Every Beckton cow has spent part of her life in the Bighorn Mountain summer range at elevations from 7,000 to 10,500 feet. Good feet and legs are a must in these environments.

Growth

- ▶ Weaning efficiency, and rate of gain to slaughter weight second to none.
- ▶ Growth traits must be consistent with maintaining maternal qualities.
- ▶ Beckton and Mushrush cattle are ideally sized for today’s packer demand.

Value

- ▶ Beckton and Mushrush Red Angus produce more growth without high birth weights.
- ▶ They are the one-bull solution that can be used on both heifers and cows.
- ▶ Carcass quality is an extra benefit.

Efficiency

- ▶ The typical dam of our bulls weans over 50% of her body weight in 205 days, under range conditions, with no creep-feeding.
- ▶ The average dam produces over 100% of her own body weight in a year.

Integrity

- ▶ Beckton has been genetically improving Red Angus since 1945, while Mushrush Red Angus began over 25 years ago. Both programs have bred with a plan to produce functional, easy fleshing cattle that work in any environment.
- ▶ It is a complete, genetically sound breeding program, which demands whole-herd performance.

Fertility

- ▶ Every bull in our program is used in natural service, with 30-50 heifers/cows.
- ▶ Every cow in our program must cycle naturally and breed early under range conditions.

Registered Bred Heifers and Cows

The Registered bred heifers and cows in this sale were selected to provide a true cross sectional sample of our herds. Included will be heifers and young cows from young upcoming stars of the Red Angus breed, as well as from the proven performers such as LT142, B571, or F075. We are also sharing a group of donor quality matrons which include several dams of outstanding herd sires.

All of these females have been pregnancy examined by our veterinarians and are sold pregnant. We have listed the AI and pasture sires. (Since we use natural service, a female bred by a different sire could be possible, but we will always assist with DNA verification if desired.) Also, in the event any breeder is concerned about OS status, we have examined the past six generations of pedigrees of all females, and

verify that the sale animal has been tested OS Free, or that the six prior generations of every female listed show no OS Carrier. Every buyer can be assured that the females in the sale are the best available anywhere.

Because both of our programs believe in and practice rapid genetic advancement, you will find many of the sires being used are our newest and best genetics, even if they are not yet widely publicized. If you study the EPD's and performance records of these sires in our reference section, they will prove outstanding. Whether your primary interest is production, maternal traits, or reducing Maintenance Energy requirements, we think these are the most advanced animals in the breed today.



MUSHRUSH LANA 9037 (Lot 1)

• Registered Females •

1 **MUSHRUSH LANA 9037**
1A 100% # 658891 Tattoo: MUS 9037

Birth: 3-3-99
 BECKTON LANCER F270 T
 BECKTON LANCER T A664
 BECKTON LANA A754 PC
 MUS MISS CENTER 6026
 MUS 818 C
 PANHANDLE CENTERSTAGE
 FCC RAMBO 502
 PANHANDLE LUCY 8028
 BECKTON LANCER 9380
 BECKTON COCA 9119 TJ
 BECKTON PACER 8940
 BECKTON LANA 7405 NP
 JIT B2283
 MUS 532 C

Calv.Ease	BW	WW	YW	Milk	Tmat	CETM	HPG	Maint.En.	Stay
6	+0.1	35	61	10	28	2	9	-2.0	8
	Marb	-0.08		REA	-0.16		Bfat -0.01		

Talk about a donor prospect! 107 MPPA, Mushrush Lana 9037 has given us 9 top calves in a row at the front of the calving season. Her progeny include two herdsires, Ref. sire A and Ref sire K. This prolific dam is also an alumni of the 2000 National Western Stock Show. 6+ gen OS clear [A.I. Sire N795 Reg. # 916917 (5/26), Pasture Exposure Ref. Sire R (5/31 - 8/6)]



Mushrush Lana 9037
Lot 1



Mushrush Prairie Madam 8019
Lot 2



Mushrush Miss Center 6026
Lot 3

2 **MUS PRAIRIE MADAM 8019**
1A 100% # 611229 Tattoo: MUS 8019

Birth: 2-14-98
 MUS PRAIRIE MASTER 480
 MUS PRARIE MASTER 139
 MUS PRARIE MASTER 811
 MUS GOLDEN LASS 923
 CV PATRIOT 3
 REL ALINE
 CV PATRIOT 3
 REL LDY LULA
 ANKONIAN COMMANDER
 ANKONYB999 LASS15425
 MUS PRARIE MASTER 802
 ANKONY EILEEN GB201
 JIT 33 REL
 JIT B2283

Calv.Ease	BW	WW	YW	Milk	Tmat	CETM	HPG	Maint.En.	Stay
5	-0.9	26	42	22	35	1	7	+6.0	8
	Marb	-0.01		REA	+0.12		Bfat +0.00		

Sporting an Mppa of 111, donor prospect Prairie Madam 8019 shows a different pedigree than most. Outcross genetics for any program with an unmatched production history. This is the genetics that launched Mushrush Red Angus and 8019 would be a great start up for a new breeder or a positive addition for the more experienced. 6+ gen OS clear [Pasture Exposure Ref. Sire O (5/27 - 8/3)]

3 **MUS MISS CENTER 6026**
1A 100% # 530583 Tattoo: MUS 6026

Birth: 2-19-96
 PANHANDLE CENTERSTAGE
 MUS 818 C
 FCC RAMBO 502
 PANHANDLE LUCY 8028
 JIT B2283
 MUS 532 C
 CV FOUR TIMES
 COPPER LASS 2392
 RCN SANDHILL CHF 404
 PANHANDLE BELLE 5085
 CV PATRIOT 3
 REL LDY LULA
 JIT B9 REL
 JIT 21 REL

Calv.Ease	BW	WW	YW	Milk	Tmat	CETM	HPG	Maint.En.	Stay
5	+1.0	28	46	7	21	3	12	.0	5
	Marb	-0.10		REA	+0.07		Bfat +0.01		

Dam of the keeping kind! Miss Center 6026 is the dam of many productive cows at Mushrush Angus including standout 9037, Lot 1. She herself sports an impressive 105 MPPA. A proven top producer who still has a great future. 6+ gen OS clear [Pasture Exposure Ref. Sire O (5/27 - 8/3)]

• Registered Females •

4 **BECKTON CHRISTY L654 JL**
1A 100% # 793745 Tattoo: WF L654

Birth: 3-27-01
 BKT JULIAN 7526 G
BECKTON JULIAN GG B571
 Ref. J-1
 BKT MARTA 9A13 JL
 BECKTON HADRIAN F C486
BECKTON CHRISTY H207 HD
 BECKTON CHRISTY A111 VQ
 BECKTON JULIAN 6592
 BKT BELGA 6746 GS
 BKT JULIAN 7526 G
 BKT MARTA 6498 XM
 BECKTON HADRIAN A100
 BECKTON KURUBA A444 FF
 BECKTON VANQUISH 9977
 BKT CHRISTY 9A01 CL

Calv.Ease	BW	WW	YW	Milk	Tmat	CETM	HPG	Maint.En.	Stay
17	-3.2	26	51	13	26	10	15	-4.0	18
Marb -.01		REA +.15			Bfat +.01				

We are sharing some of our own B571 daughters now that they have replaced themselves in our herd with daughters of their own. The B571's are very nice maternal females, with solid production and many of the traits that are so hard to find elsewhere. Christy shows very nicely balanced EPD's, particularly high for heifer pregnancy and stayability. She was AI bred June 13 to Beckton Nebula M045, Reference Sire N-1, and pasture exposed to Beckton Nebula S543, Reference Sire N-6. Pedigree is 6+ generations OS clear.



Beckton Lana U218 JL
Lot 7

5 **BECKTON LARKEISA P091 J**
1A 100% # 978417 Tattoo: BKT P091

Birth: 2-27-04
 BECKTON JUSTICE C K449
BECKTON JUSTICE CH M056
 BECKTON RUTH K802 HD
 BECKTON LANCER TS D390
BKT LARKEISA M808 LN
 BKT LARKEISA D855 CL
 BECKTON JUSTICE G302
 BKT LARKABEL C742 CF
 BECKTON HADRIAN F C486
 BECKTON RUTH G534 NP
 BECKTON LANCER T A664
 BECKTON COCA 7536 SB
 BECKTON CLIPPER JM A124
 BKT LARKEISA Z823 SU

Calv.Ease	BW	WW	YW	Milk	Tmat	CETM	HPG	Maint.En.	Stay
15	-4.2	23	50	9	21	5	12	-4.0	14
Marb +.24		REA -.08			Bfat -.01				

Larkeisa P091 is a half sister to our #1 high selling bull this spring, and from the same Justice sire that produced the \$35,000 high selling bull in 2008. She is a very low maintenance energy, high producing young female whose calves average 109 at weaning and 106 at yearling. AI bred 6/15 to the past birth weight trait leader Beckton Nomad 9871 (#314536), and pasture exposed to Beckton Nebula S543, Reference Sire N-6. Pedigree is 6+ generations OS clear.

7 **BECKTON LANA U218 JL**
1A 100% # 1259118 Tattoo: WF U218

Birth: 3-13-08
 BECKTON JULIAN GJ P535
BECKTON JULIAN G5 S107
 Ref. J-4
 BECKTON MINOLA P826 DM
 BECKTON DOMINOR ZC M919
BECKTON LANA S476 DM
 BECKTON LANA H725 CH
 BKT JULIAN 7526 G
 BECKTON MONA D086 JL
 BECKTON DOMINOR ZC M919
 BECKTON MINOLA M641 WR
 BECKTON DOMINOR Z E401
 BECKTON BARMAID J012 CO
 BECKTON CHAMP RK E121
 BECKTON LANA E937 NM

Calv.Ease	BW	WW	YW	Milk	Tmat	CETM	HPG	Maint.En.	Stay
11	-2.5	23	59	16	27	3	12	.0	17
Marb +.18		REA +.06			Bfat +.00				

One of our most prolific cow lines, Lana, produced this nice heifer. Look at her EPD's all the way across – low birth weight, good growth and milk, low maintenance energy, very high stayability. Pasture exposed to a new young low maintenance and carcass sire with very high stayability himself, Beckton Likable U091, Reference Sire L-4. Pedigree is 6+ generations OS clear.

6 **BKT LARKABEL K768 EP**
1A 100% # 736751 Tattoo: WF K768

Birth: 4-5-00
 BECKTON EPIC D404
BECKTON EPIC K F075
 BECKTON BELGA D483 KR
 BECKTON MILEBAR BX 9822
BKT LARKABEL E645 MB
 BKT LARKABEL 8697 RR
 BECKTON SAGA KJ B702
 BECKTON KURUBA B508 PC
 BECKTON KAISER FD 9253
 BECKTON BELGA A036 MB
 BKT MILEBAR 7958B
 BKT MAGNUM EMERA5827
 CWH RED RITO 457
 BKT LARKABEL 7749 NV

Calv.Ease	BW	WW	YW	Milk	Tmat	CETM	HPG	Maint.En.	Stay
8	-3.1	24	50	16	28	-1	15	-5.0	12
Marb +.06		REA -.21			Bfat +.01				

A rare own daughter of Beckton Epic F075. Larkabelle's calves have averaged 106 weaning ratio and over 100 at yearling. Her MPPA is 105. She herself weighs 1100 pounds even, is a very efficient, low maintenance energy cow and one of the highest for heifer pregnancy. Larkabelle is pasture exposed back to a young herd sire son descended from F075, Beckton Epic T330, Reference Sire E-4, so this is a unique opportunity to get a line-bred Epic calf. Pedigree is 6+ generations OS clear.

8 **BECKTON BELGA U262 JL**
1A 100% # 1259407 Tattoo: BKT U262

Birth: 3-15-08
 BECKTON JULIAN GG B571
BECKTON JULIAN G3 P608
 BKT SUFFEINA A828 DM
 BECKTON VEGAS PK F485
BECKTON BELGA L261 VG
 BECKTON BELGA D054 GL
 BKT JULIAN 7526 G
 BKT MARTA 9A13 JL
 BECKTON DOMINOR 9455
 BKT SUFFEINA 9493 TT
 BECKTON VEGAS P D462
 BECKTON LAKME D399 KR
 BECKTON GALAHAD KK B186
 BECKTON BELGA B754 RN

Calv.Ease	BW	WW	YW	Milk	Tmat	CETM	HPG	Maint.En.	Stay
18	-7.1	13	35	15	22	4	8	-4.0	19
Marb +.01		REA -.11			Bfat +.00				

A terrific Belga dam suggests a potentially terrific heifer. Belga's dam is producing for us at eight years of age, with an average birth weight for her calves under 70 pounds, but progeny weaning and yearling ratios much above average at 107 and 104. Pasture exposed to Beckton Epic T524, Reference Sire E-5. Pedigree is 6+ generations OS clear.

• Registered Females •

9 **BECKTON ENCINO U097 LI**
1A 100% # 1259150 Tattoo: WF U097

Birth: 3-2-08
 BECKTON LIKABLE S633
 BECKTON ENCINO S792 NX

```

    / BECKTON LANCER F442 T
    / BECKTON KIT F468 JL
    / BECKTON NEXUS L016
    / BECKTON ENCINO L327 EP
    \ BECKTON LANCER T A664
    \ BKT SUFFEINA A828 DM
    \ BECKTON JULIAN GG B571
    \ BECKTON KIT A517 NP
    \ BECKTON NEPTUNE R1 J245
    \ BECKTON COCA J276 CL
    \ BECKTON EPIC KN H110
    \ BECKTON ENCINO F103 CR
    
```

Calv.Ease	BW	WW	YW	Milk	Tmat	CETM	HPG	Maint.En.	Stay
14	-4.7	26	55	12	25	3	10	.0	16
	Marb +.06			REA +.26			Bfat +.00		

Nice EPD's all the way across. Look up the new herd sire that she is pasture exposed to, Beckton Epic T524, as he is a strong sire all the way across also. Pedigree is 6+ generations OS clear.



Mushrush Goldie AF U123
Lot 11



Mushrush Lana LT U003
Lot 10

11 **MUSHRUSH GOLDIE AF U123**
1A 100% # 1245798 Tattoo: MUS U123

Birth: 3-11-08
 BROWN-CBAR AFFIRMED P7081
 MUSHRUSH GOLDIE 0158

```

    / BFCK CHEROKEE CNYN 4912
    / BROWN MS ABIGRACE L7730
    / BECKTON LANCER F270 T
    / MUS MISS CHIEFDOM 5093
    \ BUF CRK CHF 824-1658
    \ MRM 1431 8611 9109
    \ GLACIER LOGAN 210
    \ LCHMN ABIGAIL E1013
    \ BECKTON LANCER T A664
    \ BECKTON LANAA754 PC
    \ MUS PRAIRIE CHIEFDOM350
    \ MUS GOLDEN GIRL 245
    
```

Calv.Ease	BW	WW	YW	Milk	Tmat	CETM	HPG	Maint.En.	Stay
7	-1.1	36	66	15	33	1	6	+3.0	11
	Marb +.00			REA +.25			Bfat -.01		

Affirmed P7081 is becoming known breed wide as the calving ease Abigrace. U123 is a stylish heifer that does it all well. 6+ gen OS clear [Pasture Exposure Ref. Sire B (5/20 - 8/1)]

10 **MUSHRUSH LANA LT U003**
1A 100% # 1245975 Tattoo: MUS U003

Birth: 2-9-08
 TR JULIAN LT142
 MUSHRUSH LANA EP S066

```

    / BECKTON JULIAN GG B571
    / TR LANA G760
    / MUSHRUSH EPIC N223
    / MRM 916 H175 L65
    \ BKT JULIAN 7526 G
    \ BKT MARTA 9A13 JL
    \ BECKTON CODY V E023
    \ BECKTON LANA E828 SC
    \ BECKTON EPIC K F075
    \ ROSEBUD 3574
    \ MRM LANCER 916
    \ MRM CE F32 H175
    
```

Calv.Ease	BW	WW	YW	Milk	Tmat	CETM	HPG	Maint.En.	Stay
14	-3.3	34	65	17	34	8	16	-1.0	16
	Marb +.15			REA -.06			Bfat +.00		

What a way to start the heifer sale! Combine the rare Julian LT 142 and Epic F075 and you get a heifer we really don't want to part with. Eight EPDs rank in top 25% of the breed (5 in the top 10%). Lana LT U003 showcases the perfect female. Breed leading stayability, heifer pregnancy, and maintenance energy. . 6+ gen OS clear [A.I. Sire N-1 (5/19), Pasture Exposure Ref. Sire C (5/25 - 8/3)]

12 **MUSHRUSH ZENA AF U004**
1A 100% # 1245976 Tattoo: MUS U004

Birth: 2-8-08
 BROWN-CBAR AFFIRMED P7081
 MUSHRUSH ZENA JL S068

```

    / BFCK CHEROKEE CNYN 4912
    / BROWN MS ABIGRACE L7730
    / MUSHRUSH JULIAN N117
    / MUSHRUSH ZENA 0008
    \ BUF CRK CHF 824-1658
    \ MRM 1431 8611 9109
    \ GLACIER LOGAN 210
    \ LCHMN ABIGAIL E1013
    \ MUSHRUSH JULIAN 1005
    \ MUS PRAIRIE MADAM 5089
    \ BUF CRK VAQUERO 1626
    \ MUS MISS ZENITH 5003
    
```

Calv.Ease	BW	WW	YW	Milk	Tmat	CETM	HPG	Maint.En.	Stay
9	-2.3	31	59	15	31	1	8	+3.0	12
	Marb +.13			REA +.30			Bfat -.01		

Like we mentioned before, Affirmed is a calving ease Abigrace- which is evident in Mushrush Zena U004. Carcass potential to improve your herd. 6+ gen OS clear [Pasture Exposure Ref. Sire C (5/25 - 8/3)]

• Registered Females •

13 MUSHRUSH HANNA JL U008
1A 100% # 1245995 Tattoo: KCS U008

Birth: 2-9-08

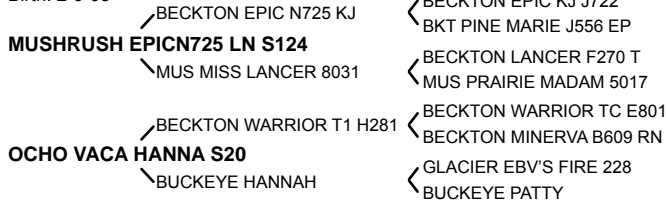

Calv.Ease	BW	WW	YW	Milk	Tmat	CETM	HPG	Maint.En.	Stay
11	-1.6	26	62	8	21	3	12	-2.0	11
Marb +0.06		REA -0.07		Bfat +0.00					

Traces 2xs to Epic F075 and Warrior H281. We can't think of a better combination for this fancy herd improver. 6+ gen OS clear [Pasture Exposure Ref. Sire C (5/25 - 8/3)]



Mushrush Primrose JL U020
Lot 14

15 MUSHRUSH LANA AF U033
1A 100% # 1245872 Tattoo: MUS U033

Birth: 2-22-08

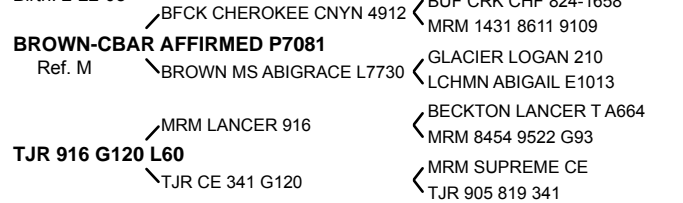

Calv.Ease	BW	WW	YW	Milk	Tmat	CETM	HPG	Maint.En.	Stay
5	+1.1	37	64	15	34	1	7	+2.0	11
Marb +0.12		REA +0.13		Bfat +0.00					

Another easy keeping Affirmed daughter with lots of growth and carcass. 6+ gen OS clear [A.I. Sire B, Pasture Exposure Ref. Sire C (5/25 - 8/3)]



Beckton Kuruba U293 JL
Lot 16

14 MUSH PRIMROSE JL U020
1A 100% # 1245950 Tattoo: MUS U020

Birth: 2-19-08

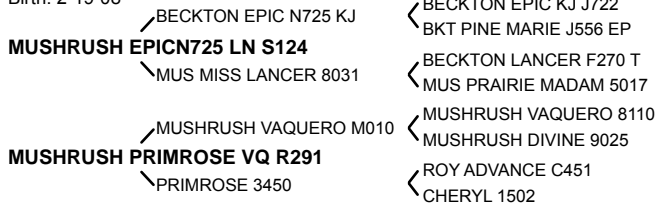

Calv.Ease	BW	WW	YW	Milk	Tmat	CETM	HPG	Maint.En.	Stay
3	+2.4	32	58	12	28	0	9	+4.0	11
Marb +0.07		REA -0.15		Bfat +0.00					

The Vaquero line is know for easy fleshing genetics useful in grass based finishing operations. 6+ gen OS clear [Pasture Exposure Ref. Sire C (5/25 - 8/3)]

16 BECKTON KURUBA U293 JL
1A 100% # 1259114 Tattoo: WF U293

Birth: 3-16-08

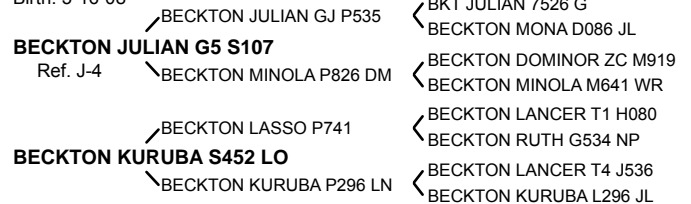

Calv.Ease	BW	WW	YW	Milk	Tmat	CETM	HPG	Maint.En.	Stay
11	-1.9	25	59	10	22	4	11	-1.0	17
Marb +0.13		REA +0.07		Bfat +0.00					

Kuruba has nicely balanced EPD's with low maintenance energy EPD and high stayability. Pasture exposed to Beckton Epic T524, Reference Sire E-5. Pedigree is 6+ generations OS clear.

• Registered Females •

17 BECKTON LANA U569 JT
1A 100% # 1258939 Tattoo: WF U569

Birth: 3-26-08

BECKTON JET L P491
 TR JULIAN LT151
 BECKTON MINERVA L278 LN

BECKTON LANA N406 LO
 BECKTON LOKI F251
 BECKTON LANA E574 KR

BECKTON JULIAN GG B571
 MS GEOMETRIC 917

BECKTON LANCER TS D390
 BECKTON MINERVA F495 CH

BECKTON LANCER TZ D525
 BKT PINE MARIE D126 JL

BECKTON KAISER FV Z559
 BECKTON LANA 9084 DR

Calv.Ease	BW	WW	YW	Milk	Tmat	CETM	HPG	Maint.En.	Stay
18	-7.6	17	34	19	27	5	7	.0	19
Marb +.14		REA -.02		Bfat +.00					

+19 for stayability, 0 for maintenance energy, +19 for milk, -7.6 for birth weight are some impressive EPD's. Lana's dam has been a highly fertile cow, breeding in the first cycle every year and calving early. Pasture exposed to Beckton Beckton Epic T524, Reference Sire E-5. Pedigree is 6+ generations OS clear.

20 BECKTON LARKABA U657 JL
1A 100% # 1259590 Tattoo: BKT U657

Birth: 3-31-08

BECKTON JULIAN G3 P608
 BECKTON JULIAN GG B571
 BKT SUFFEINA A828 DM

BECKTON LARKABA R615 JE
 BECKTON JULES L429
 BECKTON LARKABA M715 WR

BKT JULIAN 7526 G
 BKT MARTA 9A13 JL

BECKTON DOMINOR 9455
 BKT SUFFEINA 9493 TT

BECKTON JULIAN G1 J526
 BECKTON BARONA J591 EP

BECKTON WARRIOR C C355
 BECKTON LARKABA D388 SC

Calv.Ease	BW	WW	YW	Milk	Tmat	CETM	HPG	Maint.En.	Stay
19	-7.4	12	33	14	20	6	10	-8.0	21
Marb +.09		REA +.05		Bfat +.00					

A Julian B571 grand-daughter, Larkaba features one of the highest Stayability EPD's in the breed at +21, plus an exceptional maintenance energy EPD at -8. Pasture exposed to Beckton Epic T524, Reference Sire E-5. Pedigree is 6+ generations OS clear.

18 BECKTON LANA U653 VA
1A 100% # 1259585 Tattoo: BKT U653

Birth: 3-31-08

BECKTON VEGA P079
 BECKTON VEGAS S1 K316
 Ref. V-1
 BECKTON LYDIA H159 JL

BECKTON LANA R561 NB
 BECKTON NEBULA M045
 BECKTON LANA A634 SC

BECKTON VEGAS SV H078
 BECKTON EOLA H073 EP

BECKTON JULIAN GG B571
 BECKTON LYDIA D386 CL

BECKTON NEPTUNE R2 K065
 BECKTON BELGA K285 JL

BECKTON SCAMP 8954
 BECKTON LANA 8400 RN

Calv.Ease	BW	WW	YW	Milk	Tmat	CETM	HPG	Maint.En.	Stay
15	-3.5	26	51	14	27	5	13	+1.0	16
Marb +.01		REA +.12		Bfat +.00					

We seem to have an endless treasure chest of good Lana cows. If this heifer turns out at all like her mother, she will be great. Her dam has calves averaging less than 70 pounds at birth, but weaning at 105 and 108 by yearling. Pasture exposed to Beckton Likable U091, Reference Sire L-4. Pedigree is 6+ generations OS clear.

21 BECKTON MINERVA U467 JL
1A 100% # 1259364 Tattoo: BKT U467

Birth: 3-22-08

BECKTON JULIAN G3 P608
 BECKTON JULIAN GG B571
 BKT SUFFEINA A828 DM

BECKTON MINERVA F589 CD
 BECKTON CODY C401
 BECKTON MINERVA A392 LN

BKT JULIAN 7526 G
 BKT MARTA 9A13 JL

BECKTON DOMINOR 9455
 BKT SUFFEINA 9493 TT

BECKTON CLIPPER JL A095
 BECKTON SCARLET A742 RB

BECKTON LANCER 9380
 BKT MINERVA 8636 NV

Calv.Ease	BW	WW	YW	Milk	Tmat	CETM	HPG	Maint.En.	Stay
18	-6.2	13	34	12	18	5	10	-2.0	18
Marb +.14		REA +.01		Bfat +.00					

This nice heifer is out of one of the grand matrons of Beckton, Minerva F589. She is now thirteen years of age having never missed a calf, and the vet thinks she was one of the first cows bred this spring. Minerva should be excellent for fertility and longevity. Pasture exposed to Beckton Likable U091, Reference Sire L-4. Pedigree is 6+ generations OS clear.

19 BECKTON LAKME U221 CT
1A 100% # 1258858 Tattoo: WF U221

Birth: 3-13-08

BKT CLIFFTOP TP R288
 BECKTON CLIFFTOP T C075
 Ref. B-1
 BECKTON CHRISTY K209 CO

BECKTON LAKME J021 LT
 BECKTON LATIGO G714
 BECKTON LAKME G298 CL

BJR TOPPER 5241
 BECKTON BARMAID A761 TR

BECKTON COPPER JT G095
 BECKTON CHRISTY A111 VQ

BECKTON LANCER TZ D525
 BECKTON MARTA Z381 CL

BECKTON CLIPPER KC D400
 BECKTON LAKME A062 VQ

Calv.Ease	BW	WW	YW	Milk	Tmat	CETM	HPG	Maint.En.	Stay
15	-6.0	8	38	13	17	3	7	+2.0	14
Marb -.02		REA +.17		Bfat +.00					

Some nice longevity with Lakme, as her dam produced for us for nine years before we sold her. All of her calves but one were heifers. Pasture exposed to Beckton Epic U749, Reference Sire E-9, a new sire with -0.7 BW, +80 YW, 0 ME, +17 Stay, and very high for both ribeye and marbling. Pedigree is 6+ generations OS clear.

22 MUSHRUSH MADMA LN U037
1A 100% # 1245811 Tattoo: MUS U037

Birth: 2-23-08

BUF CRK LANCER R017
 BECKTON LANCER F442 T
 Ref. N
 BUF CRK JULIET N036

MUSHRUSH MADAM 1045
 MUSHRUSH LANCER 8115
 MUS PRAIRIE MADAM 476

BECKTON LANCER T A664
 BKT SUFFEINA A828 DM

BECKTON JULIAN GG B571
 BUF CRK PRIMROSE 5679

BECKTON LANCER F270 T
 MUS MISS CHIEFDOM 457

MUS PRARIE MASTER 904
 MUS GOLDEN GIRL 132

Calv.Ease	BW	WW	YW	Milk	Tmat	CETM	HPG	Maint.En.	Stay
7	+1.4	33	63	12	29	3	8	-4.0	16
Marb +.12		REA +.14		Bfat +.00					

Buf Crk Lancer R017 has rocketed in popularity following his OSF status. Out of Romeo's full sister, he stamps out consistent, thick, easy fleshing, carcass genetics. Several top herds in the country are using him but you won't find many daughters offered for sale. 6+ gen OS clear [Pasture Exposure Ref. Sire C (5/25 - 8/3)]

• Registered Females •



Mushrush Madam OS U088
Lot 23

25 MUSH PRIMROSE AF U117
1A 100% # 1245826 Tattoo: DANS U117

Birth: 3-10-08

BROWN-CBAR AFFIRMED P7081
Ref. M

PRIMROSE 3487

BFCK CHEROKEE CNYN 4912
BROWN MS ABIGRACE L7730
ROY ADVANCE C451
ABIGALE 2601

BUF CRK CHF 824-1658
MRM 1431 8611 9109
GLACIER LOGAN 210
LCHMN ABIGAIL E1013
JKG MILK MAN Y962
BECKY 1366
DENVER DYNASTY
TEMPTATION 542

Calv.Ease	BW	WW	YW	Milk	Tmat	CETM	HPG	Maint.En.	Stay
3	+0.7	38	64	21	40	1	10	+11.0	9
	Marb	+1.10		REA	+2.25		Bfat	-.01	

A high growth Affirmed daughter that is unrelated to any other Mushrush or Beckton genetics. 6+ gen OS clear [A.I. Sire E, Pasture Exposure Ref. Sire C (5/23 - 8/1)]

23 MUSHRUSH MADAM OS U088
1A 100% # 1245891 Tattoo: MUS U088

Birth: 3-5-08

MUSHRUSH ROCKET P016
Ref. K

MUSHRUSH MADAM N056

TR JULIAN LT142
MUSHRUSH LANA 9037
MUSHRUSH VAQUERO 8110
MUS PRAIRIE MADAM 414

BECKTON JULIAN GG B571
TR LANA G760
BECKTON LANCER F270 T
MUS MISS CENTER 6026
BUF CRK VAQUERO 1626
MUS HEAVY GIRL 412
MUS PRARIE MASTER 139
MUS GOLDEN GIRL 201

Calv.Ease	BW	WW	YW	Milk	Tmat	CETM	HPG	Maint.En.	Stay
8	+1.1	40	73	11	31	4	10	.0	13
	Marb	-.16		REA	-.06		Bfat	-.01	



Mushrush Candice JL U078
Lot 26

26 MUSHRUSH CANDICE JL U078
1A 100% # 1246002 Tattoo: KCS U078

Birth: 3-2-08

MUSHRUSH EPICN725 LN S124

OCHO VACA MIS CYN WAR S37

BECKTON EPIC N725 KJ
MUS MISS LANCER 8031
BECKTON WARRIOR T1 H281
MRM 5180 9605 0008

BECKTON EPIC KJ J722
BKT PINE MARIE J556 EP
BECKTON LANCER F270 T
MUS PRAIRIE MADAM 5017
BECKTON WARRIOR TC E801
BECKTON MINERVA B609 RN
BUF CRK CANYON 5180
MRM 9409 9328 9605

Calv.Ease	BW	WW	YW	Milk	Tmat	CETM	HPG	Maint.En.	Stay
8	-1.3	24	58	11	23	1	12	+1.0	8
	Marb	+0.06		REA	-1.18		Bfat	+0.00	

A Warrior x Epic – again in a calving ease low maintenance package. tested OS free [Pasture Exposure Ref. Sire C (5/25 - 8/3)]

24 MUSHRUSH ATHENA LN U137
1A 100% # 1245833 Tattoo: MUS U137

Birth: 3-15-08

BUF CRK LANCER R017
Ref. N

ATHENA 3519

BECKTON LANCER F442 T
BUF CRK JULIET N036
ROY'S BETTER HEAVY 1413
ALICE 2792

BECKTON LANCER T A664
BKT SUFFEINA A828 DM
BECKTON JULIAN GG B571
BUF CRK PRIMROSE 5679
LEACHMAN BETTER HVY8041
RCN KURUBA CP 605
ROY'S HALLELUJAH 1691
MATTIE 2352

Calv.Ease	BW	WW	YW	Milk	Tmat	CETM	HPG	Maint.En.	Stay
6	+2.5	36	56	16	34	4	6	-5.0	13
	Marb	+0.32		REA	+1.10		Bfat	-.01	

Another thick easy keeping (ME EPD top 2%) R017 daughter. Her astounding 179 IMF ratio places her in the top 2% of the breed for Marb EPD. 6+ gen OS clear [Pasture Exposure Ref. Sire B (5/20 - 8/1)]

• Registered Females •

27 MUSHRUSH CENTI LN U128
1A 100% # 1245879 Tattoo: MUS U128

Birth: 3-12-08
 BECKTON LANCER F442 T
BUF CRK LANCER R017
 Ref. N
 BECKTON JULIET N036
 BECKTON LANCER F270 T
MUSHRUSH CENTI M042
 MUS MISS CENTER 6026
 BECKTON LANCER T A664
 BKT SUFFEINA A828 DM
 BECKTON JULIAN GG B571
 BUF CRK PRIMROSE 5679
 BECKTON LANCER T A664
 BECKTON LANA A754 PC
 PANHANDLE CENTERSTAGE
 MUS 818 C

Calv.Ease	BW	WW	YW	Milk	Tmat	CETM	HPG	Maint.En.	Stay
10	-1.8	30	57	10	25	4	8	.0	15
Marb +.06		REA +.09		Bfat -.01					

The sire is again Buf Crk Lancer R017 and maternal granddam is our Lot 3 donor matron 6026. That explains the top6% Stayability. 6+ gen OS clear [Pasture Exposure Ref. Sire C (5/23 - 8/3)]

29 BECKTON LANA U069 JL
1A 100% # 1259637 Tattoo: BKT U069

Birth: 2-27-08
 BECKTON JULIAN GJ P535
BECKTON JULIAN G5 S107
 Ref. J-4
 BECKTON MINOLA P826 DM
 BECKTON JULIAN GJ P535
BECKTON LANA S126 JL
 BECKTON LANA P026 DM
 BKT JULIAN 7526 G
 BECKTON MONA D086 JL
 BECKTON DOMINOR ZC M919
 BECKTON MINOLA M641 WR
 BKT JULIAN 7526 G
 BECKTON MONA D086 JL
 BECKTON DOMINOR ZC M919
 BECKTON LANA M552 WR

Calv.Ease	BW	WW	YW	Milk	Tmat	CETM	HPG	Maint.En.	Stay
12	-2.6	21	51	9	19	5	11	-2.0	20
Marb +.17		REA +.13		Bfat +.00					

A linebred Julian heifer that is very low for maintenance energy EPD and high in the carcass traits. Pasture exposed to our new sire Beckton Likable U091, Reference Sire L-4, who is also exceptional for carcass traits and low for maintenance requirements, so the calf should be tops in areas of importance today. Pedigree is 6+ generations OS clear.



Beckton Rose U295 NM
Lot 28

30 BECKTON MONA U056 EP
1A 100% # 1259158 Tattoo: WF U056

Birth: 2-26-08
 BECKTON EPIC KM M115
BECKTON EPIC K6 S569
 Ref. E-3
 BECKTON SIERRA N703 LM
 BECKTON NEBULA L P093
BECKTON MONA S878 NB
 BECKTON MONA P719 EP
 BECKTON EPIC K F075
 BECKTON MINERVA F495 CH
 BECKTON LARAMIE L044
 BECKTON SIERRA L887 LN
 BECKTON NEBULA M045
 BECKTON MARTA M021 LN
 BECKTON EPIC KJ J722
 BECKTON MONA L571 EP

Calv.Ease	BW	WW	YW	Milk	Tmat	CETM	HPG	Maint.En.	Stay
11	-2.5	27	61	11	24	3	9	+1.0	16
Marb +.14		REA +.12		Bfat +.00					

This Mona line heifer has nicely balance EPD's, strong in the carcass traits, and she is pasture exposed to our new sire Beckton Likable U091, Reference Sire L-4. Likable is also strong in the carcass traits, so the calf could be outstanding. Pedigree is 6+ generations OS clear.

28 BECKTON ROSE U295 NM
1A 100% # 1258921 Tattoo: WF U295

Birth: 3-16-08
 BECKTON NOMAD 7496
BECKTON NOMAD V 9871
 BKT BARMAID 6986 VR
 BECKTON WARRIOR T C371
BECKTON ROSE M872 WR
 BECKTON ROSE D198 JL
 BECKTON NEVA 5562
 BKT BOLT TAMRCK 3913
 BECKTON VARO 5642
 BKT LAHROGNO-3
 JKG CHIEFTON L303
 BECKTON TAMLA A671 TR
 BECKTON JULIAN GG B571
 BECKTON ROSE B761 CB

Calv.Ease	BW	WW	YW	Milk	Tmat	CETM	HPG	Maint.En.	Stay
18	-6.9	12	16	11	17	5	7	-13.0	12
Marb +.03		REA -.10		Bfat +.00					

Rose has one of the lowest maintenance energy EPD's in the breed, and her dam is noteworthy for high fertility, with all of her calves in the first cycle and all but one calving in the first week and a half of the calving season. Pasture exposed to Beckton Likable U091, Reference Sire L-4. Pedigree is 6+ generations OS clear.

31 BKT LARKEISA U259 CD
1A 100% # 1259070 Tattoo: WF U259

Birth: 3-14-08
 BECKTON CODY KH M390
BECKTON CODY K2 R168
 Ref. C-1
 BECKTON TAMARA K249 VG
 BECKTON JUSTICE C K449
BKT LARKEISA R775 JC
 BKT LARKEISA L149 CK
 BECKTON CODY K G701
 BECKTON TAMARA J124 HR
 BECKTON VEGAS SV H078
 BECKTON TAMARA HA38 WR
 BECKTON JUSTICE G302
 BKT LARKABEL C742 CF
 BECKTON COLT G552
 BKT LARKEISA E578 HB

Calv.Ease	BW	WW	YW	Milk	Tmat	CETM	HPG	Maint.En.	Stay
12	-3.1	35	77	15	33	5	12	+5.0	11
Marb +.00		REA +.04		Bfat +.00					

Out of a top young dam, a Larkeisa cow with progeny ratio averages of 105 for weaning and 109 for yearling. Larkeisa U259 really spreads low birth weight with high yearling, just what many commercial cattlemen want. Pasture exposed to Beckton Likable U130, Reference Sire L-5, a new sire that is +.73 for Ribeye EPD. Pedigree is 6+ generations OS clear.

• Registered Females •

32 BECKTON INDIGO U658 JL
 1A 100% # 1259059 Tattoo: WF U658

Birth: 3-31-08

BECKTON JULIAN GJ P535
 BKT JULIAN 7526 G
 BECKTON MONA D086 JL

BECKTON INDIGO R567 WA
 BECKTON WARHAWK N560
 BECKTON INDIGO N754 HR

BECKTON JULIAN 6592
 BKT BELGA 6746 GS
 BECKTON JULIAN GV Z693
 BECKTON MONA 9356 KR
 BECKTON WARRIOR T1 H281
 BECKTON FIREFLY H195 HD
 BECKTON HERALD F1 L151
 BECKTON INDIGO LC22 LO

Calv.Ease	BW	WW	YW	Milk	Tmat	CETM	HPG	Maint.En.	Stay
15	-4.9	24	51	10	21	5	13	-2.0	18
Marb +.12		REA +.04		Bfat +.00					

This Indigo heifer comes from a superior young dam with progeny averages of 103 for weaning and 103 for yearling. Pasture exposed to Beckton Likable U130, Reference Sire L-5, a new Beckton sire with a ribeye EPD of +.73. Pedigree is 6+ generations OS clear.



*Mushrush Loga LN U167
Lot 35*

33 BECKTON LANA U660 JD
 1A 100% # 1259030 Tattoo: WF U660

Birth: 4-1-08

TR JULIAN RT561
 TR JULIAN LT151
 Ref. J-3 TR DYNA HT824

BECKTON LANA R205 EP
 BECKTON EPIC K4 N795
 BECKTON LANA N540 VG

BECKTON JULIAN GG B571
 MS GEOMETRIC 917
 BUF CRK DYNAMICS 3820
 BUF CRK DYNA 3082
 BECKTON EPIC KJ J722
 BECKTON SIERRA J789 EP
 BECKTON VEGAS S1 K316
 BECKTON LANA J131 CT

Calv.Ease	BW	WW	YW	Milk	Tmat	CETM	HPG	Maint.En.	Stay
13	-3.6	22	55	11	22	5	8	-1.0	15
Marb +.15		REA +.09		Bfat +.00					

Lana U660 comes to us from Tongue River's well known herd sire TR Julian LT151. She has nicely balanced EPD's with low maintenance energy and good carcass trait numbers. Pasture exposed to Beckton Likable U-01, Reference Sire L-4, another excellent carcass trait sire. Pedigree is 6+ generations OS clear.

35 MUSHRUSH LOGA LN U167
 1A 100% # 1245799 Tattoo: MUS U167

Birth: 3-24-08

BUF CRK LANCER R017
 BECKTON LANCER F442 T
 Ref. N BUF CRK JULIET N036

MUSHRUSH LANA 0160
 BECKTON LANCER F270 T
 MUS MISS CENTER 6093

BECKTON LANCER T A664
 BKT SUFFEINA A828 DM
 BECKTON JULIAN GG B571
 BUF CRK PRIMROSE 5679
 BECKTON LANCER T A664
 BECKTON LANA A754 PC
 PANHANDLE CENTERSTAGE
 MUS 532 C

Calv.Ease	BW	WW	YW	Milk	Tmat	CETM	HPG	Maint.En.	Stay
6	+1.9	41	79	13	33	3	8	+2.0	15
Marb +.30		REA +.19		Bfat -.01					

5 traits in the top 10% percentile, including top 4% yearling weight. Mushrush Loga U167 scanned an incredible 6.52% IMF to earn her an IMF ratio of an astounding 179! 6+ gen OS clear [Pasture Exposure Ref. Sire C (5/23 - 8/3)]

34 MUSHRUSH LANA AF U131
 1A 100% # 1245845 Tattoo: MUS U131

Birth: 3-13-08

BROWN-CBAR AFFIRMED P7081
 BFCK CHEROKEE CNYN 4912
 Ref. M BROWN MS ABIGRACE L7730

MUS MISS LANCER 8031
 BECKTON LANCER F270 T
 MUS PRAIRIE MADAM 5017

BUF CRK CHF 824-1658
 MRM 1431 8611 9109
 GLACIER LOGAN 210
 LCHMN ABIGAIL E1013
 BECKTON LANCER T A664
 BECKTON LANA A754 PC
 MUS PRARIE MASTER 241
 MUS GOLDEN GIRL

Calv.Ease	BW	WW	YW	Milk	Tmat	CETM	HPG	Maint.En.	Stay
7	-1.8	35	66	18	36	-2	7	+4.0	10
Marb +.14		REA +.12		Bfat -.01					

Some great old genetics combined with some great new in this high performing heifer. 6+ gen OS clear [A.I. Sire D, Pasture Exposure Ref. Sire D (5/21 - 8/3)]

36 MUSHRUSH PRAIRIE EP U170
 1A 100% # 1245796 Tattoo: KCS U170

Birth: 3-25-08

BECKTON EPIC R415 KM
 BECKTON EPIC KM M115
 BECKTON LYDIA G059 WR

MUSHRUSH PRAIRIE 0145
 BECKTON LANCER F270 T
 MUS PRAIRIE MADAM 6045

BECKTON EPIC K F075
 BECKTON MINERVA F495 CH
 BECKTON WARRIOR TC E801
 BECKTON LYDIA E838 NP
 BECKTON LANCER T A664
 BECKTON LANA A754 PC
 MUS PRARIE MASTER 139
 MUS PRARIE MADAM 806

Calv.Ease	BW	WW	YW	Milk	Tmat	CETM	HPG	Maint.En.	Stay
3	+2.6	37	71	15	33	1	9	+8.0	11
Marb +.13		REA +.02		Bfat +.00					

Lots of performance here and with an IMF ratio of 119. 6+ gen OS clear [Pasture Exposure Ref. Sire B (5/20 - 8/1)]

• Registered Females •

37 MUSHRUSH LANA EP U182
1A 100% # 1245847 Tattoo: MUS U182

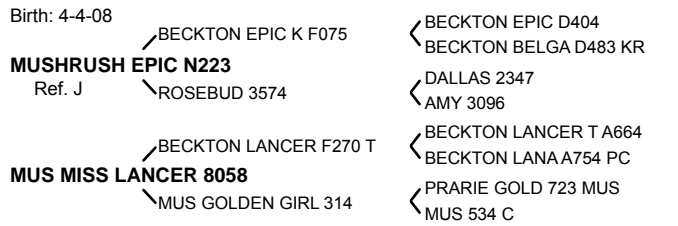

Calv.Ease	BW	WW	YW	Milk	Tmat	CETM	HPG	Maint.En.	Stay
12	-3.2	22	45	16	27	3	10	-2.0	11
Marb +.02		REA -.24		Bfat +.01					

A nice Epic x Lancer heifer for calving ease and low maintenance. 6+ gen OS clear [Pasture Exposure Ref. Sire C (5/23 - 8/3)]



Mushrush Madam DP U090
Lot 38

39 MUSH HEAVYGIRL NB U035
1A 100% # 1245805 Tattoo: MUS U035

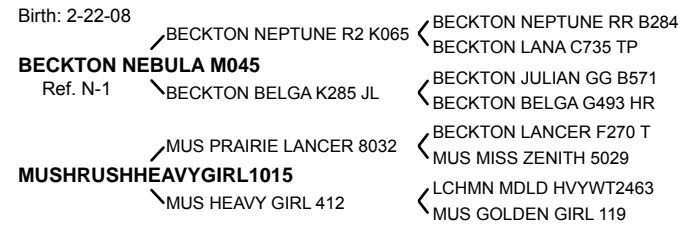

Calv.Ease	BW	WW	YW	Milk	Tmat	CETM	HPG	Maint.En.	Stay
13	-4.0	27	47	14	27	4	11	-7.0	15
Marb +.15		REA +.08		Bfat +.00					

Top 3% CED, top 1% ME, top 7% Stayability with a 120 IMF ratio. The only heifer we are letting of out of the M045 Nebula bull. 6+ gen OS clear [Pasture Exposure Ref. Sire D (5/20 - 8/3)]



Beckton Lydia U389 NB
Lot 40

38 MUSHRUSH MADAM DP U090
1A 100% # 1245886 Tattoo: MUS U090

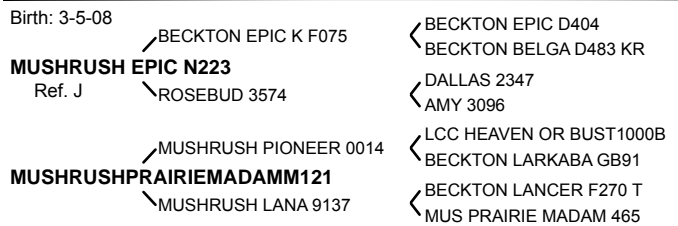

Calv.Ease	BW	WW	YW	Milk	Tmat	CETM	HPG	Maint.En.	Stay
11	-3.3	27	53	23	36	4	11	+6.0	9
Marb -.04		REA -.11		Bfat +.00					

A nicely balanced heifer from our slick haired Epic N223. 6+ gen OS clear [Pasture Exposure Ref. Sire C (5/25 - 8/3)]

40 BECKTON LYDIA U389 NB
2 100% # 1259368 Tattoo: BKT U389

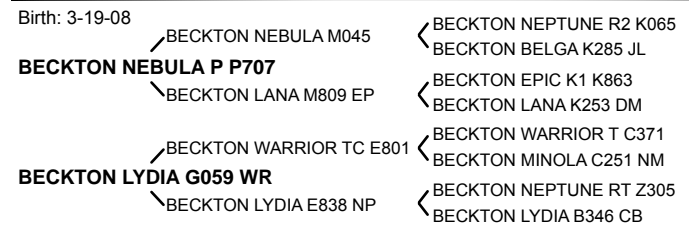

Calv.Ease	BW	WW	YW	Milk	Tmat	CETM	HPG	Maint.En.	Stay
11	-2.4	23	57	13	25	4	11	-4.0	12
Marb +.16		REA +.10		Bfat +.00					

Lydia offers two of the most important maternal traits – very low maintenance energy and longevity. The longevity comes from her dam, Lydia G059 who produced for us without missing a calf, for eleven years, with progeny averages of 103 weaning and 105 yearling. Pasture exposed to Beckton Epic T524, Reference Sire E-5. Pedigree is 6+ generations OS clear.

• Registered Females •

41 BKT LARKABEL U829 NB
1A 100% # 1258902 Tattoo: WF U829

Birth: 4-22-08

BECKTON NEBULA N R573
Ref. N-4

BKT LARKABEL M166 LN

BECKTON NEBULA M045
BECKTON LANA M621 LN
BECKTON LANCER TS D390
BKT LARKABEL G030 CT

BECKTON NEPTUNE R2 K065
BECKTON BELGA K285 JL
BECKTON LANCER F442 T
BECKTON LANA H329 HD
BECKTON LANCER T A664
BECKTON COCA 7536 SB
BKT CLIFFTOP TC E081
BKT LARKABEL E645 MB

Calv.Ease	BW	WW	YW	Milk	Tmat	CETM	HPG	Maint.En.	Stay
13	-3.2	25	44	11	23	3	11	-7.0	17
Marb +.10		REA -.12		Bfat -.01					

The Larkabel dam is a very nice cow for us – 7 years of age now and weaning calves in the upper half of the herd. This heifer has a very low maintenance energy EPD of -7, and exceptional stayability EPD of +17. Pasture exposed to Beckton Epic T524, Reference Sire E-5. Pedigree is 6+ generations OS clear.

44 BECKTON ROSE U484 RN
1A 100% # 1259501 Tattoo: BKT U484

Birth: 3-23-08

BECKTON RANGER 9479R

BECKTON ROSE P493 EP

BECKTON RANGER 7003
BECKTON EOLA 7470 RZ
BECKTON EPIC K F075
BECKTON ROSE L019 JL

BECKTON VARO 5642
BKT MIGO VERNICE3942
BECKTON RAZA 2308-N
BKT NEVA EOLA 4829
BECKTON EPIC D404
BECKTON BELGA D483 KR
BECKTON JULIAN G1 J526
BECKTON ROSE J317 HD

Calv.Ease	BW	WW	YW	Milk	Tmat	CETM	HPG	Maint.En.	Stay
15	-5.4	16	34	7	15	2	8	-8.0	10
Marb +.10		REA -.28		Bfat +.01					

This feminine Rose heifer is one of the best overall for low maintenance energy EPD at -8. She is an AI daughter of a many time Red Angus trait leader for low birth weight, Beckton Ranger 9479. Pasture exposed to Beckton Epic T524, Reference Sire E-5. Pedigree is 6+ generations OS clear.

42 BECKTON TAMARA U354 CB
1A 100% # 1259611 Tattoo: BKT U354

Birth: 3-18-08

BECKTON COBALT S029

BECKTON TAMARA S019 CD

BECKTON CODY K1 P014
BECKTON MARTA P633 JO
BECKTON CODY K1 P014
BECKTON TAMARA P460 LN

BECKTON CODY KH M390
BECKTON ROSE M126 WR
BECKTON JULIO L233
BECKTON MARTA C314 JL
BECKTON CODY KH M390
BECKTON ROSE M126 WR
BECKTON LANCER T4 J536
BECKTON TAMARA H068 LN

Calv.Ease	BW	WW	YW	Milk	Tmat	CETM	HPG	Maint.En.	Stay
15	-4.9	26	57	17	30	4	7	+3.0	15
Marb -.11		REA -.05		Bfat +.00					

Tamara is a nice heifer out of a nice young, good-milking dam weaning her calves in the top half of the herd. Line-breeding with an outcross sire line in our program opens up a lot of potential upside. Pasture exposed to Beckton Epic U095, Reference Sire E-7. Pedigree is 6+ generations OS clear.

45 BECKTON ROSE U684 CT
1A 100% # 1259588 Tattoo: BKT U684

Birth: 4-3-08

BKT CLIFFTOP TP R288
Ref. B-1

BECKTON ROSE R579 JJ

BECKTON CLIFFTOP T C075
BECKTON CHRISTY K209 CO
BECKTON JUNO N493
BECKTON ROSE N524 NM

BJR TOPPER 5241
BECKTON BARMAID A761 TR
BECKTON COPPER JT G095
BECKTON CHRISTY A111 VQ
BECKTON JULIAN G1 J526
BECKTON SERENA D760 KR
BECKTON NOMAD 7496
BECKTON ROSE F306 JL

Calv.Ease	BW	WW	YW	Milk	Tmat	CETM	HPG	Maint.En.	Stay
17	-6.5	15	35	13	20	4	8	-9.0	17
Marb +.00		REA +.14		Bfat +.00					

Very good maintenance energy EPD plus very high stayability EPD come with this Rose heifer. Pasture exposed to Beckton Epic T524, Reference Sire E-5. Pedigree is 6+ generations OS clear.

43 BKT PINE MARIE U481 NM
1A 100% # 1259552 Tattoo: BKT U481

Birth: 3-22-08

BECKTON NOMAD 7496

BKT PINE MARIE R246 JE

BECKTON NEVA 5562
BKT BOLT TAMRCK 3913
BECKTON JULES L429
BKT PINE MARIE J556 EP

BKT PINE 2778-8
BKT MO1634-1549
THUNDERBOLT
MD 373 RC 523
BECKTON JULIAN G1 J526
BECKTON BARONA J591 EP
BECKTON EPIC K F075
BKT PINE MARIE F030 CL

Calv.Ease	BW	WW	YW	Milk	Tmat	CETM	HPG	Maint.En.	Stay
14	-5.2	23	40	11	22	4	10	-3.0	11
Marb -.04		REA -.22		Bfat +.01					

Pine Marie's dam is a good young cow with a progeny record of 107 for weaning and 106 for yearling. She is pasture exposed to a new sire Beckton Hasten U108, Reference Sire H-3, that is -2.5 BW +66 YW +15 Stay and -2 ME. Pedigree is 6+ generations OS clear.

46 MUSHRUSH MADAM OS U022
1A 100% # 1245930 Tattoo: MUS U022

Birth: 2-20-08

MUSHRUSH OSAGE LN P017
Ref. L

MUSHRUSH MADAM LT R038

LJC CHEROKEE M03
MUSHRUSH LANA 1061
TR JULIAN LT142
MUSHRUSH MADAM N086

BFCK CHEROKEE CNYN 4912
BUCKEYE MOLLIE
BUF CRK JULIAN 5138
MUS MISS LANCER 5025
BECKTON JULIAN GG B571
TR LANA G760
MUS PRAIRIE LANCER 8032
MUS PRAIRIE MADAM 7104

Calv.Ease	BW	WW	YW	Milk	Tmat	CETM	HPG	Maint.En.	Stay
12	-2.7	25	50	15	27	4	7	+7.0	17
Marb -.07		REA +.05		Bfat -.01					

Nice, well balanced heifer from an LT 142 dam. Top 2% Stayability, top 4% CED. 6+ gen OS clear [A.I. Sire N-1 (5/18), Pasture Exposure Ref. Sire C (5/25 - 8/3)]

• Registered Females •



Mushrush Lana MI U047
Lot 47

49 MUSHRUSH LANA JL U050
1A 100% # 1245931 Tattoo: MUS U050

Birth: 2-26-08

MUSHRUSH JULIAN N153
Ref. H

MUSHRUSH LANA WR R042

Calv.Ease BW WW YW Milk Tmat CETM HPG Maint.En. Stay
6 +1.5 35 58 12 30 4 6 -2.0 15
Marb **+0.06** REA **-0.07** Bfat **-0.02**

Fancy Julian x Warrior excels on low maintenance and Stayability with both in top 6% of breed. 6+ gen OS clear [Pasture Exposure Ref. Sire C (5/25 - 8/3)]

47 MUSHRUSH LANA MI U047
1A 100% # 1245809 Tattoo: MUS U047

Birth: 2-25-08

MUSHRUSH MIMI VG R205
Ref. O

MUSHRUSH LANA 1035

Calv.Ease BW WW YW Milk Tmat CETM HPG Maint.En. Stay
10 -0.7 33 57 15 31 4 7 +1.0 15
Marb **-0.01** REA **+0.04** Bfat **-0.01**

Double bred Julian with the added twist of Bieber Make Mimi. tested OS free [Pasture Exposure Ref. Sire C (5/25 - 8/3)]

50 MUSHRUSH MONA OS U046
1A 100% # 1245925 Tattoo: DANS U046

Birth: 2-25-08

MUSHRUSH OSAGE LN P017
Ref. L

BECKTON MONA P282 EP

Calv.Ease BW WW YW Milk Tmat CETM HPG Maint.En. Stay
6 +0.7 33 66 16 32 1 5 +5.0 14
Marb **-0.07** REA **-0.07** Bfat **-0.01**

Check out the individual growth ratio's (106 WR, 111YR) on this nice heifer out of a rare F075 dam. 6+ gen OS clear [A.I. Sire F, Pasture Exposure Ref. Sire C (5/25 - 8/3)]

48 MUSH KURUBA JL U039
1A 100% # 1245997 Tattoo: KCS U039

Birth: 2-24-08

MUSHRUSH EPICN725 LN S124

OCHO VACA KURUBA WAR S24

Calv.Ease BW WW YW Milk Tmat CETM HPG Maint.En. Stay
7 +0.7 35 73 10 27 1 11 +4.0 10
Marb **+0.08** REA **+0.00** Bfat **+0.00**

Lots of growth from this Epic x Warrior. 6+ gen OS clear [Pasture Exposure Ref. Sire D (5/20 - 8/3)]

51 MUSH VALLEYGIRL LN U057
1A 100% # 1245834 Tattoo: DANS U057

Birth: 2-26-08

BECKTON LANCER F270 T

VALLEY GIRL 3530

Calv.Ease BW WW YW Milk Tmat CETM HPG Maint.En. Stay
7 +0.6 35 63 8 25 3 5 +7.0 6
Marb **-0.03** REA **-0.16** Bfat **-0.01**

Nice balanced all around producer. 6+ gen OS clear [Pasture Exposure Ref. Sire D (5/20 - 8/3)]

• Registered Females •

52 **BECKTON BELGA T138 CD**
1A 100% # 1178649 Tattoo: BKT T138

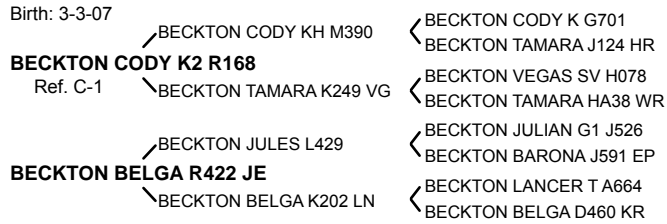

Calv.Ease	BW	WW	YW	Milk	Tmat	CETM	HPG	Maint.En.	Stay
17	-6.2	21	54	17	27	4	12	-1.0	15
Marb -.03		REA +.08		Bfat +.00					

This moderate sized 955 pound two year old brings great milk and a very low maintenance energy for efficiency. She is AI bred June 14 to Beckton Nebula P084, Reference Sire N-2, a calving ease trait leader, and pasture exposed to Beckton Nebula S543, Reference Sire N-6. Pedigree is 6+ generations OS clear.

54 **BECKTON LANA T243 WA**
1A 100% # 1178753 Tattoo: WF T243

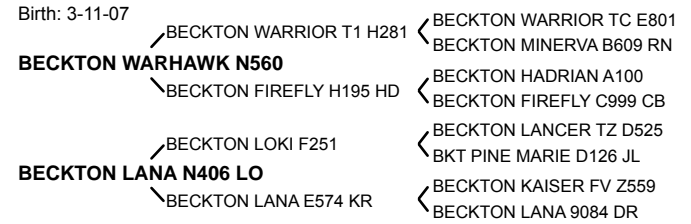

Calv.Ease	BW	WW	YW	Milk	Tmat	CETM	HPG	Maint.En.	Stay
16	-6.0	21	41	19	29	5	12	.0	15
Marb +.06		REA -.10		Bfat +.00					

Lana is one of our oldest and most prolific cow lines. This daughter is a high milk, low maintenance, high calving ease, future brood cow. Her dam is now a good-producing six year old and calves early every year. Pasture exposed to Beckton Epic S569, Reference Sire E-3. Pedigree is 6+ generations OS clear.

53 **BECKTON COCA T080 NB**
1A 100% # 1178375 Tattoo: BKT T080

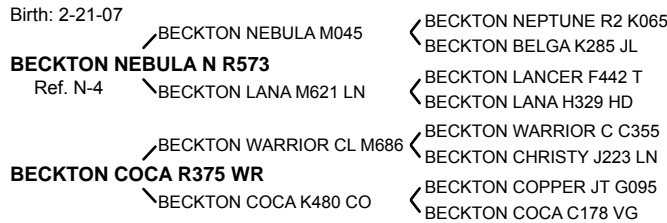

Calv.Ease	BW	WW	YW	Milk	Tmat	CETM	HPG	Maint.En.	Stay
17	-5.6	23	48	11	23	4	13	-1.0	18
Marb +.10		REA +.03		Bfat +.00					

Nicely balanced EPD's in this attractive 2 year old Nebula M045 grand-daughter, with low ME and high calving ease. She is pasture exposed to our Cherokee Canyon grandson Beckton Cherokee T450, Reference Sire B-2. Pedigree is 6+ generations OS clear.

55 **BECKTON BELGA T633 JJ**
1A 100% # 1178925 Tattoo: BKT T633

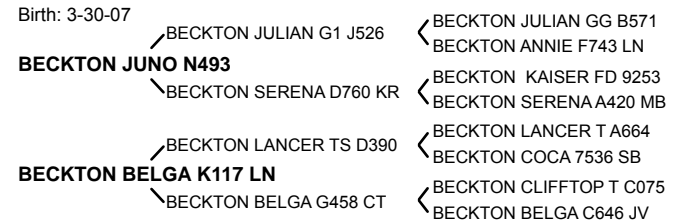

Calv.Ease	BW	WW	YW	Milk	Tmat	CETM	HPG	Maint.En.	Stay
15	-5.0	25	37	10	23	3	5	.0	17
Marb +.04		REA -.13		Bfat -.01					

Belga T633 descends from Julian B571 on the sire side. Her dam is still a strong producer in our herd at 1130 pounds and nine years of age. Pasture exposed to Beckton Nebula T269, Reference Sire N-8. Pedigree is 6+ generations OS clear.



56 **BECKTON MINOLA R604 CD**
1A 100% # 1042342 Tattoo: WF R604

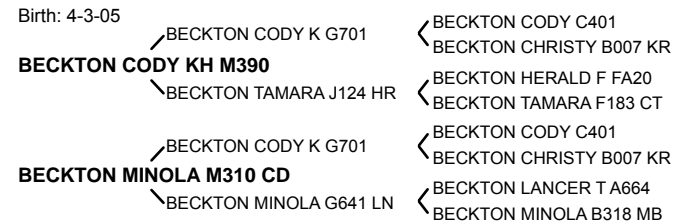

Calv.Ease	BW	WW	YW	Milk	Tmat	CETM	HPG	Maint.En.	Stay
14	-4.5	24	52	14	26	4	3	+8.0	11
Marb -.02		REA -.20		Bfat +.01					

Linebred with an outcross bloodline, our Beckton Cody's, Minola offers a completely different pedigree. This has produced a lot of performance also, as Minola has progeny performance of 105 at weaning and 110 at yearling. Pasture exposed to Beckton Heritage T270, Reference Sire H-2, a new herd sire from the ABS Beckton Heritage sire. Pedigree is 6+ generations OS clear.

• Registered Females •



Mushrush Lana LT R203
Lot 59

59 MUSHRUSH LANA LT R203
1A 100% # 1084976 Tattoo: MUS R203

Birth: 8-22-05

BECKTON JULIAN GG B571 < BKT JULIAN 7526 G
BKT MARTA 9A13 JL

TR JULIAN LT142
Ref. G < TR LANA G760 < BECKTON CODY V E023
BECKTON LANA E828 SC

MUSHRUSH PIONEER 0014 < LCC HEAVEN OR BUST1000B
BECKTON LARKABA GB91

MUSHRUSH LANA N304
< MUSHRUSH LANA 9137 < BECKTON LANCER F270 T
MUS PRAIRIE MADAM 465

Calv.Ease	BW	WW	YW	Milk	Tmat	CETM	HPG	Maint.En.	Stay
14	-2.5	33	58	19	35	9	15	.0	14
Marb		-0.02		REA		+0.01		Bfat -0.01	

The chance to purchase an LT 142 daughter is a rare opportunity. Semen is no longer available and nobody wants to turn loose of one. Don't let R203 get away! Her EPDs reflect the reason LT 142 is so popular. 6+ gen OS clear [Pasture Exposure Ref. Sire P (5/22 - 6/26), Pasture Exposure Ref. Sire V (6/26 - 7/27)]

57 BECKTON TAMARA S596 LN
1A 100% # 1119059 Tattoo: WF S596

Birth: 3-26-06

BECKTON LANCER TA K644 < BECKTON LANCER T A664
BECKTON TAMARA B570 JL

BECKTON LANCER T9 N586
BKT LARKEISA H232 SC < BECKTON SCAMP TR FB22
BKT LARKEISA F828 JL

BECKTON VEGAS PK F485 < BECKTON VEGAS P D462
BECKTON LAKME D399 KR

BECKTON TAMARA K783 VG
BECKTON TAMARA F269 CH < BECKTON CHAMP R A583
BKT TAMARA 8502 ZL

Calv.Ease	BW	WW	YW	Milk	Tmat	CETM	HPG	Maint.En.	Stay
9	-0.4	31	56	20	35	3	9	.0	14
Marb		-0.06		REA		-0.01		Bfat -0.01	



Mushrush Heavygirl JL S01
Lot 60

60 MUSH HEAVYGIRL JL S013
1A 100% # 1115165 Tattoo: MUS S013

Birth: 2-11-06

BECKTON JULIAN GG B571 < BKT JULIAN 7526 G
BKT MARTA 9A13 JL

MUSHRUSH JULIAN 1005
Ref. A < MUSHRUSH LANA 9037 < BECKTON LANCER F270 T
MUS MISS CENTER 6026

MUSHRUSH LANCER 0089 < BECKTON LANCER F270 T
MUS MISS ZENITH 5029

MUSHRUSH HEAVYGIRL LN P096
< MUSHRUSHHEAVYGIRL1015 < MUS PRAIRIE LANCER 8032
MUS HEAVY GIRL 412

Calv.Ease	BW	WW	YW	Milk	Tmat	CETM	HPG	Maint.En.	Stay
12	-2.5	28	53	14	28	4	10	-6.0	16
Marb		+0.06		REA		+0.01		Bfat +0.00	

A young Lancer x Julian with a long, exciting life ahead of her. If you want the easy fleshing, highly fertile kind, look no further. 6+ gen OS clear [Pasture Exposure Ref. Sire Q (5/27 - 6/3), Pasture Exposure Ref. Sire J (6/3 - 8/3)]

58 MUSH PERFECTION JL P301
1A 100% # 1015572 Tattoo: MUS P301

Birth: 10-5-04

BECKTON JULIAN GG B571 < BKT JULIAN 7526 G
BKT MARTA 9A13 JL

MUSHRUSH JULIAN 1005
Ref. A < MUSHRUSH LANA 9037 < BECKTON LANCER F270 T
MUS MISS CENTER 6026

ROY'S PERFECTION 2447 < STAND OFF 1629
TOWN MODEL 2230

TOUCH OF PERFECTION 346
LESLIE 2602 < ROY'S BETTER HEAVY 1413
DEE DEE 2307

Calv.Ease	BW	WW	YW	Milk	Tmat	CETM	HPG	Maint.En.	Stay
11	-1.1	33	59	13	29	4	11	-3.0	13
Marb		-0.10		REA		-0.06		Bfat +0.00	

Mushrush Perfection JL P301's name says it all. She's a snapshot of what our program is about. Fertile, functional, low maintenance, worry free genetics. 6+ gen OS clear [Pasture Exposure Ref. Sire P (5/22 - 6/26), Pasture Exposure Ref. Sire V (6/26 - 7/27)]

• Registered Females •

61 **BECKTON ROSE T651 JL**
1A 100% # 1178943 Tattoo: BKT T651

Birth: 4-1-07
 BECKTON JULIAN G3 P608
 BECKTON ROSE P340 HR

```

    / BECKTON JULIAN GG B571 < BKT JULIAN 7526 G
    / BKT MARTA 9A13 JL
    / BECKTON DOMINOR 9455
    / BKT SUFFEINA 9493 TT
    / BECKTON HERALD FV J537 < BECKTON HERALD F FA20
    / BECKTON KURUBA F588 VG
    / BECKTON HADRIAN F C486
    / BECKTON ROSE A528 PC
    / BECKTON SUFFEINA A828 DM
    / BECKTON ROSE H292 HD
    
```

Calv.Ease	BW	WW	YW	Milk	Tmat	CETM	HPG	Maint.En.	Stay
16	-4.6	22	46	15	26	5	12	-5.0	17
	Marb +.07			REA -.04			Bfat +.00		

This low maintenance energy, high milk grand-daughter of Julian B571 was AI bred June 14 back to B571. Her Rose dam averaged calves that were 104 at weaning and 102 at yearling. Pasture exposed to Beckton Nebula S543, Reference Sire N-6. Pedigree is 6+ generations OS clear.



Mushrush Primrose N202 S
Lot 64

62 **BECKTON FIREFLY S418 LN**
1A 100% # 1118881 Tattoo: BKT S418

Birth: 3-16-06
 BECKTON LANCER T7 M089
 BECKTON FIREFLY K250 VG

```

    / BECKTON LANCER F442 T < BECKTON LANCER T A664
    / BKT SUFFEINA A828 DM
    / LCC HEAVEN OR BUST1000B
    / BECKTON TAMARA G141 HE < BECKTON TAMARA C695 CL
    / BECKTON VEGAS PK F485 < BECKTON VEGAS P D462
    / BECKTON LAKME D399 KR
    / BECKTON MILEBAR BX 9822
    / BECKTON FIREFLY B018 KR
    / BECKTON FIREFLY E920 MB
    
```

Calv.Ease	BW	WW	YW	Milk	Tmat	CETM	HPG	Maint.En.	Stay
11	-3.5	26	49	17	30	2	8	-1.0	13
	Marb -.12			REA -.13			Bfat -.03		

This Lancer F442 granddaughter from our long-running Firefly cow line exhibits strong maternal traits, with very low maintenance energy EPD and high milk, and a very moderate 985 pound size this fall. Her two calves are averaging 102 ratio at weaning, and last year's calf was 107 at yearling, so she produces strongly and efficiently. Pasture exposed to Beckton Epic S569, Reference Sire E-3. Pedigree is 6+ generations OS clear.

64 **MUSH PRIMROSE N202 S311**
1A 100% # 1152416 Tattoo: MUS S311

Birth: 10-11-06
 MUSHRUSH JULIAN N202
 MUSHRUSH CH PRIMROSE P230

```

    / BECKTON JULIAN GG B571 < BKT JULIAN 7526 G
    / BKT MARTA 9A13 JL
    / BUF CRK CHF 824-1658
    / MUSHRUSH LANA 1181 < MUSHRUSH LANA 9126
    / BUF CRK CHF 824-1658
    / BFCK CHEROKEE CNYN 4912 < MRM 1431 8611 9109
    / MUS PRAIRIE LANCER 8032
    / MUSHRUSH PRIMROSE M222 < PRIMROSE 3503
    
```

Calv.Ease	BW	WW	YW	Milk	Tmat	CETM	HPG	Maint.En.	Stay
14	-3.9	25	55	18	30	1	13	-1.0	17
	Marb +.01			REA +.23			Bfat +.01		

Sire Mushrush Julian N202 is a multi-trait genetic leader and Primrose S311 follows suit. Top 10% EPDs for 5 traits. 6+ gen OS clear [Pasture Exposure Ref. Sire P (5/22 - 6/26), Pasture Exposure Ref. Sire V (6/26 - 7/27)]

63 **BECKTON FREYJA R540 CD**
1A 100% # 1042278 Tattoo: WF R540

Birth: 3-27-05
 BECKTON CODY KH M390
 BECKTON FREYJA K260 CH

```

    / BECKTON CODY K G701 < BECKTON CODY C401
    / BECKTON CHRISTY B007 KR
    / BECKTON HERALD F FA20
    / BECKTON TAMARA J124 HR < BECKTON TAMARA F183 CT
    / BECKTON CHAMP RH F275
    / BECKTON CHAMP R1 H024 < BECKTON LANA F138 LN
    / BECKTON COBALT V AC03
    / BECKTON FREYJA HC12 CB < BKT FREYJA 8052 RV
    
```

Calv.Ease	BW	WW	YW	Milk	Tmat	CETM	HPG	Maint.En.	Stay
15	-5.8	20	47	16	26	4	4	+12.0	13
	Marb -.06			REA -.09			Bfat +.00		

Our vet thinks this young Freyja R540 cow will calve early (early March). She is pasture exposed to a big ribeye, good marbling, low maintenance EPD grandson of Nebula M045, Beckton Nebula T054, Reference Sire N-7. This pasture sire has a +.42 ribeye, +.10 marbling and a -3 maintenance energy EPD. Freyja's pedigree is 6+ generations OS clear.

65 **OCHO VACA KURUBA WAR S24**
1A 100% # 1120115 Tattoo: OVCC S24

Birth: 2-12-06
 BECKTON WARRIOR T1 H281
 OCHO VACA KURUBA 07

```

    / BECKTON WARRIOR TC E801 < BECKTON WARRIOR T C371
    / BECKTON MINOLA C251 NM
    / BECKTON RANGER H Z095
    / BECKTON MINERVA B609 RN < BECKTON MINERVA Z936 RN
    / BECKTON LANCER T A664 < BECKTON LANCER 9380
    / BECKTON COCA 9119 TJ
    / BECKTON LANCER T A664 < BECKTON COCA 9119 TJ
    / SELL RIBEYE 656
    / SELL KURUBA 026 < BUF CRK KURUBA 203
    
```

Calv.Ease	BW	WW	YW	Milk	Tmat	CETM	HPG	Maint.En.	Stay
9	+0.1	35	69	9	26	3	12	+7.0	8
	Marb +.03			REA +.03			Bfat -.01		

Beckton Warrior H281 is one of favorite sires and one look at S24 tells you why. Son Casey purchased S24 from Ocho Vaca Red Angus in Colorado. 6+ gen OS clear [Pasture Exposure Ref. Sire Q (5/27 - 6/3), Pasture Exposure Ref. Sire J (6/3 - 8/3)]

• Registered Females •



Mushrush Candice N031
Lot 66

68 **BECKTON ANGEL T158 JT**
1A 100% # 1178669 Tattoo: WF T158

Birth: 3-5-07
 TR JULIAN LT151
 MS GEOMETRIC 917
 BECKTON WARRIOR CL M686
 BECKTON ANGEL R465 WR
 BECKTON ANGEL K213 CH
 BKT JULIAN 7526 G
 BKT MARTA 9A13 JL
 BJR YO 121
 MS GEOMETRIC
 BECKTON WARRIOR C C355
 BECKTON CHRISTY J223 LN
 BECKTON CHAMP R1 H024
 BECKTON ANGEL H164 LO

Calv.Ease	BW	WW	YW	Milk	Tmat	CETM	HPG	Maint.En.	Stay
13	-2.3	35	72	15	32	6	13	+7.0	17
	Marb	+1.14		REA	+1.17		Bfat +.00		

Outstanding EPD's from low birth to high yearling, milk, stayability and carcass. She weighed a moderate 935 pounds at weaning. Pasture exposed to Beckton Warrior T248, Reference Sire W-2. Pedigree is 6+ generations OS clear.

66 **MUSHRUSH CANDICE N031**
1A 100% # 912152 Tattoo: MUS N031

Birth: 2-20-03
 BFCK CHEROKEE CNYN 4912
 MRM 1431 8611 9109
 MUSHRUSH CANDICE 9130
 MUS MISS ZENITH 438
 BUF CRK CHF 824-1658
 BUF CRK CHIEF092-824
 BFLO CRK CARIE VC473
 BUF CRK CHEROKEE1431
 MRM 8454 8219 8611
 BUF CRK CHF 824-1658
 BUF CRK CHIEF092-824
 BFLO CRK CARIE VC473
 MUS PRARIE ZENITH 221
 MUS GOLDEN LASS 926

Calv.Ease	BW	WW	YW	Milk	Tmat	CETM	HPG	Maint.En.	Stay
11	-3.4	22	38	15	25	-7	11	+8.0	9
	Marb	+2.1		REA	+1.19		Bfat +.01		

Excellent carcass potential from this linebred Canyon. tested OS free [Pasture Exposure Ref. Sire P (5/22 - 6/26), Pasture Exposure Ref. Sire V (6/26 - 7/27)]

69 **BECKTON LANA S831 JL**
1A 100% # 1119293 Tattoo: BKT S831

Birth: 4-20-06
 BECKTON JULIAN G1 J526
 Ref. F
 BECKTON ANNIE F743 LN
 BECKTON LANCER T5 L095
 BECKTON LANA N041 LN
 BECKTON LANA L923 CD
 BKT JULIAN 7526 G
 BKT MARTA 9A13 JL
 BECKTON LANCER T A664
 BECKTON ANNIE C132 NP
 BECKTON LANCER F442 T
 BECKTON BELGA J293 HR
 BECKTON CODY K G701
 BECKTON LANA D232 HV

Calv.Ease	BW	WW	YW	Milk	Tmat	CETM	HPG	Maint.En.	Stay
14	-2.7	34	58	10	27	4	5	+1.0	17
	Marb	-1.11		REA	+0.09		Bfat +.00		

A young Julian B571 grand-daughter, Lana offers low maintenance energy and high calving ease. She is moderate sized, 940 pounds, as we would expect from the Julian line. Pasture exposed to Beckton Hasten S462, Reference Sire H-1. Pedigree is 6+ generations OS clear.

67 **BECKTON ANGEL T229 JJ**
1A 100% # 1178739 Tattoo: WF T229

Birth: 3-10-07
 BECKTON JUNO N493
 BECKTON SERENA D760 KR
 BECKTON ANGEL F717 VG
 BECKTON ANGEL D665 VG
 BECKTON JULIAN G1 J526
 BECKTON JULIAN GG B571
 BECKTON ANNIE F743 LN
 BECKTON KAISER FD 9253
 BECKTON SERENA A420 MB
 BECKTON VEGAS P D462
 BECKTON VEGAS 9433
 BECKTON LARKABA A442 PC
 BECKTON VEGAS 9433
 BECKTON ANGEL A476 SN

Calv.Ease	BW	WW	YW	Milk	Tmat	CETM	HPG	Maint.En.	Stay
15	-4.8	26	37	12	25	3	6	-4.0	15
	Marb	-1.10		REA	-1.13		Bfat -.01		

Angel's dam is Angel F717, linebred from our Vegas 9433 herd sire. She calved early 10 straight years before we finally sold her, and her calves were in the top half of the herd at both weaning and yearling. On the sire side Angel descends from Julian B571. Pasture exposed to Beckton Nebula T054, Reference Sire N-7. Pedigree is 6+ generations OS clear.

70 **MUSHRUSH LOGA M211**
1A 100% # 882992 Tattoo: MUS M211

Birth: 10-6-02
 MUS PRAIRIE LANCER 8032
 MUS MISS ZENITH 5029
 MUSHRUSH LOGA 9142
 MUS MISS HEAVEN 7010
 BECKTON LANCER F270 T
 BECKTON LANCER T A664
 BECKTON LANA A754 PC
 MUS PRARIE ZENITH 221
 MUS PRAIRIE MADAM 101
 BFLO CR VC CHIEF 105
 GLACIER REBALAS
 LCC HEAVEN OR BUST1000B
 MUS MISS THUNDER 5069

Calv.Ease	BW	WW	YW	Milk	Tmat	CETM	HPG	Maint.En.	Stay
6	-1.0	26	43	18	31	6	3	+1.0	12
	Marb	+0.07		REA	+0.04		Bfat -.01		

Lancer x Logan. Proven genetics that will work anywhere. 6+ gen OS clear [Pasture Exposure Ref. Sire P (5/22 - 6/26), Pasture Exposure Ref. Sire V (6/26 - 7/27)]

• Registered Females •

71 MUSHRUSH CANDICE CL P090
1A 100% # 975149 Tattoo: MUR P090

Birth: 3-11-04
 MUSHRUSH CLIPPER 1030
 MUSHRUSH CANDICE 0020

BECKTON CLIPPER KC D400
 BECKTON CLIPPER K Z420
 BKT CHRISTY 9A01 CL
 BECKTON LANCER F270 T
 MUS MISS ZENITH
 BKT JULIAN 7526 G
 BUF CRK PNMARIE 1781
 BUF CRK JULIAN 5138
 BUF CRK CHF 824-1658
 BUF CRK 1658 9130 4809
 MRM 732 8491 9130

Calv.Ease	BW	WW	YW	Milk	Tmat	CETM	HPG	Maint.En.	Stay
9	-0.9	25	53	19	31	4	10	+6.0	11
	Marb +.02			REA +.06			Bfat +.02		

We don't have many Clippers, but we really like the ones we do. An excellent productive package in Mushrush Candace P090. tested OS free [Pasture Exposure Ref. Sire Q (5/27 - 6/3), Pasture Exposure Ref. Sire J (6/3 - 8/3)]



Beckton Rose U854 NB
Lot 73



Mushrush Perfection M126
Lot 72

73 BECKTON ROSE U854 NB
1A 100% # 1259591 Tattoo: BKT U854

Birth: 4-29-08
 BECKTON NEBULA M045
 BECKTON ROSE R623 JC

BECKTON NEPTUNE R2 K065
 BECKTON LANA C735 TP
 BECKTON JULIAN GG B571
 BECKTON BELGA K285 JL
 BECKTON BELGA G493 HR
 BECKTON JULIAN GG B571
 BKT VERNICE 9733 PC
 BECKTON JUSTICE G302
 BECKTON LANCER T A664
 BECKTON ROSE M683 LN
 BECKTON ROSE A528 PC

Calv.Ease	BW	WW	YW	Milk	Tmat	CETM	HPG	Maint.En.	Stay
16	-4.7	27	55	5	18	5	14	-4.0	17
	Marb +.06			REA +.15			Bfat +.00		

Balanced EPD's with high stayability and a very low maintenance energy EPD. Rose is pasture exposed to Beckton Epic T524, Reference Sire E-5. Pedigree is 6+ generations OS clear.

72 MUSHRUSH PERFECTION M126
1A 100% # 882915 Tattoo: MUS M126

Birth: 9-12-02
 MUSHRUSH LANCER 8115
 TOUCH OF PERFECTION 346

BECKTON LANCER F270 T
 BECKTON LANCER T A664
 BECKTON LANA A754 PC
 LEACHMAN CHIEFDOM 2X
 MUS 823 C
 STAND OFF 1629
 TOWN MODEL 2230
 ROYS PERFECTION 2447
 ROY'S BETTER HEAVY 1413
 DEE DEE 2307
 MUS MISS CHIEFDOM 457
 LESLIE 2602

Calv.Ease	BW	WW	YW	Milk	Tmat	CETM	HPG	Maint.En.	Stay
10	-1.8	26	57	13	26	4	9	-6.0	8
	Marb +.01			REA -.18			Bfat +.00		

Easy Fleshing, extreme low maintenance, calving ease genetics. An injection of what every herd needs. 6+ gen OS clear [Pasture Exposure Ref. Sire P (5/22 - 6/26), Pasture Exposure Ref. Sire V (6/26 - 7/27)]

74 BECKTON ANGEL U632 CD
1A 100% # 1258965 Tattoo: WF U632

Birth: 3-29-08
 BECKTON CODY K1 P014
 BECKTON ANGEL P156 CE

BECKTON CODY KH M390
 BECKTON CODY K G701
 BECKTON TAMARA J124 HR
 BECKTON WARRIOR T C371
 BECKTON ROSE M126 WR
 BECKTON ROSE D741 LN
 BECKTON CRUISER K118
 BECKTON CLIPPER K1 H772
 BECKTON LANA H329 HD
 BECKTON ANGEL L717 LN
 BECKTON LANCER TS D390
 BECKTON ANGEL H227 EP

Calv.Ease	BW	WW	YW	Milk	Tmat	CETM	HPG	Maint.En.	Stay
14	-4.5	17	47	14	23	4	10	+1.0	13
	Marb -.05			REA -.03			Bfat +.00		

Angel U632 is the only heifer in the sale selling pasture exposed to our new Cody line herd sire, Beckton Cody U777, Reference Sire C-2. While this was not by plan, it is worth looking at Cody, because he is -4.5 BW +63 YW and +21 milk, and is an outcross to our other bloodlines such as Julian, Lancer and Nebula. Pedigree is 6+ generations OS clear.

• Registered Females •

75 **BKT LARKEISA U407 JD**
1A 100% # 1259514 Tattoo: BKT U407

Birth: 3-20-08

TR JULIAN RT561
Ref. J-3

BECKTON LARKEISA P688 C

BECKTON JULIAN GG B571
MS GEOMETRIC 917
BUF CRK DYNAMICS 3820
BUF CRK DYNA 3082
BECKTON CHAMP R3 H338
BECKTON CHAMP RK E121
BECKTON ENCINO C644 ZN
BECKTON HERALD HH E503
BKT LARKEISA E308 EM

Calv.Ease	BW	WW	YW	Milk	Tmat	CETM	HPG	Maint.En.	Stay
13	-4.8	10	27	13	17	5	10	+4.0	14
Marb +.00		REA -.01			Bfat +.00				

A grand-daughter of Tongue River's well-known LT151 sire, Larkeisa is out of an early calving dam. Pasture exposed to a very low maintenance energy and good carcass sire, Beckton Epic T524, Reference Sire E-5. Pedigree is 6+ generations OS clear.

78 **BSF ANDREA U143 JL**
1B 99.8% # 1259219 Tattoo: BSF U143

Birth: 3-7-08

BECKTON JULIAN G3 P608

BSF ANDREA N061 PG

BECKTON JULIAN GG B571
BKT SUFFEINA A828 DM
ANDRAS PURE GOLD 132
BSF REGUS L427 HR
BKT JULIAN 7526 G
BKT MARTA 9A13 JL
BECKTON DOMINOR 9455
BKT SUFFEINA 9493 TT
BADLANDS MR BEEF 805
JHL D5803
BECKTON HERALD F FA20
BSF RED G117

Calv.Ease	BW	WW	YW	Milk	Tmat	CETM	HPG	Maint.En.	Stay
16	-5.1	18	40	15	24	6	11	-7.0	18
Marb +.11		REA -.12			Bfat +.00				

Andrea comes to us as a newer cow line from the Andras Pure Gold, an eye-appealing sire from Andras Stock Farms in Illinois. Her dam has remarkable fertility, calving in the first week or two of the calving season every one of her five years. Pasture exposed to Beckton Epic T524, Reference Sire E-5. Pedigree is 6+ generations OS clear.

76 **BKT LARKEISA U176 NM**
1A 100% # 1259428 Tattoo: BKT U176

Birth: 3-11-08

BECKTON NOMAD 7496

BECKTON LARKEISA M138 JC

BECKTON NEVA 5562
BKT MO1634-1549
THUNDERBOLT
MD 373 RC 523
BECKTON JUSTICE G302
BECKTON JULIAN GG B571
BKT VERNICE 9733 PC
BECKTON CLIFFTOP T C075
BKT LARKEISA C894 JV

Calv.Ease	BW	WW	YW	Milk	Tmat	CETM	HPG	Maint.En.	Stay
16	-5.1	21	37	8	18	5	11	-9.0	11
Marb +.00		REA -.19			Bfat +.00				

The dam of Larkeisa also produced Reference Sire N-3, and she is still in the herd without a miss in her seven years. Larkeisa is very low for maintenance energy EPD, as is our new sire she is pasture exposed to, Beckton Epic U126, Reference Sire N-8. Pedigree is 6+ generations OS clear.

79 **MUSHRUSH PRIMROSE JL U065**
1A 100% # 1245954 Tattoo: MUS U065

Birth: 2-29-08

MUSHRUSH EPICN725 LN S124

MUSHRUSH PRIMROSE WR R376

BECKTON EPIC N725 KJ
MUS MISS LANCER 8031
BECKTON WARRIOR M099 T
PRIMROSE 3557
BECKTON EPIC KJ J722
BKT PINE MARIE J556 EP
BECKTON LANCER F270 T
MUS PRAIRIE MADAM 5017
BECKTON WARRIOR T C371
BECKTON ENCINO E044 WR
ROY ADVANCE C451
RCN KURUBA CP 605

Calv.Ease	BW	WW	YW	Milk	Tmat	CETM	HPG	Maint.En.	Stay
2	+2.8	37	71	19	37	2	9	-1.0	11
Marb +.22		REA +.12			Bfat -.01				

Worlds of growth (114 WR, 113 YR) coupled with worlds of carcass potential (IMF ratio 151 with 5.1% IMF on a forage ration and 115 REA ratio). [Pasture Exposure Ref. Sire C]

77 **BECKTON LANA U182 JC**
1A 100% # 1258852 Tattoo: WF U182

Birth: 3-11-08

BECKTON JUSTICE C1 R483

BECKTON LANA H544 WR

BECKTON JUSTICE CH M056
BECKTON RUTH K802 HD
BECKTON HERALD F FA20
BECKTON TAMARA F183 CT
BECKTON WARRIOR TC E801
BECKTON WARRIOR T C371
BECKTON MINOLA C251 NM
BECKTON CLIPPER K Z420
BECKTON LANA Z357 MB

Calv.Ease	BW	WW	YW	Milk	Tmat	CETM	HPG	Maint.En.	Stay
11	-2.2	26	64	12	25	4	10	+1.0	9
Marb +.08		REA +.01			Bfat -.01				

The Lana dam of this nice heifer produced for us for 10 years, with a record high up in the herd - 103 progeny average for weaning and 107 for yearling. Both Lana and her pasture exposure sire Beckton Clifftop U575, Reference Sire B-3, feature low maintenance energy EPD's. Pedigree is 6+ generations OS clear.

80 **MUSHRUSH ZENA JL U079**
1A 100% # 1245932 Tattoo: DANS U079

Birth: 3-3-08

MUSHRUSH JULIAN N153

MUSHRUSH ZENA LN R049

TJR 7526 922 L38
TJR A664 836 K10
MUSHRUSH LANCER 1233
MUSHRUSH LANA 9031
BKT JULIAN 7526 G
TJR A664 713 922
BECKTON LANCER T A664
TJR UTE 816 836
BECKTON LANCER F270 T
MUS PRAIRIE MADAM 7029
BECKTON LANCER F270 T
MUS MISS ZENITH 6008

Calv.Ease	BW	WW	YW	Milk	Tmat	CETM	HPG	Maint.En.	Stay
6	+2.2	35	66	9	26	3	5	-5.0	13
Marb +.13		REA -.11			Bfat -.01				

Lancer x Julian with worlds of growth and top 2% ME EPD. 6+ gen OS clear [Pasture Exposure Ref. Sire C (5/25 - 8/3)]

• Registered Females •



Mushrush Goldie LN U163
Lot 81

83 MUSHRUSH LANA AF U106
1A 100% # 1245846 Tattoo: MUS U106

Birth: 3-9-08
 BFCK CHEROKEE CNYN 4912 < BUF CRK CHF 824-1658
 MRM 1431 8611 9109
BROWN-CBAR AFFIRMED P7081
 Ref. M < BROWN MS ABIGRACE L7730 < GLACIER LOGAN 210
 LCHMN ABIGAIL E1013
 BECKTON LANCER F270 T < BECKTON LANCER T A664
MUS MISS LANCER 8038 < BECKTON LANA A754 PC
 MUS PRAIRIE MADAM 5008 < MUS PRARIE MASTER 241
 MUS GOLDEN GIRL 332

Calv.Ease	BW	WW	YW	Milk	Tmat	CETM	HPG	Maint.En.	Stay
7	-0.6	29	54	11	26	0	6	+2.0	12
	Marb	+1.15		REA	+0.07		Bfat +0.00		

A smaller framed heifer that will really catch your eye. 6+ gen OS clear [A.I. Sire E, Pasture Exposure Ref. Sire B (5/23 - 8/1)]

81 MUSHRUSH GOLDIE LN U163
1A 100% # 1245795 Tattoo: MUS U163

Birth: 4-14-08
 BFCK CHEROKEE CNYN 4912 < BUF CRK CHF 824-1658
 MRM 1431 8611 9109
BROWN-CBAR AFFIRMED P7081
 Ref. M < BROWN MS ABIGRACE L7730 < GLACIER LOGAN 210
 LCHMN ABIGAIL E1013
 BUF CRK JULIAN 5138 < BKT JULIAN 7526 G
MUSHRUSH GOLDIE 0133 < BUF CRK PNMARIE 1781
 MUS BETTER GIRL 7016 < LMAN NONE BETTER 9604
 MUS GOLDEN GIRL 131

Calv.Ease	BW	WW	YW	Milk	Tmat	CETM	HPG	Maint.En.	Stay
1	+3.0	48	82	18	42	1	8	+7.0	13
	Marb	+2.2		REA	+0.07		Bfat +0.00		

Whoa Nellie! Top 1% WW, top 3% YW, top 6% TM, tip 13% Stay and top 7% Marb, all from a 108 Mppa dam. 6+ gen OS clear [Pasture Exposure Ref. Sire C (5/23 - 8/3)]

84 MUSHRUSH ZENA JL U127
1A 100% # 1245969 Tattoo: MUS U127

Birth: 3-12-08
 TR JULIAN LT142 < BECKTON JULIAN GG B571
 TR LANA G760
MUSHRUSH LT N020
 MUSHRUSH LANA 1061 < BUF CRK JULIAN 5138
 MUS MISS LANCER 5025
 MUSHRUSH JULIAN N117 < MUSHRUSH JULIAN 1005
MUSHRUSH ZENA JL S033 < MUS PRAIRIE MADAM 5089
 MUSHRUSH ZENA 1055 < BECKTON LANCER F270 T
 MUS MISS ZENITH 424

Calv.Ease	BW	WW	YW	Milk	Tmat	CETM	HPG	Maint.En.	Stay
16	-4.6	20	45	11	21	6	11	-2.0	17
	Marb	-1.10		REA	+2.29		Bfat +0.00		

Double Julian breeding puts CED top 1%, BW top 2%, ME top 4% and Stayability top 3%. tested OS free [Pasture Exposure Ref. Sire C (5/23 - 8/3)]

82 MUSHRUSH LOGA OS U018
1A 100% # 1245843 Tattoo: MUS U018

Birth: 2-18-08
 BFCK CHEROKEE CNYN 4912 < BUF CRK CHF 824-1658
 MRM 1431 8611 9109
LJC CHEROKEE M03
 BUCKEYE MOLLIE < DMW HEAVEN F63
 BUCKEYE SOPHIA
 MUS PRAIRIE LOGAN 5066 < GLACIER LOGAN 210
 MUS 821 C
MUS MISS LOGAN 8017 < PANHANDLE CENTERSTAGE
 MUS MISS CENTER 6026 < MUS 818 C

Calv.Ease	BW	WW	YW	Milk	Tmat	CETM	HPG	Maint.En.	Stay
6	-1.1	27	45	15	29	1	6	+4.0	9
	Marb	+0.05		REA	+0.03		Bfat -0.02		

Feb. 18, 2009 was evidently a cold night as Mushrush Loga U018 has one slightly frozen ear. Herd matron Lot 3 shows up again!. 6+ gen OS clear [Pasture Exposure Ref. Sire B (5/18 - 8/1)]

85 BECKTON COCA U638 JL
2 100% # 1259362 Tattoo: BKT U638

Birth: 3-29-08
 BECKTON JULIAN GG B571 < BKT JULIAN 7526 G
 BKT MARTA 9A13 JL
BECKTON JULIAN G3 P608
 BKT SUFFEINA A828 DM < BECKTON DOMINOR 9455
 BKT SUFFEINA 9493 TT
 BECKTON CLIFFTOP T C075 < BJR TOPPER 5241
BECKTON COCA F370 CT < BECKTON BARMAID A761 TR
 BECKTON COCA C178 VG < BECKTON VEGAS 9433
 BECKTON COCA 8372 TJ

Calv.Ease	BW	WW	YW	Milk	Tmat	CETM	HPG	Maint.En.	Stay
17	-5.5	15	40	12	20	4	9	-5.0	20
	Marb	+0.06		REA	+0.09		Bfat -0.01		

The Coca F370 dam of this heifer is another of the grand matrons at Beckton. She will produce her 12th calf for us next spring. This daughter comes from Julian B571 on the sire side, and has an impressively low -5 maintenance energy EPD. Pasture exposed to Beckton Likable U091, Reference Sire L-4. Pedigree is 6+ generations OS clear.

• Registered Females •

86 **BSF CODETTE U165 CD**
1B 99.7% # 1259166 Tattoo: BSF U165

Birth: 3-10-08

BECKTON CODY K2 R168
Ref. C-1

BECKTON CAESAR M D023
BSF REGUS F207
BSF REGUS D006

BECKTON CODY K G701
BECKTON TAMARA J124 HR
BECKTON VEGAS SV H078
BECKTON TAMARA HA38 WR
BECKTON CAESAR B679
BECKTON LANA B460 MB
BECKTON HERALD K B244
BSF REGUS B368

Calv.Ease	BW	WW	YW	Milk	Tmat	CETM	HPG	Maint.En.	Stay
18	-7.8	9	31	19	24	4	9	+2.0	13
Marb +.05		REA +.00		Bfat +.00					

Codette's dam has an outstanding production record, going strong for us at 13 years of age and never missing a calf. For longevity, stayability, fertility, and milk, Codette should be terrific. Pasture exposed to Beckton Likable U091, Reference Sire L-4. Pedigree is 6+ generations OS clear.

89 **BSF NEENA U754 JO**
1B 99.4% # 1259226 Tattoo: BSF U754

Birth: 4-10-08

BECKTON JULIO L233

BECKTON NEPTUNE R2 K065
BSF NEENA N333 NP
BSF BROCKLE G498

BECKTON JULIAN G1 J526
BECKTON ANNIE F743 LN
BECKTON EPIC K F075
BECKTON ROSE F192 CL
BECKTON NEPTUNE RR B284
BECKTON LANA C735 TP
MULTIPLE SIRE
BSF REGUS B655

Calv.Ease	BW	WW	YW	Milk	Tmat	CETM	HPG	Maint.En.	Stay
13	-4.9	22	46	15	26	3	7	-6.0	14
Marb +.08		REA +.04		Bfat +.00					

Excellent maintenance energy EPD of -6 together with good numbers throughout, and out of an excellent Lana dam. Weighing 1055 at six years of age, she has progeny averages of 106 at yearling and 110 for weaning weight for her calves. Pasture exposed to Beckton Likable U091, Reference Sire L-4. Pedigree is 6+ generations OS clear.

87 **BECKTON COCA U212 VA**
1A 100% # 1259567 Tattoo: BKT U212

Birth: 3-12-08

BECKTON VEGA P079
Ref. V-1

BECKTON WARRIOR CL M686
BECKTON COCA R375 WR
BECKTON COCA K480 CO

BECKTON VEGAS SV H078
BECKTON EOLA H073 EP
BECKTON JULIAN GG B571
BECKTON LYDIA D386 CL
BECKTON WARRIOR C C355
BECKTON CHRISTY J223 LN
BECKTON COPPER JT G095
BECKTON COCA C178 VG

Calv.Ease	BW	WW	YW	Milk	Tmat	CETM	HPG	Maint.En.	Stay
16	-4.8	20	44	14	24	5	11	+4.0	17
Marb +.01		REA +.12		Bfat +.00					

Coca's pasture sire, and our newest Julian herd sire, Beckton Julian U742, Reference Sire J-7, we expect to be outstanding. Take a look at his EPD's - strong in everything - very high calving ease, high for growth, carcass traits, milk, very low for maintenance energy, and very high stayability. Pedigree is 6+ generations OS clear.

90 **BECKTON TAMARA U358 CT**
1A 100% # 1259419 Tattoo: BKT U358

Birth: 3-18-08

BKT CLIFFTOP TP R288
Ref. B-1

BECKTON TAMARA L801 CL

BECKTON CLIFFTOP T C075
BECKTON CHRISTY K209 CO
BECKTON CLIPPER KH F416
BECKTON TAMARA H625 CH

BJR TOPPER 5241
BECKTON BARMAID A761 TR
BECKTON COPPER JT G095
BECKTON CHRISTY A111 VQ
BECKTON CLIPPER K Z420
BECKTON ENCINO C644 ZN
BECKTON CHAMP RH F275
BECKTON TAMARA F658 TP

Calv.Ease	BW	WW	YW	Milk	Tmat	CETM	HPG	Maint.En.	Stay
11	-3.6	21	43	18	28	2	6	+2.0	14
Marb -.01		REA +.26		Bfat -.01					

This high milk potential heifer is out of a Tamara dam with an above average weaning record on her own calves. Pasture exposed to Beckton Emperor U668 (Reg# 1259448) and expected by the vet to calve early. Pedigree is 6+ generations OS clear.

88 **BECKTON COCA U303 NB**
1A 100% # 1259418 Tattoo: BKT U303

Birth: 3-16-08

BECKTON NEBULA E P084
Ref. N-2

BECKTON COPPER JG H648
BECKTON COCA L794 CO
BECKTON COCA H256 JL

BECKTON NEPTUNE R2 K065
BECKTON BELGA K285 JL
BECKTON EPIC K F075
BKT PINE MARIE D126 JL
BECKTON COPPER J E616
BKT INDIGO 9235 GL
BKT JULIAN 7526 G
BECKTON COCA D283 JV

Calv.Ease	BW	WW	YW	Milk	Tmat	CETM	HPG	Maint.En.	Stay
14	-4.6	15	39	11	18	5	13	-5.0	19
Marb +.16		REA -.05		Bfat +.01					

Very low maintenance energy EPD with Coca U303. Her dam is still in the herd producing every year at eight. Pasture exposed to Beckton Likable U091, Reference Sire L-4. Pedigree is 6+ generations OS clear.

91 **MUSHRUSH LISA U175**
1A 100% # 1245792 Tattoo: MUS U175

Birth: 3-29-08

BUF CRK LANCER R017
Ref. N

MUSHRUSH LISA 0047

BECKTON LANCER F442 T
BUF CRK JULIET N036
BUF CRK JULIAN 5138
BUF CRK LISA 4980

BECKTON LANCER T A664
BKT SUFFEINA A828 DM
BECKTON JULIAN GG B571
BUF CRK PRIMROSE 5679
BKT JULIAN 7526 G
BUF CRK PNMARIE 1781
BUF CRK CHF 824-1658
BUF CRK LISA 3156

Calv.Ease	BW	WW	YW	Milk	Tmat	CETM	HPG	Maint.En.	Stay
9	+0.2	34	63	14	31	4	8	-1.0	19
Marb +.22		REA -.09		Bfat +.00					

Lancer, Julian, and Canyon combine for a Stayability EPD off the chart. Add a 123 IMF ratio and -1 ME for a really nice herd enhancing female. tested OS free [Pasture Exposure Ref. Sire C (5/23 - 8/3)]

• Registered Females •

92 MUSHRUSH JA EPICY U174
1A 100% # 1245873 Tattoo: MUS U174

Birth: 3-29-08
 BECKTON EPIC R415 KM
 BECKTON EPIC KM M115
 BECKTON LYDIA G059 WR
 TJR G361 G95 L61
 BECKTON LANCER G361 TZ
 TJR CE 325 G95
 BECKTON EPIC K F075
 BECKTON MINERVA F495 CH
 BECKTON WARRIOR TC E801
 BECKTON LYDIA E838 NP
 BECKTON LANCER TZ D525
 BECKTON LANA 9052 NM
 MRM SUPREME CE
 TJR 9004 904 325

Calv.Ease	BW	WW	YW	Milk	Tmat	CETM	HPG	Maint.En.	Stay
11	-1.8	22	47	14	25	4	8	-3.0	12
Marb -.01		REA -.01		Bfat +.00					

A nice low birth, low maintenance high Stayability heifer. A little smaller frame if you are trying to downsize. 6+ gen OS clear [A.I. Sire E, Pasture Exposure Ref. Sire D (5/23 - 8/3)]

95 MUSH CHIEFGIRL JL U198
1A 100% # 1245943 Tattoo: MUS U198

Birth: 5-12-08
 MUSHRUSH JULIAN N153
 Ref. H
 MUSHRUSH CHIEFGIRL OS R136
 TJR 7526 922 L38
 TJR A664 836 K10
 LJC CHEROKEE M03
 MUSHRUSH CHIEFGIRL M052
 BKT JULIAN 7526 G
 TJR A664 713 922
 BECKTON LANCER T A664
 TJR UTE 816 836
 BFCK CHEROKEE CNYN 4912
 BUCKEYE MOLLIE
 MUSHRUSH PIONEER 0014
 MUSHRUSH LANA 8147

Calv.Ease	BW	WW	YW	Milk	Tmat	CETM	HPG	Maint.En.	Stay
5	+2.0	38	67	15	34	3	7	+1.0	13
Marb +.04		REA +.00		Bfat -.02					

Check out the depth of body and spring of rib on this moderate framed heifer. 6+ gen OS clear [Pasture Exposure Ref. Sire C (5/23 - 8/3)]

93 MUSHRUSH GB92 EPICY U193
1A 100% # 1245857 Tattoo: MUS U193

Birth: 4-14-08
 BECKTON EPIC R415 KM
 BECKTON EPIC KM M115
 BECKTON LYDIA G059 WR
 BECKTON LANA GB92
 BECKTON CLIPPER EZ BB55
 BECKTON LANA 9011 NM
 BECKTON EPIC K F075
 BECKTON MINERVA F495 CH
 BECKTON WARRIOR TC E801
 BECKTON LYDIA E838 NP
 BECKTON CLIPPER Z324
 BKT MINOLA 8042 ZP
 BECKTON NOMAD 7496
 BKT TOVO LANA 4810

Calv.Ease	BW	WW	YW	Milk	Tmat	CETM	HPG	Maint.En.	Stay
9	-1.7	19	42	11	20	1	11	-2.0	8
Marb +.10		REA -.24		Bfat +.00					

Dam GB92 is one of our all time favorite cows. We have kept every other heifer she has had but decided to let you have a chance at U193. 6+ gen OS clear [Pasture Exposure Ref. Sire D (5/20 - 8/3)]

96 MUSHRUSH BERNIE AF U192
1A 100% # 1245794 Tattoo: MUS U192

Birth: 4-14-08
 BROWN-CBAR AFFIRMED P7081
 Ref. M
 MUSHRUSH BERNIE 0119
 MUS MISS CHIEFDOM 457
 BFCK CHEROKEE CNYN 4912
 BROWN MS ABIGRACE L7730
 BUF CRK BARNEY 3474
 MUS MISS CHIEFDOM 457
 BUF CRK CHF 824-1658
 MRM 1431 8611 9109
 GLACIER LOGAN 210
 LCHMN ABIGAIL E1013
 BUF CRK BARON 2678
 OLE SUNFLOWER 359 PB08
 LEACHMAN CHIEFDOM 2X
 MUS 823 C

Calv.Ease	BW	WW	YW	Milk	Tmat	CETM	HPG	Maint.En.	Stay
2	+1.8	45	77	17	40	1	7	+7.0	10
Marb +.19		REA +.12		Bfat +.01					

High growth heifer with 135% IMF ratio. 6+ gen OS clear [Pasture Exposure Ref. Sire B (5/20 - 8/1)]

94 MUSHRUSH SIERRA EP U195
1A 100% # 1245823 Tattoo: MUS U195

Birth: 4-22-08
 MUSHRUSH EPIC N223
 Ref. J
 SIERRA GEM 3451
 BECKTON EPIC K F075
 ROSEBUD 3574
 GOLDMINE 7416
 BETSY 2014
 BECKTON EPIC D404
 BECKTON BELGA D483 KR
 DALLAS 2347
 AMY 3096
 LCHMN GOLD ROBBER 1909E
 SANTIAM'S PAT G14
 REMINGTON 647
 TOKAY LADY 444

Calv.Ease	BW	WW	YW	Milk	Tmat	CETM	HPG	Maint.En.	Stay
5	+1.6	37	64	16	35	4	13	-1.0	7
Marb +.13		REA -.12		Bfat +.01					

Lots of growth, low maintenance, and a 124 IMF ratio to boot. All from our slick haired sire Epic N223. 6+ gen OS clear [Pasture Exposure Ref. Sire B (5/20 - 8/1)]

97 MUSHRUSH LANA OS U102
1A 100% # 1245889 Tattoo: MUS U102

Birth: 3-8-08
 MUSHRUSH OSAGE LN P017
 Ref. L
 MUSHRUSH LANA N022
 LJC CHEROKEE M03
 MUSHRUSH LANA 1061
 TR JULIAN LT142
 MUSHRUSH LANA 1035
 BFCK CHEROKEE CNYN 4912
 BUCKEYE MOLLIE
 BUF CRK JULIAN 5138
 MUS MISS LANCER 5025
 BECKTON JULIAN GG B571
 TR LANA G760
 BUF CRK JULIAN 5138
 MUS MISS LANCER 8058

Calv.Ease	BW	WW	YW	Milk	Tmat	CETM	HPG	Maint.En.	Stay
20	-8.7	10	32	14	19	6	8	+2.0	20
Marb -.04		REA -.16		Bfat -.01					

Be sure to check out both the CED and Stayability EPD's . You probably will never see either one this high again, and for sure not on the same animal. One ear is nipped back a little. 6+ gen OS clear [A.I. Sire F, Pasture Exposure Ref. Sire D (5/20 - 8/3)]

• Registered Females •

98 MUSHRUSH GUNNER U060
 3 50% # 1245863 Tattoo: MUS U060
 Birth: 2-27-08
 RC STINGER 072K
TNT GUNNER N208
 TNT MISS HONEY L9
 MRM ANASAZI G85
MRM G85 H198 K43
 MRM 605 302D H198
 CCR GRIFFEY
 MISS RC 600U 501F
 JF NEW DIMENSION 903J
 TNT MISS ALLIE J1
 MRM UTE
 BUF CRK ANNE 3091
 MRM DYNAMO GRANDE 605
 RED SSS LARKABA 302D

Calv.Ease	BW	WW	YW	Milk	Tmat	CETM	HPG	Maint.En.	Stay
11	-3.4	12	17	9	15	3	6	-6.0	8
Marb -.04		REA -.19		Bfat +.00					

F1 Simmental X Red Angus heifer. She is registered with the RAAA so her EPDs do not take any sire contribution into account. Calving ease and low maintenance. Lot 98 will compliment any herd. 6+ gen OS clear [Pasture Exposure Ref. Sire B (5/20 - 8/1)]



Beckton Justicia U261 NM
Lot 99

99 BSF JUSTICIA U261 NM
 1B 99.8% # 1259236 Tattoo: BSF U261
 Birth: 3-14-08
 BECKTON NOMAD 7496
BECKTON NOMAD V 9871
 BKT BARMAID 6986 VR
 BECKTON JUSTICE CH M056
BSF JUSTICIA P007
 BSF REGUS M024 HR
 BECKTON NEVA 5562
 BKT BOLT TAMRCK 3913
 BECKTON VARO 5642
 BKT LAHROGNO-3
 BECKTON JUSTICE C K449
 BECKTON RUTH K802 HD
 BECKTON HERALD FN K641
 BSF REGUS K745 CT

Calv.Ease	BW	WW	YW	Milk	Tmat	CETM	HPG	Maint.En.	Stay
15	-5.4	18	31	11	20	3	9	-8.0	10
Marb +.08		REA -.12		Bfat +.00					

To downsize your Maintenance Energy requirements, try this Justicia heifer – an ME of -8. Pasture exposed to Beckton Likable U091, Reference Sire L-4. Pedigree is 6+ generations OS clear.

100 BECKTON LARKABA U498 EP
 1A 100% # 1259562 Tattoo: BKT U498
 Birth: 3-23-08
 BECKTON EPIC K F075
BECKTON EPIC R350 K
 Ref. E-2
 BECKTON LARKABA E042 CD
 BECKTON COLT K M609
BECKTON LARKABA R336 CK
 BECKTON LARKABA J649 CR
 BECKTON EPIC D404
 BECKTON BELGA D483 KR
 BECKTON CODY C401
 BECKTON LARKABA C317 CL
 BECKTON COLT G552
 BECKTON ANGEL H164 LO
 BECKTON COLTER H F112
 BECKTON LARKABA F279 LN

Calv.Ease	BW	WW	YW	Milk	Tmat	CETM	HPG	Maint.En.	Stay
9	-1.1	31	61	15	30	2	9	+8.0	12
Marb +.00		REA -.04		Bfat +.01					

Larkaba has been pasture exposed to a new young Nebula sire, Beckton Nebula U060, Reference Sire N-10, with some impressive performance credentials - - 0.5 BW +62 YW +15 Milk +10 HPG +16 Stay +.16 Marb +.12 Ribeye and -3 ME. Pedigree is 6+ generations OS clear.

101 BSF JULESTE U757 CD
 2 99.8% # 1259270 Tattoo: BSF U757
 Birth: 4-10-08
 BECKTON CODY KH M390
BECKTON CODY K2 R168
 Ref. C-1
 BECKTON TAMARA K249 VG
 BECKTON JULES L429
BSF JULESTE R249 JE
 BSF RED K467 CD
 BECKTON CODY K G701
 BECKTON TAMARA J124 HR
 BECKTON VEGAS SV H078
 BECKTON TAMARA HA38 WR
 BECKTON JULIAN G1 J526
 BECKTON BARONA J591 EP
 BECKTON CODY V E023
 BSF REGUS F793

Calv.Ease	BW	WW	YW	Milk	Tmat	CETM	HPG	Maint.En.	Stay
15	-4.8	21	54	16	27	4	12	-2.0	13
Marb -.01		REA +.05		Bfat +.00					

Low maintenance energy EPD with high Heifer Pregnancy, Milk and Stayability. Juleste has been pasture exposed to Beckton Epic T524, Reference Sire E-5. Pedigree is 6+ generations OS clear.

102 BECKTON LARKABA U028 HS
 1A 100% # 1258817 Tattoo: BKT U028
 Birth: 2-19-08
 BECKTON HASTEN P292
BECKTON HASTEN H S462
 Ref. H-1
 BECKTON LAKME G128 HD
 BECKTON HASTEN P292
BECKTON LARKABA S838 HS
 BECKTON LARKABA M715 WR
 BECKTON HUSTLER C2 L079
 BECKTON SHEBA L644 CH
 BECKTON HADRIAN FC E166
 BECKTON LAKME E373 CL
 BECKTON HUSTLER C2 L079
 BECKTON SHEBA L644 CH
 BECKTON WARRIOR C C355
 BECKTON LARKABA D388 SC

Calv.Ease	BW	WW	YW	Milk	Tmat	CETM	HPG	Maint.En.	Stay
12	-3.5	28	55	18	32	5	10	+3.0	12
Marb +.01		REA +.05		Bfat +.00					

Larkaba is linebred Hustler L079, and her dam is an exceptional young cow, with progeny averages of 105 at yearling and 110 for weaning weight. Pasture exposed to Beckton Hasten U108, Reference Sire H-3, so her calf could be triple bred to the sire of the ABS Heritage bull. Pedigree is 6+ generations OS clear.

• Registered Females •

103 BSF JULIANNE U418 WA
1B 87.5% # 1259295 Tattoo: BSF U418

Birth: 3-20-08
 BECKTON WARRIOR T1 H281 < BECKTON WARRIOR TC E801
 BECKTON MINERVA B609 RN
BECKTON WARHAWK N560
 BECKTON FIREFLY H195 HD < BECKTON HADRIAN A100
 BECKTON FIREFLY C999 CB
 BSF JULIANNE R768 JL < BECKTON JULIAN GG B571
 BECKTON ANNIE F743 LN
 BRU RED LC54 < BECKTON CODY C401
 UNIDENTIFIED DAM

Calv.Ease	BW	WW	YW	Milk	Tmat	CETM	HPG	Maint.En.	Stay
15	-4.7	26	44	15	28	5	14	.0	13
Marb +.04		REA +.01		Bfat +.00					

Nicely balance EPD's with low maintenance energy in a heifer descended from Julian B571. Pasture exposed to Beckton Epic T524, Reference Sire E-5. Pedigree is 6+ generations OS clear.

106 MUSH CT PRETTY LADY P253
1A 100% # 1015574 Tattoo: MUR P253

Birth: 9-19-04
 BECKTON COLT G552 < BECKTON CLIPPER KC D400
 BECKTON ROSE Z519 ZN
BECKTON COLT L336
 BECKTON BELGA F772 VG < BECKTON VEGAS 9433
 BECKTON BELGA A750 SN
 PRETTY LADY 3482 < QUANTUM 2491
 PANHANDLE CENTERSTAGE
 ROY CATHY 2405
 ROMA 2655 < DFR EL CAPITAN 13ZA
 COWBOYS CINDY

Calv.Ease	BW	WW	YW	Milk	Tmat	CETM	HPG	Maint.En.	Stay
12	-3.0	19	41	11	21	4	6	+10.0	6
Marb -.11		REA -.09		Bfat +.01					

A little different pedigree. 6+ gen OS clear [Pasture Exposure Ref. Sire P (5/22 - 6/26), Pasture Exposure Ref. Sire V (6/26 - 7/27)]

104 BSF LANETTE U876 CD
1B 99.6% # 1259255 Tattoo: BSF U876

Birth: 5-19-08
 BECKTON CODY KH M390 < BECKTON CODY K G701
 BECKTON TAMARA J124 HR
BECKTON CODY K1 P014
 BECKTON ROSE M126 WR < BECKTON WARRIOR T C371
 BECKTON ROSE D741 LN
 BSF LANETTE P754 < BECKTON LANCER TZ D525
 BECKTON VERNICE D121 VG
 BSF REGUS L619 JL < BKT JULIAN 7526 G
 BSF RED E036

Calv.Ease	BW	WW	YW	Milk	Tmat	CETM	HPG	Maint.En.	Stay
18	-6.6	16	47	13	21	5	8	+1.0	17
Marb -.04		REA +.08		Bfat +.00					

High calving ease, low maintenance, high stayability are characteristics of nearly all Beckton cattle, and Lanette brings all of these to her new owner. Pasture exposed to Beckton Epic T524, Reference Sire E-5. Pedigree is 6+ generations OS clear.

107 MUSHRUSH PRAIRIE MADAM
1A 100% # 818573 Tattoo: MUS 1182

Birth: 9-16-01
 BECKTON LANCER T A664 < BECKTON LANCER 9380
 BECKTON COCA 9119 TJ
BECKTON LANCER F270 T
 BECKTON LANA A754 PC < BECKTON PACER 8940
 BECKTON LANA 7405 NP
 MUS PRAIRIE MASTER 241 < MUS PRAIRIE MASTER811
 MUS 540 C
MUS PRAIRIE MADAM 5017
 MUS GOLDEN GIRL < PRAIRIE GOLD 723 MUS
 MUS PRAIRIE MADAM 012

Calv.Ease	BW	WW	YW	Milk	Tmat	CETM	HPG	Maint.En.	Stay
10	-1.6	19	45	13	23	1	6	+4.0	6
Marb +.09		REA -.07		Bfat +.00					

Beckton Lancer F270 was a herd changer for Mushrush Red Angus, propelling our program forward. 6+ gen OS clear [Pasture Exposure Ref. Sire P (5/22 - 6/26), Pasture Exposure Ref. Sire V (6/26 - 7/27)]

105 MUSHRUSH LARKABA M060
1A 100% # 841451 Tattoo: MUR M060

Birth: 3-10-02
 BECKTON LANCER T A664 < BECKTON LANCER 9380
 BECKTON COCA 9119 TJ
BECKTON LANCER F270 T
 BECKTON LANA A754 PC < BECKTON PACER 8940
 BECKTON LANA 7405 NP
 BECKTON CLIPPER A361 < BECKTON CLIPPER 8496
 BKT LAKOTA 8643 JL
BECKTON LARKABA GB91
 BECKTON LARKABA Z581 KR < BECKTON KAISER 7143F
 BKT LARKABA 6696 GS

Calv.Ease	BW	WW	YW	Milk	Tmat	CETM	HPG	Maint.En.	Stay
7	+1.7	35	61	12	29	2	7	+4.0	9
Marb -.09		REA -.21		Bfat -.01					

Dam, Beckton Larkaba GB91 was one of our all time favorite cows. M060's own growth ratios show you why. Let her become your favorite cow. 6+ gen OS clear [Pasture Exposure Ref. Sire Q (5/27 - 6/3), Pasture Exposure Ref. Sire J (6/3 - 8/3)]

108 BECKTON LANA T553 JJ
1A 100% # 1178600 Tattoo: BKT T553

Birth: 3-24-07
 BECKTON JULIAN G1 J526 < BECKTON JULIAN GG B571
 BECKTON ANNIE F743 LN
BECKTON JUNO N493
 BECKTON SERENA D760 KR < BECKTON KAISER FD 9253
 BECKTON SERENA A420 MB
 BECKTON LANCER T A664 < BECKTON LANCER 9380
 BECKTON COCA 9119 TJ
BECKTON LANA L734 LN
 BECKTON LANA F245 NP < BECKTON NEPTUNE RR B284
 BECKTON LANA 9082 NM

Calv.Ease	BW	WW	YW	Milk	Tmat	CETM	HPG	Maint.En.	Stay
18	-7.1	24	38	11	23	3	4	+1.0	15
Marb -.01		REA -.03		Bfat -.01					

Another of the prolific Lana dam line, T553 is a low maintenance, high calving ease EPD female. Her dam is strong in our herd at eight, and has been an early calver. Pasture exposed to a high growth new herd sire, Beckton Lancer T371, Reference Sire L-3. Pedigree is 6+ generations OS clear.

• Registered Females •

109 **BECKTON TAMARA T240 JV**
1A 100% # 1178750 Tattoo: WF T240

Birth: 3-11-07
 BECKTON JAVELIN 6587
BKT JAVELIN 7466 R
 BECKTON ROSE 6807 RZ
 BECKTON JULIO L233
BECKTON TAMARA N421 JO
 BECKTON TAMARA L888 NW
 BECKTON TROJAN 5253
 BKT ILEXIMKA-3
 BECKTON RAZA 2308-N
 BKT BAYA ROSE 5195
 BECKTON JULIAN G1 J526
 BECKTON ROSE J725 EP
 BECKTON NEWARK G611
 BECKTON TAMARA HA38 WR

Calv.Ease	BW	WW	YW	Milk	Tmat	CETM	HPG	Maint.En.	Stay
15	-5.0	7	7	8	12	4	9	-16.0	12
	Marb	-.05		REA	-.23		Bfat	+.00	

A super low Maintenance Energy EPD young cow. Pasture exposed to a high growth new herd sire, Beckton Lancer T371, Reference Sire L-3. Pedigree is 6+ generations OS clear.



Mushrush Prairie Madam M121
Lot 112

110 **BKT LARKEISA R775 JC**
1A 100% # 1042513 Tattoo: WF R775

Birth: 4-17-05
 BECKTON JUSTICE G302
BECKTON JUSTICE C K449
 BKT LARKABEL C742 CF
 BECKTON COLT G552
BKT LARKEISA L149 CK
 BKT LARKEISA E578 HB
 BECKTON JULIAN GG B571
 BKT VERNICE 9733 PC
 JKG CHIEFTON L303
 BKT LARKABEL 8541 ZP
 BECKTON CLIPPER KC D400
 BECKTON ROSE Z519 ZN
 BUF CRK HOBO 1961
 BKT LARKEISA B312 CB

Calv.Ease	BW	WW	YW	Milk	Tmat	CETM	HPG	Maint.En.	Stay
10	-1.2	37	72	9	28	6	12	+4.0	10
	Marb	+.04		REA	-.02		Bfat	-.01	

Calves that average 104 at weaning and 109 at yearling, with only a 70 pound average birth weight, illustrate the tremendous spread from birth to yearling predicted by her EPD's. Pasture exposed to our Beckton Ranger T603, Reference Sire R-1. Pedigree is 6+ generations OS clear.

112 **MUS PRAIRIEMADAM M121**
1A 100% # 882987 Tattoo: MUS M121

Birth: 9-11-02
 LCC HEAVEN OR BUST1000B
MUSHRUSH PIONEER 0014
 BECKTON LARKABA GB91
 BECKTON LANCER F270 T
MUSHRUSH LANA 9137
 MUS PRAIRIE MADAM 465
 LEACHMAN HEAVENLY 8141
 LMAN MARY 9003
 BECKTON CLIPPER A361
 BECKTON LARKABA Z581 KR
 BECKTON LANCER T A664
 BECKTON LANA A754 PC
 MUS PRARIE MASTER 904
 MUS PRARIE MADAM 249

Calv.Ease	BW	WW	YW	Milk	Tmat	CETM	HPG	Maint.En.	Stay
11	-2.7	27	54	20	34	5	11	+11.0	7
	Marb	-.21		REA	-.15		Bfat	-.01	

A nice balanced cow who'd be an excellent addition to any herd. 6+ gen OS clear [Pasture Exposure Ref. Sire Q (5/27 - 6/3), Pasture Exposure Ref. Sire J (6/3 - 8/3)]

111 **MUSHRUSH LOGA M070**
1A 100% # 841445 Tattoo: MUC M070

Birth: 3-14-02
 LCC HEAVEN OR BUST1000B
MUSHRUSH PIONEER 0014
 BECKTON LARKABA GB91
 MUS PRAIRIE LOGAN 5066
MUSHRUSH LOGA 9098
 MUS MISS CHIEFDOM 467
 LEACHMAN HEAVENLY 8141
 LMAN MARY 9003
 BECKTON CLIPPER A361
 BECKTON LARKABA Z581 KR
 GLACIER LOGAN 210
 MUS 821 C
 LEACHMAN CHIEFDOM 2X
 MUS GOLDEN GIRL 131

Calv.Ease	BW	WW	YW	Milk	Tmat	CETM	HPG	Maint.En.	Stay
6	-1.3	24	46	16	28	6	9	-4.0	8
	Marb	+.03		REA	-.18		Bfat	-.02	

Son Cole is offering his 103 Mppa Logan x Heavenly herd matron. Easy fleshing genetics for lower costs. 6+ gen OS clear [Pasture Exposure Ref. Sire Q (5/27 - 6/3), Pasture Exposure Ref. Sire J (6/3 - 8/3)]



Mushrush Loga M070
Lot 111

• Registered Females •

113 MUSHRUSH MADAM EP S272
1A 100% # 1152387 Tattoo: MUS S273

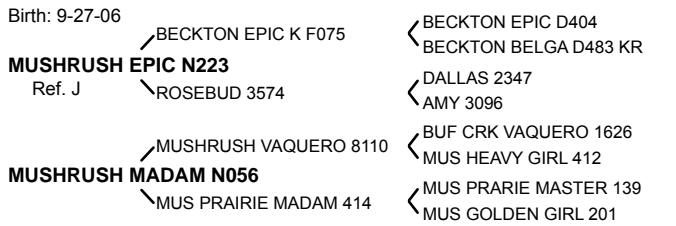

Calv.Ease	BW	WW	YW	Milk	Tmat	CETM	HPG	Maint.En.	Stay
7	-0.1	33	58	17	34	2	10	+3.0	10
Marb -.03		REA -.04		Bfat +.01					

Sire Mushrush Epic N223 is a son of the rare sought after F075. He typically sires thick, slick hared progeny popular with our Southern customers. 6+ gen OS clear [Pasture Exposure Ref. Sire P (5/22 - 6/26), Pasture Exposure Ref. Sire V (6/26 - 7/27)]

116 BECKTON ROSE P011 EP
1A 100% # 978337 Tattoo: WF P011

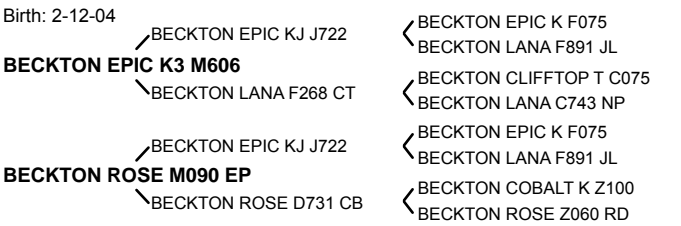

Calv.Ease	BW	WW	YW	Milk	Tmat	CETM	HPG	Maint.En.	Stay
9	-1.8	22	49	18	29	1	7	+7.0	14
Marb +.10		REA +.03		Bfat +.00					

A rare linebred Epic female, Rose is a very attractive 1185 pound cow that ranks in the top 10-15% of our herd for productivity. With an MPPA of 103, her calves have averaged 105 and 106% for weaning weight and yearling weight respectively. Rose is pasture exposed to Beckton Loki S284, Reference Sire L-2. Pedigree is 6+ generations OS clear.

114 BECKTON LARKABA S756 CH
1A 100% # 1119218 Tattoo: BKT S756

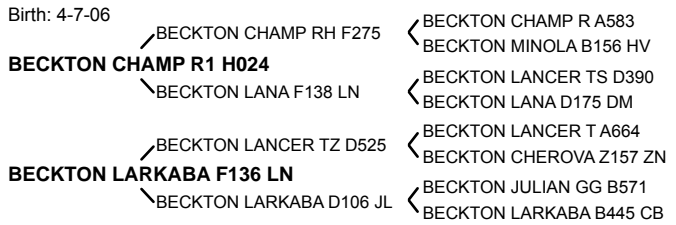

Calv.Ease	BW	WW	YW	Milk	Tmat	CETM	HPG	Maint.En.	Stay
19	-6.6	20	40	14	23	6	10	+2.0	16
Marb -.02		REA +.19		Bfat -.01					

One of the highest calving ease females in the breed at CED +19, with a -6.6 birth weight EPD, Larkaba S756 descends from one of our earliest cow lines. Very promising young cow to produce offspring with low birth weights and efficiency, since she weighs a moderate 965 pounds. Pasture exposed to our new herd bull son of the ABS Heritage sire, Beckton Heritage T270, Reference Sire H-2. Pedigree is 6+ generations OS clear.

117 OCHO VACA BREEZE S48
1A 100% # 1141214 Tattoo: OVCC S48

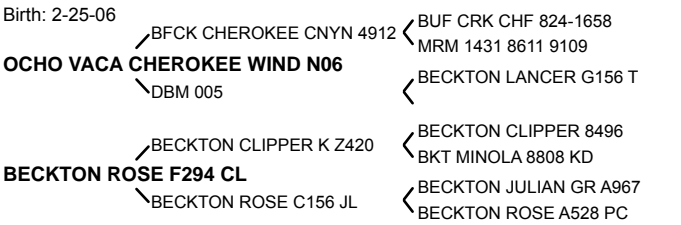

Calv.Ease	BW	WW	YW	Milk	Tmat	CETM	HPG	Maint.En.	Stay
10	-1.0	31	62	13	28	0	8	-5.0	11
Marb -.06		REA +.11		Bfat +.00					

Calving ease, extreme low maintenance, and high growth, all you could ask for in a nice young cow. 6+ gen OS clear [Pasture Exposure Ref. Sire Q (5/27 - 6/3), Pasture Exposure Ref. Sire J (6/3 - 8/3)]

115 BECKTON TAMARA R801 NB
1A 100% # 1042539 Tattoo: BKT R801

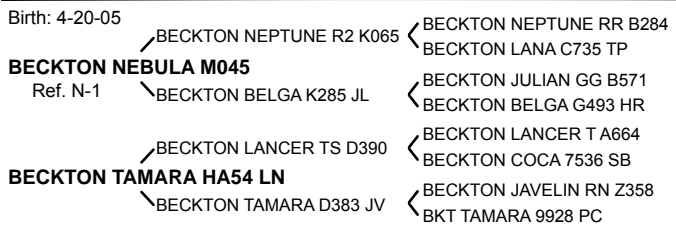

Calv.Ease	BW	WW	YW	Milk	Tmat	CETM	HPG	Maint.En.	Stay
15	-3.9	28	51	8	22	4	13	+2.0	17
Marb +.11		REA -.10		Bfat +.00					

Tamara is a young female, and we expect her milk EPD to be improving, since her calves are weaning very well with a 103 progeny average and a 102 MPPA. She weighs 1055 pounds so her efficiency is high also. She is pasture exposed to Beckton Hasten S462, Reference Sire H-1. Pedigree is 6+ generations OS clear.

118 TJR 7526 941 L12
1A 100% # 787823 Tattoo: TJR L12

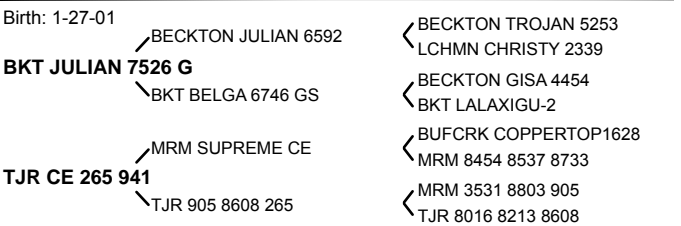

Calv.Ease	BW	WW	YW	Milk	Tmat	CETM	HPG	Maint.En.	Stay
6	+2.1	29	45	7	22	7	12	+2.0	14
Marb -.01		REA +.05		Bfat +.01					

One of a group of cows we purchased from Roberts Red Angus in New Mexico. Julian genetics from the original 7526G. Breed leading stayability and heifer pregnancy numbers. 6+ gen OS clear [Pasture Exposure Ref. Sire Q (5/27 - 6/3), Pasture Exposure Ref. Sire J (6/3 - 8/3)]

• Registered Females •

119 **TJR 1018 933 L07**
1A 100% # 787832 Tattoo: TJR L07

Birth: 1-24-01
 ESQUIRE 1018 ← BJR C-CHIEF 811
 ← CONNIE 1261
 TJR UTE 816 933 ← MRM UTE
 ← TJR L218 8608 816
 RCN CANYON CHIEF
 BJR LAKOTA 356-416
 CALIF COMSTOCK 160
 BEST WEST 617
 MRM 832 8203 9004
 CSU DOLORES 1405
 FTF DOUBLE CHF L218
 TJR 8016 8213 8608

Calv.Ease	BW	WW	YW	Milk	Tmat	CETM	HPG	Maint.En.	Stay
10	-0.8	20	28	12	22	8	11	+1.0	8
	Marb +.05			REA -.08			Bfat -.01		

Another super female from the Roberts program. Small loose lump is scar tissue from several years ago. 6+ gen OS clear [Pasture Exposure Ref. Sire O (5/27 - 8/3)]

121 **BECKTON INDIGO M514 CH**
1A 100% # 855289 Tattoo: WF M514

Birth: 3-25-02
 BECKTON CHAMP R3 H338 ← BECKTON CHAMP RK E121
 ← BECKTON ENCINO C644 ZN
 BECKTON INDIGO F587 LN ← BECKTON LANCER T A664
 ← BKT INDIGO 9235 GL
 BECKTON CHAMP R A583
 BECKTON CHRISTY Z453 KR
 BECKTON ZENITH LJ Z801
 BKT ENCINO 9A05 JL
 BECKTON LANCER 9380
 BECKTON COCA 9119 TJ
 BECKTON GALAHAD 8599
 BKT INDIGO 8631 DT

Calv.Ease	BW	WW	YW	Milk	Tmat	CETM	HPG	Maint.En.	Stay
15	-5.0	17	37	10	19	3	7	.0	17
	Marb -.05			REA -.03			Bfat +.00		

For those looking to downsize their herd, this Indigo line cow is one of our smaller cows, about 1000 pounds and very efficient, and she produces outstanding daughters. She is pasture exposed to Beckton Ranger T603, Reference Sire R-1, a new herd sire from an out-cross Ranger line within our program. Pedigree is 6+ generations OS clear.



Beckton Rose P016 LN
Lot 120

122 **MUSH CT DREAMING P362**
1A 100% # 1015573 Tattoo: MUR P362

Birth: 11-11-04
 BECKTON COLT L336 ← BECKTON COLT G552
 ← BECKTON BELGA F772 VG
 CALIFORNIA DREAMING 347 ← CALIFORNIA SUPREME 2087
 ← JOECY 2224
 BECKTON CLIPPER KC D400
 BECKTON ROSE Z519 ZN
 BECKTON VEGAS 9433
 BECKTON BELGA A750 SN
 DENVER DYNASTY
 BECKY 1706
 1305
 DIRTY DANCER

Calv.Ease	BW	WW	YW	Milk	Tmat	CETM	HPG	Maint.En.	Stay
8	-2.0	28	51	10	24	1	8	+3.0	9
	Marb -.12			REA -.16			Bfat +.00		

Great personal ratios from Mushrush Dreaming P362. Overall great balance. 6+ gen OS clear [Pasture Exposure Ref. Sire P (5/22 - 6/26), Pasture Exposure Ref. Sire V (6/26 - 7/27)]

120 **BECKTON ROSE P016 LN**
1A 100% # 978342 Tattoo: BKT P016

Birth: 2-15-04
 BECKTON LANCER T7 M089 ← BECKTON LANCER F442 T
 ← BECKTON TAMARA G141 HE
 BECKTON ROSE M131 HR ← BECKTON HERALD HH E503
 ← BECKTON ROSE H253 CH
 BECKTON LANCER T A664
 BKT SUFFEINA A828 DM
 LCC HEAVEN OR BUST1000B
 BECKTON TAMARA C695 CL
 BECKTON HERALD H B463
 BECKTON SERENA B025 HV
 BECKTON CHAMP RK E121
 BECKTON ROSE Z519 ZN

Calv.Ease	BW	WW	YW	Milk	Tmat	CETM	HPG	Maint.En.	Stay
9	-1.7	33	63	17	34	3	7	+3.0	10
	Marb -.13			REA -.09			Bfat -.01		

Rose P016 has never produced anything but a calf in the top third of the herd at sale time, and her bull calves have sold accordingly, averaging well over \$3,000 selling price in our sales. She herself weighed 1155 pounds at weaning. She is pasture exposed to Beckton Nebula T269, Reference Sire N-8. Pedigree is 6+ generations OS clear.

123 **TJR 926 325 L56**
1A 100% # 787799 Tattoo: TJR L56

Birth: 3-17-01
 TJR MESILLA 926 ← BECKTON LANCER T A664
 ← TJR CE 325 G95
 TJR 9004 904 325 ← MRM 832 8203 9004
 ← TJR 2463 819 904
 BECKTON LANCER 9380
 BECKTON COCA 9119 TJ
 MRM SUPREME CE
 TJR 9004 904 325
 MRM SIOUX CHIEF 832
 MRM J4430 F1723 8203
 LCHMN MDLD HVYWT2463
 TJR 8016 8213 819

Calv.Ease	BW	WW	YW	Milk	Tmat	CETM	HPG	Maint.En.	Stay
7	-0.2	21	29	7	17	3	4	-13.0	9
	Marb +.05			REA -.40			Bfat -.01		

Herd changing genetics for maintenance energy. With a -13 ME EPD matched by only several animals in the entire breed. 6+ gen OS clear [Pasture Exposure Ref. Sire Q (5/27 - 6/3), Pasture Exposure Ref. Sire J (6/3 - 8/3)]

• Registered Females •



Mushrush Candice 8111
Lot 124

126 **BECKTON ENCINO H115 HD**
1A 100% # 623173 Tattoo: WF H115

Birth: 3-2-98
 BECKTON HADRIAN F C486
 BECKTON ENCINO E527 TO
 BECKTON JULIAN GN 9A45
 BKT MARTA 9A13 JL
 BECKTON FAIRFAX 8812
 BKT KURUBA 9588 JL
 BIEBER TOPPER 2476
 BJR LAKINA 002-0142
 BKT SENTINEL 8165
 BCH KIT 7132-784

Calv.Ease	BW	WW	YW	Milk	Tmat	CETM	HPG	Maint.En.	Stay
10	-1.0	24	37	13	25	4	14	+3.0	11
	Marb	+0.07		REA	+0.07		Bfat -0.02		

Fertility, productivity and longevity describe this proven 1170 pound cow from the top end of our herd. Her calves have averaged 101 at weaning time, and her MPPA is 101. She never misses, and five different years she calved in the first week of the calving season. She is pasture exposed to Beckton Hasten S462, Reference Sire H-1. Pedigree is 6+ generations OS clear.

124 **MUSHRUSH CANDICE 8111**
1A 100% # 649990 Tattoo: MUS 8111

Birth: 10-13-98
 BUF CRK CHF 824-1658
 MUS MISS ZENITH 5022
 RCN CANYON CHIEF 092
 BUF CREEK LOLA 628
 BFLO CR VC CHIEF 105
 BFLO CRK CARRIE 3391
 BECKTON ZENITH Z123
 MUS PRARIE MADAM 012
 PRARIE GOLD 723 MUS
 JIT 29 REL

Calv.Ease	BW	WW	YW	Milk	Tmat	CETM	HPG	Maint.En.	Stay
8	-0.4	22	42	16	27	1	12	+6.0	6
	Marb	+0.07		REA	-0.12		Bfat +0.01		

Here is your chance to add a Canyon x Zenith to your herd. Zenith is synonymous with thickness and capacity. tested OS free [Pasture Exposure Ref. Sire O (5/27 - 8/3)]

127 **MUSHRUSH LANA 8125**
1A 100% # 649957 Tattoo: MUS 8125

Birth: 10-25-98
 BECKTON LANCER F270 T
 MUS MISS CHIEFDOM 347
 BECKTON LANCER T A664
 BECKTON LANA A754 PC
 LEACHMAN CHIEFDOM 2X
 REL BURKE
 REL NATOMA

Calv.Ease	BW	WW	YW	Milk	Tmat	CETM	HPG	Maint.En.	Stay
10	-1.9	24	38	8	21	4	4	-9.0	8
	Marb	+0.04		REA	-0.17		Bfat -0.01		

Proven, solid low maintenance cow. 6+ gen OS clear [Pasture Exposure Ref. Sire O (5/27 - 8/3)]

125 **BECKTON BARMAID R124 CT**
1A 100% # 1041862 Tattoo: WF R124

Birth: 3-2-05
 BECKTON CLIFFTOP T3 N800
 BECKTON BARMAID N371 LN
 BKT CLIFFTOP TV G672
 BECKTON BIRDIE C353 VG
 BECKTON CODY K G701
 BECKTON LANA G514 CD
 BECKTON LANCER T A664
 BECKTON ANGEL G356 HR
 BECKTON HADRIAN F C486
 BECKTON BARMAID Z697 SU

Calv.Ease	BW	WW	YW	Milk	Tmat	CETM	HPG	Maint.En.	Stay
9	+0.2	32	64	17	33	3	9	+8.0	11
	Marb	+0.14		REA	+0.03		Bfat +0.00		

This young cow produced a knockout heifer calf last year, and has another nice one this year. So far she is 111 on her progeny weaning ratio and 114 yearling. She is pasture exposed this year to a new herd bull son of Nebula M045, Beckton Nebula T269, Reference Sire N-8. Pedigree is 6+ generations OS clear.

128 **MUS MISS LOGAN 8017**
1A 100% # 611256 Tattoo: MUS 8017

Birth: 2-6-98
 MUS PRAIRIE LOGAN 5066
 MUS MISS CENTER 6026
 GLACIER LOGAN 210
 BFLO CR VC CHIEF 105
 GLACIER REBALAS
 JIT B2283
 JIT 33 REL
 FCC RAMBO 502
 PANHANDLE LUCY 8028
 JIT B2283
 MUS 532 C

Calv.Ease	BW	WW	YW	Milk	Tmat	CETM	HPG	Maint.En.	Stay
6	-1.6	19	25	7	16	5	9	-5.0	8
	Marb	+0.17		REA	-0.07		Bfat +0.00		

Another good solid cow – another daughter of donor prospect Lot 3, Miss Center 6026. Longevity is built in. 6+ gen OS clear [Pasture Exposure Ref. Sire O (5/27 - 8/3)]

Mushrush Commercial Bred Heifers

The Mushrush commercial bred heifers are solid red with high enough percentage to be considered purebred Red Angus. We buy these heifers as calves from bull customers that have been using Mushrush and Beckton genetics for many generations. They are typical of our breeding program - moderate framed, easy fleshing cattle with lots of natural thickness and capacity. We bred over 400 of these this year and held back this elite group especially for this sale. All heifers have a negative BVD - PI test and were vaccinated three times prior to breeding with BoviShield Gold

FP+VL5™ which includes Vibrio and Lepto. All heifers were OCV for brucellosis. They were bred to calving ease Mushrush and Beckton bulls for a 65 day calving season starting February 15, 2010. We use a lot of bulls so typically the heifers are bred up in the front half of the season. At preg check the heifers were boosted with ViraShield 6™ and poured with Dectomax. Their calves will be eligible for the Red Angus Feeder Calf Certification Program. These heifers typically weigh right around 1000 pounds at preg check in October.

Lot 201 and following

We expect around 50 head, depending on preg check of these fancy heifers. They will be individually lotted starting at Lot 201. The high bidder takes as many as they want, one to all. We will repeat until all heifers are sold. If you will be bidding on DV Auction, please watch the bidding tutorial. It will help you to communicate the number you are buying.



Beckton Commercial Bred Heifers and Cows

These bred heifers and cows are from the Beckton program. They are all very high percentage Red Angus, solid red, bred and raised here at Beckton. Their calves will be eligible for the Red Angus Feeder Calf Certification Program. The heifers are bred to calve starting the second half of February, and the cows are bred to start calving early March. All have been pregnancy tested and examined for reproductive tract soundness by our veterinarian. All are bred to our own Beckton Red Angus sires.

They are very moderate in size and frame, with low maintenance energy requirements for which our program is well known. It is difficult to find moderate sized, productive females, and these are bred to be just that. Over the years these cows have proven to give both performance and value to our commercial female customers.

Lot 301

15 – Beckton 18 mo. Bred Heifers – high percentage Red Angus

Lot 302

15 – Beckton 2-3 year old Bred Cows – high percentage Red Angus

Lot 303

50 – Beckton young Bred Cows – average age 4 1/2 yrs. – high percentage Red Angus
(These will be sold gate cut, and the high bidder may take as many as he/she wants)



Beckton Program Bulls

Be ready to go out early with your bulls next year...

At Beckton we use primarily a natural service breeding program. Every year we add about 15 new yearling bulls from the top end of our breeding program, plus some back-ups. Which means every year we need to retire this many bulls. Because these sires turn over so quickly, many are quite young. We have put together 27 of these retired and back-up bulls. These are high performance bulls only 2 to 5 years of age.

They have only been used with our own cows. We are selling full possession of these bulls, and are retaining a ½ breeding interest only.

These bulls offer tremendous performance and value, and should have many good years of service remaining.



• Beckton Program Bulls •

401 **BKT CHEROKEE U269 N**
1A 100.0% # 1259459 Tattoo: BKT U269

Birth: 3-15-08
 BECKTON CHEROKEE N N479
 BECKTON FIREFLY N177 NP

Calv.Ease	BW	WW	YW	Milk	Tmat	HPG	Maint.En.	Stay
12	-3.4	31	61	16	32	10	-3.0	12
Marb +.03			REA +.24			Bfat +.00		
BWt	WWt	WR	ADG	YWt	YR	Scr.	Fr.	
74	597	103	3.54	1164	106	37	5.5	

★★★★★ for Low Maintenance, Growth, Rib-eye area, Calving Ease. Selling ½ Interest & Full Possession.

403 **BECKTON ROMAN U035 J**
1A 100.0% # 1259636 Tattoo: BKT U035

Birth: 2-21-08
 BECKTON ROMAN J S158
 BECKTON SIERRA S120 HW

Calv.Ease	BW	WW	YW	Milk	Tmat	HPG	Maint.En.	Stay
10	-0.7	38	72	19	38	9	-4.0	18
Marb -.04			REA +.27			Bfat +.00		
BWt	WWt	WR	ADG	YWt	YR	Scr.	Fr.	
73	600	109	3.29	1127	109	33	5.5	

★★★★★ for Low Maintenance, Growth, Rib-eye area, Calving Ease, Stayability. Selling ½ Interest & Full Possession.

402 **BECKTON EPIC U817 K4**
1A 100.0% # 1259074 Tattoo: WF U817

Birth: 4-19-08
 BECKTON EPIC K4 N795
 BECKTON INDIGO R842 NB

Calv.Ease	BW	WW	YW	Milk	Tmat	HPG	Maint.En.	Stay
13	-3.5	30	63	8	23	7	-6.0	16
Marb +.24			REA +.06			Bfat +.00		
BWt	WWt	WR	ADG	YWt	YR	Scr.	Fr.	
66	588	102	2.85	1044	95	33	5.0	

★★★★★ for Low Maintenance, Marbling, Calving Ease, Stayability. Selling ½ Interest & Full Possession.

404 **BECKTON EPIC U490 KD**
1A 100.0% # 1258836 Tattoo: WF U490

Birth: 3-23-08
 BECKTON EPIC R350 K
 BECKTON ANNIE F743 LN

Calv.Ease	BW	WW	YW	Milk	Tmat	HPG	Maint.En.	Stay
16	-6.6	19	35	13	23	7	-2.0	11
Marb +.04			REA +.02			Bfat +.00		
BWt	WWt	WR	ADG	YWt	YR	Scr.	Fr.	
56	528	89	2.95	1000	90	34	5.0	

★★★★★ for Low Maintenance, Calving Ease. Selling ½ Interest & Full Possession.



405 **BECKTON DOMINOR T035 Z1**
1A 100.0% # 1178330 Tattoo: BKT T035

Birth: 2-15-07
 BECKTON DOMINOR Z1 R610
 BECKTON ROSE R545 DM

Calv.Ease	BW	WW	YW	Milk	Tmat	HPG	Maint.En.	Stay
15	-5.0	23	60	21	32	8	-6.0	16
Marb +.09			REA +.30			Bfat +.01		
BWt	WWt	WR	ADG	YWt	YR	Scr.	Fr.	
60	584	103	3.34	1118	103	34	5.0	

★★★★★ for Low Maintenance, Rib-eye area, Calving Ease, Stayability. Selling ½ Interest & Full Possession.

• Beckton Program Bulls •

406 **BECKTON HERITAGE T234**
1A 100.0% # 1178744 Tattoo: BKT T234

Birth: 3-10-07
 BECKTON HERITAGE N013
 BECKTON ROSE F306 JL
 BECKTON JULIAN GG B571
 BECKTON LANA L007 JL
 BECKTON JULIAN G1 J526
 BECKTON LANA J790 EP
 BKT JULIAN 7526 G
 BKT MARTA 9A13 JL
 BKT JAVELIN 7466 R
 BECKTON ROSE 9776 BN
 BECKTON HUSTLER C2 L079
 BECKTON HUSTLER CN J102
 BECKTON BARMAID J012 CO

Calv.Ease	BW	WW	YW	Milk	Tmat	HPG	Maint.En.	Stay
20	-7.5	17	33	16	25	11	-4.0	18
Marb +.09		REA +.14			Bfat +.00			
BWt	WWt	WR	ADG	YWt	YR	Scr.	Fr.	
59	521	92	3.21	1035	89	35	5.0	

★★★★★ for Low Maintenance, Rib-eye area, Calving Ease, Stayability. Selling ½ Interest & Full Possession.

409 **BECKTON JUSTICE C1 R483**
1A 100.0% # 1042221 Tattoo: BKT R483

Birth: 3-24-05
 BECKTON JUSTICE CH M056
 BECKTON TAMARA J124 HR
 BECKTON JUSTICE C K449
 BECKTON RUTH K802 HD
 BECKTON HERALD F FA20
 BECKTON TAMARA F183 CT
 BECKTON JUSTICE G302
 BKT LARKABEL C742 CF
 BECKTON HADRIAN F C486
 BECKTON RUTH G534 NP
 LEACHMAN HEAVENLY 8141
 BECKTON BARONA C548 FF
 BECKTON CLIFFTOP T C075
 BECKTON TAMARA C264 SC

Calv.Ease	BW	WW	YW	Milk	Tmat	HPG	Maint.En.	Stay
14	-4.0	30	70	15	30	13	-1.0	12
Marb +.06		REA +.10			Bfat -.01			
BWt	WWt	WR	ADG	YWt	YR	Scr.	Fr.	
76	700	113	3.82	1312	118	41	6.0	

★★★★★ for Low Maintenance, Growth, Calving Ease. Selling ½ Interest & Full Possession.

407 **BECKTON JUSTICE S651**
1A 100.0% # 1119114 Tattoo: BKT S651

Birth: 3-29-06
 BECKTON JUSTICE G302
 BECKTON SIERRA N403 LN
 BECKTON JULIAN GG B571
 BKT VERNICE 9733 PC
 BECKTON LANCER TH K417
 BECKTON SIERRA J659 DM
 BKT JULIAN 7526 G
 BKT MARTA 9A13 JL
 BECKTON PACER 8940
 BKT VERNICE 8999 NV
 BECKTON LANCER T A664
 BECKTON ANGEL G356 HR
 BECKTON DOMINOR ZR G223
 BECKTON SIERRA G671 DM

Calv.Ease	BW	WW	YW	Milk	Tmat	HPG	Maint.En.	Stay
10	-0.3	37	73	12	31	12	+1.0	15
Marb +.11		REA +.33			Bfat +.00			
BWt	WWt	WR	ADG	YWt	YR	Scr.	Fr.	
81	663	115	3.77	1266	112	35	5.0	

★★★★★ for Low Maintenance, Growth, Marbling, Rib-eye area, Calving Ease, Stayability. Selling ½ Interest & Full Possession.



Beckton Nebula J R475
Lot 410

408 **BECKTON EPIC S369 K4**
1A 100.0% # 1118832 Tattoo: BKT S369

Birth: 3-14-06
 BECKTON EPIC K4 N795
 BECKTON ROSE N524 NM
 BECKTON EPIC KJ J722
 BECKTON SIERRA J789 EP
 BECKTON NOMAD 7496
 BECKTON ROSE F306 JL
 BECKTON EPIC K F075
 BECKTON LANA F891 JL
 BECKTON EPIC D404
 BECKTON SIERRA C157 CL
 BECKTON NEVA 5562
 BKT BOLT TAMRCK 3913
 BECKTON JULIAN GG B571
 BECKTON ROSE C320 JV

Calv.Ease	BW	WW	YW	Milk	Tmat	HPG	Maint.En.	Stay
14	-4.2	24	58	8	20	7	-6.0	14
Marb +.14		REA +.10			Bfat +.01			
BWt	WWt	WR	ADG	YWt	YR	Scr.	Fr.	
65	577	98	3.30	1106	102	34	4.5	

★★★★★ for Low Maintenance, Marbling, Calving Ease, Stayability. Selling ½ Interest & Full Possession.

410 **BECKTON NEBULA J R475**
1A 100.0% # 1042213 Tattoo: BKT R475

Birth: 3-23-05
 BECKTON NEBULA M045
 BECKTON LARKEISA M138 JC
 BECKTON NEPTUNE R2 K065
 BECKTON BELGA K285 JL
 BECKTON JUSTICE G302
 BKT LARKEISA G448 CT
 BECKTON NEPTUNE RR B284
 BECKTON LANA C735 TP
 BECKTON JULIAN GG B571
 BECKTON BELGA G493 HR
 BECKTON JULIAN GG B571
 BKT VERNICE 9733 PC
 BECKTON CLIFFTOP T C075
 BKT LARKEISA C894 JV

Calv.Ease	BW	WW	YW	Milk	Tmat	HPG	Maint.En.	Stay
18	-6.8	19	45	9	18	14	-9.0	18
Marb +.09		REA +.43			Bfat +.00			
BWt	WWt	WR	ADG	YWt	YR	Scr.	Fr.	
60	579	101	3.42	1126	102	36	5.0	

★★★★★ for Low Maintenance, Rib-eye area, Calving Ease, Stayability. Selling ½ Interest & Full Possession.

• Beckton Program Bulls •

411 **BECKTON NEBULA EN S347**
1A 100.0% # 1118810 Tattoo: WF S347

Birth: 3-13-06
 BECKTON NEBULA M045
BECKTON NEBULA E P084
 Ref. N-2
 BKT PINE MARIE M119 EP
 BECKTON NEPTUNE R2 K065
 BECKTON BELGA K285 JL
 BECKTON EPIC K F075
 BKT PINE MARIE D126 JL
 BECKTON NEPTUNE R2 K065
 BECKTON BELGA K285 JL
 BECKTON EPIC K1 K863
 BECKTON EOLA K178 EP

Calv.Ease	BW	WW	YW	Milk	Tmat	HPG	Maint.En.	Stay
19	-7.6	21	45	11	21	14	-8.0	19
Marb +.40		REA +.01		Bfat +.01				
BWt	WWt	WR	ADG	YWt	YR	Scr.	Fr.	
55	527	99	3.05	1015	99	NA	4.5	

★★★★★ for Low Maintenance, Marbling, Calving Ease, Stayability.
 Selling ½ Interest & Full Possession.



Beckton Nebula N R473
Lot 414

412 **BECKTON EPIC R350 K**
1A 100.0% # 1042088 Tattoo: BKT R350

Birth: 3-17-05
 BECKTON EPIC D404
BECKTON EPIC K F075
 BECKTON BELGA D483 KR
 BECKTON SAGA KJ B702
 BECKTON KURUBA B508 PC
 BECKTON KAISER FD 9253
 BECKTON BELGA A036 MB
 BECKTON CLIPPER JL A095
 BECKTON SCARLET A742 RB
 BECKTON CLIPPER J 9956
 BKT LARKABA 7596 PN

Calv.Ease	BW	WW	YW	Milk	Tmat	HPG	Maint.En.	Stay
11	-3.3	27	54	18	32	10	+2.0	9
Marb +.07		REA +.07		Bfat +.02				
BWt	WWt	WR	ADG	YWt	YR	Scr.	Fr.	
95	696	NA	3.65	1280	NA	38	6.5	

★★★★★ for Low Maintenance, Calving Ease. Selling ½ Interest & Full Possession.

414 **BECKTON NEBULA N R573**
1A 100.0% # 1042311 Tattoo: BKT R573

Birth: 3-29-05
 BECKTON NEPTUNE R2 K065
BECKTON NEBULA M045
 Ref. N-1
 BECKTON BELGA K285 JL
 BECKTON LANCER F442 T
BECKTON LANA M621 LN
 BECKTON LANA H329 HD
 BECKTON NEPTUNE RR B284
 BECKTON LANA C735 TP
 BECKTON JULIAN GG B571
 BECKTON BELGA G493 HR
 BECKTON LANCER T A664
 BKT SUFFEINA A828 DM
 BECKTON HADRIAN FH E143
 BECKTON LANA D288 VG

Calv.Ease	BW	WW	YW	Milk	Tmat	HPG	Maint.En.	Stay
14	-3.9	29	57	10	24	12	-5.0	17
Marb +.13		REA +.07		Bfat -.01				
BWt	WWt	WR	ADG	YWt	YR	Scr.	Fr.	
66	593	104	3.63	1174	109	37	5.0	

★★★★★ for Low Maintenance, Marbling, Calving Ease, Stayability.
 Selling ½ Interest & Full Possession.

413 **BECKTON CODY K2 R168**
1A 100.0% # 1041906 Tattoo: WF R168

Birth: 3-6-05
 BECKTON CODY K G701
BECKTON CODY KH M390
 BECKTON TAMARA J124 HR
 BECKTON VEGAS SV H078
BECKTON TAMARA K249 VG
 BECKTON TAMARA HA38 WR
 BECKTON CODY C401
 BECKTON CHRISTY B007 KR
 BECKTON HERALD F FA20
 BECKTON TAMARA F183 CT
 BECKTON VEGAS S F382
 BECKTON LARKABA F252 VG
 BECKTON WARRIOR CC E292
 BECKTON TAMARA Z909 SN

Calv.Ease	BW	WW	YW	Milk	Tmat	HPG	Maint.En.	Stay
14	-4.3	31	75	21	37	12	+5.0	11
Marb -.05		REA +.09		Bfat +.01				
BWt	WWt	WR	ADG	YWt	YR	Scr.	Fr.	
76	745	113	3.38	1285	111	39	6.0	

★★★★★ for Growth, Calving Ease. Selling ½ Interest & Full Possession.

415 **BECKTON NEBULA E P084**
1A 100.0% # 978410 Tattoo: BKT P084

Birth: 2-27-04
 BECKTON NEPTUNE R2 K065
BECKTON NEBULA M045
 Ref. N-1
 BECKTON BELGA K285 JL
 BECKTON EPIC K F075
BKT PINE MARIE M119 EP
 BKT PINE MARIE D126 JL
 BECKTON NEPTUNE RR B284
 BECKTON LANA C735 TP
 BECKTON JULIAN GG B571
 BECKTON BELGA G493 HR
 BECKTON EPIC D404
 BECKTON BELGA D483 KR
 BECKTON JULIAN GG B571
 BKT PINE MARIE B849 JL

Calv.Ease	BW	WW	YW	Milk	Tmat	HPG	Maint.En.	Stay
20	-8.7	16	43	12	19	14	-7.0	19
Marb +.27		REA +.06		Bfat +.01				
BWt	WWt	WR	ADG	YWt	YR	Scr.	Fr.	
54	546	100	2.90	1010	100	33	4.5	

★★★★★ for Low Maintenance, Marbling, Calving Ease, Stayability.
 Selling ½ Interest & Full Possession.

• Beckton Program Bulls •

416 **BECKTON JULIAN U099 G5**
1A 100.0% # 1259082 Tattoo: WF U099

Birth: 3-2-08
 BECKTON JULIAN GJ P535 < BKT JULIAN 7526 G
 BECKTON JULIAN G5 S107 < BECKTON MONA D086 JL
 Ref. J-4 < BECKTON DOMINOR ZC M919
 < BECKTON MINOLA M641 WR
 < BECKTON LASSO P741 < BECKTON LANCER T1 H080
 BECKTON SIERRA S065 LO < BECKTON RUTH G534 NP
 < BECKTON LANCER T6 M467
 < BECKTON SIERRA M258 LN

Calv.Ease	BW	WW	YW	Milk	Tmat	HPG	Maint.En.	Stay
7	+1.1	39	82	16	35	10	+1.0	16
Marb +.20		REA +.14		Bfat +.00				
BWt	WWt	WR	ADG	YWt	YR	Scr.	Fr.	
81	658	119	3.34	1193	116	35	5.5	

★★★★★ for Low Maintenance, Growth, Marbling, Rib-eye area, Calving Ease, Stayability. **Selling ½ Interest & Full Possession.**



*Sue and Forest Dunning
Tongue River Red Angus, 307.750.2454*

417 **BECKTON CODY U672 K1**
1A 100.0% # 1259429 Tattoo: BKT U672

Birth: 4-2-08
 BECKTON CODY KH M390 < BECKTON CODY K G701
 BECKTON CODY K1 P014 < BECKTON TAMARA J124 HR
 < BECKTON WARRIOR T C371
 < BECKTON ROSE M126 WR < BECKTON ROSE D741 LN
 < BECKTON CHAMP RH F275
 BECKTON SUSAN M144 CH < BECKTON LANA F138 LN
 < RDD B TOPPER 1675
 < BECKTON SUSAN 9785 VK

Calv.Ease	BW	WW	YW	Milk	Tmat	HPG	Maint.En.	Stay
13	-4.2	22	48	20	31	7	+3.0	12
Marb +.07		REA +.15		Bfat -.01				
BWt	WWt	WR	ADG	YWt	YR	Scr.	Fr.	
72	611	104	3.05	1099	100	34	5.0	

★★★★★ for Low Maintenance, Rib-eye area, Calving Ease. **Selling ½ Interest & Full Possession.**

419 **BECKTON LANCER T748 T9**
1A 100.0% # 1179040 Tattoo: BKT T748

Birth: 4-13-07
 BECKTON LANCER TA K644 < BECKTON LANCER T A664
 BECKTON LANCER T9 N586 < BECKTON TAMARA B570 JL
 < BECKTON SCAMP TR FB22
 < BKT LARKEISA H232 SC < BKT LARKEISA F828 JL
 < BECKTON LANCER T A664
 BECKTON TAMARA H068 LN < BECKTON KIT C041 NP
 < BECKTON LANCER T A664
 < BECKTON TAMARA F809 LN < BECKTON TAMARA A939 JL

Calv.Ease	BW	WW	YW	Milk	Tmat	HPG	Maint.En.	Stay
12	-1.1	21	43	11	21	8	-1.0	15
Marb +.14		REA +.09		Bfat -.01				
BWt	WWt	WR	ADG	YWt	YR	Scr.	Fr.	
89	503	NA	3.33	1036	92	33	5.5	

★★★★★ for Low Maintenance, Marbling, Calving Ease, Stayability. **Selling ½ Interest & Full Possession.**

418 **BECKTON JULIAN T612 GG**
1A 100.0% # 1178904 Tattoo: WF T612

Birth: 3-28-07
 BKT JULIAN 7526 G < BECKTON JULIAN 6592
 BECKTON JULIAN GG B571 < BKT BELGA 6746 GS
 Ref. J-1 < BKT JULIAN 7526 G
 < BKT MARTA 6498 XM
 < BECKTON DOMINOR 9455 < BKT DORADO 8411 V
 < BKT FIREFLY 8734 DR
 BKT SUFFEINA A828 DM < BECKTON TITAN 7965
 < BKT SUFFEINA 9493 TT < BCH RCH CLAUDIA 2140

Calv.Ease	BW	WW	YW	Milk	Tmat	HPG	Maint.En.	Stay
14	-2.9	25	51	12	25	11	-3.0	18
Marb +.13		REA +.28		Bfat +.00				
BWt	WWt	WR	ADG	YWt	YR	Scr.	Fr.	
82	529	NA	3.35	1066	NA	34	5.5	

★★★★★ for Low Maintenance, Marbling, Rib-eye area, Calving Ease, Stayability. **Selling ½ Interest & Full Possession.**

420 **BECKTON CODY S634 KH**
1A 100.0% # 1119097 Tattoo: WF S634

Birth: 3-28-06
 BECKTON CODY K G701 < BECKTON CODY C401
 BECKTON CODY KH M390 < BECKTON CHRISTY B007 KR
 < BECKTON HERALD F FA20
 < BECKTON TAMARA J124 HR < BECKTON TAMARA F183 CT
 < BECKTON HUSTLER C G407 < LCC HEAVEN OR BUST1000B
 < BECKTON ROSE E032 CL
 BECKTON DINAH K287 HU < BECKTON CLIFFTOP T C075
 < BECKTON DINAH G334 CT < BECKTON DINAH C440 NM

Calv.Ease	BW	WW	YW	Milk	Tmat	HPG	Maint.En.	Stay
15	-4.7	24	54	18	30	9	.0	10
Marb +.04		REA +.11		Bfat +.00				
BWt	WWt	WR	ADG	YWt	YR	Scr.	Fr.	
70	599	102	3.41	1145	101	37	5.0	

★★★★★ for Low Maintenance, Calving Ease. **Selling ½ Interest & Full Possession.**

• Beckton Program Bulls •

421 **TR JULIAN RT561**
1A 100.0% # 1045656 Tattoo: TR2A RT561

Birth: 2-20-05
 BECKTON JULIAN GG B571 < BKT JULIAN 7526 G
 BKT MARTA 9A13 JL
TR JULIAN LT151
 MS GEOMETRIC 917 < BJR YO 121
 MS GEOMETRIC
 BUF CRK DYNAMICS 3820 < RCN DYNAMO 732
 BUF CRK PRIMROSE 3150
TR DYNA HT824
 BUF CRK DYNA 3082 < BUF CRK HOBO 1961
 BUF CRK DYNA 1777

Calv.Ease	BW	WW	YW	Milk	Tmat	HPG	Maint.En.	Stay
15	-4.0	21	47	12	22	12	+4.0	14
Marb +.14		REA +.07		Bfat -.01				
BWt	WWt	WR	ADG	YWt	YR	Scr.	Fr.	
78	664	103	3.75	1265	109	35	6.9	

★★★★★ for Low Maintenance, Marbling, Calving Ease, Stayability. Selling ½ Interest & Full Possession.

423 **BECKTON NEBULA R787**
1A 100.0% # 1042525 Tattoo: BKT R787

Birth: 4-18-05
 BECKTON NEPTUNE R2 K065 < BECKTON NEPTUNE RR B284
 BECKTON LANA C735 TP
BECKTON NEBULA M045
 Ref. N-1 < BECKTON BELGA K285 JL
 BECKTON JULIAN GG B571
 BECKTON BELGA G493 HR
 BECKTON SCAMP T A825 < BECKTON SCAMP 8954
 BKT ENCINO 8459 TJ
BECKTON LARKABA D388 SC
 BECKTON LARKABA A833 JL < BECKTON JULIAN 8970 S
 BKT LARKABA 9613 VC

Calv.Ease	BW	WW	YW	Milk	Tmat	HPG	Maint.En.	Stay
18	-7.2	14	44	12	19	14	-8.0	14
Marb +.05		REA +.05		Bfat +.01				
BWt	WWt	WR	ADG	YWt	YR	Scr.	Fr.	
56	637	101	3.58	1209	104	37	5.5	

★★★★★ for Low Maintenance, Calving Ease, Stayability. Selling ½ Interest & Full Possession.

422 **BKT CLIFFTOP TP R288**
1A 100.0% # 1042026 Tattoo: WF R288

Birth: 3-14-05
 BJR TOPPER 5241 < BIEBER TOPPER 2476
 BJR LAKINA 002-0142
BECKTON CLIFFTOP T C075
 BECKTON BARMAID A761 TR < BECKTON TARTAN 8148
 BKT BARMAID 8925 KR
 BECKTON COPPER JT G095 < BECKTON COPPER J E616
 BECKTON RUTH E549 TP
BECKTON CHRISTY K209 CO
 BECKTON CHRISTY A111 VQ < BECKTON VANQUISH 9977
 BKT CHRISTY 9A01 CL

Calv.Ease	BW	WW	YW	Milk	Tmat	HPG	Maint.En.	Stay
14	-5.5	14	40	17	24	7	-3.0	14
Marb +.01		REA +.28		Bfat +.00				
BWt	WWt	WR	ADG	YWt	YR	Scr.	Fr.	
73	594	103	3.55	1163	105	38	5.0	

★★★★★ for Low Maintenance, Rib-eye area, Calving Ease, Stayability. Selling ½ Interest & Full Possession.

424 **BECKTON VEGA P079**
1A 100.0% # 978405 Tattoo: BKT P079

Birth: 2-26-04
 BECKTON VEGAS SV H078 < BECKTON VEGAS S F382
 BECKTON LARKABA F252 VG
BECKTON VEGAS S1 K316
 BECKTON EOLA H073 EP < BECKTON EPIC K F075
 BECKTON EOLA F467 CD
 BECKTON JULIAN GG B571 < BKT JULIAN 7526 G
 BKT MARTA 9A13 JL
BECKTON LYDIA H159 JL
 BECKTON LYDIA D386 CL < BECKTON CLIPPER K Z420
 BKT LYDIA 9B78 VK

Calv.Ease	BW	WW	YW	Milk	Tmat	HPG	Maint.En.	Stay
13	-2.4	24	49	15	27	10	+6.0	14
Marb -.05		REA +.25		Bfat +.00				
BWt	WWt	WR	ADG	YWt	YR	Scr.	Fr.	
73	603	97	3.35	1139	103	35	5.0	

★★★★★ for Rib-eye area, Calving Ease, Stayability. Selling ½ Interest & Full Possession.



Beckton Clifftop TP R288
Lot 422

425 **BSF JET U716 L**
1B 99.7% # 1259287 Tattoo: BSF U716

Birth: 4-5-08
 TR JULIAN LT151 < BECKTON JULIAN GG B571
 MS GEOMETRIC 917
BECKTON JET L P491
 BECKTON MINERVA L278 LN < BECKTON LANCER TS D390
 BECKTON MINERVA F495 CH
 BECKTON NEBULA M045 < BECKTON NEPTUNE R2 K065
 BECKTON BELGA K285 JL
BSF NEBULANN R664 NB
 BSF REGUS M043 JC < BECKTON JUSTICE C K449
 BSF REGUS K341 JC

Calv.Ease	BW	WW	YW	Milk	Tmat	HPG	Maint.En.	Stay
18	-6.3	25	52	15	28	14	+1.0	18
Marb +.14		REA +.19		Bfat +.00				
BWt	WWt	WR	ADG	YWt	YR	Scr.	Fr.	
62	609	105	2.99	1087	101	35	5.0	

★★★★★ for Low Maintenance, Marbling, Rib-eye area, Calving Ease, Stayability. Selling ½ Interest & Full Possession.

Sale Terms and Conditions

Except for those stated in the terms and conditions below, there are no warranties, either expressed or implied, as to the merchantability or fitness for a particular purpose with respect to the cattle being sold at this auction. The warranties and guarantees set forth in the "Terms and Conditions" are in lieu of all other warranties, either expressed or implied, and the remedies provided therein shall be the sole and exclusive remedy for the Buyer, or any party claiming through Buyer, for any breach of warranty

I. BIDDING

The Auctioneer in charge will settle any disputes as to bids, and his decision on such matters shall be final.

II. TERMS

Terms of sale are cash or personal check unless satisfactory credit arrangements have been made with vendor prior to sale.

III. PURCHASER'S RISK

Each animal becomes the risk of the purchaser as soon as sold, but it shall be the obligation of the Seller to see that animals are fed and cared for free of charge to purchaser, until loaded for shipment or until the expiration of 48 hours after the sale, whichever occurs sooner.

IV. DELIVERY

For any animals for which seller's arrange delivery, the following terms shall apply. Each animal becomes the risk of the purchaser as soon as sold, and through the time of delivery. The seller will arrange transportation and delivery schedules, and may combine animals from one or more purchasers for convenience and to reduce costs. If delivery is arranged, seller assumes no other liability. Once the purchaser has been notified of the date and approximate time of delivery (morning, afternoon, evening, etc.), it is the responsibility of the purchaser to arrange adequate and agreeable location and facilities for unloading each animal. When unloaded at the agreed upon location, all care and management of the animal is the responsibility of the purchaser.

V. CERTIFICATE OF REGISTRY

A transferred certificate of registry will be furnished to the purchaser for each animal sold as 'Registered'.

VI. HEALTH

All animals are eligible for interstate shipment, except as otherwise announced. Interstate health papers will be furnished for each animal requiring T.B. and Bang's tests in accordance with Federal Regulations.

VII. A.I. NON-OWNER BULL PERMITS

A.I./Non-owner Bull Permits shall be furnished by the Seller, at no cost to the Buyer, for all females bred artificially or naturally to bulls not owned by the Seller.

VIII. ANNOUNCEMENTS

Any changes from information of any kind in this catalog will be announced from the auction box and such announcements shall take precedence.

IX. BREEDING GUARANTEE

Any female that has had a calf prior to the date of sale shall be considered a breeder without further guarantee. All females sold as 'bred' or 'pregnant' have been pregnancy checked by a licensed veterinarian and are guaranteed bred on the day of sale. The purchaser may elect to have any female so listed rechecked at their cost within 30 days of delivery by a licensed veterinarian of their choice. Any such female determined

or guarantee therein provided, and all other obligations or liabilities.

The information in the catalog is believed to be accurate, and the information seller believes to be most representative. It is the nature of seller's business that the seller engages in a continual process of collecting new data and information. Therefore, any information presented at the time of sale is always subject to revision, correction or update.

open by this recheck may be returned to the seller for a full refund. Due to conditions out of seller's control, once a female leaves seller's possession, this is the only guarantee offered.

All bulls are sold as guaranteed breeders. Each bull has been officially fertility tested as "Satisfactory Breeder" prior to the sale. However, seller cannot guarantee against physical injury or illness following the sale. But if within 8 months following the sale, the buyer has evidence that the animal is not a breeder, the buyer may obtain a statement signed by a licensed veterinarian to that effect, such statement also indicating that there has been no injury or illness to the animal following the sale, and return the bull to the farm of the seller for adjustment. If the seller cannot then prove the animal to be a breeder, an adjustment will be made by the seller, either by substituting an animal of equal value, or by the refund of the full purchase price. Such adjustment shall be considered full settlement and satisfaction of all claims. No guarantees apply to animals which are shown following the sale.

X. GENETIC DEFECT AND PARENTAGE GUARANTEE

For complete rules and regulations in regard to genetic defects or parentage guarantee contact the RAAA. Ask for Section C Registration Requirements. At time of sale all animals sold as 'Registered' have been tested OS Free, or have pedigrees that have been verified to have no RAAA listed carriers of OS for six complete generations.

XI. RETAINED INTEREST AND SEMEN RIGHTS:

Buyer receives full possession and salvage value of all bulls in the sale, unless stated otherwise in the catalog or during the auction. On animals designated in the catalog or from the auction block, Seller is retaining an undivided 1/2 interest or other interest as stated. Designation of interest may occur on an animal's individual listing, or in an introduction preceding a group of animals. We reserve the right to collect and market semen on these bulls. Collection would be during the off season, at the buyer's convenience, and at seller's expense. The buyer has the option of obtaining semen at the same time, at cost, provided we are notified ahead of collection. If the buyer collects the bull, we would like to be notified so we may obtain semen if wanted.

On all other bulls in the Sale, except those so designated, the buyer has full possession, and shall have the sole privilege to determine if the bull is to have semen collected at any time in the future. On such bulls which are collected in the future, and from which semen is advertised or marketed commercially, seller retains a 1/3 royalty interest on gross sales price for any semen which is sold; however, any decision to collect or sell semen is solely the right of the buyer.

XII. RIGHTS AND OBLIGATIONS

A. The above terms and conditions of sale shall constitute a contract between the Buyer and Seller of each animal and shall be equally binding upon both. Each sale or resale of an animal constitutes a separate transaction.

B. Neither the sale manager, the owner, nor any other person connected with the management of the sale, assumes any liability, legal or otherwise.

• **Mushrush Reference Sires** •

A MUSHRUSH JULIAN 1005
1A 100% # 787285 Tattoo: MUS 1005

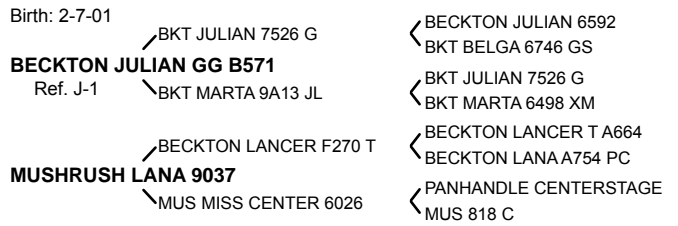

Calv.Ease	BW	WW	YW	Milk	HPG	Maint.En.	Stay
16	-4.5	26	53	9	14	-8.0	15
(.64)	(.76)	(.72)	(.71)	(.65)	(.52)	(.49)	(.25)
Marb -0.5		REA -0.7		Bfat +0.1			
(.50)	(.50)	(.50)	(.50)	(.50)	(.50)	(.50)	(.50)
BWt	WWt	WR	ADG	YWt	YR	Scr.	Fr.
68	661	110	3	1177	105		5.0

Before the rest of the breed had discovered Lancers and Julian's, we were using them diligently and 1005 is a Lancer X Julian out of the top producing 9037 cow (Lot 1) that we are reluctantly selling at the fall cow sale as lot xx. 1005 was moderate thick and muscled with calving ease, low maintenance and carcass to boot. 6+ gen OS clear.

B BECKTON NEBULA U127 G
1A 100% # 1259091 Tattoo: WF U127

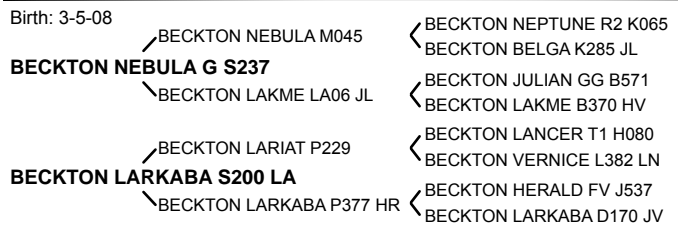

Calv.Ease	BW	WW	YW	Milk	HPG	Maint.En.	Stay
14	-2.9	26	63	11	10	-3.0	16
(.13)	(.33)	(.23)	(.24)	(.13)	()	()	()
Marb +1.0		REA +0.5		Bfat +0.1			
(.25)	(.24)	(.24)	(.24)	(.24)	(.24)	(.24)	(.24)
BWt	WWt	WR	ADG	YWt	YR	Scr.	Fr.
66	581	105	4	1169	113	36	5.5

A young herd sire that will have his first calf crop this spring, U127 represents our program well. Tested OS free.

C RED HILL B571 JULIAN 77S
1A 100% # 1147704 Tattoo: 1BWJ 77S

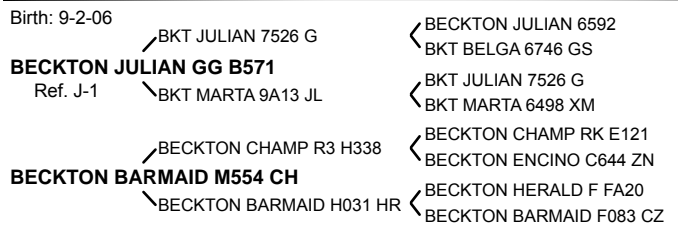

Calv.Ease	BW	WW	YW	Milk	HPG	Maint.En.	Stay
17	-4.7	28	60	21	13	-4.0	18
(.25)	(.26)	(.26)	(.26)	(.25)	(.22)	(.18)	(.21)
Marb +0.1		REA +1.8		Bfat +0.1			
(.25)	(.26)	(.26)	(.26)	(.25)	(.22)	(.18)	(.21)
BWt	WWt	WR	ADG	YWt	YR	Scr.	Fr.
80	603	NA	2	967	NA		4.5

When we lost our B571 son ref. sire I to injury, we replaced him with Red Hill Julian 77S. He represents everything we do here at Mushrush Red Angus with his calving ease, easy fleshing, maternal traits and his low maintenance. Semen available. Tested OS free.

D BECKTON JULIAN U485 GJ
1A 100% # 1258893 Tattoo: WF U485

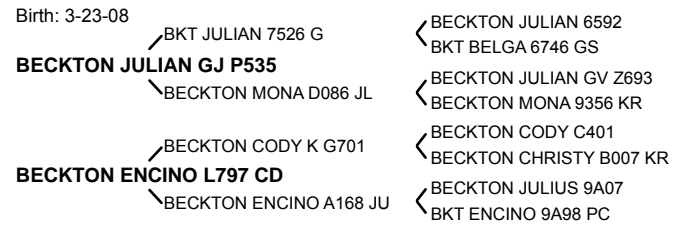

Calv.Ease	BW	WW	YW	Milk	HPG	Maint.En.	Stay
13	-3.6	29	54	8	9	-3.0	17
(.19)	(.36)	(.27)	(.29)	(.20)	(.14)	(.12)	()
Marb +0.4		REA +0.2		Bfat +0.1			
(.28)	(.27)	(.27)	(.27)	(.27)	(.27)	(.27)	(.27)
BWt	WWt	WR	ADG	YWt	YR	Scr.	Fr.
82	655	113	3	1169	107	41	5.5

U485 was used natural service on some of the heifers available in the sale. His pedigree is very similar to our great herd sire LT 142 ref. sire G. Tested OS free.

E RED HILL B571 JULIAN 84S
1A 100% # 1147702 Tattoo: 1BWJ 84S

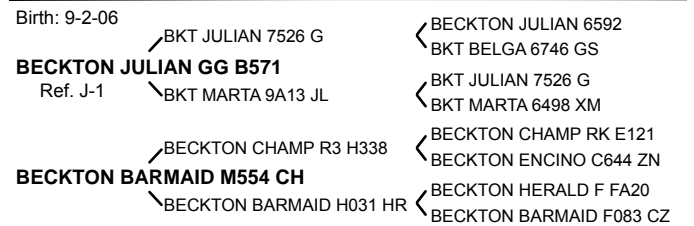

Calv.Ease	BW	WW	YW	Milk	HPG	Maint.En.	Stay
18	-5.1	27	59	21	13	-4.0	18
(.34)	(.42)	(.41)	(.39)	(.35)	(.22)	(.18)	(.21)
Marb +0.1		REA +1.8		Bfat +0.1			
(.25)	(.26)	(.26)	(.26)	(.25)	(.22)	(.18)	(.21)
BWt	WWt	WR	ADG	YWt	YR	Scr.	Fr.
80	517	NA	3	992	NA		4.0

A full brother to our Ref. Sire C, 84S now resides at Buffalo Creek Red Angus, Wv. Tested OS free.



Red Hill Julian 77S

• Mushrush Reference Sires •

F **BECKTON JULIAN G1 J526**

1A 100% # 678010 Tattoo: WF J526

Birth: 3-25-99

↙ BKT JULIAN 7526 G
BECKTON JULIAN GG B571
 Ref. J-1
 ↘ BKT MARTA 9A13 JL

 ↙ BECKTON JULIAN 6592
 BKT BELGA 6746 GS
 ↘ BKT JULIAN 7526 G
 BKT MARTA 6498 XM

↙ BECKTON LANCER T A664
BECKTON ANNIE F743 LN
 ↘ BECKTON ANNIE C132 NP

 ↙ BECKTON LANCER 9380
 BECKTON COCA 9119 TJ
 ↘ BECKTON NEPTUNE RZ A447
 BECKTON ANNIE A019 MW

Calv.Ease	BW	WW	YW	Milk	HPG	Maint.En.	Stay
18	-5.3	36	59	8	4	-4.0	15
(.80)	(.87)	(.84)	(.83)	(.80)	(.60)	(.59)	(.41)
Marb -.01 (.58)		REA +.05 (.54)		Bfat +.00 (.39)			
BWt	WWt	WR	ADG	YWt	YR	Scr.	Fr.
73	581	112	3	1056	100	34	5.0

We sampled this B571 son A.I. His first calves will arrive the spring of 2010. 6+ gen OS clear.

I **MUSHRUSH JULIAN N202**

1A 100% # 946413 Tattoo: MUS N202

Birth: 8-31-03

↙ BKT JULIAN 7526 G
BECKTON JULIAN GG B571
 Ref. J-1
 ↘ BKT MARTA 9A13 JL

 ↙ BECKTON JULIAN 6592
 BKT BELGA 6746 GS
 ↘ BKT JULIAN 7526 G
 BKT MARTA 6498 XM

↙ BUF CRK CHF 824-1658
MUSHRUSH LANA 1181
 ↘ MUSHRUSH LANA 9126

 ↙ BUF CRK CHIEF092-824
 BFLO CRK CARIE VC473
 ↘ BECKTON LANCER F270 T
 MUS PRAIRIE MADAM 5017

Calv.Ease	BW	WW	YW	Milk	HPG	Maint.En.	Stay
18	-4.9	20	57	16	13	-6.0	17
(.47)	(.75)	(.66)	(.64)	(.44)	(.44)	(.26)	(.21)
Marb +.17 (.51)		REA -.07 (.48)		Bfat +.01 (.32)			
BWt	WWt	WR	ADG	YWt	YR	Scr.	Fr.
64	567	104	3	1122	104		4.5

Highly efficient and easy fleshing, N202 ranks within the top 5% of the breed for CED, BW, ME, HPG, and Stayability. A true heifer bull, he has recorded 100 progeny averaging only 65# at birth. Both parents tested OS free.

G **TR JULIAN LT142**

1A 100% # 785183 Tattoo: TR2A LT142

Birth: 2-21-01

↙ BKT JULIAN 7526 G
BECKTON JULIAN GG B571
 Ref. J-1
 ↘ BKT MARTA 9A13 JL

 ↙ BECKTON JULIAN 6592
 BKT BELGA 6746 GS
 ↘ BKT JULIAN 7526 G
 BKT MARTA 6498 XM

↙ BECKTON CODY V E023
TR LANA G760
 ↘ BECKTON LANA E828 SC

 ↙ BECKTON CODY C401
 BECKTON BIRDIE C353 VG
 ↘ BECKTON SCAMP 8954
 BECKTON LANA B695 SG

Calv.Ease	BW	WW	YW	Milk	HPG	Maint.En.	Stay
22	-5.9	31	59	16	20	-5.0	16
(.78)	(.87)	(.84)	(.83)	(.78)	(.65)	(.56)	(.30)
Marb +.06 (.58)		REA +.04 (.57)		Bfat -.01 (.41)			
BWt	WWt	WR	ADG	YWt	YR	Scr.	Fr.
76	782	113	3	1215	112	36	5.0

Stacked with proven genetics, TR Julian LT142 continues to perform as a lead herd sire and is flawless from birth to rail. His daughters are getting lots of attention from all over the United States. With lots of proof he showcases our program, calving ease, all the growth you'll ever need while maintaining low ME and carcass. Tested OS free.



Mushrush Epic N223

H **MUSHRUSH JULIAN N153**

1A 100% # 912049 Tattoo: MUR N153

Birth: 4-28-03

↙ BKT JULIAN 7526 G
TJR 7526 922 L38
 ↘ TJR A664 713 922

 ↙ BECKTON JULIAN 6592
 BKT BELGA 6746 GS
 ↘ BECKTON LANCER T A664
 TJR 9004 265 713

↙ BECKTON LANCER T A664
TJR A664 836 K10
 ↘ TJR UTE 816 836

 ↙ BECKTON LANCER 9380
 BECKTON COCA 9119 TJ
 ↘ MRM UTE
 TJR L218 8608 816

Calv.Ease	BW	WW	YW	Milk	HPG	Maint.En.	Stay
5	+2.6	38	69	10	11	-2.0	14
(.51)	(.75)	(.68)	(.66)	(.51)	(.42)	(.36)	()
Marb +.16 (.46)		REA +.08 (.44)		Bfat -.01 (.26)			
BWt	WWt	WR	ADG	YWt	YR	Scr.	Fr.
75	647	119	4	1216	115		5.5

Linebred Lancer A664 and out of a 7526 Julian son, Mushrush Julian N153 has always passed growth and performance on to his progeny. 6+ gen OS clear.

J **MUSHRUSH EPIC N223**

1A 100% # 946434 Tattoo: DANS N223

Birth: 9-15-03

↙ BECKTON EPIC D404
BECKTON EPIC K F075
 ↘ BECKTON BELGA D483 KR

 ↙ BECKTON SAGA KJ B702
 BECKTON KURUBA B508 PC
 ↘ BECKTON KAISER FD 9253
 BECKTON BELGA A036 MB

↙ DALLAS 2347
ROSEBUD 3574
 ↘ AMY 3096

 ↙ ROY'S BETTER HEAVY 1413
 ROY ADVANCE C08
 ↘ HEAVY DUTY TOO 141
 YOLANDO 2303

Calv.Ease	BW	WW	YW	Milk	HPG	Maint.En.	Stay
9	-1.9	33	58	24	12	+1.0	9
(.47)	(.76)	(.68)	(.66)	(.47)	(.45)	(.34)	(.17)
Marb +.14 (.47)		REA -.10 (.43)		Bfat +.01 (.24)			
BWt	WWt	WR	ADG	YWt	YR	Scr.	Fr.
76	598	113	3	1087	105		4.5

Very thick and moderate, if you see N223 you will understand why we like him so much. Even with all that thickness he is very easy calving. He is a very slick haired bull. Tested OS free.

• **Mushrush Reference Sires** •

K MUSHRUSH ROCKET P016
1A 100% # 975127 Tattoo: MUS P016

Birth: 2-24-04
 BECKTON JULIAN GG B571 < BKT JULIAN 7526 G
TR JULIAN LT142 < BKT MARTA 9A13 JL
 Ref. G < BECKTON CODY V E023
 TR LANA G760 < BECKTON LANA E828 SC
 BECKTON LANCER F270 T < BECKTON LANCER T A664
MUSHRUSH LANA 9037 < BECKTON LANA A754 PC
 MUS MISS CENTER 6026 < PANHANDLE CENTERSTAGE
 MUS 818 C

Calv.Ease	BW	WW	YW	Milk	HPG	Maint.En.	Stay
14	-3.2	37	69	14	15	-3.0	14
(.35)	(.59)	(.50)	(.48)	(.32)	(.21)	(.17)	(.11)
	Marb -.10	(.42)	REA -.05	(.39)	Bfat -.01	(.26)	
BWt	WWt	WR	ADG	YWt	YR	Scr.	Fr.
72	569	108	4	1192	112		5.0

You will see the dam (Lot 1) to this bull in other herdsires at Mushrush Red Angus. Rocket combines her excellent performance 108 MPPA with LT 142, a sire who has done so much to improve the Red Angus breed and Mushrush Red Angus. 6+ gen OS clear.



Buffalo Creek Lancer R017

L MUSHRUSH OSAGE LN P017
1A 100% # 975079 Tattoo: MUS P017

Birth: 2-25-04
 BFCK CHEROKEE CNYN 4912 < BUF CRK CHF 824-1658
LJC CHEROKEE M03 < MRM 1431 8611 9109
 BUCKEYE MOLLIE < DMW HEAVEN F63
 BUCKEYE SOPHIA
 BUF CRK JULIAN 5138 < BKT JULIAN 7526 G
MUSHRUSH LANA 1061 < BUF CRK PNMARIE 1781
 MUS MISS LANCER 5025 < BECKTON LANCER F270 T
 MUS GOLDEN GIRL 5025

Calv.Ease	BW	WW	YW	Milk	HPG	Maint.En.	Stay
12	-4.8	22	51	17	1	+11.0	14
(.30)	(.64)	(.54)	(.51)	(.29)	(.32)	(.15)	()
	Marb -.09	(.42)	REA +.11	(.39)	Bfat -.02	(.23)	
BWt	WWt	WR	ADG	YWt	YR	Scr.	Fr.
71	581	102	3	1127	114		5.5

P017 brought excellent calving ease to the herd but had to be retired after only two breeding seasons. 6+ gen OS clear.

N BUF CRK LANCER R017
1A 100% # 1050008 Tattoo: BUF R017

Birth: 4-18-05
 BECKTON LANCER T A664 < BECKTON LANCER 9380
BECKTON LANCER F442 T < BECKTON COCA 9119 TJ
 Ref. L-1 < BKT SUFFEINA A828 DM < BECKTON DOMINOR 9455
 BKT SUFFEINA 9493 TT
 BECKTON JULIAN GG B571 < BKT JULIAN 7526 G
BUF CRK JULIET N036 < BKT MARTA 9A13 JL
 BUF CRK PRIMROSE 5679 < BUF CRK CHF 824-1658
 BUF CRK PRIMROSE 3150

Calv.Ease	BW	WW	YW	Milk	HPG	Maint.En.	Stay
10	-0.4	38	79	13	7	-1.0	18
(.33)	(.67)	(.57)	(.55)	(.30)	(.13)	()	(.17)
	Marb +.26	(.49)	REA +.24	(.46)	Bfat -.01	(.34)	
BWt	WWt	WR	ADG	YWt	YR	Scr.	Fr.
90	721	NA	3	1233	NA	41	5.0

Our pick from the Fall 2006 Buffalo Creek Red Angus sale. Tremendous thickness in the hindquarter on a moderate frame, R017 stamps his progeny with thickness and eye appeal. Semen Available. Tested OS free.

M BROWN-CBAR AFFIRMED P7081
1A 100% # 1003224 Tattoo: RABS P7081

Birth: 3-9-04
 BUF CRK CHF 824-1658 < BUF CRK CHIEF092-824
BFCK CHEROKEE CNYN 4912 < BFLO CRK CARIE VC473
 MRM 1431 8611 9109 < BUF CRK CHEROKEE1431
 MRM 8454 8219 8611
 GLACIER LOGAN 210 < BFLO CR VC CHIEF 105
BROWN MS ABIGRACE L7730 < GLACIER REBALAS
 LCHMN ABIGAIL E1013 < LMAN ROBIN HOOD 1174B
 LCHMN ABIGAIL C1037

Calv.Ease	BW	WW	YW	Milk	HPG	Maint.En.	Stay
4	-0.4	46	80	22	7	+9.0	10
(.35)	(.77)	(.66)	(.64)	(.32)	(.37)	(.16)	(.21)
	Marb +.24	(.52)	REA +.45	(.48)	Bfat +.00	(.31)	
BWt	WWt	WR	ADG	YWt	YR	Scr.	Fr.
84	734	NA	3	1158	NA	37	6.0

Sired by Cherokee Canyon and out of the famed Abigrace cow, Affirmed is the easiest fleshing, heaviest muscled sire ever to walk our pastures. Top 5% for both marbling and REA. Semen Available. Tested OS free.



Brown-Cbar Affirmed P708

• **Mushrush Reference Sires** •

O MUSHRUSH MIMI VG R205
1A 100% # 1084978 Tattoo: MUS R205

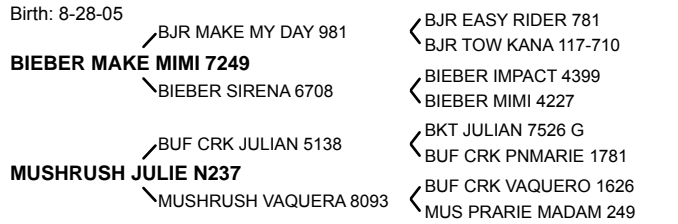

Calv.Ease	BW	WW	YW	Milk	HPG	Maint.En.	Stay
8	-0.6	42	76	22	5	+1.0	10
(.28)	(.61)	(.51)	(.49)	(.28)	(.22)	(.15)	(.14)
Marb +0.06 (.43)		REA +0.28 (.40)		Bfat -0.01 (.25)			
BWt	WWt	WR	ADG	YWt	YR	Scr.	Fr.
74	574	115	3	1057	109		6.0

A little different pedigree, R205 is doing everything well. Ratioing 103 on weaned calves to date. Every cow bred to him tested OS free. OSC.

Q MUSHRUSH EPICM115 LN S035
1A 100% # 1115187 Tattoo: MUS S035

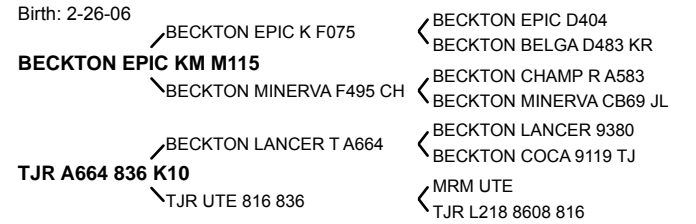

Calv.Ease	BW	WW	YW	Milk	HPG	Maint.En.	Stay
5	+1.8	39	79	17	8	+4.0	12
(.21)	(.37)	(.28)	(.30)	(.23)	(.17)	(.16)	()
Marb +0.17 (.30)		REA -0.01 (.29)		Bfat +0.00 (.23)			
BWt	WWt	WR	ADG	YWt	YR	Scr.	Fr.
90	547	109	4	1125	115		6.0

Mushrush EpicM115 is a very high performing bull and is visually so correct and easy fleshing. 6+ gen OS clear.

P MUSHRUSH EPIC R244
1A 100% # 1085017 Tattoo: MUS R244

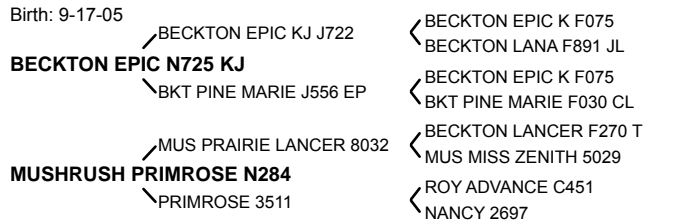

Calv.Ease	BW	WW	YW	Milk	HPG	Maint.En.	Stay
7	-1.1	34	66	16	11	+7.0	13
(.27)	(.45)	(.39)	(.36)	(.28)	()	(.11)	()
Marb +0.16 (.28)		REA +0.19 (.27)		Bfat +0.00 (.20)			
BWt	WWt	WR	ADG	YWt	YR	Scr.	Fr.
65	543	109	3	1048	109		5.5

R244 is a grandson to the great Epic F075. Dark red in color, he maintains his flesh well and has continued to bring all the traits we value to our program. Some of the cows will be NS to R244. 6+ gen OS clear.



Mushrush Epic R244

R MUSHRUSH WARRIOR MD S207
1A 100% # 1152302 Tattoo: MUS S207

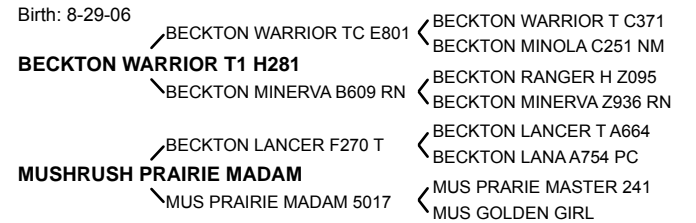

Calv.Ease	BW	WW	YW	Milk	HPG	Maint.En.	Stay
10	-1.4	28	63	10	13	+4.0	6
(.21)	(.37)	(.28)	(.30)	(.23)	(.17)	(.16)	(.12)
Marb +0.00 (.30)		REA -0.11 (.28)		Bfat -0.01 (.22)			
BWt	WWt	WR	ADG	YWt	YR	Scr.	Fr.
72	585	103	3	996	105		6.0

This direct H281 son has so much natural thickness. His first calves are just hitting the weaning pen now. His dam was an old matron that had a 104 MPPA. He will be on display along with many of the reference sires listed for Mushrush Red Angus. Tested OS free.

S MUSHRUSH ROCKET CA T038
1A 100% # 1186794 Tattoo: MUS T038

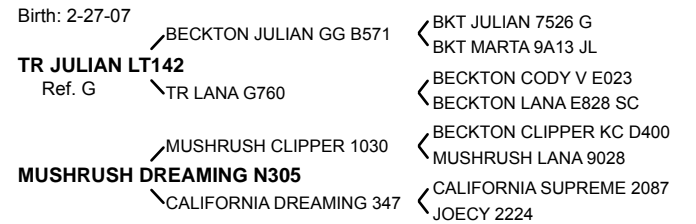

Calv.Ease	BW	WW	YW	Milk	HPG	Maint.En.	Stay
13	-2.6	35	76	18	15	+4.0	16
(.20)	(.36)	(.27)	(.29)	(.22)	(.12)	(.14)	()
Marb +0.03 (.30)		REA +0.19 (.30)		Bfat +0.01 (.24)			
BWt	WWt	WR	ADG	YWt	YR	Scr.	Fr.
76	688	115	3	1212	118		5.0

Another exciting new herd sire with his first calves just hitting the weaning pens this fall. We have high hopes this sire will be a fertility expert. Tested OS free.

• **Mushrush Reference Sires** •

T MUSHRUSH QUANTUM OS T068
1A 100% # 1186818 Tattoo: MUS T068

Birth: 3-12-07
 BFCK CHEROKEE CNYN 4912 < BUF CRK CHF 824-1658
 MRM 1431 8611 9109
BROWN-CBAR AFFIRMED P7081
 Ref. M < BROWN MS ABIGRACE L7730 < GLACIER LOGAN 210
 LCHMN ABIGAIL E1013
 LJC CHEROKEE M03 < BFCK CHEROKEE CNYN 4912
MUSHRUSH UMPIRE OS P143
 MRM 9004 903 L04 < BUCKEYE MOLLIE
 MRM 832 8203 9004
 WOR 9409 110 903

Calv.Ease	BW	WW	YW	Milk	HPG	Maint.En.	Stay
1	+1.4	45	88	20	8	+6.0	11
(.15)	(.36)	(.26)	(.28)	(.16)	(.15)	()	()
Marb +1.0 (.29)		REA +4.3 (.28)		Bfat -.01 (.23)			
BWt	WWt	WR	ADG	YWt	YR	Scr.	Fr.
84	655	111	3	1206	116		5.5

We always like to have a sire around for growth and muscle and this young new sire is one to watch. Top 1% Yearling weight and Ribeye. His first calves will be available in 2010. Tested OS free.



Mushrush Quantum T068

V MUSHRUSH JULIANLT ZN U005
1A 100% # 1245965 Tattoo: MUS U005

Birth: 2-8-08
 BECKTON JULIAN GG B571 < BKT JULIAN 7526 G
 BKT MARTA 9A13 JL
TR JULIAN LT142
 Ref. G < TR LANA G760 < BECKTON CODY V E023
 BECKTON LANA E828 SC
 LJC CHEROKEE M03 < BFCK CHEROKEE CNYN 4912
MUSHRUSH ZENA OS S023
 MUSHRUSH ZENA 0165 < BUCKEYE MOLLIE
 BECKTON LANCER F270 T
 MUS PRAIRIE MADAM 5041

Calv.Ease	BW	WW	YW	Milk	HPG	Maint.En.	Stay
14	-2.4	34	65	16	12	+5.0	16
(.20)	(.36)	(.27)	(.29)	(.21)	(.12)	(.13)	()
Marb +1.7 (.30)		REA +0.7 (.30)		Bfat -.01 (.25)			
BWt	WWt	WR	ADG	YWt	YR	Scr.	Fr.
74	595	101	3	1057	107		4.5

Mushrush Julian LT U005 was used natural service on a group of young cows. He represents our program so well with adequate growth while maintaining excellent calving ease and low maintenance. 6+ gen OS clear.

W MUSHRUSH NEBULA CA U055
1A 100% # 1245825 Tattoo: MUS U055

Birth: 2-26-08
 BECKTON NEPTUNE R2 K065 < BECKTON NEPTUNE RR B284
 BECKTON LANA C735 TP
BECKTON NEBULA M045
 Ref. N-1 < BECKTON BELGA K285 JL < BECKTON JULIAN GG B571
 BECKTON BELGA G493 HR
 CALIFORNIA SUPREME 2087 < DENVER DYNASTY
CALIFORNIA DREAMING 347
 JOECY 2224 < BECKY 1706
 1305
 DIRTY DANCER

Calv.Ease	BW	WW	YW	Milk	HPG	Maint.En.	Stay
9	-1.6	35	72	12	14	.0	14
(.21)	(.37)	(.28)	(.30)	(.23)	(.18)	(.16)	()
Marb -.05 (.29)		REA +2.3 (.28)		Bfat +0.00 (.21)			
BWt	WWt	WR	ADG	YWt	YR	Scr.	Fr.
88	686	111	3	1128	112		5.0

We admired this M045 son from weaning until he was put into the herd sire pen. He bred his group and came back in great flesh. He will be on display at the fall sale along with many of the other herd sires here at Mushrush Red Angus. Tested OS free.



Beckton Cody T085 K2

U BECKTON CODY T085 K2
1A 100% # 1178380 Tattoo: BKT T085

Birth: 2-22-07
 BECKTON CODY KH M390 < BECKTON CODY K G701
 BECKTON TAMARA J124 HR
BECKTON CODY K2 R168
 Ref. C-1 < BECKTON TAMARA K249 VG < BECKTON VEGAS SV H078
 BECKTON TAMARA HA38 WR
 BECKTON DOMINOR ZC M919 < BECKTON DOMINOR Z E401
 BECKTON BARMAID J012 CO
BKT LARKEISA R676 DM
 BKT LARKEISA M816 EP < BECKTON EPIC KJ J722
 BKT LARKEISA J076 DM

Calv.Ease	BW	WW	YW	Milk	HPG	Maint.En.	Stay
11	-2.5	29	69	21	12	-3.0	13
(.13)	(.34)	(.25)	(.26)	(.14)	()	()	()
Marb +1.2 (.26)		REA +0.3 (.25)		Bfat +0.1 (.19)			
BWt	WWt	WR	ADG	YWt	YR	Scr.	Fr.
68	594	105	4	1168	108		

Our pick of the 2008 Beckton sale. An outcross for our Julians and Lancers, T085's EPD's represent everything we strive for in our program. His first calves are just hitting the ground and are averaging under 70#. Semen is available. Tested OS free.

• Beckton Reference Sires •

B-1 **BKT CLIFFTOP TP R288**
1-A 100% # 1042026 Tattoo: WF5 R288

Birth: 3-14-05
 BJR Topper 5241
BECKTON CLIFFTOP T C075
 Beckton Barmaid A761 TR
 Bieber Topper 2476
 BJR Lakina 002-0142
 Beckton Tartan 8148
 Bkt Barmaid 8925 KR
 Beckton Copper J E616
 Beckton Ruth E549 TP
BECKTON CHRISTY K209 CO
 Beckton Copper JT G095
 Beckton Christy A111 VQ
 Beckton Vanquish 9977
 Bkt Christy 9A01 CL

Calv.Ease	BW	WW	YW	Milk	HPG	Maint.En.	Stay
14	-5.5	14	40	17	7	-3.1	14
(.31)	(.71)	(.60)	(.58)	(.29)	(.12)	(.16)	(.20)
Marb +0.1		REA +0.28		Bfat +0.0			
	(.44)		(.40)				(.25)
BWt	WWt	WR	ADG	YWt	YR	Scr.	Fr.
73	594	107	4	1163	107	38	5.0

★★★★★ for Low Maintenance, Gainability, Rib-eye area, Calving Ease, Stayability.



Beckton Cliff Top TP R288

B-2 **BECKTON CHEROKEE T450 N**
1-A 100% # 1178497 Tattoo: WF7 T450

Birth: 3-19-07
 BFCK Cherokee Cnyn 4912
BECKTON CHEROKEE N N479
 Beckton Dinah C440 NM
 BUF CRK Chief 824-1658
 MRM 1431 8611 9109
 Beckton Nomad K 9949
 Beckton Dinah Z610 JL
 Beckton Lancer TL G626
BECKTON ANNIE M337 LN
 Beckton Annie F743 LN
 Beckton Lancer T A664
 Beckton Fayette C110 LN
 Beckton Lancer T A664
 Beckton Annie C132 NP

Calv.Ease	BW	WW	YW	Milk	HPG	Maint.En.	Stay
15	-4.9	28	58	15	7	-5.1	15
(.19)	(.36)	(.27)	(.29)	(.21)	(.16)	(.14)	(.01)
Marb +0.07		REA +0.19		Bfat +0.0			
	(.30)		(.29)				(.24)
BWt	WWt	WR	ADG	YWt	YR	Scr.	Fr.
73	589	98	4	1211	108	38	6.0

★★★★★ for Low Maintenance, Gainability, Rib-eye area, Calving Ease, Stayability.

C-1 **BECKTON CODY K2 R168**
1-A 100% # 1041906 Tattoo: WF5 R168

Birth: 3-6-05
 Beckton Cody K G701
BECKTON CODY KH M390
 Beckton Tamara J124 HR
 Beckton Cody C401
 Beckton Christy B007 KR
 Beckton Herald F FA20
 Beckton Tamara F183 CT
 Beckton Vegas SV H078
BECKTON TAMARA K249 VG
 Beckton Tamara HA38 WR
 Beckton Vegas S F382
 Beckton Larkaba F252 VG
 Beckton Warrior CC E292
 Beckton Tamara Z909 SN

Calv.Ease	BW	WW	YW	Milk	HPG	Maint.En.	Stay
14	-4.3	31	75	21	12	+5.1	11
(.29)	(.65)	(.56)	(.53)	(.28)	(.30)	(.14)	(.01)
Marb -0.05		REA +0.09		Bfat +0.01			
	(.40)		(.36)				(.21)
BWt	WWt	WR	ADG	YWt	YR	Scr.	Fr.
76	745	116	4	1285	112	39	6.0

★★★★★ for Gainability, Calving Ease.

B-3 **BKT CLIFFTOP U575 TP**
1-A 100% # 1258956 Tattoo: WF8 U575

Birth: 3-26-08
 Beckton Clifftop T C075
BKT CLIFFTOP TP R288
 Ref. B-1
 Beckton Christy K209 CO
 Beckton Herald FJ J776
BECKTON LARKABEL N769 HR
 Bkt Larkabel F246 CT
 BJR Topper 5241
 Beckton Barmaid A761 TR
 Beckton Copper JT G095
 Beckton Christy A111 VQ
 Beckton Herald F FA20
 Bkt Larkeisa D095 JL
 Beckton Clifftop T C075
 Bkt Larkabel B012 CB

Calv.Ease	BW	WW	YW	Milk	HPG	Maint.En.	Stay
14	-5.2	21	49	16	9	-4.3	16
(.14)	(.35)	(.26)	(.27)	(.16)	(.01)	(.01)	(.01)
Marb +0.0		REA +0.20		Bfat +0.0			
	(.28)		(.27)				(.21)
BWt	WWt	WR	ADG	YWt	YR	Scr.	Fr.
64	582	100	4	1126	103	35	4.5

★★★★★ for Low Maintenance, Gainability, Rib-eye area, Calving Ease, Stayability.

C-2 **BECKTON CODY U777 K1**
1-A 100% # 1259524 Tattoo: BKT8 U777

Birth: 4-13-08
 Beckton Cody KH M390
BECKTON CODY K1 P014
 Beckton Rose M126 WR
 Beckton Cody K G701
 Beckton Tamara J124 HR
 Beckton Warrior T C371
 Beckton Rose D741 LN
 Beckton Cherokee N N479
BECKTON SUSAN R022 CQ
 Beckton Susan N023 JE
 BFCK Cherokee Cnyn 4912
 Beckton Dinah C440 NM
 Beckton Jules L429
 Beckton Susan L258 LR

Calv.Ease	BW	WW	YW	Milk	HPG	Maint.En.	Stay
14	-4.5	29	63	21	8	+1.6	14
(.16)	(.35)	(.25)	(.27)	(.17)	(.01)	(.10)	(.01)
Marb +0.0		REA +0.11		Bfat +0.0			
	(.01)		(.01)				(.01)
BWt	WWt	WR	ADG	YWt	YR	Scr.	Fr.
66	666	117	5	1209	112	38	5.0

★★★★★ for Low Maintenance, Gainability, Calving Ease, Stayability.

• Beckton Reference Sires •

E-1 **BECKTON EPIC K4 N795**
1-A 100% # 916917 Tattoo: WF3 N795

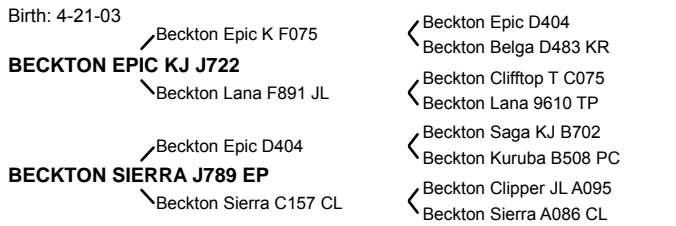

Calv.Ease	BW	WW	YW	Milk	HPG	Maint.En.	Stay
8	-0.8	34	87	9	3	-0.3	11
(.63)	(.79)	(.74)	(.72)	(.63)	(.40)	(.44)	(.15)
Marb +0.27 (.48)		REA +0.16 (.44)		Bfat +0.01 (.26)			
BWt	WWt	WR	ADG	YWt	YR	Scr.	Fr.
85	619	106	4	1191	112	36	6.5

★★★★★ for Low Maintenance, Gainability, Marbling, Rib-eye area, Calving Ease.

E-3 **BECKTON EPIC K6 S569**
1-A 100% # 1119032 Tattoo: WF6 S569

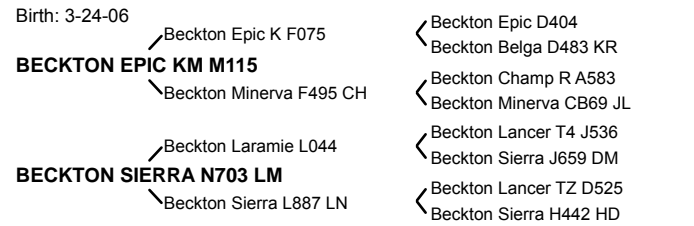

Calv.Ease	BW	WW	YW	Milk	HPG	Maint.En.	Stay
10	-2.0	40	87	21	8	+1.5	14
(.31)	(.61)	(.51)	(.49)	(.30)	(.16)	(.15)	(.01)
Marb +0.14 (.40)		REA +0.07 (.36)		Bfat +0.01 (.22)			
BWt	WWt	WR	ADG	YWt	YR	Scr.	Fr.
78	698	117	5	1342	119	37	6.0

★★★★★ for Low Maintenance, Gainability, Marbling, Calving Ease, Stayability.



Beckton Epic K4 N795

E-4 **BECKTON EPIC T330 K4**
1-A 100% # 1178840 Tattoo: BKT7 T330

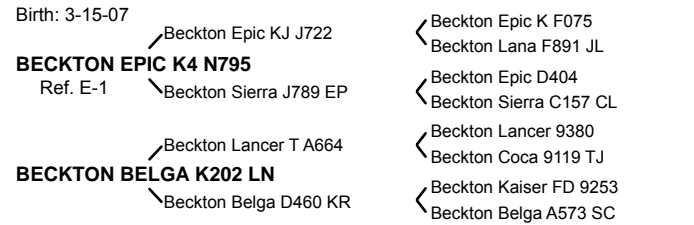

Calv.Ease	BW	WW	YW	Milk	HPG	Maint.En.	Stay
16	-5.1	23	67	9	5	-2.3	14
(.21)	(.37)	(.29)	(.30)	(.23)	(.17)	(.16)	(.01)
Marb +0.15 (.29)		REA +0.08 (.28)		Bfat +0.01 (.23)			
BWt	WWt	WR	ADG	YWt	YR	Scr.	Fr.
65	554	100	4	1183	108	35	5.5

★★★★★ for Low Maintenance, Gainability, Marbling, Calving Ease, Stayability.

E-2 **BECKTON EPIC R350 K**
1-A 100% # 1042088 Tattoo: BKT5 R350

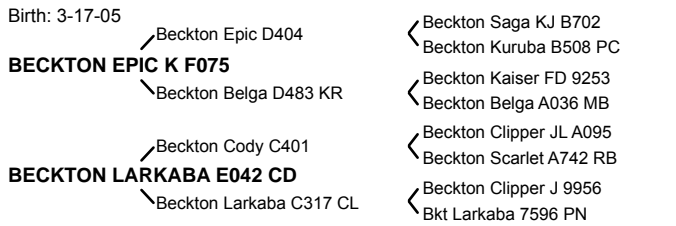

Calv.Ease	BW	WW	YW	Milk	HPG	Maint.En.	Stay
11	-3.7	25	54	17	11	+1.0	11
(.23)	(.26)	(.25)	(.25)	(.25)	(.19)	(.18)	(.17)
Marb +0.14 (.01)		REA +0.09 (.01)		Bfat +0.01 (.01)			
BWt	WWt	WR	ADG	YWt	YR	Scr.	Fr.
95	696	108	4	1280	112	38	6.5

★★★★★ for Low Maintenance, Gainability, Marbling, Calving Ease.

E-5 **BECKTON EPIC T524 K4**
1-A 100% # 1178571 Tattoo: BKT7 T524

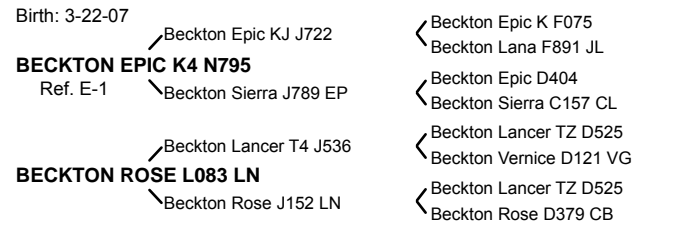

Calv.Ease	BW	WW	YW	Milk	HPG	Maint.En.	Stay
11	-1.8	32	67	10	3	-3.1	15
(.20)	(.37)	(.28)	(.30)	(.22)	(.15)	(.15)	(.01)
Marb +0.21 (.28)		REA +0.10 (.27)		Bfat +0.00 (.21)			
BWt	WWt	WR	ADG	YWt	YR	Scr.	Fr.
77	626	104	4	1124	100	37	5.5

★★★★★ for Low Maintenance, Gainability, Marbling, Calving Ease, Stayability.

• Beckton Reference Sires •

E-6 BECKTON EMPEROR T641
1-A 100% # 1178933 Tattoo: BKT7 T641

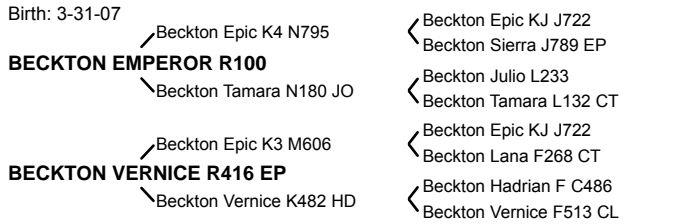

Calv.Ease	BW	WW	YW	Milk	HPG	Maint.En.	Stay
11	-2.6	27	60	15	7	+0.7	15
(.13)	(.34)	(.24)	(.25)	(.14)	(.01)	(.01)	(.01)
Marb +1.2 (.26)		REA +2.3 (.25)		Bfat +0.00 (.20)			
BWt	WWt	WR	ADG	YWt	YR	Scr.	Fr.
69	611	110	4	1173	110	34	5.5

★★★★★ for Low Maintenance, Gainability, Marbling, Rib-eye area, Calving Ease, Stayability.

H-2 BECKTON HERITAGE T270
1-A 100% # 1178780 Tattoo: WF7 T270

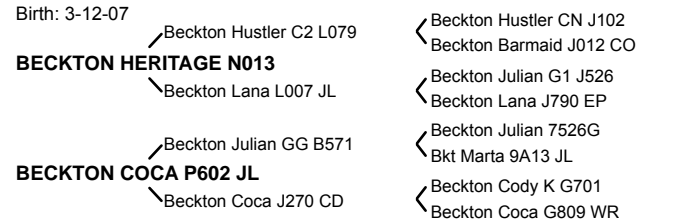

Calv.Ease	BW	WW	YW	Milk	HPG	Maint.En.	Stay
16	-4.5	32	59	17	10	-0.1	19
(.19)	(.36)	(.27)	(.29)	(.20)	(.01)	(.11)	(.01)
Marb +1.7 (.30)		REA +1.9 (.29)		Bfat +0.00 (.24)			
BWt	WWt	WR	ADG	YWt	YR	Scr.	Fr.
70	662	113	4	1186	107	38	5.5

★★★★★ for Low Maintenance, Gainability, Marbling, Rib-eye area, Calving Ease, Stayability.

E-7 BECKTON EPIC U749 K4
1-A 100% # 1259558 Tattoo: BKT8 U749

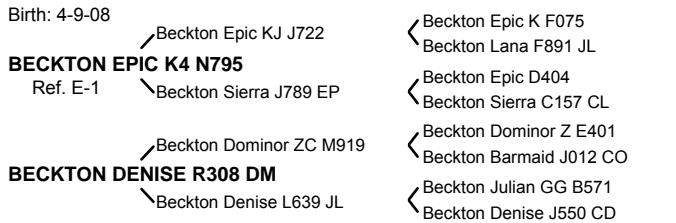

Calv.Ease	BW	WW	YW	Milk	HPG	Maint.En.	Stay
10	-0.7	34	84	13	8	+0.4	17
(.19)	(.36)	(.27)	(.29)	(.20)	(.01)	(.12)	(.01)
Marb +2.3 (.01)		REA +1.4 (.01)		Bfat +0.01 (.01)			
BWt	WWt	WR	ADG	YWt	YR	Scr.	Fr.
77	640	111	4	1201	112	34	5.5

★★★★★ for Low Maintenance, Gainability, Marbling, Rib-eye area, Calving Ease, Stayability.



Beckton Heritage T270

H-1 BECKTON HASTEN H S462
1-A 100% # 1118925 Tattoo: BKT6 S462

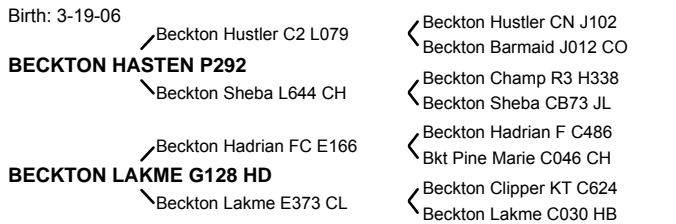

Calv.Ease	BW	WW	YW	Milk	HPG	Maint.En.	Stay
12	-4.2	32	59	20	10	+4.0	12
(.29)	(.56)	(.47)	(.44)	(.29)	(.14)	(.12)	(.10)
Marb -0.1 (.36)		REA +1.2 (.33)		Bfat -0.01 (.20)			
BWt	WWt	WR	ADG	YWt	YR	Scr.	Fr.
76	676	115	4	1200	108	36	5.5

★★★★★ for Low Maintenance, Gainability, Calving Ease.

H-3 BECKTON HASTEN U108 H
1-A 100% # 1259115 Tattoo: WF8 U108

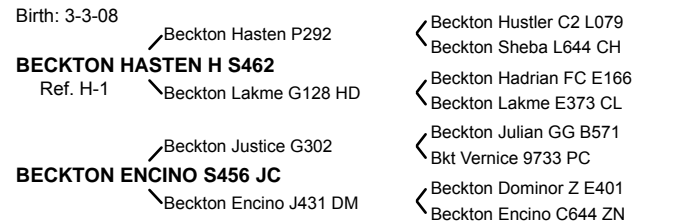

Calv.Ease	BW	WW	YW	Milk	HPG	Maint.En.	Stay
11	-2.5	34	66	15	12	-1.6	15
(.13)	(.33)	(.23)	(.25)	(.14)	(.01)	(.01)	(.01)
Marb +0.6 (.26)		REA +0.00 (.25)		Bfat +0.00 (.20)			
BWt	WWt	WR	ADG	YWt	YR	Scr.	Fr.
70	564	105	4	1120	110	34	5.5

★★★★★ for Low Maintenance, Gainability, Calving Ease, Stayability.

• Beckton Reference Sires •

J-1 BECKTON JULIAN GG B571
1-A 100% # 387580 Tattoo: WF2 B571

Birth: 3-27-92
 Beckton Julian 6592
BECKTON JULIAN 7526G
 Bkt Belga 6746 GS
 Beckton Trojan 5253
 Lchmn Christy 2339
 Beckton Gisa 4454
 Beckton Lalaxigu -2
 Beckton Julian 6592
 Bkt Belga 6746 GS
BKT MARTA 9A13 JL
 Beckton Julian 7526G
 Bkt Marta 6498 XM
 Beckton Xime 4736
 Beckton Marwa -K

Calv.Ease	BW	WW	YW	Milk	HPG	Maint.En.	Stay
19	-5.9	29	56	15	5	-7.0	24
(.90)	(.92)	(.91)	(.91)	(.90)	(.76)	(.62)	(.70)
Marb +1.0 (.72)		REA +4.8 (.69)		Bfat +0.2 (.58)			
BWt	WWt	WR	ADG	YWt	YR	Scr.	Fr.
65	627	113	3	1140	112	NA	5.0

★★★★★ for Low Maintenance, Gainability, Rib-eye area, Calving Ease, Stayability.



Beckton Julian GG B571

J-2 BECKTON JUSTICE C1 R483
1-A 100% # 1042221 Tattoo: BKT5 R483

Birth: 3-24-05
 Beckton Justice C K449
BECKTON JUSTICE CH M056
 Beckton Ruth K802 HD
 Beckton Herald F FA20
BECKTON TAMARA J124 HR
 Beckton Tamara F183 CT
 Beckton Justice G302
 Bkt Larkabel C742 CF
 Beckton Hadrian F C486
 Beckton Ruth G534 NP
 Leachman Heavenly 8141
 Beckton Barona C548 FF
 Beckton Clifftop T C075
 Beckton Tamara C264 SC

Calv.Ease	BW	WW	YW	Milk	HPG	Maint.En.	Stay
14	-4.0	30	70	15	13	-1.3	12
(.30)	(.66)	(.56)	(.53)	(.29)	(.16)	(.17)	(.01)
Marb +0.6 (.40)		REA +1.0 (.36)		Bfat -0.1 (.23)			
BWt	WWt	WR	ADG	YWt	YR	Scr.	Fr.
76	700	109	4	1312	115	41	6.0

★★★★★ for Low Maintenance, Gainability, Calving Ease.

J-4 BECKTON JULIAN G5 S107
1-A 100% # 1118570 Tattoo: WF6 S107

Birth: 2-21-06
 Beckton Julian 7526G
BECKTON JULIAN GJ P535
 Beckton Mona D086 JL
 Beckton Dominor ZC M919
BECKTON MINOLA P826 DM
 Beckton Minola M641 WR
 Beckton Julian 6592
 Bkt Belga 6746 GS
 Beckton Julian GV Z693
 Beckton Mona 9356 KR
 Beckton Dominor Z E401
 Beckton Barmaid J012 CO
 Beckton Warrior T C371
 Beckton Minola H170 JL

Calv.Ease	BW	WW	YW	Milk	HPG	Maint.En.	Stay
10	-0.9	30	72	12	11	+2.0	20
(.28)	(.58)	(.48)	(.45)	(.28)	(.01)	(.01)	(.01)
Marb +1.9 (.38)		REA +1.4 (.35)		Bfat +0.0 (.23)			
BWt	WWt	WR	ADG	YWt	YR	Scr.	Fr.
74	640	115	4	1237	113	43	4.5

★★★★★ for Low Maintenance, Gainability, Marbling, Rib-eye area, Calving Ease, Stayability.

J-3 TR JULIAN RT561
1-A 100% # 1045656 Tattoo: TR2A5 RT5

Birth: 2-20-05
 Beckton Julian GG B571
TR JULIAN LT151
 MS Geometric 917
 Buf Crk Dynamics 3820
TR DYNA HT824
 Buf Crk Dyna 3082
 Beckton Julian 7526G
 Bkt Marta 9A13 JL
 BJR Yo 121
 MS Geometric
 RCN Dynamo 732
 Buf Crk Primrose 3150
 Buf Crk Hobo 1961
 Buf Crk Dyna 1777

Calv.Ease	BW	WW	YW	Milk	HPG	Maint.En.	Stay
13	-3.8	29	60	12	7	+2.0	17
(.19)	(.36)	(.27)	(.27)	(.21)	(.16)	(.11)	(.01)
Marb +1.0 (.30)		REA +2.2 (.29)		Bfat -0.1 (.24)			
BWt	WWt	WR	ADG	YWt	YR	Scr.	Fr.
78	664	103	4	1265	109	35	6.5

★★★★★ for Low Maintenance, Gainability, Rib-eye area, Calving Ease, Stayability.

J-5 BECKTON ROMAN J S158
1-A 100% # 1118621 Tattoo: BKT6 S158

Birth: 2-27-06
 Buffalo Creek Romeo L081
TR ROMEO NT379
 Buf Crk Lass L420
 Beckton Julian GG B571
BECKTON BELGA K285 JL
 Beckton Belga G493 HR
 Beckton Julian GG B571
 Buf Crk Primrose 5679
 RCN Dynamo 732
 BUF CR ET LASS VC889
 Beckton Julian 7526G
 Bkt Marta 9A13 JL
 Beckton Herald K B244
 Beckton Belga D776 CL

Calv.Ease	BW	WW	YW	Milk	HPG	Maint.En.	Stay
11	-0.1	41	71	19	11	-0.1	18
(.31)	(.59)	(.50)	(.47)	(.30)	(.16)	(.16)	(.01)
Marb -0.1 (.38)		REA +4.6 (.36)		Bfat +0.1 (.25)			
BWt	WWt	WR	ADG	YWt	YR	Scr.	Fr.
79	660	113	4	1209	104	37	6.0

★★★★★ for Low Maintenance, Gainability, Rib-eye area, Calving Ease, Stayability.

• Beckton Reference Sires •

J-6 **BECKTON JULIAN U699 G1**
1-A 100% # 1259409 Tattoo: BKT8 U699

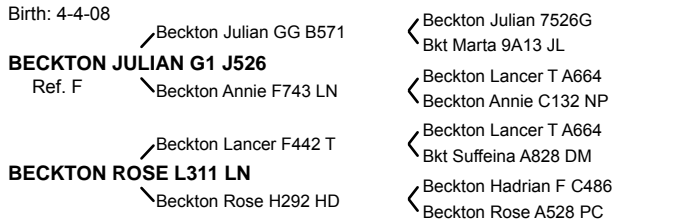

Calv.Ease	BW	WW	YW	Milk	HPG	Maint.En.	Stay
15	-3.8	36	64	10	7	-5.5	16
(.22)	(.37)	(.29)	(.31)	(.24)	(.19)	(.17)	(.15)
Marb +0.1 (.31)		REA +0.20 (.30)		Bfat -0.1 (.26)			
BWt	WWt	WR	ADG	YWt	YR	Scr.	Fr.
74	676	110	4	1170	106	39	5.0

★★★★★ for Low Maintenance, Gainability, Rib-eye area, Calving Ease, Stayability.

L-2 **BECKTON LOKI CL S284**
1-A 100% # 1118747 Tattoo: BKT6 S284

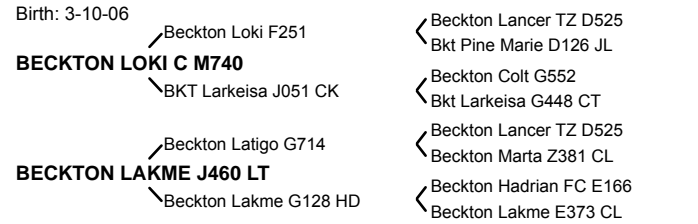

Calv.Ease	BW	WW	YW	Milk	HPG	Maint.En.	Stay
12	-3.1	31	65	17	7	+3.7	15
(.31)	(.58)	(.50)	(.47)	(.31)	(.16)	(.17)	(.12)
Marb +0.08 (.36)		REA +0.05 (.33)		Bfat +0.00 (.21)			
BWt	WWt	WR	ADG	YWt	YR	Scr.	Fr.
82	640	109	4	1198	103	39	6.0

★★★★★ for Low Maintenance, Gainability, Calving Ease, Stayability.

J-7 **BECKTON JULIAN U742 G3**
1-A 100% # 1258900 Tattoo: WF8 U742

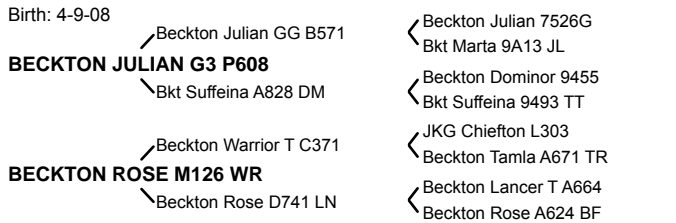

Calv.Ease	BW	WW	YW	Milk	HPG	Maint.En.	Stay
17	-5.2	20	60	15	9	-1.5	18
(.20)	(.37)	(.28)	(.30)	(.21)	(.16)	(.14)	(.01)
Marb +0.10 (.01)		REA +0.09 (.01)		Bfat -0.1 (.01)			
BWt	WWt	WR	ADG	YWt	YR	Scr.	Fr.
67	640	104	5	1235	111	34	5.0

★★★★★ for Low Maintenance, Gainability, Calving Ease, Stayability.

L-3 **BECKTON LANCER T371 TD**
1-A 100% # 1178419 Tattoo: BKT7 T371

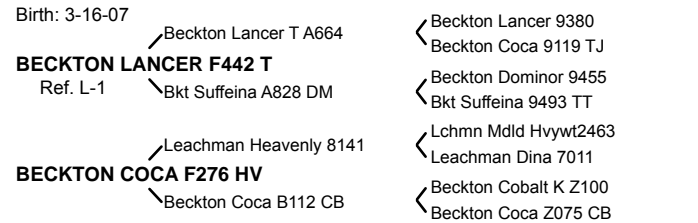

Calv.Ease	BW	WW	YW	Milk	HPG	Maint.En.	Stay
8	+0.9	40	72	13	6	-0.9	13
(.24)	(.38)	(.30)	(.32)	(.26)	(.22)	(.18)	(.25)
Marb -0.04 (.34)		REA +0.26 (.34)		Bfat -0.02 (.31)			
BWt	WWt	WR	ADG	YWt	YR	Scr.	Fr.
89	722	126	4	1292	118	37	5.5

★★★★★ for Low Maintenance, Gainability, Rib-eye area, Calving Ease, Stayability.

L-1 **BECKTON LANCER F442 T**
1-A 100% # 533603 Tattoo: WF6 F442

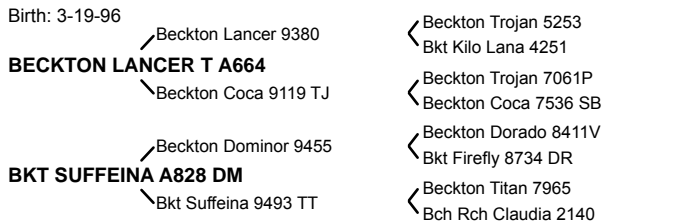

Calv.Ease	BW	WW	YW	Milk	HPG	Maint.En.	Stay
11	-0.4	32	51	7	3	.0	10
(.90)	(.94)	(.93)	(.92)	(.89)	(.73)	(.61)	(.27)
Marb +0.27 (.80)		REA +0.49 (.76)		Bfat -0.03 (.69)			
BWt	WWt	WR	ADG	YWt	YR	Scr.	Fr.
82	623	112	3	1084	109	37	5.5

★★★★★ for Low Maintenance, Gainability, Marbling, Rib-eye area, Calving Ease.



Beckton Lancer F442 T

• Beckton Reference Sires •



Beckton Nebula M045

N-1 **BECKTON NEBULA M045**
1-A 100% # 854775 Tattoo: BKT2 M045

Birth: 2-19-02
 Beckton Neptune RR B284
BECKTON NEPTUNE R2 K065
 Beckton Lana C735 TP
 Beckton Julian GG B571
BECKTON BELGA K285 JL
 Beckton Belga G493 HR
 Bkt Neptune 8460 R
 Beckton Eola 8600 RR
 RDD B Topper 1675
 Beckton Lana A714 TR
 Beckton Julian 7526G
 Bkt Marta 9A13 JL
 Beckton Herald K B244
 Beckton Belga D776 CL

Calv.Ease	BW	WW	YW	Milk	HPG	Maint.En.	Stay
18	-6.8	27	60	7	16	-7.2	14
(.72)	(.84)	(.80)	(.78)	(.73)	(.49)	(.54)	(.18)
Marb +1.0 (.52)		REA +2.4 (.48)		Bfat +0.1 (.31)			
BWt	WWt	WR	ADG	YWt	YR	Scr.	Fr.
59	586	108	4	1080	106	35	5.0

★★★★★ for Low Maintenance, Gainability, Rib-eye area, Calving Ease, Stayability.

L-4 **BECKTON LIKABLE U091**
1-A 100% # 1259087 Tattoo: WF8 U091

Birth: 3-1-08
 Beckton Lancer F442 T
BECKTON LIKABLE S633
 Beckton Kit F468 JL
 Beckton Jet L P491
BECKTON LANA S157 JT
 Beckton Lana P668 CH
 Beckton Lancer T A664
 Bkt Suffeina A828 DM
 Beckton Julian GG B571
 Beckton Kit A517 NP
 TR Julian LT151
 Beckton Minerva L278 LN
 Beckton Champ R3 H338
 Beckton Lana E610 JL

Calv.Ease	BW	WW	YW	Milk	HPG	Maint.En.	Stay
16	-5.4	19	52	14	10	-3.0	20
(.14)	(.33)	(.23)	(.25)	(.14)	(.01)	(.01)	(.01)
Marb +0.09 (.26)		REA +3.7 (.25)		Bfat -0.1 (.22)			
BWt	WWt	WR	ADG	YWt	YR	Scr.	Fr.
60	561	105	5	1142	113	35	5.0

★★★★★ for Low Maintenance, Gainability, Rib-eye area, Calving Ease, Stayability.

N-2 **BECKTON NEBULA E P084**
1-A 100% # 978410 Tattoo: BKT4 P084

Birth: 2-27-04
 Beckton Neptune R2 K065
BECKTON NEBULA M045
 Ref. N-1
 Beckton Epic K F075
BKT PINE MARIE M119 EP
 Bkt Pine Marie D126 JL
 Beckton Neptune RR B284
 Beckton Lana C735 TP
 Beckton Julian GG B571
 Beckton Belga G493 HR
 Beckton Epic D404
 Beckton Belga D483 KR
 Beckton Julian GG B571
 Bkt Pine Marie B849 JL

Calv.Ease	BW	WW	YW	Milk	HPG	Maint.En.	Stay
20	-8.7	16	43	12	14	-7.5	19
(.43)	(.72)	(.63)	(.61)	(.43)	(.31)	(.29)	(.01)
Marb +0.27 (.43)		REA +0.06 (.39)		Bfat +0.1 (.23)			
BWt	WWt	WR	ADG	YWt	YR	Scr.	Fr.
54	559	100	3	1023	100	33	4.0

★★★★★ for Low Maintenance, Gainability, Marbling, Calving Ease, Stayability.

L-5 **BECKTON LIKABLE U130**
1-A 100% # 1258774 Tattoo: BKT8 U130

Birth: 3-6-08
 Beckton Lancer F442 T
BECKTON LIKABLE S633
 Beckton Kit F468 JL
 Beckton Lancer F442 T
BECKTON KIT S478 LN
 Beckton Kit F468 JL
 Beckton Lancer T A664
 Bkt Suffeina A828 DM
 Beckton Julian GG B571
 Beckton Kit A517 NP
 Beckton Lancer T A664
 Bkt Suffeina A828 DM
 Beckton Julian GG B571
 Beckton Kit A517 NP

Calv.Ease	BW	WW	YW	Milk	HPG	Maint.En.	Stay
12	-1.8	27	56	10	8	-6.3	22
(.15)	(.32)	(.23)	(.24)	(.15)	(.01)	(.01)	(.01)
Marb +0.06 (.28)		REA +0.73 (.27)		Bfat -0.1 (.25)			
BWt	WWt	WR	ADG	YWt	YR	Scr.	Fr.
68	536	100	4	1059	104	35	5.0

★★★★★ for Low Maintenance, Gainability, Rib-eye area, Calving Ease, Stayability.

N-3 **BECKTON NEBULA R787**
1-A 100% # 1042525 Tattoo: BKT5 R787

Birth: 4-18-05
 Beckton Neptune R2 K065
BECKTON NEBULA M045
 Ref. N-1
 Beckton Scamp T A825
BECKTON LARKABA D388 SC
 Beckton Larkaba A833 JL
 Beckton Neptune RR B284
 Beckton Lana C735 TP
 Beckton Julian GG B571
 Beckton Belga G493 HR
 Beckton Scamp 8954
 Bkt Encino 8459 TJ
 Beckton Julian 8970S
 Bkt Larkaba 9613 VC

Calv.Ease	BW	WW	YW	Milk	HPG	Maint.En.	Stay
18	-7.2	14	44	12	14	-7.7	14
(.23)	(.38)	(.30)	(.32)	(.25)	(.19)	(.17)	(.15)
Marb +0.05 (.01)		REA +0.05 (.01)		Bfat +0.1 (.01)			
BWt	WWt	WR	ADG	YWt	YR	Scr.	Fr.
56	640	102	4	1212	108	37	5.5

★★★★★ for Low Maintenance, Gainability, Calving Ease, Stayability.

• Beckton Reference Sires •



Beckton Nebula N R573

N-6 **BECKTON NEBULA PJ S543**
1-A 100% # 1119006 Tattoo: BKT6 S543

Birth: 3-23-06
 Beckton Nebula M045
BECKTON NEBULA P P707
 Beckton Lana M809 EP
 Beckton Neptune R2 K065
 Beckton Belga K285 JL
 Beckton Epic K1 K863
 Beckton Lana K253 DM
 Beckton Julian G1 J526
 Beckton Rose J725 EP
BECKTON LANA P685 JO
 Beckton Lana E083 CD
 Beckton Cody C401
 Beckton Lana C220 CL

Calv.Ease	BW	WW	YW	Milk	HPG	Maint.En.	Stay
16	-5.2	35	76	16	9	-1.5	15
(.27)	(.59)	(.48)	(.45)	(.27)	(.01)	(.12)	(.01)
Marb +1.5 (.36)		REA +2.0 (.33)		Bfat +0.1 (.20)			
BWt	WWt	WR	ADG	YWt	YR	Scr.	Fr.
68	661	126	4	1216	120	35	6.5

★★★★★ for Low Maintenance, Gainability, Marbling, Rib-eye area, Calving Ease, Stayability.

N-4 **BECKTON NEBULA N R573**
1-A 100% # 1042311 Tattoo: BKT5 R573

Birth: 3-29-05
 Beckton Neptune R2 K065
BECKTON NEBULA M045
 Ref. N-1
 Beckton Belga K285 JL
 Beckton Lancer F442 T
BECKTON LANA M621 LN
 Beckton Lana H329 HD
 Beckton Neptune RR B284
 Beckton Lana C735 TP
 Beckton Julian GG B571
 Beckton Belga G493 HR
 Beckton Lancer T A664
 Bkt Suffeina A828 DM
 Beckton Hadrian FH E143
 Beckton Lana D288 VG

Calv.Ease	BW	WW	YW	Milk	HPG	Maint.En.	Stay
14	-3.9	29	57	10	12	-4.7	17
(.29)	(.68)	(.57)	(.54)	(.28)	(.30)	(.15)	(.01)
Marb +1.3 (.41)		REA +0.7 (.38)		Bfat -0.1 (.24)			
BWt	WWt	WR	ADG	YWt	YR	Scr.	Fr.
66	610	100	4	1191	107	37	4.5

★★★★★ for Low Maintenance, Gainability, Marbling, Calving Ease, Stayability.

N-7 **BECKTON NEBULA T054 J**
1-A 100% # 1178349 Tattoo: BKT7 T054

Birth: 2-18-07
 Beckton Nebula M045
BECKTON NEBULA J R475
 Ref. N-3
 Beckton Larkeisa M138 JC
 Beckton Hustler C2 L079
BKT PINE MARIE R401 HU
 Bkt Pine Marie LC30 CD
 Beckton Neptune R2 K065
 Beckton Belga K285 JL
 Beckton Justice G302
 Bkt Larkeisa G448 CT
 Beckton Hustler CN J102
 Beckton Barmaid J012 CO
 Beckton Cody V E023
 Bkt Pine Marie D764 HD

Calv.Ease	BW	WW	YW	Milk	HPG	Maint.En.	Stay
13	-3.7	22	57	11	14	-2.8	16
(.13)	(.33)	(.23)	(.25)	(.14)	(.01)	(.01)	(.01)
Marb +1.0 (.26)		REA +4.2 (.25)		Bfat -0.1 (.20)			
BWt	WWt	WR	ADG	YWt	YR	Scr.	Fr.
67	507	91	5	1135	106	35	5.0

★★★★★ for Low Maintenance, Gainability, Rib-eye area, Calving Ease, Stayability.

N-5 **BECKTON NEBULA J R475**
1-A 100% # 1042213 Tattoo: BKT5 R475

Birth: 3-23-05
 Beckton Neptune R2 K065
BECKTON NEBULA M045
 Ref. N-1
 Beckton Belga K285 JL
 Beckton Justice G302
BECKTON LARKEISA M138 JC
 Bkt Larkeisa G448 CT
 Beckton Neptune RR B284
 Beckton Lana C735 TP
 Beckton Julian GG B571
 Beckton Belga G493 HR
 Beckton Julian GG B571
 Bkt Vernice 9733 PC
 Beckton Clifftop T C075
 Bkt Larkeisa C894 JV

Calv.Ease	BW	WW	YW	Milk	HPG	Maint.En.	Stay
18	-6.8	19	45	9	14	-8.7	18
(.29)	(.59)	(.48)	(.45)	(.29)	(.01)	(.16)	(.01)
Marb +0.9 (.36)		REA +4.3 (.34)		Bfat +0.0 (.23)			
BWt	WWt	WR	ADG	YWt	YR	Scr.	Fr.
60	595	97	4	1142	103	36	4.5

★★★★★ for Low Maintenance, Gainability, Rib-eye area, Calving Ease, Stayability.



Beckton Nebula J R475

• Beckton Reference Sires •

N-8 **BECKTON NEBULA T269**
1-A 100% # 1178779 Tattoo: BKT7 T269

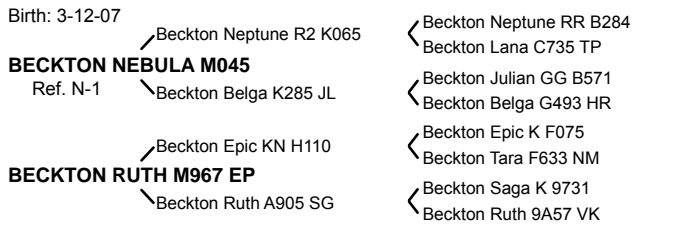

Calv.Ease	BW	WW	YW	Milk	HPG	Maint.En.	Stay
13	-4.2	25	57	11	13	-7.8	14
(.21)	(.36)	(.27)	(.29)	(.22)	(.01)	(.16)	(.01)
Marb +0.05 (.28)		REA +0.27 (.27)		Bfat +0.01 (.22)			
BWt	WWt	WR	ADG	YWt	YR	Scr.	Fr.
75	522	94	4	1145	105	37	5.5

★★★★★ for Low Maintenance, Gainability, Rib-eye area, Calving Ease, Stayability.

V-1 **BECKTON VEGA P079**
1-A 100% # 978405 Tattoo: BKT4 P079

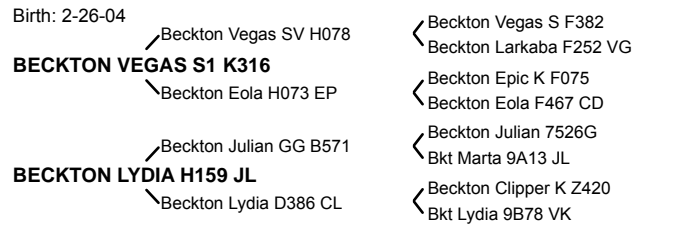

Calv.Ease	BW	WW	YW	Milk	HPG	Maint.En.	Stay
13	-2.4	24	49	15	10	+6.1	14
(.43)	(.70)	(.61)	(.59)	(.43)	(.18)	(.29)	(.10)
Marb -0.05 (.42)		REA +0.25 (.39)		Bfat +0.00 (.22)			
BWt	WWt	WR	ADG	YWt	YR	Scr.	Fr.
73	603	98	4	1139	104	35	5.0

★★★★★ for Gainability, Rib-eye area, Calving Ease, Stayability.

N-9 **BECKTON NEBULA U060 PJ**
1-A 100% # 1259084 Tattoo: WF8 U060

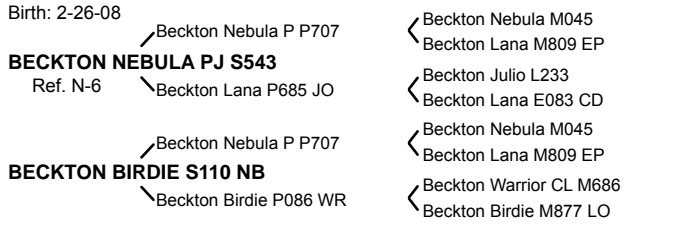

Calv.Ease	BW	WW	YW	Milk	HPG	Maint.En.	Stay
17	-6.5	29	62	15	10	-3.4	16
(.12)	(.33)	(.23)	(.24)	(.13)	(.01)	(.01)	(.01)
Marb +0.16 (.25)		REA +0.12 (.24)		Bfat +0.01 (.19)			
BWt	WWt	WR	ADG	YWt	YR	Scr.	Fr.
52	565	99	4	1037	100	35	5.0

★★★★★ for Low Maintenance, Gainability, Marbling, Calving Ease, Stayability.

W-1 **BECKTON WARRIOR C1 S337**
1-A 100% # 1118800 Tattoo: WF6 S337

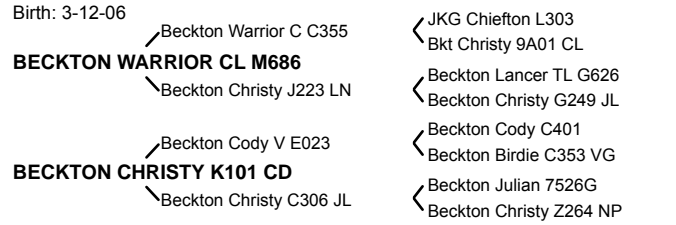

Calv.Ease	BW	WW	YW	Milk	HPG	Maint.En.	Stay
16	-4.2	31	63	15	14	+1.8	13
(.30)	(.58)	(.49)	(.47)	(.30)	(.01)	(.15)	(.10)
Marb +0.05 (.40)		REA +0.29 (.37)		Bfat +0.00 (.23)			
BWt	WWt	WR	ADG	YWt	YR	Scr.	Fr.
81	682	116	5	1249	112	36	5.5

★★★★★ for Low Maintenance, Gainability, Rib-eye area, Calving Ease, Stayability.

R-1 **BECKTON RANGER T603 R**
1-A 100% # 1178895 Tattoo: WF7 T603

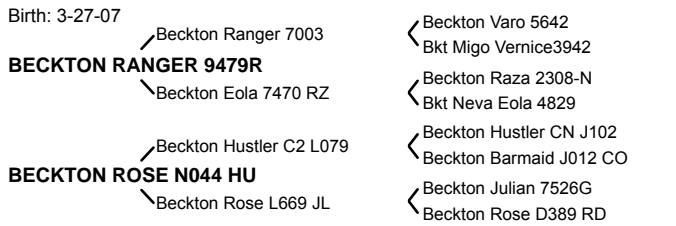

Calv.Ease	BW	WW	YW	Milk	HPG	Maint.En.	Stay
9	-1.9	23	45	9	9	-9.4	10
(.20)	(.36)	(.28)	(.29)	(.22)	(.01)	(.13)	(.17)
Marb +0.11 (.29)		REA -0.20 (.28)		Bfat +0.01 (.24)			
BWt	WWt	WR	ADG	YWt	YR	Scr.	Fr.
84	637	106	4	1185	106	35	5.5

★★★★★ for Low Maintenance, Gainability, Marbling, Calving Ease.

W-2 **BECKTON WARRIOR T248 T3**
1-A 100% # 1178758 Tattoo: WF7 T248

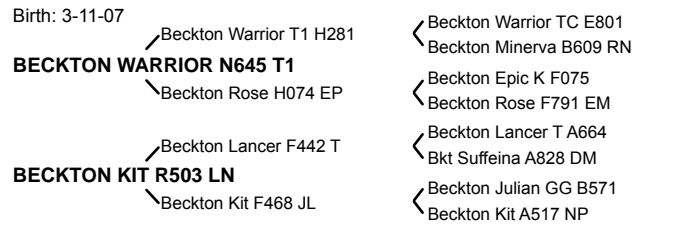

Calv.Ease	BW	WW	YW	Milk	HPG	Maint.En.	Stay
9	-0.6	37	70	11	10	-4.3	15
(.19)	(.34)	(.26)	(.28)	(.20)	(.01)	(.01)	(.01)
Marb +0.00 (.29)		REA +0.38 (.28)		Bfat +0.00 (.23)			
BWt	WWt	WR	ADG	YWt	YR	Scr.	Fr.
70	602	108	4	1136	106	37	5.0

★★★★★ for Low Maintenance, Gainability, Rib-eye area, Calving Ease, Stayability.

Sire Bloodline Charts

Name Family

- Champ H
- Clifftop B
- Clipper C
- Cobalt C
- Cody C
- Colt C
- Copper B
- Dominor D
- Emcee E
- Emperor E
- Epic E
- Epitomy E
- Exeter E
- Hasten H
- Herald H
- Heritage H
- Hilltop B
- Hustler H
- Javelin L
- Jet J
- Jules J
- Julian J
- Julio J
- Juniper J
- Juno J
- Jupiter J
- Justice J
- Lancer L
- Lamar L
- Lariat L
- Legend L
- Likable L
- Loki L
- Nebula N
- Neptune N
- Neva V
- Nomad V
- Ranger R
- Roman J
- Scamp J
- Varo R
- Vega V
- Vegas V
- Warhawk W
- Warrior W

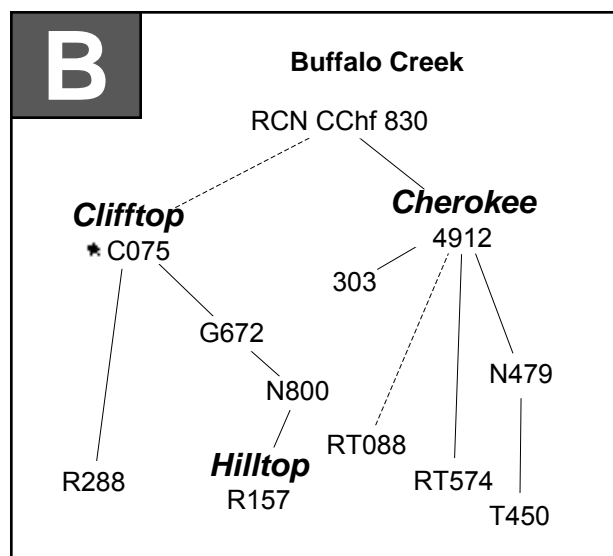
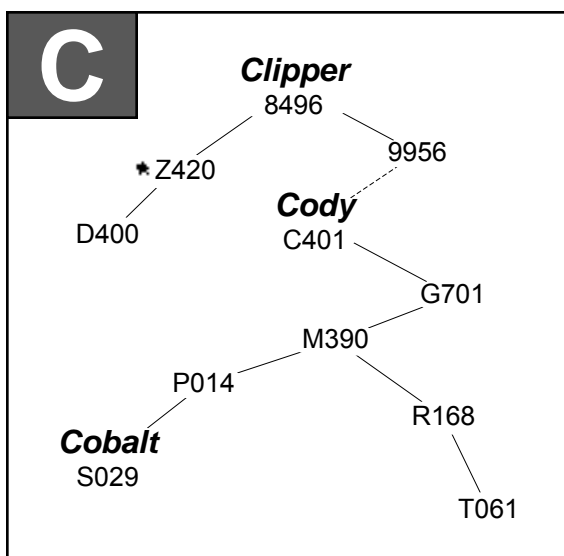
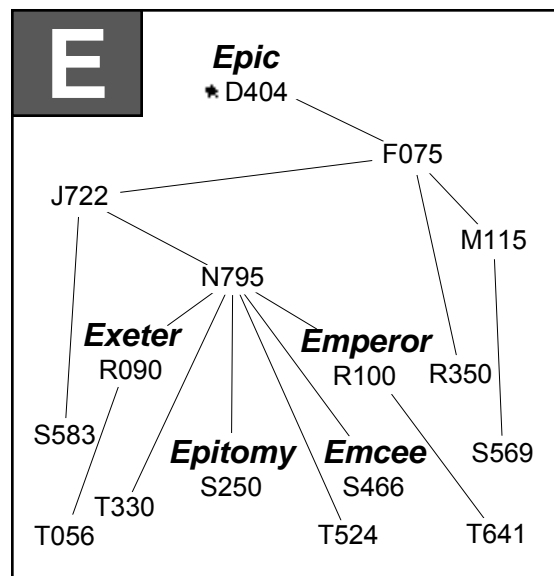
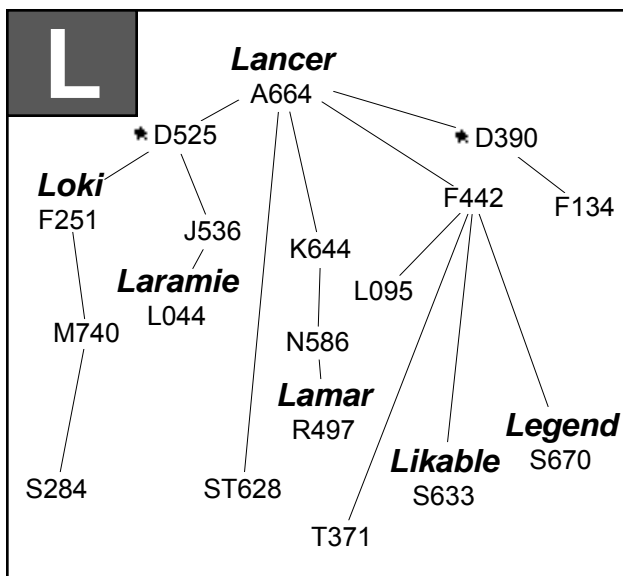
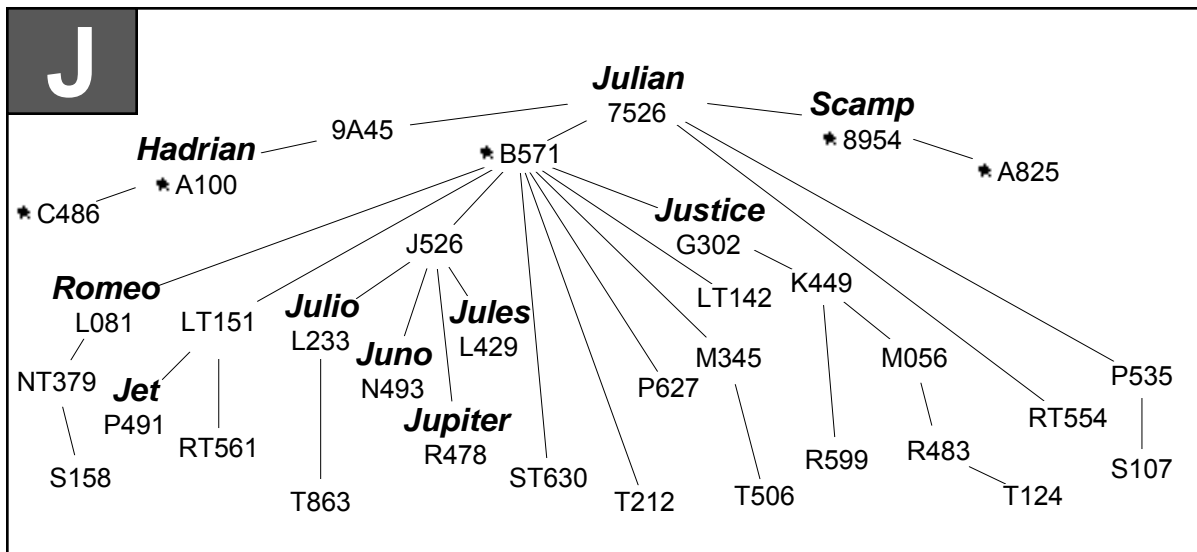

★ Red Angus Trait Leader

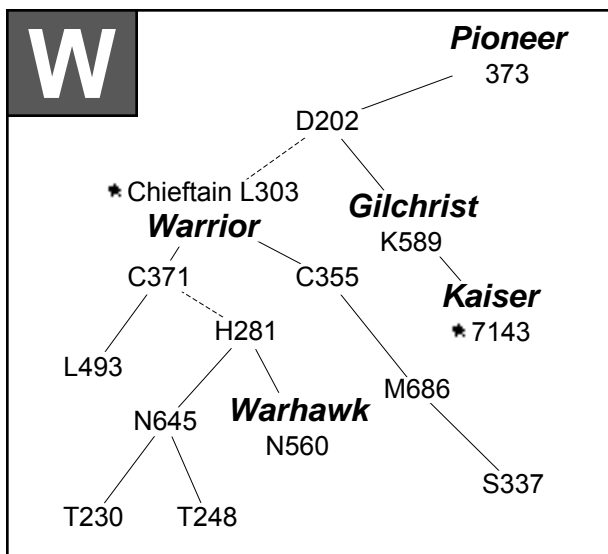
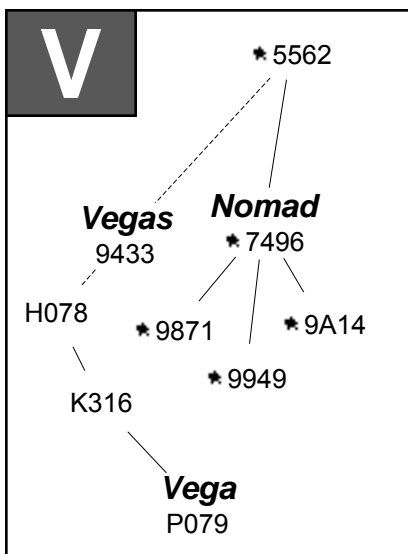
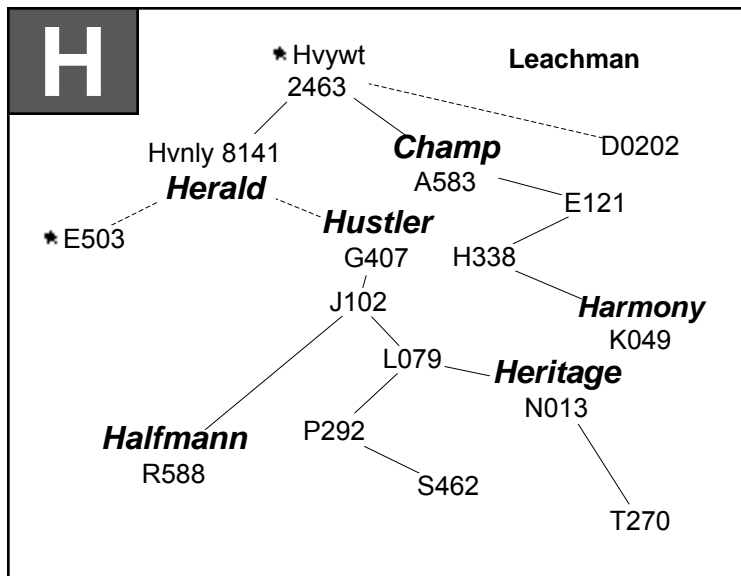
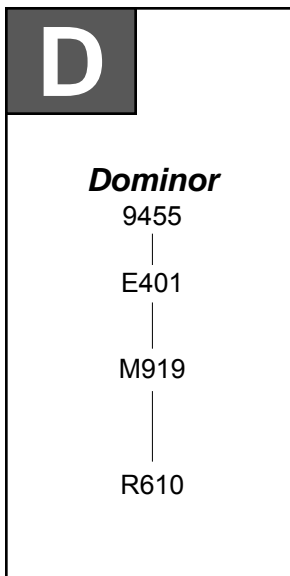
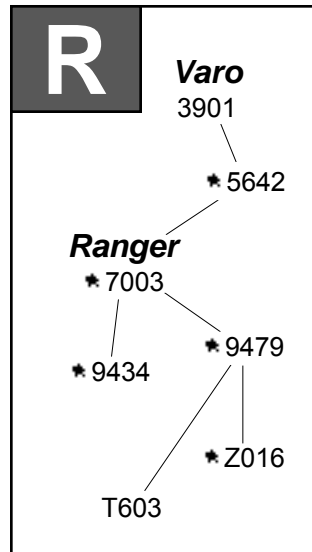
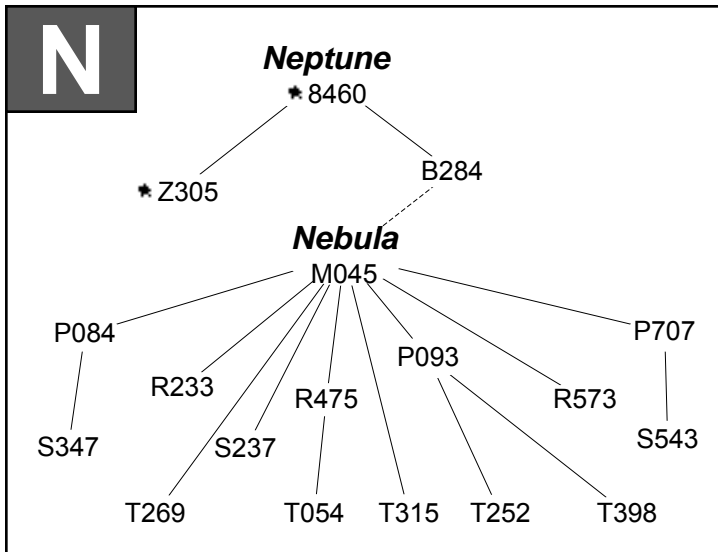

Name	Tag	Family
Julian	7526	J
Lancer	A664	L
Julian	B571	J-1
Epic	D404	E
Epic	F075	E
Lancer	F442	L-1
Julian	J526	J
Epic	J722	E
Hustler	L079	H
Julio	L233	J-2
Julian	LT151	J-11
Nebula	M045	N-1
Justice	M056	J-3
Epic	M115	E-1
Julian	M345	J
Cody	M390	C
Warrior	M686	W
Loki	M740	L
Dominor	M919	D
Heritage	N013	H-1
Cherokee	N479	B-1
Juno	N493	J
Warhawk	N560	W
Lancer	N586	L-2
Warrior	N645	W-1
Epic	N795	E-2
Clifftop	N800	B-2
Romeo	NT379	J
Cody	P014	C-1
Vega	P079	V-1
Nebula	P084	N-2
Nebula	P093	N-3
Hasten	P292	H
Jet	P491	J-4
Julian	P535	J-5
Julian	P608	J-6
Julian	P627	J
Nebula	P707	N-4
Exeter	R090	E
Emperor	R100	E
Hilltop	R157	B
Cody	R168	C-2
Nebula	R233	N
Clifftop	R288	B-3
Epic	R350	E-3
Nebula	R475	N
Jupiter	R478	J
Justice	R483	J-7
Nebula	R573	N-5
Halfmann	R588	H-2
Justice	R599	J
Dominor	R610	D
Julian	RT561	J-13
Cobalt	S029	C-3
Julian	S107	J-8
Roman	S158	J-9
Nebula	S237	N-6
Epitomy	S250	E
Loki	S284	L-3
Warrior	S337	W-2
Nebula	S347	N-7
Hasten	S462	H-3
Emcee	S466	E-4
Nebula	S543	N-8
Epic	S569	E-5
Epic	S583	E
Likable	S633	L-4
Legend	S670	L

Lot-Tag Cross Reference

<u>ID</u>	<u>Lot</u>	<u>ID</u>	<u>Lot</u>	<u>ID</u>	<u>Lot</u>	<u>ID</u>	<u>Lot</u>	<u>ID</u>	<u>Lot</u>
<i>Beckton Females</i>		U389	40	S311	64	R350	412	T269	N-8
H115	126	U407	75	S48	117	R475	410	T270	H-2
K768	6	U418	103	U003	10	R483	409	T330	E-4
L654	4	U467	21	U004	12	R573	414	T371	L-3
M514	121	U481	43	U008	13	R787	423	T398	N-9
P011	116	U484	44	U018	82	RT561	421	T450	B-2
P016	120	U498	100	U020	14	S347	411	T524	E-5
P091	5	U569	17	U022	46	S369	408	T603	R-1
R124	125	U632	74	U033	15	S634	420	T641	E-6
R540	63	U638	85	U035	39	S651	407	U060	N-10
R604	56	U653	18	U037	22	T035	405	U091	L-4
R775	110	U657	20	U039	48	T234	406	U095	E-7
R801	115	U658	32	U046	50	T612	418	U108	H-3
S418	62	U660	33	U047	47	T748	419	U126	E-8
S596	57	U684	45	U050	49	U035	403	U130	L-5
S756	114	U754	89	U057	51	U099	416	U575	B-3
S831	69	U757	101	U060	98	U269	401	U699	J-6
T080	53	U829	41	U065	79	U490	404	U742	J-7
T138	52	U854	73	U078	26	U672	417	U749	E-9
T158	68	U876	104	U079	80	U716	425	U777	C-2
T229	67	<i>Mushrush Females</i>		U088	23	U817	402	<i>Mushrush Ref. Sires</i>	
T240	109	1182	107	U090	38	<i>Beckton Ref. Sires</i>		1005	A
T243	54	6026	3	U102	97	B571	J-1	77S	C
T553	108	8017	128	U106	83	F442	L-1	84S	E
T633	55	8019	2	U117	25	M045	N-1	J526	F
T651	61	8111	124	U123	11	N795	E-1	LT142	G
U028	102	8125	127	U127	84	P079	V-1	N153	H
U056	30	9037	1	U128	27	P084	N-2	N202	I
U069	29	L07	119	U131	34	R168	C-1	N223	J
U097	9	L12	118	U137	24	R288	B-1	P016	K
U143	78	L56	123	U163	81	R350	E-2	P017	L
U165	86	M060	105	U167	35	R475	N-3	P7081	M
U176	76	M070	111	U170	36	R483	J-2	R017	N
U182	77	M121	112	U174	92	R573	N-4	R205	O
U212	87	M126	72	U175	91	R787	N-5	R244	P
U218	7	M211	70	U182	37	RT561	J-3	S035	Q
U221	19	N031	66	U192	96	S107	J-4	S207	R
U259	31	P090	71	U193	93	S158	J-5	T038	S
U261	99	P253	106	U195	94	S284	L-2	T068	T
U262	8	P301	58	U198	95	S337	W-1	T085	U
U293	16	P362	122	<i>Bulls</i>		S462	H-1	U005	V
U295	28	R203	59	P079	424	S543	N-6	U055	W
U303	88	S013	60	P084	415	S569	E-3	U127	B
U354	42	S24	65	R168	413	T054	N-7	U485	D
U358	90	S273	113	R288	422	T248	W-2		

Our Families



Pen after pen, year after year...
THEY WORK!
MUSHRUSH
RED ANGUS
2346B N Rd. • Strong City, KS 66869

FIRST CLASS MAIL
U.S. POSTAGE
PAID
COTTONWOOD FALLS, KS
PERMIT NO. 09



**Both locations
broadcast live!**

DVAuction Broadcasting
Real-time Auctions