

66th Anniversary Production Sale

Tuesday April 12th, 2011

Industry Leaders for
Low Maintenance, Maternal Traits



1 Beckton Red Angus

Foundation Herd of the Red Angus Breed

Transportation

Great Lakes Airlines

Several daily flights to/from Denver
Contact Holiday Inn for airport transfers

Avis Car Rental

T: 307.672.2226, Sheridan Airport

Accommodations

Holiday Inn

307.672.8931, I-90, Exit 25
Please ask for special Beckton Sale rate

Best Western Sheridan Center

307.674.7421, 612 N. Main Street

Days Inn

307.672.2888, 1104 Brundage Lane

Super 8 Motel

307.672.9725, 2435 N. Main Street



Auctioneer Roger Jacobs
406.698.7686

Sight-Unseen Purchase (by mail or phone)

If you are unable to attend the sale, we can help you select the bulls or females to fit your needs. Give us a phone call, letter, fax or e-mail (please refer to the back cover), and we can make arrangements to handle bidding according to your directions. Bulls are bought at the lowest price, and satisfaction is guaranteed on bulls purchased sight unseen. Many of our repeat customers buy their bulls this way.

To provide us adequate time to assist you, please contact us before noon of the day prior to the sale.

Free Delivery

We pay for delivery for all bulls and registered heifers throughout the Continental U.S. If you do bring a trailer to haul your own, \$50 will be deducted from the price of each bull or registered heifer. Most of the sale cattle will be delivered from 1-3 weeks after the sale, although we will try to accommodate special needs. Although there occasionally are limitations, in most cases we can deliver the cattle directly to your ranch.

Payment

Payments can be made with cash, check payable to Beckton Stock Farm, or Visa/Mastercard on sale day.

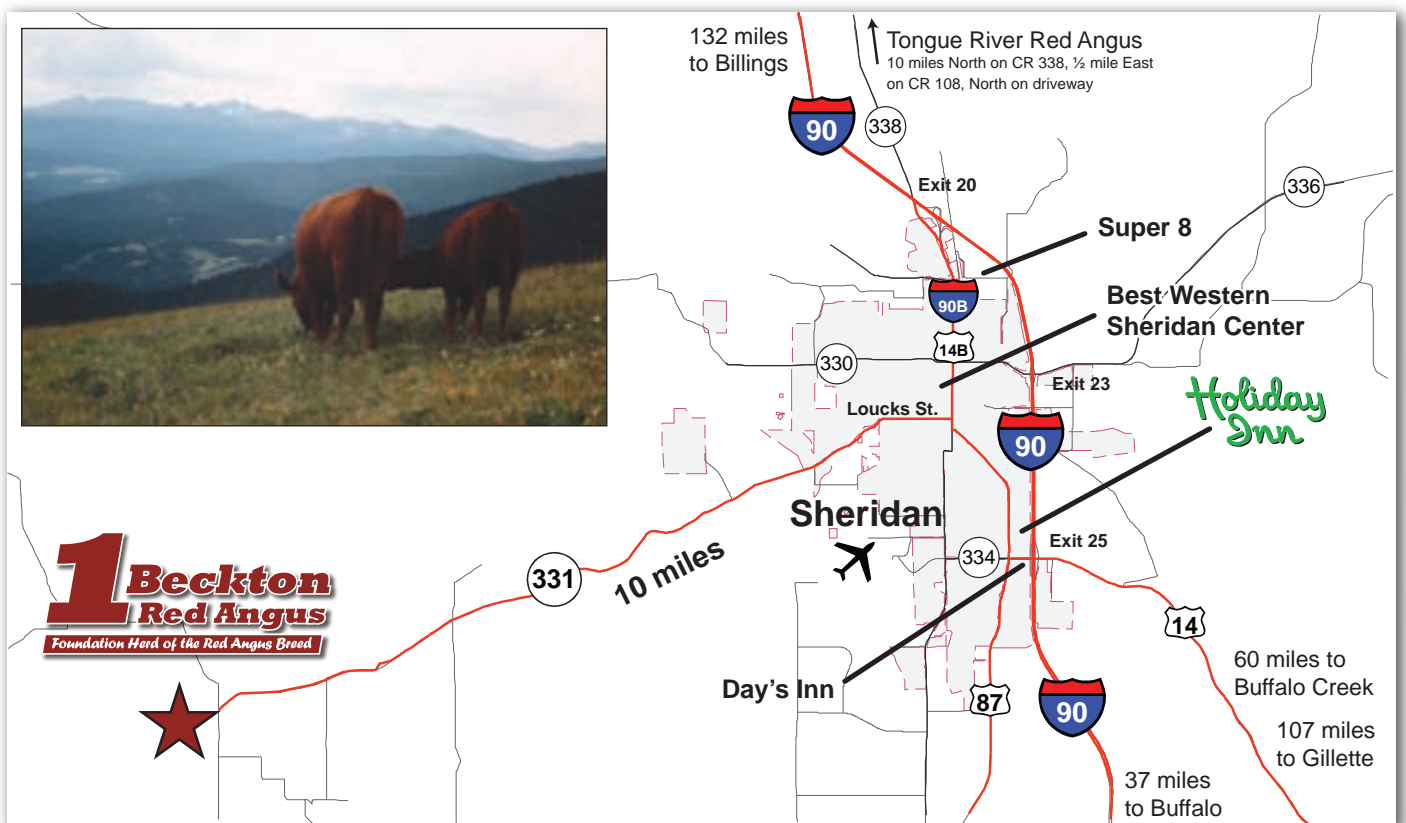

66th Anniversary Production Sale

Beckton Ranch

9½ miles West of Sheridan

Tuesday, April 12, 2011

1 o'clock pm

Lunch at noon

260 Bulls • 71 Heifers

Selling in catalog order, heifers sell following the bulls

Please join us for a complimentary dinner after the sale at the Holiday Inn.

Phone: 307.674.6095



Beckton Red Angus is the Foundation Herd of the Red Angus breed. Started in 1945, it has since maintained the longest continuous performance testing and improvement program in the industry.

Some Facts about the Beckton Herd

- ▶ Beckton is the #1 herd for Low Maintenance Energy requirements, with the lowest average Cow Maintenance EPD of any major herd. Seven of the top ten sires in the breed for lowest Maintenance Energy are Beckton sires, more than all other herds combined. The average Beckton bull in this sale is in the top 5% of the entire breed for low Maintenance Energy EPD. **No other set of bulls will do a better job cutting your cowherd maintenance requirement and saving you money.**
- ▶ Beckton is also the #1 herd for easy calving, with the best average Calving Ease EPD of any major herd. Eight of the top ten sires in the breed for low Birth Weight EPD are Beckton sires. **No other set of bulls will do a better job giving you calving ease, for easier nights, and reducing calving loss.**
- ▶ Beckton bulls are leaders in total birth-to-market rate of growth. The average growth from birth to yearling weight EPD of these sale bulls is +59. **These are the bulls that give you not only low cowherd maintenance costs and higher calving ease, but also higher growth rate up to market age.**
- ▶ Beckton produces the top all-round carcass sires that combine Rib-eye and Marbling with Efficiency and Calving Ease. Beckton is producing the most "in-demand" sires in the breed - Beckton Julian B571, Beckton Nebula M045 and Beckton Nebula P707— with **top carcass traits, low maintenance energy requirements, and high Stayability.**
- ▶ Plus 66 years of selection for the convenience traits – good dispositions – cowherd fertility – good udders and milk. Our cattle grow up at high elevations in the Bighorn Mountains, as well as Wyoming range, so they offer **excellent altitude adaptation and good feet and legs.**
- ▶ There is no other sale offering which combines such good growth traits with this low cow maintenance and high calving ease, and in so many bulls.



Cam and Trish Forbes

The Foundation Herd of the Red Angus Breed – Serving our customers with industry leading genetics and the highest quality cattle – for 66 years.

Additional Sale Information

- ▶ The animals sell in catalog order.
- ▶ All bulls have passed a rigorous fertility exam that included live semen evaluation, scrotal measurements, and reproductive tract examinations.
- ▶ Beckton has a comprehensive herd-wide health program which includes vaccinations for 7-Way, IBR, BVD, PI3, BRSV, Lepto, and ivermectin. The heifers are also vaccinated for bangs and vibrio.
- ▶ Since a genetic test was developed by RAAA for osteopetrosis (OS) two years ago, Beckton has tested every sire in use in our program, as well as our major AI sires. All Beckton bred sires (nearly 80 in total) have tested **OS Free**.
- ▶ We plan to have semen collected on some of the bulls before the sale. We will also work with the buyer to collect bulls after the sale.
- ▶ Beckton's focus has always been on the commercial market. From our earliest sales over 40 years ago, we have retained a 1/3 semen interest on every bull sold through our sales. This policy has been for the benefit of our commercial customers, who are not in the business of selling semen. Buyers at our sale have not had to compete with AI companies when they bid for their choice of bulls. This policy continues with this sale, and unless otherwise designated in the catalog or by the auctioneer, the following terms are included in the terms and conditions, and re-stated here, and apply to all bulls in the sale:

Buyer receives full possession of the bull, and income from future sale of the animal itself. Buyer also has the sole privilege to determine if and when a bull is collected in the future. Seller retains a 1/3 semen interest on all sale bulls, including the privilege of in-herd use. If a bull is collected in the future, we would like to be notified so we may obtain semen, sharing pro-rata in the collection cost. On bulls from which semen is marketed commercially in the future, seller is entitled to a 1/3 royalty interest on gross semen sales, with buyer receiving 2/3 of gross sales.

This policy helps make every bull in our sale, from Lot 1 on, equally accessible to all of our customers, as well as giving the buyer full possession and control.

- ▶ **Special Rare Semen Option for BECKTON JULIAN B571 and BECKTON NEBULA P707:** These are the two premier sires in the Red Angus breed, offering the best of all traits for which our program is known. Semen is very limited and not on the market. We are offering four packages of 10 straws each, for choice of either of these sires, or split between them. Details are given on the inside back cover.



Bob Hough and Sal Forbes



Doug Bingham



Spike and Jo

Table of Contents

The Beckton Program	4
The Bulls	11
The Yearling Heifers	63
Reference Sires.	78
RAAA Herd EPD Tables	90
Sire Bloodline Charts.	92
Lot-Tag Cross Ref	94
Sale Terms & Conditions	95
Semen Available	96

Credit for many of the photographs in the catalog should go to Kim Wolfe (*Record Stockman*), Doug Hogan (*Tri-State*), Brenda Stewart, and Diane Vaneck.



Bob Hough
817.296.0976



Tommy "T.V." Jones
Record Stockman
307.632.5118



Doug Hogan
Tri-State
Livestock News
605.391.5346



Curt Cox
Wyoming Livestock
Roundup
307.630.4604



Jerry Gliko
Western Livestock
Journal
406.656.2515



Alan Sears
Western Livestock
Reporter
970.454.3986



Del Tinsley
Wyoming Livestock
Roundup
307.234.2700



Eric Mack
Wyoming Stockman
Farmer
406.366.2111

THE WALDO FORBES FAMILY
Sal; Spike and Jo; Cam and Trish;
Doug and Sheila; Cherry and John
Julia and Ed; Sarah and Doug;
Elfie and Ruth



REGISTERED RED ANGUS CATTLE AT
Foundation Herd of the Red Angus Breed
Serving You since 1945
BECKTON STOCK FARM
37 Beckton Drive
SHERIDAN, WYOMING 82801
Phone (307) 674-6095 day; 674-8162 evening; 672-7281 fax
beckton@wavecom.net



Dear Friends and Cattlemen,

On behalf of all of us at Beckton, we invite you to join us for our 66th Anniversary Production Sale. We have put together the best offering of Red Angus bulls and heifers ever, and hope you will take the opportunity to visit and see them. Following the sale, you are all cordially invited to a complimentary roast beef dinner at the Holiday Inn.

The future of the industry looks excellent. While feed costs are high, so are cattle prices. We are not seeing expansion in the nation's beef cow inventory. And beef cow numbers are unlikely to expand even as high prices continue, because the alternative uses of productive land are too attractive.

The best management strategy to deal with high feed costs, is to raise cattle which need less feed. Beckton has the leading genetics in the industry to moderate cow size and to reduce maintenance requirements. Ours is the #1 herd for low cow maintenance energy EPD, and this is the #1 sale for obtaining bulls with low maintenance energy genetics. But the producer can't give up a certain level of growth – his cattle must be cost effective for the packer to run through his plant. We need to watch both the demand side and the cost side.

But you also get strong growth, high calving ease, excellent carcass characteristics, and exceptional fertility and stayability. This results from so many years of performance selection in a consistent program. Our bulls are the leaders to achieve both low maintenance requirements and still produce steers with the gainability and growth to meet feeder and packers needs.

It has been a really good year for the cattle in spite of the summer and fall dryness. We recently went through all of the bulls again and they look fantastic. In keeping with our reputation, we offer only bulls which offer a high level of performance and structural soundness. We have also screened the bulls for disposition and made sure that anything which was questionable would not be in the sale. On the final weighing just recently, they were really quiet and easy to handle.

We are very proud of these bulls and heifers, and think we have a top selection to deliver to you. Join us for the sale and for dinner afterward. If we can help you in any other way, we will do our best.

Sincerely,



Shelley, Stephen, Trish, Tallie, and Cam

BRED-IN, NOT FED-IN, GENETIC SUPERIORITY
APRIL: SPRING BULL SALE FALL: RED ANGUS FEMALES
RED ANGUS BREEDING STOCK AVAILABLE YEAR ROUND

The Beckton Program

Cow Size

The goal for Beckton's program has always been to develop breeding seedstock which offer increased levels of performance for the commercial cattleman. Increased performance does not mean maximizing weight and size, which have already reached the upper limit of economic value for the packer and consumer. It does, however, mean increasing performance related to calving percentage and weaning percentage; and increasing performance related to cow maintenance requirements and "pounds of calf per acre" efficiency.

Size Matters

Beckton cattle are already big enough for the consumer and the packer. Using yearling weight EPD as the best available indicator of market size, the average for our sale bulls is +56, about the same as the Red Angus breed average, so for market size our cattle are directly comparable.

The big difference with Beckton's program is that we select for additional weaning and yearling weight, but with the restriction that we have maintained the same cow size over time. In contrast, the industry has allowed cow size to increase at the same rate as calf size. Cow size is the largest factor determining maintenance requirements. Our goal has been to increase efficiency, not size. No other seedstock breeding program has had such a goal and maintained it for so long.

Beckton Cow Weight Average (lb.)

Year	1978	1982	1986	1990	1994	1998	2002	2006	2010
Wt.	1,126	1,126	1,064	1,115	1,067	1,125	1,104	1,093	1,068

(mature lactating cows taken at weaning)

Cow weights vary from year to year depending on grass, weather or other short term factors. But overall our cow size has stayed fairly constant over time.

The Industry Problem

As shown on the graph on the next page, industry-wide cow size has increased substantially, 25% over this same period. But look at the industry-wide trend in feed use per cow over the same period, shown by the use of hay:

Industry Hay Use (tons/animal unit)

Year	1978	1982	1986	1990	1994	1998	2002	2006	2010
Hay Usg.	1.43	1.62	1.91	2.00	1.94	1.99	2.08	2.05	2.06
Pct.	100%	113	134	140	136	140	146	143	144

(Src.: USDA Econ. Research Service, 2007 is newest available data)

Industry-wide, production per cow is up about 22%, but hay consumption per cow has risen 44%.

Why does hay use increase at a faster rate than cow size or production per cow? Hay and grain are supplements to the cow's main diet, which is grass, and grass supply is relatively fixed by environment. Each increase in cow feed requirement must be met entirely by supplements, or by a combination of supplement and reduced stocking rate. A small increase in cow feed requirement leads to a reduction in stocking rate or a large increase in higher-cost, supplemental feed needs.

Any gains achieved in the feedlot sector due to increased animal growth, have been overwhelmed by increased cost of production in the cow-calf sector.

The Beckton Crew...



Tom Peek



Randy Zier



Mick McClure



Alan Sanders



Roger Zier

Efficiency

32 Years of Change: Industry-Wide

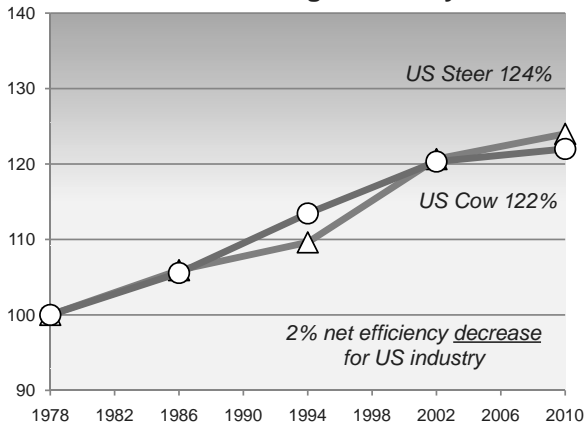

The graph at left shows how, for the U.S. cattle industry overall, the increase in average calf weights, as measured by steer slaughter weights, has been directly matched by an increase in average cow weights. (Percentages are based on USDA slaughter weight data for steers and cows respectively, using 1978 as a base year. Data for heifers slaughtered shows an identical trend.) Over 25 years, there has been minimal change in overall cowherd efficiency.

This graph shows the failure of cross-breeding and composite breeding to do little more than simply increase general cattle size. In the promotion of composites, the impact of retained heterosis on mature weight is too often ignored. Crossbreeding and composites are sold as a free lunch, but they aren't free.

We have accomplished this by selecting for growth, restricting birth weight and cow size creep, and multiplying each incremental change rapidly throughout our entire cowherd and all of our bloodlines. Usually this has meant working within our own bloodlines rather than introducing out-crosses, because the outside genetics for the direction we wanted to go haven't been available. The overall key to success is simply that we have been making small progress in multiple traits, but doing it consistently over a very long period of time.

32 Years of Change: Beckton

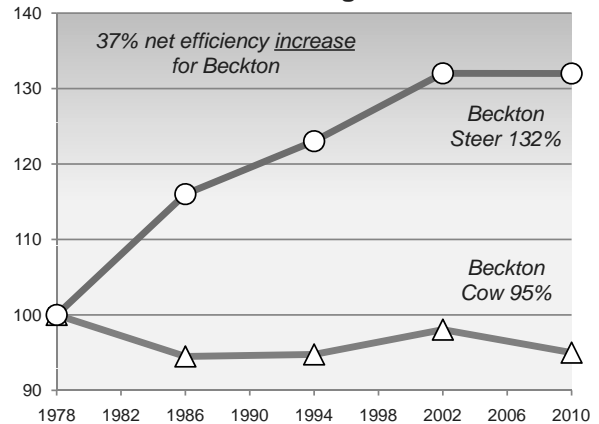

The graph at right shows Beckton cowherd data over the same time period.

1. Beckton cow size has shown no significant change over the past 32 years, while the industry has experienced a substantial increase in cow size.
2. Even without increasing cow size, we have raised the rate of early growth in Beckton cattle, using intense genetic selection and generation turnover, and by more than the rest of the industry.
3. The net change in efficiency as measured simply by "calf weight divided by cow weight" is significantly higher with Beckton's genetic program, compared to mainstream cross-breeding based on retained heterosis.

... making the Beckton Program work!



Sherry Kobielus



Seth Tomisich



Travus Adsit



Jane Redding

Management

One Bull – the Simple Solution is the Best Solution

Many cattlemen use Beckton bulls for their heifers because of their low birth weights and high calving ease. Our bulls are even better when used on cows, because replacement heifers tend to be selected from calves out of older cows. **Keeping replacement heifers sired by Beckton bulls is the quickest way to limit cow size creep and to moderate cow size for the future.** In our own program we use the same bulls on both heifers and cows. Every bull is used his first year with heifers to evaluate calving ease, and used in future years with older cows. We get calving ease, growth, and moderate-sized replacements, all with the same bull.

Quietness and Ease of Handling

The necessity of record keeping means that our cattle will be handled much more than commercial cows. **This benefits our seedstock customers because our cattle will be quieter and easier to handle.** Good disposition is one of our most valued traits.

Selection for Industry Requirements

In order to make selection decisions appropriate to the commercial beef industry, seedstock cattle need to be managed and measured under conditions which will approximate the commercial industry. **Our cows are run entirely on grass, with hay only if weather conditions require it, because that is how the commercial industry runs cows.** However, almost all commercial calves go into feedlots before slaughter, so feedlot performance and efficiency is an important trait for calves. **Simply put, a producer needs to know how his cows perform on grass, and how his calves perform with feed.**

Our bulls are run on a performance test designed to provide the fairest basis of comparison among them, and

this requires a compromise. Our bulls receive a “growing” ration high in roughage and protein and not as high in energy as a steer would receive. **We want to get a good measure of gainability with which to compare bulls, but we don’t want the bulls fat.**



*Craig Uden, Darr Feedlot Manager
Photo courtesy of the Lexington Clipper-Herald*

Mitch Ziebell, Craig Uden of Darr, NE

In the fall of 2005, Lane Kugler retired and sold his bull testing facility to a neighboring operation - Craig Uden with Darr Feeders. **The name change is somewhat misleading, because the bulls are still in the same pens they have always been in.** Unlike the Kugler’s, Craig runs a complete operation vertically integrated from commercial cow-calf production all the way to the packer door. Bull testing is a natural fit. Craig Uden started at Darr in 1984, and has served on numerous committees and organizations in Nebraska. Mitch Ziebell has joined him and has taken over responsibility for the daily management of our bulls at Darr. **We have been very impressed with what conscientious care Mitch oversees all aspects of the bull management.**

Contributing to the success of the Beckton Program...



*Sarah and Mark Schreiber
Our vets*



*Charles Larsen
Brand Inspector*



*Dr. Robert Bohlender
Fertility tests the bulls*



*Bob Milner
Our AI tech*

Additional Facts about the Beckton Program

Birth weight

- ▶ Every sire entering our own program is used first on our own heifers, then on our cows.
- ▶ We have never used high birth weight sires in any part of our program, so big birth weights are rare.
- ▶ We get the pay weight, but with lower birth weights and greater calving ease.
- ▶ Full production from heifers. We use the same bulls on heifers and cows.

Growth

- ▶ Weaning efficiency, and rate of gain to slaughter weight second to none.
- ▶ Growth traits must be consistent with maintaining maternal qualities.
- ▶ Beckton cattle are ideally sized for today's packer demand.

Hardiness

- ▶ Every cow in the herd has spent part of her life in the Big Horn Mountain summer range, at elevations from 7000 to 10,500 feet.
- ▶ In 2001 we PAP tested all of our herd sires. The herd average PAP score was 32.5 at 4000', equivalent to a herd average PAP of 39 at 8000' (excellent scores).
- ▶ By the time she is 5, our average cow will have been trailed over 80 miles, above and beyond normal pasture rotation.

Efficiency

- ▶ The typical dam of our bulls weans over 50% of her body weight in 205 days, under range conditions, with no creep-feeding.
- ▶ The average dam produces over 100% of her own body weight in a year.
- ▶ The average mature cow (age 5+) weighs about 1100-1125 pounds.

Fertility

- ▶ Every bull in our program is used in natural service, with 30-50 heifers/cows.
- ▶ Every cow in our program must cycle naturally and breed early under range conditions.

Value

- ▶ Beckton Red Angus produce more growth without high birth weights.
- ▶ They are the one-bull solution that can be used on both heifers and cows.
- ▶ Carcass quality is an extra benefit.

Reliability

- ▶ Beckton has been genetically improving Red Angus since 1945, a 30-60 year lead time over other producers.
- ▶ It is a complete, genetically sound breeding program, which demands whole-herd performance.



Sue and Forest Dunning
Tongue River Red Angus, 307.750.2454



Joe and Connie Mushrush
Mushrush Red Angus, 620.273.8581

Beckton History



Sal keeping records.



Waldo Forbes - 1st President of the Red Angus Association.



Beckton house/office before being moved in 1905 to its current location. This house was built in the 1880s by George Beck, the original homesteader. The antlers are still on the porch, and it is one of the oldest buildings in Sheridan County.



The Waldo Forbes family in 1959: Ellen, Julia, Sal, Sarah, Cherry,, Spike, and Cam & Elfie in front.



Inspection Committee at Beckton (1954), including George and Vernice Chiga, Sal and Waldo Forbes and Spike.



Beckton Larkabeau O "220" in 1959 - the 1st Red Angus Bull at ABS



Mrs. Waldo (Sal) Forbes was honored as the first woman inducted into the Saddle and Sirloin Club's portrait gallery in Louisville, KY.

The Other Friends and Family who help us in many ways over the course of the year



Dave Nelson



*Spike, Jo, and Keenan Forbes (back)
Jeff, Katie, Julia, Ellen, and Sarah Durkin (front)*



*Julia Forbes and Ed Waddington
(with Tazmin and Flinder)*



Sal Forbes and Elfie Forbes



Doug Foster and Sarah Forbes



*Don Bingham, Alison Brody,
and Kate Bingham*



*Mary Ellen McWilliams
and Joy Miller*



Ruth Sylvester

Using New Selection Tools

Maintenance EPD

This EPD predicts the relative feed energy requirement for maintenance, for cows produced by a sire or female. A bull with an ME of -3 (minus 3) is expected to sire replacement daughters which will need 10 fewer mcals of energy per month than a bull with an ME of +7.

We believe this is an important EPD because feed costs, both direct and indirect through ranch overhead, make up by far the largest proportion of operating costs. It can have much more direct impact on ranch profitability than Marbling or Ribeye EPD for example.

The Beckton herd is the breed's top herd for low maintenance energy requirements, with the lowest average herd ME of any major herd, based on all sires listed on National Sire Evaluation. **The average Beckton cow is in the top 4% of the entire breed for lowest Maintenance Energy requirement.**

Calving Ease

The Red Angus Calving Ease EPD was introduced in 2003, and is a more direct measure of calving ease than birth weight alone. Calving Ease is defined as follows: "The expected differences of calving ease measured as the probability difference (between sires) of unassisted calvings among offspring." For Calving Ease EPD, the higher number is better.

There are two Calving Ease EPDs – "Direct", a predictor of an animal's own offspring; and "Maternal", a predictor of a daughter's calving ease. Unless stated otherwise, we publish the Calving Ease Direct because most of our customers' primary concern is selecting bulls for use on first calf heifers.

Beckton's average Calving Ease EPD is +13, seven points higher than the Red Angus breed average of 6, due to our long history of selection for moderate birth weights. **The average Beckton bull is in the top 4% of the entire breed for highest Calving Ease.**

Cow Efficiency

We present two indicators of efficiency. The first is Weaning Percent, a simple percentage of calf 205 day weight divided by the dam's actual weight at weaning. The second is PRI Cow Efficiency. This also measures calf weaning weight, but relative to the cow's metabolic weight, and is expressed as an index above or below 100.

These efficiency measures are best used as indicators of where an animal is relative to others, rather than directly for selection. For example, if we see an animal with a low efficiency, we would look at the actual calf and cow weights to decide if the calf is too small, or the cow too big for the environment. That in turn will suggest corrective actions. **In general, select for the traits you need to change to make cattle more efficient, and efficiency will be the result.**

After 64 years of this performance selection, we believe our cattle are the most efficient in the industry.

Dam Information

A significant difference with our catalog is the greater amount of information about the dams we provide. Weaning percent and Cow Efficiency are explained above. In addition and next to each sale animal, we give the dam's age when that calf was born, and the dam's actual weight when the calf was weaned last fall. We also provide her progeny averages – the average birth weight, weaning ratio, and yearling ratio, of her calves.



The Bulls

Our bulls are managed in a manner to gain important performance data and information, and equally importantly, to develop and provide our customers with many years of productive service. We have been testing breeding bulls over 50 years, longer than almost any other producer. Our own breeding is based primarily on natural service, not AI, so we see how our bulls work in the pasture. We use bulls raised and managed just this way, with our own cows and heifers, on every kind of terrain, and high in the Bighorn Mountains.

For the first twenty years our bulls were tested at home here in Wyoming. They received some grain, but otherwise grass pasture and dry hay. In 1979 we moved our test to a facility managed by the Kugler family in Cozad, Nebraska, where the bulls got a ration including silage, corn and protein. When we brought our first bulls home from Kuglers' and used them with our own cowherd, we discovered a dramatic increase in libido and breeding performance. The effect of proper

nutrition was apparent, and the bulls would maintain condition and hold up better through the entire breeding season. We have continued managing our bulls at the same facility ever since, and we continue to see the same benefits.

We have since used over 500 of these bulls natural service in our own breeding program, on dry range and in the mountains, and have never had a bull fall out of our program early due to his feeding or testing management. Beckton Julian B571, Lancer F442, Nebula M045, Nebula P707, and all of our other great sires were fed and managed in Cozad. While it is possible to feed bulls improperly under any structure, we would strongly question those who promote the notion of any advantage to "forage-raised" bulls. Every year we see the results and success of our bull management program, and we serve many satisfied customers.



• Bulls •

1 BECKTON EMPEROR X009 E3

1-A 100% # 1383301 Tattoo: BKT0 X009

Birth: 2-9-10
 Beckton Emperor R100
BECKTON EMPEROR U668
 Ref. E
 Beckton Ruth M967 EP
 Beckton Epic K6 S569
BECKTON ROSE U026 EP
 Beckton Rose S118 JT
 Beckton Epic K4 N795
 Beckton Tamara N180 JO
 Beckton Epic KN H110
 Beckton Ruth A905 SG
 Beckton Epic KM M115
 Beckton Sierra N703 LM
 Beckton Jet L P491
 Beckton Rose P340 HR

DAM		Calv.	Ease	BW	WW	YW	Milk	HPG	Stay	Maint.En.
Age	2									
Wt	812	12	-2.8	27	69	23	9	16	0.3	
Prog.BW	57			Marb	+26	REA	+20	Bfat	+05	
WR	102									
YR	115									
Wean Pct.	56%	BWt	WWt	WR	ADG	YWt	YR	Scr.	Fr.	
Cow Eff.	117	57	511	102	4.62	1127	115	34	5.0	

One doesn't often get a Lot 1 bull from a first calf heifer, but we expect great production from our first calf heifers. This Rose mother has delivered. Lot 1 does everything - a huge spread between low birth weight and high yearling weight; large Ribeye and high Marbling; very high Milk and Stayability - a money-making bull for any producer. Note the triple Epic in the pedigree.



Beckton Epic K4 N795, Ref. E-1
Sire of Lot 2 and others

3 BECKTON LEGEND X076 E3

1-A 100% # 1383334 Tattoo: BKT0 X076

Birth: 2-24-10
 Beckton Legend S670
BECKTON LEGEND U331 E2
 Ref. L-7
 Beckton Lana S669 EP
 Beckton Epic KJ J722
BECKTON LARKABA U211 EP
 Beckton Larkaba N643 HR
 Beckton Lancer F442 T
 Beckton Kit F468 JL
 Beckton Epic K4 N795
 Beckton Lana M597 LO
 Beckton Epic K F075
 Beckton Lana F891 JL
 Beckton Herald FJ J776
 Beckton Larkaba J765 CH

DAM		Calv.	Ease	BW	WW	YW	Milk	HPG	Stay	Maint.En.
Age	2									
Wt	900	13	-3.1	23	57	17	6	16	-0.2	
Prog.BW	64			Marb	+54	REA	+22	Bfat	+05	
WR	104									
YR	110									
Wean Pct.	55%	BWt	WWt	WR	ADG	YWt	YR	Scr.	Fr.	
Cow Eff.	115	64	553	104	3.91	1108	110	38	5.5	

A Lancer line bull with very high Marbling and excellent Ribeye, good Milk and Stayability. The 38 cm scrotal is unusually high coming off a first calf heifer, but Larkaba U211 is another heifer producing an outstanding calf on her first go-round. This Marbling EPD is the highest of any bull this year, if you are looking for a sire for a grass-fed beef program.



2 BECKTON EPIC X810 V5

1-A 100% # 1382823 Tattoo: BSF0 X810

Birth: 5-2-10
 Beckton Epic KJ J722
BECKTON EPIC K4 N795
 Ref. E-1
 Beckton Sierra J789 EP
 Beckton Vegas SC H209
BECKTON LANA K093 VG
 Beckton Lana H349 HR
 Beckton Epic K F075
 Beckton Lana F891 JL
 Beckton Epic D404
 Beckton Sierra C157 CL
 Beckton Vegas S F382
 Beckton Lana F268 CT
 Beckton Herald HH E503
 Beckton Lana B269 JL

DAM		Calv.	Ease	BW	WW	YW	Milk	HPG	Stay	Maint.En.
Age	10									
Wt	1280	6	1.5	41	87	15	5	10	5.5	
Prog.BW	82			Marb	+25	REA	+25	Bfat	+03	
WR	118									
YR	114									
Wean Pct.	54%	BWt	WWt	WR	ADG	YWt	YR	Scr.	Fr.	
Cow Eff.	113	86	685	115	4.33	1307	121	37	5.5	

Our #1 bull coming off test, by far - yearling weight 1307 off of dry summer range and high roughage winter ration - nearly 50 pounds higher than any other bull on test. Lana K093 is coming eleven, has never missed, with every calf above average and seven of those calves weaning at 126, 116, 116, 114, 131, 139, 115; followed by yearling ratios of 113, 112, 114, 110, 124, 126, and Lot 2 at 121. High Marbling and Ribeye EPD. X810 is triple Lana in his pedigree.

4 BECKTON JULIAN X321 E4

1-A 100% # 1382993 Tattoo: BSF0 X321

Birth: 3-20-10
 Beckton Julian 7526G
BECKTON JULIAN GG B571
 Ref. J-1
 Bkt Marta 9A13 JL
 Beckton Epic KJ J722
BECKTON LARKABA S299 EP
 Beckton Larkaba D170 JV
 Beckton Julian 6592
 Bkt Belga 6746 GS
 Beckton Julian 7526G
 Bkt Marta 6498 XM
 Beckton Epic KJ J722
 Beckton Sierra J789 EP
 Beckton Javelin RN Z358
 Beckton Larkaba Z257 ZN

DAM		Calv.	Ease	BW	WW	YW	Milk	HPG	Stay	Maint.En.
Age	4									
Wt	955	17	-3.4	25	65	14	9	18	-6.2	
Prog.BW	71			Marb	+32	REA	+23	Bfat	+03	
WR	106									
YR	109									
Wean Pct.	62%	BWt	WWt	WR	ADG	YWt	YR	Scr.	Fr.	
Cow Eff.	131	78	615	103	4.43	1203	111	34	5.5	

Beckton Julian B571 produces one herd bull after another throughout the breed, and Lot 4 is an outstanding specimen. He is one of Mitch's top overall picks from all of our bulls for phenotype. His performance numbers are outstanding across the board - from a super-low Maintenance Energy to very high Marbling, Ribeye and Stayability, and everything in between.

• Bulls •

5 **BECKTON JULIAN X333 H5**
1-A 99% # 1382892 Tattoo: BSF0 X333

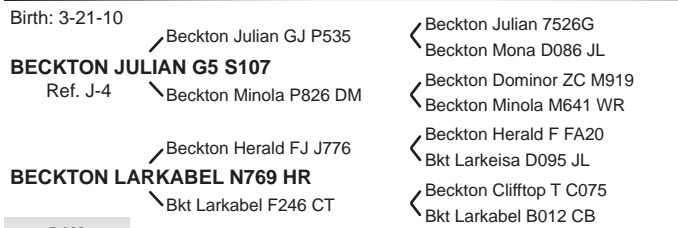

DAM		Calv.Ease	BW	WW	YW	Milk	HPG	Stay	Maint.En.
Age	7	13	-2.1	31	62	15	13	17	-0.9
Wt	1140	Marb +0.06		REA +1.13		Bfat +0.05			
Prog.BW	65	BWt	WWt	WR	ADG	YWt	YR	Scr.	Fr.
WR	102	66	676	114	3.67	1192	110	38	5.0
YR	102								
Wean Pct.	59%								
Cow Eff.	125								

A second of Mitch Ziebell's highest overall picks for phenotype, and in a moderate frame package. His Larkabelle dam has already produced one herd sire for us - Beckton Clifftop U575, Reference Sire C-2 - and this is likely the second, from her three bull calves. Very high for Stayability.



Beckton Julian GG B571, Ref. J-1
Sire of Lots 4, 9, 15, 16, and 77

7 **TR JUBILATION XT009**
1-A 100% # 1369796 Tattoo: TR2A0 XT00

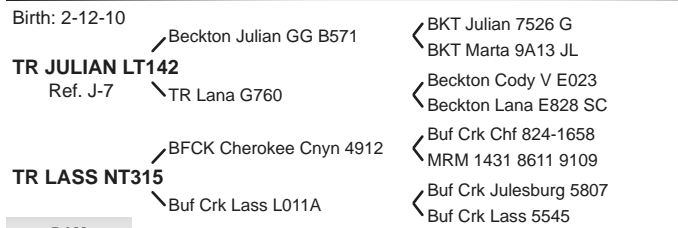

DAM		Calv.Ease	BW	WW	YW	Milk	HPG	Stay	Maint.En.
Age	7	16	-3.0	36	59	15	16	18.2	-5.7
Wt	1265	Marb +0.08		REA +0.52		Bfat +0.02			
Prog.BW	78	BWt	WWt	WR	ADG	YWt	YR	Scr.	Fr.
WR	NA	80	688	108	3.26	1209	108	36	6.0
YR	NA								
Wean Pct.	NA%								
Cow Eff.	NA								

A good year for 009's. Semen of TR Julian LT142 is a very rare commodity so direct sons are hard to find. This son represents his sire well with absolutely top-of-the-breed scores in the maternal traits of calving ease, maintenance, heifer pregnancy, calving ease maternal, and stayability.

8 **TR EPIC XT002**
1-A 100% # 1369858 Tattoo: TR2A0 XT00



DAM		Calv.Ease	BW	WW	YW	Milk	HPG	Stay	Maint.En.
Age	2	9	-1.5	36	65	17	14	12.3	-0.6
Wt	1045	Marb +0.10		REA +0.22		Bfat -0.01			
Prog.BW	78	BWt	WWt	WR	ADG	YWt	YR	Scr.	Fr.
WR	NA	78	674	117	3.15	1178	107	40	5.0
YR	NA								
Wean Pct.	NA%								
Cow Eff.	NA								

This young Epic son shows terrific balance across a multitude of traits with 8 of the 16 published traits in the top 25% of the breed and 13 of 16 in the top 50%. With weaning and yearling ratios of 117 and 107 respectively and a scrotal of 40, he is a great herd bull prospect.

6 **BECKTON LANCER X593 J5**
1-A 100% # 1382910 Tattoo: BSF0 X593

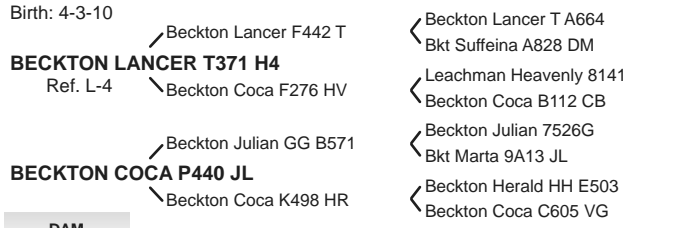

DAM		Calv.Ease	BW	WW	YW	Milk	HPG	Stay	Maint.En.
Age	6	14	-2.9	35	63	12	8	14	-1.3
Wt	1170	Marb +0.00		REA +0.21		Bfat +0.01			
Prog.BW	74	BWt	WWt	WR	ADG	YWt	YR	Scr.	Fr.
WR	106	74	654	110	3.91	1164	108	35	5.0
YR	100								
Wean Pct.	56%								
Cow Eff.	118								

Lot 6 combines two top lines in his pedigree - the great maternal sire Julian B571 on the dam side and the great carcass sire from ABS, Beckton Lancer F442, on the sire side. He is a balanced bull with a nice spread from birth to yearling.



Sue and Forest Dunning
Tongue River Red Angus, 307.750.2454

• Bulls •

9 **TR JULIAN XT001**
1-A 100% # 1369780 Tattoo: TR2A0 XT00

Birth: 2-17-10
 Beckton Julian 7526G
BECKTON JULIAN GG B571
 Ref. J-1
 Bkt Marta 9A13 JL
 Beckton Clipper JM A124
BECKTON TAMARA G760 CL
 Beckton Tamara D727 LN
 Beckton Julian 6592
 Bkt Belga 6746 GS
 Beckton Julian 7526G
 Bkt Marta 6498 XM
 Beckton Clipper J 9956
 Beckton Mona 9766 MJ
 Beckton Lancer T A664
 Beckton Tamara Z909 SN

DAM		Calv.Ease	BW	WW	YW	Milk	HPG	Stay	Maint.En.
Age	13	21	-5.0	23	48	19	15	16.4	-2.8
Wt	1400								
Prog.BW	77								
WR	NA								
YR	NA								
Wean Pct.NA%	NA								
Cow Eff.	NA								
		Marb	+0.00		REA	+0.20		Bfat	+0.02
		BWt	75	WWt	593	WR	NA	ADG	3.37
		YWt		YR	1133	NA	42	Scr.	5.5
		Fr.							

A rare own son of Beckton Julian B571, this bull has all the great attributes of his famous sire, scoring in the very top 5% of the breed for calving ease, low maintenance, heifer pregnancy, maternal calving ease, and stayability.

11 **BECKTON LANCER X215 C5**
1-A 100% # 1382814 Tattoo: BSF0 X215

Birth: 3-15-10
 Beckton Lancer F442 T
BECKTON LANCER T371 H4
 Ref. L-4
 Beckton Coca F276 HV
 Beckton Copper JT G095
BECKTON BARMAID J012 CO
 Beckton Barmaid G565 LN
 Beckton Lancer T A664
 Bkt Suffeina A828 DM
 Leachman Heavenly 8141
 Beckton Coca B112 CB
 Beckton Copper J E616
 Beckton Ruth E549 TP
 Beckton Lancer T A664
 Bkt Barmaid 9517 RN

DAM		Calv.Ease	BW	WW	YW	Milk	HPG	Stay	Maint.En.
Age	11	9	-2.4	25	62	16	7	17	-5.5
Wt	1010								
Prog.BW	71								
WR	103								
YR	108								
Wean Pct.	59%								
Cow Eff.	125								
		Marb	+0.21		REA	+0.02		Bfat	+0.01
		BWt	82	WWt	620	WR	104	ADG	4.62
		YWt		YR	1210	112	39	Scr.	5.5
		Fr.							

X215's dam is a mother cow that would be proud in any herd. She is coming on twelve; never missed a calf; raising all those calves to an average yearling ratio of 108, while she only weighs 1010 pounds. Super efficiency and low maintenance.



12 **BECKTON HERITAGE X327 H2**
1-A 100% # 1382796 Tattoo: BKT0 X327

Birth: 3-20-10
 Beckton Hustler C2 L079
BECKTON HERITAGE N013
 Ref. H-1
 Beckton Lana L007 JL
 Beckton Hawk P248
BECKTON BELGA S166 HW
 Beckton Belga P443 JO
 Beckton Hustler CN J102
 Beckton Barmaid J012 CO
 Beckton Julian G1 J526
 Beckton Lana J790 EP
 Beckton Hustler C2 L079
 Beckton Lana L498 CO
 Beckton Julio L233
 Beckton Belga K117 LN

DAM		Calv.Ease	BW	WW	YW	Milk	HPG	Stay	Maint.En.
Age	4	14	-4.3	33	66	12	8	14	-2.4
Wt	1030								
Prog.BW	60								
WR	107								
YR	105								
Wean Pct.	62%								
Cow Eff.	130								
		Marb	+0.35		REA	-0.06		Bfat	+0.03
		BWt	70	WWt	656	WR	110	ADG	4.29
		YWt		YR	1209	112	40	Scr.	6.0
		Fr.							

A herd bull prospect from another great female line. The dam Belga S166 and granddam Belga P443 both have progeny averages of 107 for weaning ratio and 105-106 for yearling ratio. A low maintenance herd sire prospect with solid growth potential and an excellent scrotal.

10 **TR RICARDO XT022**
1-A 100% # 1369829 Tattoo: TR2A0 XT02

Birth: 3-15-10
 Bfck Cherokee Cnyn 4912
TR RICARDO RT574
 Ref. C-3
 TR Dyna LT111
 TR Julian LT151
TR LANA ST685
 Buf Crk Chf 824-1658
 MRM 1431 8611 9109
 Beckton Julian GG B571
 BSF Dyna JT976
 Beckton Julian GG B571
 MS Geometric 917

DAM		Calv.Ease	BW	WW	YW	Milk	HPG	Stay	Maint.En.
Age	4	13	-2.7	35	67	16	12	14.8	-1.2
Wt	1300								
Prog.BW	71								
WR	NA								
YR	NA								
Wean Pct.NA%	NA								
Cow Eff.	NA								
		Marb	+0.22		REA	+0.36		Bfat	+0.02
		BWt	90	WWt	741	WR	116	ADG	3.29
		YWt		YR	1267	113	42	Scr.	6.0
		Fr.							

This TR Ricardo son has been top-of-the-line for balanced traits and carcass with 7 of the 16 traits in the top 25%. His ratios of 116 for weaning and 113 for yearling together with a huge 42 scrotal make him herd bull material.

13 **BECKTON NEBULA X270 W3**
1-A 99% # 1382860 Tattoo: BSF0 X270

Birth: 3-17-10
 Beckton Nebula M045
BECKTON NEBULA T269 E2
 Ref. N-8
 Beckton Ruth M967 EP
 Beckton Warrior T C371
BECKTON FREYJA M659 WR
 Beckton Freyja B572 JL
 Beckton Neptune R2 K065
 Beckton Belga K285 JL
 Beckton Epic KN H110
 Beckton Ruth A905 SG
 JKG Chiefton L303
 Beckton Tamla A671 TR
 Beckton Julian GN 9A45
 Bkt Freyja 8039 JV

DAM		Calv.Ease	BW	WW	YW	Milk	HPG	Stay	Maint.En.
Age	8	8	-0.3	26	60	17	11	14	-6.8
Wt	1060								
Prog.BW	77								
WR	104								
YR	103								
Wean Pct.	55%								
Cow Eff.	116								
		Marb	+0.17		REA	+0.08		Bfat	+0.03
		BWt	90	WWt	583	WR	101	ADG	4.33
		YWt		YR	1157	107	36	Scr.	5.5
		Fr.							

Nebula X270 is a very low maintenance EPD herd sire prospect with strong growth, milk and carcass EPD's. He was one of Mitch Ziebell's high picks for phenotype as well.

• Bulls •

14 BECKTON NEBULA X038 N4

1-A 100% # 1383395 Tattoo: BKT0 X038

Birth: 2-16-10
 Beckton Nebula P P707
BECKTON NEBULA U206 V3
 Ref. N-12 Beckton Minerva J615 VG
 Beckton Nebula M045
 Beckton Lana M809 EP
 Beckton Vegas PK F485
 Beckton Minerva F433 VG
 Beckton Nebula M045
 Beckton Lana M809 EP
BKT PINE MARIE U621 NB
 Beckton Nebula P P707
 BKT Pine Marie P475 LN
 Beckton Lancer T4 J536
 Bkt Pine Marie LC30 CD

DAM		Calv.Ease	BW	WW	YW	Milk	HPG	Stay	Maint.En.
Age	2	14	-3.7	33	71	19	9	13	-5.9
Wt	880	Marb +0.28		REA +0.12		Bfat +0.01			
Prog.BW	64	BWt	WWt	WR	ADG	YWt	YR	Scr.	Fr.
WR	104	64	552	104	4.24	1090	108	35	5.0
YR	108								
Wean Pct.	56%								
Cow Eff.	118								

One of the biggest spreads from low birth weight and high calving ease, to high yearling weight, and with very good Marbling, Ribeye, Milk, plus exceptionally low maintenance energy EPD - one of the best in the sale. This Nebula is another good potential herd sire coming out of a first calf heifer.

17 BECKTON LANCER X209 J5

1-A 100% # 1382723 Tattoo: BKT0 X209

Birth: 3-14-10
 Beckton Lancer F442 T
BECKTON LANCER T371 H4
 Ref. L-4 Beckton Coca F276 HV
 Beckton Lancer T A664
 Bkt Suffeina A828 DM
 Leachman Heavenly 8141
 Beckton Coca B112 CB
 Beckton Justice C K449
 Beckton Ruth K802 HD
 Beckton Justice C K449
 Beckton Justice C K449
 Beckton Sheba M054 JC
 Beckton Sheba K206 JC

DAM		Calv.Ease	BW	WW	YW	Milk	HPG	Stay	Maint.En.
Age	6	12	-2.0	38	74	9	9	13	-4.3
Wt	1005	Marb +0.12		REA +0.15		Bfat -0.01			
Prog.BW	78	BWt	WWt	WR	ADG	YWt	YR	Scr.	Fr.
WR	104	74	647	109	4.29	1209	112	35	5.5
YR	105								
Wean Pct.	64%								
Cow Eff.	136								

★★★★★ for Low Maintenance, Growth, Gainability, Marbling, Rib-eye area, Superior Cow, High Cow Efficiency, Calving Ease, Stayability.

15 BECKTON JULIAN X337 L4

1-A 100% # 1382774 Tattoo: BKT0 X337

Birth: 3-21-10
 Beckton Julian 7526G
BECKTON JULIAN GG B571
 Ref. J-1 Bkt Marta 9A13 JL
 Beckton Lancer T6 M467
BECKTON ROSE R711 LN
 Beckton Rose L311 LN
 Beckton Julian 6592
 Bkt Belga 6746 GS
 Beckton Julian 7526G
 Bkt Marta 6498 XM
 Beckton Lancer TL G626
 Beckton Lana C735 TP
 Beckton Lancer F442 T
 Beckton Rose H292 HD

DAM		Calv.Ease	BW	WW	YW	Milk	HPG	Stay	Maint.En.
Age	5	20	-5.4	23	53	19	11	18	-4.7
Wt	1115	Marb +0.12		REA +0.25		Bfat +0.01			
Prog.BW	61	BWt	WWt	WR	ADG	YWt	YR	Scr.	Fr.
WR	101	70	578	97	2.95	1091	101	37	5.0
YR	101								
Wean Pct.	52%								
Cow Eff.	109								

This B571 son amplifies the maternal traits of his Julian sire. Super high calving ease EPD of +20; super-low maintenance energy EPD of -5; very high Milk and Stayability; and with good scrotal, good Marbling and Ribeye, and a nice phenotype.



16 BECKTON JULIAN X467 N4

1-A 99% # 1383228 Tattoo: BKT0 X467

Birth: 3-27-10
 Beckton Julian 7526G
BECKTON JULIAN GG B571
 Ref. J-1 Bkt Marta 9A13 JL
 Beckton Nebula M045
BECKTON LANA T311 NB
 Beckton Lana N163 JL
 Beckton Julian 6592
 Bkt Belga 6746 GS
 Beckton Julian 7526G
 Bkt Marta 6498 XM
 Beckton Neptune R2 K065
 Beckton Belga K285 JL
 Beckton Julian 7526G
 Beckton Lana K052 VG

DAM		Calv.Ease	BW	WW	YW	Milk	HPG	Stay	Maint.En.
Age	3	19	-3.7	34	68	12	14	19	-1.2
Wt	1100	Marb +0.14		REA +0.18		Bfat +0.03			
Prog.BW	72	BWt	WWt	WR	ADG	YWt	YR	Scr.	Fr.
WR	103	70	596	103	4.38	1123	103	35	5.0
YR	103								
Wean Pct.	51%								
Cow Eff.	106								

This B571 son has exceptional calving ease, near the very top of the breed, and with very good weaning and yearling EPD's. The carcass EPD's are very solid, and Stayability also close to the top of the breed. The Lana's are fertile, productive females, with the dam's record shown and the granddam Lana N163 weaning all of her six calves in the top third of the herd.

18 BECKTON NEBULA X253 H4

1-A 100% # 1382647 Tattoo: BKT0 X253

Birth: 3-16-10
 Beckton Nebula P P707
BECKTON NEBULA PJ S543
 Ref. N-6 Beckton Lana P685 JO
 Beckton Nebula M045
 Beckton Lana M809 EP
 Beckton Julio L233
 Beckton Lana E083 CD
 Beckton Herald H B463
 Beckton Serena B025 HV
 BJR Topper 5241
 Beckton Minola B168 SC

DAM		Calv.Ease	BW	WW	YW	Milk	HPG	Stay	Maint.En.
Age	11	13	-3.7	34	78	13	5	12	-0.6
Wt	1195	Marb +0.12		REA -0.08		Bfat -0.01			
Prog.BW	74	BWt	WWt	WR	ADG	YWt	YR	Scr.	Fr.
WR	103	85	639	107	4.57	1267	117	35	5.5
YR	104								
Wean Pct.	52%								
Cow Eff.	109								

★★★★★ for Low Maintenance, Growth, Gainability, Marbling, Calving Ease.

• Bulls •

19 BECKTON EMPEROR X160 A3

1-A 100% # 1382669 Tattoo: BKT0 X160

Birth: 3-11-10
 Beckton Emperor R100
BECKTON EMPEROR T641 E2
 Ref. E-5
 Beckton Vernice R416 EP
 Beckton Epic K4 N795
 Beckton Tamara N180 JO
 Beckton Epic K3 M606
 Beckton Vernice K482 HD
 Beckton Cody K G701
 Beckton Cody C401
 Beckton Christy B007 KR
BECKTON LANA L923 CD
 Beckton Lana D232 HV
 Beckton Herald D B437
 Beckton Lana B354 KR

DAM		Calv.Ease	BW	WW	YW	Milk	HPG	Stay	Maint.En.
Age	9	10	-1.5	32	69	18	6	12	2.9
Wt	1180	Marb +0.05		REA +0.14		Bfat +0.00			
Prog.BW	67	BWt	WWt	WR	ADG	YWt	YR	Scr.	Fr.
WR	100	80	630	106	3.86	1178	109	34	5.5
YR	103								
Wean Pct.	53%								
Cow Eff.	112								

★★★★★ for Low Maintenance, Growth, Rib-eye area, Calving Ease.

22 BECKTON JET X080 J3

1-A 100% # 1383100 Tattoo: BSF0 X080

Birth: 2-24-10
 Beckton Jet L P491
BECKTON JET U473 L2
 Ref. J-5
 Beckton Lydia N047 LM
 TR Julian LT151
 Beckton Minerva L278 LN
 Beckton Laramie L044
 Beckton Lydia L647 JL
 Beckton Justice CH M056
 Beckton Tamara J124 HR
BECKTON TAMARA U249 JC
 Beckton Tamara M823 LN
 Beckton Tamara F269 CH

DAM		Calv.Ease	BW	WW	YW	Milk	HPG	Stay	Maint.En.
Age	2	12	-2.0	34	75	23	9	16	4.0
Wt	970	Marb +0.17		REA +0.24		Bfat +0.04			
Prog.BW	66	BWt	WWt	WR	ADG	YWt	YR	Scr.	Fr.
WR	109	66	582	109	4.00	1149	114	40	6.0
YR	114								
Wean Pct.	54%								
Cow Eff.	113								

★★★★★ for Low Maintenance, Growth, Gainability, Marbling, Rib-eye area, Superior Cow, Calving Ease, Stayability.

20 BECKTON NEBULA X307 L2

1-A 100% # 1382718 Tattoo: BKT0 X307

Birth: 3-19-10
 Beckton Neptune R2 K065
BECKTON NEBULA M045
 Ref. N-1
 Beckton Belga K285 JL
 Beckton Neptune RR B284
 Beckton Lana C735 TP
 Beckton Julian GG B571
 Beckton Belga G493 HR
 Beckton Lancer T4 J536
 Beckton Lancer TZ D525
 Beckton Vernice D121 VG
BECKTON EMERA P378 LN
 Beckton Emera L405 WR
 Beckton Warrior C C355
 Beckton Emera D880 CB

DAM		Calv.Ease	BW	WW	YW	Milk	HPG	Stay	Maint.En.
Age	6	16	-4.5	31	67	13	11	11	-4.3
Wt	1100	Marb +0.13		REA -0.17		Bfat +0.02			
Prog.BW	68	BWt	WWt	WR	ADG	YWt	YR	Scr.	Fr.
WR	105	70	643	108	3.67	1187	110	35	5.5
YR	102								
Wean Pct.	58%								
Cow Eff.	123								

★★★★★ for Low Maintenance, Growth, Marbling, High Cow Efficiency, Calving Ease.



21 BECKTON LANCER X488 L5

1-A 100% # 1382658 Tattoo: BKT0 X488

Birth: 3-28-10
 Beckton Lancer F442 T
BECKTON LANCER T371 H4
 Ref. L-4
 Beckton Coca F276 HV
 Beckton Lancer T4 J536
BECKTON ROSE L083 LN
 Beckton Rose J152 LN
 Beckton Lancer T A664
 Bkt Suffeina A828 DM
 Leachman Heavenly 8141
 Beckton Coca B112 CB
 Beckton Lancer TZ D525
 Beckton Vernice D121 VG
 Beckton Lancer TZ D525
 Beckton Rose D379 CB

DAM		Calv.Ease	BW	WW	YW	Milk	HPG	Stay	Maint.En.
Age	9	12	-3.1	26	56	14	6	14	-3.5
Wt	1110	Marb +0.12		REA +0.00		Bfat +0.02			
Prog.BW	69	BWt	WWt	WR	ADG	YWt	YR	Scr.	Fr.
WR	103	77	655	110	4.10	1204	111	39	5.5
YR	100								
Wean Pct.	59%								
Cow Eff.	124								

★★★★★ for Low Maintenance, Gainability, Marbling, High Cow Efficiency, Calving Ease, Stayability.

23 BECKTON JULES X242 J2

1-A 100% # 1382875 Tattoo: BSF0 X242

Birth: 3-16-10
 Beckton Julian G1 J526
BECKTON JULES L429
 Ref. J-2
 Beckton Barona J591 EP
 Beckton Julian GG B571
 Beckton Annie F743 LN
 Beckton Epic K F075
 Beckton Barona E134 RN
 Beckton Julian GG B571
 Bkt Vernice 9733 PC
BECKTON LANA N291 JC
 Beckton Lana H725 CH
 Beckton Champ RK E121
 Beckton Lana E937 NM

DAM		Calv.Ease	BW	WW	YW	Milk	HPG	Stay	Maint.En.
Age	7	13	-2.7	34	60	12	12	16	-1.2
Wt	1270	Marb +0.17		REA +0.11		Bfat +0.04			
Prog.BW	74	BWt	WWt	WR	ADG	YWt	YR	Scr.	Fr.
WR	107	82	684	115	3.57	1139	105	36	5.5
YR	103								
Wean Pct.	54%								
Cow Eff.	113								

★★★★★ for Low Maintenance, Marbling, Superior Cow, Calving Ease, Stayability.

• Bulls •



26 **BECKTON LOKI X170 L4**
1-A 100% # 1382681 Tattoo: BKT0 X170

Birth: 3-11-10
 Beckton Loki C M740
 Beckton Loki F251
 BKT Larkeisa J051 CK
BECKTON LOKI CL S284
 Ref. L-2 Beckton Lakme J460 LT
 Beckton Latigo G714
 Beckton Lakme G128 HD
 Beckton Lancer T A664
 Bkt Suffeina A828 DM
BECKTON LANA M621 LN
 Beckton Lancer F442 T
 Beckton Lana H329 HD
 Beckton Hadrian FH E143
 Beckton Lana D288 VG

DAM		Calv.Ease	BW	WW	YW	Milk	HPG	Stay	Maint.En.
Age	8	12	-2.7	31	60	13	5	14	1.4
Wt	1085								
Prog.BW	75								
WR	101								
YR	102								
Wean Pct.	58%								
Cow Eff.	121								
		BWt	WWt	WR	ADG	YWt	YR	Scr.	Fr.
		77	626	105	3.43	1115	103	37	5.5

★★★★★ for Low Maintenance, Rib-eye area, High Cow Efficiency, Calving Ease, Stayability.

24 **BECKTON NEBULA X188 J3**
1-A 99% # 1382730 Tattoo: BKT0 X188

Birth: 3-12-10
 Beckton Nebula M045
 Beckton Neptune R2 K065
 Beckton Belga K285 JL
BECKTON NEBULA T269 E2
 Ref. N-8 Beckton Ruth M967 EP
 Beckton Epic KN H110
 Beckton Ruth A905 SG
 Beckton Julio L233
 Beckton Julian G1 J526
 Beckton Rose J725 EP
BECKTON COCA P843 JO
 Beckton Coca J487 WH
 Beckton Washaki G272
 Beckton Coca G488 WR

DAM		Calv.Ease	BW	WW	YW	Milk	HPG	Stay	Maint.En.
Age	6	10	-1.4	25	53	13	10	14	-7.0
Wt	1025								
Prog.BW	71								
WR	98								
YR	96								
Wean Pct.	58%								
Cow Eff.	122								
		BWt	WWt	WR	ADG	YWt	YR	Scr.	Fr.
		84	595	99	4.00	1120	101	35	5.5

★★★★★ for Low Maintenance, Gainability, Marbling, High Cow Efficiency, Calving Ease, Stayability.

27 **BECKTON WARRIOR X373 C6**
1-A 100% # 1382659 Tattoo: BKT0 X373

Birth: 3-22-10
 Beckton Warrior N645 T1
 Beckton Warrior T1 H281
 Beckton Rose H074 EP
BECKTON WARRIOR T248 L5
 Ref. W-2 Beckton Kit R503 LN
 Beckton Lancer F442 T
 Beckton Kit F468 JL
 Bkt Clifftop TV G672
 Beckton Mona G569 CS
BECKTON TAMARA L132 CT
 Beckton Tamara J201 CH
 Beckton Champ RK E121
 Beckton Tamara D359 SC

DAM		Calv.Ease	BW	WW	YW	Milk	HPG	Stay	Maint.En.
Age	9	8	-0.6	30	59	16	11	15	-3.6
Wt	1125								
Prog.BW	77								
WR	108								
YR	107								
Wean Pct.	59%								
Cow Eff.	125								
		BWt	WWt	WR	ADG	YWt	YR	Scr.	Fr.
		87	668	112	3.38	1144	106	42	5.5

★★★★★ for Low Maintenance, Superior Cow, High Cow Efficiency, Calving Ease, Stayability.

25 **BECKTON LANCER X185 C5**
1-A 100% # 1383168 Tattoo: BKT0 X185

Birth: 3-12-10
 Beckton Lancer F442 T
 Beckton Lancer T A664
 Bkt Suffeina A828 DM
BECKTON LANCER T371 H4
 Ref. L-4 Beckton Coca F276 HV
 Leachman Heavenly 8141
 Beckton Coca B112 CB
 Beckton Clifftop T3 N800
 Bkt Clifftop TV G672
 Beckton Lana J384 CD
BECKTON TAMARA S729 CT
 Beckton Epic KJ J722
 Beckton Tamara HA73 CH

DAM		Calv.Ease	BW	WW	YW	Milk	HPG	Stay	Maint.En.
Age	4	12	-2.5	25	53	15	4	12	0.5
Wt	1090								
Prog.BW	65								
WR	105								
YR	105								
Wean Pct.	55%								
Cow Eff.	115								
		BWt	WWt	WR	ADG	YWt	YR	Scr.	Fr.
		73	617	104	3.76	1135	105	38	5.5

★★★★★ for Low Maintenance, Marbling, Superior Cow, Calving Ease.

28 **BECKTON DOMINOR X421 E5**
1-A 100% # 1383259 Tattoo: BKT0 X421

Birth: 3-25-10
 Beckton Dominor ZC M919
 Beckton Dominor Z E401
 Beckton Barmaid J012 CO
BECKTON DOMINOR Z1 R610
 Ref. D-1 Beckton Sierra K557 LO
 Beckton Loki F251
 Beckton Sierra C157 CL
 Beckton Epic K F075
 Beckton Minerva F495 CH
BKT BAYBERRY T519 EP
 Bkt Bayberry LC31 SC
 Beckton Scamp TR FB22
 Bkt Bayberry D736 GL

DAM		Calv.Ease	BW	WW	YW	Milk	HPG	Stay	Maint.En.
Age	3	11	-2.1	35	74	20	8	15	1.7
Wt	1010								
Prog.BW	65								
WR	109								
YR	103								
Wean Pct.	63%								
Cow Eff.	133								
		BWt	WWt	WR	ADG	YWt	YR	Scr.	Fr.
		76	677	118	4.05	1180	111	35	6.0

★★★★★ for Low Maintenance, Growth, Gainability, Marbling, High Cow Efficiency, Calving Ease, Stayability.

• Bulls •

29 **BECKTON EPIC X344 H5**
1-A 100% # 1382914 Tattoo: BSF0 X344

Birth: 3-21-10
 Beckton Epic KJ J722
BECKTON EPIC K4 N795
 Ref. E-1
 Beckton Sierra J789 EP
 Beckton Epic K F075
 Beckton Lana F891 JL
 Beckton Epic D404
 Beckton Sierra C157 CL
 Beckton Champ RH F275
 Beckton Lana F138 LN
 Beckton Julian 7526G
 Beckton Mona E524 JL
BECKTON MONA P539 CH
 Beckton Champ R1 H024
 Beckton Mona H298 JL

DAM		Calv.Ease	BW	WW	YW	Milk	HPG	Stay	Maint.En.
Age	6	10	-1.2	33	75	12	6	14	3.9
Wt	1190								
Prog.BW	69								
WR	97		Marb	+0.24	REA	+0.17	Bfat	+0.03	
YR	101								
Wean Pct.	51%	BWt	WWt	WR	ADG	YWt	YR	Scr.	Fr.
Cow Eff.	108	75	609	102	4.38	1188	107	34	5.5

★★★★★ for Low Maintenance, Growth, Gainability, Marbling, Rib-eye area, Calving Ease, Stayability.



31 **BECKTON EPIC X285 L5**
1-A 100% # 1382689 Tattoo: BKT0 X285

Birth: 3-18-10
 Beckton Epic KJ J722
BECKTON EPIC K4 N795
 Ref. E-1
 Beckton Sierra J789 EP
 Beckton Epic K F075
 Beckton Lana F891 JL
 Beckton Epic D404
 Beckton Sierra C157 CL
 Beckton Lancer T4 J536
 Beckton Sierra J659 DM
 Beckton Vegas SC H209
 Beckton Ruth G534 NP
BECKTON RUTH N010 LM
 Beckton Laramie L044
 Beckton Ruth L277 VG

DAM		Calv.Ease	BW	WW	YW	Milk	HPG	Stay	Maint.En.
Age	7	6	0.2	33	72	17	5	12	3.2
Wt	955								
Prog.BW	75								
WR	99		Marb	+0.28	REA	+0.11	Bfat	+0.05	
YR	106								
Wean Pct.	65%	BWt	WWt	WR	ADG	YWt	YR	Scr.	Fr.
Cow Eff.	137	88	620	104	3.38	1137	105	37	5.5

★★★★★ for Low Maintenance, Growth, Marbling, High Cow Efficiency.

32 **BECKTON LOKI X341 J4**
1-A 100% # 1382725 Tattoo: BKT0 X341

Birth: 3-21-10
 Beckton Loki C M740
BECKTON LOKI CL S284
 Ref. L-2
 Beckton Lakme J460 LT
 Beckton Julian GG B571
BECKTON LARKABA P645 JL
 Beckton Larkaba L312 LN
 Beckton Loki F251
 BKT Larkeisa J051 CK
 Beckton Latigo G714
 Beckton Lakme G128 HD
 Beckton Julian 7526G
 Bkt Marta 9A13 JL
 Beckton Lancer TL G626
 Beckton Larkaba G311 CT

DAM		Calv.Ease	BW	WW	YW	Milk	HPG	Stay	Maint.En.
Age	6	20	-7.1	23	52	15	7	16	-1.0
Wt	1085								
Prog.BW	60								
WR	100		Marb	+0.20	REA	+0.16	Bfat	+0.01	
YR	102								
Wean Pct.	58%	BWt	WWt	WR	ADG	YWt	YR	Scr.	Fr.
Cow Eff.	122	61	627	105	3.19	1140	105	36	5.5

★★★★★ for Low Maintenance, Marbling, Rib-eye area, High Cow Efficiency, Calving Ease, Stayability.

30 **BECKTON RANGER X377 L4**
1-A 100% # 1382708 Tattoo: BKT0 X377

Birth: 3-22-10
 Beckton Ranger 9479R
BECKTON RANGER T603 H3
 Ref. R-1
 Beckton Rose N044 HU
 Beckton Loki C M740
BECKTON INDIGO P043 LO
 Beckton Indigo M571 EP
 Beckton Ranger 7003
 Beckton Eola 7470 RZ
 Beckton Hustler C2 L079
 Beckton Rose L669 JL
 Beckton Loki F251
 BKT Larkeisa J051 CK
 Beckton Epic K F075
 Beckton Indigo C106 LN

DAM		Calv.Ease	BW	WW	YW	Milk	HPG	Stay	Maint.En.
Age	6	10	-2.1	25	58	11	7	12	-1.1
Wt	1165								
Prog.BW	76								
WR	107		Marb	+0.19	REA	-0.18	Bfat	+0.02	
YR	105								
Wean Pct.	51%	BWt	WWt	WR	ADG	YWt	YR	Scr.	Fr.
Cow Eff.	106	77	588	102	3.86	1146	106	41	5.5

★★★★★ for Low Maintenance, Marbling, Superior Cow, Calving Ease.

33 **BECKTON JUSTICE X173 J4**
1-A 100% # 1382687 Tattoo: BKT0 X173

Birth: 3-12-10
 Beckton Justice C K449
BECKTON JUSTICE CE R599
 Ref. J
 Beckton Belga M050 EP
 Beckton Justice G302
BECKTON MAIATA M854 JC
 Beckton Maiata C997 CB
 Beckton Justice G302
 Bkt Larkabel C742 CF
 Beckton Epic K1 K863
 Beckton Belga K588 HD
 Beckton Julian GG B571
 Bkt Vernice 9733 PC
 Beckton Cobalt K Z100
 BchRchLilo 333K35L444

DAM		Calv.Ease	BW	WW	YW	Milk	HPG	Stay	Maint.En.
Age	8	9	-0.5	39	70	10	13	13	-4.8
Wt	1100								
Prog.BW	73								
WR	101		Marb	+0.07	REA	+0.17	Bfat	-0.01	
YR	100								
Wean Pct.	59%	BWt	WWt	WR	ADG	YWt	YR	Scr.	Fr.
Cow Eff.	124	90	650	109	3.62	1150	106	35	5.5

★★★★★ for Low Maintenance, Growth, Rib-eye area, High Cow Efficiency, Calving Ease, Stayability.

• Bulls •



34 BECKTON EMPEROR X224 L3
1-A 100% # 1382676 Tattoo: BKT0 X224

Birth: 3-15-10
 Beckton Emperor R100
 Beckton Epic K4 N795
 Beckton Tamara N180 JO
BECKTON EMPEROR T641 E2
 Ref. E-5
 Beckton Vernice R416 EP
 Beckton Epic K3 M606
 Beckton Vernice K482 HD
 Beckton Lancer F442 T
 Beckton Lancer T A664
 Bkt Suffeina A828 DM
BECKTON LANA M167 LN
 Beckton Lana J384 CD
 Beckton Cody K G701
 Beckton Lana G514 CD

DAM		Calv.Ease	BW	WW	YW	Milk	HPG	Stay	Maint.En.
Age	8	14	-4.2	27	52	15	4	14	0.2
Wt	1095	Marb +0.15		REA +0.31		Bfat +0.01			
Prog.BW	67	BWt	WWt	WR	ADG	YWt	YR	Scr.	Fr.
WR	101	61	624	105	3.76	1112	103	37	5.5
YR	98								
Wean Pct.	57%								
Cow Eff.	120								

★★★★★ for Low Maintenance, Marbling, Rib-eye area, High Cow Efficiency, Calving Ease, Stayability.

35 BECKTON NEBULA X286 C3
1-A 99% # 1382716 Tattoo: BKT0 X286

Birth: 3-18-10
 Beckton Nebula M045
 Beckton Neptune R2 K065
 Beckton Belga K285 JL
BECKTON NEBULA T269 E2
 Ref. N-8
 Beckton Ruth M967 EP
 Beckton Epic KN H110
 Beckton Ruth A905 SG
 Beckton Cruiser K118
 Beckton Clipper K1 H772
 Beckton Lana H329 HD
BECKTON EOLA P336 CE
 Beckton Eola C611 SC
 Beckton Scamp T A825
 Beckton Eola A746 PC

DAM		Calv.Ease	BW	WW	YW	Milk	HPG	Stay	Maint.En.
Age	6	13	-2.7	20	47	16	12	11	-5.4
Wt	1045	Marb +0.02		REA +0.10		Bfat +0.03			
Prog.BW	64	BWt	WWt	WR	ADG	YWt	YR	Scr.	Fr.
WR	105	73	577	100	4.10	1115	104	35	5.5
YR	103								
Wean Pct.	55%								
Cow Eff.	116								

★★★★★ for Low Maintenance, Gainability, High Cow Efficiency, Calving Ease.

37 BECKTON EPIC X456 H6
1-A 100% # 1382891 Tattoo: BSF0 X456

Birth: 3-26-10
 Beckton Epic K4 N795
 Beckton Epic KJ J722
 Beckton Sierra J789 EP
BECKTON EPIC T330 L5
 Ref. E-3
 Beckton Belga K202 LN
 Beckton Lancer T A664
 Beckton Belga D460 KR
 Beckton Herald F1 L151
 Beckton Herald FV J537
 Beckton Christy J474 CO
BECKTON INDIGO N754 HR
 Beckton Indigo LC22 LO
 Beckton Loki F251
 Beckton Indigo E370 RN

DAM		Calv.Ease	BW	WW	YW	Milk	HPG	Stay	Maint.En.
Age	7	12	-3.1	22	60	15	6	13	3.8
Wt	1265	Marb +0.33		REA -0.05		Bfat +0.02			
Prog.BW	67	BWt	WWt	WR	ADG	YWt	YR	Scr.	Fr.
WR	97	74	587	99	3.62	1125	104	36	6.0
YR	103								
Wean Pct.	46%								
Cow Eff.	98								

★★★★★ for Low Maintenance, Marbling, Calving Ease, Stayability.

36 BECKTON JANUS X577 E2
1-A 100% # 1382748 Tattoo: BKT0 X577

Birth: 4-2-10
 TR Romeo NT379
 Buffalo Creek Romeo L081
 Buf Crk Lass L420
BECKTON ROMAN J S158
 Ref. O-1
 Beckton Belga K285 JL
 Beckton Julian GG B571
 Beckton Belga G493 HR
 Beckton Epic KM M115
 Beckton Epic K F075
 Beckton Minerva F495 CH
BKT PINE MARIE R213 EP
 BKT Pine Marie H175 NP
 Beckton Neptune RT Z305
 Bkt Pine Marie D319 VG

DAM		Calv.Ease	BW	WW	YW	Milk	HPG	Stay	Maint.En.
Age	5	12	-1.5	42	71	20	9	13	-1.0
Wt	1065	Marb -0.01		REA +0.22		Bfat -0.01			
Prog.BW	72	BWt	WWt	WR	ADG	YWt	YR	Scr.	Fr.
WR	111	72	690	116	3.62	1164	108	35	5.5
YR	106								
Wean Pct.	65%								
Cow Eff.	136								

★★★★★ for Low Maintenance, Growth, Rib-eye area, Superior Cow, High Cow Efficiency, Calving Ease, Stayability.

38 BECKTON RANGER X361 L4
1-A 100% # 1382915 Tattoo: BSF0 X361

Birth: 3-21-10
 Beckton Ranger 9479R
 Beckton Ranger 7003
 Beckton Eola 7470 RZ
BECKTON RANGER T603 H3
 Ref. R-1
 Beckton Rose N044 HU
 Beckton Hustler C2 L079
 Beckton Rose L669 JL
 Beckton Lancer T7 M089
 Beckton Lancer F442 T
 Beckton Tamara G141 HE
BECKTON MINOLA P596 LN
 Beckton Minola M155 CE
 Beckton Cruiser K118
 Beckton Minola K592 EP

DAM		Calv.Ease	BW	WW	YW	Milk	HPG	Stay	Maint.En.
Age	6	7	-2.1	26	65	13	11	11	-4.3
Wt	1190	Marb -0.04		REA -0.08		Bfat -0.01			
Prog.BW	80	BWt	WWt	WR	ADG	YWt	YR	Scr.	Fr.
WR	109	91	671	113	3.81	1146	106	36	5.5
YR	107								
Wean Pct.	56%								
Cow Eff.	119								

★★★★★ for Low Maintenance, Growth, Superior Cow, High Cow Efficiency, Calving Ease.

• Bulls •

39 BECKTON EPIC X657 N5

1-A 100% # 1382767 Tattoo: BKT0 X657

Birth: 4-9-10

Beckton Epic KJ J722
 Beckton Epic K F075
BECKTON EPIC K4 N795
 Ref. E-1 Beckton Lana F891 JL
 Beckton Sierra J789 EP
 Beckton Epic D404
 Beckton Sierra C157 CL
 Beckton Nebula M045
 Beckton Neptune R2 K065
BECKTON LANA R561 NB
 Beckton Belga K285 JL
 Beckton Lana A634 SC
 Beckton Scamp 8954
 Beckton Lana 8400 RN

DAM		Calv.Ease	BW	WW	YW	Milk	HPG	Stay	Maint.En.
Age	5	11	-1.9	34	70	15	7	12	1.8
Wt	1110								
Prog.BW	66								
WR	108		Marb +.35		REA +.07		Bfat +.06		
YR	106								
Wean Pct.	62%	BWt	WWt	WR	ADG	YWt	YR	Scr.	Fr.
Cow Eff.	130	81	685	115	3.52	1166	108	38	6.0

★★★★★ for Low Maintenance, Growth, Marbling, Superior Cow, High Cow Efficiency, Calving Ease.

42 BSF NEBULA X161 J3

1-B 99% # 1382952 Tattoo: BSF0 X161

Birth: 3-11-10

Beckton Nebula M045
 Beckton Neptune R2 K065
BECKTON NEBULA T269 E2
 Ref. N-8 Beckton Belga K285 JL
 Beckton Ruth M967 EP
 Beckton Epic KN H110
 Beckton Ruth A905 SG
 Beckton Justice C K449
 Beckton Justice G302
BSF JUSTICIA R553 JC
 Bkt Larkabel C742 CF
 BSF Regus L104 LN
 Beckton Lancer F442 T
 BSF Regus J155

DAM		Calv.Ease	BW	WW	YW	Milk	HPG	Stay	Maint.En.
Age	5	11	-2.0	34	76	11	10	13	-4.3
Wt	1175								
Prog.BW	66								
WR	101		Marb +.33		REA +.15		Bfat +.03		
YR	109								
Wean Pct.	50%	BWt	WWt	WR	ADG	YWt	YR	Scr.	Fr.
Cow Eff.	106	81	591	99	4.62	1223	110	39	5.5

★★★★★ for Low Maintenance, Growth, Gainability, Marbling, Rib-eye area, Calving Ease, Stayability.

40 BECKTON NEBULA X187 L4

1-A 100% # 1382834 Tattoo: BSF0 X187

Birth: 3-12-10

Beckton Nebula L P093
 Beckton Nebula M045
BECKTON NEBULA T398 V3
 Ref. N-9 Beckton Marta M021 LN
 Beckton Minerva J615 VG
 Beckton Vegas PK F485
 Beckton Minerva F433 VG
 Beckton Lancer T4 J536
 Beckton Lancer TZ D525
BECKTON FIREFLY L161 LN
 Beckton Vernice D121 VG
 Beckton Firefly J650 CD
 Beckton Cody V E023
 Beckton Firefly E684 NP

DAM		Calv.Ease	BW	WW	YW	Milk	HPG	Stay	Maint.En.
Age	9	13	-3.7	22	47	16	10	13	-2.5
Wt	1175								
Prog.BW	66								
WR	102		Marb +.07		REA -.07		Bfat -.01		
YR	93								
Wean Pct.	52%	BWt	WWt	WR	ADG	YWt	YR	Scr.	Fr.
Cow Eff.	109	68	609	102	3.33	1096	101	39	5.5

★★★★★ for Low Maintenance, Calving Ease, Stayability.

43 BSF EPIC X266 C6

1-B 99% # 1382816 Tattoo: BSF0 X266

Birth: 3-17-10

Beckton Epic KJ J722
 Beckton Epic K4 N795
BECKTON EPIC T330 L5
 Ref. E-3 Beckton Sierra J789 EP
 Beckton Belga K202 LN
 Beckton Lancer T A664
 Beckton Belga D460 KR
 Beckton Copper JT G095
 Beckton Copper J E616
BSF REGUS J082
 Beckton Ruth E549 TP
 BSF Red G218
 Beckton Ranger RS B919
 BSF Regus A027

DAM		Calv.Ease	BW	WW	YW	Milk	HPG	Stay	Maint.En.
Age	11	8	-1.7	29	71	19	6	14	1.9
Wt	890								
Prog.BW	81								
WR	109		Marb +.28		REA +.13		Bfat +.01		
YR	108								
Wean Pct.	72%	BWt	WWt	WR	ADG	YWt	YR	Scr.	Fr.
Cow Eff.	152	81	661	111	3.91	1225	113	35	6.0

★★★★★ for Low Maintenance, Growth, Marbling, Rib-eye area, Superior Cow, High Cow Efficiency, Calving Ease, Stayability.

41 BSF DOMINOR X365 L5

1-B 99% # 1382912 Tattoo: BSF0 X365

Birth: 3-22-10

Beckton Dominor ZC M919
 Beckton Dominor Z E401
BECKTON DOMINOR Z1 R610
 Ref. D-1 Beckton Barmaid J012 CO
 Beckton Sierra K557 LO
 Beckton Loki F251
 Beckton Sierra C157 CL
 Beckton Lancer T1 H080
 Beckton Lancer TN F726
BSF LANETTE P497
 Beckton Belga F657 TP
 BSF Regus B368
 Beckton Nomad V 9871
 BSF Red 8101

DAM		Calv.Ease	BW	WW	YW	Milk	HPG	Stay	Maint.En.
Age	6	11	-2.3	29	68	20	6	12	3.0
Wt	1115								
Prog.BW	80								
WR	125		Marb +.30		REA +.12		Bfat +.04		
YR	117								
Wean Pct.	68%	BWt	WWt	WR	ADG	YWt	YR	Scr.	Fr.
Cow Eff.	143	76	755	131	4.05	1303	121	33	5.5

★★★★★ for Low Maintenance, Growth, Gainability, Marbling, Superior Cow, High Cow Efficiency, Calving Ease.



• Bulls •

44 **BSF EPIC X108 J6**
1-B 99% # 1383063 Tattoo: BSF0 X108

Birth: 3-2-10
 Beckton Epic K4 N795
BECKTON EPIC U749 D5
 Ref. E-8
 Beckton Denise R308 DM
 Beckton Epic KJ J722
 Beckton Sierra J789 EP
 Beckton Dominor ZC M919
 Beckton Denise L639 JL
 TR Romeo NT379
 Beckton Belga K285 JL
 Beckton Hawk P248
 BSF Lanette P804
 Beckton Roman J S158
BSF LANETTE U009 RA
 BSF Lanette S490 HW

DAM		Calv.Ease	BW	WW	YW	Milk	HPG	Stay	Maint.En.
Age	2	12	-1.9	37	78	17	7	14	0.4
Wt	865								
Prog.BW	70								
WR	117								
YR	112								
Wean Pct.	69%								
Cow Eff.	145								
		Marb			REA			Bfat	
		BWt	WWt	WR	ADG	YWt	YR	Scr.	Fr.
		70	657	117	3.91	1176	112	33	6.0

★★★★★ for Low Maintenance, Growth, Marbling, Rib-eye area, Superior Cow, High Cow Efficiency, Calving Ease, Stayability.

47 **BSF WARRIOR X061 W6**
1-B 99% # 1383115 Tattoo: BSF0 X061

Birth: 2-22-10
 Beckton Warrior N645 T1
BECKTON WARRIOR U636 J5
 Ref. W-3
 Beckton Lydia H159 JL
 Beckton Warrior T1 H281
 Beckton Rose H074 EP
 Beckton Julian GG B571
 Beckton Lydia D386 CL
 Beckton Warrior CL M686
 Beckton Christy K101 CD
 Beckton Epic K3 M606
 BSF Regus M057 JC
 Beckton Warrior C1 S337
BSF EPIQUETTE U398 WR
 BSF Epiquette S632 EP

DAM		Calv.Ease	BW	WW	YW	Milk	HPG	Stay	Maint.En.
Age	2	13	-2.0	37	73	11	13	15	1.8
Wt	875								
Prog.BW	68								
WR	112								
YR	110								
Wean Pct.	62%								
Cow Eff.	129								
		Marb			REA			Bfat	
		BWt	WWt	WR	ADG	YWt	YR	Scr.	Fr.
		68	598	112	3.81	1113	110	35	5.5

★★★★★ for Low Maintenance, Growth, Marbling, Rib-eye area, Superior Cow, High Cow Efficiency, Calving Ease, Stayability.

45 **BSF WARRIOR X131 H6**
1-B 99% # 1383419 Tattoo: BKB0 X131

Birth: 3-7-10
 Beckton Warrior N645 T1
BECKTON WARRIOR T248 L5
 Ref. W-2
 Beckton Kit R503 LN
 Beckton Warrior T1 H281
 Beckton Rose H074 EP
 Beckton Lancer F442 T
 Beckton Kit F468 JL
 Beckton Hustler CN J102
 BSF Regus J475
 Beckton Scamp TR FB22
 Bkt Bayberry D736 GL
 BSF Hustler C1 L004
BSF BAYBERRY N137 HU
 Bkt Bayberry LC31 SC

DAM		Calv.Ease	BW	WW	YW	Milk	HPG	Stay	Maint.En.
Age	7	14	-4.5	24	50	15	13	13	-4.8
Wt	1005								
Prog.BW	61								
WR	98								
YR	99								
Wean Pct.	62%								
Cow Eff.	130								
		Marb			REA			Bfat	
		BWt	WWt	WR	ADG	YWt	YR	Scr.	Fr.
		67	621	104	3.71	1121	104	38	5.0

★★★★★ for Low Maintenance, Rib-eye area, High Cow Efficiency, Calving Ease, Stayability.

48 **BSF WARRIOR X271 H6**
1-B 99% # 1382902 Tattoo: BSF0 X271

Birth: 3-17-10
 Beckton Warrior N645 T1
BECKTON WARRIOR T248 L5
 Ref. W-2
 Beckton Kit R503 LN
 Beckton Warrior T1 H281
 Beckton Rose H074 EP
 Beckton Lancer F442 T
 Beckton Kit F468 JL
 Beckton Hustler CN J102
 Beckton Barmaid J012 CO
 Beckton Hadrian A100
 BSF Regus 8183-2
 Beckton Hustler C2 L079
BSF HUSTLE P246
 BSF Regus E323

DAM		Calv.Ease	BW	WW	YW	Milk	HPG	Stay	Maint.En.
Age	6	10	-1.6	32	59	10	13	14	-4.2
Wt	1100								
Prog.BW	72								
WR	103								
YR	102								
Wean Pct.	58%								
Cow Eff.	121								
		Marb			REA			Bfat	
		BWt	WWt	WR	ADG	YWt	YR	Scr.	Fr.
		77	633	106	3.67	1112	103	37	5.5

★★★★★ for Low Maintenance, Rib-eye area, High Cow Efficiency, Calving Ease, Stayability.

46 **BSF LANCER X133 H5**
1-B 87% # 1383418 Tattoo: BKB0 X133

Birth: 3-7-10
 Beckton Lancer F442 T
BECKTON LANCER T371 H4
 Ref. L-4
 Beckton Coca F276 HV
 Beckton Lancer T A664
 Bkt Suffeina A828 DM
 Leachman Heavenly 8141
 Beckton Coca B112 CB
 Beckton Hustler CN J102
 BSF Regus J475
 Beckton Cody C401
 BSF Hustler C1 L004
BSF HELENA N098 HU
 BRU Red LC54

DAM		Calv.Ease	BW	WW	YW	Milk	HPG	Stay	Maint.En.
Age	7	8	.0	36	70	14	8	9	0.3
Wt	1180								
Prog.BW	79								
WR	111								
YR	107								
Wean Pct.	54%								
Cow Eff.	113								
		Marb			REA			Bfat	
		BWt	WWt	WR	ADG	YWt	YR	Scr.	Fr.
		84	633	106	4.38	1171	108	34	5.5

★★★★★ for Low Maintenance, Growth, Gainability, Rib-eye area, Superior Cow, Calving Ease.

49 **BSF EPIC X201 W6**
1-B 99% # 1382589 Tattoo: BSF0 X201

Birth: 3-14-10
 Beckton Epic K7 S583
BECKTON EPIC U126 J5
 Ref. E-7
 Beckton Ruth S076 JT
 Beckton Epic KJ J722
 Beckton Kit F468 JL
 Beckton Jet L P491
 Beckton Ruth P591 LN
 Beckton Warrior T1 H281
 Beckton Rose H074 EP
 Beckton Julian G1 J526
 BSF Regus J082
 Beckton Warrior N645 T1
BSF WENDIE U579 WR
 BSF Regus L009 JL

DAM		Calv.Ease	BW	WW	YW	Milk	HPG	Stay	Maint.En.
Age	2	13	-3.4	30	66	16	10	16	-1.5
Wt	895								
Prog.BW	70								
WR	110								
YR	113								
Wean Pct.	59%								
Cow Eff.	124								
		Marb			REA			Bfat	
		BWt	WWt	WR	ADG	YWt	YR	Scr.	Fr.
		70	588	110	3.95	1144	113	34	5.5

★★★★★ for Low Maintenance, Growth, Marbling, Superior Cow, High Cow Efficiency, Calving Ease, Stayability.

• Bulls •

50 BSF NEBULA X380 J3
1-B 99% # 1383002 Tattoo: BSF0 X380

Birth: 3-23-10
 ↙ Beckton Nebula M045
BECKTON NEBULA T269 E2
 Ref. N-8 ↘ Beckton Ruth M967 EP
 ↙ Beckton Neptune R2 K065
 Beckton Belga K285 JL
 ↙ Beckton Epic KN H110
 Beckton Ruth A905 SG
 ↙ Beckton Julian GG B571
 Bkt Vernice 9733 PC
BSF BUFFIE S394 JC
 ↙ Beckton Justice G302
 ↘ BSF Buffie N856 CO
 ↘ Beckton Copper JT G095
 BSF Regus F207

DAM		Calv.Ease	BW	WW	YW	Milk	HPG	Stay	Maint.En.
Age	4	10	-0.5	35	73	11	11	14	-2.7
Wt	1145								
Prog.BW	71								
WR	99								
YR	102								
Wean Pct.	54%								
Cow Eff.	113								
			Marb		REA			Bfat	
			+0.28		+0.16			+0.05	
		BWt	WWt	WR	ADG	YWt	YR	Scr.	Fr.
		82	635	107	4.38	1171	108	38	5.5

★★★★★ for Low Maintenance, Growth, Gainability, Marbling, Rib-eye area, Calving Ease, Stayability.

52 BSF EPIC X300 J5
1-B 99% # 1382931 Tattoo: BSF0 X300

Birth: 3-19-10
 ↙ Beckton Epic KJ J722
BECKTON EPIC K4 N795
 Ref. E-1 ↘ Beckton Sierra J789 EP
 ↙ Beckton Epic K F075
 Beckton Lana F891 JL
 ↙ Beckton Epic D404
 Beckton Sierra C157 CL
 ↙ Beckton Justice G302
 Bkt Larkabel C742 CF
BSF JUSTICIA R147 JC
 ↙ Beckton Justice C K449
 ↘ BSF Regus J698
 ↘ Beckton Epic K F075
 BSF Regus F492

DAM		Calv.Ease	BW	WW	YW	Milk	HPG	Stay	Maint.En.
Age	5	10	-1.8	36	77	12	6	12	7.2
Wt	1250								
Prog.BW	71								
WR	106								
YR	103								
Wean Pct.	48%								
Cow Eff.	102								
			Marb		REA			Bfat	
			+0.30		+0.20			+0.03	
		BWt	WWt	WR	ADG	YWt	YR	Scr.	Fr.
		78	603	101	3.71	1124	104	37	5.5

★★★★★ for Marbling, Rib-eye area, Calving Ease.



53 BECKTON CHEROKEE X852 W4
1-A 100% # 1382702 Tattoo: BKT0 X852

Birth: 3-27-10
 ↙ Beckton Cherokee N N479
BECKTON CHEROKEE T450 L3
 Ref. C-1 ↘ Beckton Annie M337 LN
 ↙ Beckton Warrior TD L493
 BFKC Cherokee Cryn 4912
 Beckton Dinah C440 NM
 ↙ Beckton Lancer TL G626
 Beckton Annie F743 LN
 ↙ Beckton Warrior T C371
 Bkt Suffeina A828 DM
BKT PINE MARIE N582 WR
 ↘ BKT Pine Marie L650 EP
 ↘ Beckton Epic K F075
 BKT Pine Marie H175 NP

DAM		Calv.Ease	BW	WW	YW	Milk	HPG	Stay	Maint.En.
Age	7	11	-3.0	19	46	11	10	17	-3.1
Wt	1185								
Prog.BW	69								
WR	110								
YR	107								
Wean Pct.	58%								
Cow Eff.	122								
			Marb		REA			Bfat	
			-0.02		+0.18			+0.03	
		BWt	WWt	WR	ADG	YWt	YR	Scr.	Fr.
		NA	687	115	4.14	1231	111	38	5.0

★★★★★ for Low Maintenance, Gainability, Rib-eye area, Superior Cow, High Cow Efficiency, Calving Ease, Stayability.

51 BSF EPIC X030 A6
1-B 99% # 1383064 Tattoo: BSF0 X030

Birth: 2-15-10
 ↙ Beckton Epic K6 S569
BECKTON EPIC U095 E5
 Ref. E-6 ↘ Beckton Lydia S274 EP
 ↙ Beckton Epic KM M115
 Beckton Sierra N703 LM
 ↙ Beckton Epic KM M115
 Beckton Lydia M607 LO
 ↙ Beckton Cody K1 P014
 Beckton Marta P633 JO
BSF JULIA U018 CB
 ↙ Beckton Cobalt S029
 ↘ BSF Julia S423 JO
 ↘ Beckton Julio L233
 BSF Regus H501

DAM		Calv.Ease	BW	WW	YW	Milk	HPG	Stay	Maint.En.
Age	2	12	-2.6	33	73	22	8	19	1.0
Wt	900								
Prog.BW	69								
WR	105								
YR	106								
Wean Pct.	59%								
Cow Eff.	124								
			Marb		REA			Bfat	
			+0.12		+0.00			+0.04	
		BWt	WWt	WR	ADG	YWt	YR	Scr.	Fr.
		69	590	105	4.00	1119	106	37	5.5

★★★★★ for Low Maintenance, Growth, Gainability, Marbling, Superior Cow, High Cow Efficiency, Calving Ease, Stayability.

54 BECKTON LOKI X238 C4
1-A 100% # 1382866 Tattoo: BSF0 X238

Birth: 3-16-10
 ↙ Beckton Loki C M740
BECKTON LOKI CL S284
 Ref. L-2 ↘ Beckton Lakme J460 LT
 ↙ Beckton Loki F251
 BKT Larkeisa J051 CK
 ↙ Beckton Latigo G714
 Beckton Lakme G128 HD
 ↙ Badlands Mr Beef 805
 JHL D5803
BECKTON ENCINO N076 PG
 ↙ Andras Pure Gold 132
 ↘ Beckton Encino L922 CH
 ↘ Beckton Champ R3 H338
 Beckton Encino G341 NP

DAM		Calv.Ease	BW	WW	YW	Milk	HPG	Stay	Maint.En.
Age	7	13	-4.2	28	60	19	6	12	5.6
Wt	1285								
Prog.BW	73								
WR	110								
YR	109								
Wean Pct.	47%								
Cow Eff.	99								
			Marb		REA			Bfat	
			-0.03		-0.19			+0.01	
		BWt	WWt	WR	ADG	YWt	YR	Scr.	Fr.
		72	605	102	3.95	1143	106	39	5.0

★★★★★ for Superior Cow, Calving Ease.

• Bulls •



55 BECKTON LANCER X195 C5
1-A 100% # 1382712 Tattoo: BKT0 X195

Birth: 3-13-10
 Beckton Lancer F442 T
 Beckton Lancer T A664
 Bkt Suffeina A828 DM
BECKTON LANCER T371 H4
 Ref. L-4 Beckton Coca F276 HV
 Leachman Heavenly 8141
 Beckton Coca B112 CB
 Beckton Cody KH M390
 Beckton Cody K G701
BECKTON LAKME P162 CD
 Beckton Lakme M795 WR
 Beckton Tamara J124 HR
 Beckton Warrior C C355
 Beckton Lakme A348 SN

DAM		Calv.Ease	BW	WW	YW	Milk	HPG	Stay	Maint.En.
Age	6	11	-1.6	29	57	14	8	13	-2.0
Wt	1050	Marb		-0.07	REA		+0.14	Bfat +0.01	
Prog.BW	73	BWt	WWt	WR	ADG	YWt	YR	Scr.	Fr.
WR	102	79	613	103	3.76	1109	102	36	5.0
YR	102								
Wean Pct.	58%								
Cow Eff.	123								

★★★★★ for Low Maintenance, Rib-eye area, High Cow Efficiency, Calving Ease, Stayability.

56 BECKTON NEBULA X229 J4
1-A 100% # 1382873 Tattoo: BSF0 X229

Birth: 3-15-10
 Beckton Nebula L P093
 Beckton Nebula M045
 Beckton Marta M021 LN
BECKTON NEBULA T398 V3
 Ref. N-9 Beckton Minerva J615 VG
 Beckton Vegas PK F485
 Beckton Minerva F433 VG
 Beckton Justice C K449
 Beckton Justice G302
 Bkt Larkabel C742 CF
BECKTON BARMAID N258 JC
 Beckton Barmaid G565 LN
 Beckton Lancer T A664
 Bkt Barmaid 9517 RN

DAM		Calv.Ease	BW	WW	YW	Milk	HPG	Stay	Maint.En.
Age	7	16	-5.3	27	56	13	9	12	-4.8
Wt	1095	Marb		+0.25	REA		+0.01	Bfat +0.01	
Prog.BW	66	BWt	WWt	WR	ADG	YWt	YR	Scr.	Fr.
WR	103	65	621	104	3.91	1106	102	39	5.0
YR	102								
Wean Pct.	57%								
Cow Eff.	119								

★★★★★ for Low Maintenance, Marbling, High Cow Efficiency, Calving Ease.

58 BECKTON DOMINOR X618 L5
1-A 100% # 1382811 Tattoo: BSF0 X618

Birth: 4-5-10
 Beckton Dominor ZC M919
 Beckton Dominor Z E401
 Beckton Barmaid J012 CO
BECKTON DOMINOR Z1 R610
 Ref. D-1 Beckton Sierra K557 LO
 Beckton Loki F251
 Beckton Sierra C157 CL
 Beckton Loki F251
 Beckton Lancer TZ D525
 Bkt Pine Marie D126 JL
BECKTON ANGEL H164 LO
 Beckton Angel F571 LN
 Beckton Lancer T A664
 Beckton Angel B636 DM

DAM		Calv.Ease	BW	WW	YW	Milk	HPG	Stay	Maint.En.
Age	12	14	-3.2	29	60	22	4	18	2.2
Wt	1105	Marb		+0.31	REA		+0.05	Bfat +0.03	
Prog.BW	74	BWt	WWt	WR	ADG	YWt	YR	Scr.	Fr.
WR	109	67	650	109	3.71	1161	107	35	5.5
YR	110								
Wean Pct.	57%								
Cow Eff.	120								

★★★★★ for Low Maintenance, Marbling, Superior Cow, High Cow Efficiency, Calving Ease, Stayability.

57 BECKTON EMPEROR X342 J3
1-A 100% # 1382727 Tattoo: BKT0 X342

Birth: 3-21-10
 Beckton Emperor R100
 Beckton Epic K4 N795
 Beckton Tamara N180 JO
BECKTON EMPEROR T641 E2
 Ref. E-5 Beckton Vernice R416 EP
 Beckton Epic K3 M606
 Beckton Vernice K482 HD
 Beckton Julio L233
 Beckton Julian G1 J526
 Beckton Rose J725 EP
BECKTON LANA P685 JO
 Beckton Lana E083 CD
 Beckton Cody C401
 Beckton Lana C220 CL

DAM		Calv.Ease	BW	WW	YW	Milk	HPG	Stay	Maint.En.
Age	6	14	-4.3	22	57	18	5	13	3.7
Wt	1240	Marb		+0.19	REA		+0.18	Bfat +0.01	
Prog.BW	66	BWt	WWt	WR	ADG	YWt	YR	Scr.	Fr.
WR	97	71	610	106	3.95	1111	103	36	5.5
YR	102								
Wean Pct.	49%								
Cow Eff.	104								

★★★★★ for Low Maintenance, Marbling, Rib-eye area, Calving Ease, Stayability.

59 BECKTON DOMINOR X524 C5
1-A 100% # 1382933 Tattoo: BSF0 X524

Birth: 3-30-10
 Beckton Dominor ZC M919
 Beckton Dominor Z E401
 Beckton Barmaid J012 CO
BECKTON DOMINOR Z1 R610
 Ref. D-1 Beckton Sierra K557 LO
 Beckton Loki F251
 Beckton Sierra C157 CL
 Beckton Cherokee N N479
 BFCK Cherokee Cnyn 4912
 Beckton Dinah C440 NM
BECKTON MONA R166 CQ
 Beckton Mona N342 HU
 Beckton Hustler C2 L079
 Beckton Mona L890 CO

DAM		Calv.Ease	BW	WW	YW	Milk	HPG	Stay	Maint.En.
Age	5	12	-2.9	32	60	18	8	15	2.4
Wt	1115	Marb		+0.20	REA		+0.09	Bfat +0.04	
Prog.BW	73	BWt	WWt	WR	ADG	YWt	YR	Scr.	Fr.
WR	104	71	598	101	3.81	1102	102	35	5.5
YR	103								
Wean Pct.	54%								
Cow Eff.	113								

★★★★★ for Low Maintenance, Marbling, Calving Ease, Stayability.

• Bulls •

60 **BECKTON EPIC X655 V6**
1-A 100% # 1382714 Tattoo: BKT0 X655

Birth: 4-9-10
 Beckton Epic K4 N795
BECKTON EPIC T330 L5
 Ref. E-3
 Beckton Belga K202 LN
 Beckton Epic KJ J722
 Beckton Sierra J789 EP
 Beckton Lancer T A664
 Beckton Belga D460 KR
 Beckton Vegas SV H078
 Beckton Eola H073 EP
 Beckton Herald H1 H348
 BKT Larkeisa H443 DM
BECKTON LARKEISA P268 VG
 Beckton Vegas S1 K316
 BKT Larkeisa K053 HR

DAM		Calv.Ease	BW	WW	YW	Milk	HPG	Stay	Maint.En.
Age	6	13	-3.9	25	56	17	8	11	-0.5
Wt	1100								
Prog.BW	69								
WR	109		Marb +.28		REA +.01		Bfat -.01		
YR	107								
Wean Pct.	60%	BWt	WWt	WR	ADG	YWt	YR	Scr.	Fr.
Cow Eff.	126	73	657	110	3.81	1188	107	32	5.5

★★★★★ for Low Maintenance, Marbling, Superior Cow, High Cow Efficiency, Calving Ease.

63 **BECKTON NEBULA X388 C4**
1-A 100% # 1383286 Tattoo: BKT0 X388

Birth: 3-23-10
 Beckton Nebula P P707
BECKTON NEBULA PJ S543
 Ref. N-6
 Beckton Lana P685 JO
 Beckton Nebula M045
 Beckton Lana M809 EP
 Beckton Julio L233
 Beckton Lana E083 CD
 Beckton Clifftop T3 N800
 Beckton Lana N869 LO
 Beckton Clifftop T3 N800
 Beckton Rose N125 LN
BECKTON ROSE T770 HI
 Beckton Hilltop R157
 Beckton Rose R507 CT

DAM		Calv.Ease	BW	WW	YW	Milk	HPG	Stay	Maint.En.
Age	3	14	-3.2	33	67	16	1	14	3.3
Wt	935								
Prog.BW	64								
WR	109		Marb +.29		REA +.20		Bfat +.02		
YR	103								
Wean Pct.	63%	BWt	WWt	WR	ADG	YWt	YR	Scr.	Fr.
Cow Eff.	132	64	627	109	3.38	1119	103	38	6.0

★★★★★ for Low Maintenance, Marbling, Rib-eye area, Superior Cow, High Cow Efficiency, Calving Ease, Stayability.

61 **BECKTON JET X118 J3**
1-A 100% # 1383328 Tattoo: BKT0 X118

Birth: 3-3-10
 Beckton Jet L P491
BECKTON JET U473 L2
 Ref. J-5
 Beckton Lydia N047 LM
 TR Julian LT151
 Beckton Minerva L278 LN
 Beckton Laramie L044
 Beckton Lydia L647 JL
 TR Julian RT561
 Beckton COCA U187 JD
 Beckton Coca R490 JC
 TR Julian LT151
 TR Dyna HT824
 Beckton Justice G302
 Beckton Coca M637 LO

DAM		Calv.Ease	BW	WW	YW	Milk	HPG	Stay	Maint.En.
Age	2	16	-3.9	29	61	16	8	17	1.0
Wt	842								
Prog.BW	61								
WR	104		Marb +.41		REA +.18		Bfat +.04		
YR	104								
Wean Pct.	62%	BWt	WWt	WR	ADG	YWt	YR	Scr.	Fr.
Cow Eff.	130	61	581	104	3.86	1088	104	41	5.5

★★★★★ for Low Maintenance, Marbling, Rib-eye area, Superior Cow, High Cow Efficiency, Calving Ease, Stayability.

64 **BECKTON JET X033 E3**
1-A 100% # 1383362 Tattoo: BKT0 X033

Birth: 2-16-10
 Beckton Jet L P491
BECKTON JET U473 L2
 Ref. J-5
 Beckton Lydia N047 LM
 Beckton Epic KJ J722
BECKTON LARKABA U448 EP
 Beckton Larkaba F394 VG
 TR Julian LT151
 Beckton Minerva L278 LN
 Beckton Laramie L044
 Beckton Lydia L647 JL
 Beckton Epic K F075
 Beckton Lana F891 JL
 Beckton Vegas P D462
 Beckton Larkaba D427 KR

DAM		Calv.Ease	BW	WW	YW	Milk	HPG	Stay	Maint.En.
Age	2	11	-1.7	31	48	21	6	15	-5.1
Wt	752								
Prog.BW	51								
WR	114		Marb +.17		REA +.20		Bfat +.04		
YR	102								
Wean Pct.	73%	BWt	WWt	WR	ADG	YWt	YR	Scr.	Fr.
Cow Eff.	153	51	606	114	3.24	1026	102	37	5.5

★★★★★ for Low Maintenance, Marbling, Rib-eye area, High Cow Efficiency, Calving Ease, Stayability.

62 **BECKTON JANUS X615 C2**
1-A 100% # 1382634 Tattoo: BKT0 X615

Birth: 4-5-10
 TR Romeo NT379
BECKTON ROMAN J S158
 Ref. O-1
 Beckton Belga K285 JL
 RDD B Topper 1675
BECKTON TAMARA F658 TP
 Bkt Tamara 8195 DN
 Buffalo Creek Romeo L081
 Buf Crk Lass L420
 Beckton Julian GG B571
 Beckton Belga G493 HR
 Bieber Topper 2476
 RR Miss Dynamo 7202
 Leachman Dyn614-3466
 MD 373 RC 523

DAM		Calv.Ease	BW	WW	YW	Milk	HPG	Stay	Maint.En.
Age	14	6	1.1	32	63	23	3	12	0.8
Wt	1075								
Prog.BW	74								
WR	105		Marb +.05		REA +.32		Bfat -.04		
YR	104								
Wean Pct.	58%	BWt	WWt	WR	ADG	YWt	YR	Scr.	Fr.
Cow Eff.	122	95	644	108	4.00	1163	108	36	5.5

★★★★★ for Low Maintenance, Growth, Gainability, Rib-eye area, Superior Cow, High Cow Efficiency.



• Bulls •

65 **BSF CHEROKEE X168 N4**
1-B 99% # 1382903 Tattoo: BSF0 X168

Birth: 3-11-10
 ↙ Beckton Cherokee N N479 ↘ BFCK Cherokee Cnyn 4912
 ↙ Beckton Dinah C440 NM
BECKTON CHEROKEE T450 L3
 Ref. C-1 ↙ Beckton Annie M337 LN ↘ Beckton Lancer TL G626
 ↘ Beckton Annie F743 LN
 ↙ Beckton Neptune R2 K065 ↘ Beckton Neptune RR B284
 ↘ Beckton Lana C735 TP
BSF NEPTALA P301
 ↙ BSF Regus L616 LN ↘ Beckton Lancer TL G626
 ↘ BSF Regus H508

DAM		Calv.Ease	BW	WW	YW	Milk	HPG	Stay	Maint.En.
Age	6	10	-2.1	32	62	17	11	15	-2.4
Wt	1135								
Prog.BW	71								
WR	102								
YR	99								
Wean Pct.	59%								
Cow Eff.	124								
		Marb	+0.09		REA	+0.08		Bfat	+0.03
		BWt	WWt	WR	ADG	YWt	YR	Scr.	Fr.
		83	670	113	3.19	1133	105	39	5.0

★★★★★ for Low Maintenance, High Cow Efficiency, Calving Ease, Stayability.



66 **BSF LEGEND X745 W2**
1-B 99% # 1383043 Tattoo: BSF0 X745

Birth: 4-19-10
 ↙ Beckton Lancer F442 T ↘ Beckton Lancer T A664
 ↘ Bkt Suffeina A828 DM
BECKTON LEGEND S670
 Ref. L-3 ↙ Beckton Kit F468 JL ↘ Beckton Julian GG B571
 ↘ Beckton Kit A517 NP
 ↙ Beckton Warrior N645 T1 ↘ Beckton Warrior T1 H281
 ↘ Beckton Rose H074 EP
BSF HUSTELLE T145 WR
 ↙ BSF Hustelle R666 HU ↘ Beckton Hustler CN J102
 ↘ BSF Regus L114 HR

DAM		Calv.Ease	BW	WW	YW	Milk	HPG	Stay	Maint.En.
Age	3	12	-2.4	32	69	10	15	14	-1.0
Wt	1005								
Prog.BW	67								
WR	110								
YR	109								
Wean Pct.	58%								
Cow Eff.	122								
		Marb	+0.28		REA	+0.24		Bfat	+0.02
		BWt	WWt	WR	ADG	YWt	YR	Scr.	Fr.
		67	625	109	4.19	1173	111	35	6.0

★★★★★ for Low Maintenance, Growth, Gainability, Marbling, Rib-eye area, Superior Cow, High Cow Efficiency, Calving Ease, Stayability.

68 **BSF LANCER X206 J5**
1-B 99% # 1382905 Tattoo: BSF0 X206

Birth: 3-14-10
 ↙ Beckton Lancer F442 T ↘ Beckton Lancer T A664
 ↘ Bkt Suffeina A828 DM
BECKTON LANCER T371 H4
 Ref. L-4 ↙ Beckton Coca F276 HV ↘ Leachman Heavenly 8141
 ↘ Beckton Coca B112 CB
 ↙ Beckton Julian G2 M345 ↘ Beckton Julian GG B571
 ↘ Beckton Lana H544 WR
BSF JULIANNE P332
 ↙ BSF Regus M835 JL ↘ Beckton Julian 7526G
 ↘ BSF Regus H052

DAM		Calv.Ease	BW	WW	YW	Milk	HPG	Stay	Maint.En.
Age	6	13	-2.6	23	53	10	9	15	0.3
Wt	1170								
Prog.BW	62								
WR	97								
YR	102								
Wean Pct.	46%								
Cow Eff.	97								
		Marb	+0.13		REA	+0.06		Bfat	+0.02
		BWt	WWt	WR	ADG	YWt	YR	Scr.	Fr.
		80	540	91	4.10	1068	99	37	5.5

★★★★★ for Low Maintenance, Gainability, Marbling, Calving Ease, Stayability.

67 **BSF NEBULA X563 V4**
1-B 99% # 1382974 Tattoo: BSF0 X563

Birth: 4-1-10
 ↙ Beckton Nebula P P707 ↘ Beckton Nebula M045
 ↘ Beckton Lana M809 EP
BECKTON NEBULA PJ S543
 Ref. N-6 ↙ Beckton Lana P685 JO ↘ Beckton Julio L233
 ↘ Beckton Lana E083 CD
 ↙ Beckton Vega P079 ↘ Beckton Vegas S1 K316
 ↘ Beckton Lydia H159 JL
BSF NEPTALA S036 VA
 ↙ BSF Neptala P301 ↘ Beckton Neptune R2 K065
 ↘ BSF Regus L616 LN

DAM		Calv.Ease	BW	WW	YW	Milk	HPG	Stay	Maint.En.
Age	4	15	-4.0	33	67	16	9	15	3.7
Wt	1160								
Prog.BW	62								
WR	112								
YR	108								
Wean Pct.	53%								
Cow Eff.	111								
		Marb	+0.11		REA	+0.14		Bfat	+0.01
		BWt	WWt	WR	ADG	YWt	YR	Scr.	Fr.
		72	634	106	3.67	1167	105	33	5.5

★★★★★ for Low Maintenance, Growth, Marbling, Rib-eye area, Superior Cow, Calving Ease, Stayability.

69 **BSF JANUS X419 J2**
1-B 99% # 1382998 Tattoo: BSF0 X419

Birth: 3-25-10
 ↙ TR Romeo NT379 ↘ Buffalo Creek Romeo L081
 ↘ Buf Crk Lass L420
BECKTON ROMAN J S158
 Ref. O-1 ↙ Beckton Belga K285 JL ↘ Beckton Julian GG B571
 ↘ Beckton Belga G493 HR
 ↙ Beckton Jules L429 ↘ Beckton Julian G1 J526
 ↘ Beckton Barona J591 EP
BSF VIOLET S326 JE
 ↙ BSF Violet N382 VG ↘ Beckton Vegas S1 K316
 ↘ BSF Red H119

DAM		Calv.Ease	BW	WW	YW	Milk	HPG	Stay	Maint.En.
Age	4	12	-1.3	38	64	17	8	13	0.7
Wt	1040								
Prog.BW	63								
WR	104								
YR	99								
Wean Pct.	59%								
Cow Eff.	123								
		Marb	+0.00		REA	+0.11		Bfat	-0.02
		BWt	WWt	WR	ADG	YWt	YR	Scr.	Fr.
		72	629	106	3.43	1074	99	37	5.5

★★★★★ for Low Maintenance, High Cow Efficiency, Calving Ease, Stayability.

• Bulls •

70 **BSF LIKABLE X063 E3**
1-B 99% # 1383108 Tattoo: BSF0 X063

Birth: 2-22-10
 Beckton Likable S633
BECKTON LIKABLE U120 L2
 Ref. L-5
 Beckton Lana S718 LN
 Beckton Lancer F442 T
 Beckton Kit F468 JL
 Beckton Lancer F442 T
 Beckton Lana F891 JL
 Beckton Epic R350 K
BSF COQUETTE U319 EP
 Beckton Epic K F075
 Beckton Larkaba E042 CD
 Beckton Colt L L820
 BSF Red L735 EP

DAM		Calv.Ease	BW	WW	YW	Milk	HPG	Stay	Maint.En.
Age	2	12	-2.5	24	55	10	7	18	0.8
Wt	965	Marb +1.0		REA +2.7		Bfat +0.3			
Prog.BW	66	BWt	WWt	WR	ADG	YWt	YR	Scr.	Fr.
WR	97	66	515	97	3.19	1015	101	35	5.5
YR	101								
Wean Pct.	47%								
Cow Eff.	99								

★★★★★ for Low Maintenance, Rib-eye area, Calving Ease, Stayability.

72 **TR EPIC XT004**
1-A 100% # 1369790 Tattoo: TR2A0 XT00

Birth: 2-25-10
 Beckton Epic K F075
TR EPIC ST618
 Ref. E-9
 Beckton Kit F468 JL
 Beckton Epic D404
 Beckton Belga D483 KR
 Beckton Julian GG B571
 Beckton Kit A517 NP
 Beckton JULIAN GG B571
TR BELGA LT125
 Beckton Larkaba E042 CD
 Beckton Colt L L820
 BSF Red L735 EP
 BKT Julian 7526 G
 BKT Marta 9A13 JL
 MRM-Buf Copper Chf 9409
 Buf Crk Belga 3464

DAM		Calv.Ease	BW	WW	YW	Milk	HPG	Stay	Maint.En.
Age	9	12	-2.8	29	54	13	12	15	-5.0
Wt	1280	Marb -0.9		REA +2.1		Bfat +0.4			
Prog.BW	71	BWt	WWt	WR	ADG	YWt	YR	Scr.	Fr.
WR	NA	87	676	106	3.28	1200	107	40	5.0
YR	NA								
Wean Pct.	NA%								
Cow Eff.	NA								

★★★★★ for Low Maintenance, Rib-eye area, Calving Ease, Stayability.



73 **TR LANCER XT058**
1-A 100% # 1369784 Tattoo: TR2A0 XT05

Birth: 1-23-10
 Beckton Lancer 9380
BECKTON LANCER T A664
 Ref. L
 Beckton Coca 9119 TJ
 Algebra I 769
MS GEOMETRIC 928
 MS Geometric 661
 Beckton Trojan 5253
 Bkt Kilo Lana 4251
 Beckton Trojan 7061P
 Beckton Coca 7536 SB
 Buf Crk Hobo 1961
 MS Geometric 474
 Leachman Heavenly 8141
 MS Geometric 277

DAM		Calv.Ease	BW	WW	YW	Milk	HPG	Stay	Maint.En.
Age	11	13	-1.8	29	61	9	7	10.6	9.1
Wt	1535	Marb +2.2		REA +1.1		Bfat -0.2			
Prog.BW	82	BWt	WWt	WR	ADG	YWt	YR	Scr.	Fr.
WR	NA	82	613	NA	3.17	1120	NA	34	5.5
YR	NA								
Wean Pct.	NA%								
Cow Eff.	NA								

★★★★★ for Marbling, Calving Ease.

71 **TR EPIC XT005**
1-A 100% # 1369791 Tattoo: TR2A0 XT00

Birth: 2-23-10
 Beckton Epic K F075
TR EPIC ST618
 Ref. E-9
 Beckton Kit F468 JL
 BSF Julian JT911
TR RUTH LT126
 Beckton Ruth D817 NP
 Beckton Epic D404
 Beckton Belga D483 KR
 Beckton Julian GG B571
 Beckton Kit A517 NP
 Beckton Julian G717 GG
 TR Lydia G750
 Beckton Neptune RT Z305
 Beckton Ruth A905 SG

DAM		Calv.Ease	BW	WW	YW	Milk	HPG	Stay	Maint.En.
Age	9	14	-3.4	21	39	13	11	13.8	-7.8
Wt	1200	Marb +1.1		REA +2.2		Bfat -0.1			
Prog.BW	77	BWt	WWt	WR	ADG	YWt	YR	Scr.	Fr.
WR	NA	76	654	102	3.22	1170	104	41	4.5
YR	NA								
Wean Pct.	NA%								
Cow Eff.	NA								

★★★★★ for Low Maintenance, Marbling, Rib-eye area, Calving Ease, Stayability.

74 **TR EPIC XT041**
1-A 100% # 1369857 Tattoo: TR2A0 XT04

Birth: 2-11-10
 Beckton Epic K F075
TR EPIC ST618
 Ref. E-9
 Beckton Kit F468 JL
 TR Ricardo RT574
TR LANA UT892
 TR Lana ST685
 Beckton Epic D404
 Beckton Belga D483 KR
 Beckton Julian GG B571
 Beckton Kit A517 NP
 Bfck Cherokee Cnyn 4912
 TR Dyna LT111
 TR Julian LT151
 TR Lana PT460

DAM		Calv.Ease	BW	WW	YW	Milk	HPG	Stay	Maint.En.
Age	2	14	-3.5	30	60	15	12	17	-3.9
Wt	1005	Marb +1.3		REA +3.1		Bfat +0.3			
Prog.BW	70	BWt	WWt	WR	ADG	YWt	YR	Scr.	Fr.
WR	NA	70	631	109	3.37	1171	106	37	5.5
YR	NA								
Wean Pct.	NA%								
Cow Eff.	NA								

★★★★★ for Low Maintenance, Marbling, Rib-eye area, Calving Ease, Stayability.

• Bulls •

75 **TR EPIC XT003**
1-A 100% # 1369788 Tattoo: TR2A0 XT00

Birth: 2-18-10
 Beckton Epic K F075
TR EPIC ST618
 Ref. E-9
 Beckton Kit F468 JL
 Beckton Epic D404
 Beckton Belga D483 KR
 Beckton Julian GG B571
 Beckton Kit A517 NP
 BKT Julian 7526 G
 BKT Marta 9A13 JL
 TR Lancer G010
 Buf Crk Dyna 3082
TR DYNA LT111
 Beckton Julian GG B571
 BSF Dyna JT976

DAM		Calv.	Ease	BW	WW	YW	Milk	HPG	Stay	Maint.En.
Age	9	14	-3.6	25	54	14	10	19	-8.2	
Wt	1210									
Prog.BW	75									
WR	NA		Marb	+20	REA	+20	Bfat	+03		
YR	NA									
Wean Pct.	NA%	BWt	WWt	WR	ADG	YWt	YR	Scr.	Fr.	
Cow Eff.	NA	86	625	98	3.27	1147	102	33	4.5	

★★★★★ for Low Maintenance, Marbling, Rib-eye area, Calving Ease, Stayability.

78 **TR JULIAN XT010**
1-A 100% # 1369798 Tattoo: TR2A0 XT01

Birth: 2-28-10
 Beckton Julian GG B571
TR JULIAN LT151
 Ref. J-8
 MS Geometric 917
 Beckton Epic D404
TR LANA NT329
 TR Lana LT116
 BKT Julian 7526 G
 BKT Marta 9A13 JL
 BJR Yo 121
 MS Geometric
 Beckton Saga KJ B702
 Beckton Kuruba B508 PC
 Beckton Lancer F134 TS
 Beckton Lana E828 SC

DAM		Calv.	Ease	BW	WW	YW	Milk	HPG	Stay	Maint.En.
Age	7	13	-2.7	25	54	12	11	17	2.2	
Wt	1410									
Prog.BW	78									
WR	NA		Marb	+39	REA	+13	Bfat	+02		
YR	NA									
Wean Pct.	NA%	BWt	WWt	WR	ADG	YWt	YR	Scr.	Fr.	
Cow Eff.	NA	81	624	98	3.19	1135	101	35	5.5	

★★★★★ for Low Maintenance, Marbling, Rib-eye area, Calving Ease, Stayability.

76 **TR EPIC XT034**
1-A 100% # 1369779 Tattoo: TR2A0 XT03

Birth: 2-22-10
 Beckton Epic K F075
TR EPIC ST618
 Ref. E-9
 Beckton Kit F468 JL
 Beckton Epic D404
 Beckton Belga D483 KR
 Beckton Julian GG B571
 Beckton Kit A517 NP
 Beckton Martex 709-236-2
BECKTON L A 1060-110
 Beckton Larkaba A 771-751

DAM		Calv.	Ease	BW	WW	YW	Milk	HPG	Stay	Maint.En.
Age	3	8	-0.9	41	77	14	10	10.5	-0.3	
Wt	1135									
Prog.BW	85									
WR	NA		Marb	+15	REA	+19	Bfat	+01		
YR	NA									
Wean Pct.	NA%	BWt	WWt	WR	ADG	YWt	YR	Scr.	Fr.	
Cow Eff.	NA	85	658	114	3.16	1164	106	38	5.5	

★★★★★ for Low Maintenance, Growth, Marbling, Rib-eye area, Calving Ease.



77 **TR JULIAN XT006**
1-A 100% # 1369792 Tattoo: TR2A0 XT00

Birth: 3-13-10
 Beckton Julian 7526G
BECKTON JULIAN GG B571
 Ref. J-1
 Bkt Marta 9A13 JL
 Beckton Julian 6592
 Bkt Belga 6746 GS
 Beckton Julian 7526G
 Bkt Marta 6498 XM
 BJR Easy Rider 781
 BJR Tow Kana 117-710
 BJR Yo 121
 MS Geometric 360
 BJR Make My Day 981
MS GEOMETRIC 922
 MS Geometric 653

DAM		Calv.	Ease	BW	WW	YW	Milk	HPG	Stay	Maint.En.
Age	11	15	-3.2	27	58	18	10	13	4.9	
Wt	1550									
Prog.BW	75									
WR	NA		Marb	+25	REA	+24	Bfat	+01		
YR	NA									
Wean Pct.	NA%	BWt	WWt	WR	ADG	YWt	YR	Scr.	Fr.	
Cow Eff.	NA	65	584	NA	3.34	1119	NA	38	5.5	

★★★★★ for Marbling, Rib-eye area, Calving Ease, Stayability.

79 **BSF JULIAN X207 E5**
1-B 99% # 1382871 Tattoo: BSF0 X207

Birth: 3-14-10
 Beckton Julian GJ P535
BECKTON JULIAN G5 S107
 Ref. J-4
 Beckton Minola P826 DM
 Beckton Julian 7526G
 Beckton Mona D086 JL
 Beckton Dominor ZC M919
 Beckton Minola M641 WR
 Beckton Epic K F075
 Beckton Lana F891 JL
 Beckton Epic KJ J722
BSF ERICA N159 EP
 BSF Red G006
 Beckton Julius E349
 BSF Regus E305

DAM		Calv.	Ease	BW	WW	YW	Milk	HPG	Stay	Maint.En.
Age	7	12	-2.1	30	66	17	9	17	-1.8	
Wt	1135									
Prog.BW	73									
WR	110		Marb	+22	REA	+14	Bfat	+08		
YR	112									
Wean Pct.	60%	BWt	WWt	WR	ADG	YWt	YR	Scr.	Fr.	
Cow Eff.	126	72	681	114	4.14	1227	113	41	5.0	

★★★★★ for Low Maintenance, Growth, Gainability, Marbling, Rib-eye area, Superior Cow, High Cow Efficiency, Calving Ease, Stayability.

• Bulls •

80 **BSF ACCENT X037 L3**
1-B 99% # 1383067 Tattoo: BSF0 X037

Birth: 2-16-10
 ↗ Beckton Cody K1 P014
BECKTON ACCENT U777 C2
 Ref. A-1 ↘ Beckton Susan R022 CQ
 ↗ Beckton Cody KH M390
 Beckton Rose M126 WR
 ↗ Beckton Cherokee N N479
 Beckton Susan N023 JE
 ↗ Beckton Legend S670
BSF LANETTE U041 LE
 ↘ BSF Lanette S316 LN
 ↗ Beckton Lancer F442 T
 Beckton Kit F468 JL
 ↗ Beckton Lancer T7 M089
 BSF Red F608

DAM		Calv.Ease	BW	WW	YW	Milk	HPG	Stay	Maint.En.
Age	2	11	-1.8	29	58	16	11	17	1.1
Wt	826	Marb +1.1		REA +5.1		Bfat +0.3			
Prog.BW	49	BWt	WWt	WR	ADG	YWt	YR	Scr.	Fr.
WR	104	49	552	104	4.14	1111	110	36	5.0
YR	110								
Wean Pct.	60%								
Cow Eff.	125								

★★★★★ for Low Maintenance, Gainability, Marbling, Rib-eye area, Superior Cow, High Cow Efficiency, Calving Ease, Stayability.

83 **BSF LIKABLE X103 C3**
1-B 99% # 1383094 Tattoo: BSF0 X103

Birth: 3-1-10
 ↗ Beckton Likable S633
BECKTON LIKABLE U120 L2
 Ref. L-5 ↘ Beckton Lana S718 LN
 ↗ Beckton Lancer F442 T
 Beckton Kit F468 JL
 ↗ Beckton Lancer F442 T
 Beckton Lana F891 JL
 ↗ BFCK Cherokee Cnyn 4912
 Beckton Dinah C440 NM
 ↗ Beckton Cherokee N N479
BSF LAUREL U202 CQ
 ↘ BSF Laurel N839 LN
 ↗ Beckton Lancer T1 H080
 BSF Regus E601

DAM		Calv.Ease	BW	WW	YW	Milk	HPG	Stay	Maint.En.
Age	2	11	-2.6	26	59	13	9	17	0.6
Wt	895	Marb +1.9		REA +4.7		Bfat +0.2			
Prog.BW	70	BWt	WWt	WR	ADG	YWt	YR	Scr.	Fr.
WR	103	70	578	103	3.71	1114	106	38	5.5
YR	106								
Wean Pct.	58%								
Cow Eff.	122								

★★★★★ for Low Maintenance, Marbling, Rib-eye area, Superior Cow, High Cow Efficiency, Calving Ease, Stayability.

81 **BSF NEBULA X614 J4**
1-B 99% # 1383035 Tattoo: BSF0 X614

Birth: 4-5-10
 ↗ Beckton Nebula P P707
BECKTON NEBULA PJ S543
 Ref. N-6 ↘ Beckton Lana P685 JO
 ↗ Beckton Nebula M045
 Beckton Lana M809 EP
 ↗ Beckton Julio L233
 Beckton Lana E083 CD
 ↗ Beckton Justice C1 R483
BSF JUSTICIA T013 JC
 ↘ BSF Justicia R874 JC
 ↗ Beckton Justice CH M056
 Beckton Tamara J124 HR
 ↗ Beckton Justice CH M056
 BSF Regus M411 EP

DAM		Calv.Ease	BW	WW	YW	Milk	HPG	Stay	Maint.En.
Age	3	16	-5.3	38	80	20	5	14	2.3
Wt	1040	Marb +3.1		REA +0.8		Bfat +0.2			
Prog.BW	64	BWt	WWt	WR	ADG	YWt	YR	Scr.	Fr.
WR	124	64	659	124	4.00	1216	118	36	5.5
YR	118								
Wean Pct.	60%								
Cow Eff.	125								

★★★★★ for Low Maintenance, Growth, Gainability, Marbling, Superior Cow, High Cow Efficiency, Calving Ease, Stayability.

84 **BSF JULES X276 W2**
1-B 99% # 1382859 Tattoo: BSF0 X276

Birth: 3-18-10
 ↗ Beckton Julian G1 J526
BECKTON JULES L429
 Ref. J-2 ↘ Beckton Barona J591 EP
 ↗ Beckton Julian GG B571
 Beckton Annie F743 LN
 ↗ Beckton Epic K F075
 Beckton Barona E134 RN
 ↗ Beckton Warrior CK J861
BSF REGUS M638 WR
 ↘ BSF Regus J551
 ↗ Bkt Larkaba 8562 KR
 BSF Casper F784
 BSF Regus E628

DAM		Calv.Ease	BW	WW	YW	Milk	HPG	Stay	Maint.En.
Age	8	13	-3.5	19	40	17	12	16	-1.0
Wt	1165	Marb -0.4		REA +1.8		Bfat +0.2			
Prog.BW	68	BWt	WWt	WR	ADG	YWt	YR	Scr.	Fr.
WR	104	77	603	101	3.81	1095	101	37	5.0
YR	101								
Wean Pct.	52%								
Cow Eff.	109								

★★★★★ for Low Maintenance, Rib-eye area, Calving Ease, Stayability.

82 **BSF HASTEN X036 J4**
1-2 99% # 1382610 Tattoo: BSF0 X036

Birth: 2-16-10
 ↗ Beckton Hasten H S462
BECKTON HASTEN U108 J3
 Ref. H-5 ↘ Beckton Encino S456 JC
 ↗ Beckton Hasten P292
 Beckton Lakme G128 HD
 ↗ Beckton Justice G302
 Beckton Encino J431 DM
 ↗ Beckton Justice C1 R483
BSF JULIANNE U743 JC
 ↘ BSF Julianne R839 JL
 ↗ Beckton Justice CH M056
 Beckton Tamara J124 HR
 ↗ Beckton Julian G1 J526
 BSF Regus G340

DAM		Calv.Ease	BW	WW	YW	Milk	HPG	Stay	Maint.En.
Age	2	16	-4.4	27	60	15	10	16	-3.1
Wt	885	Marb +1.2		REA -0.7		Bfat +0.3			
Prog.BW	49	BWt	WWt	WR	ADG	YWt	YR	Scr.	Fr.
WR	104	49	524	104	4.00	1088	111	34	5.0
YR	111								
Wean Pct.	52%								
Cow Eff.	110								

★★★★★ for Low Maintenance, Gainability, Marbling, Superior Cow, Calving Ease, Stayability.

85 **BSF NEBULA X700 L4**
1-B 99% # 1383015 Tattoo: BSF0 X700

Birth: 4-13-10
 ↗ Beckton Nebula P P707
BECKTON NEBULA PJ S543
 Ref. N-6 ↘ Beckton Lana P685 JO
 ↗ Beckton Nebula M045
 Beckton Lana M809 EP
 ↗ Beckton Julio L233
 Beckton Lana E083 CD
 ↗ Beckton Lancer T9 N586
BSF NEENA S559 LN
 ↘ BSF Neena N333 NP
 ↗ Beckton Lancer TA K644
 BKT Larkeisa H232 SC
 ↗ Beckton Neptune R2 K065
 BSF Brockle G498

DAM		Calv.Ease	BW	WW	YW	Milk	HPG	Stay	Maint.En.
Age	4	13	-3.3	34	64	16	8	11	-6.2
Wt	880	Marb +2.3		REA +0.8		Bfat -0.1			
Prog.BW	79	BWt	WWt	WR	ADG	YWt	YR	Scr.	Fr.
WR	115	74	664	112	3.43	1160	107	38	5.5
YR	110								
Wean Pct.	73%								
Cow Eff.	154								

★★★★★ for Low Maintenance, Growth, Marbling, Superior Cow, High Cow Efficiency, Calving Ease.

• Bulls •



88 **BSF LOKI X784 J4**
1-B 99% # 1383040 Tattoo: BSF0 X784

Birth: 4-26-10
 Beckton Loki C M740 < Beckton Loki F251
 Beckton Larkieisa J051 CK
BECKTON LOKI CL S284
 Ref. L-2 < Beckton Lakme J460 LT
 Beckton Latigo G714
 Beckton Lakme G128 HD
 Beckton Justice C2 R695 < Beckton Justice CH M056
BSF JUSTICIA T087 JC
 < Beckton Tamara M878 JC
 Beckton Justice C K449
 < BSF Regus J698

DAM		Calv.Ease	BW	WW	YW	Milk	HPG	Stay	Maint.En.
Age	3	17	-5.6	31	65	17	7	14	4.7
Wt	970	Marb +0.18		REA +0.11		Bfat +0.02			
Prog.BW	57	BWt	WWt	WR	ADG	YWt	YR	Scr.	Fr.
WR	116	60	652	114	3.67	1165	110	39	6.0
YR	110								
Wean Pct.	63%								
Cow Eff.	133								

★★★★★ for Growth, Marbling, Superior Cow, High Cow Efficiency, Calving Ease, Stayability.

86 **BSF NEBULA X723 L4**
1-3 93% # 1383062 Tattoo: BSF0 X723

Birth: 4-16-10
 Beckton Nebula L P093 < Beckton Nebula M045
 Beckton Marta M021 LN
BECKTON NEBULA T398 V3
 Ref. N-9 < Beckton Minerva J615 VG
 Beckton Vegas PK F485
 Beckton Minerva F433 VG
 Beckton Lancer T7 M089 < Beckton Lancer F442 T
BSF REGINA T868
 < Beckton Tamara G141 HE

DAM		Calv.Ease	BW	WW	YW	Milk	HPG	Stay	Maint.En.
Age	3	8	-0.7	35	67	13	9	11	-1.6
Wt	950	Marb +0.05		REA +0.16		Bfat +0.00			
Prog.BW	69	BWt	WWt	WR	ADG	YWt	YR	Scr.	Fr.
WR	114	75	681	119	3.57	1171	111	36	5.5
YR	100								
Wean Pct.	68%								
Cow Eff.	142								

★★★★★ for Low Maintenance, Growth, Rib-eye area, High Cow Efficiency, Calving Ease.

89 **BSF NEBULA X014 C5**
1-B 99% # 1383105 Tattoo: BSF0 X014

Birth: 2-11-10
 Beckton Nebula PJ S543 < Beckton Nebula P P707
 Beckton Lana P685 JO
BECKTON NEBULA U060 N4
 Ref. N-11 < Beckton Birdie S110 NB
 Beckton Nebula P P707
 Beckton Birdie P086 WR
 Beckton Clifftop T3 N800 < Bkt Clifftop TV G672
BSF EPIQUETTE U279 CT
 < Beckton Lana J384 CD
 Beckton Epic KJ J722
 < BSF Regus L407 CL

DAM		Calv.Ease	BW	WW	YW	Milk	HPG	Stay	Maint.En.
Age	2	15	-4.2	24	54	17	4	13	-3.3
Wt	870	Marb +0.35		REA +0.10		Bfat +0.03			
Prog.BW	61	BWt	WWt	WR	ADG	YWt	YR	Scr.	Fr.
WR	102	61	546	102	3.24	1003	99	37	5.0
YR	99								
Wean Pct.	56%								
Cow Eff.	118								

★★★★★ for Low Maintenance, Marbling, High Cow Efficiency, Calving Ease, Stayability.

87 **BSF NEBULA X709 J4**
1-B 98% # 1382878 Tattoo: BSF0 X709

Birth: 4-14-10
 Beckton Nebula P P707 < Beckton Nebula M045
 Beckton Lana M809 EP
BECKTON NEBULA PJ S543
 Ref. N-6 < Beckton Lana P685 JO
 Beckton Julio L233
 Beckton Lana E083 CD
 Beckton Jules L429 < Beckton Julian G1 J526
 Beckton Barona J591 EP
BSF JEWEL N355 JE
 < Beckton Clifftop T C075
 BSF Regus F712

DAM		Calv.Ease	BW	WW	YW	Milk	HPG	Stay	Maint.En.
Age	7	16	-5.4	31	58	15	7	17	-7.4
Wt	985	Marb +0.14		REA +0.15		Bfat +0.01			
Prog.BW	62	BWt	WWt	WR	ADG	YWt	YR	Scr.	Fr.
WR	101	66	636	110	3.24	1107	103	34	5.5
YR	99								
Wean Pct.	65%								
Cow Eff.	136								

★★★★★ for Low Maintenance, Marbling, Rib-eye area, High Cow Efficiency, Calving Ease, Stayability.

90 **BSF NEBULA X756 J4**
1-B 99% # 1383044 Tattoo: BSF0 X756

Birth: 4-21-10
 Beckton Nebula P P707 < Beckton Nebula M045
 Beckton Lana M809 EP
BECKTON NEBULA PJ S543
 Ref. N-6 < Beckton Lana P685 JO
 Beckton Julio L233
 Beckton Lana E083 CD
 Beckton Jupiter R478 < Beckton Julian G1 J526
 Beckton Serena L042 CR
BSF ANDREA T146 JR
 < Beckton Juno N493
 BSF Andrea R028 JJ
 < BSF Andrea N061 PG

DAM		Calv.Ease	BW	WW	YW	Milk	HPG	Stay	Maint.En.
Age	3	14	-4.3	33	65	14	7	15	-2.2
Wt	905	Marb +0.26		REA -0.04		Bfat +0.01			
Prog.BW	61	BWt	WWt	WR	ADG	YWt	YR	Scr.	Fr.
WR	107	69	611	107	3.81	1100	104	36	6.0
YR	104								
Wean Pct.	63%								
Cow Eff.	133								

★★★★★ for Low Maintenance, Marbling, Superior Cow, High Cow Efficiency, Calving Ease, Stayability.

• Bulls •

91 BSF RANGER X574 N4
1-B 98% # 1382870 Tattoo: BSF0 X574

Birth: 4-2-10
 Beckton Ranger 9479R
BECKTON RANGER T603 H3
 Ref. R-1
 Beckton Rose N044 HU
 Beckton Ranger 7003
 Beckton Eola 7470 RZ
 Beckton Hustler C2 L079
 Beckton Rose L669 JL
 Beckton Neptune RR B284
 Beckton Lana C735 TP
 Beckton Hadrian F C486
 BSF Regus 9287-2
BSF NEENA N153 NP
 Beckton Neptune R2 K065
 BSF Regus F343

DAM		Calv.Ease	BW	WW	YW	Milk	HPG	Stay	Maint.En.
Age	7	13	-4.1	16	32	14	12	11	-5.7
Wt	1100	Marb +0.07		REA -0.40		Bfat +0.03			
Prog.BW	67	BWt	WWt	WR	ADG	YWt	YR	Scr.	Fr.
WR	98	70	588	99	3.05	994	92	33	5.5
YR	98								
Wean Pct.	53%								
Cow Eff.	113								

★★★★★ for Low Maintenance, Calving Ease.

93 BECKTON EPIC X148 J5
1-A 100% # 1382872 Tattoo: BSF0 X148

Birth: 3-9-10
 Beckton Epic KM M115
BECKTON EPIC K6 S569
 Ref. E-2
 Beckton Sierra N703 LM
 Beckton Epic K F075
 Beckton Minerva F495 CH
 Beckton Laramie L044
 Beckton Sierra L887 LN
 Beckton Julian 6592
 Bkt Belga 6746 GS
BECKTON LANA N163 JL
 Beckton Julian 7526G
 Beckton Lana K052 VG
 Beckton Vegas SV H078
 Beckton Lana H725 CH

DAM		Calv.Ease	BW	WW	YW	Milk	HPG	Stay	Maint.En.
Age	7	9	-0.9	35	68	20	12	16	3.8
Wt	1245	Marb +0.18		REA +0.16		Bfat +0.06			
Prog.BW	71	BWt	WWt	WR	ADG	YWt	YR	Scr.	Fr.
WR	106	82	614	103	3.43	1114	101	36	5.0
YR	104								
Wean Pct.	49%								
Cow Eff.	104								

★★★★★ for Low Maintenance, Marbling, Rib-eye area, Superior Cow, Calving Ease, Stayability.

92 BECKTON HASTEN X685 J3
1-A 100% # 1382691 Tattoo: BKT0 X685

Birth: 4-12-10
 Beckton Hasten P292
BECKTON HASTEN H S462
 Ref. H-3
 Beckton Lakme G128 HD
 Beckton Hustler C2 L079
 Beckton Sheba L644 CH
 Beckton Hadrian FC E166
 Beckton Lakme E373 CL
 Beckton Julian G1 J526
 Beckton Barona J591 EP
BECKTON SUSAN N023 JE
 Beckton Jules L429
 Beckton Susan L258 LR
 MRM Lancer 916
 Beckton Susan F315 TP

DAM		Calv.Ease	BW	WW	YW	Milk	HPG	Stay	Maint.En.
Age	7	15	-5.8	26	48	23	8	14	-1.8
Wt	1120	Marb -0.11		REA +0.06		Bfat +0.02			
Prog.BW	65	BWt	WWt	WR	ADG	YWt	YR	Scr.	Fr.
WR	111	70	715	120	3.38	1170	108	35	5.0
YR	102								
Wean Pct.	64%								
Cow Eff.	134								

★★★★★ for Low Maintenance, High Cow Efficiency, Calving Ease, Stayability.

94 BECKTON HERITAGE X423 A3
1-A 100% # 1383171 Tattoo: BKT0 X423

Birth: 3-25-10
 Beckton Heritage N013
BECKTON HERITAGE T270 J2
 Ref. H-4
 Beckton Coca P602 JL
 Beckton Cody K1 P014
BECKTON SUSAN S766 CD
 Beckton Susan P857 JO
 Beckton Hustler C2 L079
 Beckton Lana L007 JL
 Beckton Julian GG B571
 Beckton Coca J270 CD
 Beckton Cody KH M390
 Beckton Rose M126 WR
 Beckton Julio L233
 Beckton Susan G199 CO

DAM		Calv.Ease	BW	WW	YW	Milk	HPG	Stay	Maint.En.
Age	4	18	-5.8	28	55	19	9	16	0.3
Wt	1080	Marb +0.21		REA +0.07		Bfat +0.04			
Prog.BW	58	BWt	WWt	WR	ADG	YWt	YR	Scr.	Fr.
WR	111	55	639	111	4.14	1172	109	34	5.0
YR	111								
Wean Pct.	57%								
Cow Eff.	121								

★★★★★ for Low Maintenance, Gainability, Marbling, Superior Cow, High Cow Efficiency, Calving Ease, Stayability.



95 BECKTON CHEROKEE X252 H4
1-A 100% # 1382636 Tattoo: BKT0 X252

Birth: 3-16-10
 Beckton Cherokee N N479
BECKTON CHEROKEE T450 L3
 Ref. C-1
 Beckton Annie M337 LN
 Beckton Hadrian FC E166
BECKTON LAKME G128 HD
 Beckton Lakme E373 CL
 BFCK Cherokee Cnyn 4912
 Beckton Dinah C440 NM
 Beckton Lancer TL G626
 Beckton Annie F743 LN
 Beckton Hadrian F C486
 Bkt Pine Marie C046 CH
 Beckton Clipper KT C624
 Beckton Lakme C030 HB

DAM		Calv.Ease	BW	WW	YW	Milk	HPG	Stay	Maint.En.
Age	13	14	-4.3	21	44	21	9	14	-3.9
Wt	1030	Marb -0.11		REA +0.14		Bfat +0.03			
Prog.BW	73	BWt	WWt	WR	ADG	YWt	YR	Scr.	Fr.
WR	108	66	658	111	3.38	1126	104	35	5.0
YR	105								
Wean Pct.	62%								
Cow Eff.	130								

★★★★★ for Low Maintenance, Rib-eye area, Superior Cow, High Cow Efficiency, Calving Ease, Stayability.

• Bulls •

96 BECKTON LANCER X705 L5
1-A 100% # 1382770 Tattoo: BKT0 X705

Birth: 4-14-10
 Beckton Lancer F442 T
BECKTON LANCER T371 H4
 Ref. L-4 Beckton Coca F276 HV
 Beckton Lancer T7 M089
BECKTON LAKME R626 LN
 Beckton Lakme M669 EP
 Beckton Lancer T A664
 Bkt Suffeina A828 DM
 Leachman Heavenly 8141
 Beckton Coca B112 CB
 Beckton Lancer F442 T
 Beckton Tamara G141 HE
 Beckton Epic K F075
 Beckton Lakme F560 TP

DAM		Calv.Ease	BW	WW	YW	Milk	HPG	Stay	Maint.En.
Age	5	10	-1.7	35	66	14	8	14	1.5
Wt	1165	Marb -0.04		REA +0.17		Bfat -0.01			
Prog.BW	76	BWt	WWt	WR	ADG	YWt	YR	Scr.	Fr.
WR	108	74	661	111	4.10	1177	109	34	5.0
YR	108								
Wean Pct.	57%								
Cow Eff.	120								

★★★★★ for Low Maintenance, Growth, Gainability, Rib-eye area, Superior Cow, High Cow Efficiency, Calving Ease, Stayability.

99 BECKTON LOKI X716 W4
1-A 100% # 1382808 Tattoo: BSF0 X716

Birth: 4-15-10
 Beckton Loki C M740
BECKTON LOKI CL S284
 Ref. L-2 Beckton Lakme J460 LT
 Beckton Warrior C C355
BECKTON COCA G809 WR
 Beckton Coca C605 VG
 Beckton Loki F251
 BKT Larkeisa J051 CK
 Beckton Latigo G714
 Beckton Lakme G128 HD
 JKG Chiefton L303
 Bkt Christy 9A01 CL
 Beckton Vegas 9433
 Beckton Coca 8570 MN

DAM		Calv.Ease	BW	WW	YW	Milk	HPG	Stay	Maint.En.
Age	13	9	-0.7	37	68	13	8	12	2.4
Wt	1080	Marb +0.05		REA +0.06		Bfat +0.02			
Prog.BW	81	BWt	WWt	WR	ADG	YWt	YR	Scr.	Fr.
WR	104	85	695	117	3.43	1175	109	35	5.5
YR	103								
Wean Pct.	63%								
Cow Eff.	132								

★★★★★ for Low Maintenance, Growth, Superior Cow, High Cow Efficiency, Calving Ease.

97 BECKTON DOMINOR X230 J5
1-A 100% # 1382885 Tattoo: BSF0 X230

Birth: 3-15-10
 Beckton Dominor ZC M919
BECKTON DOMINOR Z1 R610
 Ref. D-1 Beckton Sierra K557 LO
 Beckton Julian G1 J526
BECKTON ROSE N495 JL
 Beckton Rose J897 HD
 Beckton Dominor Z E401
 Beckton Barmaid J012 CO
 Beckton Loki F251
 Beckton Sierra C157 CL
 Beckton Julian GG B571
 Beckton Annie F743 LN
 Beckton Hadrian F C486
 Beckton Rose D731 CB

DAM		Calv.Ease	BW	WW	YW	Milk	HPG	Stay	Maint.En.
Age	7	16	-4.8	19	45	18	7	16	-3.7
Wt	975	Marb +0.19		REA +0.04		Bfat +0.04			
Prog.BW	69	BWt	WWt	WR	ADG	YWt	YR	Scr.	Fr.
WR	99	70	579	97	3.81	1081	100	37	5.0
YR	98								
Wean Pct.	59%								
Cow Eff.	125								

★★★★★ for Low Maintenance, Marbling, High Cow Efficiency, Calving Ease, Stayability.



98 BECKTON NEBULA X533 E4
1-A 99% # 1382644 Tattoo: BKT0 X533

Birth: 3-30-10
 Beckton Nebula J R475
BECKTON NEBULA T054 H3
 Ref. N-7 BKT Pine Marie R401 HU
 Beckton Epic K F075
BKT PINE MARIE J556 EP
 Bkt Pine Marie F030 CL
 Beckton Nebula M045
 Beckton Larkeisa M138 JC
 Beckton Hustler C2 L079
 Bkt Pine Marie LC30 CD
 Beckton Epic D404
 Beckton Belga D483 KR
 Beckton Clipper KC D400
 Bkt Pine Marie D319 VG

DAM		Calv.Ease	BW	WW	YW	Milk	HPG	Stay	Maint.En.
Age	11	10	-1.6	30	63	9	12	14	-2.4
Wt	1030	Marb +0.09		REA +0.22		Bfat +0.02			
Prog.BW	75	BWt	WWt	WR	ADG	YWt	YR	Scr.	Fr.
WR	102	80	628	106	3.71	1132	105	35	5.5
YR	101								
Wean Pct.	59%								
Cow Eff.	124								

★★★★★ for Low Maintenance, Rib-eye area, High Cow Efficiency, Calving Ease, Stayability.

100 BECKTON EMPEROR X257 J3
1-A 100% # 1382729 Tattoo: BKT0 X257

Birth: 3-17-10
 Beckton Emperor R100
BECKTON EMPEROR T641 E2
 Ref. E-5 Beckton Vernice R416 EP
 Beckton Julian G1 J526
BECKTON DENISE P830 JL
 Beckton Denise L639 JL
 Beckton Epic K4 N795
 Beckton Tamara N180 JO
 Beckton Epic K3 M606
 Beckton Vernice K482 HD
 Beckton Julian GG B571
 Beckton Annie F743 LN
 Beckton Julian GG B571
 Beckton Denise J550 CD

DAM		Calv.Ease	BW	WW	YW	Milk	HPG	Stay	Maint.En.
Age	6	16	-4.7	25	50	16	9	15	-2.4
Wt	1140	Marb +0.22		REA +0.09		Bfat +0.02			
Prog.BW	62	BWt	WWt	WR	ADG	YWt	YR	Scr.	Fr.
WR	97	70	606	102	3.76	1063	98	36	5.0
YR	97								
Wean Pct.	53%								
Cow Eff.	112								

★★★★★ for Low Maintenance, Marbling, Calving Ease, Stayability.

• Bulls •

101 BECKTON WARRIOR X315 H6

1-A 100% # 1382632 Tattoo: BKT0 X315

Birth: 3-20-10

Beckton Warrior N645 T1
 Beckton Warrior T1 H281
 Beckton Rose H074 EP

BECKTON WARRIOR T248 L5
 Ref. W-2
 Beckton Kit R503 LN
 Beckton Lancer F442 T
 Beckton Kit F468 JL

Beckton Champ R A583
 Lchmn Mldd Hvywt2463
 Beckton Minerva CB69 JL
 Beckton Julian GN 9A45
 Bkt Minerva 7016 TJ

DAM		Calv.Ease	BW	WW	YW	Milk	HPG	Stay	Maint.En.
Age	14	9	-1.0	30	58	16	11	15	-3.4
Wt	1095	Marb +.05		REA +.11		Bfat -.01			
Prog.BW	69	BWt	WWt	WR	ADG	YWt	YR	Scr.	Fr.
WR	104	85	615	107	3.57	1082	101	38	5.0
YR	105								
Wean Pct.	54%								
Cow Eff.	114								

★★★★★ for Low Maintenance, Superior Cow, Calving Ease, Stayability.

104 BECKTON EPIC X689 E6

1-A 100% # 1382720 Tattoo: BKT0 X689

Birth: 4-12-10

Beckton Epic K4 N795
 Beckton Epic KJ J722
 Beckton Sierra J789 EP

BECKTON EPIC T330 L5
 Ref. E-3
 Beckton Belga K202 LN
 Beckton Lancer T A664
 Beckton Belga D460 KR

Beckton Epic K F075
 Beckton Epic D404
 Beckton Lakme K697 CT
 Bkt Clifftop TV G672
 Beckton Lakme G128 HD

DAM		Calv.Ease	BW	WW	YW	Milk	HPG	Stay	Maint.En.
Age	6	12	-5.1	16	60	16	6	13	-0.6
Wt	1110	Marb +.14		REA +.13		Bfat +.04			
Prog.BW	73	BWt	WWt	WR	ADG	YWt	YR	Scr.	Fr.
WR	103	77	628	106	4.14	1194	110	36	5.5
YR	105								
Wean Pct.	57%								
Cow Eff.	119								

★★★★★ for Low Maintenance, Gainability, Marbling, Rib-eye area, Superior Cow, High Cow Efficiency, Calving Ease, Stayability.

102 BECKTON RANGER X120 H4

1-A 100% # 1382719 Tattoo: BKT0 X120

Birth: 3-4-10

Beckton Ranger 9479R
 Beckton Ranger 7003
 Beckton Eola 7470 RZ

BECKTON RANGER T603 H3
 Ref. R-1
 Beckton Rose N044 HU
 Beckton Hustler C2 L079
 Beckton Rose L669 JL

Beckton Champ R1 H024
 Beckton Champ RH F275
 Beckton Minerva G034 BR
 Beckton Lana F138 LN
 Beckton Brutus T E062
 Beckton Minerva E442 MB

DAM		Calv.Ease	BW	WW	YW	Milk	HPG	Stay	Maint.En.
Age	6	13	-4.5	13	37	12	9	11	-10.0
Wt	1040	Marb +.13		REA -.18		Bfat -.01			
Prog.BW	68	BWt	WWt	WR	ADG	YWt	YR	Scr.	Fr.
WR	96	75	553	93	4.14	1066	99	38	4.5
YR	99								
Wean Pct.	53%								
Cow Eff.	112								

★★★★★ for Low Maintenance, Gainability, Marbling, Calving Ease.

105 BECKTON RANGER X436 E4

1-A 100% # 1382777 Tattoo: BKT0 X436

Birth: 3-25-10

Beckton Ranger 9479R
 Beckton Ranger 7003
 Beckton Eola 7470 RZ

BECKTON RANGER T603 H3
 Ref. R-1
 Beckton Rose N044 HU
 Beckton Hustler C2 L079
 Beckton Rose L669 JL

Beckton Epic K3 M606
 Beckton Epic KJ J722
 Beckton Sheba M054 JC
 Beckton Lana F268 CT
 Beckton Justice C K449
 Beckton Sheba K206 JC

DAM		Calv.Ease	BW	WW	YW	Milk	HPG	Stay	Maint.En.
Age	5	12	-3.4	18	52	10	8	10	-7.4
Wt	1060	Marb +.05		REA -.04		Bfat +.03			
Prog.BW	65	BWt	WWt	WR	ADG	YWt	YR	Scr.	Fr.
WR	100	75	572	96	4.57	1167	108	38	5.0
YR	98								
Wean Pct.	54%								
Cow Eff.	114								

★★★★★ for Low Maintenance, Gainability, Calving Ease.

103 BECKTON EPIC X082 N6

1-A 100% # 1383415 Tattoo: BKT0 X082

Birth: 2-25-10

Beckton Epic K6 S569
 Beckton Epic KM M115
 Beckton Sierra N703 LM

BECKTON EPIC U095 E5
 Ref. E-6
 Beckton Lydia S274 EP
 Beckton Epic KM M115
 Beckton Lydia M607 LO

Beckton Nebula M045
 Beckton Neptune R2 K065
 Beckton Minerva R086 EP
 Beckton Belga K285 JL
 Beckton Epic KM M115
 Beckton Minerva G321 NP

DAM		Calv.Ease	BW	WW	YW	Milk	HPG	Stay	Maint.En.
Age	2	12	-2.7	38	86	20	10	17	0.7
Wt	880	Marb +.15		REA -.17		Bfat +.04			
Prog.BW	50	BWt	WWt	WR	ADG	YWt	YR	Scr.	Fr.
WR	105	50	562	105	4.38	1183	117	33	5.5
YR	117								
Wean Pct.	57%								
Cow Eff.	120								

★★★★★ for Low Maintenance, Growth, Gainability, Marbling, Superior Cow, High Cow Efficiency, Calving Ease, Stayability.

106 BECKTON HASTEN X218 L3

1-A 100% # 1382879 Tattoo: BSF0 X218

Birth: 3-15-10

Beckton Hasten P292
 Beckton Hasten H S462
 Beckton Hadrian FC E166

Beckton Lancer TH K417
 Beckton Lancer T A664
 Beckton Rose D731 CB
 Beckton Angel G356 HR
 Beckton Cobalt K Z100
 Beckton Rose Z060 RD

DAM		Calv.Ease	BW	WW	YW	Milk	HPG	Stay	Maint.En.
Age	7	12	-3.6	19	52	24	9	12	1.9
Wt	1250	Marb -.04		REA +.01		Bfat +.03			
Prog.BW	65	BWt	WWt	WR	ADG	YWt	YR	Scr.	Fr.
WR	103	78	543	91	3.91	1102	102	35	5.0
YR	103								
Wean Pct.	44%								
Cow Eff.	92								

★★★★★ for Low Maintenance, Calving Ease.

• Bulls •



109 **BECKTON LOKI X378 C4**
1-A 100% # 1383195 Tattoo: BKT0 X378

Birth: 3-22-10
 Beckton Loki C M740
 Beckton Loki F251
 BKT Larkeisa J051 CK
BECKTON LOKI CL S284
 Ref. L-2 Beckton Lakme J460 LT
 Beckton Latigo G714
 Beckton Lakme G128 HD
 BKT Clifftop TP R288
 Beckton Clifftop T C075
 Beckton Christy K209 CO
BECKTON LANA T104 CT
 Beckton Lana R128 LS
 Beckton Laser N602
 Beckton Lana N378 LN

DAM		Calv.Ease	BW	WW	YW	Milk	HPG	Stay	Maint.En.
Age	3	15	-4.7	27	56	17	6	16	1.8
Wt	940								
Prog.BW	60								
WR	109								
YR	107								
Wean Pct.	59%								
Cow Eff.	125								
		Marb	-0.05		REA	+0.25		Bfat	+0.01
		BWt	WWt	WR	ADG	YWt	YR	Scr.	Fr.
		58	596	103	3.67	1107	102	39	5.5

★★★★★ for Low Maintenance, Rib-eye area, Superior Cow, High Cow Efficiency, Calving Ease, Stayability.

107 **BECKTON EPIC X697 D5**
1-A 100% # 1382863 Tattoo: BSF0 X697

Birth: 4-13-10
 Beckton Epic KJ J722
 Beckton Epic K F075
 Beckton Lana F891 JL
BECKTON EPIC K4 N795
 Ref. E-1 Beckton Sierra J789 EP
 Beckton Epic D404
 Beckton Sierra C157 CL
 Beckton Dominor Z E401
 Beckton Dominor 9455
 Beckton Belga B061 ZN
BECKTON BELGA M883 DM
 Beckton Belga HC71 CB
 Beckton Cobalt V AC03
 Beckton Belga 9582VC

DAM		Calv.Ease	BW	WW	YW	Milk	HPG	Stay	Maint.En.
Age	8	11	-1.9	23	61	17	6	12	2.2
Wt	1120								
Prog.BW	66								
WR	100								
YR	100								
Wean Pct.	53%								
Cow Eff.	113								
		Marb	+0.26		REA	+0.16		Bfat	+0.02
		BWt	WWt	WR	ADG	YWt	YR	Scr.	Fr.
		70	598	101	4.00	1144	106	37	5.5

★★★★★ for Low Maintenance, Growth, Gainability, Marbling, Rib-eye area, Calving Ease.

110 **BECKTON EPIC X017 C6**
1-A 100% # 1383377 Tattoo: BKT0 X017

Birth: 2-12-10
 Beckton Epic K4 N795
 Beckton Epic KJ J722
 Beckton Sierra J789 EP
BECKTON EPIC U749 D5
 Ref. E-8 Beckton Denise R308 DM
 Beckton Dominor ZC M919
 Beckton Denise L639 JL
 BKT Clifftop TP R288
 Beckton Clifftop T C075
 Beckton Christy K209 CO
BKT LARKEISA U521 CT
 Beckton Larkeisa N897 HR
 Beckton Herald H1 H348
 Bkt Larkeisa D262 JL

DAM		Calv.Ease	BW	WW	YW	Milk	HPG	Stay	Maint.En.
Age	2	15	-5.5	14	45	18	9	14	2.9
Wt	712								
Prog.BW	56								
WR	96								
YR	102								
Wean Pct.	63%								
Cow Eff.	133								
		Marb	+0.19		REA	+0.21		Bfat	+0.04
		BWt	WWt	WR	ADG	YWt	YR	Scr.	Fr.
		56	510	96	3.81	1032	102	33	5.5

★★★★★ for Low Maintenance, Marbling, Rib-eye area, High Cow Efficiency, Calving Ease, Stayability.

108 **BECKTON LEGEND X021 J3**
1-A 100% # 1383408 Tattoo: BKT0 X021

Birth: 2-13-10
 Beckton Legend S670
 Beckton Lancer F442 T
 Beckton Kit F468 JL
BECKTON LEGEND U331 E2
 Ref. L-7 Beckton Lana S669 EP
 Beckton Epic K4 N795
 Beckton Lana M597 LO
 Beckton Julian GJ P535
 Beckton Julian 7526G
 Beckton Mona D086 JL
BECKTON MINOLA U780 JL
 Beckton Minola N760 HU
 Beckton Hustler CN J102
 Beckton Minola K527 CO

DAM		Calv.Ease	BW	WW	YW	Milk	HPG	Stay	Maint.En.
Age	2	14	-4.2	22	52	13	9	16	-0.7
Wt	820								
Prog.BW	58								
WR	98								
YR	103								
Wean Pct.	56%								
Cow Eff.	118								
		Marb	+0.49		REA	+0.07		Bfat	+0.05
		BWt	WWt	WR	ADG	YWt	YR	Scr.	Fr.
		58	520	98	3.67	1038	103	35	5.0

★★★★★ for Low Maintenance, Marbling, High Cow Efficiency, Calving Ease, Stayability.

111 **BECKTON NEBULA X430 J3**
1-A 99% # 1382817 Tattoo: BSF0 X430

Birth: 3-25-10
 Beckton Nebula M045
 Beckton Neptune R2 K065
 Beckton Belga K285 JL
BECKTON NEBULA T269 E2
 Ref. N-8 Beckton Ruth M967 EP
 Beckton Epic KN H110
 Beckton Ruth A905 SG
 Beckton Julian GG B571
 Beckton Julian 7526G
 Bkt Marta 9A13 JL
BECKTON LANA J235 JL
 Beckton Lana D466 NM
 Beckton Nomad X 9972
 Beckton Lana 9751 MJ

DAM		Calv.Ease	BW	WW	YW	Milk	HPG	Stay	Maint.En.
Age	11	18	-4.9	20	39	16	12	16	-4.4
Wt	1150								
Prog.BW	65								
WR	101								
YR	94								
Wean Pct.	47%								
Cow Eff.	98								
		Marb	+0.02		REA	+0.14		Bfat	+0.01
		BWt	WWt	WR	ADG	YWt	YR	Scr.	Fr.
		60	556	93	3.91	1087	98	34	5.0

★★★★★ for Low Maintenance, Rib-eye area, Calving Ease, Stayability.

• Bulls •

112 BECKTON EPIC X692 E6

1-A 100% # 1382683 Tattoo: BKT0 X692

Birth: 4-13-10

Beckton Epic K4 N795
BECKTON EPIC T330 L5
 Ref. E-3
 Beckton Belga K202 LN

Beckton Epic KJ J722
 Beckton Sierra J789 EP
 Beckton Lancer T A664
 Beckton Belga D460 KR
 Beckton Epic D404
 Beckton Belga D483 KR
 RDD B Topper 1675
 Beckton Lakme 8192NV

Beckton Epic K F075
BECKTON LAKME M669 EP
 Beckton Lakme F560 TP

DAM		Calv.Ease	BW	WW	YW	Milk	HPG	Stay	Maint.En.
Age	8	12	-4.0	21	52	16	6	14	-0.8
Wt	1200	Marb +0.26		REA -0.01		Bfat +0.01			
Prog.BW	71	BWt	WWt	WR	ADG	YWt	YR	Scr.	Fr.
WR	99	74	629	109	3.29	1115	104	36	5.5
YR	98								
Wean Pct.	52%								
Cow Eff.	110								

★★★★★ for Low Maintenance, Marbling, Calving Ease, Stayability.

114 BECKTON EPIC X518 D6

1-A 100% # 1383147 Tattoo: BKT0 X518

Birth: 3-29-10

Beckton Epic K4 N795
BECKTON EPIC T330 L5
 Ref. E-3
 Beckton Belga K202 LN

Beckton Epic KJ J722
 Beckton Sierra J789 EP
 Beckton Lancer T A664
 Beckton Belga D460 KR
 Beckton Dominor Z E401
 Beckton Barmaid J012 CO
 Beckton Dominor ZC M919
BECKTON MARTA S459 DM
 Beckton Marta G675 LN
 Bkt Marta 9A13 JL

DAM		Calv.Ease	BW	WW	YW	Milk	HPG	Stay	Maint.En.
Age	4	15	-5.2	19	57	15	6	15	1.2
Wt	1145	Marb +0.30		REA +0.07		Bfat +0.01			
Prog.BW	68	BWt	WWt	WR	ADG	YWt	YR	Scr.	Fr.
WR	94	68	556	93	4.00	1089	101	36	5.5
YR	104								
Wean Pct.	47%								
Cow Eff.	99								

★★★★★ for Low Maintenance, Gainability, Marbling, Calving Ease, Stayability.

113 BECKTON DOMINOR X454 A5

1-A 100% # 1382994 Tattoo: BSF0 X454

Birth: 3-26-10

Beckton Dominor ZC M919
BECKTON DOMINOR Z1 R610
 Ref. D-1
 Beckton Sierra K557 LO

Beckton Dominor Z E401
 Beckton Barmaid J012 CO
 Beckton Loki F251
 Beckton Sierra C157 CL
 Beckton Cody K G701
 Beckton Tamara J124 HR
 Beckton Scamp T A825
 Beckton Mona J805 BH

Beckton Cody KH M390
BECKTON MONA S304 CD
 Beckton Mona M250 SC

DAM		Calv.Ease	BW	WW	YW	Milk	HPG	Stay	Maint.En.
Age	4	16	-5.2	21	46	19	8	15	-0.5
Wt	920	Marb +0.17		REA +0.03		Bfat +0.05			
Prog.BW	61	BWt	WWt	WR	ADG	YWt	YR	Scr.	Fr.
WR	102	66	572	99	3.71	1044	97	35	5.5
YR	97								
Wean Pct.	60%								
Cow Eff.	126								

★★★★★ for Low Maintenance, Marbling, High Cow Efficiency, Calving Ease, Stayability.

115 BECKTON EMPEROR X394 L3

1-A 100% # 1382839 Tattoo: BSF0 X394

Birth: 3-23-10

Beckton Emperor R100
BECKTON EMPEROR T641 E2
 Ref. E-5
 Beckton Vernice R416 EP

Beckton Epic K4 N795
 Beckton Tamara N180 JO
 Beckton Epic K3 M606
 Beckton Vernice K482 HD
 Beckton Lancer T A664
 Beckton Fayette C110 LN
 Beckton Lancer TL G626
BECKTON INDIGO L588 LN
 Bkt Indigo 9235 GL
 Beckton Galahad 8599
 Bkt Indigo 8631 DT

DAM		Calv.Ease	BW	WW	YW	Milk	HPG	Stay	Maint.En.
Age	9	10	-2.2	27	53	16	7	15	1.3
Wt	1065	Marb +0.09		REA +0.18		Bfat +0.01			
Prog.BW	71	BWt	WWt	WR	ADG	YWt	YR	Scr.	Fr.
WR	101	78	539	91	3.10	1007	93	41	5.0
YR	106								
Wean Pct.	51%								
Cow Eff.	107								

★★★★★ for Low Maintenance, Rib-eye area, Calving Ease, Stayability.



116 BECKTON EMPEROR X210 N3

1-A 100% # 1383208 Tattoo: BKT0 X210

Birth: 3-14-10

Beckton Emperor R100
BECKTON EMPEROR T641 E2
 Ref. E-5
 Beckton Vernice R416 EP

Beckton Epic K4 N795
 Beckton Tamara N180 JO
 Beckton Epic K3 M606
 Beckton Vernice K482 HD
 Beckton Neptune R2 K065
 Beckton Belga K285 JL
 Beckton Nebula M045
BECKTON COCA T168 NB
 Beckton Coca H256 JL
 Beckton Julian 7526G
 Beckton Coca D283 JV

DAM		Calv.Ease	BW	WW	YW	Milk	HPG	Stay	Maint.En.
Age	3	15	-4.1	23	54	15	11	15	1.4
Wt	1115	Marb +0.16		REA -0.02		Bfat +0.03			
Prog.BW	59	BWt	WWt	WR	ADG	YWt	YR	Scr.	Fr.
WR	100	64	574	100	3.76	1074	101	36	5.5
YR	100								
Wean Pct.	48%								
Cow Eff.	101								

★★★★★ for Low Maintenance, Marbling, Calving Ease, Stayability.

• Bulls •

117 BECKTON HERITAGE X537 H3

1-A 100% # 1383010 Tattoo: BSF0 X537

Birth: 3-31-10

Beckton Heritage N013
 Beckton Lana L007 JL
 Beckton Julian GG B571
 Beckton Coca J270 CD
 Beckton Hustler C2 L079
 Beckton Barmaid J012 CO
 Beckton Hustler C G407
 Beckton Ucola HA24 LN

Beckton Heritage T270 J2
 Ref. H-4
 Beckton Coca P602 JL

Beckton Ucola S513 HU
 Beckton Ucola L781 HU

DAM		Calv.Ease	BW	WW	YW	Milk	HPG	Stay	Maint.En.
Age	4	14	-3.4	33	55	9	10	13	-1.7
Wt	1020	Marb +.26		REA -.04		Bfat +.02			
Prog.BW	59	BWt	WWt	WR	ADG	YWt	YR	Scr.	Fr.
WR	99	69	604	102	3.24	1045	97	35	5.5
YR	100								
Wean Pct.	57%								
Cow Eff.	121								

★★★★★ for Low Maintenance, Marbling, High Cow Efficiency, Calving Ease, Stayability.

120 BECKTON LANCER X610 L5

1-A 100% # 1382664 Tattoo: BKT0 X610

Birth: 4-5-10

Beckton Lancer F442 T
 Beckton Lancer T A664
 Bkt Suffeina A828 DM
 Leachman Heavenly 8141
 Beckton Coca B112 CB
 Beckton Lancer T A664
 Bkt Suffeina A828 DM
 Beckton Julian GG B571
 Beckton Lana D697 LN

Beckton Lancer T371 H4
 Ref. L-4
 Beckton Coca F276 HV

Beckton Lancer F442 T
 Beckton Lana L367 LN
 Beckton Lana H143 JL

DAM		Calv.Ease	BW	WW	YW	Milk	HPG	Stay	Maint.En.
Age	9	13	-2.7	30	58	8	7	19	-5.0
Wt	1015	Marb +.01		REA +.26		Bfat -.01			
Prog.BW	69	BWt	WWt	WR	ADG	YWt	YR	Scr.	Fr.
WR	95	72	610	103	3.81	1105	102	37	5.0
YR	99								
Wean Pct.	60%								
Cow Eff.	127								

★★★★★ for Low Maintenance, Rib-eye area, High Cow Efficiency, Calving Ease, Stayability.

118 BECKTON HERITAGE X630 C3

1-A 100% # 1383009 Tattoo: BSF0 X630

Birth: 4-7-10

Beckton Heritage N013
 Beckton Lana L007 JL
 Beckton Julian GG B571
 Beckton Coca J270 CD
 Beckton Hustler C2 L079
 Beckton Barmaid J012 CO
 Beckton Hustler C G407
 Beckton Ucola HA24 LN

Beckton Heritage T270 J2
 Ref. H-4
 Beckton Coca P602 JL

Beckton Clifftop T3 N800
 Beckton Lana J384 CD
 Beckton Lancer T4 J536
 Beckton Marta C314 JL

Beckton Clifftop TV G672
 Beckton Marta N644 LN

DAM		Calv.Ease	BW	WW	YW	Milk	HPG	Stay	Maint.En.
Age	4	15	-4.0	28	50	13	6	15	1.0
Wt	1075	Marb +.37		REA +.12		Bfat +.05			
Prog.BW	76	BWt	WWt	WR	ADG	YWt	YR	Scr.	Fr.
WR	110	66	591	99	3.48	1045	97	38	5.5
YR	108								
Wean Pct.	53%								
Cow Eff.	112								

★★★★★ for Low Maintenance, Marbling, Superior Cow, Calving Ease, Stayability.



119 BECKTON JULIAN X496 W5

1-A 100% # 1383141 Tattoo: BKT0 X496

Birth: 3-28-10

Beckton Julian GJ P535
 Beckton Julian 7526G
 Beckton Mona D086 JL
 Beckton Dominor ZC M919
 Beckton Minola M641 WR
 Beckton Warrior C C355
 Beckton Christy J223 LN
 Beckton Cody V E023
 Beckton Vernice C047 JL

Beckton Julian G5 S107
 Ref. J-4
 Beckton Minola P826 DM

Beckton Warrior CL M686
 Beckton Vernice S380 WR
 Beckton Vernice K798 CD

DAM		Calv.Ease	BW	WW	YW	Milk	HPG	Stay	Maint.En.
Age	4	13	-1.8	28	62	11	15	16	4.0
Wt	1190	Marb +.15		REA +.07		Bfat +.05			
Prog.BW	66	BWt	WWt	WR	ADG	YWt	YR	Scr.	Fr.
WR	97	72	604	102	3.81	1130	104	38	5.0
YR	97								
Wean Pct.	49%								
Cow Eff.	103								

★★★★★ for Low Maintenance, Marbling, Calving Ease, Stayability.

121 BECKTON NEBULA X626 A4

1-A 100% # 1382794 Tattoo: BKT0 X626

Birth: 4-6-10

Beckton Nebula P P707
 Beckton Nebula M045
 Beckton Lana M809 EP
 Beckton Julio L233
 Beckton Lana E083 CD
 Beckton Cody KH M390
 Beckton Rose M126 WR
 Beckton Warrior T1 H281
 Beckton Coca K658 CO

Beckton Nebula PJ S543
 Ref. N-6
 Beckton Lana P685 JO

Beckton Cody K1 P014
 Beckton Coca S115 CD
 Beckton Coca P762 WR

DAM		Calv.Ease	BW	WW	YW	Milk	HPG	Stay	Maint.En.
Age	4	17	-6.0	25	57	17	8	13	-1.3
Wt	1045	Marb +.16		REA +.09		Bfat +.01			
Prog.BW	59	BWt	WWt	WR	ADG	YWt	YR	Scr.	Fr.
WR	103	60	606	102	3.86	1110	103	34	5.5
YR	103								
Wean Pct.	56%								
Cow Eff.	118								

★★★★★ for Low Maintenance, Marbling, High Cow Efficiency, Calving Ease, Stayability.

• Bulls •

122 BECKTON LIKABLE X468 L3

1-A 100% # 1383306 Tattoo: BKT0 X468

Birth: 3-27-10

Beckton Likable S633
 Beckton Lancer F442 T
 Beckton Kit F468 JL

BECKTON LIKABLE U120 L2
 Ref. L-5
 Beckton Lana S718 LN
 Beckton Lancer F442 T
 Beckton Lana F891 JL

Beckton Loki CL S284
 Beckton Loki C M740
 Beckton Lakme J460 LT

BECKTON SERENA U046 LO
 Beckton Serena S649 LO
 Beckton Loki C M740
 Beckton Serena F248 CZ

DAM		Calv.Ease	BW	WW	YW	Milk	HPG	Stay	Maint.En.
Age	2	12	-2.1	34	65	11	5	19	3.7
Wt	995	Marb +.15		REA +.28		Bfat +.02			
Prog.BW	57	BWt	WWt	WR	ADG	YWt	YR	Scr.	Fr.
WR	115	57	612	115	3.71	1113	110	36	5.5
YR	110								
Wean Pct.	56%								
Cow Eff.	117								

★★★★★ for Low Maintenance, Growth, Marbling, Rib-eye area, Superior Cow, High Cow Efficiency, Calving Ease, Stayability.

125 BECKTON NEBULA X461 A3

1-A 100% # 1382671 Tattoo: BKT0 X461

Birth: 3-27-10

Beckton Nebula M045
 Beckton Neptune R2 K065
 Beckton Belga K285 JL

BECKTON NEBULA G S237
 Ref. N-5
 Beckton Lakme LA06 JL
 Beckton Julian GG B571
 Beckton Lakme B370 HV

Beckton Cody V E023
 Beckton Cody C401
 Beckton Birdie C353 VG

BECKTON KURUBA LC61 CD
 Beckton Kuruba D537 CL
 Beckton Clipper JM A124
 Bkt Kuruba 9120 JL

DAM		Calv.Ease	BW	WW	YW	Milk	HPG	Stay	Maint.En.
Age	9	16	-3.9	14	31	13	12	11	-6.6
Wt	1135	Marb +.19		REA -.08		Bfat -.02			
Prog.BW	76	BWt	WWt	WR	ADG	YWt	YR	Scr.	Fr.
WR	109	70	586	98	3.38	1056	98	36	5.0
YR	101								
Wean Pct.	52%								
Cow Eff.	109								

★★★★★ for Low Maintenance, Marbling, Calving Ease.

123 BECKTON DOMINOR X446 C5

1-A 100% # 1383174 Tattoo: BKT0 X446

Birth: 3-26-10

Beckton Dominor ZC M919
 Beckton Dominor Z E401
 Beckton Barmaid J012 CO

BECKTON DOMINOR Z1 R610
 Ref. D-1
 Beckton Sierra K557 LO
 Beckton Loki F251
 Beckton Sierra C157 CL

Beckton Clifftop T3 N800
 Bkt Clifftop TV G672
 Beckton Lana J384 CD

BECKTON SERENA S819 CT
 Beckton Serena M036 HR
 Beckton Herald FN K641
 Beckton Serena K594 HR

DAM		Calv.Ease	BW	WW	YW	Milk	HPG	Stay	Maint.En.
Age	4	13	-3.2	23	57	17	5	13	2.2
Wt	1010	Marb +.28		REA +.06		Bfat +.04			
Prog.BW	73	BWt	WWt	WR	ADG	YWt	YR	Scr.	Fr.
WR	101	73	553	92	4.14	1107	100	35	5.0
YR	102								
Wean Pct.	53%								
Cow Eff.	111								

★★★★★ for Low Maintenance, Gainability, Marbling, Calving Ease, Stayability.

126 BECKTON NEBULA X169 N4

1-A 100% # 1383299 Tattoo: BKT0 X169

Birth: 3-11-10

Beckton Nebula G S237
 Beckton Nebula M045
 Beckton Lakme LA06 JL

BECKTON NEBULA U031 D3
 Ref. N-10
 Beckton Marta S459 DM
 Beckton Dominor ZC M919
 Beckton Marta G675 LN

Beckton Nebula EN S347
 Beckton Nebula E P084
 Beckton Eola P530 NB

BKT PINE MARIE U016 NB
 BKT Pine Marie S349 JE
 Beckton Jules L429
 BKT Pine Marie N194 JL

DAM		Calv.Ease	BW	WW	YW	Milk	HPG	Stay	Maint.En.
Age	2	19	-6.4	23	54	14	9	20	-6.0
Wt	855	Marb +.46		REA -.20		Bfat +.01			
Prog.BW	58	BWt	WWt	WR	ADG	YWt	YR	Scr.	Fr.
WR	101	58	566	101	3.76	1065	101	37	5.0
YR	101								
Wean Pct.	59%								
Cow Eff.	125								

★★★★★ for Low Maintenance, Marbling, High Cow Efficiency, Calving Ease, Stayability.

124 BECKTON LANCER X473 C5

1-A 100% # 1382827 Tattoo: BSF0 X473

Birth: 3-27-10

Beckton Lancer F442 T
 Beckton Lancer T A664
 Bkt Suffeina A828 DM

BECKTON LANCER T371 H4
 Ref. L-4
 Beckton Coca F276 HV
 Leachman Heavenly 8141
 Beckton Coca B112 CB

Beckton Copper JT G095
 Beckton Copper J E616
 Beckton Ruth E549 TP

BECKTON INDIGO K331 CO
 Beckton Indigo F057 CL
 Beckton Clipper JJ D234
 Beckton Indigo D780 JL

DAM		Calv.Ease	BW	WW	YW	Milk	HPG	Stay	Maint.En.
Age	10	13	-3.5	19	42	18	10	14	1.0
Wt	1145	Marb +.16		REA -.02		Bfat -.01			
Prog.BW	70	BWt	WWt	WR	ADG	YWt	YR	Scr.	Fr.
WR	106	64	538	90	4.10	1060	98	38	5.0
YR	99								
Wean Pct.	47%								
Cow Eff.	99								

★★★★★ for Low Maintenance, Gainability, Marbling, Calving Ease, Stayability.

127 BECKTON RANGER X289 E4

1-A 100% # 1382685 Tattoo: BKT0 X289

Birth: 3-18-10

Beckton Ranger 9479R
 Beckton Ranger 7003
 Beckton Eola 7470 RZ

BECKTON RANGER T603 H3
 Ref. R-1
 Beckton Rose N044 HU
 Beckton Hustler C2 L079
 Beckton Rose L669 JL

Beckton Epic K1 K863
 Beckton Epic KN H110
 Beckton Rose H019 SC

BECKTON LANA M809 EP
 Beckton Lana K253 DM
 Beckton Dominor ZJ H657
 Beckton Lana HA34 DM

DAM		Calv.Ease	BW	WW	YW	Milk	HPG	Stay	Maint.En.
Age	8	12	-3.7	13	33	20	8	11	-6.5
Wt	1135	Marb +.35		REA -.10		Bfat +.02			
Prog.BW	73	BWt	WWt	WR	ADG	YWt	YR	Scr.	Fr.
WR	109	72	543	91	3.67	1022	94	38	5.0
YR	108								
Wean Pct.	48%								
Cow Eff.	101								

★★★★★ for Low Maintenance, Marbling, Superior Cow, Calving Ease.

• Bulls •



130 BECKTON DOMINOR X474 W5
1-A 100% # 1382705 Tattoo: BKT0 X474

Birth: 3-27-10
 Beckton Dominor ZC M919
 Beckton Dominor Z E401
 Beckton Barmaid J012 CO
BECKTON DOMINOR Z1 R610
 Ref. D-1 Beckton Sierra K557 LO
 Beckton Loki F251
 Beckton Sierra C157 CL
 Beckton Warrior T1 H281
 Beckton Warrior TC E801
BECKTON TAMARA N709 WR
 Beckton Minerva B609 RN
 Beckton Herald F FA20
 Beckton Tamara G058 CO

DAM		Calv.Ease	BW	WW	YW	Milk	HPG	Stay	Maint.En.
Age	7	17	-6.0	17	45	17	12	14	-0.5
Wt	1140	Marb +.27		REA +.05		Bfat +.05			
Prog.BW	63	BWt	WWt	WR	ADG	YWt	YR	Scr.	Fr.
WR	98	59	557	94	3.57	1033	95	37	5.0
YR	99								
Wean Pct.	49%								
Cow Eff.	103								

★★★★★ for Low Maintenance, Marbling, Calving Ease, Stayability.

128 BECKTON NEBULA X663 E4
1-A 100% # 1382988 Tattoo: BSF0 X663

Birth: 4-9-10
 Beckton Nebula P P707
 Beckton Nebula M045
 Beckton Lana M809 EP
BECKTON NEBULA PJ S543
 Ref. N-6 Beckton Lana P685 JO
 Beckton Julio L233
 Beckton Lana E083 CD
 Beckton Epic K4 N795
 Beckton Epic KJ J722
BECKTON MARTA S195 EP
 Beckton Sierra J789 EP
 Beckton Lancer T A664
 Beckton Marta C314 JL

DAM		Calv.Ease	BW	WW	YW	Milk	HPG	Stay	Maint.En.
Age	4	16	-5.6	28	63	14	3	14	1.9
Wt	1145	Marb +.37		REA +.14		Bfat +.03			
Prog.BW	63	BWt	WWt	WR	ADG	YWt	YR	Scr.	Fr.
WR	106	63	631	106	3.71	1117	103	36	5.5
YR	103								
Wean Pct.	53%								
Cow Eff.	112								

★★★★★ for Low Maintenance, Marbling, Rib-eye area, Superior Cow, Calving Ease, Stayability.

131 BECKTON HERITAGE X412 C3
1-A 100% # 1383196 Tattoo: BKT0 X412

Birth: 3-24-10
 Beckton Heritage N013
 Beckton Hustler C2 L079
 Beckton Lana L007 JL
BECKTON HERITAGE T270 J2
 Ref. H-4 Beckton Coca P602 JL
 Beckton Julian GG B571
 Beckton Coca J270 CD
 Beckton Cherokee N N479
 BFCK Cherokee Cryn 4912
BECKTON TAMARA T111 CQ
 Beckton Tamara J229 NP
 Beckton Dinah C440 NM
 Beckton Neptune RR B284
 Beckton Tamara C931 CL

DAM		Calv.Ease	BW	WW	YW	Milk	HPG	Stay	Maint.En.
Age	3	17	-5.5	27	50	15	11	16	-5.5
Wt	870	Marb +.19		REA +.23		Bfat +.04			
Prog.BW	55	BWt	WWt	WR	ADG	YWt	YR	Scr.	Fr.
WR	105	53	584	102	3.29	1080	102	36	5.0
YR	104								
Wean Pct.	63%								
Cow Eff.	132								

★★★★★ for Low Maintenance, Marbling, Rib-eye area, Superior Cow, High Cow Efficiency, Calving Ease, Stayability.

129 BECKTON EPIC X259 J5
1-A 100% # 1382674 Tattoo: BKT0 X259

Birth: 3-17-10
 Beckton Epic KM M115
 Beckton Epic K F075
 Beckton Minerva F495 CH
BECKTON EPIC K6 S569
 Ref. E-2 Beckton Sierra N703 LM
 Beckton Laramie L044
 Beckton Sierra L887 LN
 Beckton Justice G302
 Beckton Julian GG B571
 Bkt Vernice 9733 PC
BECKTON LARKEISA M138 JC
 Bkt Larkeisa G448 CT
 Beckton Cliffot T C075
 Bkt Larkeisa C894 JV

DAM		Calv.Ease	BW	WW	YW	Milk	HPG	Stay	Maint.En.
Age	8	20	-7.7	15	43	16	11	15	-6.1
Wt	970	Marb +.21		REA +.06		Bfat +.04			
Prog.BW	63	BWt	WWt	WR	ADG	YWt	YR	Scr.	Fr.
WR	97	53	557	94	3.10	1018	94	37	5.0
YR	100								
Wean Pct.	58%								
Cow Eff.	121								

★★★★★ for Low Maintenance, Marbling, High Cow Efficiency, Calving Ease, Stayability.

132 BECKTON LOKI X304 L4
1-A 100% # 1382752 Tattoo: BKT0 X304

Birth: 3-19-10
 Beckton Loki C M740
 Beckton Loki F251
 BKT Larkeisa J051 CK
BECKTON LOKI CL S284
 Ref. L-2 Beckton Lakme J460 LT
 Beckton Latigo G714
 Beckton Lakme G128 HD
 Beckton Laser N602
 Beckton Lancer F442 T
 Beckton Minola E589 TO
BECKTON FIREFLY R298 LS
 Beckton Firefly N457 CO
 Beckton Copper JT G095
 Beckton Firefly K180 CH

DAM		Calv.Ease	BW	WW	YW	Milk	HPG	Stay	Maint.En.
Age	5	12	-3.9	19	41	18	5	16	2.7
Wt	1050	Marb +.04		REA +.01		Bfat +.01			
Prog.BW	73	BWt	WWt	WR	ADG	YWt	YR	Scr.	Fr.
WR	102	73	543	94	3.24	1004	93	37	5.0
YR	103								
Wean Pct.	52%								
Cow Eff.	109								

★★★★★ for Low Maintenance, Calving Ease, Stayability.

• Bulls •

133 BECKTON LEGEND X541 W2

1-A 100% # 1383176 Tattoo: BKT0 X541

Birth: 3-31-10

Beckton Lancer F442 T
Beckton Lancer T A664
Bkt Suffeina A828 DM

BECKTON LEGEND S670
Ref. L-3
Beckton Kit F468 JL
Beckton Julian GG B571
Beckton Kit A517 NP

Beckton Warrior T1 H281
Beckton Warrior TC E801
Beckton Minerva B609 RN

BECKTON SIERRA S847 WR
Beckton Sierra N766 HR
Beckton Herald FJ J776
Beckton Sierra G178 JL

DAM		Calv.Ease	BW	WW	YW	Milk	HPG	Stay	Maint.En.
Age	4	9	.0	32	59	6	16	15	-3.5
Wt	1070	Marb +0.27		REA +0.33		Bfat +0.03			
Prog.BW	86	BWt	WWt	WR	ADG	YWt	YR	Scr.	Fr.
WR	103	84	575	97	3.19	1036	96	34	5.5
YR	102								
Wean Pct.	52%								
Cow Eff.	109								

★★★★★ for Low Maintenance, Marbling, Rib-eye area, Calving Ease, Stayability.

135 BSF CHEROKEE X673 N4

1-B 99% # 1382845 Tattoo: BSF0 X673

Birth: 4-11-10

Beckton Cherokee N N479
BFCK Cherokee Cnyn 4912
Beckton Dinah C440 NM

BECKTON CHEROKEE T450 L3
Ref. C-1
Beckton Annie M337 LN
Beckton Lancer TL G626
Beckton Annie F743 LN

Beckton Neptune R2 K065
Beckton Neptune RR B284
Beckton Lana C735 TP

BSF REGUS M001 NP
BSF Regus K226 NP
Beckton Neptune RR B284
BSF Regus Z112

DAM		Calv.Ease	BW	WW	YW	Milk	HPG	Stay	Maint.En.
Age	8	10	-1.9	30	62	17	11	14	-5.1
Wt	1085	Marb +0.04		REA -0.05		Bfat +0.03			
Prog.BW	73	BWt	WWt	WR	ADG	YWt	YR	Scr.	Fr.
WR	102	76	654	110	3.57	1156	107	36	5.0
YR	103								
Wean Pct.	60%								
Cow Eff.	127								

★★★★★ for Low Maintenance, Growth, High Cow Efficiency, Calving Ease, Stayability.

134 BECKTON NEBULA X179 E4

1-A 100% # 1383194 Tattoo: BKT0 X179

Birth: 3-12-10

Beckton Nebula P P707
Beckton Nebula M045
Beckton Lana M809 EP

BECKTON NEBULA PJ S543
Ref. N-6
Beckton Lana P685 JO
Beckton Julio L233
Beckton Lana E083 CD

Beckton Epic K4 N795
Beckton Epic KJ J722
Beckton Sierra J789 EP

BKT PINE MARIE T100 EP
BKT Pine Marie H175 NP
Beckton Neptune RT Z305
Bkt Pine Marie D319 VG

DAM		Calv.Ease	BW	WW	YW	Milk	HPG	Stay	Maint.En.
Age	3	16	-5.7	23	50	14	5	13	-0.8
Wt	985	Marb +0.31		REA +0.13		Bfat +0.03			
Prog.BW	56	BWt	WWt	WR	ADG	YWt	YR	Scr.	Fr.
WR	93	56	535	93	3.19	994	92	32	5.5
YR	92								
Wean Pct.	50%								
Cow Eff.	106								

★★★★★ for Low Maintenance, Marbling, Rib-eye area, Calving Ease, Stayability.

136 BSF LOKI X396 J4

1-B 99% # 1382957 Tattoo: BSF0 X396

Birth: 3-24-10

Beckton Loki C M740
Beckton Loki F251
BKT Larkeisa J051 CK

BECKTON LOKI CL S284
Ref. L-2
Beckton Lakme J460 LT
Beckton Latigo G714
Beckton Lakme G128 HD

Beckton Jules L429
Beckton Julian G1 J526
Beckton Barona J591 EP

BSF JULESTE R644 JE
BSF Regus D616
Beckton Dominor S B431
BSF Regus B319

DAM		Calv.Ease	BW	WW	YW	Milk	HPG	Stay	Maint.En.
Age	5	17	-6.4	21	45	19	7	14	2.1
Wt	1125	Marb +0.12		REA +0.02		Bfat +0.00			
Prog.BW	66	BWt	WWt	WR	ADG	YWt	YR	Scr.	Fr.
WR	108	59	574	100	4.05	1096	102	39	5.0
YR	105								
Wean Pct.	51%								
Cow Eff.	107								

★★★★★ for Low Maintenance, Gainability, Marbling, Superior Cow, Calving Ease, Stayability.



137 BSF LOKI X245 W4

1-B 99% # 1382877 Tattoo: BSF0 X245

Birth: 3-16-10

Beckton Loki C M740
Beckton Loki F251
BKT Larkeisa J051 CK

BECKTON LOKI CL S284
Ref. L-2
Beckton Lakme J460 LT
Beckton Latigo G714
Beckton Lakme G128 HD

Beckton Warrior T1 H281
Beckton Warrior TC E801
Beckton Minerva B609 RN

BSF WENDIE N343 WR
BSF Regus E323
Beckton Hadrian A100
BSF Regus 8183-2

DAM		Calv.Ease	BW	WW	YW	Milk	HPG	Stay	Maint.En.
Age	7	14	-4.2	23	55	12	11	13	0.8
Wt	1125	Marb +0.00		REA -0.08		Bfat +0.00			
Prog.BW	68	BWt	WWt	WR	ADG	YWt	YR	Scr.	Fr.
WR	99	74	560	94	3.95	1096	101	37	5.0
YR	100								
Wean Pct.	50%								
Cow Eff.	105								

★★★★★ for Low Maintenance, Calving Ease, Stayability.

• Bulls •

138 BSF NEBULA X248 L3

1-B 99% # 1382841 Tattoo: BSF0 X248

Birth: 3-16-10
 Beckton Nebula M045
BECKTON NEBULA G S237
 Ref. N-5
 Beckton Lakme LA06 JL
 Beckton Neptune R2 K065
 Beckton Belga K285 JL
 Beckton Julian GG B571
 Beckton Lakme B370 HV
 Beckton Lancer T A664
 Beckton Fayette C110 LN
 Beckton Caesar M D023
 BSF Regus D006
 Beckton Lancer TL G626
BSF RED ROAN L823 LN
 BSF Regus F207

DAM		Calv.Ease	BW	WW	YW	Milk	HPG	Stay	Maint.En.
Age	9	16	-4.4	15	43	16	8	16	-5.0
Wt	1170	Marb +0.19		REA +0.01		Bfat -.01			
Prog.BW	69	BWt	WWt	WR	ADG	YWt	YR	Scr.	Fr.
WR	102	76	537	90	3.81	1083	100	41	4.5
YR	101								
Wean Pct.	46%								
Cow Eff.	97								

★★★★★ for Low Maintenance, Marbling, Calving Ease, Stayability.

141 BSF RANGER X616 W4

1-B 99% # 1382991 Tattoo: BSF0 X616

Birth: 4-5-10
 Beckton Ranger 9479R
BECKTON RANGER T603 H3
 Ref. R-1
 Beckton Rose N044 HU
 Beckton Ranger 7003
 Beckton Eola 7470 RZ
 Beckton Hustler C2 L079
 Beckton Rose L669 JL
 Beckton Warrior C C355
 Beckton Christy J223 LN
 Beckton Herald F FA20
 BSF Regus F114
 Beckton Warrior CL M686
BSF WARRITA S236 WR
 BSF Regus L114 HR

DAM		Calv.Ease	BW	WW	YW	Milk	HPG	Stay	Maint.En.
Age	4	12	-2.3	29	57	12	13	12	0.1
Wt	1195	Marb +0.16		REA +0.11		Bfat +0.04			
Prog.BW	68	BWt	WWt	WR	ADG	YWt	YR	Scr.	Fr.
WR	105	76	637	107	3.86	1120	104	37	5.0
YR	102								
Wean Pct.	52%								
Cow Eff.	109								

★★★★★ for Low Maintenance, Marbling, Calving Ease.

139 BSF RANGER X503 J4

1-B 99% # 1382965 Tattoo: BSF0 X503

Birth: 3-29-10
 Beckton Ranger 9479R
BECKTON RANGER T603 H3
 Ref. R-1
 Beckton Rose N044 HU
 Beckton Ranger 7003
 Beckton Eola 7470 RZ
 Beckton Hustler C2 L079
 Beckton Rose L669 JL
 Beckton Julian GG B571
 Bkt Vernice 9733 PC
 Beckton Champ R1 H024
 BSF Red D116
 Beckton Justice G302
BSF JUSTICIA R750 JC
 BSF Regus M133 CH

DAM		Calv.Ease	BW	WW	YW	Milk	HPG	Stay	Maint.En.
Age	5	16	-5.1	21	43	11	11	10	-5.5
Wt	1125	Marb +0.04		REA +0.01		Bfat +0.02			
Prog.BW	60	BWt	WWt	WR	ADG	YWt	YR	Scr.	Fr.
WR	95	60	588	99	4.00	1090	101	34	5.0
YR	97								
Wean Pct.	52%								
Cow Eff.	110								

★★★★★ for Low Maintenance, Gainability, Calving Ease.



140 BSF HERITAGE X460 E3

1-B 99% # 1383004 Tattoo: BSF0 X460

Birth: 3-27-10
 Beckton Heritage N013
BECKTON HERITAGE T270 J2
 Ref. H-4
 Beckton Coca P602 JL
 Beckton Epic K3 M606
BSF EPIQUETTE S429 EP
 BSF Regus L003 HU
 Beckton Hustler C2 L079
 Beckton Lana L007 JL
 Beckton Julian GG B571
 Beckton Coca J270 CD
 Beckton Epic KJ J722
 Beckton Lana F268 CT
 Beckton Hustler CN J102
 BSF Red J219

DAM		Calv.Ease	BW	WW	YW	Milk	HPG	Stay	Maint.En.
Age	4	14	-4.1	28	56	10	8	13	-7.0
Wt	875	Marb +0.22		REA -0.03		Bfat +0.03			
Prog.BW	59	BWt	WWt	WR	ADG	YWt	YR	Scr.	Fr.
WR	83	68	619	104	3.71	1125	104	33	5.0
YR	100								
Wean Pct.	69%								
Cow Eff.	144								

★★★★★ for Low Maintenance, Marbling, High Cow Efficiency, Calving Ease, Stayability.

142 BSF NEBULA X605 W3

1-B 99% # 1382843 Tattoo: BSF0 X605

Birth: 4-4-10
 Beckton Nebula M045
BECKTON NEBULA T269 E2
 Ref. N-8
 Beckton Ruth M967 EP
 Beckton Neptune R2 K065
 Beckton Belga K285 JL
 Beckton Epic KN H110
 Beckton Ruth A905 SG
 JKG Chiefton L303
 Beckton Tamla A671 TR
 Beckton Cody V E023
 BSF Regus D038
 Beckton Warrior T C371
BSF REGUS L897 WR
 BSF Regus H341

DAM		Calv.Ease	BW	WW	YW	Milk	HPG	Stay	Maint.En.
Age	9	12	-2.2	26	55	18	11	13	-7.0
Wt	1125	Marb +0.18		REA +0.03		Bfat +0.02			
Prog.BW	71	BWt	WWt	WR	ADG	YWt	YR	Scr.	Fr.
WR	103	69	628	106	3.81	1122	104	34	5.0
YR	99								
Wean Pct.	56%								
Cow Eff.	118								

★★★★★ for Low Maintenance, Marbling, High Cow Efficiency, Calving Ease, Stayability.

• Bulls •

143 BSF LOKI X511 J4

1-B 99% # 1383057 Tattoo: BSF0 X511

Birth: 3-29-10

Beckton Loki C M740
BECKTON LOKI CL S284
 Ref. L-2

Beckton Lakme J460 LT

Beckton Loki F251
 BKT Larkeisa J051 CK

Beckton Latigo G714
 Beckton Lakme G128 HD

Beckton Julio L233
BSF JULIA T623 JO

Beckton Julian G1 J526
 Beckton Rose J725 EP

Beckton Neptune R2 K065
 BSF Regus K326 WH

DAM		Calv.Ease	BW	WW	YW	Milk	HPG	Stay	Maint.En.
Age	3	16	-5.2	27	57	16	6	15	1.9
Wt	1005	Marb +.03		REA -.06		Bfat +.01			
Prog.BW	65	BWt	WWt	WR	ADG	YWt	YR	Scr.	Fr.
WR	110	57	641	112	3.24	1101	104	36	5.5
YR	107								
Wean Pct.	60%								
Cow Eff.	126								

★★★★★ for Low Maintenance, Superior Cow, High Cow Efficiency, Calving Ease, Stayability.

146 BSF NEBULA X477 J4

1-B 99% # 1383038 Tattoo: BSF0 X477

Birth: 3-27-10

Beckton Nebula L P093
BECKTON NEBULA T398 V3
 Ref. N-9

Beckton Minerva J615 VG

Beckton Nebula M045
 Beckton Marta M021 LN

Beckton Vegas PK F485
 Beckton Minerva F433 VG

Beckton Justice C1 R483
BSF NEBULANN T046 JC

Beckton Justice CH M056
 Beckton Tamara J124 HR

Beckton Nebula M045
 BSF Regus M043 JC

DAM		Calv.Ease	BW	WW	YW	Milk	HPG	Stay	Maint.En.
Age	3	18	-6.0	27	56	18	11	13	-4.5
Wt	880	Marb +.19		REA +.04		Bfat +.03			
Prog.BW	50	BWt	WWt	WR	ADG	YWt	YR	Scr.	Fr.
WR	109	53	598	104	3.38	1058	100	37	5.0
YR	104								
Wean Pct.	63%								
Cow Eff.	134								

★★★★★ for Low Maintenance, Marbling, Superior Cow, High Cow Efficiency, Calving Ease, Stayability.

144 BSF EPIC X097 C6

1-B 99% # 1383084 Tattoo: BSF0 X097

Birth: 2-28-10

Beckton Epic K4 N795
BECKTON EPIC U749 D5
 Ref. E-8

Beckton Denise R308 DM

Beckton Epic KJ J722
 Beckton Sierra J789 EP

Beckton Dominor ZC M919
 Beckton Denise L639 JL

BKT Clifftop TP R288
BSF NEBULANN U145 CT

Beckton Clifftop T C075
 Beckton Christy K209 CO

Beckton Nebula M045
 BSF Regus F175

DAM		Calv.Ease	BW	WW	YW	Milk	HPG	Stay	Maint.En.
Age	2	14	-3.9	23	59	17	9	15	-1.0
Wt	840	Marb +.25		REA +.34		Bfat +.04			
Prog.BW	56	BWt	WWt	WR	ADG	YWt	YR	Scr.	Fr.
WR	102	56	541	102	3.67	1054	104	30	5.0
YR	104								
Wean Pct.	57%								
Cow Eff.	121								

★★★★★ for Low Maintenance, Marbling, Rib-eye area, High Cow Efficiency, Calving Ease, Stayability.

147 BSF RANGER X679 A4

1-B 99% # 1382864 Tattoo: BSF0 X679

Birth: 4-12-10

Beckton Ranger 9479R
BECKTON RANGER T603 H3
 Ref. R-1

Beckton Rose N044 HU

Beckton Ranger 7003
 Beckton Eola 7470 RZ

Beckton Hustler C2 L079
 Beckton Rose L669 JL

Beckton Colter HW J766
BSF REGUS M902 CR

Beckton Minerva E200 WR
 Beckton Clifftop TC E081
 BSF Regus C181

DAM		Calv.Ease	BW	WW	YW	Milk	HPG	Stay	Maint.En.
Age	8	15	-5.4	11	31	15	11	11	-12.0
Wt	880	Marb +.11		REA -.18		Bfat +.03			
Prog.BW	66	BWt	WWt	WR	ADG	YWt	YR	Scr.	Fr.
WR	102	68	598	101	3.76	1090	101	32	5.0
YR	103								
Wean Pct.	68%								
Cow Eff.	143								

★★★★★ for Low Maintenance, Marbling, High Cow Efficiency, Calving Ease.

145 BSF JAVELIN X323 C3

1-B 99% # 1383051 Tattoo: BSF0 X323

Birth: 3-20-10

Beckton Javelin 6587
BKT JAVELIN 7466 R
 Ref. J

Beckton Rose 6807 RZ

Beckton Trojan 5253
 Beckton Ileximka -3

Beckton Raza 2308-N
 Bkt Baya Rose 5195

Beckton Cherokee N N479
BSF CHERISE T387 CQ

BFCK Cherokee Cnyn 4912
 Beckton Dinah C440 NM

Beckton Caesar M D023
 BSF Regus Z112

DAM		Calv.Ease	BW	WW	YW	Milk	HPG	Stay	Maint.En.
Age	3	13	-4.5	8	22	21	12	14	-8.3
Wt	1020	Marb +.19		REA +.02		Bfat +.02			
Prog.BW	64	BWt	WWt	WR	ADG	YWt	YR	Scr.	Fr.
WR	102	67	582	102	3.38	1036	98	37	5.0
YR	98								
Wean Pct.	53%								
Cow Eff.	112								

★★★★★ for Low Maintenance, Marbling, Calving Ease, Stayability.

148 BSF DOMINOR X760 C5

1-B 99% # 1383059 Tattoo: BSF0 X760

Birth: 4-21-10

Beckton Dominor ZC M919
BECKTON DOMINOR Z1 R610
 Ref. D-1

Beckton Sierra K557 LO

Beckton Dominor Z E401
 Beckton Barmaid J012 CO

Beckton Loki F251
 Beckton Sierra C157 CL

Beckton Clifftop T3 N800
BSF NEBULANN T682 CT

Beckton Lana J384 CD
 Beckton Nebula M045
 BSF Regus M717 EP

DAM		Calv.Ease	BW	WW	YW	Milk	HPG	Stay	Maint.En.
Age	3	14	-4.1	24	60	17	5	14	-1.8
Wt	895	Marb +.31		REA +.07		Bfat +.06			
Prog.BW	61	BWt	WWt	WR	ADG	YWt	YR	Scr.	Fr.
WR	103	65	610	107	3.71	1122	106	34	5.5
YR	105								
Wean Pct.	64%								
Cow Eff.	134								

★★★★★ for Low Maintenance, Marbling, Superior Cow, High Cow Efficiency, Calving Ease, Stayability.

• Bulls •



151 BECKTON NEBULA X512 W3
1-A 99% # 1383253 Tattoo: BKT0 X512

Birth: 3-29-10
 Beckton Nebula M045
 Beckton Neptune R2 K065
BECKTON NEBULA T269 E2
 Ref. N-8 Beckton Ruth M967 EP
 Beckton Belga K285 JL
 Beckton Epic KN H110
 Beckton Ruth A905 SG
 Beckton Warhawk N560
 Beckton Warrior T1 H281
BECKTON SIERRA T474 WA
 Beckton Sierra N766 HR
 Beckton Firefly H195 HD
 Beckton Herald FJ J776
 Beckton Sierra G178 JL

DAM		Calv.Ease	BW	WW	YW	Milk	HPG	Stay	Maint.En.
Age	3	15	-4.9	21	56	16	15	15	-5.1
Wt	860	Marb +0.21		REA +0.04		Bfat +0.05			
Prog.BW	64	BWt	WWt	WR	ADG	YWt	YR	Scr.	Fr.
WR	97	70	573	100	4.29	1124	106	33	5.5
YR	103								
Wean Pct.	62%								
Cow Eff.	130								

★★★★★ for Low Maintenance, Gainability, Marbling, High Cow Efficiency, Calving Ease, Stayability.

149 BSF JULES X360 L2
1-B 99% # 1383024 Tattoo: BSF0 X360

Birth: 3-21-10
 Beckton Julian G1 J526
BECKTON JULES L429
 Ref. J-2 Beckton Barona J591 EP
 Beckton Annie F743 LN
 Beckton Epic K F075
 Beckton Barona E134 RN
 Beckton Lancer T9 N586
 Beckton Lancer TA K644
 BKT Larkeisa H232 SC
BSF LANETTE S768 LN
 BSF Regus G195
 Beckton Emperor C369
 BSF Regus 8099

DAM		Calv.Ease	BW	WW	YW	Milk	HPG	Stay	Maint.En.
Age	4	18	-6.9	11	24	17	10	15	-3.7
Wt	1055	Marb +0.02		REA +0.05		Bfat +0.02			
Prog.BW	61	BWt	WWt	WR	ADG	YWt	YR	Scr.	Fr.
WR	98	53	551	93	3.19	983	91	36	5.0
YR	104								
Wean Pct.	50%								
Cow Eff.	106								

★★★★★ for Low Maintenance, Calving Ease, Stayability.

152 BECKTON EPIC X796 J5
1-A 100% # 1383182 Tattoo: BKT0 X796

Birth: 4-28-10
 Beckton Epic KM M115
BECKTON EPIC K6 S569
 Ref. E-2 Beckton Sierra N703 LM
 Beckton Epic K F075
 Beckton Minerva F495 CH
 Beckton Laramie L044
 Beckton Sierra L887 LN
 Beckton Justice C2 R695
 Beckton Justice CH M056
 Beckton Tamara M878 JC
BECKTON ANNIE T016 JC
 Beckton Annie R650 DM
 Beckton Dominor ZC M919
 Beckton Annie E066 WR

DAM		Calv.Ease	BW	WW	YW	Milk	HPG	Stay	Maint.En.
Age	3	10	-2.7	25	73	16	11	16	-5.6
Wt	792	Marb +0.35		REA +0.08		Bfat +0.06			
Prog.BW	67	BWt	WWt	WR	ADG	YWt	YR	Scr.	Fr.
WR	109	82	667	116	4.00	1189	112	37	6.0
YR	106								
Wean Pct.	79%								
Cow Eff.	167								

★★★★★ for Low Maintenance, Growth, Gainability, Marbling, Superior Cow, High Cow Efficiency, Calving Ease, Stayability.

150 BSF EPIC X167 A6
1-B 99% # 1382613 Tattoo: BSF0 X167

Birth: 3-11-10
 Beckton Epic K4 N795
BECKTON EPIC T524 L5
 Ref. E-4 Beckton Rose L083 LN
 Beckton Epic KJ J722
 Beckton Sierra J789 EP
 Beckton Lancer T4 J536
 Beckton Rose J152 LN
 Beckton Cody KH M390
 Beckton Tamara K249 VG
 Beckton Cody K2 R168
 Beckton Jules L429
 BSF Jules R249 JE
 BSF Red K467 CD

DAM		Calv.Ease	BW	WW	YW	Milk	HPG	Stay	Maint.En.
Age	2	13	-3.9	22	58	17	8	13	0.7
Wt	930	Marb +0.31		REA +0.29		Bfat +0.06			
Prog.BW	62	BWt	WWt	WR	ADG	YWt	YR	Scr.	Fr.
WR	103	62	548	103	3.76	1052	104	31	5.5
YR	104								
Wean Pct.	52%								
Cow Eff.	110								

★★★★★ for Low Maintenance, Marbling, Rib-eye area, Calving Ease, Stayability.

153 BECKTON EPIC X598 L6
1-A 100% # 1382987 Tattoo: BSF0 X598

Birth: 4-3-10
 Beckton Epic K4 N795
BECKTON EPIC T330 L5
 Ref. E-3 Beckton Belga K202 LN
 Beckton Epic KJ J722
 Beckton Sierra J789 EP
 Beckton Lancer T A664
 Beckton Belga D460 KR
 Beckton Lancer T7 M089
 Beckton Lancer F442 T
 Beckton Tamara G141 HE
BECKTON CHRISTY S192 LN
 Beckton Christy J743 JL
 Beckton Julian GG B571
 Beckton Christy A111 VQ

DAM		Calv.Ease	BW	WW	YW	Milk	HPG	Stay	Maint.En.
Age	4	15	-4.9	19	51	16	7	15	-0.6
Wt	980	Marb +0.15		REA +0.20		Bfat -0.01			
Prog.BW	66	BWt	WWt	WR	ADG	YWt	YR	Scr.	Fr.
WR	110	63	561	94	3.62	1078	100	36	5.5
YR	110								
Wean Pct.	55%								
Cow Eff.	116								

★★★★★ for Low Maintenance, Marbling, Rib-eye area, Superior Cow, High Cow Efficiency, Calving Ease, Stayability.

• Bulls •

154 BECKTON JET X093 C3

1-A 100% # 1383354 Tattoo: BKT0 X093

Birth: 2-27-10

Beckton Jet L P491
BECKTON JET U473 L2
 Ref. J-5

Beckton Lydia N047 LM

Beckton Cherokee N N479
BECKTON VERNICE U385 CQ
 Beckton Vernice R416 EP

TR Julian LT151
 Beckton Minerva L278 LN
 Beckton Laramie L044
 Beckton Lydia L647 JL
 BFCK Cherokee Cnyn 4912
 Beckton Dinah C440 NM
 Beckton Epic K3 M606
 Beckton Vernice K482 HD

DAM		Calv.Ease	BW	WW	YW	Milk	HPG	Stay	Maint.En.
Age	2	13	-4.2	22	60	22	11	16	-3.4
Wt	832	Marb +.20		REA +.23		Bfat +.04			
Prog.BW	69	BWt	WWt	WR	ADG	YWt	YR	Scr.	Fr.
WR	87	69	487	87	4.10	1062	101	38	5.0
YR	101								
Wean Pct.	51%								
Cow Eff.	108								

★★★★★ for Low Maintenance, Gainability, Marbling, Rib-eye area, Calving Ease, Stayability.

156 BECKTON NEBULA X589 C4

1-A 99% # 1382643 Tattoo: BKT0 X589

Birth: 4-3-10

Beckton Nebula J R475
BECKTON NEBULA T054 H3
 Ref. N-7

BKT Pine Marie R401 HU

Beckton Nebula M045
 Beckton Larkeisa M138 JC
 Beckton Hustler C2 L079
 Bkt Pine Marie LC30 CD
 Beckton Champ R A583
 Beckton Christy Z453 KR
 Beckton Vegas 9433
 Beckton Lana A688 JL

DAM		Calv.Ease	BW	WW	YW	Milk	HPG	Stay	Maint.En.
Age	11	11	-3.2	24	51	16	11	12	1.1
Wt	1165	Marb +.00		REA +.27		Bfat +.02			
Prog.BW	76	BWt	WWt	WR	ADG	YWt	YR	Scr.	Fr.
WR	107	79	528	92	3.86	1057	98	35	5.5
YR	106								
Wean Pct.	42%								
Cow Eff.	99								

★★★★★ for Low Maintenance, Rib-eye area, Superior Cow, Calving Ease.

155 BECKTON NEBULA X024 E4

1-A 100% # 1383329 Tattoo: BKT0 X024

Birth: 2-14-10

Beckton Nebula G S237
BECKTON NEBULA U031 D3
 Ref. N-10

Beckton Marta S459 DM

Beckton Epitomy S250
BECKTON LARKABA U193 EY
 Beckton Larkaba S083 JL

Beckton Nebula M045
 Beckton Lakme LA06 JL
 Beckton Dominor ZC M919
 Beckton Marta G675 LN
 Beckton Epic K4 N795
 Beckton Tara M635 JL
 Beckton Julian G3 P608
 Beckton Larkaba P645 JL

DAM		Calv.Ease	BW	WW	YW	Milk	HPG	Stay	Maint.En.
Age	2	17	-4.4	22	61	13	10	20	-1.2
Wt	910	Marb +.45		REA +.02		Bfat -.01			
Prog.BW	65	BWt	WWt	WR	ADG	YWt	YR	Scr.	Fr.
WR	93	65	496	93	4.00	1036	103		5.5
YR	103								
Wean Pct.	48%								
Cow Eff.	101								

★★★★★ for Low Maintenance, Gainability, Marbling, Calving Ease, Stayability.

157 BECKTON EPIC X104 J6

1-A 100% # 1383103 Tattoo: BSF0 X104

Birth: 3-1-10

Beckton Epic K4 N795
BECKTON EPIC U749 D5
 Ref. E-8

Beckton Denise R308 DM

Beckton Juno N493
BECKTON ROSE U272 JJ
 Beckton Rose G345 JL

Beckton Epic KJ J722
 Beckton Sierra J789 EP
 Beckton Dominor ZC M919
 Beckton Denise L639 JL
 Beckton Julian G1 J526
 Beckton Serena D760 KR
 Beckton Julian GG B571
 Beckton Rose D741 LN

DAM		Calv.Ease	BW	WW	YW	Milk	HPG	Stay	Maint.En.
Age	2	17	-5.3	23	54	13	8	16	0.1
Wt	790	Marb +.16		REA +.24		Bfat +.02			
Prog.BW	50	BWt	WWt	WR	ADG	YWt	YR	Scr.	Fr.
WR	96	50	509	96	3.76	1035	103	34	5.5
YR	103								
Wean Pct.	57%								
Cow Eff.	120								

★★★★★ for Low Maintenance, Marbling, Rib-eye area, High Cow Efficiency, Calving Ease, Stayability.



158 BECKTON EPIC X650 J6

1-A 100% # 1382754 Tattoo: BKT0 X650

Birth: 4-8-10

Beckton Epic K4 N795
BECKTON EPIC T330 L5
 Ref. E-3

Beckton Belga K202 LN

Beckton Justice C K449
BECKTON LANA R330 JC
 Beckton Lana L538 LN

Beckton Epic KJ J722
 Beckton Sierra J789 EP
 Beckton Lancer T A664
 Beckton Belga D460 KR
 Beckton Justice G302
 Bkt Larkabel C742 CF
 Beckton Lancer TL G626
 Beckton Lana G514 CD

DAM		Calv.Ease	BW	WW	YW	Milk	HPG	Stay	Maint.En.
Age	5	15	-4.9	19	52	12	7	13	-0.3
Wt	1080	Marb +.24		REA +.10		Bfat -.01			
Prog.BW	74	BWt	WWt	WR	ADG	YWt	YR	Scr.	Fr.
WR	98	68	545	92	3.91	1069	99	37	5.5
YR	102								
Wean Pct.	50%								
Cow Eff.	106								

★★★★★ for Low Maintenance, Marbling, Calving Ease, Stayability.

• Bulls •

159 BECKTON JULIAN X493 W6

1-A 100% # 1383130 Tattoo: BSF0 X493

Birth: 3-28-10

Beckton Julian G1 J526
 Beckton Julian GG B571
 Beckton Annie F743 LN

BECKTON JULIAN U699 L5
 Ref. J-6
 Beckton Rose L311 LN
 Beckton Lancer F442 T
 Beckton Rose H292 HD

Beckton Warrior N645 T1
 Beckton Warrior T1 H281
 Beckton Rose H074 EP

BECKTON BELGA U492 WR
 Beckton Belga P119 EP
 Beckton Epic KJ J722
 Beckton Belga K476 JL

DAM		Calv.Ease	BW	WW	YW	Milk	HPG	Stay	Maint.En.
Age	2	12	-2.4	36	67	11	10	15	-2.5
Wt	1050	Marb +.11		REA +.05		Bfat +.01			
Prog.BW	55	BWt	WWt	WR	ADG	YWt	YR	Scr.	Fr.
WR	105	55	573	105	3.52	1083	106	36	5.5
YR	106								
Wean Pct.	49%								
Cow Eff.	103								

★★★★★ for Low Maintenance, Growth, Marbling, Superior Cow, Calving Ease, Stayability.

162 BECKTON DOMINOR X728 L5

1-A 100% # 1382650 Tattoo: BKT0 X728

Birth: 4-16-10

Beckton Dominor ZC M919
 Beckton Dominor Z E401
 Beckton Barmaid J012 CO

BECKTON DOMINOR Z1 R610
 Ref. D-1
 Beckton Sierra K557 LO
 Beckton Loki F251
 Beckton Sierra C157 CL

Beckton Lancer T A664
 Beckton Lancer 9380
 Beckton Coca 9119 TJ

BECKTON BELGA K202 LN
 Beckton Belga D460 KR
 Beckton Kaiser FD 9253
 Beckton Belga A573 SC

DAM		Calv.Ease	BW	WW	YW	Milk	HPG	Stay	Maint.En.
Age	10	17	-6.4	13	40	16	6	16	-0.1
Wt	1140	Marb +.19		REA +.05		Bfat +.02			
Prog.BW	61	BWt	WWt	WR	ADG	YWt	YR	Scr.	Fr.
WR	97	70	539	91	3.95	1028	95	34	5.5
YR	99								
Wean Pct.	47%								
Cow Eff.	100								

★★★★★ for Low Maintenance, Marbling, Calving Ease, Stayability.

160 BECKTON LOKI X715 L4

1-A 100% # 1383150 Tattoo: BKT0 X715

Birth: 4-15-10

Beckton Loki C M740
 Beckton Loki F251
 BKT Larkeisa J051 CK

BECKTON LOKI CL S284
 Ref. L-2
 Beckton Lakme J460 LT
 Beckton Latigo G714
 Beckton Lakme G128 HD

Beckton Lancer F442 T
 Beckton Lancer T A664
 Bkt Suffeina A828 DM

BECKTON KIT S478 LN
 Beckton Kit F468 JL
 Beckton Julian GG B571
 Beckton Kit A517 NP

DAM		Calv.Ease	BW	WW	YW	Milk	HPG	Stay	Maint.En.
Age	4	14	-3.9	27	52	12	5	15	2.2
Wt	1165	Marb +.08		REA +.24		Bfat +.00			
Prog.BW	68	BWt	WWt	WR	ADG	YWt	YR	Scr.	Fr.
WR	102	69	604	102	3.29	1074	99	35	5.5
YR	102								
Wean Pct.	50%								
Cow Eff.	106								

★★★★★ for Low Maintenance, Rib-eye area, Calving Ease, Stayability.



161 BECKTON JANUS X758 E2

1-A 100% # 1383277 Tattoo: BKT0 X758

Birth: 4-21-10

TR Romeo NT379
 Buffalo Creek Romeo L081
 Buf Crk Lass L420

BECKTON ROMAN J S158
 Ref. O-1
 Beckton Belga K285 JL
 Beckton Julian GG B571
 Beckton Belga G493 HR

Beckton Epic KM M115
 Beckton Epic K F075
 Beckton Minerva F495 CH

BECKTON LAKME T692 EP
 Beckton Lakme P513 EP
 Beckton Epic K F075
 Beckton Lakme K697 CT

DAM		Calv.Ease	BW	WW	YW	Milk	HPG	Stay	Maint.En.
Age	3	10	-0.7	38	76	22	8	14	-0.1
Wt	1000	Marb +.03		REA +.17		Bfat +.01			
Prog.BW	70	BWt	WWt	WR	ADG	YWt	YR	Scr.	Fr.
WR	105	69	593	104	3.43	1095	103	32	6.0
YR	110								
Wean Pct.	55%								
Cow Eff.	117								

★★★★★ for Low Maintenance, Rib-eye area, Superior Cow, High Cow Efficiency, Calving Ease, Stayability.

163 BECKTON JANUS X815 H2

1-A 100% # 1382795 Tattoo: BKT0 X815

Birth: 5-5-10

TR Romeo NT379
 Buffalo Creek Romeo L081
 Buf Crk Lass L420

BECKTON ROMAN J S158
 Ref. O-1
 Beckton Belga K285 JL
 Beckton Julian GG B571
 Beckton Belga G493 HR

Beckton Hawk P248
 Beckton Hustler C2 L079
 Beckton Lana L498 CO

BECKTON SIERRA S120 HW
 Beckton Sierra P348 JO
 Beckton Julio L233
 Beckton Sierra J659 DM

DAM		Calv.Ease	BW	WW	YW	Milk	HPG	Stay	Maint.En.
Age	4	8	0.7	41	66	18	7	14	-2.6
Wt	900	Marb +.00		REA +.19		Bfat -.03			
Prog.BW	74	BWt	WWt	WR	ADG	YWt	YR	Scr.	Fr.
WR	105	87	653	109	3.48	1115	101	33	6.0
YR	103								
Wean Pct.	70%								
Cow Eff.	148								

★★★★★ for Low Maintenance, Rib-eye area, High Cow Efficiency, Calving Ease, Stayability.

• Bulls •

164 BECKTON NEBULA X781 E4

1-A 100% # 1382975 Tattoo: BSF0 X781

Birth: 4-25-10

Beckton Nebula P P707
 Beckton Nebula M045
 Beckton Lana M809 EP

BECKTON NEBULA PJ S543
 Ref. N-6
 Beckton Lana P685 JO
 Beckton Julio L233
 Beckton Lana E083 CD

Beckton Epic K5 P071
 Beckton Epic KM M115
 Beckton Minerva M179 LN

BECKTON LANA S039 EP
 Beckton Lana P639 LN
 Beckton Lancer T4 J536
 Beckton Lana J790 EP

DAM		Calv.Ease	BW	WW	YW	Milk	HPG	Stay	Maint.En.
Age	4	10	-2.0	32	70	15	8	16	3.2
Wt	1155	Marb +0.35		REA -0.01		Bfat +0.02			
Prog.BW	68	BWt	WWt	WR	ADG	YWt	YR	Scr.	Fr.
WR	95	89	565	95	3.52	1049	97	36	5.5
YR	94								
Wean Pct.	47%								
Cow Eff.	99								

★★★★★ for Low Maintenance, Marbling, Calving Ease, Stayability.

167 BECKTON JULIAN X154 E6

1-A 100% # 1383305 Tattoo: BKT0 X154

Birth: 3-10-10

Beckton Julian G1 J526
 Beckton Julian GG B571
 Beckton Annie F743 LN

BECKTON JULIAN U699 L5
 Ref. J-6
 Beckton Rose L311 LN
 Beckton Lancer F442 T
 Beckton Rose H292 HD

Beckton Emcee S466
 Beckton Epic K4 N795
 Beckton Larkaba H798 WR

BECKTON SUSAN U045 EC
 Beckton Susan S684 JJ
 Beckton Juno N493
 Beckton Susan M144 CH

DAM		Calv.Ease	BW	WW	YW	Milk	HPG	Stay	Maint.En.
Age	2	15	-4.3	34	63	15	6	15	-3.6
Wt	810	Marb +0.22		REA +0.05		Bfat +0.01			
Prog.BW	65	BWt	WWt	WR	ADG	YWt	YR	Scr.	Fr.
WR	113	65	603	113	3.33	1084	107	36	5.0
YR	107								
Wean Pct.	67%								
Cow Eff.	141								

★★★★★ for Low Maintenance, Growth, Marbling, Superior Cow, High Cow Efficiency, Calving Ease, Stayability.

165 BECKTON EPIC X531 J6

1-A 100% # 1383117 Tattoo: BSF0 X531

Birth: 3-30-10

Beckton Epic K4 N795
 Beckton Epic KJ J722
 Beckton Sierra J789 EP

BECKTON EPIC T524 L5
 Ref. E-4
 Beckton Rose L083 LN
 Beckton Lancer T4 J536
 Beckton Rose J152 LN

TR Julian RT561
 TR Julian LT151
 TR Dyna HT824

BKT LARKEISA U407 JD
 Beckton Larkeisa P688 CH
 Beckton Champ R3 H338
 BKT Larkeisa J564 HR

DAM		Calv.Ease	BW	WW	YW	Milk	HPG	Stay	Maint.En.
Age	2	13	-3.4	14	35	16	5	13	3.3
Wt	844	Marb +0.31		REA +0.14		Bfat +0.06			
Prog.BW	56	BWt	WWt	WR	ADG	YWt	YR	Scr.	Fr.
WR	100	56	561	100	3.24	1009	96	35	5.5
YR	96								
Wean Pct.	59%								
Cow Eff.	125								

★★★★★ for Low Maintenance, Marbling, Rib-eye area, High Cow Efficiency, Calving Ease, Stayability.

168 BECKTON HERITAGE X153 J3

1-A 100% # 1382889 Tattoo: BSF0 X153

Birth: 3-10-10

Beckton Heritage N013
 Beckton Hustler C2 L079
 Beckton Lana L007 JL

BECKTON HERITAGE T270 J2
 Ref. H-4
 Beckton Coca P602 JL
 Beckton Julian GG B571
 Beckton Coca J270 CD

Beckton Julian 7526G
 Beckton Julian 6592
 Bkt Belga 6746 GS

BECKTON MINOLA N729 JL
 Beckton Minola K179 EP
 Beckton Epic KN H110
 Beckton Minola H122 EP

DAM		Calv.Ease	BW	WW	YW	Milk	HPG	Stay	Maint.En.
Age	7	15	-3.9	32	53	10	12	17	-5.1
Wt	1075	Marb +0.23		REA +0.13		Bfat +0.05			
Prog.BW	67	BWt	WWt	WR	ADG	YWt	YR	Scr.	Fr.
WR	97	67	619	104	3.86	1066	98	37	5.0
YR	95								
Wean Pct.	58%								
Cow Eff.	121								

★★★★★ for Low Maintenance, Marbling, Rib-eye area, High Cow Efficiency, Calving Ease, Stayability.

166 BECKTON EPIC X757 L5

1-A 100% # 1382852 Tattoo: BSF0 X757

Birth: 4-21-10

Beckton Epic KJ J722
 Beckton Epic K F075
 Beckton Lana F891 JL

BECKTON EPIC K4 N795
 Ref. E-1
 Beckton Sierra J789 EP
 Beckton Epic D404
 Beckton Sierra C157 CL

Beckton Loki F251
 Beckton Lancer TZ D525
 Bkt Pine Marie D126 JL

BECKTON MINERVA M369 LO
 Beckton Minerva H403 LN
 Beckton Lancer TZ D525
 Beckton Minerva D648 JL

DAM		Calv.Ease	BW	WW	YW	Milk	HPG	Stay	Maint.En.
Age	8	12	-3.3	23	54	15	0	14	-0.6
Wt	1035	Marb +0.49		REA +0.17		Bfat +0.06			
Prog.BW	65	BWt	WWt	WR	ADG	YWt	YR	Scr.	Fr.
WR	100	68	577	97	3.67	1062	98	32	5.5
YR	96								
Wean Pct.	56%								
Cow Eff.	117								

★★★★★ for Low Maintenance, Marbling, Rib-eye area, High Cow Efficiency, Calving Ease, Stayability.

169 BECKTON NEBULA X680 E4

1-A 99% # 1382753 Tattoo: BKT0 X680

Birth: 4-12-10

Beckton Nebula J R475
 Beckton Nebula M045
 Beckton Larkeisa M138 JC

BECKTON NEBULA T054 H3
 Ref. N-7
 BKT Pine Marie R401 HU
 Beckton Hustler C2 L079
 Bkt Pine Marie LC30 CD

Beckton Epic KM M115
 Beckton Epic K F075
 Beckton Minerva F495 CH

BECKTON LANA R327 EP
 Beckton Lana K840 LN
 Beckton Lancer TS D390
 Beckton Lana F891 JL

DAM		Calv.Ease	BW	WW	YW	Milk	HPG	Stay	Maint.En.
Age	5	14	-3.9	30	60	17	12	15	-0.6
Wt	1065	Marb +0.26		REA +0.12		Bfat +0.01			
Prog.BW	64	BWt	WWt	WR	ADG	YWt	YR	Scr.	Fr.
WR	107	64	624	105	3.48	1119	103	39	5.0
YR	107								
Wean Pct.	59%								
Cow Eff.	123								

★★★★★ for Low Maintenance, Marbling, Superior Cow, High Cow Efficiency, Calving Ease, Stayability.

• Bulls •



172 BECKTON HASTEN X128 H4
1-A 100% # 1383380 Tattoo: BKT0 X128

Birth: 3-6-10
 Beckton Hasten H S462
 Beckton Hasten P292
BECKTON HASTEN U108 J3
 Ref. H-5 Beckton Encino S456 JC
 Beckton Lakme G128 HD
 Beckton Justice G302
 Beckton Encino J431 DM
 Beckton Hasten P292
 Beckton Lakme G128 HD
BKT LARKEISA U535 HS
 Beckton Hasten H S462
 BKT Larkeisa S637 HS
 Beckton Hasten P292
 BKT Larkeisa J800 LN

DAM		Calv.Ease	BW	WW	YW	Milk	HPG	Stay	Maint.En.
Age	2	14	-4.2	30	59	15	10	14	-4.5
Wt	758								
Prog.BW	58								
WR	108								
YR	105								
Wean Pct.	68%								
Cow Eff.	144								
		Marb	+0.03		REA	+0.01		Bfat	+0.01
		BWt	WWt	WR	ADG	YWt	YR	Scr.	Fr.
		58	578	108	3.62	1063	105	33	5.0

★★★★★ for Low Maintenance, Superior Cow, High Cow Efficiency, Calving Ease, Stayability.

170 BECKTON NEBULA X370 J3
1-A 99% # 1382737 Tattoo: BKT0 X370

Birth: 3-22-10
 Beckton Nebula M045
BECKTON NEBULA T269 E2
 Ref. N-8 Beckton Ruth M967 EP
 Beckton Juno N493
BECKTON EOLA R030 JJ
 Beckton Eola N491 LN
 Beckton Neptune R2 K065
 Beckton Belga K285 JL
 Beckton Epic KN H110
 Beckton Ruth A905 SG
 Beckton Julian G1 J526
 Beckton Serena D760 KR
 Beckton Lancer T4 J536
 Beckton Eola C611 SC

DAM		Calv.Ease	BW	WW	YW	Milk	HPG	Stay	Maint.En.
Age	5	13	-2.6	29	55	16	10	14	-5.6
Wt	1010								
Prog.BW	74								
WR	105								
YR	106								
Wean Pct.	59%								
Cow Eff.	124								
		Marb	+0.09		REA	+0.18		Bfat	+0.03
		BWt	WWt	WR	ADG	YWt	YR	Scr.	Fr.
		70	594	99	3.71	1096	99	39	4.5

★★★★★ for Low Maintenance, Rib-eye area, Superior Cow, High Cow Efficiency, Calving Ease, Stayability.

173 BECKTON LOKI X263 H4
1-A 100% # 1383175 Tattoo: BKT0 X263

Birth: 3-17-10
 Beckton Loki C M740
BECKTON LOKI CL S284
 Ref. L-2 Beckton Lakme J460 LT
 Beckton Hasten P292
BECKTON LARKABA S838 HS
 Beckton Larkaba M715 WR
 Beckton Loki F251
 BKT Larkeisa J051 CK
 Beckton Latigo G714
 Beckton Lakme G128 HD
 Beckton Hustler C2 L079
 Beckton Sheba L644 CH
 Beckton Warrior C C355
 Beckton Larkaba D388 SC

DAM		Calv.Ease	BW	WW	YW	Milk	HPG	Stay	Maint.En.
Age	4	14	-4.6	21	43	17	7	14	-0.1
Wt	960								
Prog.BW	66								
WR	108								
YR	101								
Wean Pct.	63%								
Cow Eff.	132								
		Marb	+0.10		REA	+0.02		Bfat	+0.00
		BWt	WWt	WR	ADG	YWt	YR	Scr.	Fr.
		67	624	105	3.19	1031	95	40	5.0

★★★★★ for Low Maintenance, High Cow Efficiency, Calving Ease, Stayability.

171 BECKTON LEGEND X486 E2
1-A 100% # 1382741 Tattoo: BKT0 X486

Birth: 3-28-10
 Beckton Lancer F442 T
BECKTON LEGEND S670
 Ref. L-3 Beckton Kit F468 JL
 Beckton Epic KM M115
BECKTON LANA R131 EP
 Beckton Lana J211 CL
 Beckton Lancer T A664
 Bkt Suffeina A828 DM
 Beckton Julian GG B571
 Beckton Kit A517 NP
 Beckton Epic K F075
 Beckton Minerva F495 CH
 Beckton Clipper KR C290
 Beckton Lana D824 NP

DAM		Calv.Ease	BW	WW	YW	Milk	HPG	Stay	Maint.En.
Age	5	12	-2.9	24	43	13	11	15	-4.1
Wt	1075								
Prog.BW	73								
WR	107								
YR	99								
Wean Pct.	57%								
Cow Eff.	119								
		Marb	+0.29		REA	+0.16		Bfat	+0.03
		BWt	WWt	WR	ADG	YWt	YR	Scr.	Fr.
		71	609	102	3.14	1057	98	40	5.0

★★★★★ for Low Maintenance, Marbling, Rib-eye area, High Cow Efficiency, Calving Ease, Stayability.

174 BECKTON EMPEROR X515 J3
1-A 100% # 1383030 Tattoo: BSF0 X515

Birth: 3-29-10
 Beckton Emperor R100
BECKTON EMPEROR T641 E2
 Ref. E-5 Beckton Vernice R416 EP
 Beckton Julian G2 M345
BECKTON LANA S827 JL
 Beckton Lana N163 JL
 Beckton Epic K4 N795
 Beckton Tamara N180 JO
 Beckton Epic K3 M606
 Beckton Vernice K482 HD
 Beckton Julian GG B571
 Beckton Lana H544 WR
 Beckton Julian 7526G
 Beckton Lana K052 VG

DAM		Calv.Ease	BW	WW	YW	Milk	HPG	Stay	Maint.En.
Age	4	15	-3.7	25	51	15	11	16	-5.7
Wt	910								
Prog.BW	56								
WR	97								
YR	93								
Wean Pct.	63%								
Cow Eff.	132								
		Marb	+0.13		REA	+0.18		Bfat	+0.03
		BWt	WWt	WR	ADG	YWt	YR	Scr.	Fr.
		71	592	100	3.33	1042	96	34	5.0

★★★★★ for Low Maintenance, Marbling, Rib-eye area, High Cow Efficiency, Calving Ease, Stayability.

• Bulls •

175 BECKTON WARRIOR X397 W6

1-A 100% # 1382799 Tattoo: BSF0 X397

Birth: 3-24-10

Beckton Warrior N645 T1
 Beckton Warrior T1 H281
 Beckton Rose H074 EP

BECKTON WARRIOR T248 L5
 Ref. W-2
 Beckton Kit R503 LN
 Beckton Lancer F442 T
 Beckton Kit F468 JL

Beckton Warrior TD L493
 Beckton Warrior T C371
 Bkt Suffeina A828 DM

BECKTON LANA N059 WR
 Beckton Lana L665 VG
 Beckton Vegas PK F485
 Beckton Lana F819 NP

DAM		Calv.Ease	BW	WW	YW	Milk	HPG	Stay	Maint.En.
Age	15	17	-5.8	12	51	18	10	14	-6.8
Wt	1055	Marb -0.1		REA +0.07		Bfat -0.03			
Prog.BW	66	BWt	WWt	WR	ADG	YWt	YR	Scr.	Fr.
WR	103	66	625	105	3.52	1124	104	34	5.0
YR	103								
Wean Pct.	57%								
Cow Eff.	121								

★★★★★ for Low Maintenance, High Cow Efficiency, Calving Ease, Stayability.

177 BECKTON NEBULA X277 L3

1-A 100% # 1383142 Tattoo: BKT0 X277

Birth: 3-18-10

Beckton Nebula M045
 Beckton Neptune R2 K065
 Beckton Belga K285 JL

BECKTON NEBULA G S237
 Ref. N-5
 Beckton Lakme LA06 JL
 Beckton Julian GG B571
 Beckton Lakme B370 HV

Beckton Lancer T7 M089
 Beckton Lancer F442 T
 Beckton Tamara G141 HE

BECKTON FIREFLY S418 LN
 Beckton Firefly K250 VG
 Beckton Vegas PK F485
 Beckton Firefly E920 MB

DAM		Calv.Ease	BW	WW	YW	Milk	HPG	Stay	Maint.En.
Age	4	14	-3.3	22	42	13	9	13	-4.3
Wt	1075	Marb +0.05		REA -0.14		Bfat -0.02			
Prog.BW	70	BWt	WWt	WR	ADG	YWt	YR	Scr.	Fr.
WR	100	78	583	98	3.10	1007	93	37	5.0
YR	99								
Wean Pct.	52%								
Cow Eff.	110								

★★★★★ for Low Maintenance, Calving Ease, Stayability.

176 BECKTON CLIFFTOP X001 J4

1-A 100% # 1383104 Tattoo: BSF0 X001

Birth: 2-1-10

BKT Clifftop TP R288
 Beckton Clifftop T C075
 Beckton Christy K209 CO

BECKTON CLIFFTOP U575 H3
 Ref. C-2
 Beckton Larkabel N769 HR
 Beckton Herald FJ J776
 Bkt Larkabel F246 CT

Beckton Julian G3 P608
 Beckton Julian GG B571
 Bkt Suffeina A828 DM

BECKTON LARKABA U274 JL
 Beckton Larkaba N708 HR
 Beckton Herald FJ J776
 Beckton Larkaba G311 CT

DAM		Calv.Ease	BW	WW	YW	Milk	HPG	Stay	Maint.En.
Age	2	16	-4.5	21	41	19	14	17	-5.5
Wt	796	Marb +0.16		REA +0.18		Bfat +0.02			
Prog.BW	60	BWt	WWt	WR	ADG	YWt	YR	Scr.	Fr.
WR	106	60	565	106	3.29	983	97	35	5.0
YR	97								
Wean Pct.	64%								
Cow Eff.	134								

★★★★★ for Low Maintenance, Marbling, Rib-eye area, High Cow Efficiency, Calving Ease, Stayability.

178 BECKTON NEBULA X127 C5

1-A 100% # 1383385 Tattoo: BKT0 X127

Birth: 3-6-10

Beckton Nebula PJ S543
 Beckton Nebula P P707
 Beckton Lana P685 JO

BECKTON NEBULA U060 N4
 Ref. N-11
 Beckton Birdie S110 NB
 Beckton Nebula P P707
 Beckton Birdie P086 WR

Beckton Clifftop T3 N800
 Bkt Clifftop TV G672
 Beckton Lana J384 CD

BECKTON COCA U561 CT
 Beckton Coca P328 EP
 Beckton Epic KJ J722
 Beckton Coca J276 CL

DAM		Calv.Ease	BW	WW	YW	Milk	HPG	Stay	Maint.En.
Age	2	14	-3.3	28	61	17	5	13	-2.7
Wt	915	Marb +0.37		REA +0.11		Bfat +0.04			
Prog.BW	60	BWt	WWt	WR	ADG	YWt	YR	Scr.	Fr.
WR	105	60	559	105	4.05	1073	106	35	5.0
YR	106								
Wean Pct.	55%								
Cow Eff.	115								

★★★★★ for Low Maintenance, Growth, Gainability, Marbling, Superior Cow, Calving Ease, Stayability.



179 BECKTON NEBULA X299 L3

1-A 99% # 1382946 Tattoo: BSF0 X299

Birth: 3-19-10

Beckton Nebula M045
 Beckton Neptune R2 K065
 Beckton Belga K285 JL

BECKTON NEBULA T269 E2
 Ref. N-8
 Beckton Ruth M967 EP
 Beckton Ruth A905 SG

Beckton Loki C M740
 Beckton Loki F251
 BKT Larkeisa J051 CK

BECKTON LARKABA R357 LO
 Beckton Larkaba F394 VG
 Beckton Vegas P D462
 Beckton Larkaba D427 KR

DAM		Calv.Ease	BW	WW	YW	Milk	HPG	Stay	Maint.En.
Age	5	12	-2.4	24	48	15	8	14	-6.3
Wt	1020	Marb +0.13		REA +0.00		Bfat +0.04			
Prog.BW	66	BWt	WWt	WR	ADG	YWt	YR	Scr.	Fr.
WR	101	76	576	97	3.62	1028	95	35	4.5
YR	102								
Wean Pct.	56%								
Cow Eff.	119								

★★★★★ for Low Maintenance, Marbling, High Cow Efficiency, Calving Ease, Stayability.

• Bulls •

180 BECKTON HERITAGE X355 L3

1-A 99% # 1383159 Tattoo: BKT0 X355

Birth: 3-21-10

Beckton Heritage N013
 Beckton Hustler C2 L079
 Beckton Lana L007 JL

BECKTON HERITAGE T270 J2
 Ref. H-4
 Beckton Coca P602 JL
 Beckton Julian GG B571
 Beckton Coca J270 CD

Beckton Lancer T9 N586
 Beckton Lancer TA K644
 BKT Larkeisa H232 SC

BECKTON MONA S621 LN
 Beckton Mona N444 HU
 Beckton Hustler C2 L079
 Beckton Mona L136 JL

DAM		Calv.Ease	BW	WW	YW	Milk	HPG	Stay	Maint.En.
Age	4	18	-5.2	30	48	6	10	14	-5.7
Wt	970	Marb +0.23			REA +0.05		Bfat +0.02		
Prog.BW	56	BWt	WWt	WR	ADG	YWt	YR	Scr.	Fr.
WR	91	57	595	100	3.76	1040	96	36	4.5
YR	94								
Wean Pct.	59%								
Cow Eff.	125								

★★★★★ for Low Maintenance, Marbling, High Cow Efficiency, Calving Ease, Stayability.

183 BECKTON NOMAD X254 J3

1-A 100% # 1383018 Tattoo: BSF0 X254

Birth: 3-16-10

Beckton Nomad 7496
 Beckton Neva 5562
 Bkt Bolt Tamrck 3913

BECKTON NOMAD T 9A14
 Ref. V
 Beckton Lana 7152 TJ
 Beckton Trojan 5253
 Bkt Signal Lana 5599

Beckton Jules L429
 Beckton Julian G1 J526
 Beckton Barona J591 EP

BECKTON INDIGO S636 JE
 Beckton Indigo N348 LN
 Beckton Lancer TH K417
 Beckton Indigo F057 CL

DAM		Calv.Ease	BW	WW	YW	Milk	HPG	Stay	Maint.En.
Age	4	18	-7.2	5	16	12	12	12	-2.8
Wt	1090	Marb +0.03			REA -0.12		Bfat -0.01		
Prog.BW	63	BWt	WWt	WR	ADG	YWt	YR	Scr.	Fr.
WR	96	61	569	96	3.33	998	92	37	5.0
YR	92								
Wean Pct.	50%								
Cow Eff.	106								

★★★★★ for Low Maintenance, Calving Ease.

181 BECKTON JET X123 C3

1-A 100% # 1383082 Tattoo: BSF0 X123

Birth: 3-5-10

Beckton Jet L P491
 TR Julian LT151
 Beckton Minerva L278 LN

BECKTON JET U473 L2
 Ref. J-5
 Beckton Lydia N047 LM
 Beckton Laramie L044
 Beckton Lydia L647 JL

Beckton Cherokee N N479
 BFCK Cherokee Cnyn 4912
 Beckton Dinah C440 NM

BECKTON BARMAID U114 CQ
 Beckton Barmaid P323 HR
 Beckton Herald FV J537
 Beckton Barmaid J012 CO

DAM		Calv.Ease	BW	WW	YW	Milk	HPG	Stay	Maint.En.
Age	2	12	-2.5	35	63	24	11	17	-1.4
Wt	850	Marb +0.31			REA +0.11		Bfat +0.05		
Prog.BW	66	BWt	WWt	WR	ADG	YWt	YR	Scr.	Fr.
WR	112	66	597	112	3.38	1035	103	36	5.0
YR	103								
Wean Pct.	63%								
Cow Eff.	133								

★★★★★ for Low Maintenance, Marbling, High Cow Efficiency, Calving Ease, Stayability.



182 BECKTON LANCER X291 J5

1-A 100% # 1382733 Tattoo: BKT0 X291

Birth: 3-19-10

Beckton Lancer F442 T
 Beckton Lancer T A664
 Bkt Suffeina A828 DM

BECKTON LANCER T371 H4
 Ref. L-4
 Beckton Coca F276 HV
 Leachman Heavenly 8141
 Beckton Coca B112 CB

Beckton Julian G1 J526
 Beckton Julian GG B571
 Beckton Annie F743 LN

BECKTON MAIATA P892 JL
 Bkt Maiata K503 EP
 Beckton Epic D404
 Bkt Maiata 9B75 JL

DAM		Calv.Ease	BW	WW	YW	Milk	HPG	Stay	Maint.En.
Age	6	11	-2.2	23	43	11	7	15	-3.1
Wt	1175	Marb +0.04			REA +0.00		Bfat -0.01		
Prog.BW	65	BWt	WWt	WR	ADG	YWt	YR	Scr.	Fr.
WR	98	80	525	88	3.48	989	91	35	5.0
YR	99								
Wean Pct.	45%								
Cow Eff.	94								

★★★★★ for Low Maintenance, Calving Ease, Stayability.

184 TR NUGGET XT020

1-A 100% # 1369827 Tattoo: TR2A0 XT02

Birth: 3-10-10

Beckton Nebula M045
 Beckton Neptune R2 K065
 Beckton Belga K285 JL

TR NEBULA TT779
 Ref. N-13
 TR Lydia MT244
 Beckton Lancer F134 TS
 Beckton Lydia E251 CL

TR Julian LT151
 Beckton Julian GG B571
 MS Geometric 917

TR BRITTNEY ST672

DAM		Calv.Ease	BW	WW	YW	Milk	HPG	Stay	Maint.En.
Age	4	16	-3.3	36	65	14	11	13.7	2.4
Wt	1400	Marb +0.02			REA -0.05		Bfat +0.03		
Prog.BW	71	BWt	WWt	WR	ADG	YWt	YR	Scr.	Fr.
WR	NA	78	677	106	3.02	1160	103	37	5.0
YR	NA								
Wean Pct.	NA%								
Cow Eff.	NA								

★★★★★ for Low Maintenance, Calving Ease, Stayability.

• Bulls •

185 TR JAX XT029
1-A 100% # 1369840 Tattoo: TR2A0 XT02

Birth: 3-4-10

Beckton Julian GG B571
BKT Julian 7526 G
BKT Marta 9A13 JL

TR JULIAN ST630
Ref. J-9
MS Geometric 003
BJR Make My Day 981
MS Geometric 277

Mr. R2R Marvel A13N3
BC Cherokee Cnyn 4912
BKT Marta 9A13 JL

TR CEDAR TT732
TR Cedar RT516
BSF Julian JT911
MS Geometric 027

DAM		Calv.	Ease	BW	WW	YW	Milk	HPG	Stay	Maint.En.
Age	3	14	-1.6	28	49	11	10	14.7	-2.2	
Wt	946									
Prog.BW	62									
WR	NA		Marb	-0.09	REA	+0.14	Bfat	+0.00		
YR	NA									
Wean Pct.	NA%	BWt	WWt	WR	ADG	YWt	YR	Scr.	Fr.	
Cow Eff.	NA	85	694	109	2.90	1159	103	41	5.0	

★★★★★ for Low Maintenance, Rib-eye area, Calving Ease, Stayability.

188 TR RICARDO XT032
1-A 100% # 1369845 Tattoo: TR2A0 XT03

Birth: 2-16-10

Bfck Cherokee Cnyn 4912
Buf Crk Chf 824-1658
MRM 1431 8611 9109

TR RICARDO RT574
Ref. C-3
TR Dyna LT111
Beckton Julian GG B571
BSF Dyna JT976

Beckton Julian 7526G
Bkt Marta 9A13 JL

BECKTON TAMARA U628 JL
Beckton Tamara R149 LN
Beckton Lancer T9 N586
Beckton Tamara N530 LN

DAM		Calv.	Ease	BW	WW	YW	Milk	HPG	Stay	Maint.En.
Age	2	13	-1.7	30	57	12	12	15.9	-6.6	
Wt	1215									
Prog.BW	87									
WR	NA		Marb	+0.38	REA	+0.29	Bfat	+0.00		
YR	NA									
Wean Pct.	NA%	BWt	WWt	WR	ADG	YWt	YR	Scr.	Fr.	
Cow Eff.	NA	87	591	102	3.15	1095	99	37	4.5	

★★★★★ for Low Maintenance, Marbling, Rib-eye area, Calving Ease, Stayability.

186 TR JUNIPER XT023
1-A 100% # 1369830 Tattoo: TR2A0 XT02

Birth: 2-16-10

Beckton Julius M213
Beckton Julian 7526G
Beckton Lana H128 HR

TR JULIUS ST633
Ref. J-10

TR Julian LT151
Beckton Julian GG B571
MS Geometric 917

TR EOLA ST688
TR Eola G740
Beckton Hadrian FC E166
Beckton Eola E192 CL

DAM		Calv.	Ease	BW	WW	YW	Milk	HPG	Stay	Maint.En.
Age	4	17	-3.4	31	58	13	12	16.7	6.3	
Wt	1535									
Prog.BW	64									
WR	NA		Marb	+0.20	REA	+0.10	Bfat	+0.02		
YR	NA									
Wean Pct.	NA%	BWt	WWt	WR	ADG	YWt	YR	Scr.	Fr.	
Cow Eff.	NA	67	613	96	2.98	1089	97	38	4.5	

★★★★★ for Marbling, Calving Ease, Stayability.

189 TR EPIC XT021
1-A 100% # 1369828 Tattoo: TR2A0 XT02

Birth: 2-27-10

Beckton Epic K F075
Beckton Epic D404
Beckton Belga D483 KR

TR EPIC ST618
Ref. E-9
Beckton Kit F468 JL
Beckton Julian GG B571
Beckton Kit A517 NP

TR Julian LT142
Beckton Julian GG B571
TR Lana G760

TR CEDAR ST684

DAM		Calv.	Ease	BW	WW	YW	Milk	HPG	Stay	Maint.En.
Age	4	19	-5.9	26	46	14	12	15.7	-5.4	
Wt	1160									
Prog.BW	62									
WR	NA		Marb	+0.37	REA	+0.21	Bfat	+0.01		
YR	NA									
Wean Pct.	NA%	BWt	WWt	WR	ADG	YWt	YR	Scr.	Fr.	
Cow Eff.	NA	64	594	93	2.86	1052	94	40	3.5	

★★★★★ for Low Maintenance, Marbling, Rib-eye area, Calving Ease, Stayability.

187 TR JAX XT025
1-A 100% # 1369833 Tattoo: TR2A0 XT02

Birth: 2-25-10

Beckton Julian GG B571
BKT Julian 7526 G
BKT Marta 9A13 JL

TR JULIAN ST630
Ref. J-9
MS Geometric 003
BJR Make My Day 981
MS Geometric 277

Mushrush LT N020
TR Julian LT142
Mushrush Lana 1061

TR COCA TT700
TR Coca RT527
BKT Julian 7526 G
Beckton Coca L388 CK

DAM		Calv.	Ease	BW	WW	YW	Milk	HPG	Stay	Maint.En.
Age	3	19	-4.6	24	50	12	12	17.5	4.1	
Wt	1330									
Prog.BW	64									
WR	NA		Marb	-0.06	REA	+0.05	Bfat	+0.02		
YR	NA									
Wean Pct.	NA%	BWt	WWt	WR	ADG	YWt	YR	Scr.	Fr.	
Cow Eff.	NA	68	623	97	3.03	1108	99	40	5.5	

★★★★★ for Calving Ease, Stayability.

190 TR DOUBLE EAGLE XT037
1-A 100% # 1369850 Tattoo: TR2A0 XT03

Birth: 3-3-10

Beckton Julian GG B571
TR Lana G760

TR RICARDO DOS UT810
Ref. C-4

TR Julian LT142
Beckton Julian GG B571
TR Lana G760

TR CEDAR UT857
MS Geometric 004
Leachman Heavenly 8141
MS Geometric 810

DAM		Calv.	Ease	BW	WW	YW	Milk	HPG	Stay	Maint.En.
Age	2	18	-4.5	24	43	17	12	15	-2.5	
Wt	1275									
Prog.BW	67									
WR	NA		Marb	+0.19	REA	+0.11	Bfat	+0.02		
YR	NA									
Wean Pct.	NA%	BWt	WWt	WR	ADG	YWt	YR	Scr.	Fr.	
Cow Eff.	NA	67	601	104	2.86	1058	96	35	5.0	

★★★★★ for Low Maintenance, Marbling, Calving Ease, Stayability.

• Bulls •



193 BSF CHEROKEE X395 J4
1-B 99% # 1382972 Tattoo: BSF0 X395

Birth: 3-24-10
 ↙ Beckton Cherokee N N479 ↘ BFCK Cherokee Cnyn 4912
 ↙ Beckton Dinah C440 NM
BECKTON CHEROKEE T450 L3
 Ref. C-1 ↘ Beckton Annie M337 LN ↘ Beckton Lancer TL G626
 ↘ Beckton Annie F743 LN
 ↘ TR Julian LT151
BSF WARRITA S004 JT
 ↙ Beckton Jet L P491 ↘ Beckton Minerva L278 LN
 ↘ BSF Warrita P418 ↘ Beckton Warrior T1 H281
 ↘ BSF Regus H255

DAM		Calv.Ease	BW	WW	YW	Milk	HPG	Stay	Maint.En.
Age	4	16	-5.7	11	40	18	11	16	-4.5
Wt	1005	Marb +0.18		REA +0.06		Bfat +0.02			
Prog.BW	57	BWt	WWt	WR	ADG	YWt	YR	Scr.	Fr.
WR	90	64	518	90	4.24	1068	99	34	5.0
YR	95								
Wean Pct.	50%								
Cow Eff.	104								

★★★★★ for Low Maintenance, Gainability, Marbling, Calving Ease, Stayability.

191 TR RICARDO XT018
1-A 100% # 1369824 Tattoo: TR2A0 XT01

Birth: 3-11-10
 ↙ Bfck Cherokee Cnyn 4912 ↘ Buf Crk Chf 824-1658
 ↘ MRM 1431 8611 9109
TR RICARDO RT574
 Ref. C-3 ↘ TR Dyna LT111 ↘ Beckton Julian GG B571
 ↘ BSF Dyna JT976
TR SUFFEINA ST661
 ↙ Beckton Julian GG B571 ↘ Beckton Julian 7526G
 ↘ Bkt Marta 9A13 JL
 ↘ Beckton Dominor 9455
 ↘ Bkt Suffeina A828 DM ↘ Bkt Suffeina 9493 TT

DAM		Calv.Ease	BW	WW	YW	Milk	HPG	Stay	Maint.En.
Age	4	17	-4.2	23	37	15	12	16.2	-6.8
Wt	1165	Marb +0.34		REA +0.36		Bfat +0.02			
Prog.BW	70	BWt	WWt	WR	ADG	YWt	YR	Scr.	Fr.
WR	NA	74	609	95	2.72	1044	93	36	4.0
YR	NA								
Wean Pct.	NA%								
Cow Eff.	NA								

★★★★★ for Low Maintenance, Marbling, Rib-eye area, Calving Ease, Stayability.

194 BSF JULIAN X664 J5
1-B 99% # 1383026 Tattoo: BSF0 X664

Birth: 4-10-10
 ↙ Beckton Julian GJ P535 ↘ Beckton Julian 7526G
 ↘ Beckton Mona D086 JL
BECKTON JULIAN G5 S107
 Ref. J-4 ↘ Beckton Minola P826 DM ↘ Beckton Dominor ZC M919
 ↘ Beckton Minola M641 WR
BSF JUSTICIA S777 JC
 ↙ Beckton Justice CH M056 ↘ Beckton Justice C K449
 ↘ BSF Regus L414 EP ↘ Beckton Ruth K802 HD
 ↘ Beckton Epic K F075
 ↘ BSF Regus H520

DAM		Calv.Ease	BW	WW	YW	Milk	HPG	Stay	Maint.En.
Age	4	13	-2.7	28	51	14	12	16	-3.4
Wt	1035	Marb +0.22		REA +0.09		Bfat +0.05			
Prog.BW	67	BWt	WWt	WR	ADG	YWt	YR	Scr.	Fr.
WR	106	67	619	103	3.24	1054	95	35	5.0
YR	106								
Wean Pct.	58%								
Cow Eff.	122								

★★★★★ for Low Maintenance, Marbling, Superior Cow, High Cow Efficiency, Calving Ease, Stayability.

192 BSF NEBULA X768 E4
1-B 99% # 1383432 Tattoo: BKB0 X768

Birth: 4-22-10
 ↙ Beckton Nebula L P093 ↘ Beckton Nebula M045
 ↘ Beckton Marta M021 LN
BECKTON NEBULA T398 V3
 Ref. N-9 ↘ Beckton Minerva J615 VG ↘ Beckton Vegas PK F485
 ↘ Beckton Minerva F433 VG
BSF ERICA T605 EP
 ↙ Beckton Epic K4 N795 ↘ Beckton Epic KJ J722
 ↘ Beckton Sierra J789 EP
 ↘ BSF Regus M205 LN ↘ Beckton Lancer TA K644
 ↘ BSF Regus K466 JC

DAM		Calv.Ease	BW	WW	YW	Milk	HPG	Stay	Maint.En.
Age	3	12	-2.5	29	67	13	7	12	-0.5
Wt	1005	Marb +0.24		REA +0.17		Bfat +0.02			
Prog.BW	60	BWt	WWt	WR	ADG	YWt	YR	Scr.	Fr.
WR	102	62	612	107	4.33	1152	109	36	5.5
YR	105								
Wean Pct.	57%								
Cow Eff.	120								

★★★★★ for Low Maintenance, Growth, Gainability, Marbling, Rib-eye area, High Cow Efficiency, Calving Ease.

195 BSF JULIAN X678 J5
1-B 99% # 1382981 Tattoo: BSF0 X678

Birth: 4-12-10
 ↙ Beckton Julian GJ P535 ↘ Beckton Julian 7526G
 ↘ Beckton Mona D086 JL
BECKTON JULIAN G5 S107
 Ref. J-4 ↘ Beckton Minola P826 DM ↘ Beckton Dominor ZC M919
 ↘ Beckton Minola M641 WR
BSF EPIQUETTE S101 JL
 ↙ Beckton Julian G3 P608 ↘ Beckton Julian GG B571
 ↘ BSF Epiquette P553 ↘ Bkt Suffeina A828 DM
 ↘ Beckton Epic KM M115
 ↘ BSF Regus M394 EP

DAM		Calv.Ease	BW	WW	YW	Milk	HPG	Stay	Maint.En.
Age	4	10	-0.3	33	73	12	11	19	1.3
Wt	1085	Marb +0.17		REA -0.02		Bfat +0.04			
Prog.BW	74	BWt	WWt	WR	ADG	YWt	YR	Scr.	Fr.
WR	100	83	621	104	3.57	1144	106	37	5.0
YR	100								
Wean Pct.	55%								
Cow Eff.	117								

★★★★★ for Low Maintenance, Growth, Marbling, High Cow Efficiency, Calving Ease, Stayability.

• Bulls •

196 BSF NEBULA X762 H3

1-B 99% # 1382837 Tattoo: BSF0 X762

Birth: 4-21-10
 Beckton Nebula M045
BECKTON NEBULA G S237
 Ref. N-5
 Beckton Lakme LA06 JL
 Beckton Neptune R2 K065
 Beckton Belga K285 JL
 Beckton Julian GG B571
 Beckton Lakme B370 HV
 Beckton Champ RH F275
 Beckton Lana F138 LN
 Beckton Lancer TZ D525
 BSF Regus D449
BSF REGUS L479 CH
 Beckton Champ R1 H024
 BSF Regus F205

DAM		Calv.Ease	BW	WW	YW	Milk	HPG	Stay	Maint.En.
Age	9	20	-6.6	15	38	14	9	14	-4.3
Wt	1160	Marb +0.16		REA -0.05		Bfat -0.02			
Prog.BW	71	BWt	WWt	WR	ADG	YWt	YR	Scr.	Fr.
WR	101	64	532	92	3.71	1052	98	33	5.0
YR	102								
Wean Pct.	46%								
Cow Eff.	97								

★★★★★ for Low Maintenance, Marbling, Calving Ease, Stayability.

198 BSF LEGEND X741 C2

1-B 99% # 1382924 Tattoo: BSF0 X741

Birth: 4-19-10
 Beckton Lancer F442 T
BECKTON LEGEND S670
 Ref. L-3
 Beckton Kit F468 JL
 Beckton Lancer T A664
 Bkt Suffeina A828 DM
 Beckton Julian GG B571
 Beckton Kit A517 NP
 BFCK Cherokee Cnyn 4912
 Beckton Dinah C440 NM
 Beckton Herald FJ J776
 BSF Regus C791
BSF HELENA R016 CQ
 Beckton Cherokee N N479
 BSF Helena N186 HR

DAM		Calv.Ease	BW	WW	YW	Milk	HPG	Stay	Maint.En.
Age	5	12	-2.6	23	44	14	14	16	-2.8
Wt	1080	Marb +0.27		REA +0.35		Bfat +0.03			
Prog.BW	67	BWt	WWt	WR	ADG	YWt	YR	Scr.	Fr.
WR	104	77	569	96	3.38	1073	99	33	5.0
YR	100								
Wean Pct.	53%								
Cow Eff.	111								

★★★★★ for Low Maintenance, Marbling, Rib-eye area, Calving Ease, Stayability.

197 BSF EMPEROR X696 E3

1-B 98% # 1383425 Tattoo: BKB0 X696

Birth: 4-13-10
 Beckton Emperor R100
BECKTON EMPEROR T641 E2
 Ref. E-5
 Beckton Vernice R416 EP
 Beckton Epic K4 N795
 Beckton Tamara N180 JO
 Beckton Epic K3 M606
 Beckton Vernice K482 HD
 Beckton Epic KJ J722
 Beckton Sierra J789 EP
 Beckton Loki F251
 BSF Regus G195
BSF LAUREL T238 EP
 Beckton Epic K4 N795
 BSF Laurel N411 LO

DAM		Calv.Ease	BW	WW	YW	Milk	HPG	Stay	Maint.En.
Age	3	13	-3.3	27	59	17	4	15	1.0
Wt	995	Marb +0.33		REA +0.27		Bfat +0.05			
Prog.BW	53	BWt	WWt	WR	ADG	YWt	YR	Scr.	Fr.
WR	100	60	604	105	3.57	1091	103	34	5.0
YR	94								
Wean Pct.	57%								
Cow Eff.	119								

★★★★★ for Low Maintenance, Marbling, Rib-eye area, High Cow Efficiency, Calving Ease, Stayability.

199 BSF NEBULA X539 J3

1-B 99% # 1382970 Tattoo: BSF0 X539

Birth: 3-31-10
 Beckton Nebula M045
BECKTON NEBULA G S237
 Ref. N-5
 Beckton Lakme LA06 JL
 Beckton Julian G1 J526
BSF JULIANNE R839 JL
 BSF Regus G340
 Beckton Neptune R2 K065
 Beckton Belga K285 JL
 Beckton Julian GG B571
 Beckton Lakme B370 HV
 Beckton Julian GG B571
 Beckton Annie F743 LN
 Beckton Caesar M D023
 BSF Regus CB58

DAM		Calv.Ease	BW	WW	YW	Milk	HPG	Stay	Maint.En.
Age	5	20	-6.7	16	33	13	9	15	-7.8
Wt	1035	Marb +0.36		REA -0.21		Bfat +0.00			
Prog.BW	59	BWt	WWt	WR	ADG	YWt	YR	Scr.	Fr.
WR	95	57	542	91	3.29	1004	93	38	5.0
YR	97								
Wean Pct.	52%								
Cow Eff.	110								

★★★★★ for Low Maintenance, Marbling, Calving Ease, Stayability.



200 BSF LEGEND X495 J3

1-B 99% # 1382621 Tattoo: BSF0 X495

Birth: 3-28-10
 Beckton Legend S670
BECKTON LEGEND U331 E2
 Ref. L-7
 Beckton Lana S669 EP
 TR Julian RT561
BSF EPIQUETTE U833 JD
 BSF Epiquette R729 EP
 Beckton Lancer F442 T
 Beckton Kit F468 JL
 Beckton Epic K4 N795
 Beckton Lana M597 LO
 TR Julian LT151
 TR Dyna HT824
 Beckton Epic KM M115
 BSF Regus M602 EP

DAM		Calv.Ease	BW	WW	YW	Milk	HPG	Stay	Maint.En.
Age	2	13	-3.4	21	51	15	7	19	0.3
Wt	802	Marb +0.57		REA +0.08		Bfat +0.05			
Prog.BW	55	BWt	WWt	WR	ADG	YWt	YR	Scr.	Fr.
WR	103	55	551	103	4.10	1075	107	34	5.0
YR	107								
Wean Pct.	61%								
Cow Eff.	129								

★★★★★ for Low Maintenance, Gainability, Marbling, Superior Cow, High Cow Efficiency, Calving Ease, Stayability.

• Bulls •

201 **BSF HASTEN X055 W4**
1-B 99% # 1383127 Tattoo: BSF0 X055

Birth: 2-21-10
 Beckton Hasten H S462
BECKTON HASTEN U108 J3
 Ref. H-5
 Beckton Encino S456 JC
 Beckton Hasten P292
 Beckton Lakme G128 HD
 Beckton Justice G302
 Beckton Encino J431 DM
 Beckton Warrior T1 H281
 Beckton Firefly H195 HD
 Beckton Lancer TL G626
 BSF Regus H508
 Beckton Warhawk N560
 BSF Regus L616 LN

DAM		Calv.Ease	BW	WW	YW	Milk	HPG	Stay	Maint.En.
Age	2	14	-4.2	22	51	12	14	15	-1.2
Wt	930	Marb +0.00		REA +0.08		Bfat +0.02			
Prog.BW	56	BWt	WWt	WR	ADG	YWt	YR	Scr.	Fr.
WR	95	56	508	95	3.43	1009	100	36	5.0
YR	100								
Wean Pct.	48%								
Cow Eff.	101								

★★★★★ for Low Maintenance, Calving Ease, Stayability.



202 **BSF NEBULA X369 H3**
1-B 99% # 1383046 Tattoo: BSF0 X369

Birth: 3-22-10
 Beckton Nebula M045
BECKTON NEBULA T269 E2
 Ref. N-8
 Beckton Ruth M967 EP
 Beckton Neptune R2 K065
 Beckton Belga K285 JL
 Beckton Epic KN H110
 Beckton Ruth A905 SG
 Beckton Hustler C2 L079
 Beckton Lana L007 JL
 Beckton Lancer TA K644
 BSF Regus K090 CH
 Beckton Heritage N013
 BSF Laurel N619 LN

DAM		Calv.Ease	BW	WW	YW	Milk	HPG	Stay	Maint.En.
Age	3	16	-5.5	20	49	14	10	14	-4.3
Wt	1100	Marb +0.27		REA +0.09		Bfat +0.04			
Prog.BW	61	BWt	WWt	WR	ADG	YWt	YR	Scr.	Fr.
WR	95	61	546	95	3.43	997	94	36	5.0
YR	90								
Wean Pct.	46%								
Cow Eff.	97								

★★★★★ for Low Maintenance, Marbling, Calving Ease, Stayability.

204 **BSF LEGEND X121 V3**
1-B 99% # 1383087 Tattoo: BSF0 X121

Birth: 3-5-10
 Beckton Legend S670
BECKTON LEGEND U331 E2
 Ref. L-7
 Beckton Lana S669 EP
 Beckton Vega P079
BSF JULIANNE U150 VA
 BSF Julianne R593 JL
 Beckton Lancer F442 T
 Beckton Kit F468 JL
 Beckton Epic K4 N795
 Beckton Lana M597 LO
 Beckton Vegas S1 K316
 Beckton Lydia H159 JL
 Beckton Julian G1 J526
 BSF Regus M001 NP

DAM		Calv.Ease	BW	WW	YW	Milk	HPG	Stay	Maint.En.
Age	2	14	-3.5	22	48	13	9	18	0.3
Wt	890	Marb +0.43		REA +0.09		Bfat +0.04			
Prog.BW	60	BWt	WWt	WR	ADG	YWt	YR	Scr.	Fr.
WR	97	60	515	97	3.19	975	97	33	5.0
YR	97								
Wean Pct.	51%								
Cow Eff.	108								

★★★★★ for Low Maintenance, Marbling, Calving Ease, Stayability.

203 **BSF NEBULA X432 C5**
1-B 99% # 1383126 Tattoo: BSF0 X432

Birth: 3-25-10
 Beckton Nebula PJ S543
BECKTON NEBULA U060 N4
 Ref. N-11
 Beckton Birdie S110 NB
 Beckton Cherokee N N479
BSF LANETTE U463 CQ
 BSF Lanette R748 LN
 Beckton Nebula P P707
 Beckton Lana P685 JO
 Beckton Nebula P P707
 Beckton Birdie P086 WR
 BFCK Cherokee Cnyn 4912
 Beckton Dinah C440 NM
 Beckton Lancer T7 M089
 BSF Red Roan L823 LN

DAM		Calv.Ease	BW	WW	YW	Milk	HPG	Stay	Maint.En.
Age	2	15	-5.2	26	55	21	10	17	-9.6
Wt	760	Marb +0.16		REA +0.18		Bfat +0.02			
Prog.BW	56	BWt	WWt	WR	ADG	YWt	YR	Scr.	Fr.
WR	110	56	555	110	3.48	1022	104	36	5.5
YR	104								
Wean Pct.	65%								
Cow Eff.	137								

★★★★★ for Low Maintenance, Marbling, Rib-eye area, Superior Cow, High Cow Efficiency, Calving Ease, Stayability.

205 **BSF HERITAGE X776 E3**
1-B 99% # 1383056 Tattoo: BSF0 X776

Birth: 4-25-10
 Beckton Heritage N013
BECKTON HERITAGE T270 J2
 Ref. H-4
 Beckton Coca P602 JL
 Beckton Epic KM M115
BSF ERICA T609 EP
 BSF Red G329
 Beckton Hustler C2 L079
 Beckton Lana L007 JL
 Beckton Julian GG B571
 Beckton Coca J270 CD
 Beckton Epic K F075
 Beckton Minerva F495 CH
 Beckton Clifftop T C075
 BSF Regus D038

DAM		Calv.Ease	BW	WW	YW	Milk	HPG	Stay	Maint.En.
Age	3	12	-2.2	39	70	15	11	16	0.9
Wt	1040	Marb +0.30		REA -0.04		Bfat +0.04			
Prog.BW	66	BWt	WWt	WR	ADG	YWt	YR	Scr.	Fr.
WR	110	71	633	111	2.95	1090	103	37	5.5
YR	106								
Wean Pct.	57%								
Cow Eff.	120								

★★★★★ for Low Maintenance, Marbling, Superior Cow, High Cow Efficiency, Calving Ease, Stayability.

• Bulls •

206 **BSF NEBULA X302 N3**
1-B 99% # 1383034 Tattoo: BSF0 X302

Birth: 3-19-10
 ↗ Beckton Nebula M045 ↘ Beckton Neptune R2 K065
BECKTON NEBULA T269 E2 ↙ Beckton Belga K285 JL
 Ref. N-8 ↘ Beckton Ruth M967 EP ↙ Beckton Epic KN H110
 ↘ Beckton Ruth A905 SG
 ↗ Beckton Nebula H R233 ↘ Beckton Nebula M045
BSF JULIANNE T011 NB ↙ Beckton Coca H132 HD
 ↘ BSF Julianne R593 JL ↘ Beckton Julian G1 J526
 ↘ BSF Regus M001 NP

DAM		Calv.Ease	BW	WW	YW	Milk	HPG	Stay	Maint.En.
Age	3	15	-3.5	28	60	15	11	15	-8.3
Wt	960	Marb +0.25		REA -0.02		Bfat +0.04			
Prog.BW	57	BWt	WWt	WR	ADG	YWt	YR	Scr.	Fr.
WR	94	64	559	98	2.95	975	92	33	5.0
YR	93								
Wean Pct.	54%								
Cow Eff.	114								

★★★★★ for Low Maintenance, Marbling, Calving Ease, Stayability.

209 **BECKTON JULIAN X303 N5**
1-A 100% # 1383256 Tattoo: BKT0 X303

Birth: 3-19-10
 ↗ Beckton Julian GG B571 ↘ Beckton Julian 7526G
BECKTON JULIAN G3 P608 ↙ Bkt Marta 9A13 JL
 Ref. J-3 ↘ Bkt Suffeina A828 DM ↙ Beckton Dominor 9455
 ↘ Bkt Suffeina 9493 TT
 ↗ Beckton Nebula M045 ↘ Beckton Neptune R2 K065
BECKTON MONA T493 NB ↙ Beckton Belga K285 JL
 ↘ Beckton Mona P539 CH ↘ Beckton Champ R1 H024
 ↘ Beckton Mona H298 JL

DAM		Calv.Ease	BW	WW	YW	Milk	HPG	Stay	Maint.En.
Age	3	19	-5.8	19	52	14	12	16	-4.5
Wt	970	Marb +0.26		REA -0.08		Bfat +0.01			
Prog.BW	59	BWt	WWt	WR	ADG	YWt	YR	Scr.	Fr.
WR	100	58	574	100	3.81	1102	104	36	5.0
YR	104								
Wean Pct.	55%								
Cow Eff.	116								

★★★★★ for Low Maintenance, Marbling, High Cow Efficiency, Calving Ease, Stayability.

207 **BSF LEGEND X699 L2**
1-B 99% # 1382956 Tattoo: BSF0 X699

Birth: 4-13-10
 ↗ Beckton Lancer F442 T ↘ Beckton Lancer T A664
BECKTON LEGEND S670 ↙ Bkt Suffeina A828 DM
 Ref. L-3 ↘ Beckton Kit F468 JL ↙ Beckton Julian GG B571
 ↘ Beckton Kit A517 NP
 ↗ Beckton Laser N602 ↘ Beckton Lancer F442 T
BSF JEWEL R614 LS ↙ Beckton Minola E589 TO
 ↘ BSF Jewel N039 JO ↘ Beckton Julio L233
 ↘ BSF Regus L013 CT

DAM		Calv.Ease	BW	WW	YW	Milk	HPG	Stay	Maint.En.
Age	5	14	-4.0	19	35	12	8	17	-7.8
Wt	1080	Marb +0.26		REA +0.26		Bfat +0.01			
Prog.BW	75	BWt	WWt	WR	ADG	YWt	YR	Scr.	Fr.
WR	109	65	583	101	3.48	1055	98	33	5.0
YR	105								
Wean Pct.	54%								
Cow Eff.	114								

★★★★★ for Low Maintenance, Marbling, Rib-eye area, Superior Cow, Calving Ease, Stayability.

210 **BECKTON JULIAN X246 N5**
1-A 100% # 1382771 Tattoo: BKT0 X246

Birth: 3-16-10
 ↗ Beckton Julian GJ P535 ↘ Beckton Julian 7526G
BECKTON JULIAN G5 S107 ↙ Beckton Mona D086 JL
 Ref. J-4 ↘ Beckton Minola P826 DM ↙ Beckton Dominor ZC M919
 ↘ Beckton Minola M641 WR
 ↗ Beckton Nebula M045 ↘ Beckton Neptune R2 K065
BECKTON COCA R675 NB ↙ Beckton Belga K285 JL
 ↘ Beckton Coca H745 CS ↘ Beckton Caesar M D023
 ↘ Beckton Coca E051 CL

DAM		Calv.Ease	BW	WW	YW	Milk	HPG	Stay	Maint.En.
Age	5	15	-4.0	19	51	13	11	17	-4.6
Wt	960	Marb +0.27		REA +0.01		Bfat +0.08			
Prog.BW	63	BWt	WWt	WR	ADG	YWt	YR	Scr.	Fr.
WR	94	64	532	89	3.48	1085	100	38	4.5
YR	95								
Wean Pct.	55%								
Cow Eff.	117								

★★★★★ for Low Maintenance, Marbling, High Cow Efficiency, Calving Ease, Stayability.

208 **BSF LIKABLE X310 A3**
1-B 99% # 1383089 Tattoo: BSF0 X310

Birth: 3-19-10
 ↗ Beckton Likable S633 ↘ Beckton Lancer F442 T
BECKTON LIKABLE U091 J2 ↙ Beckton Kit F468 JL
 Ref. L ↘ Beckton Jet L P491
 ↘ Beckton Lana P668 CH
 ↗ Beckton Cody K2 R168 ↘ Beckton Cody KH M390
BSF CODETTE U165 CD ↙ Beckton Tamara K249 VG
 ↘ BSF Regus F207 ↘ Beckton Caesar M D023
 ↘ BSF Regus D006

DAM		Calv.Ease	BW	WW	YW	Milk	HPG	Stay	Maint.En.
Age	2	17	-6.6	13	45	20	9	16	-8.2
Wt	628	Marb +0.11		REA +0.14		Bfat +0.02			
Prog.BW	59	BWt	WWt	WR	ADG	YWt	YR	Scr.	Fr.
WR	96	59	514	96	3.71	1040	103	32	5.5
YR	103								
Wean Pct.	72%								
Cow Eff.	152								

★★★★★ for Low Maintenance, Marbling, Rib-eye area, High Cow Efficiency, Calving Ease, Stayability.



• Bulls •

211 BECKTON JULIAN X401 C5
1-A 100% # 1383417 Tattoo: BKB0 X401

Birth: 3-24-10
 Beckton Julian GG B571
BECKTON JULIAN G3 P608
 Ref. J-3
 Beckton Julian 7526G
 Bkt Marta 9A13 JL
 Beckton Dominor 9455
 Bkt Suffeina 9493 TT
 Bieber Topper 2476
 RRR Miss Dynamo 7202
 Beckton Laser 8915
 Beckton Lana 9077 DT
 RDD B Topper 1675
BECKTON LANA E136 TP
 Beckton Lana 9714 LS

DAM		Calv.Ease	BW	WW	YW	Milk	HPG	Stay	Maint.En.
Age	7	14	-4.2	19	28	17	10	12	-6.8
Wt	1135	Marb +.28		REA +.10		Bfat +.00			
Prog.BW	69	BWt	WWt	WR	ADG	YWt	YR	Scr.	Fr.
WR	103	62	547	92	3.67	1044	96	35	5.0
YR	102								
Wean Pct.	48%								
Cow Eff.	102								

★★★★★ for Low Maintenance, Marbling, Calving Ease.

213 BECKTON WARRIOR X186 J6
1-A 100% # 1382740 Tattoo: BKT0 X186

Birth: 3-12-10
 Beckton Warrior N645 T1
BECKTON WARRIOR T248 L5
 Ref. W-2
 Beckton Warrior T1 H281
 Beckton Rose H074 EP
 Beckton Lancer F442 T
 Beckton Kit F468 JL
 Beckton Justice G302
 Beckton Mona H350 VG
 Beckton Herald FJ J776
 Beckton Lana C735 TP
 Beckton Justice V N656
BECKTON LANA R121 JC
 Beckton Lana N432 HR

DAM		Calv.Ease	BW	WW	YW	Milk	HPG	Stay	Maint.En.
Age	5	15	-4.4	18	34	11	13	15	-3.1
Wt	1105	Marb +.15		REA +.14		Bfat -.02			
Prog.BW	60	BWt	WWt	WR	ADG	YWt	YR	Scr.	Fr.
WR	89	62	522	88	3.24	960	89	37	4.5
YR	90								
Wean Pct.	47%								
Cow Eff.	99								

★★★★★ for Low Maintenance, Marbling, Rib-eye area, Calving Ease, Stayability.



214 BECKTON LOKI X639 N4
1-A 100% # 1383276 Tattoo: BKT0 X639

Birth: 4-7-10
 Beckton Loki C M740
BECKTON LOKI CL S284
 Ref. L-2
 Beckton Loki F251
 BKT Larkeisa J051 CK
 Beckton Latigo G714
 Beckton Lakme G128 HD
 Beckton Neptune R1 J245
 Beckton Coca J276 CL
 Beckton Epic K F075
 Beckton Lakme F560 TP
 Beckton Nexus L016
BECKTON LAKME T689 NX
 Beckton Lakme M669 EP

DAM		Calv.Ease	BW	WW	YW	Milk	HPG	Stay	Maint.En.
Age	3	12	-3.4	34	66	14	7	13	3.4
Wt	990	Marb +.12		REA -.10		Bfat +.03			
Prog.BW	72	BWt	WWt	WR	ADG	YWt	YR	Scr.	Fr.
WR	108	73	616	107	3.00	1070	99	38	5.0
YR	104								
Wean Pct.	58%								
Cow Eff.	123								

★★★★★ for Low Maintenance, Marbling, Superior Cow, High Cow Efficiency, Calving Ease, Stayability.

212 BECKTON LIKABLE X124 A3
1-A 100% # 1382607 Tattoo: BSF0 X124

Birth: 3-6-10
 Beckton Likable S633
BECKTON LIKABLE U130 L2
 Ref. L-6
 Beckton Lancer F442 T
 Beckton Kit F468 JL
 Beckton Lancer F442 T
 Beckton Kit F468 JL
 Beckton Cody KH M390
 Beckton Rose M126 WR
 Beckton Julian G1 J526
 Beckton Encino C644 ZN
 Beckton Cody K1 P014
BECKTON ENCINO U680 CD
 Beckton Encino R488 JL

DAM		Calv.Ease	BW	WW	YW	Milk	HPG	Stay	Maint.En.
Age	2	15	-4.0	23	48	14	9	19	-5.9
Wt	780	Marb +.06		REA +.44		Bfat +.02			
Prog.BW	59	BWt	WWt	WR	ADG	YWt	YR	Scr.	Fr.
WR	105	59	559	105	3.43	1027	102	36	5.0
YR	102								
Wean Pct.	64%								
Cow Eff.	135								

★★★★★ for Low Maintenance, Rib-eye area, High Cow Efficiency, Calving Ease, Stayability.

215 BECKTON EPIC X743 E5
1-A 100% # 1382717 Tattoo: BKT0 X743

Birth: 4-19-10
 Beckton Epic KJ J722
BECKTON EPIC K4 N795
 Ref. E-1
 Beckton Epic K F075
 Beckton Lana F891 JL
 Beckton Epic D404
 Beckton Sierra C157 CL
 Beckton Epic K F075
 Beckton Lana F891 JL
 Beckton Epic KJ J722
BKT PINE MARIE P351 EP
 BKT Pine Marie L002 HR
 Beckton Herald FV J537
 BKT Pine Marie J931 RN

DAM		Calv.Ease	BW	WW	YW	Milk	HPG	Stay	Maint.En.
Age	7	7	0.1	34	72	15	3	10	3.3
Wt	1140	Marb +.28		REA +.21		Bfat +.05			
Prog.BW	77	BWt	WWt	WR	ADG	YWt	YR	Scr.	Fr.
WR	110	79	625	105	3.81	1119	103	37	5.0
YR	110								
Wean Pct.	55%								
Cow Eff.	116								

★★★★★ for Low Maintenance, Marbling, Rib-eye area, Superior Cow, Calving Ease.

• Bulls •

216 BECKTON WARRIOR X029 J6
1-A 100% # 1383375 Tattoo: BKT0 X029

Birth: 2-15-10
 ↗ Beckton Warrior N645 T1 ↘ Beckton Warrior T1 H281
 ↗ Beckton Rose H074 EP ↘ Beckton Rose H074 EP
BECKTON WARRIOR U636 J5
 Ref. W-3 ↗ Beckton Lydia H159 JL ↘ Beckton Lydia H159 JL
 ↗ Beckton Julian GG B571 ↘ Beckton Julian GG B571
 ↗ Beckton Lydia D386 CL ↘ Beckton Lydia D386 CL
BECKTON COCA U512 JL
 ↗ Beckton Julian G3 P608 ↘ Beckton Julian GG B571
 ↗ Bkt Suffeina A828 DM ↘ Bkt Suffeina A828 DM
 ↗ Beckton Loki F251 ↘ Beckton Loki F251
 ↗ Beckton Coca H132 HD ↘ Beckton Coca H132 HD

DAM		Calv.Ease	BW	WW	YW	Milk	HPG	Stay	Maint.En.
Age	2	17	-5.1	19	46	13	12	17	-2.5
Wt	704	Marb +0.23		REA +0.17		Bfat +0.02			
Prog.BW	52	BWt	WWt	WR	ADG	YWt	YR	Scr.	Fr.
WR	97	52	542	97	3.95	1022	97	38	4.5
YR	97								
Wean Pct.	68%								
Cow Eff.	144								

★★★★★ for Low Maintenance, Marbling, Rib-eye area, High Cow Efficiency, Calving Ease, Stayability.



217 BECKTON JULIAN X146 E6
1-A 100% # 1383367 Tattoo: BKT0 X146

Birth: 3-9-10
 ↗ Beckton Julian G1 J526 ↘ Beckton Julian GG B571
 ↗ Beckton Annie F743 LN ↘ Beckton Annie F743 LN
BECKTON JULIAN U699 L5
 Ref. J-6 ↗ Beckton Rose L311 LN ↘ Beckton Rose L311 LN
 ↗ Beckton Lancer F442 T ↘ Beckton Lancer F442 T
 ↗ Beckton Rose H292 HD ↘ Beckton Rose H292 HD
BECKTON INDIGO U465 EP
 ↗ Beckton Epic K4 N795 ↘ Beckton Epic KJ J722
 ↗ Beckton Sierra J789 EP ↘ Beckton Sierra J789 EP
 ↗ Beckton Hustler C2 L079 ↘ Beckton Hustler C2 L079
 ↗ Beckton Indigo R559 HU ↘ Beckton Indigo F376 CT

DAM		Calv.Ease	BW	WW	YW	Milk	HPG	Stay	Maint.En.
Age	2	13	-3.6	37	66	9	6	14	-0.2
Wt	915	Marb +0.36		REA +0.07		Bfat +0.02			
Prog.BW	52	BWt	WWt	WR	ADG	YWt	YR	Scr.	Fr.
WR	103	52	549	103	3.71	1018	101	35	5.0
YR	101								
Wean Pct.	53%								
Cow Eff.	113								

★★★★★ for Low Maintenance, Marbling, Calving Ease, Stayability.

219 BECKTON JULIAN X359 N5
1-A 100% # 1383234 Tattoo: BKT0 X359

Birth: 3-21-10
 ↗ Beckton Julian GG B571 ↘ Beckton Julian GG B571
 ↗ Bkt Marta 9A13 JL ↘ Bkt Marta 9A13 JL
BECKTON JULIAN G3 P608
 Ref. J-3 ↗ Bkt Suffeina A828 DM ↘ Bkt Suffeina A828 DM
 ↗ Beckton Dominor 9455 ↘ Beckton Dominor 9455
 ↗ Bkt Suffeina 9493 TT ↘ Bkt Suffeina 9493 TT
BECKTON LANA T348 NB
 ↗ Beckton Nebula E P084 ↘ Beckton Nebula M045
 ↗ BKT Pine Marie M119 EP ↘ BKT Pine Marie M119 EP
 ↗ Beckton Lancer F442 T ↘ Beckton Lancer F442 T
 ↗ Beckton Lana J384 CD ↘ Beckton Lana J384 CD

DAM		Calv.Ease	BW	WW	YW	Milk	HPG	Stay	Maint.En.
Age	3	17	-5.0	22	54	14	7	16	-3.1
Wt	1045	Marb +0.38		REA +0.11		Bfat +0.02			
Prog.BW	69	BWt	WWt	WR	ADG	YWt	YR	Scr.	Fr.
WR	106	69	606	106	3.57	1093	103	32	5.0
YR	103								
Wean Pct.	54%								
Cow Eff.	114								

★★★★★ for Low Maintenance, Marbling, Superior Cow, Calving Ease, Stayability.

218 BECKTON SCAMP X357 J3
1-A 100% # 1383193 Tattoo: BKT0 X357

Birth: 3-21-10
 ↗ Beckton Scamp 8954 ↘ Beckton Julian 7526G
 ↗ Bkt Kusi Annie 5462 ↘ Bkt Kusi Annie 5462
BECKTON SCAMP T A825
 Ref. S-1 ↗ Beckton Trojan 7061P ↘ Beckton Trojan 7061P
 ↗ BCH Kit 7132-784 ↘ BCH Kit 7132-784
BECKTON LANA T088 JD
 ↗ TR Julian RT561 ↘ TR Julian LT151
 ↗ TR Dyna HT824 ↘ TR Dyna HT824
 ↗ Beckton Justice G302 ↘ Beckton Justice G302
 ↗ Beckton Lana R504 JC ↘ Beckton Lana M809 EP

DAM		Calv.Ease	BW	WW	YW	Milk	HPG	Stay	Maint.En.
Age	3	17	-5.2	20	46	16	10	13	-8.1
Wt	895	Marb +0.16		REA +0.01		Bfat +0.03			
Prog.BW	64	BWt	WWt	WR	ADG	YWt	YR	Scr.	Fr.
WR	104	64	597	104	3.43	1041	98	38	5.0
YR	98								
Wean Pct.	62%								
Cow Eff.	131								

★★★★★ for Low Maintenance, Marbling, High Cow Efficiency, Calving Ease, Stayability.

220 BECKTON WARRIOR X571 L6
1-A 100% # 1382849 Tattoo: BSF0 X571

Birth: 4-2-10
 ↗ Beckton Warrior N645 T1 ↘ Beckton Warrior T1 H281
 ↗ Beckton Rose H074 EP ↘ Beckton Rose H074 EP
BECKTON WARRIOR T248 L5
 Ref. W-2 ↗ Beckton Kit R503 LN ↘ Beckton Kit R503 LN
 ↗ Beckton Lancer F442 T ↘ Beckton Lancer F442 T
 ↗ Beckton Kit F468 JL ↘ Beckton Kit F468 JL
BKT LARKABEL M166 LN
 ↗ Beckton Lancer TS D390 ↘ Beckton Lancer T A664
 ↗ Beckton Coca 7536 SB ↘ Beckton Coca 7536 SB
 ↗ Beckton Clifftop TC E081 ↘ Beckton Clifftop TC E081
 ↗ Bkt Larkabel E645 MB ↘ Bkt Larkabel E645 MB

DAM		Calv.Ease	BW	WW	YW	Milk	HPG	Stay	Maint.En.
Age	8	15	-5.1	18	32	12	11	16	-7.0
Wt	1040	Marb +0.07		REA -0.04		Bfat +0.01			
Prog.BW	69	BWt	WWt	WR	ADG	YWt	YR	Scr.	Fr.
WR	102	65	604	105	3.48	1045	97	36	5.0
YR	100								
Wean Pct.	58%								
Cow Eff.	122								

★★★★★ for Low Maintenance, High Cow Efficiency, Calving Ease, Stayability.

• Bulls •

221 **BECKTON JET X040 J3**
1-A 100% # 1383099 Tattoo: BSF0 X040

Birth: 2-17-10
 Beckton Jet L P491 < TR Julian LT151
 Beckton Minerva L278 LN
BECKTON JET U473 L2
 Ref. J-5 < Beckton Lydia N047 LM
 Beckton Laramie L044
 Beckton Lydia L647 JL
 Beckton Jet L P491 < TR Julian LT151
BECKTON LANA U246 JT
 Beckton Lana M078 LN < Beckton Minerva L278 LN
 Beckton Lancer F442 T
 Beckton Lana G248 HR

DAM		Calv.Ease	BW	WW	YW	Milk	HPG	Stay	Maint.En.
Age	2	15	-4.2	24	47	21	7	17	-1.8
Wt	844	Marb +0.28		REA +0.12		Bfat +0.02			
Prog.BW	55	BWt	WWt	WR	ADG	YWt	YR	Scr.	Fr.
WR	103	55	516	103	3.19	959	98	34	5.0
YR	98								
Wean Pct.	54%								
Cow Eff.	114								

★★★★★ for Low Maintenance, Marbling, Calving Ease, Stayability.

224 **BECKTON JANUS X763 C2**
1-A 100% # 1383180 Tattoo: BKT0 X763

Birth: 4-21-10
 TR Romeo NT379 < Buffalo Creek Romeo L081
 Buf Crk Lass L420
BECKTON ROMAN J S158
 Ref. O-1 < Beckton Belga K285 JL
 Beckton Julian GG B571
 Beckton Belga G493 HR
 Beckton Clifftop T C075
 Beckton Christy K209 CO
 Beckton EOLA T005 CT
 BKT Clifftop TP R288 < Beckton Champ R1 H024
 Beckton Eola R280 CH < Beckton Eola M663 EP

DAM		Calv.Ease	BW	WW	YW	Milk	HPG	Stay	Maint.En.
Age	3	13	-2.1	37	64	21	8	13	-2.1
Wt	935	Marb -0.06		REA +0.34		Bfat -0.02			
Prog.BW	60	BWt	WWt	WR	ADG	YWt	YR	Scr.	Fr.
WR	110	63	669	117	3.38	1119	106	32	5.5
YR	103								
Wean Pct.	67%								
Cow Eff.	142								

★★★★★ for Low Maintenance, Growth, Rib-eye area, Superior Cow, High Cow Efficiency, Calving Ease, Stayability.

222 **BECKTON EPIC X347 J6**
1-A 100% # 1382592 Tattoo: BSF0 X347

Birth: 3-21-10
 Beckton Epic K4 N795 < Beckton Epic KJ J722
 Beckton Sierra J789 EP
BECKTON EPIC T524 L5
 Ref. E-4 < Beckton Lancer T4 J536
 Beckton Rose L083 LN
 Beckton Rose J152 LN
 Beckton Julian GJ P535 < Beckton Julian 7526G
 Beckton Mona D086 JL
BECKTON ENCINO U595 JL
 Beckton Encino L177 NM < Beckton Nomad 7496
 Beckton Encino G238 BR

DAM		Calv.Ease	BW	WW	YW	Milk	HPG	Stay	Maint.En.
Age	2	15	-4.5	22	45	14	7	14	1.1
Wt	925	Marb +0.36		REA +0.14		Bfat +0.06			
Prog.BW	66	BWt	WWt	WR	ADG	YWt	YR	Scr.	Fr.
WR	114	66	605	114	3.00	1023	101	33	5.0
YR	101								
Wean Pct.	59%								
Cow Eff.	124								

★★★★★ for Low Maintenance, Marbling, Rib-eye area, High Cow Efficiency, Calving Ease, Stayability.



223 **BECKTON HERITAGE X632 E3**
1-A 100% # 1383135 Tattoo: BKT0 X632

Birth: 4-7-10
 Beckton Heritage N013 < Beckton Hustler C2 L079
 Beckton Lana L007 JL
BECKTON HERITAGE T270 J2
 Ref. H-4 < Beckton Julian GG B571
 Beckton Coca P602 JL
 Beckton Coca J270 CD
 Beckton Epic K5 P071 < Beckton Epic KM M115
 Beckton Minerva M179 LN
BECKTON ROSE S269 EP
 Beckton Rose P684 JE < Beckton Jules L429
 Beckton Rose G688 CD

DAM		Calv.Ease	BW	WW	YW	Milk	HPG	Stay	Maint.En.
Age	4	18	-6.1	26	41	15	11	17	-5.6
Wt	915	Marb +0.37		REA -0.01		Bfat +0.05			
Prog.BW	62	BWt	WWt	WR	ADG	YWt	YR	Scr.	Fr.
WR	99	55	621	104	2.67	1013	94	35	4.5
YR	99								
Wean Pct.	66%								
Cow Eff.	138								

★★★★★ for Low Maintenance, Marbling, High Cow Efficiency, Calving Ease, Stayability.

225 **BECKTON CHEROKEE X459 A4**
1-A 100% # 1382948 Tattoo: BSF0 X459

Birth: 3-27-10
 Beckton Cherokee N N479 < BFCK Cherokee Cnyn 4912
 Beckton Dinah C440 NM
BECKTON CHEROKEE T450 L3
 Ref. C-1 < Beckton Annie M337 LN
 Beckton Lancer TL G626
 Beckton Annie F743 LN
 Beckton Cody KH M390 < Beckton Cody K G701
 Beckton Tamara J124 HR
BECKTON CHRISTY R434 CD
 Beckton Christy M362 WR < Beckton Warrior T C371
 Beckton Christy C306 JL

DAM		Calv.Ease	BW	WW	YW	Milk	HPG	Stay	Maint.En.
Age	5	16	-5.6	18	34	18	10	16	-5.7
Wt	1005	Marb +0.03		REA +0.13		Bfat +0.03			
Prog.BW	64	BWt	WWt	WR	ADG	YWt	YR	Scr.	Fr.
WR	98	64	568	95	3.14	976	90	37	4.5
YR	95								
Wean Pct.	57%								
Cow Eff.	119								

★★★★★ for Low Maintenance, Rib-eye area, High Cow Efficiency, Calving Ease, Stayability.

• Bulls •

226 BECKTON JULIAN X114 C6
1-A 100% # 1383352 Tattoo: BKT0 X114

Birth: 3-3-10

Beckton Julian G1 J526
Beckton Julian GG B571
Beckton Annie F743 LN
Beckton Lancer F442 T
Beckton Rose H292 HD
Beckton Clifftop T C075
Beckton Christy K209 CO
Beckton Clipper KH F416
Beckton Tamara H625 CH

BECKTON JULIAN U699 L5
Ref. J-6
Beckton Rose L311 LN

BKT Clifftop TP R288
BECKTON TAMARA U358 CT
Beckton Tamara L801 CL

DAM		Calv.	Ease	BW	WW	YW	Milk	HPG	Stay	Maint.En.
Age	2	14	-3.7	28	57	15	8	14	-2.9	
Wt	850									
Prog.BW	68									
WR	104									
YR	106									
Wean Pct.	55%									
Cow Eff.	115									
		Marb	+0.07	REA	+0.30	Bfat	+0.01			
		BWt	WWt	WR	ADG	YWt	YR	Scr.	Fr.	
		68	525	104	3.86	1034	106	35	5.0	

★★★★★ for Low Maintenance, Rib-eye area, Superior Cow, Calving Ease, Stayability.



227 BECKTON DOMINOR X613 N5
1-A 100% # 1382920 Tattoo: BSF0 X613

Birth: 4-5-10

Beckton Dominor ZC M919
Beckton Dominor Z E401
Beckton Barmaid J012 CO
Beckton Loki F251
Beckton Sierra C157 CL
Beckton Neptune RR B284
Beckton Lana C735 TP
Beckton Champ RH F275
Beckton Coca F048 LN

BECKTON DOMINOR Z1 R610
Ref. D-1
Beckton Sierra K557 LO

Beckton Neptune R2 K065
BECKTON COCA P713 NP
Beckton Coca H051 CH

DAM		Calv.	Ease	BW	WW	YW	Milk	HPG	Stay	Maint.En.
Age	6	14	-3.9	21	48	20	7	14	-3.5	
Wt	990									
Prog.BW	75									
WR	109									
YR	109									
Wean Pct.	56%									
Cow Eff.	118									
		Marb	+0.37	REA	-0.12	Bfat	+0.04			
		BWt	WWt	WR	ADG	YWt	YR	Scr.	Fr.	
		68	554	93	3.43	1037	96	35	4.5	

★★★★★ for Low Maintenance, Marbling, Superior Cow, High Cow Efficiency, Calving Ease, Stayability.

229 BECKTON NEBULA X665 L4
1-A 99% # 1383013 Tattoo: BSF0 X665

Birth: 4-10-10

Beckton Nebula J R475
Beckton Nebula M045
Beckton Larkeisa M138 JC
Beckton Hustler C2 L079
Bkt Pine Marie LC30 CD
Beckton Loki F251
BKT Larkeisa J051 CK
Beckton Lancer TH K417
Beckton Indigo K601 EP

BECKTON NEBULA T054 H3
Ref. N-7
BKT Pine Marie R401 HU

Beckton Loki C M740
BECKTON INDIGO S538 LO
Beckton Indigo M585 LN

DAM		Calv.	Ease	BW	WW	YW	Milk	HPG	Stay	Maint.En.
Age	4	17	-5.4	22	53	12	8	14	-4.5	
Wt	970									
Prog.BW	51									
WR	97									
YR	102									
Wean Pct.	58%									
Cow Eff.	121									
		Marb	+0.26	REA	+0.11	Bfat	+0.01			
		BWt	WWt	WR	ADG	YWt	YR	Scr.	Fr.	
		60	579	97	3.67	1073	99	38	5.0	

★★★★★ for Low Maintenance, Marbling, High Cow Efficiency, Calving Ease, Stayability.

228 BECKTON CHEROKEE X280 J4
1-A 100% # 1382804 Tattoo: BSF0 X280

Birth: 3-18-10

Beckton Cherokee N N479
BFCK Cherokee Cnyn 4912
Beckton Dinah C440 NM
Beckton Lancer TL G626
Beckton Annie F743 LN
Beckton Julian GG B571
Beckton Julian 7526G
Bkt Marta 9A13 JL
Beckton Lancer T A664
Beckton Rose A624 BF

BECKTON CHEROKEE T450 L3
Ref. C-1
Beckton Annie M337 LN

Beckton Julian GG B571
BECKTON ROSE G345 JL
Beckton Rose D741 LN

DAM		Calv.	Ease	BW	WW	YW	Milk	HPG	Stay	Maint.En.
Age	13	18	-5.5	15	40	17	10	19	-2.9	
Wt	1185									
Prog.BW	69									
WR	99									
YR	99									
Wean Pct.	42%									
Cow Eff.	88									
		Marb	+0.11	REA	+0.21	Bfat	+0.03			
		BWt	WWt	WR	ADG	YWt	YR	Scr.	Fr.	
		61	518	90	3.91	1024	95	35	4.5	

★★★★★ for Low Maintenance, Marbling, Rib-eye area, Calving Ease, Stayability.

230 BECKTON EPIC X693 A5
1-A 100% # 1382821 Tattoo: BSF0 X693

Birth: 4-13-10

Beckton Epic KM M115
Beckton Epic K F075
Beckton Minerva F495 CH
Beckton Laramie L044
Beckton Sierra L887 LN
Beckton Cody C401
Beckton Birdie C353 VG
Beckton Neptune RT Z305
Bkt Firefly 9787 PC

BECKTON EPIC K6 S569
Ref. E-2
Beckton Sierra N703 LM

Beckton Cody V E023
BECKTON FIREFLY J650 CD
Beckton Firefly E684 NP

DAM		Calv.	Ease	BW	WW	YW	Milk	HPG	Stay	Maint.En.
Age	11	13	-3.8	18	46	21	12	13	-1.2	
Wt	1090									
Prog.BW	70									
WR	101									
YR	99									
Wean Pct.	53%									
Cow Eff.	111									
		Marb	+0.23	REA	-0.12	Bfat	+0.04			
		BWt	WWt	WR	ADG	YWt	YR	Scr.	Fr.	
		65	593	100	3.67	1093	101	35	5.0	

★★★★★ for Low Maintenance, Marbling, Calving Ease, Stayability.

• Bulls •

231 BECKTON LIKABLE X053 E3
1-A 100% # 1382587 Tattoo: BSF0 X053

Birth: 2-20-10
 Beckton Likable S633
BECKTON LIKABLE U120 L2
 Ref. L-5
 Beckton Lana S718 LN
 Beckton Lancer F442 T
 Beckton Kit F468 JL
 Beckton Lancer F442 T
 Beckton Lana F891 JL
 Beckton Epic R350 K
 Beckton Epic K F075
BECKTON MARTA U570 EP
 Beckton Marta G512 LN
 Beckton Larkaba E042 CD
 Beckton Lancer T A664
 Beckton Marta C314 JL

DAM		Calv.Ease	BW	WW	YW	Milk	HPG	Stay	Maint.En.
Age	2	12	-3.1	21	48	10	6	18	-0.9
Wt	915	Marb +0.22		REA +0.32		Bfat +0.02			
Prog.BW	55	BWt	WWt	WR	ADG	YWt	YR	Scr.	Fr.
WR	90	55	481	90	3.57	986	98	36	5.0
YR	98								
Wean Pct.	46%								
Cow Eff.	97								

★★★★★ for Low Maintenance, Marbling, Rib-eye area, Calving Ease, Stayability.

234 BECKTON CHEROKEE X755 W4
1-A 100% # 1382678 Tattoo: BKT0 X755

Birth: 4-21-10
 Beckton Cherokee N N479
BECKTON CHEROKEE T450 L3
 Ref. C-1
 Beckton Annie M337 LN
 BFCK Cherokee Cnyn 4912
 Beckton Dinah C440 NM
 Beckton Lancer TL G626
 Beckton Annie F743 LN
 Beckton Warrior C C355
BECKTON LANA M372 WR
 Beckton Lana G730 JL
 JKG Chiefton L303
 Bkt Christy 9A01 CL
 Beckton Julian GG B571
 Beckton Lana 9841 NM

DAM		Calv.Ease	BW	WW	YW	Milk	HPG	Stay	Maint.En.
Age	8	11	-2.1	20	48	16	12	16	-5.0
Wt	1235	Marb -0.04		REA +0.09		Bfat +0.02			
Prog.BW	70	BWt	WWt	WR	ADG	YWt	YR	Scr.	Fr.
WR	99	83	544	91	3.67	1053	97	39	4.5
YR	100								
Wean Pct.	44%								
Cow Eff.	93								

★★★★★ for Low Maintenance, Calving Ease, Stayability.

232 BECKTON HASTEN X611 J3
1-A 100% # 1383019 Tattoo: BSF0 X611

Birth: 4-5-10
 Beckton Hasten P292
BECKTON HASTEN H S462
 Ref. H-3
 Beckton Lakme G128 HD
 Beckton Hustler C2 L079
 Beckton Sheba L644 CH
 Beckton Hadrian FC E166
 Beckton Lakme E373 CL
 Beckton Julio L233
 Beckton Julian G1 J526
BECKTON RUTH S671 JO
 Beckton Ruth F125 KA
 Beckton Rose J725 EP
 Beckton Kannon D202
 Beckton Ruth D247 KR

DAM		Calv.Ease	BW	WW	YW	Milk	HPG	Stay	Maint.En.
Age	4	17	-6.2	12	29	17	8	14	-5.0
Wt	945	Marb -0.06		REA +0.02		Bfat +0.02			
Prog.BW	62	BWt	WWt	WR	ADG	YWt	YR	Scr.	Fr.
WR	93	57	522	87	3.33	1008	91	33	5.0
YR	94								
Wean Pct.	53%								
Cow Eff.	112								

★★★★★ for Low Maintenance, Calving Ease, Stayability.



233 BECKTON RANGER X508 J4
1-A 100% # 1383229 Tattoo: BKT0 X508

Birth: 3-29-10
 Beckton Ranger 9479R
BECKTON RANGER T603 H3
 Ref. R-1
 Beckton Rose N044 HU
 Beckton Ranger 7003
 Beckton Eola 7470 RZ
 Beckton Hustler C2 L079
 Beckton Rose L669 JL
 Beckton Justice CH M056
 Beckton Justice C K449
BECKTON MINERVA T318 JC
 Beckton Minerva K370 CO
 Beckton Ruth K802 HD
 Beckton Copper J E616
 Beckton Minerva E932 JL

DAM		Calv.Ease	BW	WW	YW	Milk	HPG	Stay	Maint.En.
Age	3	17	-5.9	13	35	17	11	12	-7.1
Wt	900	Marb +0.30		REA -0.10		Bfat +0.02			
Prog.BW	49	BWt	WWt	WR	ADG	YWt	YR	Scr.	Fr.
WR	103	50	573	100	3.76	1045	99	36	5.0
YR	103								
Wean Pct.	59%								
Cow Eff.	125								

★★★★★ for Low Maintenance, Marbling, High Cow Efficiency, Calving Ease.

235 BECKTON NEBULA X707 N4
1-A 99% # 1383188 Tattoo: BKT0 X707

Birth: 4-14-10
 Beckton Nebula L P093
BECKTON NEBULA T398 V3
 Ref. N-9
 Beckton Minerva J615 VG
 Beckton Nebula M045
 Beckton Marta M021 LN
 Beckton Vegas PK F485
 Beckton Minerva F433 VG
 Beckton Nebula H R233
BECKTON SUSAN T048 NB
 Beckton Susan R022 CQ
 Beckton Nebula M045
 Beckton Coca H132 HD
 Beckton Cherokee N N479
 Beckton Susan N023 JE

DAM		Calv.Ease	BW	WW	YW	Milk	HPG	Stay	Maint.En.
Age	3	12	-2.8	29	57	18	11	15	-5.9
Wt	895	Marb +0.17		REA +0.12		Bfat +0.02			
Prog.BW	67	BWt	WWt	WR	ADG	YWt	YR	Scr.	Fr.
WR	110	74	596	104	3.71	1051	99	37	5.0
YR	106								
Wean Pct.	62%								
Cow Eff.	131								

★★★★★ for Low Maintenance, Marbling, Superior Cow, High Cow Efficiency, Calving Ease, Stayability.

• Bulls •

236 BECKTON HERITAGE X634 W3
1-A 100% # 1383241 Tattoo: BKT0 X634

Birth: 4-7-10

Beckton Heritage N013
Beckton Hustler C2 L079
Beckton Lana L007 JL
Beckton Julian GG B571
Beckton Coca J270 CD
Beckton Warrior T1 H281
Beckton Firefly H195 HD
Beckton Julian G1 J526
Beckton Larkaba F279 LN

BECKTON HERITAGE T270 J2

Ref. H-4 Beckton Coca P602 JL

BECKTON LARKABA T418 WA

Beckton Warhawk N560

Beckton Larkaba P783 JL

DAM

Age 3
Wt 1035
Prog.BW 63
WR 104
YR 105
Wean Pct. 46%
Cow Eff. 98

Calv.Ease	BW	WW	YW	Milk	HPG	Stay	Maint.En.
16	-4.1	32	60	10	12	17	0.4
Marb +.30		REA +.08		Bfat +.04			
BWt	WWt	WR	ADG	YWt	YR	Scr.	Fr.
62	520	98	3.67	1027	100	34	5.0



★★★★★ for Low Maintenance, Marbling, Superior Cow, Calving Ease, Stayability.

237 BECKTON EPIC X485 J6
1-A 100% # 1383318 Tattoo: BKT0 X485

Birth: 3-28-10

Beckton Epic K7 S583
Beckton Epic KJ J722
Beckton Kit F468 JL
Beckton Jet L P491
Beckton Ruth P591 LN
Beckton Justice C K449
Beckton Ruth K802 HD
Beckton Justice CH M056
Beckton Brutus T E062
Beckton Encino G238 BR
Beckton Encino E821 JL

BECKTON EPIC U126 J5

Ref. E-7 Beckton Ruth S076 JT

BECKTON ENCINO U134 JC

Beckton Justice CH M056

Beckton Encino G238 BR

DAM

Age 2
Wt 995
Prog.BW 50
WR 100
YR 99
Wean Pct. 48%
Cow Eff. 101

Calv.Ease	BW	WW	YW	Milk	HPG	Stay	Maint.En.
14	-4.4	17	36	20	9	14	1.7
Marb +.27		REA +.01		Bfat -.02			
BWt	WWt	WR	ADG	YWt	YR	Scr.	Fr.
50	535	100	3.33	1000	99	34	5.0

★★★★★ for Low Maintenance, Marbling, Calving Ease, Stayability.

239 BECKTON CHEROKEE X581 N4
1-A 100% # 1383213 Tattoo: BKT0 X581

Birth: 4-2-10

Beckton Cherokee N N479
BFCK Cherokee Cryn 4912
Beckton Dinah C440 NM
Beckton Lancer TL G626
Beckton Annie F743 LN
Beckton Neptune R2 K065
Beckton Belga K285 JL
Beckton Nebula M045
Beckton Cody V E023
Bkt Pine Marie LC30 CD
Bkt Pine Marie D764 HD

BECKTON CHEROKEE T450 L3

Ref. C-1 Beckton Annie M337 LN

BKT PINE MARIE T206 NB

Beckton Nebula M045

Bkt Pine Marie LC30 CD

DAM

Age 3
Wt 1010
Prog.BW 55
WR 94
YR 97
Wean Pct. 47%
Cow Eff. 99

Calv.Ease	BW	WW	YW	Milk	HPG	Stay	Maint.En.
18	-6.2	15	41	18	13	14	-4.4
Marb +.13		REA +.06		Bfat +.03			
BWt	WWt	WR	ADG	YWt	YR	Scr.	Fr.
50	513	90	3.52	996	94	34	5.0

★★★★★ for Low Maintenance, Marbling, Calving Ease, Stayability.

238 BECKTON NEBULA X775 L3
1-A 100% # 1383158 Tattoo: BKT0 X775

Birth: 4-25-10

Beckton Nebula M045
Beckton Neptune R2 K065
Beckton Belga K285 JL
Beckton Epic KN H110
Beckton Ruth A905 SG
Beckton Lancer TA K644
BKT Larkeisa H232 SC
Beckton Lancer T9 N586
Beckton Epic KJ J722
BKT Larkeisa M816 EP
BKT Larkeisa J076 DM

BECKTON NEBULA T269 E2

Ref. N-8 Beckton Ruth M967 EP

BKT LARKEISA S605 LN

Beckton Lancer T9 N586

BKT Larkeisa M816 EP

DAM

Age 4
Wt 950
Prog.BW 79
WR 97
YR 96
Wean Pct. 62%
Cow Eff. 131

Calv.Ease	BW	WW	YW	Milk	HPG	Stay	Maint.En.
10	-0.9	25	49	13	9	13	-8.3
Marb +.22		REA +.14		Bfat +.03			
BWt	WWt	WR	ADG	YWt	YR	Scr.	Fr.
78	613	103	3.33	1027	95	37	5.5

★★★★★ for Low Maintenance, Marbling, Rib-eye area, High Cow Efficiency, Calving Ease, Stayability.

240 BECKTON NEBULA X431 V4
1-A 100% # 1383340 Tattoo: BKT0 X431

Birth: 3-25-10

Beckton Nebula P P707
Beckton Nebula M045
Beckton Lana M809 EP
Beckton Vegas PK F485
Beckton Minerva F433 VG
Beckton Vega P079
Beckton Vegas S1 K316
Beckton Lydia H159 JL
Beckton Julian G2 M345
Beckton Lana M078 LN

BECKTON NEBULA U206 V3

Ref. N-12 Beckton Minerva J615 VG

BECKTON LANA U297 VA

Beckton Vega P079

Beckton Lana P317 JL

DAM

Age 2
Wt 810
Prog.BW 47
WR 108
YR 106
Wean Pct. 64%
Cow Eff. 134

Calv.Ease	BW	WW	YW	Milk	HPG	Stay	Maint.En.
14	-3.1	31	59	16	9	15	-7.9
Marb +.15		REA +.13		Bfat +.01			
BWt	WWt	WR	ADG	YWt	YR	Scr.	Fr.
47	577	108	3.67	1068	106	32	5.0

★★★★★ for Low Maintenance, Marbling, Rib-eye area, Superior Cow, High Cow Efficiency, Calving Ease, Stayability.

• Bulls •

241 BECKTON DOMINOR X602 N5
1-A 100% # 1383281 Tattoo: BKT0 X602

Birth: 4-4-10
 Beckton Dominor ZC M919 < Beckton Dominor Z E401
 Beckton Barmaid J012 CO
BECKTON DOMINOR Z1 R610
 Ref. D-1 < Beckton Sierra K557 LO < Beckton Loki F251
 < Beckton Sierra C157 CL
 < Beckton Nebula M045
BKT SUFFEINA T724 NB
 < Beckton Nebula E P084 < BKT Pine Marie M119 EP
 < Beckton Julian GG B571
 < Beckton Suffeina P603 JL < Bkt Suffeina A828 DM

DAM		Calv.Ease	BW	WW	YW	Milk	HPG	Stay	Maint.En.
Age	3	19	-6.4	17	43	15	7	18	-0.5
Wt	965	Marb +0.33		REA +0.02		Bfat +0.06			
Prog.BW	57	BWt	WWt	WR	ADG	YWt	YR	Scr.	Fr.
WR	97	54	548	96	3.67	996	94	35	5.0
YR	96								
Wean Pct.	53%								
Cow Eff.	111								

★★★★★ for Low Maintenance, Marbling, Calving Ease, Stayability.

244 BSF JULIAN X171 C6
1-B 99% # 1382586 Tattoo: BSF0 X171

Birth: 3-11-10
 Beckton Julian G3 P608 < Beckton Julian GG B571
 Bkt Suffeina A828 DM
BECKTON JULIAN U742 W5
 Ref. J < Beckton Rose M126 WR < Beckton Warrior T C371
 < Beckton Rose D741 LN
 < Bkt Clifftop TV G672
BSF LAUREL U563 CT
 < Beckton Clifftop T3 N800 < Beckton Lana J384 CD
 < Beckton Lancer T4 J536
 < BSF Laurel N239 LN < BSF Regus F071

DAM		Calv.Ease	BW	WW	YW	Milk	HPG	Stay	Maint.En.
Age	2	16	-5.7	18	46	18	7	14	-3.6
Wt	828	Marb +0.31		REA +0.09		Bfat +0.02			
Prog.BW	57	BWt	WWt	WR	ADG	YWt	YR	Scr.	Fr.
WR	105	57	562	105	3.38	991	98	34	5.0
YR	98								
Wean Pct.	61%								
Cow Eff.	128								

★★★★★ for Low Maintenance, Marbling, High Cow Efficiency, Calving Ease, Stayability.

242 BECKTON EPIC X702 C5
1-A 100% # 1382631 Tattoo: BKT0 X702

Birth: 4-13-10
 Beckton Epic KJ J722 < Beckton Epic K F075
 Beckton Lana F891 JL
BECKTON EPIC K4 N795
 Ref. E-1 < Beckton Sierra J789 EP < Beckton Epic D404
 < Beckton Sierra C157 CL
 < BJR Topper 5241
BECKTON COCA F370 CT
 < Beckton Clifftop T C075 < Beckton Barmaid A761 TR
 < Beckton Vegas 9433
 < Beckton Coca C178 VG < Beckton Coca 8372 TJ

DAM		Calv.Ease	BW	WW	YW	Milk	HPG	Stay	Maint.En.
Age	14	10	-2.8	22	58	14	4	12	1.3
Wt	1090	Marb +0.20		REA +0.29		Bfat +0.02			
Prog.BW	68	BWt	WWt	WR	ADG	YWt	YR	Scr.	Fr.
WR	98	75	498	84	3.67	1009	93	36	5.0
YR	100								
Wean Pct.	44%								
Cow Eff.	92								

★★★★★ for Low Maintenance, Marbling, Rib-eye area, Calving Ease.



243 BSF LIKABLE X462 L3
1-B 99% # 1383081 Tattoo: BSF0 X462

Birth: 3-27-10
 Beckton Likable S633 < Beckton Lancer F442 T
 Beckton Kit F468 JL
BECKTON LIKABLE U130 L2
 Ref. L-6 < Beckton Lancer F442 T
 Beckton Kit F468 JL
 < Beckton Kit F468 JL
 < Beckton Loki C M740
BSF HUSTELLE U113 LO
 < Beckton Loki CL S284 < Beckton Lakme J460 LT
 < Beckton Hustler C2 L079
 < BSF Hustelle S375 HU < BSF Regus M508 LN

DAM		Calv.Ease	BW	WW	YW	Milk	HPG	Stay	Maint.En.
Age	2	13	-3.0	28	57	10	7	18	-2.3
Wt	895	Marb +0.05		REA +0.38		Bfat +0.02			
Prog.BW	55	BWt	WWt	WR	ADG	YWt	YR	Scr.	Fr.
WR	105	55	558	105	3.67	1047	104	33	5.0
YR	104								
Wean Pct.	56%								
Cow Eff.	117								

★★★★★ for Low Maintenance, Rib-eye area, Superior Cow, High Cow Efficiency, Calving Ease, Stayability.

245 BSF LIKABLE X139 A3
1-B 99% # 1382615 Tattoo: BSF0 X139

Birth: 3-7-10
 Beckton Likable S633 < Beckton Lancer F442 T
 Beckton Kit F468 JL
BECKTON LIKABLE U130 L2
 Ref. L-6 < Beckton Lancer F442 T
 Beckton Kit F468 JL
 < Beckton Kit F468 JL
 < Beckton Cody KH M390
BSF CODETTE U765 CD
 < Beckton Cody K1 P014 < Beckton Rose M126 WR
 < Beckton Clifftop T C075
 < BSF Red G329 < BSF Regus D038

DAM		Calv.Ease	BW	WW	YW	Milk	HPG	Stay	Maint.En.
Age	2	13	-3.7	17	42	15	9	18	-4.7
Wt	710	Marb -0.01		REA +0.51		Bfat +0.01			
Prog.BW	59	BWt	WWt	WR	ADG	YWt	YR	Scr.	Fr.
WR	99	59	526	99	3.71	1022	101	36	4.5
YR	101								
Wean Pct.	66%								
Cow Eff.	138								

★★★★★ for Low Maintenance, Rib-eye area, High Cow Efficiency, Calving Ease, Stayability.

• Bulls •

246 **BSF LIKABLE X163 A3**
1-B 99% # 1382626 Tattoo: BSF0 X163

Birth: 3-11-10
 ↗ Beckton Likable S633 ↘ Beckton Lancer F442 T
 ↗ Beckton Kit F468 JL ↘ Beckton Kit F468 JL
BECKTON LIKABLE U130 L2
 Ref. L-6 ↗ Beckton Kit S478 LN ↘ Beckton Lancer F442 T
 ↗ Beckton Kit F468 JL ↘ Beckton Kit F468 JL
 ↗ Beckton Cody KH M390 ↘ Beckton Cody KH M390
BSF CODETTE U860 CD
 ↗ Beckton Rose M126 WR ↘ Beckton Rose M126 WR
 ↗ Beckton Lancer TL G626 ↘ Beckton Lancer TL G626
 ↗ BSF Regus J378 ↘ BSF Regus J378
 ↗ Beckton Cody K1 P014 ↘ Beckton Cody K1 P014
 ↗ BSF Regus M604 LN ↘ BSF Regus M604 LN

DAM		Calv.Ease	BW	WW	YW	Milk	HPG	Stay	Maint.En.
Age	2	14	-4.0	18	39	15	9	19	-2.6
Wt	764								
Prog.BW	53								
WR	100								
YR	96								
Wean Pct.	62%								
Cow Eff.	130								
		Marb			REA		Bfat		
		BWt	WWt	WR	ADG	YWt	YR	Scr.	Fr.
		53	531	100	3.24	974	96	34	4.5

★★★★★ for Low Maintenance, Rib-eye area, High Cow Efficiency, Calving Ease, Stayability.



247 **BSF HERITAGE X747 J3**
1-B 99% # 1383053 Tattoo: BSF0 X747

Birth: 4-19-10
 ↗ Beckton Heritage N013 ↘ Beckton Hustler C2 L079
 ↗ Beckton Lana L007 JL ↘ Beckton Lana L007 JL
BECKTON HERITAGE T270 J2
 Ref. H-4 ↗ Beckton Coca P602 JL ↘ Beckton Julian GG B571
 ↗ Beckton Coca J270 CD ↘ Beckton Coca J270 CD
 ↗ Beckton Julian G1 J526 ↘ Beckton Julian G1 J526
BSF JUNE T528 JJ
 ↗ Beckton Serena D760 KR ↘ Beckton Serena D760 KR
 ↗ Beckton Caesar M D023 ↘ Beckton Caesar M D023
 ↗ BSF Regus G340 ↘ BSF Regus G340
 ↗ BSF Regus CB58 ↘ BSF Regus CB58

DAM		Calv.Ease	BW	WW	YW	Milk	HPG	Stay	Maint.En.
Age	3	15	-4.4	31	55	11	10	17	-1.2
Wt	1035								
Prog.BW	52								
WR	102								
YR	102								
Wean Pct.	52%								
Cow Eff.	110								
		Marb			REA		Bfat		
		BWt	WWt	WR	ADG	YWt	YR	Scr.	Fr.
		66	582	102	3.24	1046	99	35	5.0

★★★★★ for Low Maintenance, Marbling, Calving Ease, Stayability.

249 **BSF EPIC X746 J5**
1-B 99% # 1383060 Tattoo: BSF0 X746

Birth: 4-19-10
 ↗ Beckton Epic KM M115 ↘ Beckton Epic K F075
 ↗ Beckton Minerva F495 CH ↘ Beckton Minerva F495 CH
BECKTON EPIC K6 S569
 Ref. E-2 ↗ Beckton Sierra N703 LM ↘ Beckton Laramie L044
 ↗ Beckton Sierra L887 LN ↘ Beckton Sierra L887 LN
 ↗ Beckton Julian GG B571 ↘ Beckton Julian GG B571
BSF LANETTE T781 JL
 ↗ Bkt Suffeina A828 DM ↘ Bkt Suffeina A828 DM
 ↗ Beckton Lancer T4 J536 ↘ Beckton Lancer T4 J536
 ↗ BSF Regus P615 ↘ BSF Regus P615
 ↗ BSF Regus F697 ↘ BSF Regus F697

DAM		Calv.Ease	BW	WW	YW	Milk	HPG	Stay	Maint.En.
Age	3	14	-3.9	28	66	23	11	18	-2.5
Wt	756								
Prog.BW	66								
WR	110								
YR	106								
Wean Pct.	77%								
Cow Eff.	162								
		Marb			REA		Bfat		
		BWt	WWt	WR	ADG	YWt	YR	Scr.	Fr.
		62	621	108	3.43	1116	105	36	5.0

★★★★★ for Low Maintenance, Growth, Marbling, Superior Cow, High Cow Efficiency, Calving Ease, Stayability.

248 **BSF NEBULA X788 C4**
1-B 99% # 1383001 Tattoo: BSF0 X788

Birth: 4-26-10
 ↗ Beckton Nebula P P707 ↘ Beckton Nebula M045
 ↗ Beckton Lana M809 EP ↘ Beckton Lana M809 EP
BECKTON NEBULA PJ S543
 Ref. N-6 ↗ Beckton Lana P685 JO ↘ Beckton Julio L233
 ↗ Beckton Lana E083 CD ↘ Beckton Lana E083 CD
 ↗ Bkt Clifftop TV G672 ↘ Bkt Clifftop TV G672
BSF CLIFFTANA S379 CT
 ↗ Beckton Lana J384 CD ↘ Beckton Lana J384 CD
 ↗ Beckton Champ R1 H024 ↘ Beckton Champ R1 H024
 ↗ BSF Regus H402 ↘ BSF Regus H402
 ↗ Beckton Clifftop T3 N800 ↘ Beckton Clifftop T3 N800
 ↗ BSF Regus K090 CH ↘ BSF Regus K090 CH

DAM		Calv.Ease	BW	WW	YW	Milk	HPG	Stay	Maint.En.
Age	4	18	-6.8	21	44	16	6	13	1.7
Wt	1175								
Prog.BW	65								
WR	102								
YR	99								
Wean Pct.	48%								
Cow Eff.	100								
		Marb			REA		Bfat		
		BWt	WWt	WR	ADG	YWt	YR	Scr.	Fr.
		58	578	97	3.38	1030	95	39	5.0

★★★★★ for Low Maintenance, Marbling, Rib-eye area, Calving Ease, Stayability.

250 **BSF LEGEND X718 J2**
1-B 94% # 1382802 Tattoo: BSF0 X718

Birth: 4-15-10
 ↗ Beckton Lancer F442 T ↘ Beckton Lancer T A664
 ↗ Beckton Lancer T A664 ↘ Bkt Suffeina A828 DM
BECKTON LEGEND S670
 Ref. L-3 ↗ Beckton Kit F468 JL ↘ Beckton Julian GG B571
 ↗ Beckton Kit A517 NP ↘ Beckton Kit A517 NP
 ↗ Beckton Julian 6592 ↘ Beckton Julian 6592
BSF REGUS F712
 ↗ Bkt Belga 6746 GS ↘ Bkt Belga 6746 GS
 ↗ BSF Red 8127 ↘ BSF Red 8127
 ↗ BSF Red 8314 ↘ BSF Red 8314
 ↗ Beckton Julian 7526G ↘ Beckton Julian 7526G
 ↗ BSF Red 5289-2 ↘ BSF Red 5289-2

DAM		Calv.Ease	BW	WW	YW	Milk	HPG	Stay	Maint.En.
Age	14	13	-2.3	14	24	11	12	19	-6.6
Wt	1130								
Prog.BW	78								
WR	103								
YR	99								
Wean Pct.	46%								
Cow Eff.	96								
		Marb			REA		Bfat		
		BWt	WWt	WR	ADG	YWt	YR	Scr.	Fr.
		63	536	90	3.24	1000	92	32	5.0

★★★★★ for Low Maintenance, Marbling, Rib-eye area, Calving Ease, Stayability.

• Bulls •

251 **BSF JULIAN X803 N5**
1-B 99% # 1383427 Tattoo: BKB0 X803

Birth: 4-30-10
 Beckton Julian GJ P535
BECKTON JULIAN G5 S107
 Ref. J-4
 Beckton Minola P826 DM
 Beckton Julian 7526G
 Beckton Mona D086 JL
 Beckton Dominor ZC M919
 Beckton Minola M641 WR
 Beckton Nebula M045
 Beckton Larkeisa M138 JC
 Beckton Jules L429
 BSF Red K467 CD
 Beckton Nebula J R475
BSF JULESTE T491 NB
 BSF Juleste R249 JE

DAM		Calv.Ease	BW	WW	YW	Milk	HPG	Stay	Maint.En.
Age	3	14	-3.5	23	53	10	12	17	-5.2
Wt	798	Marb +0.26		REA +0.15		Bfat +0.06			
Prog.BW	55	BWt	WWt	WR	ADG	YWt	YR	Scr.	Fr.
WR	89	66	584	102	3.29	1047	99	34	5.0
YR	84								
Wean Pct.	68%								
Cow Eff.	144								

★★★★★ for Low Maintenance, Marbling, Rib-eye area, High Cow Efficiency, Calving Ease, Stayability.

254 **BECKTON NEBULA X594 J4**
1-A 100% # 1383379 Tattoo: BKT0 X594

Birth: 4-3-10
 Beckton Nebula G S237
BECKTON NEBULA U031 D3
 Ref. N-10
 Beckton Marta S459 DM
 Beckton Nebula M045
 Beckton Lakme LA06 JL
 Beckton Dominor ZC M919
 Beckton Marta G675 LN
 Beckton Scamp 8954
 Bkt Encino 8459 TJ
 Beckton Scamp T A825
BECKTON COCA U527 SC
 Beckton Coca R012 LN
 Beckton Lancer T8 N337
 Beckton Coca N459 NP

DAM		Calv.Ease	BW	WW	YW	Milk	HPG	Stay	Maint.En.
Age	2	18	-5.6	24	51	15	10	15	-0.4
Wt	778	Marb +0.29		REA +0.01		Bfat +0.01			
Prog.BW	53	BWt	WWt	WR	ADG	YWt	YR	Scr.	Fr.
WR	113	53	602	113	3.43	1062	105	31	5.0
YR	105								
Wean Pct.	70%								
Cow Eff.	147								

★★★★★ for Low Maintenance, Marbling, Superior Cow, High Cow Efficiency, Calving Ease, Stayability.

252 **BECKTON WARRIOR X726 H6**
1-A 100% # 1382969 Tattoo: BSF0 X726

Birth: 4-16-10
 Beckton Warrior N645 T1
BECKTON WARRIOR T248 L5
 Ref. W-2
 Beckton Kit R503 LN
 Beckton Hustler C2 L079
BECKTON CHRISTY R815 HU
 Beckton Christy C306 JL
 Beckton Warrior T1 H281
 Beckton Rose H074 EP
 Beckton Lancer F442 T
 Beckton Kit F468 JL
 Beckton Hustler CN J102
 Beckton Barmaid J012 CO
 Beckton Julian 7526G
 Beckton Christy Z264 NP

DAM		Calv.Ease	BW	WW	YW	Milk	HPG	Stay	Maint.En.
Age	5	14	-4.4	23	43	11	12	15	-5.6
Wt	950	Marb +0.09		REA +0.11		Bfat -0.02			
Prog.BW	65	BWt	WWt	WR	ADG	YWt	YR	Scr.	Fr.
WR	104	66	588	99	2.95	1047	97	37	4.5
YR	95								
Wean Pct.	62%								
Cow Eff.	130								

★★★★★ for Low Maintenance, High Cow Efficiency, Calving Ease, Stayability.



253 **BECKTON NEBULA X625 N3**
1-A 100% # 1382983 Tattoo: BSF0 X625

Birth: 4-6-10
 Beckton Nebula M045
BECKTON NEBULA T269 E2
 Ref. N-8
 Beckton Ruth M967 EP
 Beckton Nebula E P084
BECKTON CHRISTY S151 NB
 Beckton Christy P333 CH
 Beckton Neptune R2 K065
 Beckton Belga K285 JL
 Beckton Epic KN H110
 Beckton Ruth A905 SG
 Beckton Nebula M045
 BKT Pine Marie M119 EP
 Beckton Champ R1 H024
 Beckton Christy K209 CO

DAM		Calv.Ease	BW	WW	YW	Milk	HPG	Stay	Maint.En.
Age	4	17	-5.5	13	33	20	9	15	-8.8
Wt	970	Marb +0.23		REA +0.08		Bfat +0.05			
Prog.BW	62	BWt	WWt	WR	ADG	YWt	YR	Scr.	Fr.
WR	100	60	553	92	3.62	1032	93	37	4.5
YR	98								
Wean Pct.	55%								
Cow Eff.	116								

★★★★★ for Low Maintenance, Marbling, Calving Ease, Stayability.

255 **BSF JANUS X766 C2**
1-B 99% # 1383041 Tattoo: BSF0 X766

Birth: 4-22-10
 TR Romeo NT379
BECKTON ROMAN J S158
 Ref. O-1
 Beckton Belga K285 JL
 BKT Clifftop TP R288
BSF JEWEL T099 CT
 BSF Jewel R119 LS
 Buffalo Creek Romeo L081
 Buf Crk Lass L420
 Beckton Julian GG B571
 Beckton Belga G493 HR
 Beckton Clifftop T C075
 Beckton Christy K209 CO
 Beckton Laser N602
 BSF Jewel N155 JO

DAM		Calv.Ease	BW	WW	YW	Milk	HPG	Stay	Maint.En.
Age	3	15	-3.3	30	56	17	7	14	-3.6
Wt	915	Marb -0.06		REA +0.35		Bfat -0.02			
Prog.BW	59	BWt	WWt	WR	ADG	YWt	YR	Scr.	Fr.
WR	102	54	583	102	3.33	1037	98	37	5.0
YR	98								
Wean Pct.	59%								
Cow Eff.	125								

★★★★★ for Low Maintenance, Rib-eye area, High Cow Efficiency, Calving Ease, Stayability.

• Bulls •

256 BECKTON DOMINOR X738 N5
1-A 100% # 1382779 Tattoo: BKT0 X738

Birth: 4-18-10

Beckton Dominor ZC M919
BECKTON DOMINOR Z1 R610
 Ref. D-1
 Beckton Sierra K557 LO
 Beckton Dominor Z E401
 Beckton Barmaid J012 CO
 Beckton Loki F251
 Beckton Sierra C157 CL
 Beckton Neptune R2 K065
 Beckton Belga K285 JL
 Beckton Warrior T C371
 Beckton Rose D741 LN

BECKTON ROSE R796 NB

DAM
 Age 5
 Wt 1005
 Prog. BW 61
 WR 99
 YR 98
 Wean Pct. 58%
 Cow Eff. 122

Calv. Ease	BW	WW	YW	Milk	HPG	Stay	Maint. En.
17	-5.9	20	47	18	7	14	-1.1
Marb +.22		REA +.04		Bfat +.04			
BWt	WWt	WR	ADG	YWt	YR	Scr.	Fr.
66	584	98	3.38	1031	95	35	4.5

★★★★★ for Low Maintenance, Marbling, High Cow Efficiency, Calving Ease, Stayability.



257 BECKTON DOMINOR X801 J5
1-A 100% # 1383293 Tattoo: BKT0 X801

Birth: 4-30-10

Beckton Dominor ZC M919
BECKTON DOMINOR Z1 R610
 Ref. D-1
 Beckton Sierra K557 LO
 Beckton Justice CH M056
BECKTON LARKABA T813 JC
 Beckton Larkaba P645 JL
 Beckton Dominor Z E401
 Beckton Barmaid J012 CO
 Beckton Loki F251
 Beckton Sierra C157 CL
 Beckton Justice C K449
 Beckton Ruth K802 HD
 Beckton Julian GG B571
 Beckton Larkaba L312 LN

DAM

Age 3
 Wt 890
 Prog. BW 63
 WR 103
 YR 106
 Wean Pct. 56%
 Cow Eff. 118

Calv. Ease	BW	WW	YW	Milk	HPG	Stay	Maint. En.
17	-5.2	21	54	18	9	16	-1.8
Marb +.36		REA +.11		Bfat +.03			
BWt	WWt	WR	ADG	YWt	YR	Scr.	Fr.
61	537	94	3.76	1034	98	33	5.0

★★★★★ for Low Maintenance, Marbling, High Cow Efficiency, Calving Ease, Stayability.

259 BSF HASTEN X444 H4
1-B 99% # 1383078 Tattoo: BSF0 X444

Birth: 3-26-10

Beckton Hasten H S462
BECKTON HASTEN U108 J3
 Ref. H-5
 Beckton Encino S456 JC
 Beckton Hasten H S462
BSF EPIQUETTE U084 HS
 BSF Epiquette S488 EP
 Beckton Hasten P292
 Beckton Lakme G128 HD
 Beckton Justice G302
 Beckton Encino J431 DM
 Beckton Hasten P292
 Beckton Lakme G128 HD
 Beckton Epic K3 M606
 BSF Regus M133 CH

DAM

Age 2
 Wt 802
 Prog. BW 60
 WR 99
 YR 97
 Wean Pct. 58%
 Cow Eff. 122

Calv. Ease	BW	WW	YW	Milk	HPG	Stay	Maint. En.
15	-5.5	20	46	17	9	13	-1.9
Marb -.09		REA -.06		Bfat +.01			
BWt	WWt	WR	ADG	YWt	YR	Scr.	Fr.
60	525	99	3.62	982	97	32	5.0

★★★★★ for Low Maintenance, High Cow Efficiency, Calving Ease, Stayability.

258 BECKTON ACCENT X624 A3
1-A 100% # 1383394 Tattoo: BKT0 X624

Birth: 4-6-10

Beckton Cody K1 P014
BECKTON ACCENT U777 C2
 Ref. A-1
 Beckton Susan R022 CQ
 Beckton Cody K1 P014
BECKTON LANA U612 CD
 Beckton Lana R327 EP
 Beckton Cody KH M390
 Beckton Rose M126 WR
 Beckton Cherokee N N479
 Beckton Susan N023 JE
 Beckton Cody KH M390
 Beckton Rose M126 WR
 Beckton Epic KM M115
 Beckton Lana K840 LN

DAM

Age 2
 Wt 746
 Prog. BW 56
 WR 107
 YR 101
 Wean Pct. 64%
 Cow Eff. 135

Calv. Ease	BW	WW	YW	Milk	HPG	Stay	Maint. En.
12	-3.0	27	54	25	10	16	1.9
Marb +.02		REA +.21		Bfat +.03			
BWt	WWt	WR	ADG	YWt	YR	Scr.	Fr.
56	536	107	3.43	988	101	38	4.5

★★★★★ for Low Maintenance, Rib-eye area, High Cow Efficiency, Calving Ease, Stayability.

260 BECKTON CLIFFTOP X525 E4
1-A 100% # 1383355 Tattoo: BKT0 X525

Birth: 3-30-10

BKT Clifftop TP R288
BECKTON CLIFFTOP U575 H3
 Ref. C-2
 Beckton Larkabel N769 HR
 Beckton Epic KJ J722
BECKTON COCA U387 EP
 Beckton Coca N459 NP
 Beckton Clifftop T C075
 Beckton Christy K209 CO
 Beckton Herald FJ J776
 Bkt Larkabel F246 CT
 Beckton Epic K F075
 Beckton Lana F891 JL
 Beckton Neptune R2 K065
 Beckton Coca HA28 WR

DAM

Age 2
 Wt 792
 Prog. BW 59
 WR 99
 YR 98
 Wean Pct. 59%
 Cow Eff. 124

Calv. Ease	BW	WW	YW	Milk	HPG	Stay	Maint. En.
13	-3.7	14	37	19	11	13	-5.1
Marb +.19		REA +.30		Bfat +.03			
BWt	WWt	WR	ADG	YWt	YR	Scr.	Fr.
59	525	99	3.19	985	98	33	4.5

★★★★★ for Low Maintenance, Marbling, Rib-eye area, High Cow Efficiency, Calving Ease, Stayability.

The Yearling Heifers

The Beckton cowherd is a complete package of genetics for today's industry - moderately sized, efficient producers. They combine calving ease, growth, and desirable carcass traits. They are feminine, maternal and quiet, with nice udders. All of our heifer calves trailed up with their mothers into the Bighorn Mountains to spend their first summer. They have learned the meaning of mothering ability. And they have the productive ability to produce bulls of this quality for our sale. We have included heifers from the very top of our replacements.

We are also pleased to have a nice set of heifers from Tongue River Red Angus. These heifers are selected

with a similar philosophy, and carry a large influence of Beckton breeding. Both the Tongue River and the Beckton heifers have received a vaccination for leptovibrio this spring, but have not had MGA or other additives to suppress heat and influence gains. They have been through a complete breeding soundness exam, and are cycling and ready to breed.

We can keep any sale heifers and breed them in natural service to the same herd sires we use with our own heifers. There will be a charge of \$250 per heifer plus delivery at cost in the fall. Visit with Cam or Forest.



Special Offer

Beckton is offering 2 straws of semen from any Beckton sire (for which we have adequate supply) to go with each Beckton heifer purchased. Tongue River likewise is offering two straws of any Tongue River sire, for each Tongue River heifer purchased. We can still offer semen on Nebula P707, but Julian B571 and LT151 are not available. The buyer will only be responsible for shipping costs from Billings, Mt. The buyer may use the semen on any animal he or she chooses.

• Heifers •

301 **BECKTON COCA X221 N**
1-A 100% # 1382778 Tattoo: BKT0 X221

Birth: 3-15-10

Beckton Neptune R2 K065
Beckton Neptune RR B284
Beckton Lana C735 TP

BECKTON NEBULA M045
Ref. N-1
Beckton Belga K285 JL
Beckton Julian GG B571
Beckton Belga G493 HR

Beckton Cody KH M390
Beckton Cody K G701
Beckton Tamara J124 HR

BECKTON COCA R765 CD
Beckton Coca M175 LN
Beckton Lancer F442 T
Beckton Coca K295 CO

DAM		Calv.Ease	BW	WW	YW	Milk	HPG	Stay	Maint.En.
Age	5	15	-3.6	32	66	14	9	12	-3.6
Wt	1050								
Prog.BW	59								
WR	105								
YR	105								
Cow Eff.	111								

Marb	REA	Bfat	BWt	WR	YR	Fr.
+0.17	-0.15	+0.03	76	110	113	med

★★★★★ for Low Maintenance, Growth, Marbling, Superior Cow, Calving Ease.

303 **BECKTON LARKEISA X119 L**
1-A 100% # 1382711 Tattoo: BKT0 X119

Birth: 3-4-10

Beckton Lancer F442 T
Beckton Lancer T A664
Bkt Suffeina A828 DM

BECKTON LANCER T371 H4
Ref. L-4
Beckton Coca F276 HV
Leachman Heavenly 8141
Beckton Coca B112 CB

Beckton Neptune R2 K065
Beckton Neptune RR B284
Beckton Lana C735 TP

BECKTON LARKEISA P136 NP
Bkt Larkeisa G448 CT
Beckton Clifftop T C075
Bkt Larkeisa C894 JV

DAM		Calv.Ease	BW	WW	YW	Milk	HPG	Stay	Maint.En.
Age	6	11	-2.0	34	59	17	9	13	-1.5
Wt	1125								
Prog.BW	75								
WR	114								
YR	111								
Cow Eff.	103								

Marb	REA	Bfat	BWt	WR	YR	Fr.
+0.01	+0.07	-0.01	76	110	106	med

★★★★★ for Low Maintenance, Superior Cow, Calving Ease, Stayability.



304 **BECKTON VERNICE X117 H**
1-A 100% # 1382760 Tattoo: BKT0 X117

Birth: 3-3-10

Beckton Heritage N013
Beckton Lana L007 JL

BECKTON HERITAGE T270 J2
Ref. H-4
Beckton Coca P602 JL
Beckton Julian GG B571
Beckton Coca J270 CD

Beckton Epic K3 M606
Beckton Epic KJ J722
Beckton Lana F268 CT

BECKTON VERNICE R416 EP
Beckton Vernice K482 HD
Beckton Hadrian F C486
Beckton Vernice F513 CL

DAM		Calv.Ease	BW	WW	YW	Milk	HPG	Stay	Maint.En.
Age	5	13	-2.9	34	59	12	10	14	-0.6
Wt	1145								
Prog.BW	67								
WR	104								
YR	105								
Cow Eff.	98								

Marb	REA	Bfat	BWt	WR	YR	Fr.
+0.18	+0.07	+0.04	73	106	105	med

★★★★★ for Low Maintenance, Marbling, Superior Cow, Calving Ease, Stayability.

302 **BECKTON INDIGO X211 L**
1-A 100% # 1382883 Tattoo: BSF0 X211

Birth: 3-15-10

Beckton Lancer F442 T
Beckton Lancer T A664
Bkt Suffeina A828 DM

BECKTON LANCER T371 H4
Ref. L-4
Beckton Coca F276 HV
Leachman Heavenly 8141
Beckton Coca B112 CB

Beckton Loki F251
Beckton Lancer TZ D525
Bkt Pine Marie D126 JL

BECKTON INDIGO N467 LO
Beckton Indigo H150 LN
Beckton Lancer TE F363
Beckton Indigo F376 CT

DAM		Calv.Ease	BW	WW	YW	Milk	HPG	Stay	Maint.En.
Age	7	9	-0.4	36	72	12	3	16	0.5
Wt	1125								
Prog.BW	77								
WR	106								
YR	110								
Cow Eff.	101								

Marb	REA	Bfat	BWt	WR	YR	Fr.
+0.23	+0.15	+0.01	82	108	113	med

★★★★★ for Low Maintenance, Growth, Marbling, Rib-eye area, Superior Cow, Calving Ease, Stayability.

305 **BECKTON BELGA X392 D**
1-A 100% # 1382651 Tattoo: BKT0 X392

Birth: 3-23-10

Beckton Dominor ZC M919
Beckton Dominor Z E401
Beckton Barmaid J012 CO

BECKTON DOMINOR Z1 R610
Ref. D-1
Beckton Sierra K557 LO
Beckton Loki F251
Beckton Sierra C157 CL

Beckton Julian GG B571
Beckton Julian 7526G
Bkt Marta 9A13 JL

BECKTON BELGA K285 JL
Beckton Belga G493 HR
Beckton Herald K B244
Beckton Belga D776 CL

DAM		Calv.Ease	BW	WW	YW	Milk	HPG	Stay	Maint.En.
Age	10	16	-3.6	29	61	17	7	16	0.9
Wt	900								
Prog.BW	67								
WR	101								
YR	100								
Cow Eff.	117								

Marb	REA	Bfat	BWt	WR	YR	Fr.
+0.19	+0.16	+0.06	72	100	103	med

★★★★★ for Low Maintenance, Marbling, Rib-eye area, Calving Ease, Stayability.

• Heifers •

306 **BECKTON LANA X348 N**
1-A 100% # 1382913 Tattoo: BSF0 X348

Birth: 3-21-10

Beckton Nebula J R475
Beckton Nebula M045
Beckton Larkeisa M138 JC

BECKTON NEBULA T054 H3
Ref. N-7
BKT Pine Marie R401 HU
Beckton Hustler C2 L079
Bkt Pine Marie LC30 CD

Beckton Lancer T5 L095
Beckton Lancer F442 T
Beckton Belga J293 HR

BECKTON LANA P520 LN
Beckton Lana L827 WR
Beckton Warrior T C371
Beckton Lana F028 VG

DAM	
Age	6
Wt	940
Prog. BW	78
WR	105
YR	104
Cow Eff.	121

Calv. Ease	BW	WW	YW	Milk	HPG	Stay	Maint. En.
8	0.1	33	70	11	10	13	-1.1
Marb	REA	Bfat	BWt	WR	YR	Fr.	
+0.14	+0.30	-0.02	89	108	115	med	

★★★★★ for Low Maintenance, Growth, Marbling, Rib-eye area, Superior Cow, Calving Ease, Stayability.

309 **BECKTON LANA X138 E**
1-2 100% # 1382899 Tattoo: BSF0 X138

Birth: 3-7-10

Beckton Epic KM M115
Beckton Epic K F075
Beckton Minerva F495 CH

BECKTON EPIC K6 S569
Ref. E-2
Beckton Sierra N703 LM
Beckton Laramie L044
Beckton Sierra L887 LN

Beckton Justice CH M056
Beckton Justice C K449
Beckton Ruth K802 HD

BECKTON LANA P159 JC
Beckton Lana M199 JV
Bkt Javelin 7466 R
Beckton Lana K346 CO

DAM	
Age	6
Wt	850
Prog. BW	60
WR	101
YR	99
Cow Eff.	131

Calv. Ease	BW	WW	YW	Milk	HPG	Stay	Maint. En.
13	-4.1	24	55	24	11	14	-4.0
Marb	REA	Bfat	BWt	WR	YR	Fr.	
+0.29	-0.06	+0.03	69	105	103	med	

★★★★★ for Low Maintenance, Marbling, Calving Ease, Stayability.

307 **BECKTON LANA X141 J**
1-A 100% # 1382884 Tattoo: BSF0 X141

Birth: 3-8-10

Beckton Julian GJ P535
Beckton Julian 7526G
Beckton Mona D086 JL

BECKTON JULIAN G5 S107
Ref. J-4
Beckton Minola P826 DM
Beckton Dominor ZC M919
Beckton Minola M641 WR

Beckton Warrior T1 H281
Beckton Warrior TC E801
Beckton Minerva B609 RN

BECKTON LANA N473 WR
Beckton Lana K237 EP
Beckton Epic D404
Beckton Lana CB29 JL

DAM	
Age	7
Wt	1125
Prog. BW	72
WR	103
YR	107
Cow Eff.	101

Calv. Ease	BW	WW	YW	Milk	HPG	Stay	Maint. En.
11	-1.5	31	67	10	14	16	-1.5
Marb	REA	Bfat	BWt	WR	YR	Fr.	
+0.17	-0.01	+0.06	71	107	105	med	

★★★★★ for Low Maintenance, Growth, Marbling, Calving Ease, Stayability.

310 **BECKTON SIERRA X177 N**
1-A 99% # 1382881 Tattoo: BSF0 X177

Birth: 3-12-10

Beckton Nebula M045
Beckton Neptune R2 K065
Beckton Belga K285 JL

BECKTON NEBULA T269 E2
Ref. N-8
Beckton Ruth M967 EP
Beckton Epic KN H110
Beckton Ruth A905 SG

Beckton Laramie L044
Beckton Lancer T4 J536
Beckton Sierra J659 DM

BECKTON SIERRA N389 LM
Beckton Sierra L681 HR
Beckton Herald FV J537
Beckton Sierra J330 LN

DAM	
Age	7
Wt	1055
Prog. BW	64
WR	104
YR	104
Cow Eff.	99

Calv. Ease	BW	WW	YW	Milk	HPG	Stay	Maint. En.
11	-1.6	30	64	19	10	14	0.5
Marb	REA	Bfat	BWt	WR	YR	Fr.	
+0.06	+0.05	+0.03	78	98	105	med	

★★★★★ for Low Maintenance, Superior Cow, Calving Ease, Stayability.

308 **BECKTON ROSE X790 J**
1-A 100% # 1382766 Tattoo: BKT0 X790

Birth: 4-27-10

TR Romeo NT379
Buffalo Creek Romeo L081
Buf Crk Lass L420

BECKTON ROMAN J S158
Ref. O-1
Beckton Belga K285 JL
Beckton Julian GG B571
Beckton Belga G493 HR

Beckton Clifftop T3 N800
Bkt Clifftop TV G672
Beckton Lana J384 CD

BECKTON ROSE R507 CT
Beckton Rose N125 LN
Beckton Lancer T5 L095
Beckton Rose L311 LN

DAM	
Age	5
Wt	940
Prog. BW	76
WR	103
YR	105
Cow Eff.	112

Calv. Ease	BW	WW	YW	Milk	HPG	Stay	Maint. En.
7	0.7	40	72	16	5	12	3.5
Marb	REA	Bfat	BWt	WR	YR	Fr.	
+0.10	+0.35	-0.02	87	106	117	med	

★★★★★ for Low Maintenance, Growth, Rib-eye area, Superior Cow, Calving Ease.



• Heifers •

311 **TR DUCHESS XT092**
1-A 100% # 1369847 Tattoo: TR2A0 XT09

Birth: 2-7-10

Bfck Cherokee Cnyn 4912 < Buf Crk Chf 824-1658
MRM 1431 8611 9109

TR RICARDO RT574
Ref. C-3 < TR Dyna LT111 < Beckton Julian GG B571
BSF Dyna JT976

TR Epic ST618 < Beckton Epic K F075
Beckton Kit F468 JL

TJS DUCHESS U887
TJS Duchess R568 < Bfck Cherokee Cnyn 4912
TJS Duchess N370

DAM		Calv.Ease	BW	WW	YW	Milk	HPG	Stay	Maint.En.
Age	2	12	-2.0	40	63	15	11	16	-5.4
Wt	1160								
Prog.BW	72								
WR	NA								
YR	NA								
Cow Eff.	NA								

Marb **+0.18** REA **+0.36** Bfat **+0.03** BWt **72** WR **99** YR **103** Fr. **sma**

★★★★★ for Low Maintenance, Marbling, Rib-eye area, Calving Ease, Stayability.

313 **TR ANGEL XT067**
1-A 100% # 1369859 Tattoo: TR2A0 XT06

Birth: 3-31-10

Beckton Julian GG B571 < BKT Julian 7526 G
BKT Marta 9A13 JL

TR JULIAN ST630
Ref. J-9 < MS GeometriC 003 < BJR Make My Day 981
MS Geometric 277

MR R2 Mountain Man 570N < Glacier Mountaineer 160
Buf Crk Carrie 5705

R2 ANASCO 092R
Buf Crk Anasco M092 < Buf Crk Dynaband 5612
Buf Crk Anasco 5843

DAM		Calv.Ease	BW	WW	YW	Milk	HPG	Stay	Maint.En.
Age	5	13	-1.8	30	55	13	12	13	2.9
Wt	1285								
Prog.BW	74								
WR	NA								
YR	NA								
Cow Eff.	NA								

Marb **+0.06** REA **-0.05** Bfat **+0.00** BWt **81** WR **112** YR **110** Fr. **med**

★★★★★ for Low Maintenance, Calving Ease, Stayability.

312 **TR BRANDY XT057**
1-A 100% # 1369786 Tattoo: TR2A0 XT05

Birth: 2-22-10

Beckton Epic K F075 < Beckton Epic D404
Beckton Belga D483 KR

TR EPIC ST618
Ref. E-9 < Beckton Kit F468 JL < Beckton Julian GG B571
Beckton Kit A517 NP

Beckton Neptune RR B284 < Bkt Neptune 8460 R
Beckton Eola 8600 RR

BECKTON INDIGO L349 NP
Beckton Indigo HA01 CS < Beckton Caesar M D023
Beckton Indigo E370 RN

DAM		Calv.Ease	BW	WW	YW	Milk	HPG	Stay	Maint.En.
Age	9	10	-0.7	29	47	17	10	11	-6.9
Wt	1300								
Prog.BW	81								
WR	NA								
YR	NA								
Cow Eff.	NA								

Marb **-0.05** REA **+0.07** Bfat **-0.01** BWt **85** WR **114** YR **108** Fr. **sma**

★★★★★ for Low Maintenance, Calving Ease.

314 **TR WILLOW XT073**
1-A 100% # 1369813 Tattoo: TR2A0 XT07

Birth: 2-6-10

Bfck Cherokee Cnyn 4912 < Buf Crk Chf 824-1658
MRM 1431 8611 9109

TR RICARDO RT574
Ref. C-3 < TR Dyna LT111 < Beckton Julian GG B571
BSF Dyna JT976

Beckton Cody V E023 < Beckton Cody C401
Beckton Birdie C353 VG

TR WILLOW RT519
Buckeye Yvonne K97 < DMW Mmday H17
Buckeye Pearl

DAM		Calv.Ease	BW	WW	YW	Milk	HPG	Stay	Maint.En.
Age	5	13	-3.3	23	39	15	12	11	1.7
Wt	1475								
Prog.BW	71								
WR	NA								
YR	NA								
Cow Eff.	NA								

Marb **+0.11** REA **+0.23** Bfat **+0.01** BWt **74** WR **101** YR **97** Fr. **med**

★★★★★ for Low Maintenance, Marbling, Rib-eye area, Calving Ease.



315 **TR LIDDY XT085**
1-A 100% # 1369831 Tattoo: TR2A0 XT08

Birth: 3-6-10

Bfck Cherokee Cnyn 4912 < Buf Crk Chf 824-1658
MRM 1431 8611 9109

TR RICARDO RT574
Ref. C-3 < TR Dyna LT111 < Beckton Julian GG B571
BSF Dyna JT976

Beckton Julian G4 P627 < Beckton Julian GG B571
Beckton Kuruba LC61 CD

BSF CRUSITA T752 JL
BSF Crusita P634 < Beckton Cruiser K118
BSF Regus L314 WR

DAM		Calv.Ease	BW	WW	YW	Milk	HPG	Stay	Maint.En.
Age	3	12	-3.6	39	62	16	11	13	5.4
Wt	1410								
Prog.BW	65								
WR	NA								
YR	NA								
Cow Eff.	NA								

Marb **+0.22** REA **+0.16** Bfat **+0.02** BWt **66** WR **105** YR **104** Fr. **med**

★★★★★ for Marbling, Rib-eye area, Calving Ease, Stayability.

• Heifers •

316 **TR WILLOW XT090**
1-A 100% # 1369841 Tattoo: TR2A0 XT09

Birth: 2-21-10

Beckton Julian GG B571
BKT Julian 7526 G
BKT Marta 9A13 JL

TR JULIAN ST630
Ref. J-9 MS GeometriC 003
BJR Make My Day 981
MS Geometric 277

Beckton Nebula M045
Beckton Neptune R2 K065
Beckton Belga K285 JL

TR CARRIE TT735
TR Carrie RT524
TR Julian LT151
Buf Crk Carrie L349

DAM	
Age	3
Wt	1130
Prog.BW	62
WR	NA
YR	NA
Cow Eff.	NA

Calv.Ease	BW	WW	YW	Milk	HPG	Stay	Maint.En.
19	-5.3	23	56	14	11	14	2.9
Marb	REA	Bfat	BWt	WR	YR	Fr.	
+1.0	-.03	+0.2	67	104	114	lar	

★★★★★ for Low Maintenance, Calving Ease, Stayability.

319 **TR BRITTNEY XT062**
1-A 100% # 1369797 Tattoo: TR2A0 XT06

Birth: 2-14-10

Bfck Cherokee Cnyn 4912
Buf Crk Chf 824-1658
MRM 1431 8611 9109

TR RICARDO RT574
Ref. C-3 TR Dyna LT111
Beckton Julian GG B571
BSF Dyna JT976

Buf Crk Hobo 1961
Buf Cr Carrie VC1174

TR BRITTNEY NT316
Beckton Lana E828 SC
Beckton Scamp 8954
Beckton Lana B695 SG

DAM	
Age	7
Wt	1460
Prog.BW	74
WR	NA
YR	NA
Cow Eff.	NA

Calv.Ease	BW	WW	YW	Milk	HPG	Stay	Maint.En.
16	-4.9	21	39	20	11	14	-4.4
Marb	REA	Bfat	BWt	WR	YR	Fr.	
+0.0	+1.8	+0.1	68	102	102	lar	

★★★★★ for Low Maintenance, Rib-eye area, Calving Ease, Stayability.

317 **TR LYDIA XT077**
1-A 100% # 1369817 Tattoo: TR2A0 XT07

Birth: 3-16-10

Beckton Nebula M045
Beckton Neptune R2 K065
Beckton Belga K285 JL

TR NEBULA TT779
Ref. N-13 TR Lydia MT244
Beckton Lancer F134 TS
Beckton Lydia E251 CL

Mushrush LT N020
TR Julian LT142
Mushrush Lana 1061

TR LYDIA RT536
TR Lydia MT244
Beckton Lancer F134 TS
Beckton Lydia E251 CL

DAM	
Age	5
Wt	1595
Prog.BW	84
WR	NA
YR	NA
Cow Eff.	NA

Calv.Ease	BW	WW	YW	Milk	HPG	Stay	Maint.En.
9	0.9	48	88	14	11	14	-2.1
Marb	REA	Bfat	BWt	WR	YR	Fr.	
+0.6	-.13	-.01	97	127	124	lar	

★★★★★ for Low Maintenance, Growth, Calving Ease, Stayability.



318 **TR CEDAR XT096**
1-A 100% # 1369856 Tattoo: TR2A0 XT09

Birth: 3-3-10

Beckton Nebula M045
Beckton Neptune R2 K065
Beckton Belga K285 JL

TR NEBULA TT779
Ref. N-13 TR Lydia MT244
Beckton Lancer F134 TS
Beckton Lydia E251 CL

TR RICARDO RT574
Bfck Cherokee Cnyn 4912
TR Dyna LT111

TR CEDAR UT891
TR CEDAR ST684
TR Julian LT142
TR Cedar PT455

DAM	
Age	2
Wt	1055
Prog.BW	83
WR	NA
YR	NA
Cow Eff.	NA

Calv.Ease	BW	WW	YW	Milk	HPG	Stay	Maint.En.
13	-1.3	47	78	13	12	16	-4.4
Marb	REA	Bfat	BWt	WR	YR	Fr.	
+0.37	+0.07	+0.01	83	108	110	lar	

★★★★★ for Low Maintenance, Growth, Marbling, Calving Ease, Stayability.

320 **TR CEDAR XT094**
1-A 100% # 1370569 Tattoo: TR2A0 XT09

Birth: 3-2-10

Beckton Nebula M045
Beckton Neptune R2 K065
Beckton Belga K285 JL

TR NEBULA TT779
Ref. N-13 TR Lydia MT244
Beckton Lancer F134 TS
Beckton Lydia E251 CL

TR Ricardo RT574
Bfck Cherokee Cnyn 4912
TR Dyna LT111

TR CEDAR UT878
TR Cedar RT514
TR Julian LT151
MS Geometric 004

DAM	
Age	2
Wt	920
Prog.BW	80
WR	NA
YR	NA
Cow Eff.	NA

Calv.Ease	BW	WW	YW	Milk	HPG	Stay	Maint.En.
14	-1.7	41	61	13	11	15	-0.5
Marb	REA	Bfat	BWt	WR	YR	Fr.	
+0.20	-.04	+0.02	80	110	102	lar	

★★★★★ for Low Maintenance, Marbling, Calving Ease, Stayability.

• Heifers •

321 **BECKTON SIERRA X708 N**
1-A 100% # 1382646 Tattoo: BKT0 X708

Birth: 4-14-10
 Beckton Nebula P P707
BECKTON NEBULA PJ S543
 Ref. N-6 Beckton Lana P685 JO
 Beckton Nebula M045
 Beckton Lana M809 EP
 Beckton Julio L233
 Beckton Lana E083 CD
 Beckton Saga KJ B702
 Beckton Kuruba B508 PC
 Beckton Epic D404
BECKTON SIERRA J789 EP
 Beckton Sierra C157 CL
 Beckton Clipper JL A095
 Beckton Sierra A086 CL

DAM		Calv.Ease	BW	WW	YW	Milk	HPG	Stay	Maint.En.
Age	11	10	-1.2	42	89	9	4	13	-0.3
Wt	1175	Marb	+0.32	REA	+0.11	Bfat	+0.02	BWt	81
Prog.BW	80	WR	102	YR	104	Fr.	117	med	
Cow Eff.	94								

★★★★★ for Low Maintenance, Growth, Marbling, Calving Ease, Stayability.

324 **BECKTON LANA X322 D**
1-A 100% # 1382704 Tattoo: BKT0 X322

Birth: 3-20-10
 Beckton Dominor ZC M919
BECKTON DOMINOR Z1 R610
 Ref. D-1 Beckton Sierra K557 LO
 Beckton Dominor Z E401
 Beckton Barmaid J012 CO
 Beckton Loki F251
 Beckton Sierra C157 CL
 Beckton Julian GG B571
 Beckton Annie F743 LN
 Beckton Julian G1 J526
BECKTON LANA N664 JL
 Beckton Lana H533 LN
 Beckton Lana D466 NM

DAM		Calv.Ease	BW	WW	YW	Milk	HPG	Stay	Maint.En.
Age	7	14	-3.6	31	57	16	6	16	-0.8
Wt	1035	Marb	+0.14	REA	+0.06	Bfat	+0.04	BWt	73
Prog.BW	71	WR	108	YR	102	Fr.	107	104	med
Cow Eff.	109								

★★★★★ for Low Maintenance, Marbling, Calving Ease, Stayability.

322 **BECKTON LARKABA X086 N**
1-A 100% # 1383371 Tattoo: BKT0 X086

Birth: 2-26-10
 Beckton Nebula G S237
BECKTON NEBULA U031 D3
 Ref. N-10 Beckton Marta S459 DM
 Beckton Nebula M045
 Beckton Lakme LA06 JL
 Beckton Dominor ZC M919
 Beckton Marta G675 LN
 Beckton Epic R350 K
BECKTON LARKABA U498 EP
 Beckton Larkaba R336 CK
 Beckton Epic K F075
 Beckton Larkaba E042 CD
 Beckton Colt K M609
 Beckton Larkaba J649 CR

DAM		Calv.Ease	BW	WW	YW	Milk	HPG	Stay	Maint.En.
Age	2	9	0.1	39	82	14	7	16	-0.4
Wt	820	Marb	+0.20	REA	-0.08	Bfat	+0.00	BWt	78
Prog.BW	78	WR	118	YR	116	Fr.	118	116	med
Cow Eff.	114								

★★★★★ for Low Maintenance, Growth, Marbling, Superior Cow, Calving Ease, Stayability.

325 **BECKTON ROSE X413 J**
1-A 100% # 1382743 Tattoo: BKT0 X413

Birth: 3-24-10
 TR Romeo NT379
BECKTON ROMAN J S158
 Ref. O-1 Beckton Belga K285 JL
 Buffalo Creek Romeo L081
 Buf Crk Lass L420
 Beckton Julian GG B571
 Beckton Belga G493 HR
 Beckton Laser N602
BECKTON ROSE R152 LS
 Beckton Rose N607 CO
 Beckton Lancer F442 T
 Beckton Minola E589 TO
 Beckton Copper JT G095
 Beckton Rose J725 EP

DAM		Calv.Ease	BW	WW	YW	Milk	HPG	Stay	Maint.En.
Age	5	10	-0.2	36	71	17	7	14	-0.3
Wt	880	Marb	+0.07	REA	+0.23	Bfat	-0.03	BWt	71
Prog.BW	73	WR	103	YR	108	Fr.	104	108	med
Cow Eff.	125								

★★★★★ for Low Maintenance, Growth, Rib-eye area, Calving Ease, Stayability.

323 **BECKTON EOLA X264 H**
1-A 100% # 1382694 Tattoo: BKT0 X264

Birth: 3-17-10
 Beckton Heritage N013
BECKTON HERITAGE T270 J2
 Ref. H-4 Beckton Coca P602 JL
 Beckton Hustler C2 L079
 Beckton Lana L007 JL
 Beckton Julian GG B571
 Beckton Coca J270 CD
 Beckton Warrior TD L493
BECKTON EOLA N072 WR
 Beckton Eola L544 WR
 Beckton Warrior T C371
 Bkt Suffeina A828 DM
 Beckton Warrior T2 J333
 Beckton Eola J239 CH

DAM		Calv.Ease	BW	WW	YW	Milk	HPG	Stay	Maint.En.
Age	7	10	-0.1	42	73	10	10	15	2.2
Wt	1115	Marb	+0.30	REA	-0.03	Bfat	+0.03	BWt	79
Prog.BW	73	WR	104	YR	104	Fr.	109	104	med
Cow Eff.	103								

★★★★★ for Low Maintenance, Marbling, Superior Cow, Calving Ease, Stayability.



• Heifers •

326 BECKTON SIERRA X273 J
1-A 100% # 1382707 Tattoo: BKT0 X273

Birth: 3-17-10

TR Julian LT151
 Beckton Julian GG B571
 MS Geometric 917

BECKTON JET L P491
Ref. J
 Beckton Minerva L278 LN
 Beckton Lancer TS D390
 Beckton Minerva F495 CH

Beckton Lancer T6 M467
 Beckton Lancer TL G626
 Beckton Lana C735 TP

BECKTON SIERRA P027 LN
 Beckton Lancer TH K417
 Beckton Sierra M258 LN
 Beckton Sierra K672 EP

DAM	
Age	6
Wt	NA
Prog. BW	81
WR	115
YR	108
Cow Eff.	NA

Calv. Ease	BW	WW	YW	Milk	HPG	Stay	Maint. En.
11	-2.0	26	54	24	7	13	1.5
Marb	REA	Bfat	Bwt		WR	YR	Fr.
+.29	+.02	+.01	79	110	105	med	

★★★★★ for Low Maintenance, Marbling, Superior Cow, Calving Ease, Stayability.

329 BECKTON BAYBERRY X325 J
1-A 100% # 1382942 Tattoo: BSF0 X325

Birth: 3-20-10

Beckton Julian G1 J526
 Beckton Julian GG B571
 Beckton Annie F743 LN

BECKTON JULES L429
Ref. J-2
 Beckton Barona J591 EP
 Beckton Epic K F075
 Beckton Barona E134 RN

Beckton Hustler C2 L079
 Beckton Hustler CN J102
 Beckton Barmaid J012 CO

BKT BAYBERRY R322 HU
 Beckton Scamp TR FB22
 Bkt Bayberry LC31 SC
 Bkt Bayberry D736 GL

DAM	
Age	5
Wt	1030
Prog. BW	72
WR	111
YR	107
Cow Eff.	113

Calv. Ease	BW	WW	YW	Milk	HPG	Stay	Maint. En.
13	-3.4	30	51	15	8	14	-3.9
Marb	REA	Bfat	Bwt		WR	YR	Fr.
-.03	+.01	-.01	71	118	106	med	

★★★★★ for Low Maintenance, Superior Cow, Calving Ease, Stayability.

327 BECKTON LARKABEL X407 E
1-A 100% # 1382832 Tattoo: BSF0 X407

Birth: 3-24-10

Beckton Epic K4 N795
 Beckton Sierra J789 EP

BECKTON EPIC T330 L5
Ref. E-3
 Beckton Belga K202 LN
 Beckton Lancer T A664
 Beckton Belga D460 KR

Beckton Epic K F075
 Beckton Epic D404
 Beckton Belga D483 KR

BKT LARKABEL K768 EP
 Bkt Larkabel E645 MB
 Bkt Milebar BX 9822
 Bkt Larkabel 8697 RR

DAM	
Age	10
Wt	1060
Prog. BW	77
WR	112
YR	105
Cow Eff.	108

Calv. Ease	BW	WW	YW	Milk	HPG	Stay	Maint. En.
12	-4.4	24	51	15	9	14	-1.7
Marb	REA	Bfat	Bwt		WR	YR	Fr.
+.23	-.12	+.03	66	116	106	med	

★★★★★ for Low Maintenance, Marbling, Superior Cow, Calving Ease, Stayability.

330 BECKTON LYDIA X274 N
1-A 99% # 1382693 Tattoo: BKT0 X274

Birth: 3-17-10

Beckton Nebula M045
 Beckton Neptune R2 K065
 Beckton Belga K285 JL

BECKTON NEBULA T269 E2
Ref. N-8
 Beckton Ruth M967 EP
 Beckton Epic KN H110
 Beckton Ruth A905 SG

Beckton Laramie L044
 Beckton Lancer T4 J536
 Beckton Sierra J659 DM

BECKTON LYDIA N047 LM
 Beckton Lydia L647 JL
 Beckton Julian J153 G
 Beckton Lydia D559 CF

DAM	
Age	7
Wt	1035
Prog. BW	72
WR	114
YR	108
Cow Eff.	102

Calv. Ease	BW	WW	YW	Milk	HPG	Stay	Maint. En.
10	-0.5	33	63	20	10	15	-3.3
Marb	REA	Bfat	Bwt		WR	YR	Fr.
+.30	+.12	+.05	77	100	99	med	

★★★★★ for Low Maintenance, Marbling, Superior Cow, Calving Ease, Stayability.

328 BECKTON VERNICE X152 N
1-A 100% # 1382665 Tattoo: BKT0 X152

Birth: 3-10-10

Beckton Nebula M045
 Beckton Neptune R2 K065
 Beckton Belga K285 JL

BECKTON NEBULA T269 E2
Ref. N-8
 Beckton Ruth M967 EP
 Beckton Epic KN H110
 Beckton Ruth A905 SG

Beckton Lancer TZ D525
 Beckton Lancer T A664
 Beckton Cherova Z157 ZN

BECKTON VERNICE L382 LN
 Beckton Vernice G373 WR
 Beckton Warrior T C371
 Beckton Vernice D066 NM

DAM	
Age	9
Wt	1120
Prog. BW	72
WR	107
YR	105
Cow Eff.	99

Calv. Ease	BW	WW	YW	Milk	HPG	Stay	Maint. En.
14	-4.3	21	42	18	7	14	-4.8
Marb	REA	Bfat	Bwt		WR	YR	Fr.
+.22	+.08	+.04	65	105	96	med	

★★★★★ for Low Maintenance, Marbling, Superior Cow, Calving Ease, Stayability.

331 BSF JULIA X162 C
1-2 99% # 1382907 Tattoo: BSF0 X162

Birth: 3-11-10

Beckton Cherokee N N479
 BFCK Cherokee Cnyn 4912
 Beckton Dinah C440 NM

BECKTON CHEROKEE T450 L3
Ref. C-1
 Beckton Annie M337 LN
 Beckton Lancer TL G626
 Beckton Annie F743 LN

Beckton Julio L233
 Beckton Julian G1 J526
 Beckton Rose J725 EP

BSF JULIA P361
 BSF Regus J569
 Beckton Cody V E023
 BSF Red F208

DAM	
Age	6
Wt	1125
Prog. BW	73
WR	110
YR	111
Cow Eff.	99

Calv. Ease	BW	WW	YW	Milk	HPG	Stay	Maint. En.
11	-1.9	25	57	20	9	15	-1.3
Marb	REA	Bfat	Bwt		WR	YR	Fr.
+.03	+.06	+.02	76	113	116	med	

★★★★★ for Low Maintenance, Superior Cow, Calving Ease, Stayability.

• Heifers •



334 **BSF EPIQUETTE X385 E**
 1-B 99% # 1382854 Tattoo: BSF0 X385
 Birth: 3-23-10

Beckton Epic KM M115
BECKTON EPIC K6 S569
 Ref. E-2 Beckton Sierra N703 LM

Beckton Epic K F075
BSF REGUS M507 EP
 BSF Red Roan J119

Beckton Epic K F075
 Beckton Minerva F495 CH
 Beckton Laramie L044
 Beckton Sierra L887 LN
 Beckton Epic D404
 Beckton Belga D483 KR
 Beckton Clipper KC D400
 BSF Regus C059

DAM		Calv.Ease	BW	WW	YW	Milk	HPG	Stay	Maint.En.
Age	8	4	1.5	45	86	19	10	15	4.7
Wt	1085	Marb	+0.22	REA	+0.13	Bfat	+0.04	BWt	92
Prog.BW	87	WR		YR		FR		124	113
WR	117								med
YR	113								
Cow Eff.	113								

★★★★★ for Growth, Marbling, Rib-eye area, Superior Cow, Stayability.

332 **BSF HALEY X190 H**
 1-B 99% # 1382858 Tattoo: BSF0 X190
 Birth: 3-13-10

Beckton Hustler CN J102
BECKTON HALFMANNHUSTLER R588
 Ref. H-2 Beckton Vernice F513 CL

Beckton Lancer TL G626
BSF REGUS M604 LN
 BSF Regus J378

Beckton Hustler C G407
 Beckton Belga G355 NP
 Beckton Clipper JM A124
 Beckton Vernice A663 PC
 Beckton Lancer T A664
 Beckton Fayette C110 LN
 Beckton Hadrian F C486
 BSF Regus D019

DAM		Calv.Ease	BW	WW	YW	Milk	HPG	Stay	Maint.En.
Age	8	14	-3.8	32	71	16	12	11	3.6
Wt	1120	Marb	+0.02	REA	-0.04	Bfat	+0.00	BWt	76
Prog.BW	66	WR		YR		FR		114	114
WR	97								lar
YR	103								
Cow Eff.	107								

★★★★★ for Low Maintenance, Growth, Calving Ease.

335 **BSF VIOLET X182 E**
 1-B 99% # 1382874 Tattoo: BSF0 X182
 Birth: 3-12-10

Beckton Epic KJ J722
BECKTON EPIC K4 N795
 Ref. E-1 Beckton Sierra J789 EP

Beckton Vegas S1 K316
BSF VIOLET N276 VG
 BSF Red Roan J119

Beckton Epic K F075
 Beckton Lana F891 JL
 Beckton Epic D404
 Beckton Sierra C157 CL
 Beckton Vegas SV H078
 Beckton Eola H073 EP
 Beckton Clipper KC D400
 BSF Regus C059

DAM		Calv.Ease	BW	WW	YW	Milk	HPG	Stay	Maint.En.
Age	7	11	-1.9	33	68	11	6	10	4.3
Wt	1200	Marb	+0.12	REA	+0.12	Bfat	+0.03	BWt	68
Prog.BW	66	WR		YR		FR		110	107
WR	104								med
YR	99								
Cow Eff.	97								

★★★★★ for Growth, Marbling, Calving Ease.

333 **BSF HELENA X376 H**
 1-B 99% # 1382922 Tattoo: BSF0 X376
 Birth: 3-22-10

Beckton Hasten P292
BECKTON HASTEN H S462
 Ref. H-3 Beckton Lakme G128 HD

Beckton Warhawk N560
BSF HELENA R003 WA
 BSF Helena N151 HU

Beckton Hustler C2 L079
 Beckton Sheba L644 CH
 Beckton Hadrian FC E166
 Beckton Lakme E373 CL
 Beckton Warrior T1 H281
 Beckton Firefly H195 HD
 Beckton Hustler CN J102
 BSF Regus F175

DAM		Calv.Ease	BW	WW	YW	Milk	HPG	Stay	Maint.En.
Age	5	15	-5.4	31	62	19	13	12	2.4
Wt	1030	Marb	+0.04	REA	+0.05	Bfat	+0.03	BWt	66
Prog.BW	71	WR		YR		FR		111	111
WR	112								med
YR	111								
Cow Eff.	114								

★★★★★ for Low Maintenance, Growth, Superior Cow, Calving Ease.



• Heifers •

336 **BSF JUSTICIA X703 J**
1-B 99% # 1382971 Tattoo: BSF0 X703

Birth: 4-14-10

TR Romeo NT379
BECKTON ROMAN J S158
 Ref. O-1
 Beckton Belga K285 JL
 Buffalo Creek Romeo L081
 Buf Crk Lass L420
 Beckton Julian GG B571
 Beckton Belga G493 HR
 Beckton Justice C K449
 Beckton Ruth K802 HD
 Beckton Epic KJ J722
 BSF Regus H012
BSF JUSTICIA R874 JC
 Beckton Justice CH M056
 BSF Regus M411 EP

DAM		Calv.Ease	BW	WW	YW	Milk	HPG	Stay	Maint.En.	BWt	WR	YR	Fr.
Age	5	15	-3.7	33	61	24	6	11	-0.7	58	111	106	med
Wt	935	Marb	+0.16	REA	+0.24	Bfat	-0.03						
Prog.BW	57												
WR	106												
YR	103												
Cow Eff.	125												

★★★★★ for Low Maintenance, Growth, Marbling, Rib-eye area, Superior Cow, Calving Ease.



337 **BECKTON LARKABA X109 E**
1-A 100% # 1383387 Tattoo: BKT0 X109

Birth: 3-2-10

Beckton Epic K4 N795
BECKTON EPIC U749 D5
 Ref. E-8
 Beckton Denise R308 DM
 Beckton Lancer T A664
BECKTON LARKABA U571 LN
 Beckton Larkaba R394 JE
 Beckton Epic KJ J722
 Beckton Sierra J789 EP
 Beckton Dominor ZC M919
 Beckton Denise L639 JL
 Beckton Lancer 9380
 Beckton Coca 9119 TJ
 Beckton Jules L429
 Beckton Larkaba G311 CT

DAM		Calv.Ease	BW	WW	YW	Milk	HPG	Stay	Maint.En.	BWt	WR	YR	Fr.
Age	2	15	-4.8	23	62	13	7	15	2.1	50	104	111	sma
Wt	652	Marb	+0.28	REA	+0.23	Bfat	+0.02						
Prog.BW	50												
WR	104												
YR	111												
Cow Eff.	126												

★★★★★ for Low Maintenance, Growth, Marbling, Rib-eye area, Superior Cow, Calving Ease, Stayability.

339 **BECKTON FIREFLY X623 E**
1-A 100% # 1383231 Tattoo: BKT0 X623

Birth: 4-6-10

Beckton Epic KM M115
BECKTON EPIC K6 S569
 Ref. E-2
 Beckton Sierra N703 LM
 Beckton Epic KM M115
BECKTON FIREFLY T331 EP
 Beckton Firefly N457 CO
 Beckton Epic K F075
 Beckton Minerva F495 CH
 Beckton Laramie L044
 Beckton Sierra L887 LN
 Beckton Epic K F075
 Beckton Minerva F495 CH
 Beckton Copper JT G095
 Beckton Firefly K180 CH

DAM		Calv.Ease	BW	WW	YW	Milk	HPG	Stay	Maint.En.	BWt	WR	YR	Fr.
Age	3	9	-1.5	40	80	25	10	17	7.2	63	113	109	med
Wt	1075	Marb	+0.34	REA	-0.05	Bfat	+0.06						
Prog.BW	60												
WR	109												
YR	109												
Cow Eff.	98												

★★★★★ for Growth, Marbling, Superior Cow, Calving Ease, Stayability.

338 **BECKTON LARKABA X372 C**
1-A 100% # 1382726 Tattoo: BKT0 X372

Birth: 3-22-10

Beckton Cherokee N N479
BECKTON CHEROKEE T450 L3
 Ref. C-1
 Beckton Annie M337 LN
 Beckton Cruiser M210
BECKTON LARKABA P669 CE
 Beckton Larkaba H101 CL
 BFCK Cherokee Cnyn 4912
 Beckton Dinah C440 NM
 Beckton Lancer TL G626
 Beckton Annie F743 LN
 Beckton Cruiser K118
 Beckton Larkaba KA36 HR
 Beckton Clipper KH F416
 Beckton Larkaba F843 JL

DAM		Calv.Ease	BW	WW	YW	Milk	HPG	Stay	Maint.En.	BWt	WR	YR	Fr.
Age	6	14	-3.8	17	42	21	10	14	-1.6	62	99	100	med
Wt	1070	Marb	-0.09	REA	+0.16	Bfat	+0.02						
Prog.BW	70												
WR	104												
YR	103												
Cow Eff.	98												

★★★★★ for Low Maintenance, Rib-eye area, Calving Ease, Stayability.

340 **BECKTON VERNICE X101 N**
1-A 100% # 1382698 Tattoo: BKT0 X101

Birth: 3-1-10

Beckton Nebula J R475
BECKTON NEBULA T054 H3
 Ref. N-7
 BKT Pine Marie R401 HU
 Beckton Nebula M045
 Beckton Larkeisa M138 JC
 Beckton Hustler C2 L079
 Bkt Pine Marie LC30 CD
 Beckton Lancer T A664
 Bkt Suffeina A828 DM
BECKTON VERNICE N200 LN
 Beckton Vernice J693 HU
 Beckton Hustler S G291
 Beckton Vernice G070 HD

DAM		Calv.Ease	BW	WW	YW	Milk	HPG	Stay	Maint.En.	BWt	WR	YR	Fr.
Age	7	13	-3.5	24	47	9	11	15	-3.6	64	97	95	med
Wt	1010	Marb	+0.22	REA	+0.31	Bfat	+0.00						
Prog.BW	73												
WR	97												
YR	98												
Cow Eff.	101												

★★★★★ for Low Maintenance, Marbling, Rib-eye area, Calving Ease, Stayability.

• Heifers •

341 **BECKTON LANA X159 H**
1-A 100% # 1382940 Tattoo: BSF0 X159

Birth: 3-10-10

Beckton Heritage N013
BECKTON HERITAGE T270 J2
 Ref. H-4

Beckton Coca P602 JL

Beckton Justice C K449
BECKTON LANA R241 JC
 Beckton Lana L007 JL

Beckton Hustler C2 L079
 Beckton Lana L007 JL
 Beckton Julian GG B571
 Beckton Coca J270 CD
 Beckton Justice G302
 Bkt Larkabel C742 CF
 Beckton Julian G1 J526
 Beckton Lana J790 EP

DAM		Calv.Ease	BW	WW	YW	Milk	HPG	Stay	Maint.En.
Age	5	16	-4.4	38	65	8	11	15	1.7
Wt	NA								
Prog.BW	53								
WR	90								
YR	91								
Cow Eff.	NA								
		Marb	+0.33	REA	+0.09	Bfat	+0.03		
						BWt	56	WR	97
						YR	104	Fr.	sma

★★★★★ for Low Maintenance, Marbling, Calving Ease, Stayability.

343 **TR CEDAR XT054**
1-A 100% # 1369777 Tattoo: TR2A0 XT05

Birth: 4-6-10

Bfck Cherokee Cnyn 4912
TR RICARDO RT574
 Ref. C-3

TR Dyna LT111

BJR Make My Day 981
MS GEOMETRIC 003
 MS Geometric 277

Buf Crk Chf 824-1658
 MRM 1431 8611 9109
 Beckton Julian GG B571
 BSF Dyna JT976
 BJR Easy Rider 781
 BJR Tow Kana 117-710
 BKT Julian 7526 G
 MS Geometric 962

DAM		Calv.Ease	BW	WW	YW	Milk	HPG	Stay	Maint.En.
Age	10	12	-2.4	28	60	12	10	13	1.5
Wt	1530								
Prog.BW	71								
WR	NA								
YR	NA								
Cow Eff.	NA								
		Marb	+0.28	REA	+0.21	Bfat	+0.00		
						BWt	77	WR	98
						YR	104	Fr.	med

★★★★★ for Low Maintenance, Marbling, Rib-eye area, Calving Ease.



344 **TR LANA XT063**
1-A 100% # 1369799 Tattoo: TR2A0 XT06

Birth: 2-18-10

Beckton Nebula M045
TR NEBULA TT779
 Ref. N-13

TR Lydia MT244

BSF Julian JT911
TR LANA NT331
 TR Lana G760

Beckton Neptune R2 K065
 Beckton Belga K285 JL
 Beckton Lancer F134 TS
 Beckton Lydia E251 CL
 Beckton Julian G717 GG
 TR Lydia G750
 Beckton Cody V E023
 Beckton Lana E828 SC

DAM		Calv.Ease	BW	WW	YW	Milk	HPG	Stay	Maint.En.
Age	7	13	-2.0	30	58	15	12	13	1.2
Wt	1580								
Prog.BW	75								
WR	NA								
YR	NA								
Cow Eff.	NA								
		Marb	+0.09	REA	-0.04	Bfat	+0.01		
						BWt	82	WR	96
						YR	98	Fr.	med

★★★★★ for Low Maintenance, Calving Ease.

342 **BECKTON MINERVA X422 E**
1-A 100% # 1382656 Tattoo: BKT0 X422

Birth: 3-25-10

Beckton Epic KM M115
BECKTON EPIC K6 S569
 Ref. E-2

Beckton Sierra N703 LM

Beckton Epic D404
BECKTON MINERVA K929 EP
 Beckton Minerva CB69 JL

Beckton Epic K F075
 Beckton Minerva F495 CH
 Beckton Laramie L044
 Beckton Sierra L887 LN
 Beckton Saga KJ B702
 Beckton Kuruba B508 PC
 Beckton Julian GN 9A45
 Bkt Minerva 7016 TJ

DAM		Calv.Ease	BW	WW	YW	Milk	HPG	Stay	Maint.En.
Age	10	9	-2.1	22	53	21	10	15	-0.8
Wt	1025								
Prog.BW	80								
WR	105								
YR	103								
Cow Eff.	98								
		Marb	+0.20	REA	+0.04	Bfat	+0.04		
						BWt	75	WR	102
						YR	98	Fr.	sma

★★★★★ for Low Maintenance, Marbling, Superior Cow, Calving Ease, Stayability.

345 **TR LANA XT080**
1-A 100% # 1369820 Tattoo: TR2A0 XT08

Birth: 3-8-10

Beckton Nebula M045
TR NEBULA TT779
 Ref. N-13

TR Lydia MT244

Beckton Julius M213
TR LANA RT547
 TR Lana NT331

Beckton Neptune R2 K065
 Beckton Belga K285 JL
 Beckton Lancer F134 TS
 Beckton Lydia E251 CL
 BKT Julian 7526 G
 Beckton Lana H128 HR
 BSF Julian JT911
 TR Lana G760

DAM		Calv.Ease	BW	WW	YW	Milk	HPG	Stay	Maint.En.
Age	5	14	-1.8	39	63	14	12	15	3.2
Wt	1515								
Prog.BW	80								
WR	NA								
YR	NA								
Cow Eff.	NA								
		Marb	+0.21	REA	-0.11	Bfat	+0.01		
						BWt	74	WR	112
						YR	102	Fr.	med

★★★★★ for Low Maintenance, Marbling, Calving Ease, Stayability.

• Heifers •

346 **TR LASS XT056**
1-A 100% # 1369785 Tattoo: TR2A0 XT05

Birth: 3-1-10

Bfck Cherokee Cnyn 4912
 Buf Crk Chf 824-1658
 MRM 1431 8611 9109

TR RICARDO RT574
Ref. C-3
 TR Dyna LT111
 Beckton Julian GG B571
 BSF Dyna JT976

Buf Crk Julesburg 5807
 Buf Crk Julian 4942
 Buf Crk Vesta 3436

BUF CRK LASS L011A
 Buf Crk Lass 5545
 Beckton Lancer G575 T
 Buf Crk Lass 4773

DAM		Calv.Ease	BW	WW	YW	Milk	HPG	Stay	Maint.En.
Age	9	11	-2.3	21	39	14	13	15	-4.7
Wt	1325	Marb	+0.14	REA	+0.42	Bfat	+0.02	BWt	83
Prog.BW	83	WR	NA	YR	NA	YR	98	Fr.	med
WR	NA								
YR	NA								
Cow Eff.	NA								

★★★★★ for Low Maintenance, Marbling, Rib-eye area, Calving Ease, Stayability.

349 **TR PRIMROSE XT064**
1-A 100% # 1369802 Tattoo: TR2A0 XT06

Birth: 2-23-10

Beckton Julius M213
 Beckton Julian 7526G
 Beckton Lana H128 HR

TR JULIUS ST633
Ref. J-10

Beckton Lancer T6 M467
 Beckton Lana C735 TP
 Beckton Lancer TL G626
 Beckton Lana C735 TP

Beckton Lancer T6 M467
 BSF Regus M383 CH
 Beckton Champ R3 H338
 BSF Regus J306

DAM		Calv.Ease	BW	WW	YW	Milk	HPG	Stay	Maint.En.
Age	6	13	-1.3	38	60	10	9	17	-2.9
Wt	1285	Marb	+0.18	REA	-0.14	Bfat	+0.04	BWt	82
Prog.BW	71	WR	NA	YR	NA	YR	96	Fr.	sma
WR	NA								
YR	NA								
Cow Eff.	NA								

★★★★★ for Low Maintenance, Marbling, Calving Ease, Stayability.

347 **TR EOLA XT061**
1-A 100% # 1369793 Tattoo: TR2A0 XT06

Birth: 3-15-10

Beckton Nebula M045
 Beckton Belga K285 JL

TR NEBULA TT779
Ref. N-13
 TR Lydia MT244
 Beckton Lancer F134 TS
 Beckton Lydia E251 CL

Beckton Clifftop T C075
 Beckton Barmaid A761 TR
 BJR Topper 5241

TR EOLA NT301
 Beckton Eola E567 JL
 Beckton Julian GG B571
 Beckton Eola 8053 JP

DAM		Calv.Ease	BW	WW	YW	Milk	HPG	Stay	Maint.En.
Age	7	17	-5.1	25	55	12	10	13	0.9
Wt	1580	Marb	+0.06	REA	-0.14	Bfat	-0.01	BWt	67
Prog.BW	72	WR	NA	YR	NA	YR	95	Fr.	med
WR	NA								
YR	NA								
Cow Eff.	NA								

★★★★★ for Low Maintenance, Calving Ease, Stayability.



348 **TR DYNA XT053**
1-A 100% # 1369783 Tattoo: TR2A0 XT05

Birth: 4-16-10

Beckton Julian GG B571
 BKT Julian 7526 G
 BKT Marta 9A13 JL

TR JULIAN ST630
Ref. J-9
 MS GeometricC 003
 BJR Make My Day 981
 MS Geometric 277

TR Lancer G010
 Beckton Lancer T A664
 BKT Kuruba 9727 RV

BSF DYNA JT976
 Buf Crk Dyna 3082
 Buf Crk Hobo 1961
 Buf Crk Dyna 1777

DAM		Calv.Ease	BW	WW	YW	Milk	HPG	Stay	Maint.En.
Age	11	13	-1.7	19	49	13	8	16	4.7
Wt	1300	Marb	+0.05	REA	+0.08	Bfat	+0.02	BWt	80
Prog.BW	77	WR	NA	YR	NA	YR	105	Fr.	sma
WR	NA								
YR	NA								
Cow Eff.	NA								

★★★★★ for Calving Ease, Stayability.

350 **TR TAMARA XT069**
1-A 100% # 1369776 Tattoo: TR2A0 XT06

Birth: 4-2-10

Beckton Hasten P292
 Beckton Hustler C2 L079
 Beckton Sheba L644 CH

BECKTON HASTEN H S462
Ref. H-3
 Beckton Lakme G128 HD
 Beckton Hadrian FC E166
 Beckton Lakme E373 CL

Beckton Nebula M045
 Beckton Neptune R2 K065
 Beckton Belga K285 JL

BECKTON TAMARA R801 NB
 Beckton Tamara HA54 LN
 Beckton Lancer TS D390
 Beckton Tamara D383 JV

DAM		Calv.Ease	BW	WW	YW	Milk	HPG	Stay	Maint.En.
Age	5	17	-5.8	22	47	16	10	13	-1.0
Wt	1315	Marb	-0.09	REA	-0.09	Bfat	+0.02	BWt	67
Prog.BW	68	WR	NA	YR	NA	YR	98	Fr.	med
WR	NA								
YR	NA								
Cow Eff.	NA								

★★★★★ for Low Maintenance, Calving Ease.

• Heifers •

351 **TR KURUBA XT079**
1-A 100% # 1369819 Tattoo: TR2A0 XT07

Birth: 3-11-10

Bfck Cherokee Cnyn 4912 < Buf Crk Chf 824-1658
MRM 1431 8611 9109

TR RICARDO RT574
Ref. C-3 < TR Dyna LT111 < Beckton Julian GG B571
BSF Dyna JT976

Mushrush LT N020 < TR Julian LT142
Mushrush Lana 1061

TR KURUBA RT544
TR Kuruba NT320 < TR Hobo LT144
Beckton Kuruba E688 BR

DAM		Calv.	Ease	BW	WW	YW	Milk	HPG	Stay	Maint.En.
Age	5	18	-6.3	19	38	17	11	15	-5.8	
Wt	886	Marb	+0.17	REA	+0.17	Bfat	+0.02	BWt	63	98
Prog.BW	73	WR	NA	YR	NA	YR	NA	Fr.	97	sma
WR	NA									
YR	NA									
Cow Eff.	NA									

★★★★★ for Low Maintenance, Marbling, Rib-eye area, Calving Ease, Stayability.

353 **TR RUTH XT070**
1-A 100% # 1369807 Tattoo: TR2A0 XT07

Birth: 2-11-10

Bfck Cherokee Cnyn 4912 < Buf Crk Chf 824-1658
MRM 1431 8611 9109

TR RICARDO RT574
Ref. C-3 < TR Dyna LT111 < Beckton Julian GG B571
BSF Dyna JT976

TR Julian LT151 < Beckton Julian GG B571
MS Geometric 917

TR RUTH RT500
Beckton Ruth C176 RN < Beckton Ranger 7003
Beckton Ruth 9815 JL

DAM		Calv.	Ease	BW	WW	YW	Milk	HPG	Stay	Maint.En.
Age	5	17	-5.7	18	32	16	10	15	-1.3	
Wt	1520	Marb	+0.24	REA	+0.18	Bfat	+0.01	BWt	60	91
Prog.BW	71	WR	NA	YR	NA	YR	NA	Fr.	89	sma
WR	NA									
YR	NA									
Cow Eff.	NA									

★★★★★ for Low Maintenance, Marbling, Rib-eye area, Calving Ease, Stayability.

352 **TR TAMARA XT082**
1-A 100% # 1369822 Tattoo: TR2A0 XT08

Birth: 2-25-10

Beckton Nebula M045 < Beckton Neptune R2 K065
Beckton Belga K285 JL

TR NEBULA TT779
Ref. N-13 < TR Lydia MT244 < Beckton Lancer F134 TS
Beckton Lydia E251 CL

TR Julian LT151 < Beckton Julian GG B571
MS Geometric 917

TR TAMARA ST653
Beckton Tamara F102 RU < Beckton Romulus D497
Beckton Tamara D708 LN

DAM		Calv.	Ease	BW	WW	YW	Milk	HPG	Stay	Maint.En.
Age	4	17	-5.1	26	48	12	11	13	0.3	
Wt	1255	Marb	+0.22	REA	-0.16	Bfat	-0.02	BWt	63	97
Prog.BW	59	WR	NA	YR	NA	YR	NA	Fr.	94	med
WR	NA									
YR	NA									
Cow Eff.	NA									

★★★★★ for Low Maintenance, Marbling, Calving Ease, Stayability.

354 **BECKTON INDIGO X072 N**
1-A 100% # 1383066 Tattoo: BSF0 X072

Birth: 2-24-10

Beckton Nebula PJ S543 < Beckton Nebula P P707
Beckton Lana P685 JO

BECKTON NEBULA U060 N4
Ref. N-11 < Beckton Birdie S110 NB < Beckton Nebula P P707
Beckton Birdie P086 WR

Beckton Nebula EN S347 < Beckton Nebula E P084
Beckton Eola P530 NB

BECKTON INDIGO U038 NB
Beckton Indigo S538 LO < Beckton Loki C M740
Beckton Indigo M585 LN

DAM		Calv.	Ease	BW	WW	YW	Milk	HPG	Stay	Maint.En.
Age	2	17	-4.9	33	58	13	8	17	-5.5	
Wt	716	Marb	+0.44	REA	-0.15	Bfat	+0.03	BWt	54	114
Prog.BW	54	WR	114	YR	103	YR	103	Fr.	103	sma
WR	114									
YR	103									
Cow Eff.	127									

★★★★★ for Low Maintenance, Marbling, Calving Ease, Stayability.



355 **BECKTON BELGA X499 E**
1-A 100% # 1382775 Tattoo: BKT0 X499

Birth: 3-28-10

Beckton Epic KM M115 < Beckton Epic K F075
Beckton Minerva F495 CH

BECKTON EPIC K6 S569
Ref. E-2 < Beckton Sierra N703 LM < Beckton Laramie L044
Beckton Sierra L887 LN

Beckton Dominor ZC M919 < Beckton Dominor Z E401
Beckton Barmaid J012 CO

BECKTON BELGA R716 DM
Beckton Belga K285 JL < Beckton Julian GG B571
Beckton Belga G493 HR

DAM		Calv.	Ease	BW	WW	YW	Milk	HPG	Stay	Maint.En.
Age	5	14	-3.9	24	60	24	10	16	-0.6	
Wt	955	Marb	+0.25	REA	+0.08	Bfat	+0.06	BWt	64	97
Prog.BW	67	WR	102	YR	103	YR	98	Fr.	98	sma
WR	102									
YR	103									
Cow Eff.	107									

★★★★★ for Low Maintenance, Marbling, Calving Ease, Stayability.

• Heifers •

356 **BECKTON ROSE X478 C**
1-A 100% # 1382662 Tattoo: BKT0 X478

Birth: 3-27-10

Beckton Cherokee N N479 < BFCK Cherokee Cnyn 4912
Beckton Dinah C440 NM
BECKTON CHEROKEE T450 L3
Ref. C-1 < Beckton Lancer TL G626
Beckton Annie M337 LN < Beckton Annie F743 LN
Beckton Lancer F442 T < Beckton Lancer T A664
Beckton Suffeina A828 DM
BECKTON ROSE L311 LN
Beckton Rose H292 HD < Beckton Hadrian F C486
Beckton Rose A528 PC

DAM	
Age	9
Wt	1060
Prog. BW	72
WR	103
YR	107
Cow Eff.	99

Calv. Ease	BW	WW	YW	Milk	HPG	Stay	Maint. En.
14	-3.8	24	53	17	10	15	-6.9
Marb	REA	Bfat	BWt	WR	YR	Fr.	
+0.07	+0.24	+0.02	63	99	102	sma	

★★★★★ for Low Maintenance, Rib-eye area, Calving Ease, Stayability.



357 **BECKTON SUSAN X220 N**
1-A 99% # 1382675 Tattoo: BKT0 X220

Birth: 3-15-10

Beckton Nebula M045 < Beckton Neptune R2 K065
Beckton Belga K285 JL
BECKTON NEBULA T269 E2
Ref. N-8 < Beckton Epic KN H110
Beckton Ruth M967 EP < Beckton Ruth A905 SG
Beckton Champ R1 H024 < Beckton Champ RH F275
Beckton Lana F138 LN
BECKTON SUSAN M144 CH
Beckton Susan F315 TP < RDD B Topper 1675
Beckton Susan 9785VK

DAM	
Age	8
Wt	1120
Prog. BW	65
WR	100
YR	99
Cow Eff.	99

Calv. Ease	BW	WW	YW	Milk	HPG	Stay	Maint. En.
13	-3.7	21	44	21	7	13	-3.4
Marb	REA	Bfat	BWt	WR	YR	Fr.	
+0.27	+0.17	+0.02	60	96	94	med	

★★★★★ for Low Maintenance, Marbling, Rib-eye area, Calving Ease, Stayability.

359 **BECKTON BELGA X345 E**
1-A 100% # 1382897 Tattoo: BSF0 X345

Birth: 3-21-10

Beckton Epic KM M115 < Beckton Epic K F075
Beckton Minerva F495 CH
BECKTON EPIC K6 S569
Ref. E-2 < Beckton Laramie L044
Beckton Sierra N703 LM < Beckton Sierra L887 LN
Beckton Epic K F075
Beckton Lana F891 JL
BECKTON BELGA P119 EP
Beckton Julian 7526G
Beckton Belga K476 JL < Beckton Belga F772 VG

DAM	
Age	6
Wt	985
Prog. BW	72
WR	99
YR	99
Cow Eff.	103

Calv. Ease	BW	WW	YW	Milk	HPG	Stay	Maint. En.
11	-2.3	27	58	24	8	15	1.6
Marb	REA	Bfat	BWt	WR	YR	Fr.	
+0.25	+0.03	+0.08	71	102	91	med	

★★★★★ for Low Maintenance, Marbling, Calving Ease, Stayability.

358 **BECKTON ROSE X228 N**
1-2 99% # 1382820 Tattoo: BSF0 X228

Birth: 3-15-10

Beckton Nebula M045 < Beckton Neptune R2 K065
Beckton Belga K285 JL
BECKTON NEBULA T269 E2
Ref. N-8 < Beckton Epic KN H110
Beckton Ruth M967 EP < Beckton Ruth A905 SG
Beckton Copper J E616 < Buf Crk Coppertop 3230
Beckton Bkt Larkeisa C894 JV
BECKTON ROSE J565 CO
Beckton Rose F280 JL < Beckton Julian GG B571
Beckton Rose A624 BF

DAM	
Age	11
Wt	1015
Prog. BW	74
WR	107
YR	104
Cow Eff.	100

Calv. Ease	BW	WW	YW	Milk	HPG	Stay	Maint. En.
12	-1.9	21	47	22	8	15	-2.1
Marb	REA	Bfat	BWt	WR	YR	Fr.	
+0.19	-0.06	+0.04	64	100	99	sma	

★★★★★ for Low Maintenance, Marbling, Superior Cow, Calving Ease, Stayability.

360 **TR DYNA XT084**
1-A 100% # 1369826 Tattoo: TR2A0 XT08

Birth: 3-5-10

Bfck Cherokee Cnyn 4912 < Buf Crk Chf 824-1658
MRM 1431 8611 9109
TR RICARDO RT574
Ref. C-3 < Beckton Julian GG B571
TR Dyna LT111 < BSF Dyna JT976
Beckton Julian 7526G
Beckton Lana H128 HR
TR DYNA ST669

DAM	
Age	4
Wt	1150
Prog. BW	70
WR	NA
YR	NA
Cow Eff.	NA

Calv. Ease	BW	WW	YW	Milk	HPG	Stay	Maint. En.
15	-3.5	27	40	17	10	17	-7.3
Marb	REA	Bfat	BWt	WR	YR	Fr.	
+0.25	+0.21	+0.02	73	104	97	sma	

★★★★★ for Low Maintenance, Marbling, Rib-eye area, Calving Ease, Stayability.

• Heifers •

361 **TR WILLOW XT072**
1-A 100% # 1369812 Tattoo: TR2A0 XT07

Birth: 3-7-10

Beckton Julian GG B571 < BKT Julian 7526 G
BKT Marta 9A13 JL

TR JULIAN ST630
Ref. J-9 MS GeometriC 003 < BJR Make My Day 981
MS Geometric 277

TR Julian LT151 < Beckton Julian GG B571
MS Geometric 917

TR WILLOW RT518
Buckeye Pam K48 < Buf Crk Dynamics 3820
Buckeye Alberta

DAM	
Age	5
Wt	1495
Prog.BW	57
WR	NA
YR	NA
Cow Eff.	NA

Calv.Ease	BW	WW	YW	Milk	HPG	Stay	Maint.En.		
21	-5.9	18	43	15	9	15	7.0		
Marb	+0.05	REA	+0.01	Bfat	+0.02	BWt	WR	YR	Fr.
				57	92	94	med		

★★★★★ for Calving Ease, Stayability.

364 **TR RUTH XT076**
1-A 100% # 1369816 Tattoo: TR2A0 XT07

Birth: 3-23-10

Beckton Julian GG B571 < BKT Julian 7526 G
BKT Marta 9A13 JL

TR JULIAN ST630
Ref. J-9 MS GeometriC 003 < BJR Make My Day 981
MS Geometric 277

Mushrush LT N020 < TR Julian LT142
Mishrush Lana 1061

TR RUTH RT534
TR Ruth LT126 < BSF Julian JT911
Beckton Ruth D817 NP

DAM	
Age	5
Wt	1215
Prog.BW	71
WR	NA
YR	NA
Cow Eff.	NA

Calv.Ease	BW	WW	YW	Milk	HPG	Stay	Maint.En.		
18	-4.9	9	32	12	11	16	-2.2		
Marb	-0.03	REA	+0.05	Bfat	-0.02	BWt	WR	YR	Fr.
				67	89	91	sma		

★★★★★ for Low Maintenance, Calving Ease, Stayability.

362 **TR LARK XT068**
1-A 100% # 1369775 Tattoo: TR2A0 XT06

Birth: 4-16-10

Beckton Ranger 9479R < Beckton Ranger 7003
Beckton Eola 7470 RZ

BECKTON RANGER T603 H3
Ref. R-1 Beckton Rose N044 HU < Beckton Hustler C2 L079
Beckton Rose L669 JL

Beckton Justice C K449 < Beckton Justice G302
Bkt Larkabel C742 CF

BKT LARKEISA R775 JC
BKT Larkeisa L149 CK < Beckton Colt G552
Bkt Larkeisa E578 HB

DAM	
Age	5
Wt	1295
Prog.BW	72
WR	NA
YR	NA
Cow Eff.	NA

Calv.Ease	BW	WW	YW	Milk	HPG	Stay	Maint.En.		
11	-2.3	24	56	7	12	10	-3.2		
Marb	+0.07	REA	-.11	Bfat	+0.01	BWt	WR	YR	Fr.
				78	94	97	sma		

★★★★★ for Low Maintenance, Calving Ease.

365 **TR LANA XT087**
1-A 100% # 1369835 Tattoo: TR2A0 XT08

Birth: 4-7-10

Beckton Julian GG B571 < BKT Julian 7526 G
BKT Marta 9A13 JL

TR JULIAN ST630
Ref. J-9 MS GeometriC 003 < BJR Make My Day 981
MS Geometric 277

Mushrush LT N020 < TR Julian LT142
Mushrush

TR LANA TT717
BC Lana L378 < BC Hobo 2595
BC Lana 4445

DAM	
Age	3
Wt	1250
Prog.BW	77
WR	NA
YR	NA
Cow Eff.	NA

Calv.Ease	BW	WW	YW	Milk	HPG	Stay	Maint.En.		
16	-3.4	13	42	11	11	16	0.6		
Marb	-0.06	REA	+0.13	Bfat	-0.01	BWt	WR	YR	Fr.
				71	84	89	sma		

★★★★★ for Low Maintenance, Rib-eye area, Calving Ease, Stayability.

363 **TR DYNA XT066**
1-A 100% # 1369805 Tattoo: TR2A0 XT06

Birth: 2-27-10

Beckton Julian GG B571 < BKT Julian 7526 G
BKT Marta 9A13 JL

TR JULIAN LT151
Ref. J-8 MS Geometric 917 < BJR Yo 121
MS Geometric

Beckton Cody V E023 < Beckton Cody C401
Beckton Birdie C353 VG

TR DYNA PT487
TR Dyna LT111 < Beckton Julian GG B571
BSF Dyna JT976

DAM	
Age	6
Wt	1380
Prog.BW	75
WR	NA
YR	NA
Cow Eff.	NA

Calv.Ease	BW	WW	YW	Milk	HPG	Stay	Maint.En.		
16	-3.6	21	42	14	12	15	3.3		
Marb	+0.50	REA	+0.10	Bfat	+0.02	BWt	WR	YR	Fr.
				77	97	89	sma		

★★★★★ for Low Maintenance, Marbling, Calving Ease, Stayability.



• Heifers •

366 BECKTON MINOLA X255 N
1-A 100% # 1383218 Tattoo: BKT0 X255

Birth: 3-17-10

Beckton Nebula M045
Beckton Neptune R2 K065
Beckton Belga K285 JL

BECKTON NEBULA E P084
Ref. N-2 \BKT Pine Marie M119 EP

Beckton Epic K F075
Bkt Pine Marie D126 JL

Beckton Nebula M045
BKT Pine Marie M119 EP

BECKTON MINOLA T233 NB
Beckton Warrior T C371
Beckton Minola H170 JL

DAM		Calv.Ease	BW	WW	YW	Milk	HPG	Stay	Maint.En.
Age	3	17	-5.3	24	55	15	4	16	-3.7
Wt	990	Marb	+0.41	REA	-0.16	Bfat	+0.05	66	101
Prog.BW	66							102	sma
WR	101								
YR	102								
Cow Eff.	94								

★★★★★ for Low Maintenance, Marbling, Calving Ease, Stayability.

369 BECKTON LANA X668 N
1-2 100% # 1382788 Tattoo: BKT0 X668

Birth: 4-10-10

Beckton Nebula P P707
Beckton Nebula M045
Beckton Lana M809 EP

BECKTON NEBULA PJ S543
Ref. N-6 \Beckton Lana P685 JO

Beckton Lasso P741
Beckton Lancer T1 H080
Beckton Ruth G534 NP

BECKTON LANA S049 LO
Beckton Lana P265 JO
Beckton Lana J131 CT

DAM		Calv.Ease	BW	WW	YW	Milk	HPG	Stay	Maint.En.
Age	4	18	-7.1	24	47	17	6	13	-5.9
Wt	980	Marb	+0.41	REA	+0.02	Bfat	+0.01	55	110
Prog.BW	62							98	sma
WR	108								
YR	100								
Cow Eff.	115								

★★★★★ for Low Maintenance, Marbling, Calving Ease, Stayability.

367 BECKTON LARKABA X332 N
1-A 100% # 1382944 Tattoo: BSF0 X332

Birth: 3-20-10

Beckton Nebula M045
Beckton Neptune R2 K065
Beckton Belga K285 JL

BECKTON NEBULA E P084
Ref. N-2 \BKT Pine Marie M119 EP

Beckton Epic K F075
Bkt Pine Marie D126 JL

Beckton Dominor ZC M919
Beckton Dominor Z E401
Beckton Barmaid J012 CO

BECKTON LARKABA R338 DM
Beckton Larkaba D170 JV
Beckton Javelin RN Z358
Beckton Larkaba Z257 ZN

DAM		Calv.Ease	BW	WW	YW	Milk	HPG	Stay	Maint.En.
Age	5	16	-5.3	17	37	19	8	15	-7.8
Wt	1035	Marb	+0.49	REA	-0.20	Bfat	+0.03	65	106
Prog.BW	67							97	sma
WR	105								
YR	101								
Cow Eff.	108								

★★★★★ for Low Maintenance, Marbling, Calving Ease, Stayability.

370 BECKTON BELGA X116 E
1-A 100% # 1382876 Tattoo: BSF0 X116

Birth: 3-3-10

Beckton Epic KM M115
Beckton Epic K F075
Beckton Minerva F495 CH

BECKTON EPIC K6 S569
Ref. E-2 \Beckton Sierra N703 LM

Beckton Laramie L044
Beckton Sierra L887 LN

Beckton Neptune R2 K065
Beckton Neptune RR B284
Beckton Lana C735 TP

BECKTON BELGA N308 NP
Beckton Belga HC71 CB
Beckton Cobalt V AC03
Beckton Belga 9582VC

DAM		Calv.Ease	BW	WW	YW	Milk	HPG	Stay	Maint.En.
Age	7	11	-2.6	14	48	27	11	14	2.6
Wt	1275	Marb	+0.32	REA	-0.12	Bfat	+0.04	70	74
Prog.BW	71							89	sma
WR	104								
YR	104								
Cow Eff.	61								

★★★★★ for Low Maintenance, Marbling, Superior Cow, Calving Ease, Stayability.

368 BECKTON INDIGO X262 E
1-A 100% # 1382844 Tattoo: BSF0 X262

Birth: 3-17-10

Beckton Epic KJ J722
Beckton Epic K F075
Beckton Lana F891 JL

BECKTON EPIC K4 N795
Ref. E-1 \Beckton Sierra J789 EP

Beckton Epic D404
Beckton Sierra C157 CL

Beckton Loki F251
Beckton Lancer TZ D525
Bkt Pine Marie D126 JL

BECKTON INDIGO LC22 LO
Beckton Indigo E370 RN
Beckton Ranger H Z095
Beckton Indigo A735 LN

DAM		Calv.Ease	BW	WW	YW	Milk	HPG	Stay	Maint.En.
Age	9	8	0.2	28	61	15	1	13	2.1
Wt	1170	Marb	+0.46	REA	+0.10	Bfat	+0.04	79	96
Prog.BW	77							96	med
WR	106								
YR	101								
Cow Eff.	81								

★★★★★ for Low Maintenance, Marbling, Calving Ease, Stayability.

371 BECKTON BELGA X244 H
1-A 100% # 1382744 Tattoo: BKT0 X244

Birth: 3-16-10

Beckton Heritage N013
Beckton Hustler C2 L079
Beckton Lana L007 JL

BECKTON HERITAGE T270 J2
Ref. H-4 \Beckton Coca P602 JL

Beckton Julian GG B571
Beckton Coca J270 CD

Beckton Justice Cc N265
Beckton Justice C K449
Beckton Rose H303 CL

BECKTON BELGA R173 JC
Beckton Belga N528 EP
Beckton Epic KJ J722
Beckton Belga K285 JL

DAM		Calv.Ease	BW	WW	YW	Milk	HPG	Stay	Maint.En.
Age	5	13	-2.1	35	56	9	9	15	2.7
Wt	1035	Marb	+0.30	REA	+0.10	Bfat	+0.05	69	94
Prog.BW	70							92	med
WR	104								
YR	103								
Cow Eff.	96								

★★★★★ for Low Maintenance, Marbling, Superior Cow, Calving Ease, Stayability.

Reference Sires

The goal for Beckton's program has always been to develop breeding seedstock which offer increased levels of performance for the commercial cattleman. Increased performance does not mean maximizing weight and size, which have already reached the upper limit of economic

value for the packer and consumer. It does, however, mean increasing performance related to calving percentage and weaning percentage; and increasing performance related to cow maintenance requirements and "pounds of calf per acre" efficiency.



Beckton Julian B571 (Ref. Sire J-1)

• Reference Sires •

A-1 BECKTON ACCENT U777 C2
1-A 100% # 1259524 Tattoo: BKT8 U777

Birth: 4-13-08
 Beckton Cody KH M390
BECKTON CODY K1 P014
 Ref. C-1
 Beckton Rose M126 WR
 Beckton Cherokee N N479
BECKTON SUSAN R022 CQ
 Beckton Susan N023 JE
 Beckton Cody K G701
 Beckton Tamara J124 HR
 Beckton Warrior T C371
 Beckton Rose D741 LN
 BFCK Cherokee Cnyn 4912
 Beckton Dinah C440 NM
 Beckton Jules L429
 Beckton Susan L258 LR

DAM		Calv.Ease	BW	WW	YW	Milk	HPG	Stay	Maint.En.	
Age	3	11	-2.5	29	60	25	11	16	-0.1	
Wt	915	(.28)	(.46)	(.41)	(.40)	(.24)	(.01)	(.01)	(.13)	
Wean Pct.	68%	Marb	-.03 (.25)		REA	+.33 (.24)		Bfat	+.05 (.36)	
Cow Eff.	144	BWt	WWt	WR	ADG	YWt	YR	Scr.	Fr.	
		66	666	117	5	1209	112	38	5.0	

★★★★★ for Low Maintenance, Gainability, Rib-eye area, High Cow Efficiency, Calving Ease, Stayability.

C-3 TR RICARDO RT574
1-A 100% # 1045620 Tattoo: TR2A5 RT57

Birth: 2-21-05
 Buf Crk Chf 824-1658
BFCK CHEROKEE CNYN 4912
 Ref.
 MRM 1431 8611 9109
 Beckton Julian GG B571
TR DYNA LT111
 BSF Dyna JT976
 Buf Crk Chief092-824
 Bflo Crk Carie VC473
 Buf Crk Cherokee1431
 MRM 8454 8219 8611
 BKT Julian 7526 G
 BKT Marta 9A13 JL
 TR Lancer G010
 Buf Crk Dyna 3082

DAM		Calv.Ease	BW	WW	YW	Milk	HPG	Stay	Maint.En.	
Age	4	15	-4.6	27	41	17	11	15	-8.3	
Wt	NA	(.52)	(.72)	(.67)	(.67)	(.51)	(.38)	(.29)	(.24)	
Wean Pct.	NA%	Marb	+.32 (.38)		REA	+.47 (.35)		Bfat	+.01 (.48)	
Cow Eff.	NA	BWt	WWt	WR	ADG	YWt	YR	Scr.	Fr.	
		69	647	101	3	1186	102	36	5.0	

★★★★★ for Low Maintenance, Marbling, Rib-eye area, Calving Ease, Stayability.

C-1 BECKTON CHEROKEE T450 L3
1-A 100% # 1178497 Tattoo: WF7 T450

Birth: 3-19-07
 BFCK Cherokee Cnyn 4912
BECKTON CHEROKEE N N479
 Ref. B
 Beckton Dinah C440 NM
 Beckton Lancer TL G626
BECKTON ANNIE M337 LN
 Beckton Annie F743 LN
 BUF CRK Chief 824-1658
 MRM 1431 8611 9109
 Beckton Nomad K 9949
 Beckton Dinah Z610 JL
 Beckton Lancer T A664
 Beckton Fayette C110 LN
 Beckton Lancer T A664
 Beckton Annie C132 NP

DAM		Calv.Ease	BW	WW	YW	Milk	HPG	Stay	Maint.En.	
Age	5	14	-4.5	18	43	21	10	17	-6.3	
Wt	945	(.33)	(.59)	(.50)	(.46)	(.26)	(.31)	(.01)	(.16)	
Wean Pct.	62%	Marb	+.07 (.26)		REA	+.24 (.25)		Bfat	+.04 (.37)	
Cow Eff.	131	BWt	WWt	WR	ADG	YWt	YR	Scr.	Fr.	
		73	589	98	4	1211	108	38	6.0	

★★★★★ for Low Maintenance, Gainability, Rib-eye area, High Cow Efficiency, Calving Ease, Stayability.



TR Ricardo RT574

C-2 BECKTON CLIFFTOP U575 H3
1-A 100% # 1258956 Tattoo: WF8 U575

Birth: 3-26-08
 Beckton Clifftop T C075
BKT CLIFFTOP TP R288
 Ref. B-1
 Beckton Christy K209 CO
 Beckton Herald FJ J776
BECKTON LARKABEL N769 HR
 Bkt Larkabel F246 CT
 BJR Topper 5241
 Beckton Barmaid A761 TR
 Beckton Copper JT G095
 Beckton Christy A111 VQ
 Beckton Herald F FA20
 Bkt Larkeisa D095 JL
 Beckton Clifftop T C075
 Bkt Larkabel B012 CB

DAM		Calv.Ease	BW	WW	YW	Milk	HPG	Stay	Maint.En.	
Age	5	14	-4.1	16	39	21	14	16	-2.4	
Wt	970	(.30)	(.45)	(.42)	(.40)	(.25)	(.15)	(.01)	(.15)	
Wean Pct.	60%	Marb	-.01 (.26)		REA	+.32 (.25)		Bfat	+.03 (.37)	
Cow Eff.	126	BWt	WWt	WR	ADG	YWt	YR	Scr.	Fr.	
		64	582	100	4	1126	103	35	4.5	

★★★★★ for Low Maintenance, Gainability, Rib-eye area, High Cow Efficiency, Calving Ease, Stayability.

C-4 TR RICARDO DOS
1-A 100% # 1240423 Tattoo: TR2A8 UT81

Birth: 2-20-08
 Buf Crk Chf 824-1658
BFCK CHEROKEE CNYN 4912
 Ref.
 MRM 1431 8611 9109
 Beckton Julian GG B571
TR DYNA LT111
 BSF Dyna JT976
 Buf Crk Chief092-824
 Bflo Crk Carie VC473
 Buf Crk Cherokee1431
 MRM 8454 8219 8611
 BKT Julian 7526 G
 BKT Marta 9A13 JL
 TR Lancer G010
 Buf Crk Dyna 3082

DAM		Calv.Ease	BW	WW	YW	Milk	HPG	Stay	Maint.En.	
Age	7	15	-4.1	27	46	16	9	15	-5.2	
Wt	NA	(.31)	(.38)	(.34)	(.35)	(.26)	(.24)	(.28)	(.18)	
Wean Pct.	NA%	Marb	+.45 (.30)		REA	+.49 (.29)		Bfat	+.02 (.40)	
Cow Eff.	NA	BWt	WWt	WR	ADG	YWt	YR	Scr.	Fr.	
		74	631	103	3	1129	102	39	4.5	

★★★★★ for Low Maintenance, Marbling, Rib-eye area, Calving Ease, Stayability.

• Reference Sires •

D-1 BECKTON DOMINOR Z1 R610
1-A 100% # 1042348 Tattoo: WF5 R610

Birth: 4-3-05
 Beckton Dominor Z E401
BECKTON DOMINOR ZC M919
 Ref. D Beckton Barmaid J012 CO
 Beckton Dominor 9455
 Beckton Belga B061 ZN
 Beckton Copper JT G095
 Beckton Barmaid G565 LN
 Beckton Loki F251
BECKTON SIERRA K557 LO
 Beckton Sierra C157 CL
 Beckton Lancer TZ D525
 Bkt Pine Marie D126 JL
 Beckton Clipper JL A095
 Beckton Sierra A086 CL

DAM		Calv.Ease	BW	WW	YW	Milk	HPG	Stay	Maint.En.
Age	5	16	-4.9	25	59	18	4	16	3.4
Wt	1100	(.48)	(.71)	(.65)	(.65)	(.45)	(.27)	(.10)	(.35)
Wean Pct.	55%	Marb +0.34 (.40)		REA +0.04 (.38)		Bfat +0.07 (.49)			
Cow Eff.	115	BWt	WWt	WR	ADG	YWt	YR	Scr.	Fr.
		69	600	102	5	1169	105	34	5.5

★★★★★ for Low Maintenance, Gainability, Marbling, Calving Ease, Stayability.

E-2 BECKTON EPIC K6 S569
1-A 100% # 1119032 Tattoo: WF6 S569

Birth: 3-24-06
 Beckton Epic K F075
BECKTON EPIC KM M115
 Ref. E Beckton Minerva F495 CH
 Beckton Epic D404
 Beckton Belga D483 KR
 Beckton Champ R A583
 Beckton Minerva CB69 JL
 Beckton Lancer T4 J536
 Beckton Sierra J659 DM
 Beckton Lancer TZ D525
 Beckton Sierra H442 HD

DAM		Calv.Ease	BW	WW	YW	Milk	HPG	Stay	Maint.En.
Age	3	11	-2.8	32	74	26	9	16	3.6
Wt	980	(.48)	(.68)	(.60)	(.60)	(.38)	(.31)	(.01)	(.27)
Wean Pct.	65%	Marb +0.34 (.31)		REA +0.05 (.28)		Bfat +0.07 (.41)			
Cow Eff.	136	BWt	WWt	WR	ADG	YWt	YR	Scr.	Fr.
		78	698	117	5	1342	119	37	6.0

★★★★★ for Low Maintenance, Growth, Gainability, Marbling, High Cow Efficiency, Calving Ease, Stayability.

E-1 BECKTON EPIC K4 N795
1-A 100% # 916917 Tattoo: WF3 N795

Birth: 4-21-03
 Beckton Epic K F075
BECKTON EPIC KJ J722
 Ref. E Beckton Lana F891 JL
 Beckton Epic D404
BECKTON SIERRA J789 EP
 Beckton Sierra C157 CL
 Beckton Epic D404
 Beckton Belga D483 KR
 Beckton Cliffot T C075
 Beckton Lana 9610 TP
 Beckton Saga KJ B702
 Beckton Kuruba B508 PC
 Beckton Clipper JL A095
 Beckton Sierra A086 CL

DAM		Calv.Ease	BW	WW	YW	Milk	HPG	Stay	Maint.En.
Age	4	8	-0.4	37	87	12	0	10	6.2
Wt	1095	(.75)	(.81)	(.79)	(.79)	(.73)	(.52)	(.21)	(.54)
Wean Pct.	54%	Marb +0.56 (.62)		REA +0.32 (.60)		Bfat +0.07 (.68)			
Cow Eff.	113	BWt	WWt	WR	ADG	YWt	YR	Scr.	Fr.
		85	619	106	4	1191	112	36	6.5

★★★★★ for Growth, Gainability, Marbling, Rib-eye area, Calving Ease.

E-3 BECKTON EPIC T330 L5
1-A 100% # 1178840 Tattoo: BKT7 T330

Birth: 3-15-07
 Beckton Epic KJ J722
BECKTON EPIC K4 N795
 Ref. E-1 Beckton Sierra J789 EP
 Beckton Lancer T A664
BECKTON BELGA K202 LN
 Beckton Belga D460 KR
 Beckton Epic K F075
 Beckton Lana F891 JL
 Beckton Epic D404
 Beckton Sierra C157 CL
 Beckton Lancer 9380
 Beckton Coca 9119 TJ
 Beckton Kaiser FD 9253
 Beckton Belga A573 SC

DAM		Calv.Ease	BW	WW	YW	Milk	HPG	Stay	Maint.En.
Age	7	16	-6.9	13	48	15	3	13	1.4
Wt	1105	(.33)	(.61)	(.53)	(.53)	(.28)	(.20)	(.14)	(.17)
Wean Pct.	50%	Marb +0.38 (.28)		REA +0.09 (.27)		Bfat +0.00 (.40)			
Cow Eff.	106	BWt	WWt	WR	ADG	YWt	YR	Scr.	Fr.
		65	554	100	4	1183	108	35	5.5

★★★★★ for Low Maintenance, Gainability, Marbling, Calving Ease, Stayability.



Beckton Epic K4 N795

E-4 BECKTON EPIC T524 L5
1-A 100% # 1178571 Tattoo: BKT7 T524

Birth: 3-22-07
 Beckton Epic KJ J722
BECKTON EPIC K4 N795
 Ref. E-1 Beckton Sierra J789 EP
 Beckton Lancer T4 J536
BECKTON ROSE L083 LN
 Beckton Rose J152 LN
 Beckton Epic K F075
 Beckton Lana F891 JL
 Beckton Epic D404
 Beckton Sierra C157 CL
 Beckton Lancer TZ D525
 Beckton Vernice D121 VG
 Beckton Lancer TZ D525
 Beckton Rose D379 CB

DAM		Calv.Ease	BW	WW	YW	Milk	HPG	Stay	Maint.En.
Age	6	11	-3.2	19	49	16	3	14	0.3
Wt	1090	(.33)	(.45)	(.41)	(.41)	(.26)	(.17)	(.01)	(.17)
Wean Pct.	57%	Marb +0.42 (.28)		REA +0.20 (.27)		Bfat +0.10 (.38)			
Cow Eff.	121	BWt	WWt	WR	ADG	YWt	YR	Scr.	Fr.
		77	626	104	4	1124	100	37	5.5

★★★★★ for Low Maintenance, Marbling, Rib-eye area, High Cow Efficiency, Calving Ease, Stayability.

• Reference Sires •

E-5 BECKTON EMPEROR T641 E2
1-A 100% # 1178933 Tattoo: BKT7 T641

Birth: 3-31-07
 Beckton Epic K4 N795
BECKTON EMPEROR R100
 Ref. E Beckton Tamara N180 JO
 Beckton Epic KJ J722
 Beckton Sierra J789 EP
 Beckton Julio L233
 Beckton Tamara L132 CT
 Beckton Epic K3 M606
BECKTON VERNICE R416 EP
 Beckton Vernice K482 HD
 Beckton Epic KJ J722
 Beckton Lana F268 CT
 Beckton Hadrian F C486
 Beckton Vernice F513 CL

DAM		Calv.Ease	BW	WW	YW	Milk	HPG	Stay	Maint.En.
Age	2	12	-3.0	29	63	19	7	14	-0.1
Wt	930	(.29)	(.62)	(.52)	(.51)	(.24)	(.14)	(.01)	(.10)
Wean Pct.	57%	Marb +.20 (.22)		REA +.26 (.20)		Bfat +.02 (.35)			
Cow Eff.	120	BWt	WWt	WR	ADG	YWt	YR	Scr.	Fr.
		69	611	110	4	1173	110	34	5.5

★★★★★ for Low Maintenance, Growth, Gainability, Marbling, Rib-eye area, High Cow Efficiency, Calving Ease, Stayability.

E-8 BECKTON EPIC U749 D5
1-A 100% # 1259558 Tattoo: BKT8 U749

Birth: 4-9-08
 Beckton Epic KJ J722
BECKTON EPIC K4 N795
 Ref. E-1 Beckton Sierra J789 EP
 Beckton Epic K F075
 Beckton Lana F891 JL
 Beckton Epic D404
 Beckton Sierra C157 CL
 Beckton Dominor ZC M919
BECKTON DENISE R308 DM
 Beckton Denise L639 JL
 Beckton Barmaid J012 CO
 Beckton Dominor Z E401
 Beckton Julian GG B571
 Beckton Denise J550 CD

DAM		Calv.Ease	BW	WW	YW	Milk	HPG	Stay	Maint.En.
Age	3	13	-3.3	29	73	15	6	15	4.3
Wt	1025	(.29)	(.42)	(.38)	(.37)	(.24)	(.10)	(.01)	(.13)
Wean Pct.	59%	Marb +.32 (.26)		REA +.33 (.25)		Bfat +.03 (.34)			
Cow Eff.	123	BWt	WWt	WR	ADG	YWt	YR	Scr.	Fr.
		77	640	111	4	1201	112	34	5.5

★★★★★ for Growth, Gainability, Marbling, Rib-eye area, High Cow Efficiency, Calving Ease, Stayability.

E-6 BECKTON EPIC U095 E5
1-A 100% # 1259659 Tattoo: BKT8 U095

Birth: 3-1-08
 Beckton Epic KM M115
BECKTON EPIC K6 S569
 Ref. E-5 Beckton Sierra N703 LM
 Beckton Epic K F075
 Beckton Minerva F495 CH
 Beckton Laramie L044
 Beckton Sierra L887 LN
 Beckton Epic KM M115
BECKTON LYDIA S274 EP
 Beckton Lydia M607 LO
 Beckton Epic K F075
 Beckton Minerva F495 CH
 Beckton Loki F251
 Beckton Lydia J801 CD

DAM		Calv.Ease	BW	WW	YW	Milk	HPG	Stay	Maint.En.
Age	2	9	-1.1	44	93	26	8	19	3.0
Wt	915	(.25)	(.33)	(.31)	(.32)	(.20)	(.01)	(.01)	(.01)
Wean Pct.	68%	Marb +.28 (.23)		REA +.00 (.22)		Bfat +.06 (.34)			
Cow Eff.	142	BWt	WWt	WR	ADG	YWt	YR	Scr.	Fr.
		70	677	126	5	1310	129	37	5.5

★★★★★ for Low Maintenance, Growth, Gainability, Marbling, High Cow Efficiency, Calving Ease, Stayability.

E-9 TR EPIC ST618
1-A 100% # 1122033 Tattoo: TR2A6 ST61

Birth: 2-26-06
 Beckton Epic D404
BECKTON EPIC K F075
 Ref. E Beckton Belga D483 KR
 Beckton Saga KJ B702
 Beckton Kuruba B508 PC
 Beckton Kaiser FD 9253
 Beckton Belga A036 MB
 Beckton Julian GG B571
BECKTON KIT F468 JL
 Beckton Kit A517 NP
 Bkt Marta 9A13 JL
 Bkt Neptune 8460 R
 BchRch Kit935 35L416

DAM		Calv.Ease	BW	WW	YW	Milk	HPG	Stay	Maint.En.
Age	NA	10	-1.5	29	52	14	11	15	-6.8
Wt	NA	(.35)	(.71)	(.63)	(.52)	(.32)	(.22)	(.27)	(.18)
Wean Pct.	NA%	Marb +.05 (.38)		REA +.33 (.36)		Bfat +.02 (.26)			
Cow Eff.	NA	BWt	WWt	WR	ADG	YWt	YR	Scr.	Fr.
		92	647	NA	5	1323	NA	43	6.0

★★★★★ for Low Maintenance, Gainability, Rib-eye area, Calving Ease, Stayability.

E-7 BECKTON EPIC U126 J5
1-A 100% # 1259622 Tattoo: BKT8 U126

Birth: 3-5-08
 Beckton Epic KJ J722
BECKTON EPIC K7 S583
 Ref. E Beckton Kit F468 JL
 Beckton Jet L P491
BECKTON RUTH S076 JT
 Beckton Ruth P591 LN
 Beckton Epic K F075
 Beckton Lana F891 JL
 Beckton Julian GG B571
 Beckton Kit A517 NP
 TR Julian LT151
 Beckton Minerva L278 LN
 Beckton Lancer T5 L095
 Beckton Ruth E549 TP

DAM		Calv.Ease	BW	WW	YW	Milk	HPG	Stay	Maint.En.
Age	2	15	-4.8	12	26	20	8	17	-4.1
Wt	NA	(.25)	(.43)	(.37)	(.34)	(.21)	(.01)	(.01)	(.01)
Wean Pct.	NA%	Marb +.15 (.11)		REA +.18 (.11)		Bfat +.00 (.13)			
Cow Eff.	NA	BWt	WWt	WR	ADG	YWt	YR	Scr.	Fr.
		51	507	103	4	1026	108	35	5.0

★★★★★ for Low Maintenance, Gainability, Marbling, Rib-eye area, Calving Ease, Stayability.

H-1 BECKTON HERITAGE N013
1-A 100% # 916136 Tattoo: WF3 N013

Birth: 2-10-03
 Beckton Hustler CN J102
BECKTON HUSTLER C2 L079
 Ref. H Beckton Barmaid J012 CO
 Beckton Julian G1 J526
BECKTON LANA L007 JL
 Beckton Lana J790 EP
 Beckton Hustler C G407
 Beckton Belga G355 NP
 Beckton Copper JT G095
 Beckton Barmaid G565 LN
 Beckton Julian GG B571
 Beckton Annie F743 LN
 Beckton Epic K F075
 Beckton Lana F880 PL

DAM		Calv.Ease	BW	WW	YW	Milk	HPG	Stay	Maint.En.
Age	2	15	-6.4	27	54	17	10	12	0.9
Wt	975	(.57)	(.80)	(.73)	(.69)	(.53)	(.29)	(.01)	(.33)
Wean Pct.	58%	Marb +.22 (.51)		REA +.04 (.47)		Bfat +.00 (.29)			
Cow Eff.	122	BWt	WWt	WR	ADG	YWt	YR	Scr.	Fr.
		57	648	115	4	1156	114	39	5.5

★★★★★ for Low Maintenance, Marbling, High Cow Efficiency, Calving Ease.

• Reference Sires •



Beckton HalfmannHustler R588

H-4 BECKTON HERITAGE T270 J2
1-A 100% # 1178780 Tattoo: WF7 T270

Birth: 3-12-07
 Beckton Hustler C2 L079
 Beckton Hustler CN J102
BECKTON HERITAGE N013
 Ref. H Beckton Lana L007 JL
 Beckton Barmaid J012 CO
 Beckton Julian G1 J526
 Beckton Lana J790 EP
 Beckton Julian GG B571
BECKTON COCA P602 JL
 Beckton Coca J270 CD
 Beckton Julian 7526G
 Bkt Marta 9A13 JL
 Beckton Cody K G701
 Beckton Coca G809 WR

DAM		Calv.Ease	BW	WW	YW	Milk	HPG	Stay	Maint.En.
Age	3	16	-3.7	41	69	8	10	17	-2.1
Wt	1005	(.30)	(.64)	(.55)	(.54)	(.25)	(.01)	(.01)	(.13)
Wean Pct.	60%	Marb +0.45 (.27)		REA +0.14 (.25)		Bfat +0.06 (.39)			
Cow Eff.	126	BWt	WWt	WR	ADG	YWt	YR	Scr.	Fr.
		70	662	113	4	1186	107	38	5.5

★★★★★ for Low Maintenance, Growth, Gainability, Marbling, Rib-eye area, High Cow Efficiency, Calving Ease, Stayability.

H-2 BKT HALFMANNHUSTLER R588
1-A 100% # 1042326 Tattoo: BKT5 R588

Birth: 4-1-05
 Beckton Hustler C G407
BECKTON HUSTLER CN J102
 Ref. Beckton Belga G355 NP
 LCC Heaven or Bust 1000B
 Beckton Rose E032 CL
 Beckton Neptune RR B284
 Beckton Belga B061 ZN
 Beckton Clipper JM A124
BECKTON VERNICE F513 CL
 Beckton Vernice A663 PC
 Beckton Clipper J 9956
 Beckton Mona 9766 MJ
 Beckton Pacer 8940
 Bkt Vernice 8994 NM

DAM		Calv.Ease	BW	WW	YW	Milk	HPG	Stay	Maint.En.
Age	10	12	-4.5	32	67	11	7	11	5.0
Wt	1305	(.21)	(.36)	(.28)	(.29)	(.23)	(.16)	(.01)	(.16)
Wean Pct.	48%	Marb -0.11 (.30)		REA -0.04 (.28)		Bfat -0.02 (.22)			
Cow Eff.	100	BWt	WWt	WR	ADG	YWt	YR	Scr.	Fr.
		67	620	103	5	1222	111	36	6.0

★★★★★ for Growth, Gainability, Calving Ease.

H-5 BECKTON HASTEN U108 J3
1-A 100% # 1259115 Tattoo: WF8 U108

Birth: 3-3-08
 Beckton Hasten P292
BECKTON HASTEN H S462
 Ref. H-2 Beckton Lakme G128 HD
 Beckton Hustler C2 L079
 Beckton Sheba L644 CH
 Beckton Hadrian FC E166
 Beckton Lakme E373 CL
 Beckton Justice G302
BECKTON ENCINO S456 JC
 Beckton Encino J431 DM
 Beckton Julian GG B571
 Bkt Vernice 9733 PC
 Beckton Dominor Z E401
 Beckton Encino C644 ZN

DAM		Calv.Ease	BW	WW	YW	Milk	HPG	Stay	Maint.En.
Age	2	15	-3.9	27	56	11	11	14	-4.6
Wt	815	(.26)	(.45)	(.39)	(.38)	(.20)	(.01)	(.01)	(.01)
Wean Pct.	62%	Marb +0.01 (.23)		REA -0.02 (.22)		Bfat +0.02 (.35)			
Cow Eff.	130	BWt	WWt	WR	ADG	YWt	YR	Scr.	Fr.
		70	564	105	4	1120	110	34	5.5

★★★★★ for Low Maintenance, Gainability, High Cow Efficiency, Calving Ease, Stayability.

H-3 BECKTON HASTEN H S462
1-A 100% # 1118925 Tattoo: BKT6 S462

Birth: 3-19-06
 Beckton Hustler C2 L079
BECKTON HASTEN P292
 Ref. Beckton Sheba L644 CH
 Beckton Hustler CN J102
 Beckton Barmaid J012 CO
 Beckton Champ R3 H338
 Beckton Sheba CB73 JL
 Beckton Hadrian FC E166
BECKTON LAKME G128 HD
 Beckton Lakme E373 CL
 Beckton Hadrian F C486
 Bkt Pine Marie C046 CH
 Beckton Clipper KT C624
 Beckton Lakme C030 HB

DAM		Calv.Ease	BW	WW	YW	Milk	HPG	Stay	Maint.En.
Age	9	17	-6.6	23	49	20	9	11	-0.7
Wt	1100	(.41)	(.66)	(.58)	(.59)	(.35)	(.14)	(.13)	(.25)
Wean Pct.	62%	Marb -0.28 (.31)		REA +0.07 (.29)		Bfat +0.02 (.43)			
Cow Eff.	129	BWt	WWt	WR	ADG	YWt	YR	Scr.	Fr.
		76	676	115	4	1200	108	36	5.5

★★★★★ for Low Maintenance, Gainability, High Cow Efficiency, Calving Ease.

J-1 BECKTON JULIAN GG B571
1-A 100% # 387580 Tattoo: WF2 B571

Birth: 3-27-92
 Beckton Julian 6592
BECKTON JULIAN 7526G
 Ref. Bkt Belga 6746 GS
 Beckton Trojan 5253
 Lchmn Christy 2339
 Beckton Gisa 4454
 Beckton Lalaxigu -2
 Beckton Julian 6592
 Bkt Belga 6746 GS
 Beckton Julian 7526G
BKT MARTA 9A13 JL
 Bkt Marta 6498 XM
 Beckton Xime 4736
 Beckton Marwa -K

DAM		Calv.Ease	BW	WW	YW	Milk	HPG	Stay	Maint.En.
Age	3	19	-5.9	29	56	15	5	24	-7.0
Wt	1015	(.90)	(.92)	(.91)	(.91)	(.90)	(.76)	(.70)	(.62)
Wean Pct.	56%	Marb +0.10 (.72)		REA +0.48 (.69)		Bfat +0.02 (.58)			
Cow Eff.	118	BWt	WWt	WR	ADG	YWt	YR	Scr.	Fr.
		65	627	113	3	1140	112	NA	5.0

★★★★★ for Low Maintenance, Rib-eye area, High Cow Efficiency, Calving Ease, Stayability.

• Reference Sires •

J-2 **BECKTON JULES L429**
1-A 100% # 793522 Tattoo: BKT1 L429

Birth: 3-18-01
 Beckton Julian GG B571
BECKTON JULIAN G1 J526
 Ref. J
 Beckton Annie F743 LN
 Beckton Julian 7526G
 Bkt Marta 9A13 JL
 Beckton Lancer T A664
 Beckton Annie C132 NP
 Beckton Epic D404
 Beckton Belga D483 KR
 Beckton Epic K F075
BECKTON BARONA J591 EP
 Beckton Barona E134 RN
 Beckton Ranger 9479R
 Beckton Barona A842 DM

DAM		Calv.Ease	BW	WW	YW	Milk	HPG	Stay	Maint.En.
Age	2	16	-6.7	20	39	17	5	12	.0
Wt	890	(.58)	(.78)	(.71)	(.68)	(.57)	(.28)	(.01)	(.46)
Wean Pct.	54%	Marb -.02 (.46)		REA +1.14 (.42)		Bfat +.01 (.26)			
Cow Eff.	113	BWt	WWt	WR	ADG	YWt	YR	Scr.	Fr.
		63	551	115	3	1041	113	34	5.0

★★★★★ for Low Maintenance, Rib-eye area, Calving Ease.

J-5 **BECKTON JET U473 L2**
1-A 100% # 1259454 Tattoo: BKT8 U473

Birth: 3-22-08
 TR Julian LT151
BECKTON JET L P491
 Ref. J-2
 Beckton Minerva L278 LN
 Beckton Julian GG B571
 MS Geometric 917
 Beckton Lancer TS D390
 Beckton Minerva F495 CH
 Beckton Lancer T4 J536
 Beckton Sierra J659 DM
 Beckton Laramie L044
BECKTON LYDIA N047 LM
 Beckton Lydia L647 JL
 Beckton Lydia J153 G
 Beckton Lydia D559 CF

DAM		Calv.Ease	BW	WW	YW	Milk	HPG	Stay	Maint.En.
Age	5	12	-2.1	35	70	23	8	18	0.6
Wt	1070	(.29)	(.44)	(.42)	(.41)	(.25)	(.01)	(.01)	(.14)
Wean Pct.	62%	Marb +.42 (.26)		REA +1.19 (.25)		Bfat +.06 (.37)			
Cow Eff.	131	BWt	WWt	WR	ADG	YWt	YR	Scr.	Fr.
		70	664	114	5	1260	115	38	5.5

★★★★★ for Low Maintenance, Growth, Gainability, Marbling, Rib-eye area, High Cow Efficiency, Calving Ease, Stayability.

J-3 **BECKTON JULIAN G3 P608**
1-A 100% # 978932 Tattoo: WF4 P608

Birth: 3-27-04
 Beckton Julian 7526G
BECKTON JULIAN GG B571
 Ref. J-1
 Bkt Marta 9A13 JL
 Beckton Julian 7526G
 Bkt Marta 6498 XM
 Beckton Dominor 9455
BKT SUFFEINA A828 DM
 Bkt Suffeina 9493 TT
 Beckton Dorado 8411V
 Bkt Firefly 8734 DR
 Beckton Titan 7965
 Bch Rch Claudia 2140

DAM		Calv.Ease	BW	WW	YW	Milk	HPG	Stay	Maint.En.
Age	13	20	-7.4	12	41	13	12	17	-7.1
Wt	NA	(.66)	(.80)	(.75)	(.73)	(.66)	(.24)	(.30)	(.47)
Wean Pct.	NA%	Marb +.19 (.51)		REA +.07 (.48)		Bfat +.01 (.35)			
Cow Eff.	NA	BWt	WWt	WR	ADG	YWt	YR	Scr.	Fr.
		72	627	106	4	1159	111	35	5.0

★★★★★ for Low Maintenance, Marbling, Calving Ease, Stayability.

J-6 **BECKTON JULIAN U699 L5**
1-A 100% # 1259409 Tattoo: BKT8 U699

Birth: 4-4-08
 Beckton Julian GG B571
BECKTON JULIAN G1 J526
 Ref. J
 Beckton Annie F743 LN
 Beckton Julian 7526G
 Bkt Marta 9A13 JL
 Beckton Lancer T A664
 Beckton Annie C132 NP
 Beckton Lancer T A664
 Bkt Suffeina A828 DM
 Beckton Lancer F442 T
BECKTON ROSE L311 LN
 Beckton Rose H292 HD
 Beckton Hadrian F C486
 Beckton Rose A528 PC

DAM		Calv.Ease	BW	WW	YW	Milk	HPG	Stay	Maint.En.
Age	7	16	-4.8	37	63	10	8	16	-6.3
Wt	1115	(.31)	(.41)	(.40)	(.39)	(.26)	(.20)	(.23)	(.18)
Wean Pct.	61%	Marb +.15 (.28)		REA +.05 (.28)		Bfat +.01 (.38)			
Cow Eff.	128	BWt	WWt	WR	ADG	YWt	YR	Scr.	Fr.
		74	676	110	4	1170	106	39	5.0

★★★★★ for Low Maintenance, Growth, Gainability, Marbling, High Cow Efficiency, Calving Ease, Stayability.

J-4 **BECKTON JULIAN G5 S107**
1-A 100% # 1118570 Tattoo: WF6 S107

Birth: 2-21-06
 Beckton Julian 7526G
BECKTON JULIAN GJ P535
 Ref. J
 Beckton Mona D086 JL
 Beckton Julian 6592
 Bkt Belga 6746 GS
 Beckton Julian GV Z693
 Beckton Mona 9356 KR
 Beckton Dominor ZC M919
BECKTON MINOLA P826 DM
 Beckton Minola M641 WR
 Beckton Dominor Z E401
 Beckton Barmaid J012 CO
 Beckton Warrior T C371
 Beckton Minola H170 JL

DAM		Calv.Ease	BW	WW	YW	Milk	HPG	Stay	Maint.En.
Age	2	10	-0.6	32	69	11	12	19	0.3
Wt	1010	(.39)	(.69)	(.59)	(.60)	(.31)	(.01)	(.01)	(.11)
Wean Pct.	55%	Marb +.28 (.26)		REA +.11 (.23)		Bfat +.10 (.39)			
Cow Eff.	116	BWt	WWt	WR	ADG	YWt	YR	Scr.	Fr.
		74	640	115	4	1237	113	43	4.5

★★★★★ for Low Maintenance, Growth, Gainability, Marbling, High Cow Efficiency, Calving Ease, Stayability.

J-7 **TR JULIAN LT142**
1-A 100% # 785183 Tattoo: TR2A1 LT14

Birth: 2-21-01
 BKT Julian 7526 G
BECKTON JULIAN GG B571
 Ref.
 BKT Marta 9A13 JL
 Beckton Julian 6592
 BKT Belga 6746 GS
 BKT Julian 7526 G
 BKT Marta 6498 XM
 Beckton Cody V E023
TR LANA G760
 Beckton Lana E828 SC
 Beckton Cody C401
 Beckton Birdie C353 VG
 Beckton Scamp 8954
 Beckton Lana B695 SG

DAM		Calv.Ease	BW	WW	YW	Milk	HPG	Stay	Maint.En.
Age	4	25	-6.1	29	52	19	19	16	-5.2
Wt	NA	(.83)	(.87)	(.86)	(.86)	(.82)	(.71)	(.40)	(.60)
Wean Pct.	NA%	Marb +.07 (.77)		REA +.07 (.76)		Bfat +.02 (.80)			
Cow Eff.	NA	BWt	WWt	WR	ADG	YWt	YR	Scr.	Fr.
		76	782	113	3	1215	112	36	5.0

★★★★★ for Low Maintenance, Calving Ease, Stayability.

• Reference Sires •

J-8 **TR JULIAN LT151**
1-A 100% # 785157 Tattoo: TR2A1 LT15

Birth: 2-16-01

BKT Julian 7526 G
BECKTON JULIAN GG B571
Ref. BKT Marta 9A13 JL

BJR Yo 121
MS GEOMETRIC 917
MS Geometric

Beckton Julian 6592
BKT Belga 6746 GS
BKT Julian 7526 G
BKT Marta 6498 XM
BJR Yogo 002-104
BJR Cherabel830-8319
Lchmn No Equal 1174D
MS Geometric 363

Calv.Ease	BW	WW	YW	Milk	HPG	Stay	Maint.En.
17	-3.8	34	67	11	11	14	7.3
(.74)	(.78)	(.77)	(.77)	(.73)	(.59)	(.39)	(.54)

DAM	
Age	2
Wt	NA
Wean Pct.	NA%
Cow Eff.	NA

Marb	REA	Bfat
+0.45	+0.11	+0.01
(.69)	(.68)	(.73)

BWt	WWt	WR	ADG	YWt	YR	Scr.	Fr.
79	739	114	3	1148	106	36	5.5

★★★★★ for Growth, Marbling, Calving Ease, Stayability.



Beckton Lancer F442 T



Tongue River Julian ST630

J-10 **TR JULIUS ST633**
1-A 100% # 1121929Tattoo: TR2A6 ST63

Birth: 3-26-06

Beckton Julian 7526G
BECKTON JULIUS M213
Ref. Beckton Lana H128 HR

Beckton Julian 6592
Bkt Belga 6746 GS
Beckton Herald F FA20
Beckton Lana F176 RE

Calv.Ease	BW	WW	YW	Milk	HPG	Stay	Maint.En.
9	.0	38	72	16	9	15	-2.0
(.16)	(.35)	(.25)	(.20)	(.16)	(.01)	(.01)	(.01)

DAM	
Age	4
Wt	NA
Wean Pct.	NA%
Cow Eff.	NA

Marb	REA	Bfat
+0.07	+0.05	+0.01
(.01)	(.01)	(.01)

BWt	WWt	WR	ADG	YWt	YR	Scr.	Fr.
87	686	109	4	1308	111	37	6.5

★★★★★ for Low Maintenance, Growth, Gainability, Calving Ease, Stayability.

J-9 **TR JULIAN ST630**
1-A 100% # 1121975Tattoo: TR2A6 ST63

Birth: 2-21-06

BKT Julian 7526 G
BECKTON JULIAN GG B571
Ref. BKT Marta 9A13 JL

BJR Make My Day 981
MS GEOMETRIC 003
MS Geometric 277

Beckton Julian 6592
BKT Belga 6746 GS
BKT Julian 7526 G
BKT Marta 6498 XM
BJR Easy Rider 781
BJR Tow Kana 117-710
BKT Julian 7526 G
MS Geometric 962

Calv.Ease	BW	WW	YW	Milk	HPG	Stay	Maint.En.
17	-3.1	25	51	11	11	16	2.4
(.36)	(.59)	(.52)	(.51)	(.30)	(.13)	(.20)	(.16)

DAM	
Age	6
Wt	NA
Wean Pct.	NA%
Cow Eff.	NA

Marb	REA	Bfat
-0.01	+0.09	+0.01
(.30)	(.28)	(.39)

BWt	WWt	WR	ADG	YWt	YR	Scr.	Fr.
76	690	NA	4	1303	NA	NA	6.5

★★★★★ for Low Maintenance, Calving Ease, Stayability.

L-1 **BECKTON LANCER F442 T**
1-A 100% # 533603 Tattoo: WF6 F442

Birth: 3-19-96

Beckton Lancer 9380
BECKTON LANCER T A664
Ref. Beckton Coca 9119 TJ

Beckton Trojan 5253
Bkt Kilo Lana 4251
Beckton Trojan 7061P
Beckton Coca 7536 SB

Beckton Dominor 9455
BKT SUFFEINA A828 DM
Bkt Suffeina 9493 TT

Beckton Dorado 8411V
Bkt Firefly 8734 DR
Beckton Titan 7965
Bch Rch Claudia 2140

Calv.Ease	BW	WW	YW	Milk	HPG	Stay	Maint.En.
11	-0.4	32	51	7	3	10	.0
(.90)	(.94)	(.93)	(.92)	(.89)	(.73)	(.27)	(.61)

DAM	
Age	5
Wt	1210
Wean Pct.	52%
Cow Eff.	108

Marb	REA	Bfat
+0.27	+0.49	-0.03
(.80)	(.76)	(.69)

BWt	WWt	WR	ADG	YWt	YR	Scr.	Fr.
82	623	112	3	1084	109	37	5.5

★★★★★ for Low Maintenance, Marbling, Rib-eye area, Calving Ease.

• Reference Sires •

L-2 BECKTON LOKI CL S284
1-A 100% # 1118747 Tattoo: BKT6 S284

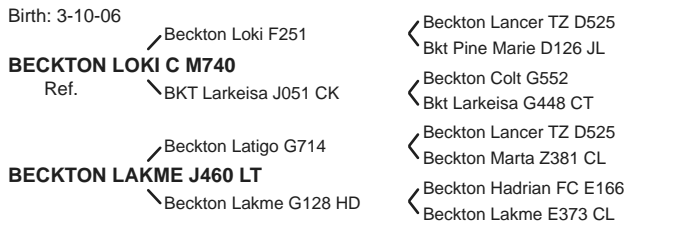

DAM		Calv.Ease	BW	WW	YW	Milk	HPG	Stay	Maint.En.
Age	7	16	-6.0	25	55	15	2	14	4.7
Wt	1160	(.50)	(.71)	(.65)	(.65)	(.45)	(.30)	(.14)	(.34)
Wean Pct.	55%	Marb +0.3 (.31)		REA -0.5 (.29)		Bfat +0.1 (.43)			
Cow Eff.	116	BWt	WWt	WR	ADG	YWt	YR	Scr.	Fr.
		82	640	109	4	1198	103	39	6.0

★★★★★ for High Cow Efficiency, Calving Ease, Stayability.

L-5 BECKTON LIKABLE U120 L2
1-A 100% # 1258806 Tattoo: BKT8 U120

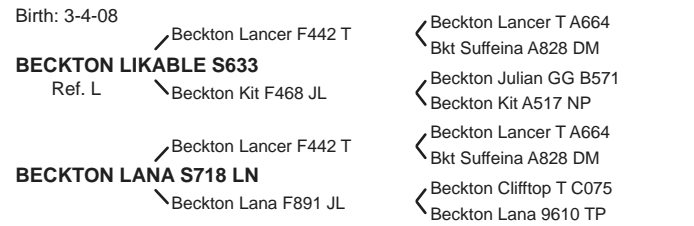

DAM		Calv.Ease	BW	WW	YW	Milk	HPG	Stay	Maint.En.
Age	2	10	-1.3	29	54	6	6	21	-2.1
Wt	1010	(.26)	(.45)	(.42)	(.40)	(.22)	(.01)	(.01)	(.10)
Wean Pct.	53%	Marb +0.24 (.22)		REA +0.74 (.22)		Bfat +0.02 (.33)			
Cow Eff.	111	BWt	WWt	WR	ADG	YWt	YR	Scr.	Fr.
		67	594	104	4	1069	103	35	5.5

★★★★★ for Low Maintenance, Gainability, Marbling, Rib-eye area, Calving Ease, Stayability.

L-3 BECKTON LEGEND S670
1-A 100% # 1119132 Tattoo: WF6 S670

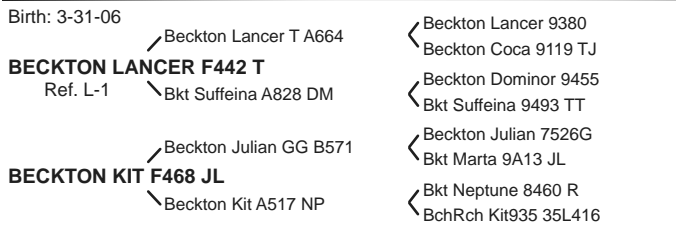

DAM		Calv.Ease	BW	WW	YW	Milk	HPG	Stay	Maint.En.
Age	10	13	-2.7	22	38	6	11	16	-6.4
Wt	NA	(.53)	(.62)	(.57)	(.56)	(.47)	(.35)	(.28)	(.32)
Wean Pct.	NA%	Marb +0.48 (.28)		REA +0.50 (.27)		Bfat +0.03 (.31)			
Cow Eff.	NA	BWt	WWt	WR	ADG	YWt	YR	Scr.	Fr.
		76	523	89	4	1017	94	36	5.0

★★★★★ for Low Maintenance, Marbling, Rib-eye area, Calving Ease, Stayability.

L-6 BECKTON LIKABLE U130 L2
1-A 100% # 1258774 Tattoo: BKT8 U130

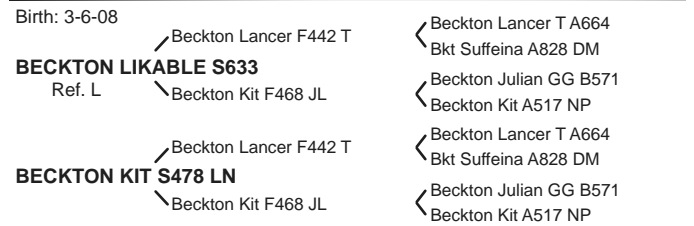

DAM		Calv.Ease	BW	WW	YW	Milk	HPG	Stay	Maint.En.
Age	2	13	-2.8	24	49	8	9	23	-7.4
Wt	875	(.26)	(.41)	(.39)	(.38)	(.22)	(.01)	(.01)	(.10)
Wean Pct.	54%	Marb +0.04 (.23)		REA +0.72 (.22)		Bfat +0.04 (.34)			
Cow Eff.	115	BWt	WWt	WR	ADG	YWt	YR	Scr.	Fr.
		68	536	100	4	1059	104	35	5.0

★★★★★ for Low Maintenance, Rib-eye area, Calving Ease, Stayability.

L-4 BECKTON LANCER T371 H4
1-A 100% # 1178419 Tattoo: BKT7 T371

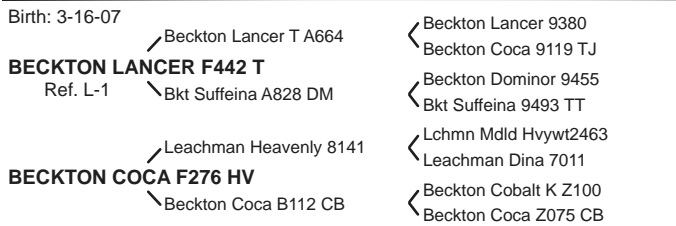

DAM		Calv.Ease	BW	WW	YW	Milk	HPG	Stay	Maint.En.
Age	11	12	-2.6	31	57	11	6	13	-1.3
Wt	1245	(.33)	(.65)	(.57)	(.55)	(.29)	(.22)	(.28)	(.19)
Wean Pct.	55%	Marb -0.03 (.31)		REA +0.24 (.30)		Bfat -0.01 (.41)			
Cow Eff.	116	BWt	WWt	WR	ADG	YWt	YR	Scr.	Fr.
		89	722	126	4	1292	118	37	5.5

★★★★★ for Low Maintenance, Gainability, Rib-eye area, High Cow Efficiency, Calving Ease, Stayability.

L-7 BECKTON LEGEND U331 E2
1-A 100% # 1258800 Tattoo: BKT8 U331

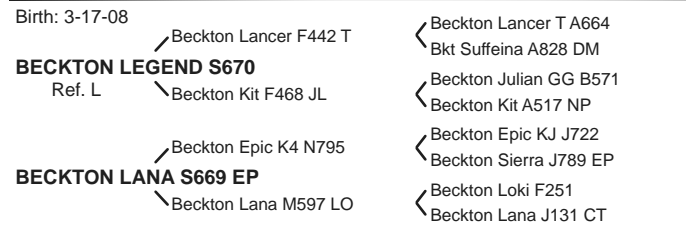

DAM		Calv.Ease	BW	WW	YW	Milk	HPG	Stay	Maint.En.
Age	2	15	-5.2	16	40	14	5	19	-0.8
Wt	955	(.27)	(.41)	(.37)	(.36)	(.21)	(.01)	(.01)	(.10)
Wean Pct.	49%	Marb +0.81 (.22)		REA +0.29 (.21)		Bfat +0.07 (.34)			
Cow Eff.	103	BWt	WWt	WR	ADG	YWt	YR	Scr.	Fr.
		57	526	98	4	1026	101	33	5.0

★★★★★ for Low Maintenance, Gainability, Marbling, Rib-eye area, Calving Ease, Stayability.

• Reference Sires •



Beckton Nebula M045

N-3 **BECKTON NEBULA L P093**
1-A 100% # 978419 Tattoo: WF4 P093

Birth: 2-28-04
 Beckton Neptune R2 K065
BECKTON NEBULA M045
 Ref. N-1 Beckton Belga K285 JL
 Beckton Neptune RR B284
 Beckton Lana C735 TP
 Beckton Julian GG B571
 Beckton Belga G493 HR
 Beckton Lancer TA K644
BECKTON MARTA M021 LN
 Beckton Marta K254 LN
 Beckton Lancer T A664
 Beckton Tamara B570 JL
 Beckton Lancer T A664
 Beckton Marta G512 LN

Calv.Ease	BW	WW	YW	Milk	HPG	Stay	Maint.En.		
13	-2.8	36	71	2	11	11	-3.5		
(.71)	(.81)	(.78)	(.79)	(.68)	(.35)	(.14)	(.44)		
DAM		Age	2	Marb	+0.26	REA	+0.08	Bfat	+0.00
Age		Wt	775	RE		YR		Scr.	
Wean Pct.		63%		ADG		YR		Fr.	
Cow Eff.		132		ADG	4	YR	1067	Fr.	5.5
BWt	69	WWt	560	WR	101	YR	105	Scr.	35

★★★★★ for Low Maintenance, Marbling, High Cow Efficiency, Calving Ease.

N-1 **BECKTON NEBULA M045**
1-A 100% # 854775 Tattoo: BKT2 M045

Birth: 2-19-02
 Beckton Neptune RR B284
BECKTON NEPTUNE R2 K065
 Ref. Beckton Lana C735 TP
 Beckton Julian GG B571
BECKTON BELGA K285 JL
 Beckton Belga G493 HR
 Bkt Neptune 8460 R
 Beckton Eola 8600 RR
 RDD B Topper 1675
 Beckton Lana A714 TR
 Beckton Julian 7526G
 Bkt Marta 9A13 JL
 Beckton Herald K B244
 Beckton Belga D776 CL

Calv.Ease	BW	WW	YW	Milk	HPG	Stay	Maint.En.		
21	-7.2	25	56	11	11	10	-6.8		
(.80)	(.87)	(.85)	(.85)	(.78)	(.59)	(.29)	(.58)		
DAM		Age	2	Marb	+0.28	REA	-0.31	Bfat	+0.05
Age		Wt	860	RE		YR		Scr.	
Wean Pct.		59%		ADG		YR		Fr.	
Cow Eff.		125		ADG	4	YR	1080	Fr.	5.0
BWt	59	WWt	586	WR	108	YR	4	Scr.	35

★★★★★ for Low Maintenance, Marbling, High Cow Efficiency, Calving Ease.



Beckton Nebula L P093

N-2 **BECKTON NEBULA E P084**
1-A 100% # 978410 Tattoo: BKT4 P084

Birth: 2-27-04
 Beckton Neptune R2 K065
BECKTON NEBULA M045
 Ref. N-1 Beckton Belga K285 JL
 Beckton Epic K F075
BKT PINE MARIE M119 EP
 Bkt Pine Marie D126 JL
 Beckton Neptune RR B284
 Beckton Lana C735 TP
 Beckton Julian GG B571
 Beckton Belga G493 HR
 Beckton Epic D404
 Beckton Belga D483 KR
 Beckton Julian GG B571
 Bkt Pine Marie B849 JL

Calv.Ease	BW	WW	YW	Milk	HPG	Stay	Maint.En.		
21	-8.2	13	35	16	6	16	-7.3		
(.62)	(.70)	(.66)	(.67)	(.58)	(.37)	(.14)	(.42)		
DAM		Age	2	Marb	+0.53	REA	-0.24	Bfat	+0.07
Age		Wt	885	RE		YR		Scr.	
Wean Pct.		55%		ADG		YR		Fr.	
Cow Eff.		116		ADG	3	YR	1023	Fr.	4.0
BWt	54	WWt	559	WR	100	YR	3	Scr.	33

★★★★★ for Low Maintenance, Marbling, Calving Ease, Stayability.

N-4 **BECKTON NEBULA P P707**
1-A 100% # 979031 Tattoo: BKT4 P707

Birth: 4-1-04
 Beckton Neptune R2 K065
BECKTON NEBULA M045
 Ref. N-1 Beckton Belga K285 JL
 Beckton Epic K1 K863
BECKTON LANA M809 EP
 Beckton Lana K253 DM
 Beckton Neptune RR B284
 Beckton Lana C735 TP
 Beckton Julian GG B571
 Beckton Belga G493 HR
 Beckton Epic KN H110
 Beckton Rose H019 SC
 Beckton Dominor ZJ H657
 Beckton Lana HA34 DM

Calv.Ease	BW	WW	YW	Milk	HPG	Stay	Maint.En.		
18	-5.9	33	64	19	8	12	-11.6		
(.62)	(.75)	(.71)	(.69)	(.59)	(.32)	(.14)	(.44)		
DAM		Age	2	Marb	+0.53	REA	-0.05	Bfat	+0.02
Age		Wt	890	RE		YR		Scr.	
Wean Pct.		71%		ADG		YR		Fr.	
Cow Eff.		150		ADG	4	YR	1265	Fr.	5.0
BWt	68	WWt	728	WR	127	YR	4	Scr.	37

★★★★★ for Low Maintenance, Growth, Marbling, High Cow Efficiency, Calving Ease.

• Reference Sires •

N-5 BECKTON NEBULA G S237
1-A 100% # 1118700 Tattoo: WF6 S237

Birth: 3-6-06
 Beckton Neptune R2 K065
BECKTON NEBULA M045
 Ref. N-1 Beckton Belga K285 JL
 Beckton Julian GG B571
BECKTON LAKME LA06 JL
 Beckton Lakme B370 HV
 Beckton Neptune RR B284
 Beckton Lana C735 TP
 Beckton Julian GG B571
 Beckton Belga G493 HR
 Beckton Julian 7526G
 Bkt Marta 9A13 JL
 Leachman Heavenly 8141
 Beckton Lakme 9211DT

Calv.Ease	BW	WW	YW	Milk	HPG	Stay	Maint.En.
20	-5.8	19	44	11	10	13	-8.1
(.47)	(.67)	(.60)	(.61)	(.42)	(.20)	(.15)	(.26)

DAM	
Age	5
Wt	998
Wean Pct.	52%
Cow Eff.	110

Marb	REA	Bfat
+33	-.16	+00
(.31)	(.30)	(.43)

BWt	WWt	WR	ADG	YWt	YR	Scr.	Fr.
63	519	88	4	1036	96	39	5.0

★★★★★ for Low Maintenance, Gainability, Marbling, Calving Ease, Stayability.

N-7 BECKTON NEBULA T054 H3
1-A 100% # 1178349 Tattoo: BKT7 T054

Birth: 2-18-07
 Beckton Nebula M045
BECKTON NEBULA J R475
 Ref. N-5 Beckton Larkeisa M138 JC
 Beckton Hustler C2 L079
BKT PINE MARIE R401 HU
 Bkt Pine Marie LC30 CD
 Beckton Neptune R2 K065
 Beckton Belga K285 JL
 Beckton Justice G302
 Bkt Larkeisa G448 CT
 Beckton Hustler CN J102
 Beckton Barmaid J012 CO
 Beckton Cody V E023
 Bkt Pine Marie D764 HD

Calv.Ease	BW	WW	YW	Milk	HPG	Stay	Maint.En.
17	-4.9	25	54	9	13	14	-3.6
(.29)	(.59)	(.50)	(.51)	(.24)	(.01)	(.01)	(.11)

DAM	
Age	2
Wt	995
Wean Pct.	44%
Cow Eff.	93

Marb	REA	Bfat
+23	+.41	+01
(.20)	(.18)	(.33)

BWt	WWt	WR	ADG	YWt	YR	Scr.	Fr.
67	507	91	5	1135	106	35	5.0

★★★★★ for Low Maintenance, Gainability, Marbling, Rib-eye area, Calving Ease, Stayability.

N-6 BECKTON NEBULA PJ S543
1-A 100% # 1119006 Tattoo: BKT6 S543

Birth: 3-23-06
 Beckton Nebula M045
BECKTON NEBULA P P707
 Ref. N-3 Beckton Lana M809 EP
 Beckton Julio L233
BECKTON LANA P685 JO
 Beckton Lana E083 CD
 Beckton Neptune R2 K065
 Beckton Belga K285 JL
 Beckton Epic K1 K863
 Beckton Lana K253 DM
 Beckton Julian G1 J526
 Beckton Rose J725 EP
 Beckton Cody C401
 Beckton Lana C220 CL

Calv.Ease	BW	WW	YW	Milk	HPG	Stay	Maint.En.
17	-5.8	35	73	15	4	14	-0.8
(.49)	(.70)	(.63)	(.63)	(.42)	(.27)	(.01)	(.25)

DAM	
Age	2
Wt	1000
Wean Pct.	58%
Cow Eff.	121

Marb	REA	Bfat
+34	+.09	+01
(.28)	(.25)	(.40)

BWt	WWt	WR	ADG	YWt	YR	Scr.	Fr.
68	661	126	4	1216	120	35	6.5

★★★★★ for Low Maintenance, Growth, Gainability, Marbling, High Cow Efficiency, Calving Ease, Stayability.

N-8 BECKTON NEBULA T269 E2
1-A 100% # 1178779 Tattoo: BKT7 T269

Birth: 3-12-07
 Beckton Neptune R2 K065
BECKTON NEBULA M045
 Ref. N-1 Beckton Belga K285 JL
 Beckton Epic KN H110
BECKTON RUTH M967 EP
 Beckton Ruth A905 SG
 Beckton Neptune RR B284
 Beckton Lana C735 TP
 Beckton Julian GG B571
 Beckton Belga G493 HR
 Beckton Epic K F075
 Beckton Tara F633 NM
 Beckton Saga K 9731
 Beckton Ruth 9A57 VK

Calv.Ease	BW	WW	YW	Milk	HPG	Stay	Maint.En.
14	-3.0	24	58	17	11	14	-7.6
(.32)	(.64)	(.54)	(.53)	(.27)	(.11)	(.01)	(.16)

DAM	
Age	5
Wt	1055
Wean Pct.	50%
Cow Eff.	104

Marb	REA	Bfat
+30	+.13	+06
(.28)	(.27)	(.40)

BWt	WWt	WR	ADG	YWt	YR	Scr.	Fr.
75	522	94	4	1145	105	37	5.5

★★★★★ for Low Maintenance, Gainability, Marbling, Rib-eye area, Calving Ease, Stayability.



Beckton Nebula P707

N-9 BECKTON NEBULA T398 V3
1-A 100% # 1178446 Tattoo: BKT7 T398

Birth: 3-17-07
 Beckton Nebula M045
BECKTON NEBULA L P093
 Ref. N-2 Beckton Marta M021 LN
 Beckton Vegas PK F485
BECKTON MINERVA J615 VG
 Beckton Minerva F433 VG
 Beckton Neptune R2 K065
 Beckton Belga K285 JL
 Beckton Lancer TA K644
 Beckton Marta K254 LN
 Beckton Vegas P D462
 Beckton Lakme D399 KR
 Beckton Vegas 9433
 Beckton Minerva C556 SC

Calv.Ease	BW	WW	YW	Milk	HPG	Stay	Maint.En.
13	-3.1	29	64	15	8	12	-4.8
(.33)	(.64)	(.54)	(.54)	(.27)	(.15)	(.13)	(.16)

DAM	
Age	8
Wt	1175
Wean Pct.	52%
Cow Eff.	110

Marb	REA	Bfat
+14	+.15	+01
(.26)	(.25)	(.38)

BWt	WWt	WR	ADG	YWt	YR	Scr.	Fr.
77	611	110	4	1234	113	40	6.0

★★★★★ for Low Maintenance, Growth, Gainability, Marbling, Rib-eye area, Calving Ease.

• Reference Sires •

N-10 BECKTON NEBULA U031 D3
1-A 100% # 1258770 Tattoo: BKT8 U031

Birth: 2-20-08
 Beckton Nebula M045
BECKTON NEBULA G S237
 Ref. N-6
 Beckton Lakme LA06 JL
 Beckton Neptune R2 K065
 Beckton Belga K285 JL
 Beckton Julian GG B571
 Beckton Lakme B370 HV
 Beckton Dominor Z E401
 Beckton Barmaid J012 CO
BECKTON MARTA S459 DM
 Beckton Dominor ZC M919
 Beckton Marta G675 LN
 Beckton Lancer T A664
 Bkt Marta 9A13 JL

Calv.Ease	BW	WW	YW	Milk	HPG	Stay	Maint.En.
17	-4.0	32	69	11	10	19	-3.7
(.28)	(.44)	(.39)	(.38)	(.21)	(.01)	(.01)	(.01)

DAM	
Age	2
Wt	900
Wean Pct.	56%
Cow Eff.	118

Marb	REA	Bfat
+41	-.13	-.01
(.22)	(.22)	(.33)

BWt	WWt	WR	ADG	YWt	YR	Scr.	Fr.
69	563	99	4	1112	107	35	5.5

★★★★★ for Low Maintenance, Growth, Gainability, Marbling, High Cow Efficiency, Calving Ease, Stayability.

N-13 TR NEBULA TT779
1-A 100% # 1183333 Tattoo: TR2A7 TT77

Birth: 2-18-07
 Beckton Neptune R2 K065
BECKTON NEBULA M045
 Ref.
 Beckton Belga K285 JL
 Beckton Neptune RR B284
 Beckton Lana C735 TP
 Beckton Julian GG B571
 Beckton Belga G493 HR
 Beckton Lancer TS D390
 Beckton Tara D565 CB
TR LYDIA MT244
 Beckton Lancer F134 TS
 Beckton Lydia E251 CL
 Beckton Clipper ER C360
 Beckton Lydia C180 CF

Calv.Ease	BW	WW	YW	Milk	HPG	Stay	Maint.En.
14	-1.9	41	75	13	11	12	-2.8
(.30)	(.53)	(.46)	(.46)	(.26)	(.20)	(.01)	(.15)

DAM	
Age	5
Wt	1240
Wean Pct.	58%
Cow Eff.	NA

Marb	REA	Bfat
+21	-.29	+03
(.31)	(.28)	(.40)

BWt	WWt	WR	ADG	YWt	YR	Scr.	Fr.
79	721	117	3	1263	110	NA	NA

★★★★★ for Low Maintenance, Growth, Marbling, Calving Ease.

N-11 BECKTON NEBULA U060 N4
1-A 100% # 1259084 Tattoo: WF8 U060

Birth: 2-26-08
 Beckton Nebula P P707
BECKTON NEBULA PJ S543
 Ref. N-8
 Beckton Lana P685 JO
 Beckton Nebula M045
 Beckton Lana M809 EP
 Beckton Julio L233
 Beckton Lana E083 CD
 Beckton Nebula M045
 Beckton Lana M809 EP
BECKTON BIRDIE S110 NB
 Beckton Nebula P P707
 Beckton Birdie P086 WR
 Beckton Warrior CL M686
 Beckton Birdie M877 LO

Calv.Ease	BW	WW	YW	Milk	HPG	Stay	Maint.En.
18	-6.0	27	57	18	6	15	-8.9
(.27)	(.42)	(.39)	(.38)	(.21)	(.01)	(.01)	(.01)

DAM	
Age	2
Wt	815
Wean Pct.	62%
Cow Eff.	131

Marb	REA	Bfat
+39	+03	+02
(.23)	(.22)	(.34)

BWt	WWt	WR	ADG	YWt	YR	Scr.	Fr.
52	565	99	4	1037	100	35	5.0

★★★★★ for Low Maintenance, Marbling, High Cow Efficiency, Calving Ease, Stayability.



Tongue River Nebula TT779

N-12 BECKTON NEBULA U206 V3
1-A 100% # 1259389 Tattoo: BKT8 U206

Birth: 3-12-08
 Beckton Nebula M045
BECKTON NEBULA P P707
 Ref. N-3
 Beckton Lana M809 EP
 Beckton Neptune R2 K065
 Beckton Belga K285 JL
 Beckton Epic K1 K863
 Beckton Lana K253 DM
 Beckton Vegas P D462
 Beckton Lakme D399 KR
BECKTON MINERVA J615 VG
 Beckton Vegas PK F485
 Beckton Minerva F433 VG
 Beckton Vegas 9433
 Beckton Minerva C556 SC

Calv.Ease	BW	WW	YW	Milk	HPG	Stay	Maint.En.
12	-2.1	38	71	19	7	13	-9.1
(.31)	(.47)	(.43)	(.41)	(.26)	(.14)	(.12)	(.16)

DAM	
Age	9
Wt	1090
Wean Pct.	65%
Cow Eff.	137

Marb	REA	Bfat
+28	+11	+00
(.28)	(.27)	(.38)

BWt	WWt	WR	ADG	YWt	YR	Scr.	Fr.
87	707	121	5	1280	117	34	5.5

★★★★★ for Low Maintenance, Growth, Gainability, Marbling, High Cow Efficiency, Calving Ease, Stayability.

O-1 BECKTON ROMAN J S158
1-A 100% # 1118621 Tattoo: BKT6 S158

Birth: 2-27-06
 Buffalo Creek Romeo L081
TR ROMEO NT379
 Ref.
 Buf Crk Lass L420
 Beckton Julian GG B571
 Beckton Roman J S158
 RCN Dynamo 732
 BUF CR ET LASS VC889
 Beckton Julian 7526G
 Bkt Marta 9A13 JL
BECKTON BELGA K285 JL
 Beckton Belga G493 HR
 Beckton Herald K B244
 Beckton Belga D776 CL

Calv.Ease	BW	WW	YW	Milk	HPG	Stay	Maint.En.
10	1.1	46	81	19	6	11	-1.6
(.39)	(.66)	(.59)	(.60)	(.35)	(.32)	(.16)	(.23)

DAM	
Age	6
Wt	1150
Wean Pct.	57%
Cow Eff.	121

Marb	REA	Bfat
-.07	+39	-.05
(.29)	(.27)	(.41)

BWt	WWt	WR	ADG	YWt	YR	Scr.	Fr.
79	660	113	4	1209	104	37	6.0

★★★★★ for Low Maintenance, Rib-eye area, High Cow Efficiency, Calving Ease.

• Reference Sires •

R-1 BECKTON RANGER T603 H3
1-A 100% # 1178895 Tattoo: WF7 T603

Birth: 3-27-07
 Beckton Ranger 7003
BECKTON RANGER 9479R
 Ref. Beckton Eola 7470 RZ
 Beckton Hustler C2 L079
BECKTON ROSE N044 HU
 Beckton Rose L669 JL
 Beckton Varo 5642
 Bkt Migo Vernice3942
 Beckton Raza 2308-N
 Bkt Neva Eola 4829
 Beckton Hustler CN J102
 Beckton Barmaid J012 CO
 Beckton Julian 7526G
 Beckton Rose D389 RD

Calv.Ease	BW	WW	YW	Milk	HPG	Stay	Maint.En.
13	-3.9	17	40	9	10	10	-9.9
(.30)	(.59)	(.50)	(.49)	(.25)	(.18)	(.16)	(.13)

DAM

Age	4
Wt	1085
Wean Pct.	56%
Cow Eff.	118

Marb	+15	(.25)	REA	-.13	(.24)	Bfat	+03	(.37)					
BWt	84	637	WR	106	ADG	4	1185	YR	106	Scr.	35	Fr.	5.5

★★★★★ for Low Maintenance, Gainability, Marbling, High Cow Efficiency, Calving Ease.



Beckton Warrior N645 T1

S-1 BECKTON SCAMP T A825
1-A 100% # 358433 Tattoo: WF1 A825

Birth: 4-4-91
 Beckton Julian 7526G
BECKTON SCAMP 8954
 Ref. Bkt Kusi Annie 5462
 Beckton Trojan 7061P
BKT ENCINO 8459 TJ
 BCH Kit 7132-784
 Beckton Julian 6592
 Bkt Belga 6746 GS
 Beckton Kusi 4879
 Bkt Xime Annie 4915
 Beckton Dito 4374
 Bkt Neva Eola 4829
 SUS Jiba 12-2970
 SUS Kit 2012-211

Calv.Ease	BW	WW	YW	Milk	HPG	Stay	Maint.En.
18	-7.8	10	26	14	6	8	-13.0
(.70)	(.79)	(.75)	(.74)	(.71)	(.47)	(.57)	(.53)

DAM

Age	5
Wt	1140
Wean Pct.	40%
Cow Eff.	84

Marb	+07	(.57)	REA	-.26	(.54)	Bfat	+01	(.43)					
BWt	65	457	WR	97	ADG	4	1048	YR	108	Scr.	NA	Fr.	4.5

★★★★★ for Low Maintenance, Calving Ease.

W-2 BECKTON WARRIOR T248 L5
1-A 100% # 1178758 Tattoo: WF7 T248

Birth: 3-11-07
 Beckton Warrior T1 H281
BECKTON WARRIOR N645 T1
 Ref. W-1 Beckton Rose H074 EP
 Beckton Lancer F442 T
BECKTON KIT R503 LN
 Beckton Kit F468 JL
 Beckton Warrior TC E801
 Beckton Minerva B609 RN
 Beckton Epic K F075
 Beckton Rose F791 EM
 Beckton Lancer T A664
 Bkt Suffeina A828 DM
 Beckton Julian GG B571
 Beckton Kit A517 NP

Calv.Ease	BW	WW	YW	Milk	HPG	Stay	Maint.En.
11	-2.7	28	56	8	12	17	-5.3
(.29)	(.61)	(.51)	(.50)	(.25)	(.01)	(.01)	(.11)

DAM

Age	2
Wt	830
Wean Pct.	63%
Cow Eff.	133

Marb	+10	(.23)	REA	+31	(.22)	Bfat	-.02	(.35)					
BWt	70	602	WR	108	ADG	4	1136	YR	106	Scr.	37	Fr.	5.0

★★★★★ for Low Maintenance, Rib-eye area, High Cow Efficiency, Calving Ease, Stayability.

W-1 BECKTON WARRIOR N645 T1
1-A 100% # 916767 Tattoo: BKT3 N645

Birth: 4-2-03
 Beckton Warrior TC E801
BECKTON WARRIOR T1 H281
 Ref. Beckton Minerva B609 RN
 Beckton Epic K F075
BECKTON ROSE H074 EP
 Beckton Rose F791 EM
 Beckton Warrior T C371
 Beckton Minola C251 NM
 Beckton Ranger H Z095
 Beckton Minerva Z936 RN
 Beckton Epic D404
 Beckton Belga D483 KR
 Beckton Emperor C369
 Beckton Rose C794 KR

Calv.Ease	BW	WW	YW	Milk	HPG	Stay	Maint.En.
5	-0.2	40	78	8	9	10	-1.0
(.31)	(.66)	(.54)	(.45)	(.27)	(.15)	(.01)	(.16)

DAM

Age	5
Wt	1020
Wean Pct.	67%
Cow Eff.	140

Marb	-.01	(.36)	REA	+01	(.34)	Bfat	+01	(.23)					
BWt	85	679	WR	117	ADG	3	1204	YR	115	Scr.	37	Fr.	6.5

★★★★★ for Low Maintenance, Growth, High Cow Efficiency.

W-3 BECKTON WARRIOR U636 J5
1-A 100% # 1259376 Tattoo: BKT8 U636

Birth: 3-29-08
 Beckton Warrior T1 H281
BECKTON WARRIOR N645 T1
 Ref. W-1 Beckton Rose H074 EP
 Beckton Julian GG B571
BECKTON LYDIA H159 JL
 Beckton Lydia D386 CL
 Beckton Warrior TC E801
 Beckton Minerva B609 RN
 Beckton Epic K F075
 Beckton Rose F791 EM
 Beckton Julian 7526G
 Bkt Marta 9A13 JL
 Beckton Clipper K Z420
 Bkt Lydia 9B78 VK

Calv.Ease	BW	WW	YW	Milk	HPG	Stay	Maint.En.
12	-1.7	36	71	9	15	15	3.8
(.31)	(.45)	(.41)	(.40)	(.26)	(.17)	(.15)	(.14)

DAM

Age	10
Wt	NA
Wean Pct.	NA%
Cow Eff.	NA

Marb	+32	(.28)	REA	+29	(.27)	Bfat	+01	(.37)					
BWt	74	583	WR	99	ADG	5	1165	YR	103	Scr.	38	Fr.	5.0

★★★★★ for Low Maintenance, Gainability, Marbling, Rib-eye area, Calving Ease, Stayability.

RAAA Herd EPD Tables

Proven and Genetic Opportunity Sires (2011)

	CED	BW	WW	YW	MILK	TM	ME	HPG	CEM	ST	MARB	YG	CW	REA	FAT
Min.	-16	-8.7	-29	-29	-14	-1	-18	-5	-15	-1	-.61	-.34	-23	-.77	-.09
Avg	6	-0.3	32	61	17	33	4	9	4	9	.08	-.02	37	.06	.00
Max.	30	7.6	80	133	38	57	24	22	26	19	.95	.31	87	1.02	.12
1%	19	-6.2	65	113	34	53	-9	17	15	17	.59	-.27	73	.62	-.06
2%	17	-5.5	61	107	32	50	-7	16	14	16	.53	-.24	69	.56	-.05
3%	16	-5.1	58	103	30	49	-6	15	13	15	.49	-.22	66	.51	-.05
4%	16	-4.8	57	101	30	48	-6	15	12	15	.46	-.21	64	.48	-.04
5%	15	-4.5	55	98	29	47	-5	15	12	15	.44	-.20	63	.46	-.04
10%	13	-3.6	50	90	26	44	-3	13	10	13	.36	-.16	57	.37	-.03
15%	12	-2.9	47	84	24	42	-2	13	9	13	.31	-.13	53	.31	-.03
20%	11	-2.4	44	80	23	40	-1	12	8	12	.26	-.11	50	.26	-.02
25%	10	-2.0	41	76	22	39	0	11	7	11	.23	-.09	47	.22	-.02
30%	9	-1.6	39	73	21	37	1	11	6	11	.20	-.08	45	.19	-.01
35%	8	-1.3	37	70	20	36	2	10	6	10	.16	-.06	43	.15	-.01
40%	7	-0.9	36	67	19	35	3	10	5	10	.14	-.05	41	.12	.00
45%	7	-0.6	34	64	18	34	3	9	5	9	.11	-.03	39	.09	.00
50%	6	-0.3	32	61	17	33	4	9	4	9	.08	-.02	37	.06	.00
55%	5	0.0	30	58	16	32	5	9	3	9	.05	-.01	35	.03	.01
60%	5	0.3	28	55	15	31	5	8	3	8	.02	.01	33	.00	.01
65%	4	0.7	27	52	14	30	6	8	2	8	.00	.02	31	-.03	.01
70%	3	1.0	25	49	13	29	7	7	2	7	-.04	.04	29	-.07	.02
75%	2	1.4	23	46	12	27	8	7	1	7	-.07	.05	27	-.10	.02
80%	1	1.8	20	42	11	26	9	6	0	6	-.10	.07	24	-.14	.02
85%	0	2.3	17	38	10	24	10	5	-1	5	-.15	.09	21	-.19	.03
90%	-1	3.0	14	32	8	22	11	5	-2	5	-.20	.12	17	-.25	.04
95%	-3	3.9	9	24	5	19	13	3	-4	3	-.28	.16	11	-.34	.05

Active Cows (2011)

	CED	BW	WW	YW	MILK	TM	ME	HPG	CEM	ST	MARB	YG	CW	REA	FAT
Min.	-11	-9.2	-39	-52	-12	-9	-24	-4	-13	-1	-.72	-.44	-35	-.83	-.11
Avg	5	0.1	29	55	17	31	4	9	3	9	.05	-.03	33	.02	.00
Max.	24	10.2	69	125	43	62	38	21	17	21	1.13	.43	80	1.10	.15
1%	14	-4.8	54	98	30	48	-7	14	11	16	.44	-.23	62	.43	-.05
2%	13	-4.3	51	93	29	46	-5	14	10	15	.40	-.20	59	.38	-.05
3%	13	-3.9	49	89	28	45	-5	13	10	15	.37	-.19	56	.35	-.04
4%	12	-3.6	48	87	27	44	-4	13	9	14	.34	-.18	55	.33	-.04
5%	12	-3.4	47	85	26	43	-3	13	9	14	.33	-.17	54	.31	-.04
10%	10	-2.6	43	78	24	40	-2	12	8	13	.26	-.14	49	.24	-.03
15%	9	-2.1	40	74	23	39	-1	11	7	12	.22	-.12	46	.20	-.02
20%	8	-1.7	38	70	22	37	0	11	6	12	.19	-.10	44	.17	-.02
25%	8	-1.3	36	67	21	36	1	11	5	11	.16	-.09	41	.14	-.02
30%	7	-1.0	35	65	20	35	2	10	5	11	.14	-.08	40	.11	-.01
35%	7	-0.7	33	62	19	34	2	10	4	10	.11	-.07	38	.09	-.01
40%	6	-0.4	32	60	18	33	3	10	4	10	.09	-.05	36	.06	-.01
45%	6	-0.2	30	57	18	32	3	9	3	9	.07	-.04	35	.04	-.01
50%	5	0.1	29	55	17	31	4	9	3	9	.05	-.03	33	.02	.00
55%	4	0.4	28	53	16	30	5	9	3	9	.02	-.02	31	.00	.00
60%	4	0.6	26	50	16	29	5	8	2	8	.00	-.01	30	-.03	.00
65%	3	0.9	25	48	15	28	6	8	2	8	-.02	.00	28	-.05	.00
70%	3	1.2	23	45	14	27	6	8	1	7	-.04	.01	26	-.07	.01
75%	2	1.5	22	43	13	26	7	7	1	7	-.07	.02	25	-.10	.01
80%	2	1.9	20	40	12	25	8	7	0	6	-.10	.04	22	-.13	.01
85%	1	2.3	18	36	11	23	9	7	-1	6	-.13	.05	20	-.16	.02
90%	0	2.8	15	32	10	22	10	6	-2	5	-.17	.07	17	-.21	.02
95%	-2	3.6	11	25	8	19	11	5	-3	4	-.23	.10	12	-.27	.03

Non-Parents (2011)

	CED	BW	WW	YW	MILK	TM	ME	HPG	CEM	ST	MARB	YG	CW	REA	FAT
Min.	-10	-9.5	-23	-27	-6	-1	-18	-2	-12	-1	-.61	-.47	-21	-.61	-.11
Avg	5	-0.1	32	60	17	33	4	10	3	9	.08	-0.03	36	.09	.00
Max.	23	7.9	74	128	34	56	23	20	17	22	1.11	.46	82	1.06	.16
1%	14	-4.7	56	101	27	47	-5	15	10	17	.47	-.22	63	.49	-.04
2%	13	-4.2	53	96	26	46	-4	14	9	16	.43	-.19	60	.44	-.04
3%	12	-3.9	52	93	25	45	-3	14	9	15	.40	-.18	58	.41	-.04
4%	12	-3.6	50	91	25	44	-2	14	8	15	.38	-.17	57	.39	-.03
5%	12	-3.4	49	89	24	43	-2	13	8	14	.36	-.16	55	.37	-.03
10%	10	-2.7	45	82	23	41	-1	13	7	13	.30	-0.13	51	.31	-0.02
15%	9	-2.2	43	78	22	39	0	12	6	12	.26	-.11	48	.26	-.02
20%	8	-1.8	41	75	21	38	1	12	5	12	.22	-.10	46	.23	-.02
25%	8	-1.4	39	72	20	37	2	11	5	11	.20	-.09	44	.20	-.01
30%	7	-1.1	37	69	19	36	2	11	5	11	.17	-.07	42	.18	-.01
35%	7	-0.9	36	67	19	35	3	11	4	10	.15	-.06	41	.15	-.01
40%	6	-0.6	35	64	18	35	3	11	4	10	.13	-.05	39	.13	.00
45%	5	-0.4	33	62	18	34	4	10	3	9	.11	-.04	37	.11	.00
50%	5	-0.1	32	60	17	33	4	10	3	9	.08	-0.03	36	.09	.00
55%	5	0.2	31	58	16	32	4	10	3	9	.06	-.02	35	.06	.00
60%	4	0.4	29	56	16	31	5	9	2	8	.04	-.01	33	.04	.01
65%	3	0.7	28	53	15	31	5	9	2	8	.02	.00	31	.02	.01
70%	3	0.9	27	51	15	30	6	9	1	7	.00	.01	30	-.01	.01
75%	2	1.2	25	48	14	29	6	9	1	7	-.03	.02	28	-.03	.01
80%	2	1.6	23	45	13	28	7	8	1	6	-.06	.03	26	-.06	.02
85%	1	2.0	21	42	12	27	8	8	0	6	-.09	.05	24	-.09	.02
90%	0	2.5	19	38	11	25	9	7	-1	5	-.13	.07	21	-.14	.03
95%	-2	3.2	15	31	10	23	10	7	-2	4	-.19	.10	17	-.20	.03

EPD Accuracies and Possible Change

EPDs are predictions, not true values, and we can therefore expect that EPDs will change from sire evaluation, as more information (i.e. progeny data) is included. A possible change value is an estimate of the amount of change (in trait units) that can be expected for a given EPD.

Technically, there is a 68% chance that the real genetic value (an EPD with a accuracy of 1.0) for any trait lies between its EPD plus its possible change value and its EPD minus its possible change value. For example, if a sire has a weaning EPD of +25 lb. and a possible change value of 10 lb., we can expect the true genetic value to be between +15 lb. (25 - 10) and +35 lb. (25 + 10) 68% of the time. We should not be surprised if his EPD in next year's evaluation is as high as +35 or as low as +15. If next year's EPD should happen to be slightly outside of this

range, keep in mind there is nearly a one-in-three chance of that happening; however, significantly larger deviations can occur.

Possible change is simply another way of expressing accuracy of an EPD. High accuracy sires will have small possible changes and vice versa. Many breeders feel that possible change values complement accuracies and help them determine just how thoroughly an animal has been evaluated. The accuracy/possible change chart lists possible changes in EPDs that can be expected with different levels of accuracy for the various traits.

For more information on possible change values, please see the article by Dr. Bob Hough titled "Understanding EPD Accuracies and Possible Change". This article can be downloaded from the Red Angus Association of America website at www.redangus.org.

Accuracy	CED	BW	WW	YW	MILK	ME	HPG	CETM	ST	MARB	YG	CW	REA	FAT
0.0	9	3.0	16	26	12	3	11	9	7	.26	.20	19	.43	.04
0.1	8	2.7	15	23	11	2	10	8	6	.23	.18	17	.39	.04
0.2	7	2.4	13	21	10	2	9	7	5	.21	.16	15	.34	.03
0.3	6	2.1	11	18	8	2	8	6	5	.18	.14	14	.30	.03
0.4	5	1.8	10	15	7	2	7	5	4	.16	.12	12	.26	.02
0.5	4	1.5	8	13	6	1	6	4	3	.13	.10	10	.22	.02
0.6	3	1.2	7	10	5	1	4	4	3	.10	.08	8	.17	.02
0.7	3	0.9	5	8	4	1	3	3	2	.08	.06	6	.13	.01
0.8	2	0.6	3	5	2	1	2	2	1	.05	.04	4	.09	.01
0.9	1	0.3	2	3	1	0	1	1	1	.03	.02	2	.04	.00
1.0	0	0.0	0	0	0	0	0	0	0	.00	.00	0	.00	.00

Sire Bloodline Charts

Name Family

- Accent A
- Action A
- Champ H
- Clifftop C
- Clipper A
- Cobalt A
- Cody A
- Colt A
- Copper C
- Dominor D
- Emcee E
- Emperor E
- Epic E
- Exeter E
- Hasten H
- Herald H
- Heritage H
- Hilltop C
- Hustler H
- Javelin L
- Jet J
- Jules J
- Julian J
- Julio J
- Juniper J
- Juno J
- Jupiter J
- Justice J
- Lancer L
- Lariat L
- Legend L
- Likable L
- Loki L
- Nebula N
- Neptune N
- Neva V
- Nomad V
- Ranger R
- Roman O
- Scamp S
- Varo R
- Vega V
- Vegas V
- Warhawk W
- Warrior W

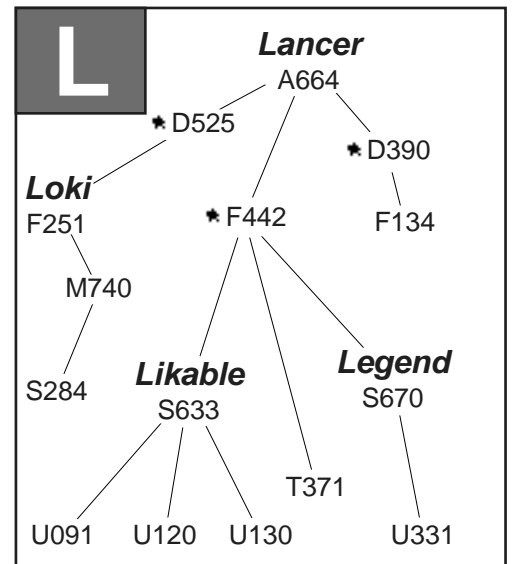
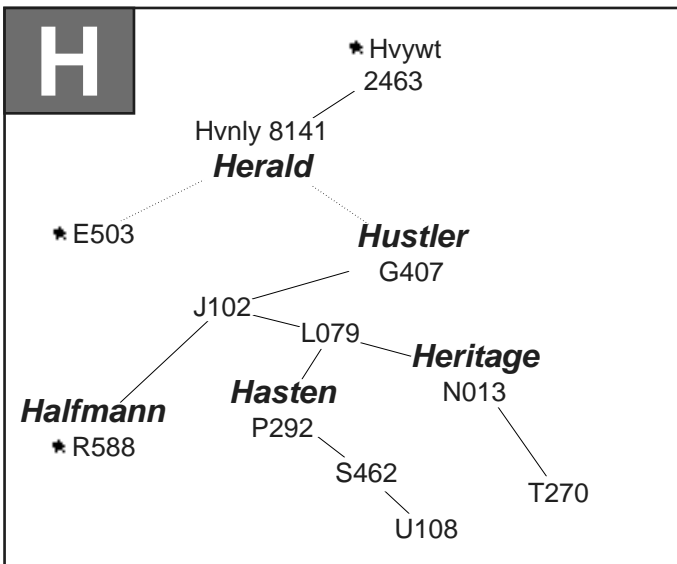
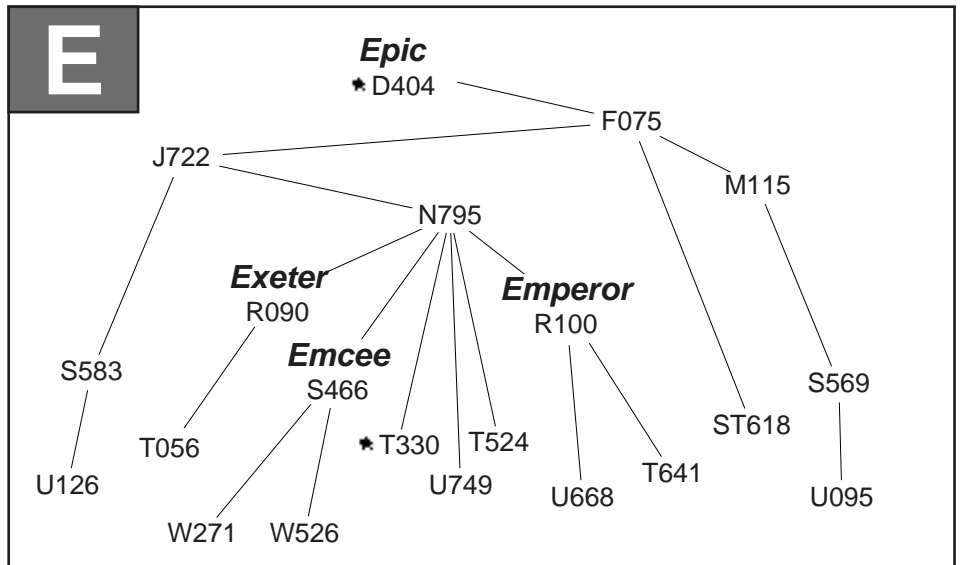
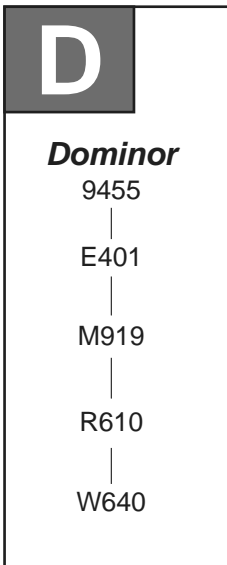
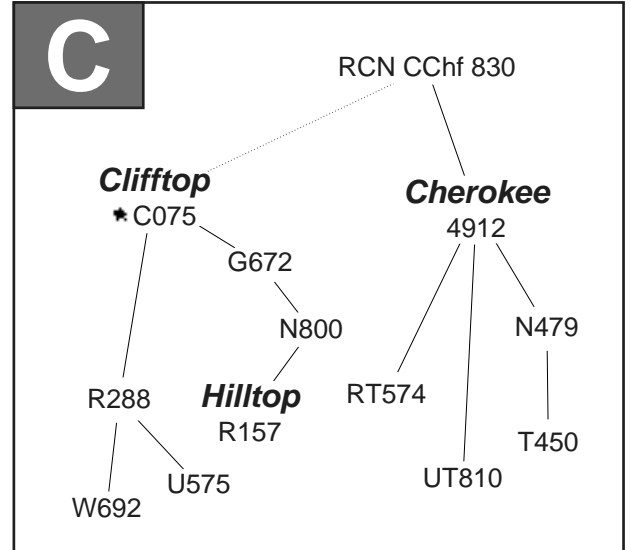
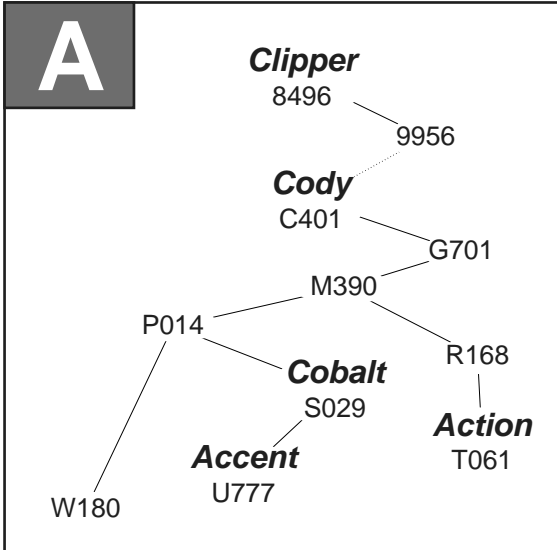

★ Red Angus Trait Leader

J

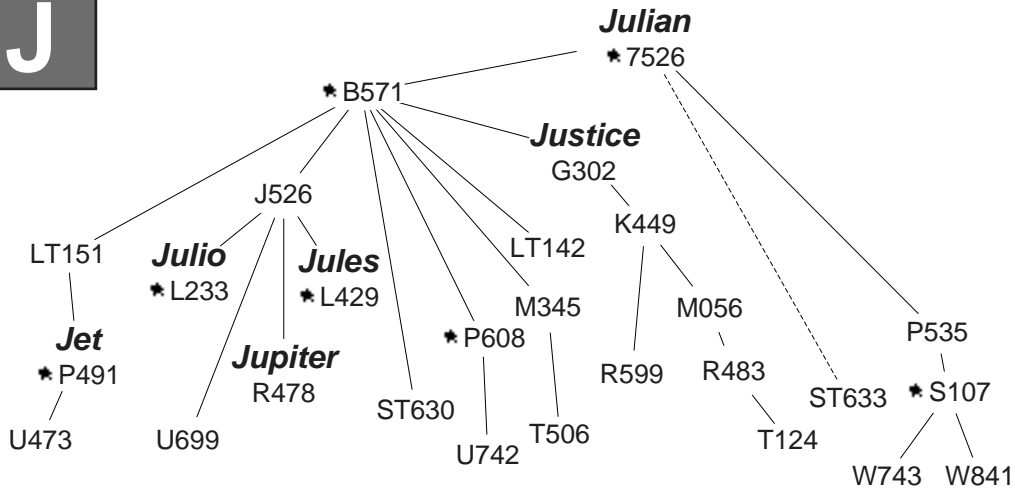

Name	Tag	Family
Scamp	A825	S-1
Julian	B571	J-1
Lancer	F442	L-1
Jules	L429	J-2
Nebula	M045	N-1
Epic	M115	E
Heritage	N013	H-1
Warrior	N645	W-1
Epic	N795	E-1
Cody	P014	A
Nebula	P093	N-3
Jet	P491	J
Julian	P535	J
Julian	P608	J-3
Nebula	P707	N-4
Cody	R168	A
Nebula	R233	N
Clifftop	R288	C
Nebula	R475	N
Halfmann	R588	H-2
Dominor	R610	D-1
Cobalt	S029	A
Julian	S107	J-4
Roman	S158	O-1
Nebula	S237	N-5
Loki	S284	L-2
Warrior	S337	W
Nebula	S347	N
Hasten	S462	H-3
Emcee	S466	E
Nebula	S543	N-6
Epic	S569	E-2
Epic	S583	E
Likable	S633	L
Legend	S670	L-3
Nebula	T054	N-7
Warrior	T248	W-2
Nebula	T252	N
Nebula	T269	N-8
Heritage	T270	H-4
Epic	T330	E-3
Lancer	T371	L-4
Nebula	T398	N-9
Cherokee	T450	C-1
Epic	T524	E-4
Ranger	T603	R-1
Emperor	T641	E-5
Nebula	U031	N-10
Nebula	U060	N-11
Likable	U091	L
Epic	U095	E-6
Hasten	U108	H-5
Likable	U120	L-5
Epic	U126	E-7
Likable	U130	L-6
Nebula	U206	N-12
Legend	U331	L-7
Jet	U473	J-5
Clifftop	U575	C-2
Warrior	U636	W-3
Emperor	U668	E
Julian	U699	J-6
Julian	U742	J
Epic	U749	E-8
Accent	U777	A-1

N

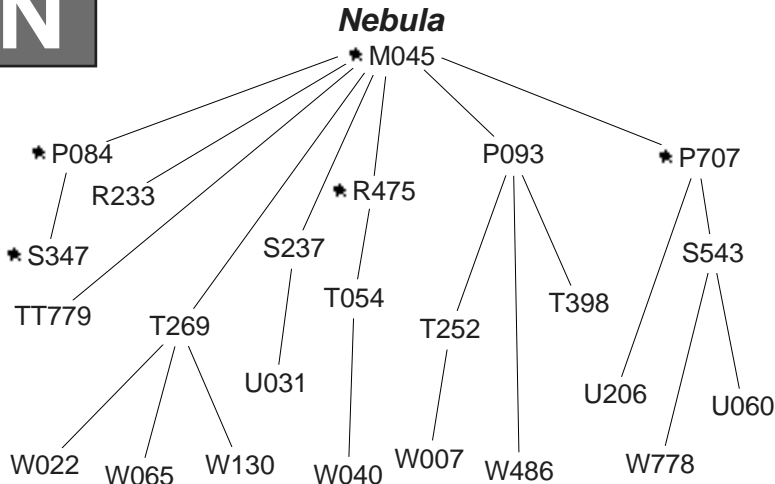

O



R

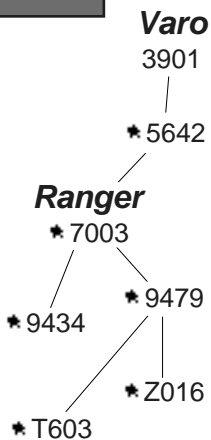

S

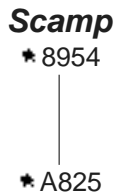

V

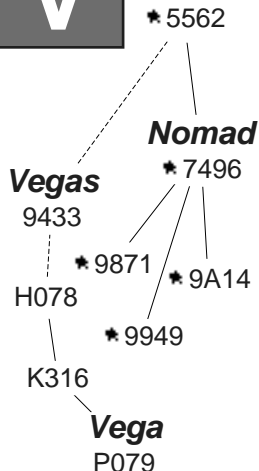

W

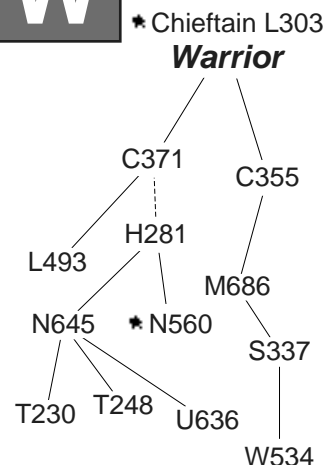

Lot-Tag Cross Reference

ID	Lot	ID	Lot	ID	Lot	ID	Lot	ID	Lot	ID	Lot	ID	Lot
<i>Reference Sires</i>		<i>Beckton Bulls</i>		X206	68	X378	109	X602	241	X766	255	X703	336
A825	S-1	X001	176	X207	79	X380	50	X605	142	X768	192	X708	321
B571	J-1	X009	1	X209	17	X388	63	X610	120	X775	238	X790	308
F442	L-1	X014	89	X210	116	X394	115	X611	232	X776	205		
L429	J-2	X017	110	X215	11	X395	193	X613	227	X781	164		
LT142	J-7	X021	108	X218	106	X396	136	X614	81	X784	88	<i>Tongue River Bulls</i>	
LT151	J-8	X024	155	X224	34	X397	175	X615	62	X788	248	XT001	9
M045	N-1	X029	216	X229	56	X401	211	X616	141	X796	152	XT002	8
N013	H-1	X030	51	X230	97	X412	131	X618	58	X801	257	XT003	75
N645	W-1	X033	64	X238	54	X419	69	X624	258	X803	251	XT004	72
N795	E-1	X036	82	X242	23	X421	28	X625	253	X810	2	XT005	71
P084	N-2	X037	80	X245	137	X423	94	X626	121	X815	163	XT006	77
P093	N-3	X038	14	X246	210	X430	111	X630	118	X852	53	XT009	7
P608	J-3	X040	221	X248	138	X431	240	X632	223			XT010	78
P707	N-4	X053	231	X252	95	X432	203	X634	236	<i>Beckton Heifers</i>			
R588	H-2	X055	201	X253	18	X436	105	X639	214	X072	354	XT018	191
R610	D-1	X061	47	X254	183	X444	259	X650	158	X086	322	XT020	184
RT574	C-3	X063	70	X257	100	X446	123	X655	60	X101	340	XT021	189
S107	J-4	X076	3	X259	129	X454	113	X657	39	X109	337	XT022	10
S158	O-1	X080	22	X263	173	X456	37	X663	128	X116	370	XT023	186
S237	N-5	X082	103	X266	43	X459	225	X664	194	X117	304	XT025	187
S284	L-2	X093	154	X270	13	X460	140	X665	229	X119	303	XT029	185
S462	H-3	X097	144	X271	48	X461	125	X673	135	X138	309	XT032	188
S543	N-6	X103	83	X276	84	X462	243	X678	195	X141	307	XT034	76
S569	E-2	X104	157	X277	177	X467	16	X679	147	X152	328	XT037	190
S670	L-3	X108	44	X280	228	X468	122	X680	169	X159	341	XT041	74
ST618	E-9	X114	226	X285	31	X473	124	X685	92	X162	331	XT058	73
ST630	J-9	X118	61	X286	35	X474	130	X689	104	X177	310		
ST633	J-10	X120	102	X289	127	X477	146	X692	112	X182	335	<i>Tongue River Heifers</i>	
T054	N-7	X121	204	X291	182	X485	237	X693	230	X190	332	XT053	348
T248	W-2	X123	181	X299	179	X486	171	X696	197	X211	302	XT054	343
T269	N-8	X124	212	X300	52	X488	21	X697	107	X220	357	XT056	346
T270	H-4	X127	178	X302	206	X493	159	X699	207	X221	301	XT057	312
T330	E-3	X128	172	X303	209	X495	200	X700	85	X228	358	XT061	347
T371	L-4	X131	45	X304	132	X496	119	X702	242	X244	371	XT062	319
T398	N-9	X133	46	X307	20	X503	139	X705	96	X255	366	XT063	344
T450	C-1	X139	245	X310	208	X508	233	X707	235	X262	368	XT064	349
T524	E-4	X146	217	X315	101	X511	143	X709	87	X264	323	XT066	363
T603	R-1	X148	93	X321	4	X512	151	X715	160	X273	326	XT067	313
T641	E-5	X153	168	X323	145	X515	174	X716	99	X274	330	XT068	362
TT779	N-13	X154	167	X327	12	X518	114	X718	250	X322	324	XT069	350
U031	N-10	X160	19	X333	5	X524	59	X723	86	X325	329	XT070	353
U060	N-11	X161	42	X337	15	X525	260	X726	252	X332	367	XT072	361
U095	E-6	X163	246	X341	32	X531	165	X728	162	X345	359	XT073	314
U108	H-5	X167	150	X342	57	X533	98	X738	256	X348	306	XT076	364
U120	L-5	X168	65	X344	29	X537	117	X741	198	X372	338	XT077	317
U126	E-7	X169	126	X347	222	X539	199	X743	215	X376	333	XT079	351
U130	L-6	X170	26	X355	180	X541	133	X745	66	X385	334	XT080	345
U206	N-12	X171	244	X357	218	X563	67	X746	249	X392	305	XT082	352
U331	L-7	X173	33	X359	219	X571	220	X747	247	X407	327	XT084	360
U473	J-5	X179	134	X360	149	X574	91	X755	234	X413	325	XT085	315
U575	C-2	X185	25	X361	38	X577	36	X756	90	X422	342	XT087	365
U636	W-3	X186	213	X365	41	X581	239	X757	166	X478	356	XT090	316
U699	J-6	X187	40	X369	202	X589	156	X758	161	X499	355	XT092	311
U749	E-8	X188	24	X370	170	X593	6	X760	148	X623	339	XT094	320
U777	A-1	X195	55	X373	27	X594	254	X762	196	X668	369		
UT810	C-4	X201	49	X377	30	X598	153	X763	224				

Sale Terms and Conditions

Except for those stated in the terms and conditions below, there are no warranties, either expressed or implied, as to the merchantability or fitness for a particular purpose with respect to the cattle being sold at this auction. The warranties and guarantees set forth in the "Terms and Conditions" are in lieu of all other warranties, either expressed or implied, and the remedies provided therein shall be the sole and exclusive remedy for the Buyer, or any party claiming through Buyer, for any breach of warranty or guarantee therein provided, and all other obligations or liabilities.

The information in the catalog is believed to be accurate, and the information seller believes to be most representative. It is the nature of seller's business that the seller engages in a continual process of collecting new data and information. Therefore, any information presented at the time of sale is always subject to revision, correction or update.

I. BIDDING

The Auctioneer in charge will settle any disputes as to bids, and his decision on such matters shall be final.

II. TERMS

Terms of sale are cash or personal check unless satisfactory credit arrangements have been made with vendor prior to sale.

III. PURCHASER'S RISK

Each animal becomes the risk of the purchaser as soon as sold, but it shall be the obligation of the Seller to see that animals are fed and cared for free of charge to purchaser, until loaded for shipment or until the expiration of 48 hours after the sale, whichever occurs sooner.

IV. DELIVERY

For any animals for which seller's arrange delivery, the following terms shall apply. Each animal becomes the risk of the purchaser as soon as sold, and through the time of delivery. The seller will arrange transportation and delivery schedules, and may combine animals from one or more purchasers for convenience and to reduce costs. If delivery is arranged, seller assumes no other liability. Once the purchaser has been notified of the date and approximate time of delivery (morning, afternoon, evening, etc.), it is the responsibility of the purchaser to arrange adequate and agreeable location and facilities for unloading each animal. When unloaded at the agreed upon location, all care and management of the animal is the responsibility of the purchaser.

V. CERTIFICATE OF REGISTRY

A transferred certificate of registry will be furnished to the purchaser for each animal sold as 'Registered'.

VI. HEALTH

All animals are eligible for interstate shipment, except as otherwise announced. Interstate health papers will be furnished for each animal requiring T.B. and Bang's tests in accordance with Federal Regulations.

VII. A.I. NON-OWNER BULL PERMITS

A.I./Non-owner Bull Permits shall be furnished by the Seller, at no cost to the Buyer, for all females bred artificially or naturally to bulls not owned by the Seller.

VIII. ANNOUNCEMENTS

Any changes from information of any kind in this catalog will be announced from the auction box and such announcements shall take precedence.

IX. BREEDING GUARANTEE

Any female that has had a calf prior to the date of sale shall be considered a breeder without further guarantee. All females sold as 'bred' or 'pregnant' have been pregnancy checked by a licensed veterinarian and are guaranteed bred on the day of sale. The purchaser may elect to have any female so listed rechecked at their cost within 30 days of delivery by a licensed veterinarian of their choice. Any such female determined open by this recheck may be returned to the seller for a full refund. Due to conditions out of seller's control, once a female leaves seller's possession, this is the only guarantee offered.

All bulls are sold as guaranteed breeders. Each bull has been officially fertility tested as "Satisfactory Breeder" prior to the sale. However, seller cannot guarantee against physical injury or illness following the sale. But if within 8 months following the sale, the buyer has evidence that the animal is not a breeder, the buyer may obtain a statement signed by a licensed veterinarian to that effect, such statement also indicating that there has been no injury or illness to the animal following the sale, and return the bull to the farm of the seller for adjustment. If the seller cannot then prove the animal to be a breeder, an adjustment will be made by the seller, either by substituting an animal of equal value, or by the refund of the full purchase price. Such adjustment shall be considered full settlement and satisfaction of all claims. No guarantees apply to animals which are shown following the sale.

X. GENETIC DEFECT AND PARENTAGE GUARANTEE

For complete rules and regulations in regard to genetic defects or parentage guarantee contact the RAAA. Ask for Section C Registration Requirements.

Osteopetrosis: The Red Angus Association along with animal scientists have developed a DNA marker test for osteopetrosis (OS), a genetic disorder which in rare instances can cause the loss of a calf at birth. Since the test was developed, Beckton has tested every sire being used in our breeding program. Only one sire, from outside our program, tested positive as a carrier of the gene. Every sire bred and raised at Beckton has tested 'Free'. All of our major semen sires have also been tested 'Free'. We guarantee every sale animal to be OS Free, and if you have a concern, we will have any sale animal tested on request. If an animal were to test positive, we would replace the animal or refund the purchase price. The testing we have done shows no incidence of occurrence in any Beckton bloodlines for the past 30 years, and so we believe there is no safer herd than ours.

XI. RETAINED INTEREST AND SEMEN RIGHTS:

Buyer receives full possession and salvage value of all bulls in the sale, unless stated otherwise in the catalog or during the auction. Buyer also has the sole privilege to determine if or when the bull is to have semen collected at any time in the future. Seller retains a 1/3 semen interest only on all sale bulls. On such bulls which are collected in the future, seller will have the privilege of receiving semen for in house use, sharing pro rata in the costs of collection of such semen. On such bulls from which semen is advertised or marketed commercially, seller is entitled to 1/3 royalty interest on gross semen sales, with buyer receiving 2/3 of gross sales. However, as stated any decision to collect or sell semen is solely the right of the buyer.

XII. RIGHTS AND OBLIGATIONS

A. The above terms and conditions of sale shall constitute a contract between the Buyer and Seller of each animal and shall be equally binding upon both. Each sale or resale of an animal constitutes a separate transaction.

B. Neither the sale manager, the owner, nor any other person connected with the management of the sale, assumes any liability, legal or otherwise.

Notes

Semen Available



Bull Name	Calv. Ease	BW	WW	YW	Milk	HPG	Stay	ME	Marb	REA	Bfat	Price
	Acc.	Acc.	Acc.	Acc.	Acc.	Acc.	Acc.	Acc.	Acc.	Acc.	Acc.	
Beckton Lancer T A664	15	-3.0	28	59	6	-1	14	7	.25	.01	-.01	\$18/60
<i>Reg. 358389</i>	.89	.92	.90	.90	.89	.80	.77	.62	.74	.72	.60	
Beckton Cody KH M390	13	-4.5	26	57	13	9	12	-4	.01	-.07	.02	\$18/60
<i>Reg. 854892</i>	.47	.76	.67	.62	.45	.01	.01	.34	.44	.41	.27	
Beckton Cherokee N N479	14	-5.6	31	50	25	11	13	-5	.08	.27	.02	\$18/60
<i>Reg. 916601</i>	.63	.76	.72	.70	.63	.36	.30	.42	.50	.47	.32	
Beckton Warrior N645 T1	5	-0.2	40	78	8	9	10	-1	-.01	.01	.01	\$18/60
<i>Reg. 916767</i>	.31	.66	.54	.45	.27	.15	.01	.16	.36	.34	.23	
Beckton Epic K4 N795	8	-0.4	37	87	12	0	10	6	.56	.32	.07	\$18/60
<i>Reg. 916917</i>	.75	.81	.79	.79	.73	.52	.21	.54	.62	.60	.68	
Beckton Nebula L P093	13	-2.8	36	71	2	11	11	-4	.26	.08	.00	\$18/60
<i>Reg. 978419</i>	.71	.81	.78	.79	.68	.35	.14	.44	.53	.51	.61	
Beckton Jet L P491	19	-8.1	14	34	19	11	15	2	.19	.15	.00	\$18/60
<i>Reg. 978816</i>	.57	.76	.69	.67	.58	.10	.25	.43	.44	.40	.24	
Beckton Julian G4 P627	19	-4.0	16	29	12	13	14	-11	.32	.23	-.03	\$18/60
<i>Reg. 978951</i>	.54	.66	.62	.63	.50	.39	.24	.32	.37	.35	.47	
Beckton Epic R350 K	11	-3.7	25	54	17	11	11	1	.14	.09	.01	\$18/60
<i>Reg. 1042088</i>	.23	.26	.25	.25	.25	.19	.17	.18	.01	.01	.01	
Beckton HalfmannHustler R588	12	-4.5	32	67	11	7	11	5	-.11	-.04	-.02	\$18/60
<i>Reg. 1042326</i>	.21	.36	.28	.29	.23	.16	.01	.16	.30	.28	.22	
Beckton Justice T124 C1	14	-3.7	31	67	13	10	12	-6	.17	.16	.00	\$18/60
<i>Reg. 1178635</i>	.13	.34	.24	.24	.14	.01	.01	.01	.25	.24	.20	
Beckton Juniper T826	10	0.4	35	70	9	10	16	-4	.03	.21	.00	\$18/60
<i>Reg. 1179117</i>	.17	.34	.21	.27	.19	.01	.01	.10	.01	.01	.01	

Special – Semen Packages on Rare Sires

BECKTON JULIAN B571 and BECKTON NEBULA P707

BECKTON JULIAN GG B571

1-A 100% # 387580 Tattoo: WF2 B571

Birth: 3-27-92

Beckton Julian 6592
BECKTON JULIAN 7526G
 Ref. Beckton Trojan 5253
 Lchmn Christy 2339
 Beckton Gisa 4454
 Beckton Lalaxigu -2
 Beckton Julian 6592
 Bkt Belga 6746 GS
 Beckton Xime 4736
 Beckton Marwa -K

Beckton Julian 7526G
BKT MARTA 9A13 JL
 Bkt Marta 6498 XM

Calv.Ease	BW	WW	YW	Milk	HPG	Stay	Maint.En.
19	-5.9	29	56	15	5	24	-7.0
(.90)	(.92)	(.91)	(.91)	(.90)	(.76)	(.70)	(.62)

DAM
 Age 3
 Wt 1015
 Wean Pct. 56%
 Cow Eff. 118

Marb	REA	Bfat
+1.0	+4.8	+0.2
(.72)	(.69)	(.58)

BWt	WWt	WR	ADG	YWt	YR	Scr.	Fr.
65	627	113	3	1140	112	NA	5.0



★★★★★ for Low Maintenance, Rib-eye area, High Cow Efficiency, Calving Ease, Stayability.

B571 and P707 are the two premier sires in the Red Angus breed, offering the best of all traits for which our program is known. Semen is rare and will not be on the market going forward. At this time we are offering four packages of 10 straws each, for choice of these sires, or split between them, as follows:

The purchaser of any Beckton bull in this sale will have the option to exchange the bull bought in the ring, for the same price, for the buyer's choice of one of these four packages. The buyer must notify the auctioneer before the next bull is sold that the buyer wants to take this semen option. The buyer should also specify which semen he is selecting to ensure that his choice of semen is reserved. The auctioneer will then re-auction the bull in the ring.

There are only 15 straws total available for B571, so if the buyer wants B571 it is important that be specified in the ring. Once the 15 straws of B571 have been claimed, his semen will no longer

be an option. There are 30 straws available for P707. However, once any four option packages totaling 40 straws have been exercised, any further option terminates and will no longer be available through the remainder of the sale.

Note: We will also offer as an alternative 15 straws of BKT Julian 7526G, Reg#173525, sire of B571, one of the greatest sires ever at Beckton and one of the highest Stayability sires in the Red Angus breed. Note also that if the choice of semen is not specified in the ring, the buyer may choose later, but only from semen not taken by other buyers.

Option on Tongue River bulls:

There is one rare semen package available on TR Julian LT151, Reference Sire J-8, a top B571 son whose semen is no longer on the market. The buyer of any Tongue River bull in the sale has the option to take this semen package in the same manner as above, with the bull in the ring being re-auctioned. When this LT151 package is taken, no further semen option is available on TRRA bulls.

BECKTON NEBULA P P707

1-A 100% # 979031 Tattoo: BKT4 P707

Birth: 4-1-04

Beckton Neptune R2 K065
BECKTON NEBULA M045
 Ref. N-1 Beckton Neptune RR B284
 Beckton Lana C735 TP
 Beckton Julian GG B571
 Beckton Belga G493 HR
 Beckton Epic KN H110
 Beckton Rose H019 SC
 Beckton Epic K1 K863
BECKTON LANA M809 EP
 Beckton Lana K253 DM
 Beckton Dominor ZJ H657
 Beckton Lana HA34 DM



Calv.Ease	BW	WW	YW	Milk	HPG	Stay	Maint.En.
18	-5.9	33	64	19	8	12	-11.6
(.62)	(.75)	(.71)	(.69)	(.59)	(.32)	(.14)	(.44)

DAM
 Age 2
 Wt 890
 Wean Pct. 71%
 Cow Eff. 150

Marb	REA	Bfat
+5.3	-0.5	+0.2
(.45)	(.42)	(.53)

BWt	WWt	WR	ADG	YWt	YR	Scr.	Fr.
68	728	127	4	1265	122	37	5.0

★★★★★ for Low Maintenance, Growth, Marbling, High Cow Efficiency, Calving Ease.

Beckton Stock Farm

Cam and Sal Forbes
37 Beckton Drive
Sheridan, WY 82801

Tel.: 307.674.6095, 674.8162 (evening)

Fax: 307.672.7281

Email: beckton@wavecom.net

Web: www.BecktonRedAngus.com

FIRST CLASS

Special Feature – Semen Packages on Rare Sires

We are offering semen packages on two of the most in-demand sires in the breed – Beckton Julian B571 and Beckton Nebula P707. Details inside.



LOWEST FEED REQUIREMENT

Beckton is the #1 herd for Low Maintenance Energy requirements, with the lowest average Cow Maintenance EPD of any major herd. Seven of the top ten sires in the breed for lowest Maintenance Energy are Beckton sires, more than all other herds combined.

RAPID GROWTH TO MARKET

Beckton bulls are leaders in total birth-to-market rate of growth. The average bull in this sale goes from -3.6 pounds at birth (BWE PD) to +55 pounds at yearling (YWE PD).

EASIEST CALVING

Beckton is also the #1 herd for easy calving, with the best average Calving Ease EPD of any major herd. Eight of the top ten sires in the breed for low Birth Weight EPD are Beckton sires.

DISPOSITION, FERTILITY, ALTITUDE ADAPTATION

Plus 66 years of selection for functionality – good dispositions, high cowherd fertility, good udders and milk. Our cattle rotate between Wyoming range and high elevations in the Bighorn Mountains, so they offer excellent altitude adaptation and strong feet and legs.

#1 HERD IN THE BREED FOR STAYABILITY !!

Six of the top ten sires in the entire breed for Stayability EPD are Beckton sires. High reproduction rate; cattle that work; traits that save you time and make you money. These are the cattle that stay in your herd when the others are gone.

Free Delivery
anywhere in the Continental US