

# 70th Anniversary Production Sale

Tuesday April 14th, 2015

Industry Leader for  
Low Maintenance, Maternal Traits



# **1** Beckton Red Angus

*Foundation Herd of the Red Angus Breed*

# Beckton Ranch

9½ miles West of Sheridan

**Tuesday, April 14th, 2015**  
**1 o'clock pm**  
Lunch at noon

**259 Bulls • 35 Heifers**  
Selling in catalog order, heifers sell following the bulls

Please join us for a complimentary dinner after the sale at the Holiday Inn.

**Phone: 307.674.6095**



Cam and Trish Forbes

## Some Facts about the Beckton Herd

- ▶ Beckton is the #1 herd in the breed for Stayability, and has been for many years. 15 of the top 20 sires (and 24 of the top 30) for Stayability EPD are Beckton sires or descended from Beckton sires. These are the bulls and heifers that will be with you after the others are gone.
- ▶ Beckton bulls are leaders in total rate of growth from birth to market weight. The average birth weight EPD of these sale bulls is minus -4.3 and the average yearling weight EPD is plus +84. No other set of bulls will start with such low birth weight and reach such a high yearling weight – for high value with for less time and cost to market.
- ▶ This has also been the #1 herd in the breed for low Maintenance Energy requirements for many years. Five of the top ten sires in the entire breed for lowest Maintenance Energy EPD are Beckton sires. No other set of bulls will do a better job cutting your cowherd maintenance requirements and saving you feed and money. Run more cows per acre and get more calves per acre.
- ▶ Beckton is also the #1 herd for easy calving, with the best average Calving Ease EPD of any major herd. 15 of the top 20 sires in the breed for low Birth Weight EPD are Beckton sires. No other set of bulls will come close.



**Serving our customers for 70 years with industry leading genetics and the highest quality cattle.**



**Conference Call Buying** For those who cannot attend the sale and would like to listen and bid over the phone, two Conference call lines will be available. Call the ranch number above well ahead of the sale and we will register you for the conference call and give you call-in instructions and a buyer number.

**Site-Unseen Purchase** If you are unable to attend the sale, we can help you select the bulls or females to fit your needs. Give us a phone call, letter, fax or e-mail (please refer to the back cover), and we can make arrangements to handle bidding according to your directions. Bulls are bought at the lowest price, and satisfaction is guaranteed on bulls purchased sight unseen. Many of our repeat customers buy their bulls this way. To provide us adequate time to assist you, please contact us before noon of the day prior to the sale.

**Free Delivery** We provide free delivery for all bulls throughout the continental U.S. If you bring a trailer to haul your own, \$200 will be deducted from the price of each bull. Heifers will be delivered free within 400 miles, and at cost for additional miles. Most of the sale cattle will be delivered from 1 to 3 weeks after the sale, although we will try to accommodate if you need your bulls right away. Although there occasionally are limitations, in most cases we can deliver the cattle directly to your ranch.

**Payments** Payments can be made with cash, check payable to Beckton Stock Farm, Inc. or Visa/Mastercard on sale day.



# 1 Beckton Red Angus

37 Beckton Drive • Sheridan, WY 82801 • becktonwyo@gmail.com  
Office: 307.674.6095 • Evenings: 674.8162 • Fax: 674.8162

Dear Friends and Cattlemen,

It is an exciting time to be in the cattle business. The economics are in our favor and the future is promising. Beef demand is strong and exports provide an avenue for future growth. Beef is becoming more popular and more affordable in non-traditional areas of the globe.

It is also an exciting time in the Red Angus breed. Over the past years the constant emphasis on scientific cattle selection and improvement have given us a wide array of EPD's to study and assimilate, but the task becomes increasingly difficult. After many years of planning and research, the Red Angus Association has developed a new tool to assist producers in their cattle breeding decisions. This past year RAA introduced two new Indices – the HerdBuilder Index and the GridMaster Index.

Many of us are now quite familiar with the EPD's such as Birth Weight or Yearling Weight, which are denominated in 'pounds'. These EPD's measure the expected pounds of difference produced by one animal compared to another. The two new Indices are denominated in 'dollars'. They measure the expected dollars of difference produced by one animal compared to another, for each mating of that animal. More complete information is provided in the article on page 8 in this catalog.

The traits which the HerdBuilder and GridMaster Indices measure, are the same traits for which Beckton has been selecting over the past seven decades. You will see looking through the sale bulls that most rank in the very highest level of the breed. These bulls should produce significantly more dollar profitability compared to median or average Red Angus bulls.

Speaking of the bulls, these bulls look absolutely terrific this year. Top to bottom they are our best ever. We had summer with both moist and dry, a winter with both warm and cold. But through all conditions, they have done very well. The heifers are better this year also. You will see that we have picked from the upper end of the herd.

We welcome you to join us for our 70th Anniversary Sale this year, with a dinner served at the Holiday Inn after. If you are unable to attend, you may use our Conference call bidding, or call me ahead and visit about a Sight-Unseen order. Over a quarter of our bulls sell this way, mostly to long-time customers. We put a lot of work into selecting the bulls and heifers for the sale, and as always, your satisfaction with every animal is guaranteed.

We look forward to seeing you on Tuesday the 14th.

Sincerely,

*Cam Forbes*



Cam and Trish Forbes

**Beckton Red Angus • Since 1945**  
**The Foundation Herd of the Red Angus Breed**

# Sale Information

## Accommodations

### Holiday Inn

307.672.8931, I-90, Exit 25

Ask for special Beckton Sale rate of \$71

### Best Western Sheridan Center

307.674.7421, 612 N. Main Street

### Days Inn

307.672.2888, 1104 Brundage Lane

### Super 8 Motel

307.672.9725, 2435 N. Main Street

## Transportation

### Great Lakes Airlines

Several daily flights to/from Denver

Contact Holiday Inn for airport transfers

### Avis Car Rental

T: 307.672.2226. Sheridan Airport



**Auctioneer Roger Jacobs**  
406.698.7686

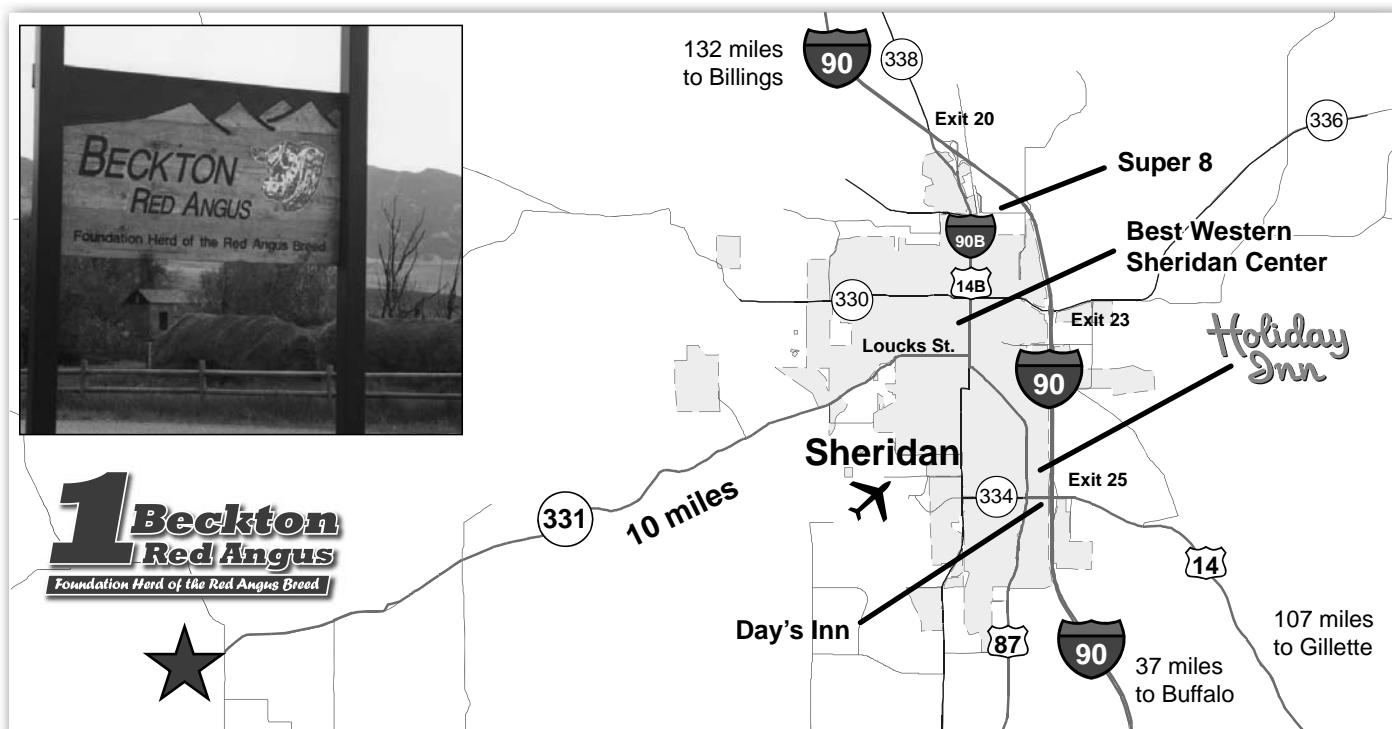

## All Bulls "Trich" Tested

In all the years we have been selling and delivering bulls, Beckton has never had a bull test positive for "trich". But because an increasing number of states require testing of yearling bulls, and to avoid any delay in delivery time, we will have all the sale bulls tested negative for "trich" prior to the sale. Customers from any state may also come to the sale with their trailer and load out directly after the sale.

## BECKTON BULL AND HEIFER WARRANTY

Optional protection against injury or death, plus Pregnancy coverage for heifers

**BULLS:** Injury or loss protection coverage - If your bull is permanently injured or dies any time up to 5 months after purchase, you will receive a credit toward purchase of another bull in the amount of the original purchase price minus salvage. The cost is 5% of the purchase price paid at settlement (eg. \$150 for a \$3,000 bull).

**HEIFERS:** Injury or loss protection plus Pregnancy Guarantee – likewise good for 5 months after purchase. If your heifer fails to become pregnant when exposed to a bull who settles 75% of the other heifers in the same pasture; or in the event your heifer is permanently injured or dies, you will receive a credit toward purchase of another heifer in the amount of the original purchase price minus any salvage. The cost is 10% of the purchase price paid at settlement (eg. \$200 for a \$2,000 heifer).

## Additional Sale Information

- ▶ The animals sell in catalog order. We will have a conference call available for telephone bidding. You must register in advance, and conference number and instructions will be available then.
- ▶ All bulls have passed a rigorous fertility exam that included live semen evaluation, scrotal measurements, and reproductive tract examinations.
- ▶ Beckton has a comprehensive herd-wide health program which includes vaccinations for 7-Way, IBR, BVD, PI3, BRSV, Lepto, and ivermectin. The heifers are also vaccinated for bangs and vibrio.
- ▶ When a genetic test was developed by RAAA for osteopetrosis (OS), Beckton tested every sire in use in our program, as well as our major AI sires. Every Beckton bred sire (nearly 80 in total) tested OS Free.
- ▶ We plan to have semen collected on some of the bulls before the sale. We will also work with the buyer to collect bulls after the sale.
- ▶ Buyer receives full possession and one half semen interest in all the bulls in the catalog. Seller is retaining one half interest in all bulls in the catalog. This is done so we can use some of the bulls in herd and reserve the right to collect and market semen on these bulls. Any collection on our behalf would be at our expense and could be done during the off-season and at the convenience of the buyer. The buyer would have the option to share in the collection and retain semen for the buyer's use also. If semen is marketed by either party, Seller receives one half royalty interest on gross semen sales, and buyer receives one half interest. Regardless of semen collection and marketing, the buyer retains full possession, full pasture use rights, and full salvage value in these bulls.
- ▶ Payments can be made with cash, check payable to Beckton Stock Farm, Inc. or Visa/Mastercard on sale day.

## Table of Contents

The Beckton Program . . . . .	4
The Bulls . . . . .	12
The Yearling Heifers . . . . .	64
Reference Sires. . . . .	73
RAAA Herd EPD Tables . . . . .	82
Sire Bloodline Charts. . . . .	84
Sale Terms & Conditions . . . . .	86
Lot-Tag Cross Reference. . . . .	87
Semen Available . . . . .	88

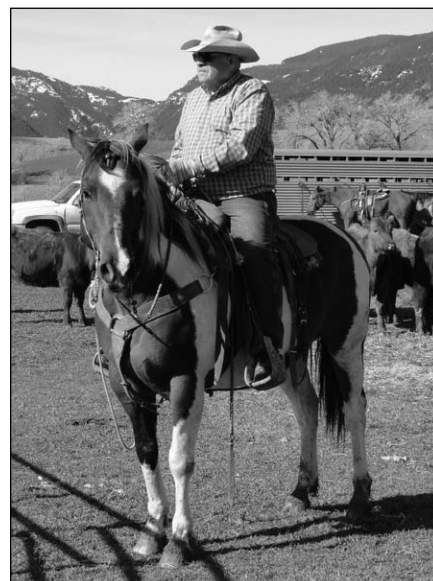

**Chuck Overturf**  
Friend and neighbor - helps us every year



**Bob Hough**  
817.296.0976



**Curt Cox**  
Wyoming Livestock  
Roundup  
307.630.4604



**Pete Crow**  
Western Livestock  
Journal  
303.722.7600



**Alan Sears**  
Western Livestock  
Reporter  
970.454.3986



**Del Tinsley**  
Wyoming Livestock  
Roundup  
307.234.2700



**Video of sale animals is available on our website, [www.BecktonRedAngus.com](http://www.BecktonRedAngus.com)**

Lots with small square "QR code" barcodes similar to the one at left have video available to view on your iPhone, Android, Blackberry, or Windows Phone. Simply Scan the code with a free downloadable barcode reader app and you can view video footage of the animal right on your phone screen.

**Don't have the app? Don't worry!** Simply visit your phone's App Store and search for a "QR Code" app. There are lots of free apps available; "i-nigma" is one that works well on all platforms. If you can't get your phone to work you can still watch all of the videos online using a computer.

VIDEOS BY:



[WWW.CATTLEINMOTION.COM](http://WWW.CATTLEINMOTION.COM)

## TOTAL PERFORMANCE IN THE MOST ECONOMICALLY IMPORTANT TRAITS

High reproduction rate; high calving rate; less time and cost to market weight; and lower total feed inputs and feed costs. Plus 70 years of selection for the convenience traits – good dispositions – cowherd fertility – good udders and milk – and structurally sound cattle well adapted to both high elevation and dry range conditions.

# The Beckton Program

## Cow Size

The goal for Beckton's program has always been to develop breeding seedstock which offer increased levels of performance for the commercial cattleman. Increased performance does not mean maximizing weight and size, which have already reached the upper limit of economic value for the packer and consumer. It does, however, mean increasing performance related to calving percentage and weaning percentage; and increasing performance related to cow maintenance requirements and "pounds of calf per acre" efficiency.

### Size Matters

Beckton cattle are already big enough for the consumer and the packer. Using yearling weight EPD as the best available indicator of market size, the average for our sale bulls is +80, about the same as the Red Angus breed average, so for market size our cattle are directly comparable.

The big difference with Beckton's program is that we select for additional weaning and yearling weight, but with the restriction that we have maintained the same cow size over time. In contrast, the industry has allowed cow size to increase at the same rate as calf size. Cow size is the largest factor determining maintenance requirements. Our goal has been to increase efficiency, not size. No other seedstock breeding program has had such a goal and maintained it for so long.

### Beckton Cow Weight Average (lb.)

Year	1978	1982	1986	1990	1994	1998	2002	2006	2010	2014
Wt.	1,126	1,126	1,064	1,115	1,067	1,125	1,104	1,093	1,068	1,106

(mature lactating cows taken at weaning)

Cow weights vary from year to year depending on grass, weather or other short term factors. But overall our cow size has stayed fairly constant over time.

### The Industry Problem

As shown on the graph on the next page, industry-wide cow size has increased substantially, 28% over this same period. USDA Economic Research Service data show that industry-wide hay use per cow has increased by more than 40% from 1978 to 2010, from 1.43 tons per animal unit to 2.08 tons. Cow size has increased by about 28% since the 1970's and production per cow is up about 27%, but hay use per cow is up more than 40%.

Industry-wide, production per cow is up about 25% since the 1970s, but hay consumption per cow is up more than 40%.

Why does hay use increase at a faster rate than cow size or production per cow? Hay and grain are supplements to the cow's main diet, which is grass, and grass supply is relatively fixed by environment. Each increase in cow feed requirement must be met entirely by supplements, or by a combination of supplement and reduced stocking rate. A small increase in cow feed requirement leads to a reduction in stocking rate or a large increase in higher-cost, supplemental feed needs.

Any gains achieved in the feedlot sector due to increased animal growth, have been overwhelmed by increased cost of production in the cow-calf sector.

## The Beckton Crew...



Randy Zier



Alan Sanders



Roger Zier



Sherry Kobielsuz

# Efficiency

**36 Years of Change: Industry-Wide**

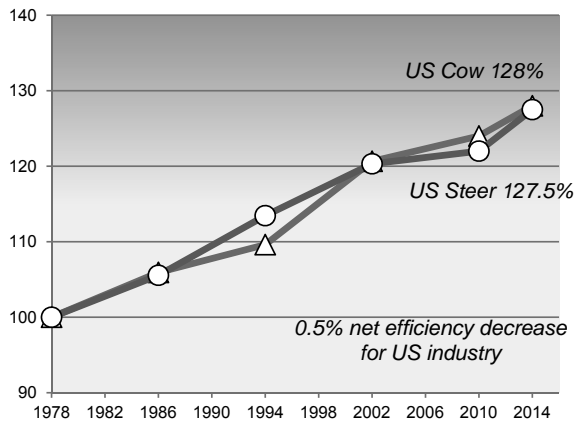

The graph at left shows how, for the U.S. cattle industry overall, the increase in average calf weights, as measured by steer slaughter weights, has been directly matched by an increase in average cow weights. (Percentages are based on USDA slaughter weight data for steers and cows respectively, using 1978 as a base year. Data for heifers slaughtered shows an identical trend.) Over 35 years, there has been minimal change in overall cowherd efficiency.

This graph shows the failure of cross-breeding and composite breeding to do little more than simply increase general cattle size. In the promotion of composites, the impact of retained heterosis on mature weight is too often ignored. Crossbreeding and composites are sold as a free lunch, but they aren't free.

We have accomplished this by selecting for growth, restricting birth weight and cow size creep, and multiplying each incremental change rapidly throughout our entire cowherd and all of our bloodlines. Usually this has meant working within our own bloodlines rather than introducing out-crosses, because the outside genetics for the direction we wanted to go haven't been available. The overall key to success is simply that we have been making small progress in multiple traits, but doing it consistently over a very long period of time.

**36 Years of Change: Beckton**

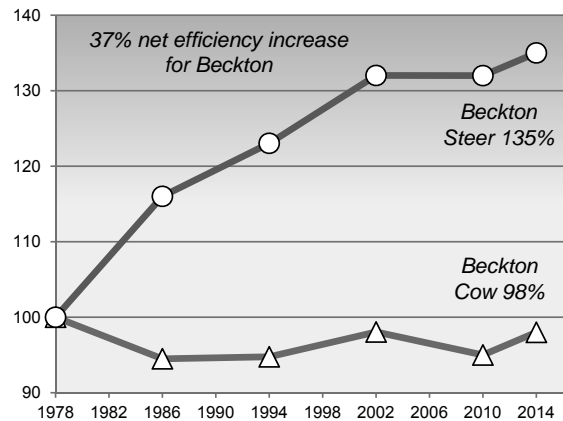

The graph at right shows Beckton cowherd data over the same time period.

1. Beckton cow size has shown no significant change over the past 35 years, while the industry has experienced a substantial increase in cow size.
2. Even without increasing cow size, we have raised the rate of early growth in Beckton cattle, using intense genetic selection and generation turnover, and by more than the rest of the industry.
3. The net change in efficiency as measured simply by "calf weight divided by cow weight" is significantly higher with Beckton's genetic program, compared to mainstream cross-breeding based on retained heterosis.

## ... making the Beckton Program work!



Morgan Armstrong



Matt Zier



Shelby Whitman



Tyler Miller

## Management

### One Bull – the Simple Solution is the Best Solution

Many cattlemen use Beckton bulls for their heifers because of their low birth weights and high calving ease. Our bulls are even better when used on cows, because replacement heifers tend to be selected from calves out of older cows. **Keeping replacement heifers sired by Beckton bulls is the quickest way to limit cow size creep and to moderate cow size for the future.** In our own program we use the same bulls on both heifers and cows. Every bull is used his first year with heifers to evaluate calving ease, and used in future years with older cows. We get calving ease, growth, and moderate-sized replacements, all with the same bull.

### Quietness and Ease of Handling

The necessity of record keeping means that our cattle will be handled much more than commercial cows. **This benefits our seedstock customers because our cattle will be quieter and easier to handle.** Good disposition is one of our most valued traits.

### Selection for Industry Requirements

In order to make selection decisions appropriate to the commercial beef industry, seedstock cattle need to be managed and measured under conditions which will approximate the commercial industry. **Our cows are run entirely on grass, with hay only if weather conditions require it, because that is how the commercial industry runs cows.** However, almost all commercial calves go into feedlots before slaughter, so feedlot performance and efficiency is an important trait for calves. **Simply put, a producer needs to know how his cows perform on grass, and how his calves perform with feed.**

Our bulls are run on a performance test designed to provide the fairest basis of comparison among them, and

this requires a compromise. Our bulls receive a “growing” ration high in roughage and protein and not as high in energy as a steer would receive. **We want to get a good measure of gainability with which to compare bulls, but we don’t want the bulls fat.**



*Craig Uden, Darr Feeders Manager*  
Photo courtesy of the Lexington Clipper-Herald

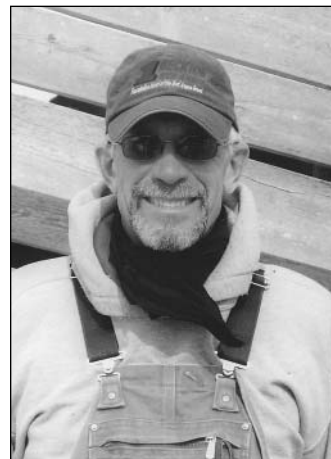

*Mitch Ziebell, Darr Feeders*

### Mitch Ziebell, Craig Uden of Darr, NE

Since 1979 all of our bulls have been performance tested at a facility owned and managed by the Kugler family near Cozad, Nebraska. In the fall of 2005, Lane Kugler retired and the operation was bought by a neighboring operation – Darr Feeders. The overall operation is managed by Craig Uden, with the bulls under the daily management of Mitch Ziebell. **We have been very impressed with the conscientious care with which Mitch oversees all aspects of the bull management.**

## Contributing to the success of the Beckton Program...



*Sarah Schreiber*  
*Our vet*



*Janet Drake*  
*Health Permit Expert ++*



*Cody Cunningham*  
*Brand Inspector*

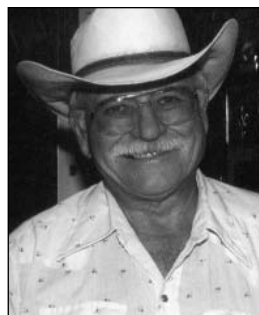

*Dr. Robert Bohlander*  
*Fertility tests the bulls*



*Bob Milner*  
*Our AI tech*



## Additional Facts about the Beckton Program

### Birth weight

- ▶ Every sire entering our own program is used first on our own heifers, then on our cows.
- ▶ We have never used high birth weight sires in any part of our program, so big birth weights are rare.
- ▶ We get the pay weight, but with lower birth weights and greater calving ease.
- ▶ Full production from heifers. We use the same bulls on heifers and cows.

### Growth

- ▶ Weaning efficiency, and rate of gain to slaughter weight second to none.
- ▶ Growth traits must be consistent with maintaining maternal qualities.
- ▶ Beckton cattle are ideally sized for today's packer demand.

### Hardiness

- ▶ Every cow in the herd has spent part of her life in the Big Horn Mountain summer range, at elevations from 7000 to 10,500 feet.
- ▶ In 2001 we PAP tested all of our herd sires. The herd average PAP score was 32.5 at 4000', equivalent to a herd average PAP of 39 at 8000' (excellent scores).
- ▶ By the time she is 5, our average cow will have been trailed over 80 miles, above and beyond normal pasture rotation.

### Efficiency

- ▶ The typical dam of our bulls weans over 50% of her body weight in 205 days, under range conditions, with no creep-feeding.
- ▶ The average dam produces over 100% of her own body weight in a year.
- ▶ The average mature cow (age 5+) weighs about 1100-1125 pounds.

### Fertility

- ▶ Every bull in our program is used in natural service, with 30-50 heifers/cows.
- ▶ Every cow in our program must cycle naturally and breed early under range conditions.

### Value

- ▶ Beckton Red Angus produce more growth without high birth weights.
- ▶ They are the one-bull solution that can be used on both heifers and cows.
- ▶ Carcass quality is an extra benefit.

### Reliability

- ▶ Beckton has been genetically improving Red Angus since 1945, a 30-60 year lead time over other producers.
- ▶ It is a complete, genetically sound breeding program, which demands whole-herd performance.



*Long-time friends and business associates Sue and Forest Dunning are almost retired from the Red Angus business*

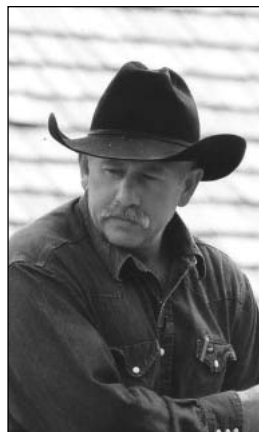

*Dave Nelson, long-time friend, neighbor, and helping hand*



*Cody and Chad Halfmann, Halfmann Red Angus Special thanks for helping to create the bull videos*

# Separating science from politics & marketing

## Red Angus unveils reliable, unbiased indices

by Larry Keenan, Director of Breed Improvement

The Red Angus Association of America (RAAA) implements a unique approach when developing genetic selection tools. In order to deliver the most reliable and unbiased data to Red Angus stakeholders, RAAA separates sound science from subjective politics and marketing.

RAAA achieves this through implementation of a non-political Technical Committee, which is populated by non-Board members and actually has decision-making powers regarding genetic predictions.

Once the technical committee is provided an assignment – such as developing economic selection indices – it is tasked with overseeing development and ultimately deciding if the tool – or index in this case – is dependable enough to release to stakeholders. While this process may slow the release of a new EPD or index, commercial producers can have confidence that once the tool is released, it is reliable.

Red Angus' work on economic selection indices provides an excellent example of the importance of such committee structure. RAAA previously had the ability to release an index; however, Technical Committee review revealed flaws in the proposed index that essentially caused it to be a marketing tool as opposed to a selection tool.

After multiple refinements to the index development software, RAAA is excited to announce that the Technical Committee has approved the release of the HerdBuilder and GridMaster indices.

### What are Indices?

The purpose of an index (plural – indices) is to estimate differences in an operation's overall profitability resulting from a particular selection decision. In developing an index to evaluate differences in profitability within an operation, assumptions must be made regarding the genetics of the cowherd (ex: average weaning weight) as well as economic values (ex: sale price of cull cows).

RAAA utilized the Red Angus database to determine the required cowherd assumptions. The economic assumptions were derived from input obtained from CattleFax and economic data from Texas A&M and North Dakota State University. Additionally, certain basic

production assumptions are made, such as: Will the bulls be used on heifers and/or cows? Are replacement heifers retained? When and how are calves marketed?

Once these assumptions were determined, the data was fed into a simulation model that accounted for the segments of the beef industry based on the assumptions. Finally, EPDs of the service sires were included in the simulation model to determine the overall impact the sires would have on the operation's profitability.

The EPDs included in the index calculation are independently changed one unit (ex: Stayability EPD of 10 vs. 11), and the resulting change in overall profitability determines the weightings placed on each EPD. It is important to understand that these EPD weightings are not determined, or adjusted, using human perceptions. Thus, the weightings, and ultimately the indices, are completely based on science.

While the process of calculating an index is very complex, the resulting selection tool is very simple to implement. RAAA's indices will be expressed to stakeholders as differences in profitability per exposure. For example, Bull A has an index value of 100 and Bull B has an index value of 150, and the selected bull would be mated to 120 cows over the bull's productive lifespan. Selecting Bull B would add an additional \$6,000  $[(150 - 100) \times 120]$  in profitability to the operation as compared to selecting Bull A.

While Red Angus bulls are selected by stakeholders to fit into various production scenarios, selection pressure is typically placed on herd-building traits or traits that increase the value of marketed product. Many producers have even developed their own selection index to assist them in identifying bulls that meet these goals. Typically these include thresholds for certain EPDs, but as most would admit, these thresholds are not strictly followed. Red Angus' selection indices will provide producers with a consistent selection tool built on a scientific, unbiased foundation.

---

## HerdBuilder Index

As the name indicates, implementation of the HerdBuilder Index will assist producers in building profitable herds. The HerdBuilder Index is built using the following production scenario:

- ▶ Red Angus bulls mated to cows and heifers (resulting progeny  $\frac{3}{4}$  Red Angus,  $\frac{1}{4}$  Simmental)
- ▶ Replacement heifers retained from within the herd
- ▶ All remaining progeny sold on a quality-based carcass grid.

Given that replacement heifers are retained, significant influence is placed on the obvious maternal EPDs of Stayability, Heifer Pregnancy and Calving Ease. Additionally, with all remaining progeny sold on a quality-based carcass grid, Marbling, Yield Grade and growth EPDs impact the HerdBuilder index.

## GridMaster Index

While Red Angus has traditionally been known as a superior maternal breed, those who have retained ownership in Red Angus calves know of their potential to excel in the feedyard and ultimately hang a premium carcass.

Red Angus stakeholders will quickly recognize the term “GridMaster,” as the Marketing Department annually recognizes load lots of harvested cattle with superior carcass observations as “Grid Master” Award winners.

Producers who place emphasis on the GridMaster Index in their selection decisions will not only experience an increase in their operation’s profitability; but as well can expect to see an increased number of calves recognized as Grid Master Award winners.

The GridMaster Index is built using the following production scenario:

- ▶ Red Angus bulls mated to cows (resulting progeny  $\frac{3}{4}$  Red Angus,  $\frac{1}{4}$  Simmental)
- ▶ All progeny sold on a quality-based carcass grid.

Thus, Marbling, Yield Grade and growth EPDs are the traits of primary importance in the GridMaster Index.

## What if my Production Scenario is Different?

While your operation may differ from the above index scenarios, our research shows that the two above situations will serve as reliable selection tools for the vast majority of ranches.

Use the GridMaster Index if your operation’s primary goal is maximizing profitability of feeders in the feedyard and on the rail.

For example, if your operation matches the HerdBuilder Index, except you would be using the selected bull on cows only, this small difference would not cause a significant change in the ranking of animals.

During committee discussions, the Technical Committee explored creating an additional HerdBuilder-Cow Index, which would use the same scenario as the above HerdBuilder except the bulls would only be used on cows. In comparing the HerdBuilder vs. HerdBuilder-Cow indices, we found that bulls ranked essentially the same between the two indices.

To be exact, the rank correlation was 0.97, which can be interpreted as only 3 in 100 bulls changed rank between the HerdBuilder and HerdBuilder-Cow. Thus demonstrating the robustness of the HerdBuilder Index, in that your production scenario can slightly deviate from the exact scenario in which the HerdBuilder Index was built, and the HerdBuilder Index can still serve as a reliable selection tool.

A quick study of the HerdBuilder and GridMaster Indices reveals that the main difference between these two indices is the source of replacement heifers. If the selected sire will be used to produce replacement females, the HerdBuilder Index should be used. However, if the selected sire will not be used to generate replacements, the GridMaster Index should be used.

Red Angus’ unwavering implementation of science has provided the foundation for the delivery of genetic selection tools with unmatched reliability. This precedence was strictly followed in the development and delivery of Red Angus’ HerdBuilder and GridMaster indices. Thus, stakeholders can have confidence that these new tools are truly genetic selection tools, and not just a marketing tool.

# Beckton History



*Sal keeping records.*



*Waldo Forbes - 1st President of the Red Angus Association.*



*Beckton house/office before being moved in 1905 to its current location. This house was built in the 1880s by George Beck, the original homesteader. The antlers are still on the porch, and it is one of the oldest buildings in Sheridan County.*



*The Waldo Forbes family in 1959: Ellen, Julia, Sal, Sarah, Cherry,, Spike, and Cam & Elfie in front.*



*Inspection Committee at Beckton (1954), including George and Vernice Chiga, Sal and Waldo Forbes and Spike.*



*Beckton Larkabeau O "220" in 1959 - the 1st Red Angus Bull at ABS*



*Mrs. Waldo (Sal) Forbes was honored as the first woman inducted into the Saddle and Sirloin Club's portrait gallery in Louisville, KY.*

## Using New Selection Tools

### HerdBuilder and GridMaster Indices

The new Red Angus Association HERDBuilder and GRIDMaster Indices are given for each sale animal, in the box just above the EPDs. The Index number is followed by the “Percentile” showing how that animal ranks compared to all other Red Angus bulls or heifers. A higher Index number results in a lower “Percentile” number, which means a higher ranking within the breed, and is therefore better. The development of these Indices by the RAAA is described in the article written by Larry Keenan and reprinted.

The familiar Birth Weight or Yearling Weight EPDs, for example, are measured in pounds of increase in weight, whereas these Indices are measured in ‘dollars of increase in profitability’ - the expected increase in profit that each animal is expected to generate per mating of that animal. A bull with a HerdBuilder Index of 160, compared to a second bull with an index of 110, should produce  $160 - 110 = 50$  dollars of expected increased profit for each cow to which he is mated, compared to the second bull (note that this is ‘per mating’, not ‘per calf produced’). The Index considers and weights all economic factors – fertility, calving ease, maintenance costs, growth rate, stayability, carcass quality, etc. - according to best available science,

You will find Beckton bulls individually and as a group ranking in the top of the breed for profitability, as measured by these new Indices.

### Maintenance EPD

This EPD predicts the relative feed energy requirement for maintenance, for cows produced by a sire or female. A bull with an ME of -3 (minus 3) is expected to sire replacement daughters which will need 10 fewer mcals of energy per month than a bull with an ME of +7.

We believe this is an important EPD because feed costs, both direct and indirect through ranch overhead, make up by far the largest proportion of operating costs. It can have much more direct impact on ranch profitability than Marbling or Ribeye EPD for example.

The Beckton herd has been one of the breed’s top herd for low maintenance energy requirements for many years.

### Calving Ease

The Red Angus Calving Ease EPD was introduced in 2003, and is a more direct measure of calving ease than birth weight alone. Calving Ease is defined as follows: “The expected differences of calving ease measured as the probability difference (between sires) of unassisted calvings among offspring.” For Calving Ease EPD, the higher number is better.

There are two Calving Ease EPD’s - “Direct”, a predictor of an animal’s own offspring; and “Maternal”, a predictor of a daughters calving ease. Unless stated otherwise, we publish the Calving Ease Direct because most of our customers’ primary concern is selecting bulls for use on first calf heifers.

Beckton’s average Calving Ease EPD is +12, a full eight points higher than the the Red Angus breed average of 4, due to our long history of selection for moderate birth weights. **The average Beckton bull is in the top 4% of the entire breed for highest Calving Ease.**

### Cow Efficiency

We present two indicators of efficiency. The first is Weaning Percent, a simple percentage of calf 205 day weight divided by the dam’s actual weight at weaning. The second is PRI Cow Efficiency. This also measures calf weaning weight, but relative to the cow’s metabolic weight, and is expressed as an index above or below 100.

These efficiency measures are best used as indicators of where an animal is relative to others, rather than directly for selection. For example, if we see an animal with a low efficiency, we would look at the actual calf and cow weights to decide if the calf is too small, or the cow too big for the environment. That in turn will suggest corrective actions. In general, select for the traits you need to change to make cattle more efficient, and efficiency will be the result.

**Beckton has been performance tested selection since 1945, and we believe our cattle today are the most efficient in the industry.**

### Dam Information

A major difference with our catalog is the greater amount of information about the dams we provide. Weaning percent and Cow Efficiency are explained above. In addition, with each sale animal we give the dam’s age when this calf was born, and the dam’s actual weight when the calf was weaned the previous fall. We also provide her progeny averages – the average birth weight, weaning ratio, and yearling ratio – of her calves.

# The Bulls

Our bulls are managed in a manner to gain important performance data and information, and equally importantly, to develop and provide our customers with many years of productive service. We have been testing breeding bulls over 50 years, longer than almost any other producer. Our own breeding is based primarily on natural service, not AI, so we see how our bulls work in the pasture. We use bulls raised and managed just this way, with our own cows and heifers, on every kind of terrain, and high in the Bighorn Mountains.

For the first twenty years our bulls were tested at home here in Wyoming. They received some grain, but otherwise grass pasture and dry hay. In 1979 we moved our test to a facility managed by the Kugler family in Cozad, Nebraska, where the bulls got a ration including silage, corn and protein. When we brought our first bulls home from Kuglers' and used them with our own cowherd, we discovered a dramatic increase in libido and breeding performance. The effect of proper

nutrition was apparent, and the bulls would maintain condition and hold up better through the entire breeding season. We have continued managing our bulls at the same facility ever since (now managed by Craig Uden), and we continue to see the same benefits.

We have since used over 500 of these bulls natural service in our own breeding program, on dry range and in the mountains, and have never had a bull fall out of our program early due to his feeding or testing management. Beckton Julian B571, Lancer F442, Nebula M045, Nebula P707, and all of our other great sires were fed and managed in Cozad. While it is possible to feed bulls improperly under any structure, we would strongly question those who promote the notion of any advantage to "forage-raised" bulls. Every year we see the results and success of our bull management program, and we serve many satisfied customers.



• Bulls •

**1** **BECKTON JULIAN B478 C4**   
 1-A 100% # 1706028 Tat.: BKT4 B478  
 Birth: 3-27-14  
 Beckton Julian 7526G < Beckton Julian 6592  
 Bkt Belga 6746 GS  
**BECKTON JULIAN GG B571** < Beckton Julian 7526G  
 Ref. J-1 < Bkt Marta 6498 XM  
 Bkt Marta 9A13 JL  
 BWT **65**  
 WR **108**  
 ADG **3.69**  
 YWt. **1142**  
 YR **104**  
 Scr. **36**  
 Fr. **5.0**  
 Beckton Cherokee T450 L3 < Beckton Cherokee N N479  
 Beckton Annie M337 LN  
**BECKTON TARA X196 C** < Beckton Julian GG B571  
 Beckton Tara M635 JL < Beckton Tara J266 HR

DAM		RAAA HerdBuilder index: <b>199</b> (Top 1% of all RA bulls)									
Age	4	RAAA GridMaster index: <b>53</b> (Top 8% of all RA bulls)									
Wt	1222	Calv.Ease	BW	WW	YW	Milk	HPG	Stay	Maint.En.	EPDs	
Prog.BW	60	<b>18</b>	<b>-7.4</b>	<b>46</b>	<b>74</b>	<b>23</b>	<b>11</b>	<b>16</b>	<b>-3.0</b>		
WR	<b>106</b>	Marb	<b>+0.56</b>	REA	<b>+1.14</b>	Bfat	<b>+0.2</b>				
YR	<b>101</b>										
Wean Pct.	<b>48%</b>										
Cow Eff.	<b>101</b>										

★★★★★ for Low Maintenance, Marbling, Rib-eye area, Calving Ease, Stayability.



**3** **BECKTON ACCENT B186 N3**   
 1-A 100% # 1705467 Tat.: BSF4 B186  
 Birth: 3-12-14  
 Beckton Cody K1 P014 < Beckton Cody KH M390  
 Beckton Rose M126 WR  
**BECKTON ACCENT W180 C2** < Beckton Cherokee N N479  
 Ref. A-2 < Beckton Christy R046 CQ < Beckton Christy N740 HR  
 Beckton Nebula P P707 < Beckton Nebula M045  
 Beckton Lana M809 EP  
**BECKTON BIRDIE S110 NB** < Beckton Warrior CL M686  
 Beckton Birdie P086 WR < Beckton Birdie M877 LO

DAM		RAAA HerdBuilder index: <b>178</b> (Top 4% of all RA bulls)									
Age	8	RAAA GridMaster index: <b>54</b> (Top 3% of all RA bulls)									
Wt	1120	Calv.Ease	BW	WW	YW	Milk	HPG	Stay	Maint.En.	EPDs	
Prog.BW	65	<b>13</b>	<b>-4.9</b>	<b>61</b>	<b>95</b>	<b>22</b>	<b>12</b>	<b>15</b>	<b>-2.2</b>		
WR	<b>102</b>	Marb	<b>+0.62</b>	REA	<b>+0.21</b>	Bfat	<b>+0.3</b>				
YR	<b>100</b>										
Wean Pct.	<b>53%</b>										
Cow Eff.	<b>111</b>										

★★★★★ for Low Maintenance, Growth, Gainability, Marbling, Rib-eye area, Calving Ease, Stayability.

**4** **BECKTON NEBULA B345 J3**   
 1-A 100% # 1705478 Tat.: BSF4 B345  
 Birth: 3-22-14  
 Beckton Nebula M045 < Beckton Neptune R2 K065  
 Beckton Belga K285 JL  
**BECKTON NEBULA P P707** < Beckton Epic K1 K863  
 Ref. N-2 < Beckton Lana M809 EP < Beckton Lana K253 DM  
 Beckton Justice CH M056  
 Beckton Justice C1 R483 < Beckton Tamara J124 HR  
**BKT LARKEISA T310 JC** < Beckton Justice C K449  
 BKT Larkeisa R775 JC < BKT Larkeisa L149 CK

DAM		RAAA HerdBuilder index: <b>197</b> (Top 1% of all RA bulls)									
Age	7	RAAA GridMaster index: <b>55</b> (Top 1% of all RA bulls)									
Wt	1190	Calv.Ease	BW	WW	YW	Milk	HPG	Stay	Maint.En.	EPDs	
Prog.BW	62	<b>14</b>	<b>-7.5</b>	<b>50</b>	<b>88</b>	<b>24</b>	<b>12</b>	<b>16</b>	<b>-2.8</b>		
WR	<b>108</b>	Marb	<b>+0.78</b>	REA	<b>-0.17</b>	Bfat	<b>+0.3</b>				
YR	<b>108</b>										
Wean Pct.	<b>47%</b>										
Cow Eff.	<b>99</b>										

★★★★★ for Low Maintenance, Marbling, Superior Cow, Calving Ease, Stayability.

**2** **BECKTON JULIAN B520 N4**   
 1-A 100% # 1705991 Tat.: BKT4 B520  
 Birth: 3-29-14  
 Beckton Julian 7526G < Beckton Julian 6592  
 Bkt Belga 6746 GS  
**BECKTON JULIAN GG B571** < Beckton Julian 7526G  
 Ref. J-1 < Bkt Marta 6498 XM  
 Bkt Marta 9A13 JL  
 BWT **78**  
 WR **102**  
 ADG **3.75**  
 YWt. **1106**  
 YR **100**  
 Scr. **32**  
 Fr. **5.0**  
 Beckton Nebula T315 W2 < Beckton Nebula M045  
 Beckton Birdie P086 WR  
**BECKTON INDIGO W617 N** < Beckton Jerome E N786  
 Beckton Indigo T707 JM < Beckton Indigo N475 WR

DAM		RAAA HerdBuilder index: <b>200</b> (Top 1% of all RA bulls)									
Age	5	RAAA GridMaster index: <b>52</b> (Top 19% of all RA bulls)									
Wt	1016	Calv.Ease	BW	WW	YW	Milk	HPG	Stay	Maint.En.	EPDs	
Prog.BW	59	<b>17</b>	<b>-3.7</b>	<b>51</b>	<b>80</b>	<b>19</b>	<b>12</b>	<b>16</b>	<b>-6.8</b>		
WR	<b>100</b>	Marb	<b>+0.57</b>	REA	<b>+1.14</b>	Bfat	<b>+0.2</b>				
YR	<b>100</b>										
Wean Pct.	<b>53%</b>										
Cow Eff.	<b>111</b>										

★★★★★ for Low Maintenance, Marbling, Rib-eye area, Calving Ease, Stayability.

**5** **BECKTON NEW ERA B236 N2**   
 1-A 100% # 1705527 Tat.: BSF4 B236  
 Birth: 3-17-14  
 Beckton Nebula P P707 < Beckton Nebula M045  
 Beckton Lana M809 EP  
**BECKTON NEW ERA Y194** < Beckton Justice C1 R483  
 Ref. N-6 < BKT Larkeisa T310 JC < BKT Larkeisa R775 JC  
 Beckton Nebula L P093  
 Beckton Vernice L382 LN  
 Beckton Nebula E P084  
**BECKTON LANA W113 N** < Beckton Lana P026 DM  
 Beckton Lana T226 NB

DAM		RAAA HerdBuilder index: <b>205</b> (Top 1% of all RA bulls)									
Age	5	RAAA GridMaster index: <b>53</b> (Top 7% of all RA bulls)									
Wt	974	Calv.Ease	BW	WW	YW	Milk	HPG	Stay	Maint.En.	EPDs	
Prog.BW	74	<b>11</b>	<b>-3.0</b>	<b>64</b>	<b>107</b>	<b>17</b>	<b>12</b>	<b>18</b>	<b>-6.7</b>		
WR	<b>97</b>	Marb	<b>+0.51</b>	REA	<b>-0.08</b>	Bfat	<b>+0.3</b>				
YR	<b>103</b>										
Wean Pct.	<b>53%</b>										
Cow Eff.	<b>111</b>										

★★★★★ for Low Maintenance, Gainability, Marbling, Calving Ease, Stayability.

• Bulls •

**6** **BECKTON NEW ERA B219 D2**   
 1-A 100% # 1705820 Tat.: BKT4 B219  
 Birth: 3-15-14  
 Beckton Nebula P P707 < Beckton Nebula M045  
 Beckton Lana M809 EP  
**BECKTON NEW ERA Y194**  
 Ref. N-6 BKT Larkeisa T310 JC < Beckton Justice C1 R483  
 BKT Larkeisa R775 JC  
 Beckton Dominor ZC M919 < Beckton Dominor Z E401  
 Beckton Barmaid J012 CO  
**BECKTON BELGA R716 DM**  
 Beckton Belga K285 JL < Beckton Julian GG B571  
 Beckton Belga G493 HR

BWt	71
WR	106
ADG	3.92
YWt.	1139
YR	103
Scr.	34
Fr.	5.0

**DAM**  
 Age 9  
 Wt 1212  
 Prog.BW 69  
 WR 106  
 YR 105  
 Wean Pct. 46%  
 Cow Eff. 97

RAAA HerdBuilder index: **195** (Top 2% of all RA bulls)  
 RAAA GridMaster index: **54** (Top 4% of all RA bulls)  
 Calv.Ease BW WW YW Milk HPG Stay Maint.En.  
 EPDs **13 -5.0 57 98 25 9 17 -3.7**  
 Marb **+5.8** REA **-1.1** Bfat **+0.4**

★★★★★ for Low Maintenance, Marbling, Superior Cow, Calving Ease, Stayability.

**8** **BECKTON ACCENT B259 W2**   
 1-A 100% # 1705869 Tat.: BKT4 B259  
 Birth: 3-18-14  
 Beckton Cody K1 P014 < Beckton Cody KH M390  
 Beckton Rose M126 WR  
**BECKTON ACCENT W180 C2**  
 Ref. A-2 Beckton Christy R046 CQ < Beckton Cherokee N N479  
 Beckton Christy N740 HR  
 Beckton Warrior T1 H281  
**BECKTON COCA T515 WA**  
 Beckton Warhawk N560 < Beckton Firefly H195 HD  
 Beckton Coca M637 LO < Beckton Loki F251  
 Beckton Coca H132 HD

BWt	69
WR	100
ADG	3.81
YWt.	1109
YR	100
Scr.	36
Fr.	5.5

**DAM**  
 Age 7  
 Wt 1020  
 Prog.BW 67  
 WR 94  
 YR 96  
 Wean Pct. 51%  
 Cow Eff. 108

RAAA HerdBuilder index: **178** (Top 4% of all RA bulls)  
 RAAA GridMaster index: **54** (Top 4% of all RA bulls)  
 Calv.Ease BW WW YW Milk HPG Stay Maint.En.  
 EPDs **14 -6.2 55 89 18 14 13 -6.0**  
 Marb **+6.0** REA **+1.8** Bfat **+0.4**

★★★★★ for Low Maintenance, Marbling, Rib-eye area, Calving Ease, Stayability.

**7** **BECKTON ACCENT B397 E2**   
 1-A 100% # 1705877 Tat.: BKT4 B397  
 Birth: 3-25-14  
 Beckton Cody K1 P014 < Beckton Cody KH M390  
 Beckton Rose M126 WR  
**BECKTON ACCENT U777 C2**  
 Ref. A-1 Beckton Susan R022 CQ < Beckton Cherokee N N479  
 Beckton Susan N023 JE  
 Beckton Epic K4 N795 < Beckton Epic KJ J722  
 Beckton Sierra J789 EP  
**BECKTON SUSAN T685 EP**  
 Beckton Susan P090 CE < Beckton Cruiser K118  
 Beckton Susan L258 LR

BWt	70
WR	110
ADG	4.15
YWt.	1240
YR	112
Scr.	36
Fr.	6.0

**DAM**  
 Age 7  
 Wt 1210  
 Prog.BW 69  
 WR 101  
 YR 108  
 Wean Pct. 48%  
 Cow Eff. 101

RAAA HerdBuilder index: **155** (Top 12% of all RA bulls)  
 RAAA GridMaster index: **53** (Top 8% of all RA bulls)  
 Calv.Ease BW WW YW Milk HPG Stay Maint.En.  
 EPDs **11 -4.9 53 89 25 7 14 -4.3**  
 Marb **+6.1** REA **+0.5** Bfat **+0.3**

★★★★★ for Low Maintenance, Growth, Gainability, Marbling, Calving Ease, Stayability.



Lot 8



Lot 7

**9** **BECKTON ACCENT B643 H3**   
 1-A 100% # 1705916 Tat.: BKT4 B643  
 Birth: 4-7-14  
 Beckton Accent U777 C2 < Beckton Cody K1 P014  
 Beckton Susan R022 CQ  
**BECKTON ACCENT Y312 N3**  
 Ref. A-4 BKT Larkeisa S055 NB < Beckton Nebula P P707  
 Beckton Larkeisa P688 CH  
 Beckton Hasten H S462 < Beckton Hasten P292  
 Beckton Lakme G128 HD  
**BKT LARKEISA U535 HS**  
 BKT Larkeisa S637 HS < Beckton Hasten P292  
 BKT Larkeisa J800 LN

BWt	80
WR	116
ADG	4.38
YWt.	1246
YR	113
Scr.	36
Fr.	5.0

**DAM**  
 Age 6  
 Wt 1154  
 Prog.BW 71  
 WR 110  
 YR 105  
 Wean Pct. 53%  
 Cow Eff. 111

RAAA HerdBuilder index: **183** (Top 3% of all RA bulls)  
 RAAA GridMaster index: **53** (Top 5% of all RA bulls)  
 Calv.Ease BW WW YW Milk HPG Stay Maint.En.  
 EPDs **13 -3.6 61 93 25 10 15 -6.9**  
 Marb **+5.4** REA **-0.1** Bfat **+0.5**

★★★★★ for Low Maintenance, Growth, Gainability, Marbling, Superior Cow, Calving Ease, Stayability.



• Bulls •



**12 BECKTON HERITAGE B584 R4**  
 1-A 100% # 1706060 Tat.: BKT4 B584

Birth: 4-3-14

Beckton Heritage T270 J2  
 Beckton Heritage N013  
 Beckton Coca P602 JL

**BECKTON HERITAGE X403 L3**  
 Ref. H-1 Beckton Indigo H150 LN  
 Beckton Lancer TE F363  
 Beckton Indigo F376 CT

Beckton Ranger T603 H3  
 Beckton Ranger 9479R

**BECKTON LYDIA X562 R**  
 Beckton Lydia S069 NB  
 Beckton Rose N044 HU  
 Beckton Nebula P P707  
 Beckton Lydia P583 WR

**DAM**  
 Age 4  
 Wt 950  
 Prog. BW 70  
 WR 106  
 YR 100  
 Wean Pct. 66%  
 Cow Eff. 139

RAAA HerdBuilder index: **184** (Top 3% of all RA bulls)  
 RAAA GridMaster index: **53** (Top 5% of all RA bulls)

	Calv. Ease	BW	WW	YW	Milk	HPG	Stay	Maint. En.
EPDs	12	-1.9	65	97	17	12	14	-11.5

Marb **+0.61** REA **-0.03** Bfat **+0.04**

Fr. **5.5**

★★★★★ for Low Maintenance, Marbling, High Cow Efficiency, Calving Ease, Stayability.

**10 BECKTON JULIAN B534 J6**  
 1-A 100% # 1705931 Tat.: BKT4 B534

Birth: 3-30-14

Beckton Julian G5 S107  
 Beckton Julian GJ P535  
 Beckton Minola P826 DM

**BECKTON JULIAN X465 J5**  
 Ref. J-4 Beckton Suffeina P643 JL  
 Beckton Julian GG B571  
 Bkt Suffeina A828 DM

Beckton Julian G5 S107  
 Beckton Julian GJ P535  
 Beckton Minola P826 DM

**BECKTON LANA U840 JL**  
 Beckton Lana S827 JL  
 Beckton Julian G2 M345  
 Beckton Lana N163 JL

**DAM**  
 Age 6  
 Wt 994  
 Prog. BW 58  
 WR 105  
 YR 102  
 Wean Pct. 56%  
 Cow Eff. 117

RAAA HerdBuilder index: **193** (Top 2% of all RA bulls)  
 RAAA GridMaster index: **53** (Top 7% of all RA bulls)

	Calv. Ease	BW	WW	YW	Milk	HPG	Stay	Maint. En.
EPDs	12	-3.2	54	88	20	15	16	-7.6

Marb **+0.65** REA **-0.05** Bfat **+0.05**

Fr. **5.5**

★★★★★ for Low Maintenance, Marbling, High Cow Efficiency, Calving Ease, Stayability.



Lot 13

**11 BECKTON HERITAGE B257 N4**  
 1-A 100% # 1705491 Tat.: BSF4 B257

Birth: 3-18-14

Beckton Heritage T270 J2  
 Beckton Heritage N013  
 Beckton Coca P602 JL

**BECKTON HERITAGE X403 L3**  
 Ref. H-1 Beckton Indigo H150 LN  
 Beckton Lancer TE F363  
 Beckton Indigo F376 CT

Beckton Nebula L P093  
 Beckton Nebula M045  
 Beckton Marta M021 LN

**BECKTON ENCINO U181 NB**  
 Beckton Encino H115 HD  
 Beckton Hadrian F C486  
 Beckton Encino E527 TO

**DAM**  
 Age 6  
 Wt 1180  
 Prog. BW 65  
 WR 106  
 YR 105  
 Wean Pct. 49%  
 Cow Eff. 102

RAAA HerdBuilder index: **172** (Top 5% of all RA bulls)  
 RAAA GridMaster index: **54** (Top 3% of all RA bulls)

	Calv. Ease	BW	WW	YW	Milk	HPG	Stay	Maint. En.
EPDs	12	-5.1	59	87	17	11	14	-0.9

Marb **+0.61** REA **+0.02** Bfat **+0.03**

Fr. **5.5**

★★★★★ for Low Maintenance, Growth, Marbling, Superior Cow, Calving Ease, Stayability.

**13 BECKTON DOMINOR B350 N6**  
 1-A 100% # 1706020 Tat.: BKT4 B350

Birth: 3-23-14

Beckton Dominor Z1 R610  
 Beckton Dominor ZC M919  
 Beckton Sierra K557 LO

**BECKTON DOMINOR W640 C5**  
 Ref. D-1 Beckton Mona R166 CQ  
 Beckton Cherokee N N479  
 Beckton Mona N342 HU

Beckton Nebula U206 V3  
 Beckton Nebula P P707  
 Beckton Minerva J615 VG

**BECKTON MINERVA X089 N**  
 Beckton Minerva U169 CD  
 Beckton Cody K2 R168  
 Beckton Minerva L324 LN

**DAM**  
 Age 4  
 Wt 1026  
 Prog. BW 62  
 WR 108  
 YR 110  
 Wean Pct. 56%  
 Cow Eff. 118

RAAA HerdBuilder index: **177** (Top 4% of all RA bulls)  
 RAAA GridMaster index: **54** (Top 3% of all RA bulls)

	Calv. Ease	BW	WW	YW	Milk	HPG	Stay	Maint. En.
EPDs	12	-6.5	52	83	24	11	16	3.3

Marb **+0.58** REA **+0.00** Bfat **+0.03**

Fr. **5.5**

★★★★★ for Low Maintenance, Marbling, Superior Cow, High Cow Efficiency, Calving Ease, Stayability.

• Bulls •

**14** **BECKTON ACCENT B468 N3**  
1-A 100% # 1705534 Tat.: BSF4 B468



Birth: 3-27-14

Beckton Accent W180 C2  
**BECKTON ACCENT Y260 L3**  
Ref. A-3  
Beckton Lana W463 L

Beckton Cody K1 P014  
Beckton Christy R046 CQ  
Beckton Loki CL S284  
Beckton Lana R327 EP  
Beckton Nebula M045  
Beckton Marta M021 LN  
Beckton Loki C M740  
Beckton Encino N076 PG

BWt **77**  
WR **118**  
ADG **3.98**  
YWt. **1187**  
YR **107**  
Scr. **40**  
Fr. **5.5**

Beckton Nebula L P093  
**BECKTON ENCINO W287 N**  
Beckton Encino S303 LO

**DAM**  
Age 5  
Wt 1220  
Prog.BW 76  
WR 117  
YR 108  
Wean Pct. 51%  
Cow Eff. 107

RAAA HerdBuilder index: **175** (Top 4% of all RA bulls)  
RAAA GridMaster index: **53** (Top 6% of all RA bulls)  
Calv.Ease BW WW YW Milk HPG Stay Maint.En.  
EPDs **9 -2.5 71 110 21 7 17 2.8**  
Marb **+0.50** REA **-0.01** Bfat **+0.2**

★★★★★ for Low Maintenance, Growth, Marbling, Superior Cow, Calving Ease, Stayability.

**17** **BECKTON NEW ERA B446 E2**  
1-A 100% # 1706010 Tat.: BKT4 B446



Birth: 3-27-14

Beckton Nebula P P707  
**BECKTON NEW ERA Y194**  
Ref. N-6  
BKT Larkeisa T310 JC

Beckton Nebula M045  
Beckton Lana M809 EP  
Beckton Justice C1 R483  
BKT Larkeisa R775 JC  
Beckton Epic KM M115  
Beckton Sierra N703 LM  
Beckton Heritage N013  
Beckton Belga N308 NP

BWt **82**  
WR **114**  
ADG **4.09**  
YWt. **1260**  
YR **114**  
Scr. **37**  
Fr. **6.0**

Beckton Epic K6 S569  
**BECKTON BELGA W895 E**  
Beckton Belga T650 HT

**DAM**  
Age 5  
Wt 1108  
Prog.BW 77  
WR 113  
YR 108  
Wean Pct. 54%  
Cow Eff. 113

RAAA HerdBuilder index: **156** (Top 11% of all RA bulls)  
RAAA GridMaster index: **54** (Top 4% of all RA bulls)  
Calv.Ease BW WW YW Milk HPG Stay Maint.En.  
EPDs **9 -1.6 69 114 28 9 14 0.3**  
Marb **+0.65** REA **-0.15** Bfat **+0.04**

★★★★★ for Low Maintenance, Growth, Gainability, Marbling, Superior Cow, Calving Ease, Stayability.

**15** **BECKTON ACCENT B390 N3**  
1-A 100% # 1705476 Tat.: BSF4 B390



Birth: 3-25-14

Beckton Accent W180 C2  
**BECKTON ACCENT Y260 L3**  
Ref. A-3  
Beckton Lana W463 L

Beckton Cody K1 P014  
Beckton Christy R046 CQ  
Beckton Loki CL S284  
Beckton Lana R327 EP  
Beckton Nebula M045  
Beckton Lana M621 LN  
Beckton Warrior CL M686  
Beckton Coca K480 CO

BWt **72**  
WR **106**  
ADG **3.58**  
YWt. **1127**  
YR **102**  
Scr. **37**  
Fr. **5.5**

Beckton Nebula N R573  
**BECKTON COCA T080 NB**  
Beckton Coca R375 WR

**DAM**  
Age 7  
Wt 1020  
Prog.BW 57  
WR 94  
YR 98  
Wean Pct. 58%  
Cow Eff. 122

RAAA HerdBuilder index: **201** (Top 1% of all RA bulls)  
RAAA GridMaster index: **53** (Top 5% of all RA bulls)  
Calv.Ease BW WW YW Milk HPG Stay Maint.En.  
EPDs **13 -5.3 59 89 21 11 17 -6.5**  
Marb **+0.45** REA **-0.07** Bfat **+0.02**

★★★★★ for Low Maintenance, Marbling, High Cow Efficiency, Calving Ease, Stayability.

**18** **BECKTON NEW ERA B303 V2**  
1-A 100% # 1705512 Tat.: BSF4 B303



Birth: 3-20-14

Beckton Nebula P P707  
**BECKTON NEW ERA Y194**  
Ref. N-6  
BKT Larkeisa T310 JC

Beckton Nebula M045  
Beckton Lana M809 EP  
Beckton Justice C1 R483  
BKT Larkeisa R775 JC  
Beckton Vegas S1 K316  
Beckton Lydia H159 JL  
Beckton Hustler C2 L079  
Beckton Lana H544 WR

BWt **88**  
WR **109**  
ADG **4.15**  
YWt. **1168**  
YR **106**  
Scr. **37**  
Fr. **5.5**

Beckton Vega P079  
**BECKTON LANA U640 VA**  
Beckton Lana R810 HU

**DAM**  
Age 6  
Wt 1226  
Prog.BW 82  
WR 109  
YR 108  
Wean Pct. 47%  
Cow Eff. 99

RAAA HerdBuilder index: **141** (Top 21% of all RA bulls)  
RAAA GridMaster index: **52** (Top 13% of all RA bulls)  
Calv.Ease BW WW YW Milk HPG Stay Maint.En.  
EPDs **9 -0.2 69 110 20 8 13 2.2**  
Marb **+0.65** REA **-0.09** Bfat **+0.01**

★★★★★ for Low Maintenance, Growth, Gainability, Marbling, Superior Cow, Calving Ease, Stayability.

**16** **BECKTON ACCENT B008 A3**  
1-A 100% # 1706253 Tat.: BKT4 B008



Birth: 2-11-14

Beckton Accent W180 C2  
**BECKTON ACCENT Z506 J3**  
Ref. A-5  
Beckton Susan P857 JO

Beckton Cody K1 P014  
Beckton Christy R046 CQ  
Beckton Julio L233  
Beckton Susan G199 CO  
Beckton Cody K1 P014  
Beckton Christy R046 CQ  
Beckton Ranger T603 H3  
Beckton Lana T448 JR

BWt **61**  
WR **112**  
ADG **3.92**  
YWt. **1152**  
YR **111**  
Scr. **32**  
Fr. **5.5**

Beckton Accent W180 C2  
**BECKTON LANA Z669 A**  
Beckton Lana W164 R

**DAM**  
Age 2  
Wt 882  
Prog.BW 61  
WR 112  
YR 111  
Wean Pct. 52%  
Cow Eff. 109

RAAA HerdBuilder index: **169** (Top 6% of all RA bulls)  
RAAA GridMaster index: **54** (Top 4% of all RA bulls)  
Calv.Ease BW WW YW Milk HPG Stay Maint.En.  
EPDs **10 -4.0 62 97 25 11 15 -4.5**  
Marb **+0.49** REA **+0.14** Bfat **+0.05**

★★★★★ for Low Maintenance, Growth, Marbling, Rib-eye area, Superior Cow, Calving Ease, Stayability.



• Bulls •

**19** **BECKTON EPIC B615 L7**  
1-A 100% # 1705466 Tat.: BSF4 B615



Birth: 4-4-14

Beckton Epic U749 D5  
**BECKTON EPIC Y484 N6**  
Ref. E-5

Beckton Lydia S069 NB

Beckton Lasso P741  
**BECKTON SIERRA S065 LO**  
Beckton Sierra P027 LN

Beckton Epic K4 N795  
Beckton Denise R308 DM  
Beckton Nebula P P707  
Beckton Lydia P583 WR  
Beckton Lancer T1 H080  
Beckton Ruth G534 NP  
Beckton Lancer T6 M467  
Beckton Sierra M258 LN

BWt **89**  
WR **118**  
ADG **4.66**  
YWt **1289**  
YR **117**  
Scr. **37**  
Fr. **6.5**

**DAM**  
Age 8  
Wt 1282  
Prog.BW 77  
WR 110  
YR 111  
Wean Pct. 48%  
Cow Eff. 102

RAAA HerdBuilder index: **122**(Top 40% of all RA bulls)  
RAAA GridMaster index: **50**(Top 49% of all RA bulls)  
Calv.Ease BW WW YW Milk HPG Stay Maint.En.  
EPDs **7 0.8 65 110 24 9 13 4.5**  
Marb **+0.51** REA **+1.12** Bfat **+0.1**

★★★★★ for Growth, Gainability, Marbling, Superior Cow, Calving Ease, Stayability.

**22** **BECKTON NEW ERA B416 W2**  
1-A 100% # 1705451 Tat.: BSF4 B416



Birth: 3-26-14

Beckton Nebula P P707  
**BECKTON NEW ERA Y194**  
Ref. N-6

BKT Larkeisa T310 JC

Beckton Warhawk N560  
**BKT LARKABEL R038 WA**  
Beckton Larkabel N769 HR

Beckton Nebula M045  
Beckton Lana M809 EP  
Beckton Justice C1 R483  
BKT Larkeisa R775 JC  
Beckton Warrior T1 H281  
Beckton Firefly H195 HD  
Beckton Herald FJ J776  
Bkt Larkabel F246 CT

BWt **82**  
WR **104**  
ADG **4.77**  
YWt **1213**  
YR **110**  
Scr. **34**  
Fr. **5.5**

**DAM**  
Age 9  
Wt 1184  
Prog.BW 75  
WR 99  
YR 101  
Wean Pct. 46%  
Cow Eff. 97

RAAA HerdBuilder index: **168** (Top 7% of all RA bulls)  
RAAA GridMaster index: **52**(Top 12% of all RA bulls)  
Calv.Ease BW WW YW Milk HPG Stay Maint.En.  
EPDs **11 -1.9 64 105 21 14 14 -2.7**  
Marb **+0.53** REA **-1.15** Bfat **+0.02**

★★★★★ for Low Maintenance, Growth, Gainability, Marbling, Calving Ease, Stayability.

**20** **BECKTON JULIAN B214 D6**  
1-A 100% # 1705819 Tat.: BKT4 B214



Birth: 3-14-14

Beckton Julian G5 S107  
**BECKTON JULIAN X465 J5**  
Ref. J-4

Beckton Suffeina P643 JL

Beckton Dominor ZC M919  
**BKT LARKEISA R676 DM**  
BKT Larkeisa M816 EP

Beckton Julian GJ P535  
Beckton Minola P826 DM  
Beckton Julian GG B571  
Bkt Suffeina A828 DM  
Beckton Dominor Z E401  
Beckton Barmaid J012 CO  
Beckton Epic KJ J722  
BKT Larkeisa J076 DM

BWt **77**  
WR **97**  
ADG **4.66**  
YWt **1204**  
YR **109**  
Scr. **37**  
Fr. **5.5**

**DAM**  
Age 9  
Wt 1082  
Prog.BW 69  
WR 102  
YR 105  
Wean Pct. 47%  
Cow Eff. 100

RAAA HerdBuilder index: **140**(Top 21% of all RA bulls)  
RAAA GridMaster index: **50**(Top 43% of all RA bulls)  
Calv.Ease BW WW YW Milk HPG Stay Maint.En.  
EPDs **9 -1.9 50 88 26 11 14 -3.9**  
Marb **+0.68** REA **-0.04** Bfat **+0.02**

★★★★★ for Low Maintenance, Growth, Gainability, Marbling, Calving Ease, Stayability.

**23** **BECKTON NEBULA B060 E5**  
1-A 100% # 1705781 Tat.: BSF4 B060



Birth: 2-21-14

Beckton Nebula X353 E3  
**BECKTON NEBULA Z180 H4**  
Ref. N-8

Beckton Mona X817 H

Beckton Emperor T641 E2  
**BECKTON LARKEISA Z924 E**  
BKT Larkeisa T310 JC

Beckton Nebula G S237  
Beckton Lana R058 EP  
Beckton Heritage T270 J2  
Beckton Mona T794 CD  
Beckton Emperor R100  
Beckton Vernice R416 EP  
Beckton Justice C1 R483  
BKT Larkeisa R775 JC

BWt **70**  
WR **125**  
ADG **4.32**  
YWt **1183**  
YR **114**  
Scr. **37**  
Fr. **5.5**

**DAM**  
Age 2  
Wt 828  
Prog.BW 70  
WR 125  
YR 114  
Wean Pct. 63%  
Cow Eff. 132

RAAA HerdBuilder index: **160** (Top 9% of all RA bulls)  
RAAA GridMaster index: **52**(Top 14% of all RA bulls)  
Calv.Ease BW WW YW Milk HPG Stay Maint.En.  
EPDs **12 -2.8 65 104 22 9 13 -1.9**  
Marb **+0.56** REA **+0.03** Bfat **+0.03**

★★★★★ for Low Maintenance, Growth, Gainability, Marbling, Superior Cow, High Cow Efficiency, Calving Ease, Stayability.

**21** **BECKTON HERITAGE B233 L4**  
1-A 100% # 1705792 Tat.: BKT4 B233



Birth: 3-16-14

Beckton Heritage T270 J2  
**BECKTON HERITAGE X403 L3**  
Ref. H-1

Beckton Indigo H150 LN

Beckton Lancer TH K417  
**BECKTON SIERRA N403 LN**  
Beckton Sierra J659 DM

Beckton Heritage N013  
Beckton Coca P602 JL  
Beckton Lancer TE F363  
Beckton Indigo F376 CT  
Beckton Lancer T A664  
Beckton Angel G356 HR  
Beckton Dominor ZR G223  
Beckton Sierra G671 DM

BWt **58**  
WR **112**  
ADG **4.26**  
YWt **1210**  
YR **110**  
Scr. **34**  
Fr. **5.5**

**DAM**  
Age 11  
Wt 1300  
Prog.BW 71  
WR 111  
YR 110  
Wean Pct. 46%  
Cow Eff. 98

RAAA HerdBuilder index: **158**(Top 10% of all RA bulls)  
RAAA GridMaster index: **54** (Top 3% of all RA bulls)  
Calv.Ease BW WW YW Milk HPG Stay Maint.En.  
EPDs **10 -6.9 49 82 28 10 14 -0.2**  
Marb **+0.66** REA **+0.01** Bfat **+0.03**

★★★★★ for Low Maintenance, Growth, Gainability, Marbling, Superior Cow, Calving Ease, Stayability.

**24** **BECKTON EPIC B287 N6**  
1-A 100% # 1705483 Tat.: BSF4 B287



Birth: 3-19-14

Beckton Epic K4 N795  
**BECKTON EPIC U749 D5**  
Ref. E-1

Beckton Denise R308 DM

Beckton Nebula G S237  
**BECKTON ENCINO U063 NB**  
Beckton Encino S090 JT

Beckton Epic KJ J722  
Beckton Sierra J789 EP  
Beckton Dominor ZC M919  
Beckton Denise L639 JL  
Beckton Nebula M045  
Beckton Lakme LA06 JL  
Beckton Jet L P491  
Beckton Encino P300 LN

BWt **72**  
WR **107**  
ADG **4.55**  
YWt **1187**  
YR **107**  
Scr. **35**  
Fr. **5.5**

**DAM**  
Age 6  
Wt 1080  
Prog.BW 58  
WR 104  
YR 102  
Wean Pct. 52%  
Cow Eff. 109

RAAA HerdBuilder index: **158**(Top 10% of all RA bulls)  
RAAA GridMaster index: **52**(Top 13% of all RA bulls)  
Calv.Ease BW WW YW Milk HPG Stay Maint.En.  
EPDs **14 -5.4 46 85 23 7 14 -0.1**  
Marb **+0.71** REA **+0.25** Bfat **+0.03**

★★★★★ for Low Maintenance, Growth, Gainability, Marbling, Rib-eye area, Calving Ease, Stayability.

• Bulls •

**25** **BECKTON EPIC B569 E7** 

1-A 100% # 1706009 Tat.: BKT4 B569

Birth: 4-1-14

Beckton Epic U749 D5  
**BECKTON EPIC Y484 N6**  
 Ref. E-5  
 Beckton Lydia S069 NB

Beckton Epic K4 N795  
 Beckton Denise R308 DM  
 Beckton Nebula P P707  
 Beckton Lydia P583 WR  
 Beckton Epic KM M115  
 Beckton Sierra N703 LM  
 Beckton Heritage N013  
 BKT Pine Marie P143 LN

BWT **72**  
 WR **112**  
 ADG **3.75**  
 YWt. **1202**  
 YR **109**  
 Scr. **36**  
 Fr. **6.0**

**BKT PINE MARIE W857 E**  
 Beckton Epic K6 S569  
 Beckton Sierra N703 LM  
 Beckton Heritage N013  
 BKT Pine Marie T593 HT

**DAM**  
 Age 5  
 Wt 910  
 Prog.BW 66  
 WR 110  
 YR 108  
 Wean Pct. 69%  
 Cow Eff. 145

RAAA HerdBuilder index: **153** (Top 12% of all RA bulls)  
 RAAA GridMaster index: **52** (Top 14% of all RA bulls)  
 Calv.Ease BW WW YW Milk HPG Stay Maint.En.  
 EPDs **11 -4.4 56 95 26 7 14 -3.7**  
 Marb **+0.58** REA **+0.21** Bfat **+0.01**

★★★★★ for Low Maintenance, Growth, Marbling, Rib-eye area, Superior Cow, High Cow Efficiency, Calving Ease, Stayability.

**28** **BECKTON HERITAGE B508 J4** 

1-A 100% # 1705533 Tat.: BSF4 B508

Birth: 3-29-14

Beckton Heritage T270 J2  
**BECKTON HERITAGE X403 L3**  
 Ref. H-1  
 Beckton Indigo H150 LN

Beckton Heritage N013  
 Beckton Coca P602 JL  
 Beckton Lancer TE F363  
 Beckton Indigo F376 CT  
 Beckton Julian 7526G  
 Bkt Marta 9A13 JL  
 Beckton Dominor ZC M919  
 Beckton Belga M883 DM

BWT **75**  
 WR **99**  
 ADG **4.15**  
 YWt. **1147**  
 YR **104**  
 Scr. **35**  
 Fr. **5.0**

**BECKTON BELGA W213 J**  
 Beckton Julian GG B571  
 Beckton Belga S587 DM

**DAM**  
 Age 5  
 Wt 1002  
 Prog.BW 64  
 WR 91  
 YR 95  
 Wean Pct. 55%  
 Cow Eff. 116

RAAA HerdBuilder index: **190** (Top 2% of all RA bulls)  
 RAAA GridMaster index: **53** (Top 5% of all RA bulls)  
 Calv.Ease BW WW YW Milk HPG Stay Maint.En.  
 EPDs **13 -3.8 60 90 18 11 15 -6.1**  
 Marb **+0.60** REA **+0.09** Bfat **+0.04**

★★★★★ for Low Maintenance, Gainability, Marbling, High Cow Efficiency, Calving Ease, Stayability.

**26** **BECKTON JULIAN B602 L6** 

1-A 100% # 1705836 Tat.: BKT4 B602

Birth: 4-3-14

Beckton Julian G5 S107  
**BECKTON JULIAN X465 J5**  
 Ref. J-4  
 Beckton Suffeina P643 JL

Beckton Julian GJ P535  
 Beckton Minola P826 DM  
 Beckton Julian GG B571  
 Bkt Suffeina A828 DM  
 Beckton Lancer TA K644  
 BKT Larkeisa H232 SC  
 Beckton Lancer T4 J536  
 Beckton Rose J152 LN

BWT **90**  
 WR **119**  
 ADG **4.03**  
 YWt. **1194**  
 YR **108**  
 Scr. **37**  
 Fr. **6.0**

**BECKTON ROSE S487 LN**  
 Beckton Lancer T9 N586  
 Beckton Rose L083 LN

**DAM**  
 Age 8  
 Wt 1004  
 Prog.BW 74  
 WR 105  
 YR 100  
 Wean Pct. 62%  
 Cow Eff. 131

RAAA HerdBuilder index: **177** (Top 4% of all RA bulls)  
 RAAA GridMaster index: **52** (Top 22% of all RA bulls)  
 Calv.Ease BW WW YW Milk HPG Stay Maint.En.  
 EPDs **8 1.1 65 99 19 12 16 -9.8**  
 Marb **+0.68** REA **-0.07** Bfat **+0.02**

★★★★★ for Low Maintenance, Growth, Gainability, Marbling, High Cow Efficiency, Calving Ease, Stayability.



**27** **BECKTON JULIAN B516 H6** 

1-A 100% # 1705867 Tat.: BKT4 B516

Birth: 3-29-14

Beckton Julian G5 S107  
**BECKTON JULIAN X465 J5**  
 Ref. J-4  
 Beckton Suffeina P643 JL

Beckton Julian GJ P535  
 Beckton Minola P826 DM  
 Beckton Julian GG B571  
 Bkt Suffeina A828 DM  
 Beckton Hustler C2 L079  
 Beckton Lana L007 JL  
 Beckton Lancer F442 T  
 Beckton Vernice J693 HU

BWT **90**  
 WR **104**  
 ADG **3.86**  
 YWt. **1168**  
 YR **106**  
 Scr. **39**  
 Fr. **5.5**

**BECKTON VERNICE T447 HT**  
 Beckton Heritage N013  
 Beckton Vernice N200 LN

**DAM**  
 Age 7  
 Wt 1220  
 Prog.BW 80  
 WR 106  
 YR 104  
 Wean Pct. 48%  
 Cow Eff. 100

RAAA HerdBuilder index: **163** (Top 8% of all RA bulls)  
 RAAA GridMaster index: **53** (Top 10% of all RA bulls)  
 Calv.Ease BW WW YW Milk HPG Stay Maint.En.  
 EPDs **6 1.4 72 112 14 10 15 -4.7**  
 Marb **+0.79** REA **-0.07** Bfat **+0.01**

★★★★★ for Low Maintenance, Growth, Marbling, Superior Cow, Stayability.

**29** **BECKTON ACCENT B237 E3** 

1-A 100% # 1705623 Tat.: BSF4 B237

Birth: 3-17-14

Beckton Cody K1 P014  
**BECKTON ACCENT U777 C2**  
 Ref. A-1  
 Beckton Susan R022 CQ

Beckton Cody KH M390  
 Beckton Rose M126 WR  
 Beckton Cherokee N N479  
 Beckton Susan N023 JE  
 Beckton Epic KM M115  
 Beckton Sierra N703 LM  
 Beckton Clifftop T3 N800  
 Beckton Tamara L214 LN

BWT **77**  
 WR **104**  
 ADG **4.26**  
 YWt. **1187**  
 YR **108**  
 Scr. **35**  
 Fr. **6.0**

**BECKTON TAMARA X628 E**  
 Beckton Epic K6 S569  
 Beckton Tamara T201 CT

**DAM**  
 Age 4  
 Wt 1050  
 Prog.BW 70  
 WR 106  
 YR 106  
 Wean Pct. 50%  
 Cow Eff. 105

RAAA HerdBuilder index: **141** (Top 20% of all RA bulls)  
 RAAA GridMaster index: **51** (Top 24% of all RA bulls)  
 Calv.Ease BW WW YW Milk HPG Stay Maint.En.  
 EPDs **9 -2.8 53 84 30 6 14 -1.6**  
 Marb **+0.50** REA **+0.05** Bfat **+0.02**

★★★★★ for Low Maintenance, Growth, Gainability, Marbling, Superior Cow, Calving Ease, Stayability.

• Bulls •

**30** **BECKTON EPIC B681 E6**  
 1-A 100% # 1705904 Tat.: BKT4 B681



Birth: 4-10-14

Beckton Epic K4 N795  
**BECKTON EPIC U749 D5**  
 Ref. E-1

Beckton Denise R308 DM

Beckton Epic K6 S569  
**BECKTON LANA U329 EP**  
 Beckton Lana S477 LN

**DAM**  
 Age 6  
 Wt 1086  
 Prog.BW 72  
 WR 116  
 YR 107  
 Wean Pct. 62%  
 Cow Eff. 130

Beckton Epic KJ J722  
 Beckton Sierra J789 EP  
 Beckton Dominor ZC M919  
 Beckton Denise L639 JL  
 Beckton Epic KM M115  
 Beckton Sierra N703 LM  
 Beckton Lancer T9 N586  
 Beckton Lana L007 JL

BWt **81**  
 WR **128**  
 ADG **3.69**  
 YWt. **1230**  
 YR **111**  
 Scr. **36**  
 Fr. **6.0**

RAAA HerdBuilder index: **131** (Top 30% of all RA bulls)  
 RAAA GridMaster index: **51** (Top 35% of all RA bulls)

Calv.Ease	BW	WW	YW	Milk	HPG	Stay	Maint.En.
EPDs <b>10</b>	<b>-2.2</b>	<b>60</b>	<b>106</b>	<b>29</b>	<b>8</b>	<b>12</b>	<b>1.4</b>
Marb <b>+0.49</b>	REA <b>+0.34</b>	Bfat <b>+0.03</b>					



Lot 32

★★★★★ for Low Maintenance, Growth, Marbling, Rib-eye area, Superior Cow, High Cow Efficiency, Calving Ease.

**31** **BECKTON ACCENT B241 W3**  
 1-A 100% # 1705980 Tat.: BKT4 B241



Birth: 3-17-14

Beckton Accent U777 C2  
**BECKTON ACCENT Y312 N3**  
 Ref. A-4

BKT Larkeisa S055 NB

Beckton Warrior T248 L5  
**BECKTON SUFFEINA W489 W**  
 BKT Suffeina T500 EP

**DAM**  
 Age 5  
 Wt 1004  
 Prog.BW 59  
 WR 110  
 YR 110  
 Wean Pct. 56%  
 Cow Eff. 118

Beckton Cody K1 P014  
 Beckton Susan R022 CQ  
 Beckton Nebula P P707  
 Beckton Larkeisa P688 CH  
 Beckton Warrior N645 T1  
 Beckton Kit R503 LN  
 Beckton Epic K3 M606  
 Beckton Suffeina N844 LN

BWt **65**  
 WR **100**  
 ADG **3.98**  
 YWt. **1155**  
 YR **105**  
 Scr. **37**  
 Fr. **5.0**

RAAA HerdBuilder index: **175** (Top 5% of all RA bulls)  
 RAAA GridMaster index: **53** (Top 8% of all RA bulls)

Calv.Ease	BW	WW	YW	Milk	HPG	Stay	Maint.En.
EPDs <b>12</b>	<b>-6.8</b>	<b>44</b>	<b>73</b>	<b>23</b>	<b>11</b>	<b>14</b>	<b>-8.1</b>
Marb <b>+0.50</b>	REA <b>+0.05</b>	Bfat <b>+0.04</b>					

★★★★★ for Low Maintenance, Marbling, Superior Cow, High Cow Efficiency, Calving Ease, Stayability.

**33** **BECKTON EPIC B437 N6**  
 1-A 100% # 1705992 Tat.: BKT4 B437



Birth: 3-26-14

Beckton Epic K4 N795  
**BECKTON EPIC U749 D5**  
 Ref. E-1

Beckton Denise R308 DM

Beckton Nebula EN S347  
**BKT PINE MARIE W623 N**  
 BKT Pine Marie R246 JE

**DAM**  
 Age 5  
 Wt 960  
 Prog.BW 63  
 WR 106  
 YR 106  
 Wean Pct. 61%  
 Cow Eff. 128

Beckton Epic KJ J722  
 Beckton Sierra J789 EP  
 Beckton Dominor ZC M919  
 Beckton Denise L639 JL  
 Beckton Nebula E P084  
 Beckton Eola P530 NB  
 Beckton Jules L429  
 BKT Pine Marie J556 EP

BWt **73**  
 WR **112**  
 ADG **3.98**  
 YWt. **1169**  
 YR **106**  
 Scr. **36**  
 Fr. **5.0**

RAAA HerdBuilder index: **162** (Top 9% of all RA bulls)  
 RAAA GridMaster index: **52** (Top 13% of all RA bulls)

Calv.Ease	BW	WW	YW	Milk	HPG	Stay	Maint.En.
EPDs <b>12</b>	<b>-4.6</b>	<b>50</b>	<b>87</b>	<b>26</b>	<b>11</b>	<b>13</b>	<b>-3.2</b>
Marb <b>+0.58</b>	REA <b>+0.10</b>	Bfat <b>+0.04</b>					

★★★★★ for Low Maintenance, Growth, Marbling, Superior Cow, High Cow Efficiency, Calving Ease, Stayability.

**32** **BECKTON NEBULA B410 C3**  
 1-A 100% # 1705503 Tat.: BSF4 B410



Birth: 3-25-14

Beckton Nebula M045  
**BECKTON NEBULA P P707**  
 Ref. N-2

Beckton Lana M809 EP

Beckton Clifftop T3 N800  
**BECKTON LANA U456 CT**  
 Beckton Lana R254 JC

**DAM**  
 Age 6  
 Wt 994  
 Prog.BW 69  
 WR 108  
 YR 107  
 Wean Pct. 62%  
 Cow Eff. 130

Beckton Neptune R2 K065  
 Beckton Belga K285 JL  
 Beckton Epic K1 K863  
 Beckton Lana K253 DM  
 Bkt Clifftop TV G672  
 Beckton Lana J384 CD  
 Beckton Justice C K449  
 Beckton Lana G032 HD

BWt **82**  
 WR **110**  
 ADG **3.86**  
 YWt. **1166**  
 YR **106**  
 Scr. **37**  
 Fr. **5.0**

RAAA HerdBuilder index: **166** (Top 7% of all RA bulls)  
 RAAA GridMaster index: **53** (Top 6% of all RA bulls)

Calv.Ease	BW	WW	YW	Milk	HPG	Stay	Maint.En.
EPDs <b>13</b>	<b>-2.8</b>	<b>59</b>	<b>97</b>	<b>21</b>	<b>9</b>	<b>14</b>	<b>-4.0</b>
Marb <b>+0.74</b>	REA <b>-0.11</b>	Bfat <b>+0.02</b>					

★★★★★ for Low Maintenance, Growth, Marbling, Superior Cow, High Cow Efficiency, Calving Ease, Stayability.

**34** **BECKTON NEW ERA B830 N2**  
 1-A 100% # 1705542 Tat.: BSF4 B830



Birth: 4-27-14

Beckton Nebula P P707  
**BECKTON NEW ERA Y194**  
 Ref. N-6

BKT Larkeisa T310 JC

Beckton Nebula L P093  
**BECKTON ROSE W402 N**  
 Beckton Rose L311 LN

**DAM**  
 Age 5  
 Wt 1292  
 Prog.BW 73  
 WR 104  
 YR 105  
 Wean Pct. 51%  
 Cow Eff. 107

Beckton Nebula M045  
 Beckton Lana M809 EP  
 Beckton Justice C1 R483  
 BKT Larkeisa R775 JC  
 Beckton Nebula M045  
 Beckton Marta M021 LN  
 Beckton Lancer F442 T  
 Beckton Rose H292 HD

BWt **88**  
 WR **118**  
 ADG **4.21**  
 YWt. **1268**  
 YR **115**  
 Scr. **37**  
 Fr. **5.5**

RAAA HerdBuilder index: **182** (Top 3% of all RA bulls)  
 RAAA GridMaster index: **53** (Top 6% of all RA bulls)

Calv.Ease	BW	WW	YW	Milk	HPG	Stay	Maint.En.
EPDs <b>10</b>	<b>-0.3</b>	<b>79</b>	<b>124</b>	<b>18</b>	<b>11</b>	<b>16</b>	<b>-1.5</b>
Marb <b>+0.56</b>	REA <b>-0.10</b>	Bfat <b>+0.02</b>					

★★★★★ for Low Maintenance, Growth, Gainability, Marbling, Superior Cow, Calving Ease, Stayability.

• Bulls •

**35** **BECKTON ACCENT B209 E2**   
 1-A 100% # 1705798 Tat.: BKT4 B209

Birth: 3-14-14

Beckton Cody K1 P014  
 Beckton Rose M126 WR  
 Beckton Cherokee N N479  
 Beckton Susan N023 JE  
 Beckton Epic K J722  
 Beckton Lana F891 JL  
 Beckton Clipper KC D400  
 Beckton Coca F276 HV

**BECKTON ACCENT U777 C2**  
 Ref. A-1  
 Beckton Susan R022 CQ

**BECKTON COCA P328 EP**  
 Beckton Epic KJ J722  
 Beckton Coca J276 CL

**DAM**  
 Age 10  
 Wt 1280  
 Prog.BW 74  
 WR 107  
 YR 104  
 Wean Pct. 42%  
 Cow Eff. 88

RAAA HerdBuilder index: **144** (Top 18% of all RA bulls)  
 RAAA GridMaster index: **51** (Top 28% of all RA bulls)

Calv.Ease	BW	WW	YW	Milk	HPG	Stay	Maint.En.
9	.0	63	96	26	10	13	-5.2

EPDs **9 .0 63 96 26 10 13 -5.2**

Marb **+.51** REA **+.04** Bfat **+.03**

BWt **89**  
 WR **126**  
 ADG **4.38**  
 YWt **1170**  
 YR **118**  
 Scr. **37**  
 Fr. **5.5**

★★★★★ for Low Maintenance, Growth, Gainability, Marbling, Superior Cow, Calving Ease, Stayability.

**37** **BECKTON JULIAN B023 N8**   
 1-A 100% # 1706155 Tat.: BKT4 B023

Birth: 2-15-14

Beckton Julian X721 E6  
 Beckton Lana U329 EP  
 Beckton Julian U699 L5  
 Beckton Larkaba U475 CT  
 Beckton Nebula X096 N4  
 Beckton Sierra X818 C  
 Beckton Julian U699 L5  
 Beckton Larkaba U475 CT  
 Beckton Nebula U206 V3  
 Beckton Tamara U185 NB  
 Beckton Cherokee T450 L3  
 Beckton Sierra G615 WR

**BECKTON JULIAN Z382 J7**  
 Ref. J-5  
 Beckton Larkaba X064 J

**BECKTON SIERRA Z059 N**  
 Beckton Nebula X096 N4  
 Beckton Sierra X818 C

**DAM**  
 Age 2  
 Wt 992  
 Prog.BW 81  
 WR 117  
 YR 114  
 Wean Pct. 49%  
 Cow Eff. 102

RAAA HerdBuilder index: **185** (Top 3% of all RA bulls)  
 RAAA GridMaster index: **51** (Top 35% of all RA bulls)

Calv.Ease	BW	WW	YW	Milk	HPG	Stay	Maint.En.
9	0.2	75	114	21	11	16.5	-3.2

EPDs **9 0.2 75 114 21 11 16.5 -3.2**

Marb **+.41** REA **+.29** Bfat **+.01**

BWt **81**  
 WR **117**  
 ADG **4.60**  
 YWt **1186**  
 YR **114**  
 Scr. **32**  
 Fr. **5.5**

★★★★★ for Low Maintenance, Growth, Gainability, Marbling, Rib-eye area, Superior Cow, Calving Ease, Stayability.

**36** **BECKTON CLIFFTOP B762 J4**   
 1-A 100% # 1705494 Tat.: BSF4 B762

Birth: 4-18-14

BKT Clifftop TP R288  
 Beckton Clifftop T C075  
 Beckton Christy K209 CO  
 Beckton Epic KM M115  
 Beckton Lydia M607 LO  
 Beckton Justice CH M056  
 Beckton Tamara J124 HR  
 Beckton Lancer TL G626  
 Beckton Tamara F269 CH

**BECKTON CLIFFTOP W692 E3**  
 Ref. C-1  
 Beckton Lydia S274 EP

**BECKTON TAMARA U249 JC**  
 Beckton Justice C1 R483  
 Beckton Tamara M823 LN

**DAM**  
 Age 6  
 Wt 1324  
 Prog.BW 73  
 WR 111  
 YR 108  
 Wean Pct. 46%  
 Cow Eff. 97

RAAA HerdBuilder index: **158** (Top 10% of all RA bulls)  
 RAAA GridMaster index: **52** (Top 17% of all RA bulls)

Calv.Ease	BW	WW	YW	Milk	HPG	Stay	Maint.En.
10	-2.8	56	94	29	11	15	2.2

EPDs **10 -2.8 56 94 29 11 15 2.2**

Marb **+.48** REA **-.05** Bfat **+.05**

BWt **79**  
 WR **116**  
 ADG **3.75**  
 YWt **1219**  
 YR **110**  
 Scr. **34**  
 Fr. **5.5**

★★★★★ for Low Maintenance, Growth, Marbling, Superior Cow, Calving Ease, Stayability.

**38** **BECKTON JULIAN B491 E6**   
 1-A 100% # 1705842 Tat.: BKT4 B491

Birth: 3-28-14

Beckton Julian G5 S107  
 Beckton Julian GJ P535  
 Beckton Minola P826 DM  
 Beckton Julian GG B571  
 Bkt Suffeina A828 DM  
 Beckton Epic KJ J722  
 Beckton Lana F268 CT  
 Beckton Lancer T A664  
 Beckton Belga D460 KR

**BECKTON JULIAN X465 J5**  
 Ref. J-4  
 Beckton Suffeina P643 JL

**BECKTON BELGA S747 EP**  
 Beckton Epic K3 M606  
 Beckton Belga K202 LN

**DAM**  
 Age 8  
 Wt 1186  
 Prog.BW 64  
 WR 102  
 YR 104  
 Wean Pct. 43%  
 Cow Eff. 89

RAAA HerdBuilder index: **157** (Top 11% of all RA bulls)  
 RAAA GridMaster index: **51** (Top 31% of all RA bulls)

Calv.Ease	BW	WW	YW	Milk	HPG	Stay	Maint.En.
10	-2.3	50	84	19	12	14	-3.5

EPDs **10 -2.3 50 84 19 12 14 -3.5**

Marb **+.60** REA **-.11** Bfat **+.00**

BWt **81**  
 WR **96**  
 ADG **5.06**  
 YWt **1204**  
 YR **109**  
 Scr. **38**  
 Fr. **5.0**

★★★★★ for Low Maintenance, Growth, Gainability, Marbling, Calving Ease, Stayability.



**39** **BECKTON NEBULA B579 H5**   
 1-A 100% # 1705936 Tat.: BKT4 B579

Birth: 4-2-14

Beckton Nebula T054 H3  
 Beckton Nebula J R475  
 BKT Pine Marie R401 HU  
 Beckton Emperor R100  
 BKT Suffeina R231 EP  
 Beckton Heritage N013  
 Beckton Coca P602 JL  
 Beckton Jupiter R478  
 Beckton Firefly R151 LS

**BECKTON NEBULA W040 E4**  
 Ref. N  
 BKT Suffeina T110 EM

**BECKTON FIREFLY W021 H**  
 Beckton Heritage T270 J2  
 Beckton Firefly T028 JR

**DAM**  
 Age 5  
 Wt 1064  
 Prog.BW 77  
 WR 115  
 YR 107  
 Wean Pct. 60%  
 Cow Eff. 126

RAAA HerdBuilder index: **155** (Top 12% of all RA bulls)  
 RAAA GridMaster index: **51** (Top 28% of all RA bulls)

Calv.Ease	BW	WW	YW	Milk	HPG	Stay	Maint.En.
10	-0.4	69	102	21	12	13	-6.4

EPDs **10 -0.4 69 102 21 12 13 -6.4**

Marb **+.45** REA **+.13** Bfat **+.01**

BWt **89**  
 WR **122**  
 ADG **4.15**  
 YWt **1251**  
 YR **113**  
 Scr. **37**  
 Fr. **6.0**

★★★★★ for Low Maintenance, Growth, Gainability, Marbling, Rib-eye area, Superior Cow, High Cow Efficiency, Calving Ease, Stayability.

• Bulls •

**40** **BECKTON EPIC B278 V6**  
1-A 100% # 1705902 Tat.: BKT4 B278



Birth: 3-19-14

Beckton Epic K4 N795  
**BECKTON EPIC U749 D5**  
Ref. E-1

Beckton Denise R308 DM

Beckton Vega P079  
**BECKTON ROSE U298 VA**  
Beckton Rose P015 LN

Beckton Epic KJ J722  
Beckton Sierra J789 EP  
Beckton Dominor ZC M919  
Beckton Denise L639 JL  
Beckton Vegas S1 K316  
Beckton Lydia H159 JL  
Beckton Lancer T7 M089  
Beckton Rose M131 HR

BWt	69
WR	99
ADG	4.72
YWt.	1198
YR	108
Scr.	33
Fr.	5.5

**DAM**  
Age 6  
Wt 1300  
Prog.BW 66  
WR 102  
YR 107  
Wean Pct. 40%  
Cow Eff. 84

RAAA HerdBuilder index: **121** (Top 40% of all RA bulls)  
RAAA GridMaster index: **50** (Top 39% of all RA bulls)

Calv.Ease	BW	WW	YW	Milk	HPG	Stay	Maint.En.	
EPDs	10	-4.6	50	93	20	7	12	3.7

Marb **+0.40** REA **+1.15** Bfat **+0.1**

★★★★★ for Low Maintenance, Growth, Gainability, Marbling, Rib-eye area, Calving Ease.

**43** **BECKTON NEBULA B022 S5**  
1-A 100% # 1706218 Tat.: BKT4 B022



Birth: 2-14-14

Beckton Nebula X353 E3  
**BECKTON NEBULA Z180 H4**  
Ref. N-8

Beckton Mona X817 H

Beckton Scamp T A825  
**BECKTON INDIGO Z423 S**  
Beckton Indigo T613 JT

Beckton Nebula G S237  
Beckton Lana R058 EP  
Beckton Heritage T270 J2  
Beckton Mona T794 CD  
Beckton Scamp 8954  
Bkt Encino 8459 TJ  
TR Julian LT151  
Beckton Indigo N467 LO

BWt	67
WR	109
ADG	4.03
YWt.	1097
YR	106
Scr.	36
Fr.	5.0

**DAM**  
Age 2  
Wt 856  
Prog.BW 67  
WR 109  
YR 106  
Wean Pct. 52%  
Cow Eff. 109

RAAA HerdBuilder index: **169** (Top 6% of all RA bulls)  
RAAA GridMaster index: **52** (Top 13% of all RA bulls)

Calv.Ease	BW	WW	YW	Milk	HPG	Stay	Maint.En.	
EPDs	14	-4.5	57	91	22	8	14	-4.8

Marb **+0.53** REA **+0.05** Bfat **+0.03**

★★★★★ for Low Maintenance, Growth, Gainability, Marbling, Superior Cow, Calving Ease, Stayability.

**41** **BECKTON ACCENT B328 A3**  
1-A 100% # 1705885 Tat.: BKT4 B328



Birth: 3-21-14

Beckton Accent W180 C2  
**BECKTON ACCENT Y260 L3**  
Ref. A-3

Beckton Lana W463 L

Beckton Colt K M609  
**BECKTON MINERVA T864 CK**  
Beckton Minerva M179 LN

Beckton Cody K1 P014  
Beckton Christy R046 CQ  
Beckton Loki CL S284  
Beckton Lana R327 EP  
Beckton Colt G552  
Beckton Angel H164 LO  
Beckton Lancer T3 J396  
Beckton Minerva E932 JL

BWt	70
WR	100
ADG	3.98
YWt.	1118
YR	101
Scr.	38
Fr.	6.0

**DAM**  
Age 7  
Wt 1222  
Prog.BW 68  
WR 104  
YR 102  
Wean Pct. 43%  
Cow Eff. 90

RAAA HerdBuilder index: **155** (Top 11% of all RA bulls)  
RAAA GridMaster index: **51** (Top 24% of all RA bulls)

Calv.Ease	BW	WW	YW	Milk	HPG	Stay	Maint.En.	
EPDs	10	-4.5	53	85	24	10	15	-0.8

Marb **+0.37** REA **-0.02** Bfat **+0.1**

★★★★★ for Low Maintenance, Marbling, Calving Ease, Stayability.



**42** **BECKTON ACCENT B343 E2**  
1-A 100% # 1705874 Tat.: BKT4 B343



Birth: 3-22-14

Beckton Cody K1 P014  
**BECKTON ACCENT U777 C2**  
Ref. A-1

Beckton Susan R022 CQ

Beckton Epic KM M115  
**BECKTON MONA T558 EP**  
Beckton Mona P199 VG

Beckton Cody KH M390  
Beckton Rose M126 WR  
Beckton Cherokee N N479  
Beckton Susan N023 JE  
Beckton Epic K F075  
Beckton Minerva F495 CH  
Beckton Vegas S1 K316  
Beckton Mona L618 LR

BWt	70
WR	98
ADG	3.75
YWt.	1108
YR	100
Scr.	38
Fr.	5.0

**DAM**  
Age 7  
Wt 1096  
Prog.BW 64  
WR 103  
YR 102  
Wean Pct. 47%  
Cow Eff. 99

RAAA HerdBuilder index: **171** (Top 6% of all RA bulls)  
RAAA GridMaster index: **53** (Top 10% of all RA bulls)

Calv.Ease	BW	WW	YW	Milk	HPG	Stay	Maint.En.	
EPDs	12	-6.0	49	76	28	10	15	-4.6

Marb **+0.52** REA **+0.01** Bfat **+0.02**

★★★★★ for Low Maintenance, Marbling, Calving Ease, Stayability.

**44** **BECKTON ACCENT B697 L3**  
1-A 100% # 1705962 Tat.: BKT4 B697



Birth: 4-8-14

Beckton Cody K1 P014  
**BECKTON ACCENT U777 C2**  
Ref. A-1

Beckton Susan R022 CQ

Beckton Loki CL S284  
**BECKTON RUTH W246 L**  
Beckton Ruth P591 LN

Beckton Cody KH M390  
Beckton Rose M126 WR  
Beckton Cherokee N N479  
Beckton Susan N023 JE  
Beckton Loki C M740  
Beckton Lakme J460 LT  
Beckton Lancer T5 L095  
Beckton Ruth E549 TP

BWt	78
WR	94
ADG	4.15
YWt.	1146
YR	104
Scr.	38
Fr.	5.5

**DAM**  
Age 5  
Wt 1196  
Prog.BW 64  
WR 95  
YR 101  
Wean Pct. 41%  
Cow Eff. 87

RAAA HerdBuilder index: **183** (Top 3% of all RA bulls)  
RAAA GridMaster index: **51** (Top 28% of all RA bulls)

Calv.Ease	BW	WW	YW	Milk	HPG	Stay	Maint.En.	
EPDs	10	-3.2	52	76	19	8	17	-6.1

Marb **+0.51** REA **+0.10** Bfat **-0.01**

★★★★★ for Low Maintenance, Gainability, Marbling, Calving Ease, Stayability.

• Bulls •

**45** **BECKTON NEW ERA B601 E2**  
1-A 100% # 1705816 Tat.: BKT4 B601



Birth: 4-3-14

Beckton Nebula P P707  
**BECKTON NEW ERA Y194**  
Ref. N-6  
BKT Larkeisa T310 JC

Beckton Nebula M045  
Beckton Lana M809 EP  
Beckton Justice C1 R483  
BKT Larkeisa R775 JC

Beckton Epic K3 M606  
**BECKTON VERNICE R416 EP**  
Beckton Vernice K482 HD

Beckton Epic KJ J722  
Beckton Lana F268 CT  
Beckton Hadrian F C486  
Beckton Vernice F513 CL

BWt	77
WR	98
ADG	4.60
YWt	1170
YR	106
Scr.	35
Fr.	5.5

**DAM**  
Age 9  
Wt 1246  
Prog.BW 69  
WR 99  
YR 104  
Wean Pct. 41%  
Cow Eff. 87

RAAA HerdBuilder index: **153**(Top 13% of all RA bulls)  
RAAA GridMaster index: **52**(Top 16% of all RA bulls)

Calv.Ease	BW	WW	YW	Milk	HPG	Stay	Maint.En.	
EPDs	12	-3.8	56	92	19	11	12	-4.8
Marb	+4.3	REA	-1.8	Bfat	+0.2			

★★★★★ for Low Maintenance, Growth, Gainability, Marbling, Calving Ease.

**48** **BECKTON EPIC B448 N7**  
1-A 100% # 1705982 Tat.: BKT4 B448



Birth: 3-27-14

Beckton Epic T330 L5  
**BECKTON EPIC X330 L6**  
Ref. E-2  
Beckton Kit R503 LN

Beckton Epic K4 N795  
Beckton Belga K202 LN  
Beckton Lancer F442 T  
Beckton Kit F468 JL

Beckton Nebula EN S347  
**BECKTON FIREFLY W511 N**  
Beckton Firefly K180 CH

Beckton Nebula E P084  
Beckton Eola P530 NB  
Beckton Champ R1 H024  
Beckton Firefly H314 EP

BWt	72
WR	101
ADG	4.09
YWt	1143
YR	103
Scr.	38
Fr.	5.5

**DAM**  
Age 5  
Wt 974  
Prog.BW 68  
WR 103  
YR 102  
Wean Pct. 54%  
Cow Eff. 114

RAAA HerdBuilder index: **173** (Top 5% of all RA bulls)  
RAAA GridMaster index: **53** (Top 8% of all RA bulls)

Calv.Ease	BW	WW	YW	Milk	HPG	Stay	Maint.En.	
EPDs	12	-5.9	46	72	25	10	14	-8.4
Marb	+6.5	REA	+0.5	Bfat	+0.2			

★★★★★ for Low Maintenance, Gainability, Marbling, Calving Ease, Stayability.

**46** **BECKTON JULIAN B669 D7**  
1-A 100% # 1705473 Tat.: BSF4 B669



Birth: 4-9-14

Beckton Julian T506 C5  
**BECKTON JULIAN W480 H6**  
Ref.  
Beckton Minola T091 HI

Beckton Julian G2 M345  
Beckton Kuruba F465 CD  
Beckton Hilltop R157  
Beckton Minola R720 JJ

Beckton Dominor ZC M919  
**BECKTON MINOLA S674 DM**  
Beckton Minola N760 HU

Beckton Dominor Z E401  
Beckton Barmaid J012 CO  
Beckton Hustler CN J102  
Beckton Minola K527 CO

BWt	74
WR	109
ADG	3.81
YWt	1155
YR	105
Scr.	37
Fr.	5.5

**DAM**  
Age 8  
Wt 1170  
Prog.BW 76  
WR 102  
YR 106  
Wean Pct. 49%  
Cow Eff. 103

RAAA HerdBuilder index: **160** (Top 9% of all RA bulls)  
RAAA GridMaster index: **53**(Top 10% of all RA bulls)

Calv.Ease	BW	WW	YW	Milk	HPG	Stay	Maint.En.	
EPDs	8	-2.7	57	92	20	10	14	-6.1
Marb	+5.4	REA	-1.4	Bfat	+0.4			

★★★★★ for Low Maintenance, Marbling, Calving Ease, Stayability.

**49** **BSF EPIC B682 D7**  
1-B 99% # 1706308 Tat.: BKB4 B682



Birth: 4-10-14

Beckton Epic U749 D5  
**BECKTON EPIC Y484 N6**  
Ref. E-5  
Beckton Lydia S069 NB

Beckton Epic K4 N795  
Beckton Denise R308 DM  
Beckton Nebula P P707  
Beckton Lydia P583 WR

Beckton Dominor Z1 R610  
**BSF DOMINIQUE X492 D**  
BSF Regus G195

Beckton Dominor ZC M919  
Beckton Sierra K557 LO  
Beckton Emperor C369  
BSF Regus 8099

BWt	91
WR	110
ADG	4.05
YWt	1206
YR	109
Scr.	36
Fr.	6.0

**DAM**  
Age 4  
Wt 978  
Prog.BW 78  
WR 114  
YR 109  
Wean Pct. 57%  
Cow Eff. 120

RAAA HerdBuilder index: **156**(Top 11% of all RA bulls)  
RAAA GridMaster index: **50**(Top 53% of all RA bulls)

Calv.Ease	BW	WW	YW	Milk	HPG	Stay	Maint.En.	
EPDs	8	0.8	62	101	22	11	15	-3.2
Marb	+5.0	REA	+2.0	Bfat	+0.2			

★★★★★ for Low Maintenance, Growth, Gainability, Marbling, Rib-eye area, Superior Cow, High Cow Efficiency, Calving Ease, Stayability.

**47** **BECKTON SCAMP B827 J4**  
1-A 100% # 1706088 Tat.: BKT4 B827



Birth: 4-26-14

Beckton Scamp T A825  
**BECKTON SCAMP X458 H3**  
Ref. S  
BKT Pine Marie R401 HU

Beckton Scamp 8954  
Bkt Encino 8459 TJ  
Beckton Hustler C2 L079  
Bkt Pine Marie LC30 CD

Beckton Julian W841 J5  
**BECKTON COCA Y037 J**  
Beckton Coca W325 E

Beckton Julian G5 S107  
Beckton Christy J743 JL  
Beckton Epitomy S250  
Beckton Coca P843 JO

BWt	74
WR	117
ADG	4.26
YWt	1238
YR	116
Scr.	32
Fr.	6.0

**DAM**  
Age 3  
Wt 1122  
Prog.BW 64  
WR 117  
YR 116  
Wean Pct. 51%  
Cow Eff. 108

RAAA HerdBuilder index: **156**(Top 11% of all RA bulls)  
RAAA GridMaster index: **51**(Top 31% of all RA bulls)

Calv.Ease	BW	WW	YW	Milk	HPG	Stay	Maint.En.	
EPDs	11	-2.1	56	89	24	11	13	-2.3
Marb	+4.3	REA	-0.1	Bfat	+0.3			

★★★★★ for Low Maintenance, Growth, Gainability, Marbling, Superior Cow, Calving Ease, Stayability.

**50** **BSF EPIC B159 E6**  
1-B 99% # 1705505 Tat.: BSF4 B159



Birth: 3-8-14

Beckton Epic K6 S569  
**BECKTON EPIC X464 L5**  
Ref. E-3  
Beckton Lana M393 LN

Beckton Epic KM M115  
Beckton Sierra N703 LM  
Beckton Lancer T3 J396  
Beckton Lana F081 LN

Beckton Epic K4 N795  
**BSF JUSTICIA U488 EP**  
BSF Justicia R888 JC

Beckton Epic KJ J722  
Beckton Sierra J789 EP  
Beckton Justice CH M056  
BSF Regus M177 EP

BWt	74
WR	91
ADG	4.55
YWt	1147
YR	104
Scr.	35
Fr.	5.5

**DAM**  
Age 6  
Wt 1112  
Prog.BW 73  
WR 105  
YR 107  
Wean Pct. 43%  
Cow Eff. 91

RAAA HerdBuilder index: **115**(Top 47% of all RA bulls)  
RAAA GridMaster index: **51**(Top 27% of all RA bulls)

Calv.Ease	BW	WW	YW	Milk	HPG	Stay	Maint.En.	
EPDs	7	-2.7	53	96	27	6	11	-1.5
Marb	+5.6	REA	+1.3	Bfat	+0.2			

★★★★★ for Low Maintenance, Gainability, Marbling, Rib-eye area, Superior Cow, Calving Ease.



• Bulls •



**53** **BSF CLIFFTOP B256 C4** 

1-B 99% # 1705549 Tat.: BSF4 B256

Birth: 3-18-14

BECKTON CLIFFTOP W692 E3  
Ref. C-1

BSF WARRITA W536 C

DAM

Age	5
Wt	996
Prog. BW	71
WR	106
YR	99
Wean Pct.	63%
Cow Eff.	133

RAAA HerdBuilder index: **190** (Top 2% of all RA bulls)  
RAAA GridMaster index: **52** (Top 12% of all RA bulls)

Calv. Ease	BW	WW	YW	Milk	HPG	Stay	Maint. En.
EPDs	11	-3.7	53	88	28	13	17
	Marb	+0.54	REA	+0.08	Bfat	+0.05	

BWT **77**  
WR **120**  
ADG **3.65**  
YWT **1170**  
YR **106**  
Scr. **35**  
Fr. **5.5**

★★★★★ for Low Maintenance, Growth, Marbling, High Cow Efficiency, Calving Ease, Stayability.

**51** **BECKTON EPIC B034 M7** 

1-B 99% # 1706186 Tat.: BKT4 B034

Birth: 2-18-14

BECKTON EPIC Z434 L6  
Ref. E-6

BECKTON REGINA Z257 M

DAM

Age	2
Wt	940
Prog. BW	78
WR	108
YR	111
Wean Pct.	50%
Cow Eff.	106

RAAA HerdBuilder index: **138** (Top 23% of all RA bulls)  
RAAA GridMaster index: **50** (Top 54% of all RA bulls)

Calv. Ease	BW	WW	YW	Milk	HPG	Stay	Maint. En.
EPDs	8	.0	60	101	26	8	13
	Marb	+0.57	REA	+0.30	Bfat	+0.02	

BWT **78**  
WR **108**  
ADG **4.27**  
YWT **1157**  
YR **111**  
Scr. **34**  
Fr. **5.5**

★★★★★ for Low Maintenance, Growth, Gainability, Marbling, Rib-eye area, Superior Cow, Calving Ease, Stayability.

**54** **BSF EPIC B585 E6** 

1-B 99% # 1705531 Tat.: BSF4 B585

Birth: 4-3-14

BECKTON EPIC U749 D5  
Ref. E-1

BSF EPIQUETTE W206 E

DAM

Age	5
Wt	1342
Prog. BW	82
WR	108
YR	113
Wean Pct.	38%
Cow Eff.	80

RAAA HerdBuilder index: **86** (Top 81% of all RA bulls)  
RAAA GridMaster index: **51** (Top 37% of all RA bulls)

Calv. Ease	BW	WW	YW	Milk	HPG	Stay	Maint. En.
EPDs	7	-1.4	57	107	21	3	10
	Marb	+0.58	REA	+0.24	Bfat	+0.03	

BWT **80**  
WR **97**  
ADG **4.49**  
YWT **1213**  
YR **110**  
Scr. **37**  
Fr. **6.0**

★★★★★ for Growth, Gainability, Marbling, Rib-eye area, Superior Cow, Calving Ease.

**52** **BSF EPIC B488 L7** 

1-B 99% # 1705486 Tat.: BSF4 B488

Birth: 3-28-14

BECKTON EPIC X816 C6  
Ref. E-4

BSF HUSTELLE U113 LO

DAM

Age	6
Wt	1184
Prog. BW	60
WR	102
YR	105
Wean Pct.	46%
Cow Eff.	96

RAAA HerdBuilder index: **168** (Top 7% of all RA bulls)  
RAAA GridMaster index: **54** (Top 4% of all RA bulls)

Calv. Ease	BW	WW	YW	Milk	HPG	Stay	Maint. En.
EPDs	13	-7.1	44	70	22	9	14
	Marb	+0.55	REA	-0.06	Bfat	+0.05	

BWT **67**  
WR **97**  
ADG **4.72**  
YWT **1237**  
YR **112**  
Scr. **35**  
Fr. **5.5**

★★★★★ for Low Maintenance, Growth, Gainability, Marbling, Calving Ease, Stayability.

**55** **BSF LIKABLE B392 J3** 

1-B 99% # 1728943 Tat.: BSF4 B392

Birth: 3-25-14

BECKTON LIKABLE U130 L2  
Ref. L-2

BSF NEBULANN T658 JC

DAM

Age	7
Wt	1104
Prog. BW	64
WR	107
YR	103
Wean Pct.	57%
Cow Eff.	120

RAAA HerdBuilder index: **157** (Top 10% of all RA bulls)  
RAAA GridMaster index: **52** (Top 13% of all RA bulls)

Calv. Ease	BW	WW	YW	Milk	HPG	Stay	Maint. En.
EPDs	11	-4.4	58	91	20	10	14
	Marb	+0.50	REA	+0.32	Bfat	+0.05	

BWT **72**  
WR **113**  
ADG **3.88**  
YWT **1181**  
YR **107**  
Scr. **39**  
Fr. **5.5**

★★★★★ for Low Maintenance, Growth, Marbling, Rib-eye area, High Cow Efficiency, Calving Ease, Stayability.

• Bulls •

**56** **BSF NEBULA B457 C4** 

1-B 99% # 1728976 Tat.: BKB4 B457

Birth: 3-27-14

Beckton Nebula L P093  
**BECKTON NEBULA W486 D3** Ref. N-4  
 Beckton Belga R716 DM

Beckton Nebula M045  
 Beckton Marta M021 LN  
 Beckton Dominor ZC M919  
 Beckton Belga K285 JL  
 BFCK Cherokee Cnyn 4912  
 Beckton Dinah C440 NM  
 Beckton Hustler C2 L079  
 BSF Regus E323

BWt **73**  
 WR **110**  
 ADG **3.99**  
 YWt **1186**  
 YR **107**  
 Scr. **38**  
 Fr. **5.5**

Beckton Cherokee N N479  
**BSF HUSTELLE T531 CQ**  
 BSF Hustle P246

**DAM**  
 Age 7  
 Wt 1140  
 Prog.BW 66  
 WR 106  
 YR 104  
 Wean Pct. 50%  
 Cow Eff. 106

RAAA HerdBuilder index: **166** (Top 6% of all RA bulls)  
 RAAA GridMaster index: **52** (Top 18% of all RA bulls)  
 Calv.Ease BW WW YW Milk HPG Stay Maint.En.  
 EPDs **11 -4.2 55 84 22 10 16 -2.4**  
 Marb **+4.7** REA **+1.5** Bfat **+0.2**

★★★★★ for Low Maintenance, Growth, Marbling, Rib-eye area, Superior Cow, Calving Ease, Stayability.

**58** **BSF NEBULA B487 C5** 

1-B 99% # 1705475 Tat.: BSF4 B487

Birth: 3-28-14

Beckton Nebula U206 V3  
**BECKTON NEBULA X096 N4** Ref. N-5  
 Beckton Tamara U185 NB

Beckton Nebula P P707  
 Beckton Minerva J615 VG  
 Beckton Nebula P P707  
 Beckton Tamara P813 CH  
 Beckton Champ RH F275  
 Beckton Lana F138 LN  
 Beckton Jules L429  
 BSF Regus L683 CT

BWt **92**  
 WR **98**  
 ADG **4.38**  
 YWt **1171**  
 YR **106**  
 Scr. **35**  
 Fr. **6.0**

Beckton Champ R1 H024  
**BSF JEWEL S875 CH**  
 BSF Jewel N355 JE

**DAM**  
 Age 8  
 Wt 1076  
 Prog.BW 69  
 WR 100  
 YR 104  
 Wean Pct. 48%  
 Cow Eff. 100

RAAA HerdBuilder index: **168** (Top 7% of all RA bulls)  
 RAAA GridMaster index: **49** (Top 67% of all RA bulls)  
 Calv.Ease BW WW YW Milk HPG Stay Maint.En.  
 EPDs **10 -0.4 59 91 21 10 17 -2.8**  
 Marb **+4.0** REA **+1.2** Bfat **-0.3**

★★★★★ for Low Maintenance, Growth, Gainability, Marbling, Calving Ease, Stayability.

**57** **BSF EPIC B112 S7** 

1-B 99% # 1705707 Tat.: BSF4 B112

Birth: 2-28-14

Beckton Epic U749 D5  
**BECKTON EPIC Z674 E6** Ref. E-7  
 Beckton Indigo U504 EP

Beckton Epic K4 N795  
 Beckton Denise R308 DM  
 Beckton Epic K6 S569  
 Beckton Indigo S016 NB  
 Beckton Scamp T A825  
 Beckton Lana S074 EP  
 Beckton Likable U120 L2  
 BSF Crusita U036 NB

BWt **65**  
 WR **110**  
 ADG **3.88**  
 YWt **1128**  
 YR **109**  
 Scr. **34**  
 Fr. **5.5**

Beckton Scamp X494 E3  
**BSF CRUSITA Z155 S**  
 BSF Crusita X071 L

**DAM**  
 Age 2  
 Wt 798  
 Prog.BW 65  
 WR 110  
 YR 109  
 Wean Pct. 56%  
 Cow Eff. 118

RAAA HerdBuilder index: **173** (Top 5% of all RA bulls)  
 RAAA GridMaster index: **52** (Top 15% of all RA bulls)  
 Calv.Ease BW WW YW Milk HPG Stay Maint.En.  
 EPDs **11 -4.1 51 87 28 8 15 -6.8**  
 Marb **+6.1** REA **+1.9** Bfat **+0.2**

★★★★★ for Low Maintenance, Growth, Marbling, Rib-eye area, Superior Cow, High Cow Efficiency, Calving Ease, Stayability.

**59** **BSF NEBULA B462 E4** 

1-B 99% # 1705484 Tat.: BSF4 B462

Birth: 3-27-14

Beckton Nebula L P093  
**BECKTON NEBULA W486 D3** Ref. N-4  
 Beckton Belga R716 DM

Beckton Nebula M045  
 Beckton Marta M021 LN  
 Beckton Dominor ZC M919  
 Beckton Belga K285 JL  
 Beckton Epic KJ J722  
 Beckton Kit F468 JL  
 Beckton Epic KJ J722  
 BSF Regus M323 VG

BWt **73**  
 WR **106**  
 ADG **3.71**  
 YWt **1153**  
 YR **104**  
 Scr. **37**  
 Fr. **5.5**

Beckton Epic K7 S583  
**BSF EPIQUETTE U076 EP**  
 BSF Epiquette S364 EP

**DAM**  
 Age 6  
 Wt 1158  
 Prog.BW 70  
 WR 107  
 YR 103  
 Wean Pct. 48%  
 Cow Eff. 101

RAAA HerdBuilder index: **160** (Top 9% of all RA bulls)  
 RAAA GridMaster index: **51** (Top 33% of all RA bulls)  
 Calv.Ease BW WW YW Milk HPG Stay Maint.En.  
 EPDs **10 -4.5 43 68 24 9 15 -1.1**  
 Marb **+4.6** REA **+1.2** Bfat **+0.3**

★★★★★ for Low Maintenance, Marbling, Calving Ease, Stayability.



**60** **BSF CLIFFTOP B598 L5** 

1-B 99% # 1728946 Tat.: BSF4 B598

Birth: 4-3-14

Beckton Clifftop W692 E3  
**BECKTON CLIFFTOP Y012 C4** Ref. C-2  
 Beckton Lana W240 C

BKT Clifftop TP R288  
 Beckton Lydia S274 EP  
 BKT Clifftop TP R288  
 Beckton Lana L923 CD  
 Beckton Lancer F442 T  
 Beckton Tamara G141 HE  
 Beckton Lancer TL G626  
 BSF Regus F207

BWt **72**  
 WR **100**  
 ADG **4.16**  
 YWt **1111**  
 YR **101**  
 Scr. **35**  
 Fr. **6.0**

Beckton Lancer T7 M089  
**BSF LANETTE R748 LN**  
 BSF Red Roan L823 LN

**DAM**  
 Age 9  
 Wt 1168  
 Prog.BW 70  
 WR 107  
 YR 107  
 Wean Pct. 45%  
 Cow Eff. 95

RAAA HerdBuilder index: **154** (Top 11% of all RA bulls)  
 RAAA GridMaster index: **50** (Top 43% of all RA bulls)  
 Calv.Ease BW WW YW Milk HPG Stay Maint.En.  
 EPDs **11 -4.2 50 83 23 10 15 -4.7**  
 Marb **+3.2** REA **+0.5** Bfat **+0.1**

★★★★★ for Low Maintenance, Gainability, Marbling, Superior Cow, Calving Ease, Stayability.

• Bulls •

**61** **BECKTON ACCENT B317 N2**   
 1-A 100% # 1705593 Tat.: BSF4 B317  
 Birth: 3-21-14  
 Beckton Cody K1 P014  
**BECKTON ACCENT U777 C2**  
 Ref. A-1 Beckton Susan R022 CQ  
 Beckton Nebula T269 E2  
**BECKTON BARMAID X231 N**  
 Beckton Barmaid G565 LN  
 Beckton Cody KH M390  
 Beckton Rose M126 WR  
 Beckton Cherokee N N479  
 Beckton Susan N023 JE  
 Beckton Nebula M045  
 Beckton Ruth M967 EP  
 Beckton Lancer T A664  
 Bkt Barmaid 9517 RN  
 BWT **69**  
 WR **116**  
 ADG **3.41**  
 YWt. **1149**  
 YR **104**  
 Scr. **39**  
 Fr. **5.0**

DAM										
Age	4	RAAA HerdBuilder index: <b>174</b> (Top 5% of all RA bulls)								
Wt	1032	RAAA GridMaster index: <b>52</b> (Top 17% of all RA bulls)								
Prog.BW	64	Calv.Ease	BW	WW	YW	Milk	HPG	Stay	Maint.En.	
WR	115	EPDs	<b>13</b>	<b>-6.0</b>	<b>43</b>	<b>68</b>	<b>30</b>	<b>9</b>	<b>15</b>	<b>-6.7</b>
YR	105	Marb	<b>+0.56</b>		REA	<b>+0.05</b>		Bfat	<b>+0.01</b>	
Wean Pct.	57%									
Cow Eff.	120									

★★★★★ for Low Maintenance, Marbling, Superior Cow, High Cow Efficiency, Calving Ease, Stayability.

**64** **BECKTON NEW ERA B617 E2**   
 1-A 100% # 1705472 Tat.: BSF4 B617  
 Birth: 4-4-14  
 Beckton Nebula P P707  
**BECKTON NEW ERA Y194**  
 Ref. N-6 BKT Larkeisa T310 JC  
 Beckton Epic KM M115  
**BECKTON MINOLA S464 EP**  
 Beckton Minola J409 LN  
 Beckton Nebula M045  
 Beckton Lana M809 EP  
 Beckton Justice C1 R483  
 BKT Larkeisa R775 JC  
 Beckton Epic K F075  
 Beckton Minerva F495 CH  
 Beckton Lancer TS D390  
 Beckton Minola D494 SC  
 BWT **78**  
 WR **112**  
 ADG **3.64**  
 YWt. **1126**  
 YR **102**  
 Scr. **36**  
 Fr. **5.0**

DAM										
Age	8	RAAA HerdBuilder index: <b>172</b> (Top 5% of all RA bulls)								
Wt	1288	RAAA GridMaster index: <b>53</b> (Top 5% of all RA bulls)								
Prog.BW	75	Calv.Ease	BW	WW	YW	Milk	HPG	Stay	Maint.En.	
WR	107	EPDs	<b>9</b>	<b>-2.6</b>	<b>68</b>	<b>109</b>	<b>24</b>	<b>11</b>	<b>15</b>	<b>-1.8</b>
YR	104	Marb	<b>+0.56</b>		REA	<b>-0.24</b>		Bfat	<b>+0.01</b>	
Wean Pct.	46%									
Cow Eff.	96									

★★★★★ for Low Maintenance, Marbling, Superior Cow, Calving Ease, Stayability.

**62** **BECKTON EPIC B238 A7**   
 1-A 100% # 1705516 Tat.: BSF4 B238  
 Birth: 3-17-14  
 Beckton Epic T330 L5  
**BECKTON EPIC X816 C6**  
 Ref. E-4 Beckton Mona R198 CQ  
 Beckton Cody K1 P014  
**BECKTON ENCINO U680 CD**  
 Beckton Encino R488 JL  
 Beckton Epic K4 N795  
 Beckton Belga K202 LN  
 Beckton Cherokee N N479  
 Beckton Mona N009 JE  
 Beckton Cody KH M390  
 Beckton Rose M126 WR  
 Beckton Julian G1 J526  
 Beckton Encino C644 ZN  
 BWT **69**  
 WR **100**  
 ADG **3.98**  
 YWt. **1119**  
 YR **101**  
 Scr. **36**  
 Fr. **5.0**

DAM										
Age	6	RAAA HerdBuilder index: <b>157</b> (Top 11% of all RA bulls)								
Wt	1080	RAAA GridMaster index: <b>52</b> (Top 16% of all RA bulls)								
Prog.BW	60	Calv.Ease	BW	WW	YW	Milk	HPG	Stay	Maint.En.	
WR	98	EPDs	<b>14</b>	<b>-6.4</b>	<b>43</b>	<b>75</b>	<b>28</b>	<b>9</b>	<b>14</b>	<b>-3.7</b>
YR	97	Marb	<b>+0.53</b>		REA	<b>+0.05</b>		Bfat	<b>+0.02</b>	
Wean Pct.	49%									
Cow Eff.	102									

★★★★★ for Low Maintenance, Marbling, Calving Ease, Stayability.

**65** **BECKTON LEGEND B664 E2**   
 1-A 100% # 1706046 Tat.: BKT4 B664  
 Birth: 4-9-14  
 Beckton Lancer F442 T  
**BECKTON LEGEND S670**  
 Ref. L-1 Beckton Kit F468 JL  
 Beckton Epic K6 S569  
**BECKTON ROSE X389 E**  
 Beckton Rose P015 LN  
 Beckton Lancer T A664  
 Bkt Suffeina A828 DM  
 Beckton Julian GG B571  
 Beckton Kit A517 NP  
 Beckton Epic KM M115  
 Beckton Sierra N703 LM  
 Beckton Lancer T7 M089  
 Beckton Rose M131 HR  
 BWT **76**  
 WR **115**  
 ADG **3.52**  
 YWt. **1126**  
 YR **102**  
 Scr. **37**  
 Fr. **6.0**

DAM										
Age	4	RAAA HerdBuilder index: <b>178</b> (Top 4% of all RA bulls)								
Wt	1000	RAAA GridMaster index: <b>52</b> (Top 19% of all RA bulls)								
Prog.BW	70	Calv.Ease	BW	WW	YW	Milk	HPG	Stay	Maint.En.	
WR	116	EPDs	<b>10</b>	<b>-3.4</b>	<b>55</b>	<b>82</b>	<b>23</b>	<b>8</b>	<b>16</b>	<b>-10.5</b>
YR	110	Marb	<b>+0.64</b>		REA	<b>+0.27</b>		Bfat	<b>+0.00</b>	
Wean Pct.	62%									
Cow Eff.	131									

★★★★★ for Low Maintenance, Marbling, Rib-eye area, Superior Cow, High Cow Efficiency, Calving Ease, Stayability.

**63** **BECKTON LEGEND B230 D 2**   
 1-A 100% # 1705440 Tat.: BSF4 B230  
 Birth: 3-16-14  
 Beckton Lancer F442 T  
**BECKTON LEGEND S670**  
 Ref. L-1 Beckton Kit F468 JL  
 Beckton Dominor ZC M919  
**BECKTON LANA P026 DM**  
 Beckton Lana M552 WR  
 Beckton Lancer T A664  
 Bkt Suffeina A828 DM  
 Beckton Julian GG B571  
 Beckton Kit A517 NP  
 Beckton Dominor Z E401  
 Beckton Barmaid J012 CO  
 Beckton Warrior T C371  
 Beckton Lana J235 JL  
 BWT **69**  
 WR **101**  
 ADG **3.13**  
 YWt. **1079**  
 YR **98**  
 Scr. **36**  
 Fr. **5.5**

DAM										
Age	10	RAAA HerdBuilder index: <b>190</b> (Top 2% of all RA bulls)								
Wt	1074	RAAA GridMaster index: <b>52</b> (Top 21% of all RA bulls)								
Prog.BW	67	Calv.Ease	BW	WW	YW	Milk	HPG	Stay	Maint.En.	
WR	104	EPDs	<b>10</b>	<b>-4.5</b>	<b>46</b>	<b>71</b>	<b>17</b>	<b>10</b>	<b>17</b>	<b>-12.6</b>
YR	104	Marb	<b>+0.71</b>		REA	<b>+0.16</b>		Bfat	<b>-0.01</b>	
Wean Pct.	53%									
Cow Eff.	111									

★★★★★ for Low Maintenance, Marbling, Rib-eye area, Superior Cow, Calving Ease, Stayability.



Lot 63

• Bulls •

**66** **BECKTON JULIAN B333 N4**   
 1-A 100% # 1705947 Tat.: BKT4 B333  
 Birth: 3-22-14  
 Beckton Julian 7526G  
**BECKTON JULIAN GG B571**  
 Ref. J-1 Bkt Marta 9A13 JL  
 Beckton Nebula T269 E2  
**BECKTON LYDIA W083 N**  
 Beckton Lydia T601 CT  
 Beckton Nebula M045  
 Beckton Ruth M967 EP  
 Beckton Clifftop T3 N800  
 Beckton Lydia N081 WR  

BWt	80
WR	101
ADG	3.86
YWt.	1119
YR	102
Scr.	37
Fr.	5.5

Age	5
Wt	1254
Prog.BW	76
WR	93
YR	99
Wean Pct.	45%
Cow Eff.	95

RAAA HerdBuilder index: **181** (Top 3% of all RA bulls)  
 RAAA GridMaster index: **52** (Top 16% of all RA bulls)  
 Calv.Ease BW WW YW Milk HPG Stay Maint.En.  
 EPDs **14 -2.9 58 91 16 7 16 0.9**  
 Marb **+0.55** REA **+0.15** Bfat **+0.03**

★★★★★ for Low Maintenance, Marbling, Rib-eye area, Calving Ease, Stayability.

**68** **BSF CARDINAL B037 W**   
 1-2 99% # 1705776 Tat.: BSF4 B037  
 Birth: 2-18-14  
 TR Ricardo DOS  
**TR DOUBLE EAGLE ZT220**  
 Ref. C-4 Beckton Lana U182 JC  
 BFCK Cherokee Cnyn 4912  
 TR Dyna LT111  
 Beckton Justice C1 R483  
 Beckton Lana H544 WR  
 Beckton Warrior C1 S337  
 BKT Larkeisa S055 NB  
 Beckton Cody K1 P014  
 BSF Regus M604 LN  

BWt	71
WR	119
ADG	4.61
YWt.	1228
YR	118
Scr.	33
Fr.	5.5

Age	2
Wt	772
Prog.BW	71
WR	119
YR	118
Wean Pct.	63%
Cow Eff.	133

RAAA HerdBuilder index: **183** (Top 3% of all RA bulls)  
 RAAA GridMaster index: **52** (Top 18% of all RA bulls)  
 Calv.Ease BW WW YW Milk HPG Stay Maint.En.  
 EPDs **13 -3.5 59 92 23 11 7.3 -8.0**  
 Marb **+0.51** REA **+0.26** Bfat **+0.02**

★★★★★ for Low Maintenance, Growth, Gainability, Marbling, Rib-eye area, Superior Cow, High Cow Efficiency, Calving Ease.

**67** **BSF ACCENT B210 L3**   
 1-B 99% # 1728941 Tat.: BSF4 B210  
 Birth: 3-14-14  
 Beckton Cody K1 P014  
**BECKTON ACCENT U777 C2**  
 Ref. A-1 Beckton Susan R022 CQ  
 Beckton Loki C M740  
**BSF LOKETTA R368 LO**  
 BSF Regus F700  
 Beckton Cody KH M390  
 Beckton Rose M126 WR  
 Beckton Cherokee N N479  
 Beckton Susan N023 JE  
 Beckton Loki F251  
 BKT Larkeisa J051 CK  
 Beckton Kannon D202  
 BSF Regus D524  

BWt	78
WR	105
ADG	4.10
YWt.	1126
YR	102
Scr.	40
Fr.	5.0

Age	9
Wt	1064
Prog.BW	74
WR	99
YR	96
Wean Pct.	52%
Cow Eff.	109

RAAA HerdBuilder index: **159** (Top 9% of all RA bulls)  
 RAAA GridMaster index: **53** (Top 9% of all RA bulls)  
 Calv.Ease BW WW YW Milk HPG Stay Maint.En.  
 EPDs **10 -4.5 48 69 21 6 15 -9.2**  
 Marb **+0.70** REA **+0.16** Bfat **+0.03**

★★★★★ for Low Maintenance, Gainability, Marbling, Rib-eye area, Calving Ease, Stayability.

**69** **BSF CLIFFTOP B414 E4**   
 1-B 99% # 1705515 Tat.: BSF4 B414  
 Birth: 3-26-14  
 BKT Clifftop TP R288  
**BECKTON CLIFFTOP W692 E3**  
 Ref. C-1 Beckton Lydia S274 EP  
 Beckton Epitomy S250  
**BSF CODETTE U667 EY**  
 BSF Codette S177 CD  
 Beckton Clifftop T C075  
 Beckton Christy K209 CO  
 Beckton Epic KM M115  
 Beckton Lydia M607 LO  
 Beckton Epic K4 N795  
 Beckton Tara M635 JL  
 Beckton Cody KH M390  
 BSF Red K467 CD  

BWt	75
WR	99
ADG	4.10
YWt.	1126
YR	102
Scr.	35
Fr.	5.0

Age	6
Wt	1008
Prog.BW	70
WR	103
YR	103
Wean Pct.	52%
Cow Eff.	109

RAAA HerdBuilder index: **151** (Top 13% of all RA bulls)  
 RAAA GridMaster index: **51** (Top 27% of all RA bulls)  
 Calv.Ease BW WW YW Milk HPG Stay Maint.En.  
 EPDs **11 -4.5 42 71 26 9 13 -6.5**  
 Marb **+0.45** REA **-0.13** Bfat **+0.03**

★★★★★ for Low Maintenance, Gainability, Marbling, Superior Cow, Calving Ease, Stayability.



**70** **BSF SCAMP B646 C7**   
 1-B 99% # 1729766 Tat.: BSF4 B646  
 Birth: 4-7-14  
 Beckton Scamp T A825  
**BECKTON SCAMP X494 E3**  
 Ref. S-1 Beckton Lana S074 EP  
 Beckton Cherokee T450 L3  
**BSF JULIA Y203 C**  
 BSF Julia T623 JO  
 Beckton Scamp 8954  
 Bkt Encino 8459 TJ  
 Beckton Epic KH P678  
 Beckton Lana P317 JL  
 Beckton Cherokee N N479  
 Beckton Annie M337 LN  
 Beckton Julio L233  
 BSF Regus M006 NP  

BWt	80
WR	106
ADG	4.72
YWt.	1203
YR	111
Scr.	40
Fr.	6.0

Age	3
Wt	1232
Prog.BW	78
WR	106
YR	111
Wean Pct.	41%
Cow Eff.	85

RAAA HerdBuilder index: **159** (Top 9% of all RA bulls)  
 RAAA GridMaster index: **51** (Top 29% of all RA bulls)  
 Calv.Ease BW WW YW Milk HPG Stay Maint.En.  
 EPDs **11 -5.1 44 77 25 11 15 -6.7**  
 Marb **+0.39** REA **+0.00** Bfat **+0.03**

★★★★★ for Low Maintenance, Growth, Gainability, Marbling, Superior Cow, Calving Ease, Stayability.

• Bulls •



**73** **BSF DOMINOR B824 J6** 

1-B 99% # 1705644 Tat.: BSF4 B824

Birth: 4-26-14

Beckton Dominor Z1 R610  
 Beckton Sierra K557 LO  
**BECKTON DOMINOR W640 C5**  
 Ref. D-1 Beckton Mona R166 CQ  
 Beckton Cherokee N N479  
 Beckton Mona N342 HU  
 Beckton Julian G5 S107  
 Beckton Christy J743 JL  
**BSF ERICA Y140 J**  
 Beckton Julian W841 J5  
 Beckton Ranger T603 H3  
 BSF Erica W053 R  
 BSF Erica T609 EP

BWT	70
WR	116
ADG	4.33
YWT	1222
YR	115
Scr.	35
Fr.	6.0

**DAM**

Age	3
Wt	950
Prog. BW	66
WR	111
YR	111
Wean Pct.	60%
Cow Eff.	126

RAAA HerdBuilder index: **184** (Top 3% of all RA bulls)  
 RAAA GridMaster index: **54** (Top 3% of all RA bulls)

Calv. Ease	BW	WW	YW	Milk	HPG	Stay	Maint. En.	
EPDs	13	-4.3	54	85	25	13	15	-1.4
Marb	+0.63		REA	-0.09		Bfat		+0.06

★★★★★ for Low Maintenance, Growth, Gainability, Marbling, Superior Cow, High Cow Efficiency, Calving Ease, Stayability.

**71** **BSF NEBULA B315 C3** 

1-B 99% # 1705504 Tat.: BSF4 B315

Birth: 3-21-14

Beckton Nebula M045  
**BECKTON NEBULA E P084**  
 Ref. N BKT Pine Marie M119 EP  
 Beckton Neptune R2 K065  
 Beckton Belga K285 JL  
 Beckton Epic K F075  
 Bkt Pine Marie D126 JL  
 BFCK Cherokee Cryn 4912  
**BSF LANETTE U463 CQ**  
 Beckton Cherokee N N479  
 Beckton Lancer T7 M089  
 BSF Lanette R748 LN  
 BSF Red Roan L823 LN

BWT	78
WR	122
ADG	4.33
YWT	1317
YR	119
Scr.	40
Fr.	5.0

**DAM**

Age	6
Wt	1074
Prog. BW	66
WR	113
YR	108
Wean Pct.	60%
Cow Eff.	126

RAAA HerdBuilder index: **177** (Top 4% of all RA bulls)  
 RAAA GridMaster index: **53** (Top 6% of all RA bulls)

Calv. Ease	BW	WW	YW	Milk	HPG	Stay	Maint. En.	
EPDs	14	-4.9	53	80	25	12	14	-5.5
Marb	+0.56		REA	-0.05		Bfat		+0.04

★★★★★ for Low Maintenance, Growth, Gainability, Marbling, Superior Cow, High Cow Efficiency, Calving Ease, Stayability.



**72** **BSF EPIC B507 C6** 

1-B 99% # 1705489 Tat.: BSF4 B507

Birth: 3-29-14

Beckton Epic K4 N795  
**BECKTON EPIC U749 D5**  
 Ref. E-1 Beckton Denise R308 DM  
 Beckton Epic KJ J722  
 Beckton Sierra J789 EP  
 Beckton Dominor ZC M919  
 Beckton Denise L639 JL  
 Bkt Clifftop TV G672  
**BSF WENDIE U152 CT**  
 Beckton Clifftop T3 N800  
 Beckton Lana J384 CD  
 Beckton Warrior T1 H281  
 BSF Wendie N343 WR  
 BSF Regus E323

BWT	76
WR	98
ADG	3.76
YWT	1128
YR	102
Scr.	33
Fr.	5.0

**DAM**

Age	6
Wt	1090
Prog. BW	72
WR	104
YR	104
Wean Pct.	47%
Cow Eff.	99

RAAA HerdBuilder index: **115** (Top 48% of all RA bulls)  
 RAAA GridMaster index: **50** (Top 44% of all RA bulls)

Calv. Ease	BW	WW	YW	Milk	HPG	Stay	Maint. En.	
EPDs	10	-3.4	47	86	19	8	11	0.3
Marb	+0.57		REA	+0.30		Bfat		+0.02

★★★★★ for Low Maintenance, Marbling, Rib-eye area, Superior Cow, Calving Ease.

**74** **BSF LEGEND S670 N2** 

1-B 99% # 1705441 Tat.: BSF4 B205

Birth: 3-13-14

Beckton Lancer F442 T  
**BECKTON LEGEND S670**  
 Ref. L-1 Beckton Kit F468 JL  
 Beckton Lancer T A664  
 Bkt Suffeina A828 DM  
 Beckton Julian GG B571  
 Beckton Kit A517 NP  
 Beckton Neptune R2 K065  
 Beckton Belga K285 JL  
**BSF NEBULANN P046**  
 Beckton Nebula M045  
 Beckton Epic K F075  
 BSF Regus M717 EP  
 BSF Regus H098

BWT	76
WR	107
ADG	3.20
YWT	1049
YR	95
Scr.	36
Fr.	5.0

**DAM**

Age	10
Wt	1126
Prog. BW	63
WR	101
YR	101
Wean Pct.	53%
Cow Eff.	112

RAAA HerdBuilder index: **212** (Top 1% of all RA bulls)  
 RAAA GridMaster index: **53** (Top 5% of all RA bulls)

Calv. Ease	BW	WW	YW	Milk	HPG	Stay	Maint. En.	
EPDs	12	-4.4	54	81	16	8	18	-14.6
Marb	+0.73		REA	+0.13		Bfat		+0.04

★★★★★ for Low Maintenance, Marbling, Rib-eye area, Calving Ease, Stayability.

• Bulls •

**75** **BSF NEW ERA B722 L** 

1-B 99% # 1705609 Tat.: BSF4 B722

Birth: 4-14-14

Beckton Nebula P P707  
**BECKTON NEW ERA Y194**  
 Ref. N-6 BKT Larkeisa T310 JC

Beckton Nebula M045  
 Beckton Lana M809 EP  
 Beckton Justice C1 R483  
 BKT Larkeisa R775 JC

Beckton Loki C M740  
 Beckton Lakme J460 LT  
 Beckton Lancer T8 N337  
 BSF Coquette N706 CE

BWt	76
WR	111
ADG	3.48
YWt	1143
YR	104
Scr.	34
Fr.	5.5

**BSF COQUETTE X506 L**  
 Beckton Loki CL S284  
 BSF Coquette R240 LN

DAM	
Age	4
Wt	NA
Prog.BW	68
WR	105
YR	99
Wean Pct. NA%	
Cow Eff.	NA

RAAA HerdBuilder index: **170** (Top 6% of all RA bulls)  
 RAAA GridMaster index: **53** (Top 6% of all RA bulls)

Calv.Ease	BW	WW	YW	Milk	HPG	Stay	Maint.En.	
EPDs	12	-3.7	63	102	20	10	15	0.5

Marb **+4.8** REA **-1.3** Bfat **+0.3**

**78** **BECKTON EPIC B737 E7** 

1-A 100% # 1705994 Tat.: BKT4 B737

Birth: 4-16-14

Beckton Epic T330 L5  
**BECKTON EPIC X330 L6**  
 Ref. E-2 Beckton Kit R503 LN

Beckton Epic K4 N795  
 Beckton Belga K202 LN  
 Beckton Lancer F442 T  
 Beckton Kit F468 JL  
 Beckton Epic KJ J722  
 Beckton Sierra J789 EP  
 Beckton Epic K5 P071  
 Beckton Rose P684 JE

BWt	78
WR	108
ADG	4.38
YWt	1279
YR	116
Scr.	37
Fr.	5.5

**BECKTON ROSE W656 E**  
 Beckton Epic K4 N795  
 Beckton Rose S269 EP

DAM	
Age	5
Wt	1224
Prog.BW	74
WR	108
YR	107
Wean Pct. 49%	
Cow Eff.	103

RAAA HerdBuilder index: **125** (Top 36% of all RA bulls)  
 RAAA GridMaster index: **53** (Top 8% of all RA bulls)

Calv.Ease	BW	WW	YW	Milk	HPG	Stay	Maint.En.	
EPDs	9	-2.9	58	98	21	4	11	0.2

Marb **+7.0** REA **+1.0** Bfat **+0.5**

★★★★★ for Low Maintenance, Marbling, Calving Ease, Stayability.

★★★★★ for Low Maintenance, Growth, Gainability, Marbling, Superior Cow, Calving Ease.

**76** **BSF NEBULA B080 N6** 

1-B 99% # 1705738 Tat.: BSF4 B080

Birth: 2-25-14

Beckton Nebula X096 N4  
**BECKTON NEBULA Z111 N5**  
 Ref. N-7 Beckton Minola X670 N

Beckton Nebula U206 V3  
 Beckton Tamara U185 NB  
 Beckton Nebula T054 H3  
 Beckton Minola S103 JL  
 Beckton Nebula T269 E2  
 Beckton Firefly T006 DM  
 Beckton Warrior C1 S337  
 BSF Epiquette S632 EP

BWt	69
WR	107
ADG	4.33
YWt	1124
YR	108
Scr.	35
Fr.	5.5

**BSF EPIQUETTE Z443 N**  
 Beckton Nebula W130 D3  
 BSF Epiquette U398 WR

DAM	
Age	2
Wt	878
Prog.BW	69
WR	107
YR	108
Wean Pct. 50%	
Cow Eff.	104

RAAA HerdBuilder index: **181** (Top 3% of all RA bulls)  
 RAAA GridMaster index: **53** (Top 11% of all RA bulls)

Calv.Ease	BW	WW	YW	Milk	HPG	Stay	Maint.En.	
EPDs	11	-3.0	60	101	18	10.5	15	-2.0

Marb **+5.3** REA **+2.1** Bfat **+0.3**

★★★★★ for Low Maintenance, Growth, Gainability, Marbling, Rib-eye area, Superior Cow, Calving Ease, Stayability.

**79** **BECKTON NEBULA B284 E5** 

1-A 100% # 1705911 Tat.: BKT4 B284

Birth: 3-19-14

Beckton Nebula U206 V3  
**BECKTON NEBULA X096 N4**  
 Ref. N-5 Beckton Tamara U185 NB

Beckton Nebula P P707  
 Beckton Minerva J615 VG  
 Beckton Nebula P P707  
 Beckton Tamara P813 CH  
 Beckton Epic K F075  
 Beckton Larkaba E042 CD  
 Beckton Colt K M609  
 Beckton Larkaba J649 CR

BWt	68
WR	98
ADG	4.83
YWt	1193
YR	108
Scr.	36
Fr.	5.0

**BECKTON LARKABA U498 EP**  
 Beckton Epic R350 K  
 Beckton Larkaba R336 CK

DAM	
Age	6
Wt	1158
Prog.BW	73
WR	112
YR	112
Wean Pct. 45%	
Cow Eff.	94

RAAA HerdBuilder index: **152** (Top 13% of all RA bulls)  
 RAAA GridMaster index: **51** (Top 32% of all RA bulls)

Calv.Ease	BW	WW	YW	Milk	HPG	Stay	Maint.En.	
EPDs	7	-3.7	52	87	22	11	15	2.5

Marb **+4.6** REA **+0.1** Bfat **+0.0**

★★★★★ for Low Maintenance, Growth, Gainability, Marbling, Superior Cow, Calving Ease, Stayability.

**77** **BSF JULIAN B155 L6** 

1-B 99% # 1728938 Tat.: BSF4 B155

Birth: 3-7-14

Beckton Julian G5 S107  
**BECKTON JULIAN X465 J5**  
 Ref. J-4 Beckton Suffeina P643 JL

Beckton Julian GJ P535  
 Beckton Minola P826 DM  
 Beckton Julian GG B571  
 Bkt Suffeina A828 DM  
 Beckton Lancer TZ D525  
 Bkt Pine Marie D126 JL  
 Beckton Emperor C369  
 BSF Regus 8099

BWt	77
WR	103
ADG	3.54
YWt	1070
YR	97
Scr.	38
Fr.	5.0

**BSF LAUREL N411 LO**  
 Beckton Loki F251  
 BSF Regus G195

DAM	
Age	11
Wt	1130
Prog.BW	73
WR	100
YR	100
Wean Pct. 49%	
Cow Eff.	104

RAAA HerdBuilder index: **160** (Top 9% of all RA bulls)  
 RAAA GridMaster index: **53** (Top 7% of all RA bulls)

Calv.Ease	BW	WW	YW	Milk	HPG	Stay	Maint.En.	
EPDs	9	-1.4	56	88	21	10	16	-7.0

Marb **+8.0** REA **+0.2** Bfat **+0.7**

★★★★★ for Low Maintenance, Marbling, Calving Ease, Stayability.

**80** **BECKTON ACCENT B599 L2** 

1-A 100% # 1706058 Tat.: BKT4 B599

Birth: 4-3-14

Beckton Cody K1 P014  
**BECKTON ACCENT U777 C2**  
 Ref. A-1 Beckton Susan R022 CQ

Beckton Cody KH M390  
 Beckton Rose M126 WR  
 Beckton Cherokee N N479  
 Beckton Susan N023 JE  
 Beckton Loki C M740  
 Beckton Lakme J460 LT  
 Beckton Jules L429  
 Beckton Larkaba M715 WR

BWt	73
WR	107
ADG	3.98
YWt	1147
YR	104
Scr.	36
Fr.	5.5

**BECKTON LARKABA X549 L**  
 Beckton Loki CL S284  
 Beckton Larkaba R615 JE

DAM	
Age	4
Wt	1100
Prog.BW	61
WR	97
YR	104
Wean Pct. 49%	
Cow Eff.	104

RAAA HerdBuilder index: **174** (Top 5% of all RA bulls)  
 RAAA GridMaster index: **52** (Top 16% of all RA bulls)

Calv.Ease	BW	WW	YW	Milk	HPG	Stay	Maint.En.	
EPDs	13	-5.1	49	76	25	10	16	-4.2

Marb **+4.6** REA **+0.4** Bfat **+0.3**

★★★★★ for Low Maintenance, Marbling, Calving Ease, Stayability.

• Bulls •



**83** **BECKTON NEBULA B683 L4** 

1-A 100% # 1705802 Tat.: BKT4 B683

Birth: 4-10-14

Beckton Nebula L P093  
**BECKTON NEBULA W486 D3**  
 Ref. N-4  
 Beckton Belga R716 DM

Beckton Nebula M045  
 Beckton Marta M021 LN  
 Beckton Dominor ZC M919  
 Beckton Belga K285 JL  
 Beckton Lancer F442 T  
 Beckton Belga J293 HR  
 RDD B Topper 1675  
 Beckton Ruth B634 MB

**BECKTON RUTH P591 LN**  
 Beckton Lancer T5 L095  
 Beckton Ruth E549 TP

BWT	78
WR	110
ADG	3.86
Ywt	1127
YR	102
Scr.	34
Fr.	5.5

**DAM**

Age	10
Wt	1292
Prog. BW	72
WR	109
YR	105
Wean Pct.	45%
Cow Eff.	94

RAAA HerdBuilder index: **170** (Top 6% of all RA bulls)  
 RAAA GridMaster index: **50** (Top 47% of all RA bulls)

Calv. Ease	BW	WW	YW	Milk	HPG	Stay	Maint. En.	
EPDs	8	-2.1	52	81	23	10	17	-1.5
Marb	+0.40		REA	-0.02		Bfat		-0.01

★★★★★ for Low Maintenance, Marbling, Superior Cow, Calving Ease, Stayability.

**81** **BECKTON LIKABLE B629 E3** 

1-A 100% # 1705870 Tat.: BKT4 B629

Birth: 4-6-14

Beckton Likable S633  
**BECKTON LIKABLE U130 L2**  
 Ref. L-2  
 Beckton Kit S478 LN

Beckton Lancer F442 T  
 Beckton Kit F468 JL  
 Beckton Lancer F442 T  
 Beckton Kit F468 JL  
 Beckton Epic K F075  
 Beckton Minerva F495 CH  
 Beckton Scamp TR FB22  
 Bkt Bayberry LC31 SC  
 Beckton Epic KM M115  
 Beckton Scamp TR FB22  
 Bkt Bayberry D736 GL

Bwt	77
WR	99
ADG	4.83
Ywt	1306
YR	118
Scr.	38
Fr.	5.0

**DAM**

Age	7
Wt	1310
Prog. BW	72
WR	107
YR	108
Wean Pct.	40%
Cow Eff.	84

RAAA HerdBuilder index: **135** (Top 26% of all RA bulls)  
 RAAA GridMaster index: **50** (Top 44% of all RA bulls)

Calv. Ease	BW	WW	YW	Milk	HPG	Stay	Maint. En.	
EPDs	7	-3.1	53	83	23	9	13	-1.9
Marb	+0.34		REA	+0.23		Bfat		+0.02

★★★★★ for Low Maintenance, Growth, Gainability, Marbling, Rib-eye area, Superior Cow, Calving Ease, Stayability.

**84** **BECKTON SCAMP B018 S5** 

1-A 100% # 1706225 Tat.: BKT4 B018

Birth: 2-14-14

Beckton Scamp X458 H3  
**BECKTON SCAMP Z460 L4**  
 Ref. S-2  
 Beckton Belga W405 L

Beckton Scamp T A825  
 BKT Pine Marie R401 HU  
 Beckton Lancer F442 T  
 Beckton Belga K285 JL  
 Beckton Scamp T A825  
 BKT Pine Marie R401 HU  
 Beckton Nebula PJ S543  
 Beckton Indigo S016 NB

**BECKTON INDIGO Z462 S**  
 Beckton Scamp X458 H3  
 Beckton Indigo W706 N

Bwt	56
WR	101
ADG	4.32
Ywt	1077
YR	104
Scr.	35
Fr.	5.0

**DAM**

Age	2
Wt	806
Prog. BW	56
WR	101
YR	104
Wean Pct.	50%
Cow Eff.	105

RAAA HerdBuilder index: **192** (Top 2% of all RA bulls)  
 RAAA GridMaster index: **53** (Top 8% of all RA bulls)

Calv. Ease	BW	WW	YW	Milk	HPG	Stay	Maint. En.	
EPDs	14	-7.3	49	80	19	7.8	13.3	-9.1
Marb	+0.51		REA	+0.00		Bfat		+0.00

★★★★★ for Low Maintenance, Gainability, Marbling, Calving Ease, Stayability.

**82** **BECKTON NEBULA B423 L4** 

1-A 100% # 1706024 Tat.: BKT4 B423

Birth: 3-26-14

Beckton Nebula E P084  
**BECKTON NEBULA EN S347**  
 Ref. N-3  
 Beckton Eola P530 NB

Beckton Nebula M045  
 BKT Pine Marie M119 EP  
 Beckton Nebula M045  
 Beckton Eola M663 EP  
 Beckton Likable S633  
 Beckton Lana S718 LN  
 Beckton Loki CL S284  
 Beckton Ucola S513 HU

Beckton Likable U120 L2  
**BECKTON UCOLA X143 L**  
 Beckton Ucola U709 LO

Bwt	67
WR	104
ADG	3.98
Ywt	1157
YR	105
Scr.	37
Fr.	5.5

**DAM**

Age	4
Wt	1080
Prog. BW	50
WR	94
YR	105
Wean Pct.	49%
Cow Eff.	102

RAAA HerdBuilder index: **197** (Top 1% of all RA bulls)  
 RAAA GridMaster index: **55** (Top 2% of all RA bulls)

Calv. Ease	BW	WW	YW	Milk	HPG	Stay	Maint. En.	
EPDs	16	-7.6	44	66	30	12	15	-4.9
Marb	+0.72		REA	-0.19		Bfat		+0.03

★★★★★ for Low Maintenance, Marbling, Calving Ease, Stayability.

**85** **BECKTON LIKABLE B784 N4** 

1-A 100% # 1706074 Tat.: BKT4 B784

Birth: 4-16-14

Beckton Likable U130 L2  
**BECKTON LIKABLE Y124 L3**  
 Ref. L-3  
 BKT Pine Marie S802 LO

Beckton Likable S633  
 Beckton Kit S478 LN  
 Beckton Lasso P741  
 BKT Pine Marie P475 LN  
 Beckton Nebula E P084  
 Beckton Eola P530 NB  
 Beckton Epic K4 N795  
 Beckton Susan P090 CE

Beckton Nebula EN S347  
**BECKTON SUSAN X753 N**  
 Beckton Susan T685 EP

Bwt	NA
WR	114
ADG	4.32
Ywt	1189
YR	108
Scr.	34
Fr.	5.5

**DAM**

Age	4
Wt	1064
Prog. BW	55
WR	107
YR	104
Wean Pct.	56%
Cow Eff.	118

RAAA HerdBuilder index: **173** (Top 5% of all RA bulls)  
 RAAA GridMaster index: **55** (Top 2% of all RA bulls)

Calv. Ease	BW	WW	YW	Milk	HPG	Stay	Maint. En.	
EPDs	11	-4.5	55	90	25	11	14	-1.9
Marb	+0.77		REA	-0.06		Bfat		+0.05

★★★★★ for Low Maintenance, Growth, Gainability, Marbling, Superior Cow, High Cow Efficiency, Calving Ease, Stayability.

• Bulls •



**88** **BECKTON ACCENT B322 E2** 

1-A 100% # 1705871 Tat.: BKT4 B322

Birth: 3-21-14

Beckton Cody K1 P014  
Beckton Rose M126 WR  
Beckton Cherokee N N479  
Beckton Christy N740 HR  
Beckton Christy R046 CQ  
Beckton Epic K3 M606  
Beckton Lana F268 CT  
Beckton Julian GG B571  
Beckton Tara M635 JL  
Beckton Tara J266 HR

**BECKTON ACCENT W180 C2**  
Ref. A-2

**BECKTON TARA T537 EP**

DAM	
Age	7
Wt	1102
Prog. BW	65
WR	103
YR	100
Wean Pct.	48%
Cow Eff.	101

BWT	70
WR	100
ADG	3.41
YWt.	1068
YR	97
Scr.	37
Fr.	5.0

RAAA HerdBuilder index: **154** (Top 12% of all RA bulls)  
RAAA GridMaster index: **52** (Top 13% of all RA bulls)

Calv. Ease	BW	WW	YW	Milk	HPG	Stay	Maint. En.	
EPDs	13	-5.9	49	77	25	10	12	-5.5
Marb	+0.48		REA	+0.13		Bfat		+0.03

★★★★★ for Low Maintenance, Marbling, Rib-eye area, Calving Ease.

**86** **BECKTON SCAMP B110 N4** 

1-A 100% # 1705627 Tat.: BSF4 B110

Birth: 2-28-14

Beckton Scamp T A825  
Beckton Scamp 8954  
Bkt Encino 8459 TJ  
Beckton Epic KH P678  
Beckton Lana S074 EP  
Beckton Lana P317 JL  
Beckton Nebula L P093  
Beckton Nebula T398 V3  
Beckton Minerva J615 VG  
Beckton Dominor ZC M919  
Beckton Barmaid S758 DM  
Beckton Barmaid K080 CH

**BECKTON SCAMP X494 E3**  
Ref. S-1

**BECKTON BARMAID X654 N**

DAM	
Age	4
Wt	1104
Prog. BW	62
WR	96
YR	101
Wean Pct.	42%
Cow Eff.	88

BWT	72
WR	86
ADG	4.60
YWt.	1112
YR	101
Scr.	37
Fr.	5.5

RAAA HerdBuilder index: **171** (Top 6% of all RA bulls)  
RAAA GridMaster index: **50** (Top 40% of all RA bulls)

Calv. Ease	BW	WW	YW	Milk	HPG	Stay	Maint. En.	
EPDs	12	-5.0	45	73	26	11	15	-5.9
Marb	+0.42		REA	+0.00		Bfat		-0.01

★★★★★ for Low Maintenance, Gainability, Marbling, Calving Ease, Stayability.

**89** **BECKTON NEBULA B577 J4** 

1-A 100% # 1705978 Tat.: BKT4 B577

Birth: 4-2-14

Beckton Nebula L P093  
Beckton Nebula M045  
Beckton Marta M021 LN  
Beckton Dominor ZC M919  
Beckton Belga R716 DM  
Beckton Belga K285 JL  
Beckton Julian G1 J526  
Beckton Rose J725 EP  
Beckton Justice V N656  
Beckton Lana R121 JC  
Beckton Lana N432 HR

**BECKTON NEBULA W486 D3**  
Ref. N-4

**BECKTON LANA W479 J**

DAM	
Age	5
Wt	1038
Prog. BW	66
WR	101
YR	104
Wean Pct.	49%
Cow Eff.	104

BWT	72
WR	97
ADG	4.66
YWt.	1138
YR	103
Scr.	35
Fr.	5.5

RAAA HerdBuilder index: **191** (Top 2% of all RA bulls)  
RAAA GridMaster index: **52** (Top 12% of all RA bulls)

Calv. Ease	BW	WW	YW	Milk	HPG	Stay	Maint. En.	
EPDs	13	-5.2	44	71	21	10	17	-3.8
Marb	+0.60		REA	-0.01		Bfat		+0.03

★★★★★ for Low Maintenance, Gainability, Marbling, Calving Ease, Stayability.

**87** **BECKTON NEBULA B358 E4** 

1-A 100% # 1705595 Tat.: BSF4 B358

Birth: 3-23-14

Beckton Nebula L P093  
Beckton Nebula M045  
Beckton Marta M021 LN  
Beckton Dominor ZC M919  
Beckton Belga R716 DM  
Beckton Belga K285 JL  
Beckton Emperor T641 E2  
Beckton Emperor R100  
Beckton Vernice R416 EP  
Beckton Julian 7526G  
Beckton Belga K476 JL  
Beckton Belga F772 VG

**BECKTON NEBULA W486 D3**  
Ref. N-4

**BECKTON BELGA X269 E**

DAM	
Age	4
Wt	1048
Prog. BW	64
WR	97
YR	102
Wean Pct.	50%
Cow Eff.	105

BWT	76
WR	104
ADG	4.49
YWt.	1161
YR	105
Scr.	35
Fr.	5.5

RAAA HerdBuilder index: **191** (Top 2% of all RA bulls)  
RAAA GridMaster index: **52** (Top 14% of all RA bulls)

Calv. Ease	BW	WW	YW	Milk	HPG	Stay	Maint. En.	
EPDs	13	-3.8	56	87	18	9	17	-4.1
Marb	+0.49		REA	+0.03		Bfat		+0.03

★★★★★ for Low Maintenance, Growth, Gainability, Marbling, Calving Ease, Stayability.

**90** **BECKTON CLIFFTOP B479 E4** 

1-A 100% # 1705463 Tat.: BSF4 B479

Birth: 3-27-14

BKT Clifftop TP R288  
Beckton Clifftop T C075  
Beckton Christy K209 CO  
Beckton Epic KM M115  
Beckton Lydia M607 LO  
Beckton Lydia S274 EP  
Beckton Epic K3 M606  
Beckton Epic KJ J722  
Beckton Lana F268 CT  
Beckton Julian 7526G  
Beckton Marta C314 JL  
Beckton Marta 8955KR

**BECKTON CLIFFTOP W692 E3**  
Ref. C-1

**BECKTON MARTA R790 EP**

DAM	
Age	9
Wt	1234
Prog. BW	69
WR	98
YR	101
Wean Pct.	41%
Cow Eff.	87

BWT	70
WR	91
ADG	3.30
YWt.	1018
YR	92
Scr.	36
Fr.	5.5

RAAA HerdBuilder index: **151** (Top 14% of all RA bulls)  
RAAA GridMaster index: **52** (Top 20% of all RA bulls)

Calv. Ease	BW	WW	YW	Milk	HPG	Stay	Maint. En.	
EPDs	10	-5.2	40	71	24	9	13	-4.8
Marb	+0.46		REA	-0.13		Bfat		+0.05

★★★★★ for Low Maintenance, Marbling, Calving Ease, Stayability.



• Bulls •



Lot 91

# 93

**BECKTON SCAMP B157 J4**  
1-A 100% # 1705500 Tat.: BSF4 B157

Birth: 3-7-14

Beckton Scamp T A825

**BECKTON SCAMP X494 E3**  
Ref. S-1

Beckton Lana S074 EP

TR Julian RT561

**BECKTON FIREFLY U409 JD**  
Beckton Firefly J650 CD

Beckton Scamp 8954

Bkt Encino 8459 TJ

Beckton Epic KH P678

Beckton Lana P317 JL

TR Julian LT151

TR Dyna HT824

Beckton Cody V E023

Beckton Firefly E684 NP

BWt **76**

WR **99**

ADG **3.52**

YWt. **1074**

YR **98**

Scr. **36**

Fr. **5.5**

# 91

**BECKTON LIKABLE B377 L4**  
1-A 100% # 1705449 Tat.: BSF4 B377

Birth: 3-24-14

Beckton Likable U130 L2

**BECKTON LIKABLE Y124 L3**  
Ref. L-3

BKT Pine Marie S802 LO

Beckton Lancer T7 M089

**BECKTON MINOLA P596 LN**  
Beckton Minola M155 CE

Beckton Likable S633

Beckton Kit S478 LN

Beckton Lasso P741

BKT Pine Marie P475 LN

Beckton Lancer F442 T

Beckton Tamara G141 HE

Beckton Cruiser K118

Beckton Minola K592 EP

BWt **70**

WR **96**

ADG **4.43**

YWt. **1146**

YR **104**

Scr. **33**

Fr. **5.0**

**DAM**

Age 10

Wt 1232

Prog.BW 81

WR 107

YR 106

Wean Pct. 44%

Cow Eff. 92

RAAA HerdBuilder index: **134** (Top **27%** of all RA bulls)

RAAA GridMaster index: **51** (Top **32%** of all RA bulls)

	Calv.Ease	BW	WW	YW	Milk	HPG	Stay	Maint.En.
EPDs	<b>8</b>	<b>-4.1</b>	<b>50</b>	<b>82</b>	<b>21</b>	<b>12</b>	<b>13</b>	<b>0.8</b>
	Marb <b>+0.45</b>		REA <b>+0.07</b>		Bfat <b>+0.00</b>			



# 92

**BECKTON EPIC B458 C6**  
1-A 100% # 1705919 Tat.: BKT4 B458

Birth: 3-27-14

Beckton Epic K6 S569

**BECKTON EPIC X464 L5**  
Ref. E-3

Beckton Lana M393 LN

Beckton Clifftop T3 N800

**BECKTON COCA U561 CT**  
Beckton Coca P328 EP

Beckton Epic KM M115

Beckton Sierra N703 LM

Beckton Lancer T3 J396

Beckton Lana F081 LN

Bkt Clifftop TV G672

Beckton Lana J384 CD

Beckton Epic KJ J722

Beckton Coca J276 CL

BWt **81**

WR **103**

ADG **3.75**

YWt. **1132**

YR **103**

Scr. **35**

Fr. **5.5**

**DAM**

Age 6

Wt 1012

Prog.BW 67

WR 99

YR 102

Wean Pct. 57%

Cow Eff. 120

RAAA HerdBuilder index: **127** (Top **33%** of all RA bulls)

RAAA GridMaster index: **50** (Top **48%** of all RA bulls)

	Calv.Ease	BW	WW	YW	Milk	HPG	Stay	Maint.En.
EPDs	<b>8</b>	<b>-1.5</b>	<b>54</b>	<b>92</b>	<b>28</b>	<b>6</b>	<b>12</b>	<b>-6.0</b>
	Marb <b>+0.49</b>		REA <b>+0.14</b>		Bfat <b>+0.02</b>			

# 94

**BECKTON ACCENT B356 N2**  
1-A 100% # 1705964 Tat.: BKT4 B356

Birth: 3-23-14

Beckton Cody K1 P014

**BECKTON ACCENT U777 C2**  
Ref. A-1

Beckton Susan R022 CQ

Beckton Nebula EN S347

**BECKTON LARKABA W272 N**  
Beckton Larkaba N643 HR

Beckton Cody KH M390

Beckton Rose M126 WR

Beckton Cherokee N N479

Beckton Susan N023 JE

Beckton Nebula E P084

Beckton Eola P530 NB

Beckton Herald FJ J776

Beckton Larkaba J765 CH

BWt **68**

WR **100**

ADG **3.64**

YWt. **1094**

YR **99**

Scr. **34**

Fr. **5.0**

**DAM**

Age 5

Wt 896

Prog.BW 61

WR 104

YR 102

Wean Pct. 62%

Cow Eff. 131

RAAA HerdBuilder index: **198** (Top **1%** of all RA bulls)

RAAA GridMaster index: **53** (Top **6%** of all RA bulls)

	Calv.Ease	BW	WW	YW	Milk	HPG	Stay	Maint.En.
EPDs	<b>14</b>	<b>-7.0</b>	<b>42</b>	<b>64</b>	<b>32</b>	<b>13</b>	<b>16</b>	<b>-8.9</b>
	Marb <b>+0.60</b>		REA <b>-0.05</b>		Bfat <b>+0.03</b>			

★★★★★ for Low Maintenance, Marbling, Rib-eye area, High Cow Efficiency, Calving Ease.

★★★★★ for Low Maintenance, Marbling, High Cow Efficiency, Calving Ease, Stayability.

• Bulls •

**95** **BECKTON EPIC B399 H7** 

1-A 100% # 1705880 Tat.: BKT4 B399

Birth: 3-25-14

Beckton Epic U749 D5  
**BECKTON EPIC Y484 N6**  
 Ref. E-5  
 Beckton Lydia S069 NB

Beckton Epic K4 N795  
 Beckton Denise R308 DM  
 Beckton Nebula P P707  
 Beckton Lydia P583 WR  
 Beckton Hustler C2 L079  
 Beckton Lana L007 JL  
 Beckton Justice G302  
 Beckton Christy J743 JL

BWt **72**  
 WR **98**  
 ADG **3.52**  
 YWt. **1088**  
 YR **99**  
 Scr. **37**  
 Fr. **5.0**

Beckton Heritage N013  
**BECKTON CHRISTY T749 HT**  
 Beckton Christy N542 JC

**DAM**  
 Age 7  
 Wt 1184  
 Prog.BW 71  
 WR 99  
 YR 97  
 Wean Pct. 46%  
 Cow Eff. 97

RAAA HerdBuilder index: **155** (Top 11% of all RA bulls)  
 RAAA GridMaster index: **52** (Top 20% of all RA bulls)

Calv.Ease	BW	WW	YW	Milk	HPG	Stay	Maint.En.
EPDs <b>9</b>	<b>-3.3</b>	<b>61</b>	<b>100</b>	<b>14</b>	<b>8</b>	<b>14</b>	<b>-2.8</b>

Marb **+0.59** REA **+0.25** Bfat **-0.01**

★★★★★ for Low Maintenance, Marbling, Rib-eye area, Calving Ease, Stayability.

**97** **BECKTON JULIAN B010 L8** 

1-A 100% # 1706160 Tat.: BKT4 B010

Birth: 2-12-14

Beckton Julian X721 E6  
**BECKTON JULIAN Z382 J7**  
 Ref. J-5  
 Beckton Larkaba X064 J

Beckton Julian U699 L5  
 Beckton Lana U329 EP  
 Beckton Julian U699 L5  
 Beckton Larkaba U475 CT  
 Beckton Lancer T371 H4  
 Beckton Minerva L324 LN  
 Beckton Dominor Z1 R610  
 Beckton Firefly T284 WA

BWt **61**  
 WR **125**  
 ADG **3.98**  
 YWt. **1116**  
 YR **108**  
 Scr. **34**  
 Fr. **5.0**

Beckton Lancer X250 L5  
**BECKTON FIREFLY Z112 L**  
 Beckton Firefly X453 D

**DAM**  
 Age 2  
 Wt 842  
 Prog.BW 61  
 WR 125  
 YR 108  
 Wean Pct. 61%  
 Cow Eff. 129

RAAA HerdBuilder index: **195** (Top 2% of all RA bulls)  
 RAAA GridMaster index: **54** (Top 5% of all RA bulls)

Calv.Ease	BW	WW	YW	Milk	HPG	Stay	Maint.En.
EPDs <b>15</b>	<b>-6.3</b>	<b>61</b>	<b>95</b>	<b>26</b>	<b>10.8</b>	<b>17.8</b>	<b>-5.2</b>

Marb **+0.42** REA **+0.28** Bfat **+0.03**

★★★★★ for Low Maintenance, Growth, Marbling, Rib-eye area, Superior Cow, High Cow Efficiency, Calving Ease, Stayability.

**96** **BECKTON HERITAGE B500 J4** 

1-A 100% # 1705806 Tat.: BKT4 B500

Birth: 3-28-14

Beckton Heritage T270 J2  
**BECKTON HERITAGE X403 L3**  
 Ref. H-1  
 Beckton Indigo H150 LN

Beckton Heritage N013  
 Beckton Coca P602 JL  
 Beckton Lancer TE F363  
 Beckton Indigo F376 CT  
 Beckton Julian G1 J526  
 Beckton Rose J725 EP  
 Beckton Copper J E616  
 Beckton Susan E140 TP

BWt **75**  
 WR **105**  
 ADG **3.98**  
 YWt. **1170**  
 YR **106**  
 Scr. **35**  
 Fr. **5.0**

Beckton Julio L233  
**BECKTON SUSAN P857 JO**  
 Beckton Susan G199 CO

**DAM**  
 Age 10  
 Wt 1040  
 Prog.BW 72  
 WR 107  
 YR 105  
 Wean Pct. 53%  
 Cow Eff. 111

RAAA HerdBuilder index: **163** (Top 8% of all RA bulls)  
 RAAA GridMaster index: **54** (Top 3% of all RA bulls)

Calv.Ease	BW	WW	YW	Milk	HPG	Stay	Maint.En.
EPDs <b>10</b>	<b>-3.8</b>	<b>54</b>	<b>81</b>	<b>28</b>	<b>6</b>	<b>14</b>	<b>-4.4</b>

Marb **+0.58** REA **-0.15** Bfat **+0.07**

★★★★★ for Low Maintenance, Growth, Marbling, Superior Cow, Calving Ease, Stayability.

**98** **BECKTON NEBULA B721 J5** 

1-A 100% # 1705876 Tat.: BKT4 B721

Birth: 4-14-14

Beckton Nebula U206 V3  
**BECKTON NEBULA X096 N4**  
 Ref. N-5  
 Beckton Tamara U185 NB

Beckton Nebula P P707  
 Beckton Minerva J615 VG  
 Beckton Nebula P P707  
 Beckton Tamara P813 CH  
 Beckton Julian GG B571  
 MS Geometric 917  
 Beckton Loki F251  
 Beckton Indigo H150 LN

BWt **64**  
 WR **109**  
 ADG **3.86**  
 YWt. **1136**  
 YR **103**  
 Scr. **36**  
 Fr. **5.5**

TR Julian LT151  
**BECKTON INDIGO T613 JT**  
 Beckton Indigo N467 LO

**DAM**  
 Age 7  
 Wt 1152  
 Prog.BW 64  
 WR 104  
 YR 105  
 Wean Pct. 53%  
 Cow Eff. 111

RAAA HerdBuilder index: **188** (Top 2% of all RA bulls)  
 RAAA GridMaster index: **54** (Top 3% of all RA bulls)

Calv.Ease	BW	WW	YW	Milk	HPG	Stay	Maint.En.
EPDs <b>11</b>	<b>-5.5</b>	<b>58</b>	<b>100</b>	<b>22</b>	<b>8</b>	<b>17</b>	<b>-1.1</b>

Marb **+0.70** REA **+0.04** Bfat **+0.01**

★★★★★ for Low Maintenance, Marbling, Superior Cow, Calving Ease, Stayability.



Lot 98

• Bulls •

**99** **BECKTON EPIC B692 N6**  
1-A 100% # 1705861 Tat.: BKT4 B692



Birth: 4-11-14

Beckton Epic K4 N795  
**BECKTON EPIC U749 D5**  
Ref. E-1

Beckton Denise R308 DM

Beckton Epic KJ J722  
Beckton Sierra J789 EP  
Beckton Dominor ZC M919  
Beckton Denise L639 JL  
Beckton Nebula M045  
BKT Pine Marie M119 EP  
Beckton Lancer F442 T  
Beckton Lana J384 CD

BWt **78**  
WR **114**  
ADG **3.75**  
YWt. **1198**  
YR **108**  
Scr. **31**  
Fr. **5.5**

Beckton Nebula E P084  
**BECKTON LANA T348 NB**  
Beckton Lana M167 LN

**DAM**  
Age 7  
Wt 1240  
Prog.BW 70  
WR 102  
YR 100  
Wean Pct. 48%  
Cow Eff. 101

RAAA HerdBuilder index: **129** (Top 32% of all RA bulls)  
RAAA GridMaster index: **51** (Top 27% of all RA bulls)  
Calv.Ease BW WW YW Milk HPG Stay Maint.En.  
EPDs **11 -3.0 57 97 20 4 13 2.2**  
Marb **+0.55** REA **+0.28** Bfat **+0.02**

★★★★★ for Low Maintenance, Growth, Marbling, Rib-eye area, Calving Ease, Stayability.

**102** **BECKTON SCAMP B191 N4**  
1-A 100% # 1705828 Tat.: BKT4 B191



Birth: 3-13-14

Beckton Scamp T A825  
**BECKTON SCAMP X494 E3**  
Ref. S-1

Beckton Lana S074 EP

Beckton Scamp 8954  
Bkt Encino 8459 TJ  
Beckton Epic KH P678  
Beckton Lana P317 JL  
Beckton Nebula M045  
Beckton Lana M809 EP  
Beckton Warrior CL M686  
Beckton Lydia M121 WR

BWt **70**  
WR **95**  
ADG **3.58**  
YWt. **1045**  
YR **95**  
Scr. **35**  
Fr. **5.0**

Beckton Nebula P P707  
**BECKTON LYDIA S069 NB**  
Beckton Lydia P583 WR

**DAM**  
Age 8  
Wt 1084  
Prog.BW 65  
WR 101  
YR 100  
Wean Pct. 49%  
Cow Eff. 104

RAAA HerdBuilder index: **182** (Top 3% of all RA bulls)  
RAAA GridMaster index: **51** (Top 24% of all RA bulls)  
Calv.Ease BW WW YW Milk HPG Stay Maint.En.  
EPDs **13 -5.8 49 78 22 12 15 -8.6**  
Marb **+0.43** REA **+0.05** Bfat **-0.01**

★★★★★ for Low Maintenance, Marbling, Calving Ease, Stayability.

**100** **BECKTON EPIC B336 N6**  
1-A 100% # 1705887 Tat.: BKT4 B336



Birth: 3-22-14

Beckton Epic K4 N795  
**BECKTON EPIC U749 D5**  
Ref. E-1

Beckton Denise R308 DM

Beckton Epic KJ J722  
Beckton Sierra J789 EP  
Beckton Dominor ZC M919  
Beckton Denise L639 JL  
Beckton Nebula E P084  
Beckton Eola P530 NB  
Beckton Loki C M740  
Beckton Eola J454 JL

BWt **68**  
WR **103**  
ADG **3.24**  
YWt. **1046**  
YR **95**  
Scr. **36**  
Fr. **5.0**

Beckton Nebula EN S347  
**BECKTON EOLA U027 NB**  
Beckton Eola S317 LO

**DAM**  
Age 6  
Wt 1034  
Prog.BW 66  
WR 114  
YR 107  
Wean Pct. 52%  
Cow Eff. 110

RAAA HerdBuilder index: **146** (Top 17% of all RA bulls)  
RAAA GridMaster index: **53** (Top 11% of all RA bulls)  
Calv.Ease BW WW YW Milk HPG Stay Maint.En.  
EPDs **12 -5.8 46 83 26 8 13 0.1**  
Marb **+0.60** REA **+0.08** Bfat **+0.03**

★★★★★ for Low Maintenance, Marbling, Superior Cow, Calving Ease, Stayability.

**103** **BECKTON JULIAN B542 R6**  
1-A 100% # 1706057 Tat.: BKT4 B542



Birth: 3-31-14

Beckton Julian G5 S107  
**BECKTON JULIAN W841 J5**  
Ref. J-3

Beckton Christy J743 JL

Beckton Julian GJ P535  
Beckton Minola P826 DM  
Beckton Julian GG B571  
Beckton Christy A111 VQ  
TR Romeo NT379  
Beckton Belga K285 JL  
Beckton Julian G3 P608  
Beckton Larkaba P645 JL

BWt **78**  
WR **106**  
ADG **3.52**  
YWt. **1110**  
YR **101**  
Scr. **33**  
Fr. **5.5**

Beckton Roman J S158  
**BECKTON LARKABA X544 J**  
Beckton Larkaba S083 JL

**DAM**  
Age 4  
Wt 1132  
Prog.BW 75  
WR 101  
YR 102  
Wean Pct. 51%  
Cow Eff. 107

RAAA HerdBuilder index: **177** (Top 4% of all RA bulls)  
RAAA GridMaster index: **52** (Top 13% of all RA bulls)  
Calv.Ease BW WW YW Milk HPG Stay Maint.En.  
EPDs **13 -2.4 59 93 21 11 15 -1.1**  
Marb **+0.58** REA **+0.14** Bfat **+0.04**

★★★★★ for Low Maintenance, Marbling, Rib-eye area, Calving Ease, Stayability.

**101** **BECKTON LIKABLE B305 C3**  
1-A 100% # 1705957 Tat.: BKT4 B305



Birth: 3-20-14

Beckton Likable S633  
**BECKTON LIKABLE U130 L2**  
Ref. L-2

Beckton Kit S478 LN

Beckton Lancer F442 T  
Beckton Kit F468 JL  
Beckton Lancer F442 T  
Beckton Kit F468 JL  
Beckton Cliffot T C075  
Beckton Christy K209 CO  
Beckton Laramie L044  
Beckton Lydia L647 JL

BWt **84**  
WR **102**  
ADG **3.52**  
YWt. **1099**  
YR **100**  
Scr. **35**  
Fr. **5.0**

BKT Cliffot TP R288  
**BECKTON LYDIA W178 C**  
Beckton Lydia N047 LM

**DAM**  
Age 5  
Wt 1230  
Prog.BW 73  
WR 108  
YR 107  
Wean Pct. 44%  
Cow Eff. 92

RAAA HerdBuilder index: **160** (Top 9% of all RA bulls)  
RAAA GridMaster index: **51** (Top 34% of all RA bulls)  
Calv.Ease BW WW YW Milk HPG Stay Maint.En.  
EPDs **8 -1.5 57 88 21 10 16 -1.2**  
Marb **+0.52** REA **+0.45** Bfat **+0.05**

★★★★★ for Low Maintenance, Marbling, Rib-eye area, Superior Cow, Calving Ease, Stayability.

**104** **BECKTON JULIAN B139 J8**  
1-2 100% # 1705695 Tat.: BSF4 B139



Birth: 3-4-14

Beckton Julian X721 E6  
**BECKTON JULIAN Z382 J7**  
Ref. J-5

Beckton Larkaba X064 J

Beckton Julian U699 L5  
Beckton Lana U329 EP  
Beckton Julian U699 L5  
Beckton Larkaba U475 CT  
Beckton Julian U699 L5  
Beckton Lana U329 EP  
Beckton Dominor Z1 R610  
Beckton Christy J743 JL

BWt **63**  
WR **115**  
ADG **3.35**  
YWt. **1072**  
YR **103**  
Scr. **36**  
Fr. **5.5**

Beckton Julian X721 E6  
**BECKTON CHRISTY Z083 J**  
Beckton Christy X648 D

**DAM**  
Age 2  
Wt 890  
Prog.BW 63  
WR 115  
YR 103  
Wean Pct. 57%  
Cow Eff. 121

RAAA HerdBuilder index: **206** (Top 1% of all RA bulls)  
RAAA GridMaster index: **53** (Top 8% of all RA bulls)  
Calv.Ease BW WW YW Milk HPG Stay Maint.En.  
EPDs **13 -5.0 65 102 27 12 18 -7.1**  
Marb **+0.36** REA **+0.27** Bfat **+0.03**

★★★★★ for Low Maintenance, Marbling, Rib-eye area, High Cow Efficiency, Calving Ease, Stayability.

• Bulls •

**105** BECKTON NEBULA B451 L2  
1-A 100% # 1706049 Tat.: BKT4 B451



Birth: 3-27-14

Beckton Neptune R2 K065  
Beckton Lana C735 TP  
Beckton Julian GG B571  
Beckton Belga G493 HR  
Beckton Loki C M740  
Beckton Lakme J460 LT  
Beckton Nebula M045  
Beckton Coca P459 LN

**BECKTON NEBULA M045**  
Ref. N-1

**BECKTON COCA X433 L**  
Beckton Loki CL S284  
Beckton Coca T419 NB

**DAM**  
Age 4  
Wt 1176  
Prog.BW 72  
WR 105  
YR 101  
Wean Pct. 47%  
Cow Eff. 98

RAAA HerdBuilder index: **197** (Top 1% of all RA bulls)  
RAAA GridMaster index: **54** (Top 4% of all RA bulls)

Calv.Ease	BW	WW	YW	Milk	HPG	Stay	Maint.En.
EPDs 15	-3.3	58	94	16	9	17	-3.1

Marb **+0.57** REA **-0.28** Bfat **+0.05**

BWt **84**  
WR **108**  
ADG **2.90**  
YWt **1057**  
YR **96**  
Scr. **30**  
Fr. **5.5**

★★★★★ for Low Maintenance, Marbling, Calving Ease, Stayability.

**107** BECKTON EPIC B638 L6  
1-A 100% # 1705583 Tat.: BSF4 B638



Birth: 4-6-14

Beckton Epic K4 N795  
Beckton Sierra J789 EP  
Beckton Dominor ZC M919  
Beckton Denise L639 JL  
Beckton Likable S633  
Beckton Lana S718 LN  
Beckton Nebula L P093  
BKT Larkabel R038 WA

**BECKTON EPIC U749 D5**  
Ref. E-1

**BECKTON LARKABEL X110 L**  
Beckton Likable U120 L2  
BKT Larkabel U613 NB

**DAM**  
Age 4  
Wt 960  
Prog.BW 67  
WR 104  
YR 107  
Wean Pct. 51%  
Cow Eff. 108

RAAA HerdBuilder index: **144** (Top 18% of all RA bulls)  
RAAA GridMaster index: **50** (Top 44% of all RA bulls)

Calv.Ease	BW	WW	YW	Milk	HPG	Stay	Maint.En.
EPDs 9	-4.1	49	90	21	7	15	-0.3

Marb **+0.52** REA **+0.37** Bfat **+0.01**

BWt **69**  
WR **98**  
ADG **4.66**  
YWt **1212**  
YR **110**  
Scr. **34**  
Fr. **5.0**

★★★★★ for Low Maintenance, Growth, Gainability, Marbling, Rib-eye area, Superior Cow, Calving Ease, Stayability.

**106** BECKTON LIKABLE B548 N4  
1-A 100% # 1705629 Tat.: BSF4 B548



Birth: 3-31-14

Beckton Likable U130 L2  
Beckton Kit S478 LN  
Beckton Lasso P741  
BKT Pine Marie S802 LO  
Beckton Nebula M045  
Beckton Ruth M967 EP  
Beckton Warhawk N560  
Beckton Larkabel N769 HR

**BECKTON LIKABLE Y124 L3**  
Ref. L-3

**BECKTON LARKABEL X676 N**  
Beckton Nebula T269 E2  
BKT Larkabel R038 WA

**DAM**  
Age 4  
Wt 1182  
Prog.BW 64  
WR 106  
YR 103  
Wean Pct. 46%  
Cow Eff. 97

RAAA HerdBuilder index: **160** (Top 9% of all RA bulls)  
RAAA GridMaster index: **52** (Top 14% of all RA bulls)

Calv.Ease	BW	WW	YW	Milk	HPG	Stay	Maint.En.
EPDs 10	-4.3	50	83	22	10	15	-0.7

Marb **+0.58** REA **+0.09** Bfat **+0.04**

BWt **71**  
WR **107**  
ADG **4.15**  
YWt **1163**  
YR **105**  
Scr. **40**  
Fr. **5.0**

★★★★★ for Low Maintenance, Growth, Gainability, Marbling, Calving Ease, Stayability.

**108** BECKTON NEBULA B017 N6  
1-A 100% # 1706251 Tat.: BKT4 B017



Birth: 2-14-14

Beckton Nebula X096 N4  
Beckton Nebula U206 V3  
Beckton Tamara U185 NB  
Beckton Nebula T054 H3  
Beckton Minola S103 JL  
Beckton Nebula T269 E2  
Beckton Firefly T006 DM  
Beckton Epic KM M115  
Bkt Maiata K503 EP

**BECKTON NEBULA Z111 N5**  
Ref. N-7

**BECKTON MAIATA Z652 N**  
Beckton Nebula W130 D3  
Beckton Maiata T282 EP

**DAM**  
Age 2  
Wt 704  
Prog.BW 65  
WR 100  
YR 109  
Wean Pct. 57%  
Cow Eff. 120

RAAA HerdBuilder index: **193** (Top 2% of all RA bulls)  
RAAA GridMaster index: **53** (Top 9% of all RA bulls)

Calv.Ease	BW	WW	YW	Milk	HPG	Stay	Maint.En.
EPDs 11	-4.0	51	89	20	10.5	15.3	-3.3

Marb **+0.63** REA **-0.14** Bfat **+0.03**

BWt **65**  
WR **100**  
ADG **4.26**  
YWt **1134**  
YR **109**  
Scr. **34**  
Fr. **5.0**

★★★★★ for Low Maintenance, Growth, Gainability, Marbling, High Cow Efficiency, Calving Ease, Stayability.



**109** BECKTON WARRIOR B165 O7  
1-A 100% # 1706166 Tat.: BKT4 B165



Birth: 3-9-14

Beckton Warrior T248 L5  
Beckton Warrior N645 T1  
Beckton Kit R503 LN  
Beckton Nebula T054 H3  
Beckton Freyja T147 HI  
Beckton Roman J S158  
Beckton Sierra K557 LO  
Beckton Roman J S158  
Beckton Larkaba S083 JL

**BECKTON WARRIOR Z936 N6**  
Ref. W-1

**BECKTON LARKABA Z150 J**  
Beckton Janus X799 L2  
Beckton Larkaba X544 J

**DAM**  
Age 2  
Wt 904  
Prog.BW 87  
WR 113  
YR 109  
Wean Pct. 55%  
Cow Eff. 116

RAAA HerdBuilder index: **139** (Top 22% of all RA bulls)  
RAAA GridMaster index: **48** (Top 77% of all RA bulls)

Calv.Ease	BW	WW	YW	Milk	HPG	Stay	Maint.En.
EPDs 7	2.4	63	98	19	9	14	-3.1

Marb **+0.46** REA **+0.14** Bfat **-0.01**

BWt **87**  
WR **113**  
ADG **4.15**  
YWt **1135**  
YR **109**  
Scr. **34**  
Fr. **5.0**

★★★★★ for Low Maintenance, Growth, Gainability, Marbling, Rib-eye area, Superior Cow, Calving Ease, Stayability.

• Bulls •

**110 BECKTON CARDINAL B027 C**  
1-A 100% # 1705756 Tat.: BSF4 B027



Birth: 2-16-14

TR Ricardo DOS  
**TR DOUBLE EAGLE ZT220**  
Ref. C-4  
Beckton Lana U182 JC

BFCK Cherokee Cryn 4912  
TR Dyna LT111  
Beckton Justice C1 R483  
Beckton Lana H544 WR  
BKT Clifftop TP R288  
BKT Pine Marie R213 EP  
Beckton Hustler C G407  
Beckton Dinah G334 CT

**BECKTON DINAH Z659 C**  
Beckton Clifftop W577 E3  
Beckton Dinah K287 HU

BWt	55
WR	103
ADG	4.21
YWt	1097
YR	106
Scr.	35
Fr.	5.0

**DAM**  
Age 2  
Wt 862  
Prog.BW 55  
WR 103  
YR 106  
Wean Pct. 48%  
Cow Eff. 101

RAAA HerdBuilder index: **164** (Top 8% of all RA bulls)  
RAAA GridMaster index: **53** (Top 9% of all RA bulls)

Calv.Ease	BW	WW	YW	Milk	HPG	Stay	Maint.En.	
EPDs	12	-6.6	50	83	23	12	13	-6.3

Marb **+0.62** REA **+0.22** Bfat **+0.02**

**113 BECKTON ACCENT B403 N3**  
1-A 100% # 1705865 Tat.: BKT4 B403



Birth: 3-25-14

Beckton Accent U777 C2  
**BECKTON ACCENT Y312 N3**  
Ref. A-4  
BKT Larkeisa S055 NB

Beckton Cody K1 P014  
Beckton Susan R022 CQ  
Beckton Nebula P F707  
Beckton Larkeisa P688 CH  
Beckton Nebula M045  
Beckton Marta M021 LN  
Beckton Cruiser K118  
Beckton Eola C611 SC

**BECKTON EOLA T435 NB**  
Beckton Nebula L P093  
Beckton Eola P336 CE

BWt	63
WR	92
ADG	4.15
YWt	1128
YR	102
Scr.	38
Fr.	5.0

**DAM**  
Age 7  
Wt 1198  
Prog.BW 68  
WR 93  
YR 99  
Wean Pct. 43%  
Cow Eff. 90

RAAA HerdBuilder index: **197** (Top 1% of all RA bulls)  
RAAA GridMaster index: **53** (Top 7% of all RA bulls)

Calv.Ease	BW	WW	YW	Milk	HPG	Stay	Maint.En.	
EPDs	13	-6.9	45	72	19	11	17	-5.3

Marb **+0.48** REA **+0.00** Bfat **+0.04**

★★★★★ for Low Maintenance, Growth, Gainability, Marbling, Rib-eye area, Calving Ease, Stayability.

★★★★★ for Low Maintenance, Gainability, Marbling, Calving Ease, Stayability.

**111 BECKTON CLIFFTOP B725 V4**  
1-A 100% # 1705796 Tat.: BKT4 B725



Birth: 4-14-14

BKT Clifftop TP R288  
**BECKTON CLIFFTOP W692 E3**  
Ref. C-1  
Beckton Lydia S274 EP

Beckton Clifftop T C075  
Beckton Christy K209 CO  
Beckton Epic KM M115  
Beckton Lydia M607 LO  
Beckton Vegas SV H078  
Beckton Eola H073 EP  
Beckton Herald H1 H348  
BKT Larkeisa H443 DM

**BECKTON LARKEISA P268 VG**  
Beckton Vegas S1 K316  
BKT Larkeisa K053 HR

BWt	69
WR	107
ADG	4.83
YWt	1226
YR	111
Scr.	37
Fr.	5.0

**DAM**  
Age 10  
Wt 1200  
Prog.BW 73  
WR 109  
YR 108  
Wean Pct. 47%  
Cow Eff. 99

RAAA HerdBuilder index: **146** (Top 16% of all RA bulls)  
RAAA GridMaster index: **53** (Top 11% of all RA bulls)

Calv.Ease	BW	WW	YW	Milk	HPG	Stay	Maint.En.	
EPDs	9	-4.6	48	83	27	9	13	-3.5

Marb **+0.55** REA **-0.15** Bfat **+0.04**

★★★★★ for Low Maintenance, Growth, Gainability, Marbling, Superior Cow, Calving Ease, Stayability.



**112 BECKTON EPIC B109 S7**  
1-A 100% # 1706158 Tat.: BKT4 B109



Birth: 2-28-14

Beckton Epic U749 D5  
**BECKTON EPIC Z434 L6**  
Ref. E-6  
Beckton Sierra N403 LN

Beckton Epic K4 N795  
Beckton Denise R308 DM  
Beckton Lancer TH K417  
Beckton Sierra J659 DM  
Beckton Scamp T A825  
Beckton Lana S074 EP  
Beckton Warrior T248 L5  
BKT Suffeina T467 HT

**BECKTON SUFFEINA Z095 S**  
Beckton Scamp X494 E3  
Beckton Suffeina X536 W

BWt	84
WR	106
ADG	4.09
YWt	1089
YR	105
Scr.	33
Fr.	5.5

**DAM**  
Age 2  
Wt 812  
Prog.BW 84  
WR 106  
YR 105  
Wean Pct. 53%  
Cow Eff. 111

RAAA HerdBuilder index: **139** (Top 22% of all RA bulls)  
RAAA GridMaster index: **49** (Top 71% of all RA bulls)

Calv.Ease	BW	WW	YW	Milk	HPG	Stay	Maint.En.	
EPDs	9	0.9	61	101	23	9	14	-1.2

Marb **+0.47** REA **+0.21** Bfat **+0.00**

★★★★★ for Low Maintenance, Gainability, Marbling, Rib-eye area, Superior Cow, Calving Ease, Stayability.

**114 BECKTON ACCENT B712 N2**  
1-A 100% # 1705996 Tat.: BKT4 B712



Birth: 4-13-14

Beckton Cody K1 P014  
**BECKTON ACCENT U777 C2**  
Ref. A-1  
Beckton Susan R022 CQ

Beckton Cody KH M390  
Beckton Rose M126 WR  
Beckton Cherokee N N479  
Beckton Susan N023 JE  
Beckton Nebula L P093  
Beckton Minerva J615 VG  
Beckton Epic KM M115  
Beckton Larkeisa P519 NM

**BECKTON LARKEISA W687 N**  
Beckton Nebula T398 V3  
BKT Larkeisa T525 EP

BWt	73
WR	99
ADG	3.58
YWt	1105
YR	100
Scr.	38
Fr.	5.5

**DAM**  
Age 5  
Wt 1110  
Prog.BW 69  
WR 98  
YR 98  
Wean Pct. 50%  
Cow Eff. 105

RAAA HerdBuilder index: **168** (Top 6% of all RA bulls)  
RAAA GridMaster index: **52** (Top 22% of all RA bulls)

Calv.Ease	BW	WW	YW	Milk	HPG	Stay	Maint.En.	
EPDs	12	-5.4	49	76	28	11	15	-4.4

Marb **+0.46** REA **+0.08** Bfat **+0.00**

★★★★★ for Low Maintenance, Marbling, Calving Ease, Stayability.

• Bulls •

**115 BECKTON WARRIOR B088 N7**  
1-A 100% # 1706205 Tat.: BKT4 B088

Birth: 2-26-14

Beckton Warrior T248 L5  
Beckton Kit R503 LN  
Beckton Nebula T054 H3  
Beckton Freyja W462 N  
Beckton Freyja T147 HI  
Beckton Nebula J R475  
BKT Pine Marie R401 HU  
Beckton Epic K6 S569  
BKT Pine Marie T593 HT

**BECKTON WARRIOR Z936 N6**  
Ref. W-1

**BKT PINE MARIE Z340 N**  
Beckton Nebula T054 H3  
BKT Pine Marie W857 E

**DAM**  
Age 2  
Wt 860  
Prog.BW 67  
WR 110  
YR 108  
Wean Pct. 52%  
Cow Eff. 109

RAAA HerdBuilder index: **148** (Top 16% of all RA bulls)  
RAAA GridMaster index: **51** (Top 37% of all RA bulls)  
Calv.Ease BW WW YW Milk HPG Stay Maint.En.  
EPDs **8 -2.8 54 87 16 11 12 -8.3**  
Marb **+0.51** REA **+1.14** Bfat **+0.1**

BWt **67**  
WR **110**  
ADG **4.38**  
YWT **1117**  
YR **108**  
Scr. **33**  
Fr. **5.5**



**118 BECKTON JULIAN B626 N6**  
1-A 100% # 1706096 Tat.: BKT4 B626

Birth: 4-5-14

Beckton Julian G5 S107  
Beckton Minola P826 DM  
Beckton Julian GG B571  
Bkt Suffeina A828 DM  
Beckton Nebula M045  
Beckton Ruth M967 EP  
TR Julian RT561  
Beckton Coca R490 JC

**BECKTON JULIAN X465 J5**  
Ref. J-4

**BECKTON COCA Y114 N**  
Beckton Nebula T269 E2  
Beckton Coca U187 JD

**DAM**  
Age 3  
Wt 918  
Prog.BW 66  
WR 105  
YR 107  
Wean Pct. 54%  
Cow Eff. 115

RAAA HerdBuilder index: **191** (Top 2% of all RA bulls)  
RAAA GridMaster index: **53** (Top 7% of all RA bulls)  
Calv.Ease BW WW YW Milk HPG Stay Maint.En.  
EPDs **11 -3.2 57 95 18 11 16 -7.1**  
Marb **+0.71** REA **-0.02** Bfat **+0.03**

BWt **67**  
WR **103**  
ADG **4.09**  
YWT **1130**  
YR **106**  
Scr. **37**  
Fr. **5.5**



★★★★★ for Low Maintenance, Growth, Gainability, Marbling, Rib-eye area, Superior Cow, Calving Ease.

★★★★★ for Low Maintenance, Growth, Gainability, Marbling, Superior Cow, Calving Ease, Stayability.

**116 BECKTON EPIC B777 A6**  
1-A 100% # 1705639 Tat.: BSF4 B777

Birth: 4-21-14

Beckton Epic K6 S569  
Beckton Epic KM M115  
Beckton Sierra N703 LM  
Beckton Lancer T3 J396  
Beckton Lana F081 LN  
Beckton Cody K1 P014  
Beckton Christy R046 CQ  
Beckton Jules L429  
Beckton Indigo N754 HR

**BECKTON EPIC X464 L5**  
Ref. E-3

**BECKTON INDIGO Y041 A**  
Beckton Accent W180 C2  
Beckton Indigo W419 J

**DAM**  
Age 3  
Wt 902  
Prog.BW 73  
WR 114  
YR 110  
Wean Pct. 62%  
Cow Eff. 130

RAAA HerdBuilder index: **150** (Top 14% of all RA bulls)  
RAAA GridMaster index: **50** (Top 40% of all RA bulls)  
Calv.Ease BW WW YW Milk HPG Stay Maint.En.  
EPDs **10 0.1 67 109 30 10 14 -3.2**  
Marb **+0.48** REA **+0.19** Bfat **+0.1**

BWt **84**  
WR **114**  
ADG **4.15**  
YWT **1201**  
YR **113**  
Scr. **33**  
Fr. **5.5**



★★★★★ for Low Maintenance, Growth, Gainability, Marbling, Rib-eye area, Superior Cow, High Cow Efficiency, Calving Ease, Stayability.



**117 BECKTON SCAMP B798 J4**  
1-A 100% # 1705981 Tat.: BKT4 B798

Birth: 4-23-14

Beckton Scamp T A825  
Beckton Scamp 8954  
Bkt Encino 8459 TJ  
Beckton Hustler C2 L079  
Bkt Pine Marie LC30 CD  
TR Julian LT151  
Beckton Minerva L278 LN  
Beckton Nebula M045  
Andras Scarlett 2029

**BECKTON SCAMP X458 H3**  
Ref. S-3

**BECKTON SCARLETT W497 J**  
Beckton Jet L P491  
Beckton Scarlett R808 NB

**DAM**  
Age 5  
Wt 1062  
Prog.BW 70  
WR 102  
YR 108  
Wean Pct. 54%  
Cow Eff. 114

RAAA HerdBuilder index: **164** (Top 8% of all RA bulls)  
RAAA GridMaster index: **51** (Top 29% of all RA bulls)  
Calv.Ease BW WW YW Milk HPG Stay Maint.En.  
EPDs **12 -2.4 50 81 23 11 13 -11.0**  
Marb **+0.58** REA **-0.04** Bfat **+0.1**

BWt **85**  
WR **103**  
ADG **4.15**  
YWT **1198**  
YR **109**  
Scr. **39**  
Fr. **5.5**



★★★★★ for Low Maintenance, Growth, Gainability, Marbling, Calving Ease, Stayability.

**119 BECKTON SCAMP B072 A5**  
1-A 100% # 1706268 Tat.: BKT4 B072

Birth: 2-24-14

Beckton Scamp X458 H3  
Beckton Scamp T A825  
BKT Pine Marie R401 HU  
Beckton Lancer F442 T  
Beckton Belga K285 JL  
Beckton Cody K1 P014  
Beckton Susan R022 CQ  
Beckton Epic T330 L5  
Beckton Susan T048 NB

**BECKTON SCAMP Z460 L4**  
Ref. S-2

**BECKTON SUSAN Z770 A**  
Beckton Accent U777 C2  
Beckton Susan W058 E

**DAM**  
Age 2  
Wt 786  
Prog.BW 63  
WR 111  
YR 108  
Wean Pct. 57%  
Cow Eff. 120

RAAA HerdBuilder index: **179** (Top 4% of all RA bulls)  
RAAA GridMaster index: **52** (Top 20% of all RA bulls)  
Calv.Ease BW WW YW Milk HPG Stay Maint.En.  
EPDs **12 -5.2 51 84 26 9 16 -5.3**  
Marb **+0.46** REA **+0.18** Bfat **+0.01**

BWt **63**  
WR **111**  
ADG **4.15**  
YWT **1117**  
YR **108**  
Scr. **35**  
Fr. **5.5**



★★★★★ for Low Maintenance, Growth, Gainability, Marbling, Rib-eye area, Superior Cow, High Cow Efficiency, Calving Ease, Stayability.

• Bulls •



**120** **BECKTON EPIC C600 L6**  
1-A 100% # 1706044 Tat.: BKT4 B600

Birth: 4-3-14

Beckton Epic K4 N795  
**BECKTON EPIC U749 D5**  
Ref. E-1  
Beckton Denise R308 DM

Beckton Epic KJ J722  
Beckton Sierra J789 EP  
Beckton Dominor ZC M919  
Beckton Denise L639 JL  
Beckton Lancer F442 T  
Beckton Coca F276 HV  
Beckton Loki F251  
Beckton Lana G056 CO

BWt **79**  
WR **96**  
ADG **4.09**  
YWt. **1120**  
YR **102**  
Scr. **32**  
Fr. **5.0**

**BECKTON LANA X371 L**  
Beckton Lancer T371 H4  
Beckton Lana M793 LO

**DAM**  
Age 4  
Wt 1062  
Prog.BW 70  
WR 105  
YR 106  
Wean Pct. 49%  
Cow Eff. 102

RAAA HerdBuilder index: **125** (Top 35% of all RA bulls)  
RAAA GridMaster index: **51** (Top 37% of all RA bulls)  
Calv.Ease BW WW YW Milk HPG Stay Maint.En.  
EPDs **9 -2.4 51 89 19 6 12 1.1**  
Marb **+0.60** REA **+1.14** Bfat **+0.2**

★★★★★ for Low Maintenance, Gainability, Marbling, Rib-eye area, Superior Cow, Calving Ease.

**121** **BECKTON EPIC B761 J6**  
1-A 100% # 1705447 Tat.: BSF4 B761

Birth: 4-18-14

Beckton Epic K4 N795  
**BECKTON EPIC U749 D5**  
Ref. E-1  
Beckton Denise R308 DM

Beckton Epic KJ J722  
Beckton Sierra J789 EP  
Beckton Dominor ZC M919  
Beckton Denise L639 JL  
Beckton Julian 7526G  
Bkt Marta 9A13 JL  
Beckton Herald HH E503  
Beckton Coca G605 VG

BWt **71**  
WR **100**  
ADG **3.81**  
YWt. **1144**  
YR **104**  
Scr. **34**  
Fr. **5.0**

**BECKTON COCA P440 JL**  
Beckton Julian GG B571  
Beckton Coca K498 HR

**DAM**  
Age 10  
Wt 1194  
Prog.BW 74  
WR 105  
YR 102  
Wean Pct. 47%  
Cow Eff. 99

RAAA HerdBuilder index: **140** (Top 22% of all RA bulls)  
RAAA GridMaster index: **50** (Top 40% of all RA bulls)  
Calv.Ease BW WW YW Milk HPG Stay Maint.En.  
EPDs **12 -4.1 50 87 21 7 12 -0.8**  
Marb **+0.44** REA **+0.31** Bfat **+0.2**

★★★★★ for Low Maintenance, Marbling, Rib-eye area, Calving Ease.

**123** **BECKTON EMPEROR B104 V4**  
1-A 100% # 1705686 Tat.: BSF4 B104

Birth: 2-27-14

Beckton Emperor T641 E2  
**BECKTON EMPEROR Z750 N3**  
Ref. E-8  
Beckton Lana U789 NB

Beckton Emperor R100  
Beckton Vernice R416 EP  
Beckton Nebula M045  
Beckton Lana P073 EP  
Beckton Nomad V 9871  
Beckton Birdie S110 NB  
Beckton Nebula T269 E2  
Beckton Barmaid G565 LN

BWt **67**  
WR **107**  
ADG **4.09**  
YWt. **1080**  
YR **104**  
Scr. **34**  
Fr. **5.0**

**BECKTON BARMAID Z028 N**  
Beckton Nomad X290 N3  
Beckton Barmaid X231 N

**DAM**  
Age 2  
Wt 752  
Prog.BW 67  
WR 107  
YR 104  
Wean Pct. 57%  
Cow Eff. 121

RAAA HerdBuilder index: **178** (Top 4% of all RA bulls)  
RAAA GridMaster index: **52** (Top 16% of all RA bulls)  
Calv.Ease BW WW YW Milk HPG Stay Maint.En.  
EPDs **12 -4.1 51 81 25 8 15 -7.1**  
Marb **+0.53** REA **-0.10** Bfat **+0.2**

★★★★★ for Low Maintenance, Gainability, Marbling, Superior Cow, High Cow Efficiency, Calving Ease, Stayability.

**122** **BECKTON CLIFFTOP B101 N5**  
1-A 100% # 1706102 Tat.: BKT4 B101

Birth: 2-27-14

Beckton Clifftop W692 E3  
**BECKTON CLIFFTOP Y012 C4**  
Ref. C-2  
Beckton Lana W240 C

BKT Clifftop TP R288  
Beckton Lydia S274 EP  
BKT Clifftop TP R288  
Beckton Lana L923 CD  
Beckton Nebula M045  
Beckton Lana M809 EP  
Beckton Heritage N013  
Beckton Rose M872 WR

BWt **65**  
WR **100**  
ADG **3.30**  
YWt. **1057**  
YR **97**  
Scr. **35**  
Fr. **5.0**

**BECKTON ROSE Y181 N**  
Beckton Nebula P P707  
Beckton Rose T639 HT

**DAM**  
Age 3  
Wt 912  
Prog.BW 56  
WR 102  
YR 95  
Wean Pct. 51%  
Cow Eff. 108

RAAA HerdBuilder index: **204** (Top 1% of all RA bulls)  
RAAA GridMaster index: **53** (Top 6% of all RA bulls)  
Calv.Ease BW WW YW Milk HPG Stay Maint.En.  
EPDs **13 -5.5 50 84 24 11 18 -6.0**  
Marb **+0.62** REA **-0.09** Bfat **+0.2**

★★★★★ for Low Maintenance, Marbling, Calving Ease, Stayability.

**124** **BECKTON LEGEND B067 D4**  
1-A 100% # 1706249 Tat.: BKT4 B067

Birth: 2-22-14

Beckton Legend X561 J2  
**BECKTON LEGEND Z689 J3**  
Ref. L-4  
Beckton Larkaba W868 J

Beckton Legend S670  
Beckton Lana T279 JO  
Beckton Julian G5 S107  
Beckton Larkaba S663 JE  
Beckton Dominor Z1 R610  
Beckton Mona R166 CQ  
Beckton Nebula N R573  
Beckton Coca R375 WR

BWt **65**  
WR **109**  
ADG **4.55**  
YWt. **1132**  
YR **109**  
Scr. **35**  
Fr. **5.0**

**BECKTON COCA Z639 D**  
Beckton Dominor W640 C5  
Beckton Coca T080 NB

**DAM**  
Age 2  
Wt 832  
Prog.BW 65  
WR 109  
YR 109  
Wean Pct. 53%  
Cow Eff. 112

RAAA HerdBuilder index: **195** (Top 2% of all RA bulls)  
RAAA GridMaster index: **53** (Top 5% of all RA bulls)  
Calv.Ease BW WW YW Milk HPG Stay Maint.En.  
EPDs **11 -3.7 60 92 19 11 17 -8.3**  
Marb **+0.64** REA **+0.00** Bfat **+0.04**

★★★★★ for Low Maintenance, Growth, Gainability, Marbling, Superior Cow, Calving Ease, Stayability.

• Bulls •

**125 BECKTON RANGER B065 J5**  
1-A 100% # 1706164 Tat.: BKT4 B065



Birth: 2-22-14

Beckton Ranger T603 H3  
Beckton Rose N044 HU  
Beckton Jet L P491  
Beckton Mona P874 WR  
Beckton Julian G5 S107  
Beckton Suffeina P643 JL  
Beckton Julian G5 S107  
Beckton Serena R023 JC

**BECKTON RANGER Z225 J4**  
Ref. R-1  
Beckton Mona U564 JT

**BECKTON SERENA Z140 J**  
Beckton Julian X465 J5  
Beckton Serena X617 J

BWt	66
WR	95
ADG	4.03
YWt	1066
YR	102
Scr.	33
Fr.	5.0

**DAM**  
Age 2  
Wt 830  
Prog.BW 66  
WR 95  
YR 102  
Wean Pct. 50%  
Cow Eff. 104

RAAA HerdBuilder index: **171** (Top 5% of all RA bulls)  
RAAA GridMaster index: **53** (Top 8% of all RA bulls)

Calv.Ease	BW	WW	YW	Milk	HPG	Stay	Maint.En.	
EPDs	10	-3.1	53	88	16	15	13	-9.2
Marb	+.68		REA	-.21		Bfat		+.04



★★★★★ for Low Maintenance, Gainability, Marbling, Calving Ease, Stayability.

**126 BECKTON SCAMP B504 H5**  
1-A 100% # 1706277 Tat.: BKT4 B504



Birth: 3-29-14

Beckton Scamp X458 H3  
Beckton Pine Marie R401 HU  
Beckton Lancer F442 T  
Beckton Belga K285 JL  
Beckton Heritage T270 J2  
Beckton Indigo H150 LN  
Beckton Nebula T398 V3  
Beckton Indigo T298 JM

**BECKTON SCAMP Z460 L4**  
Ref. S-2  
Beckton Belga W405 L

**BECKTON INDIGO Z814 H**  
Beckton Heritage X403 L3  
Beckton Indigo W165 N

BWt	60
WR	124
ADG	3.92
YWt	1159
YR	112
Scr.	39
Fr.	5.5

**DAM**  
Age 2  
Wt 816  
Prog.BW 60  
WR 124  
YR 112  
Wean Pct. 62%  
Cow Eff. 131

RAAA HerdBuilder index: **185** (Top 3% of all RA bulls)  
RAAA GridMaster index: **53** (Top 7% of all RA bulls)

Calv.Ease	BW	WW	YW	Milk	HPG	Stay	Maint.En.	
EPDs	12	-5.4	58	92	23	8.8	14.3	-6.1
Marb	+.47		REA	+.12		Bfat		+.02

★★★★★ for Low Maintenance, Growth, Marbling, Superior Cow, High Cow Efficiency, Calving Ease, Stayability.

**128 BECKTON NEW ERA B820 E2**  
1-A 100% # 1706054 Tat.: BKT4 B820



Birth: 4-25-14

Beckton Nebula P P707  
Beckton Nebula M045  
Beckton Lana M809 EP  
Beckton Justice C1 R483  
BKT Larkeisa R775 JC  
Beckton Epic KJ J722  
Beckton Sierra J789 EP  
Beckton Julian G1 J526  
Beckton Sheba MB04 LO

**BECKTON NEW ERA Y194**  
Ref. N-6  
Beckton Larkeisa T310 JC

**BECKTON SHEBA X484 E**  
Beckton Epic K4 N795  
Beckton Sheba T487 JL

BWt	80
WR	105
ADG	3.92
YWt	1159
YR	105
Scr.	36
Fr.	5.5

**DAM**  
Age 4  
Wt 1294  
Prog.BW 80  
WR 105  
YR 105  
Wean Pct. 44%  
Cow Eff. 93

RAAA HerdBuilder index: **156** (Top 11% of all RA bulls)  
RAAA GridMaster index: **55** (Top 2% of all RA bulls)

Calv.Ease	BW	WW	YW	Milk	HPG	Stay	Maint.En.	
EPDs	14	-3.7	64	107	20	4	13	2.0
Marb	+.68		REA	-.18		Bfat		+.05

★★★★★ for Low Maintenance, Growth, Marbling, Superior Cow, Calving Ease, Stayability.

**127 BECKTON NEBULA B673 N4**  
1-A 100% # 1705569 Tat.: BSF4 B673



Birth: 4-9-14

Beckton Nebula E P084  
Beckton Nebula M045  
BKT Pine Marie M119 EP  
Beckton Nebula M045  
Beckton Eola M663 EP  
Beckton Nebula G S237  
Beckton Marta S459 DM  
Beckton Nebula EN S347  
Beckton Marta S772 LO

**BECKTON NEBULA EN S347**  
Ref. N-3  
Beckton Eola P530 NB

**BECKTON MARTA X010 N**  
Beckton Nebula U031 D3  
Beckton Marta U079 NB

BWt	58
WR	111
ADG	3.52
YWt	1094
YR	99
Scr.	36
Fr.	5.0

**DAM**  
Age 4  
Wt 1028  
Prog.BW 68  
WR 113  
YR 107  
Wean Pct. 55%  
Cow Eff. 115

RAAA HerdBuilder index: **218** (Top 1% of all RA bulls)  
RAAA GridMaster index: **57** (Top 1% of all RA bulls)

Calv.Ease	BW	WW	YW	Milk	HPG	Stay	Maint.En.	
EPDs	15	-8.7	46	70	32	15	16	-7.6
Marb	+.86		REA	-.44		Bfat		+.03

★★★★★ for Low Maintenance, Marbling, Superior Cow, Calving Ease, Stayability.

**129 BECKTON EPIC B323 N6**  
1-A 100% # 1706040 Tat.: BKT4 B323



Birth: 3-21-14

Beckton Epic K4 N795  
Beckton Epic KJ J722  
Beckton Sierra J789 EP  
Beckton Dominor ZC M919  
Beckton Denise L639 JL  
Beckton Nebula M045  
Beckton Ruth M967 EP  
Beckton Nebula L P093  
Beckton Angel N150 LN

**BECKTON EPIC U749 D5**  
Ref. E-1  
Beckton Denise R308 DM

**BECKTON ANGEL X317 N**  
Beckton Nebula T269 E2  
Beckton Angel T772 NB

BWt	64
WR	95
ADG	3.86
YWt	1063
YR	96
Scr.	33
Fr.	5.0

**DAM**  
Age 4  
Wt 996  
Prog.BW 57  
WR 97  
YR 101  
Wean Pct. 48%  
Cow Eff. 101

RAAA HerdBuilder index: **158** (Top 10% of all RA bulls)  
RAAA GridMaster index: **51** (Top 27% of all RA bulls)

Calv.Ease	BW	WW	YW	Milk	HPG	Stay	Maint.En.	
EPDs	12	-6.4	43	81	20	6	15	1.5
Marb	+.47		REA	+.21		Bfat		+.02

★★★★★ for Low Maintenance, Marbling, Rib-eye area, Calving Ease, Stayability.



• Bulls •

**130 BECKTON NEBULA B815 E4**  
1-A 100% # 1705470 Tat.: BSF4 B815



Birth: 4-25-14

Beckton Nebula L P093  
**BECKTON NEBULA W486 D3**  
Ref. N-4

Beckton Belga R716 DM

Beckton Epic K4 N795  
**BECKTON LARKABA S299 EP**  
Beckton Larkaba D170 JV

Beckton Nebula M045  
Beckton Marta M021 LN  
Beckton Dominor ZC M919  
Beckton Belga K285 JL  
Beckton Epic KJ J722  
Beckton Sierra J789 EP  
Beckton Javelin RN Z358  
Beckton Larkaba Z257 ZN

BWt **75**  
WR **105**  
ADG **3.86**  
YWt. **1136**  
YR **103**  
Scr. **34**  
Fr. **5.5**

**DAM**  
Age 8  
Wt 1040  
Prog.BW 71  
WR 106  
YR 105  
Wean Pct. 56%  
Cow Eff. 118

RAAA HerdBuilder index: **165** (Top 7% of all RA bulls)  
RAAA GridMaster index: **52** (Top 13% of all RA bulls)  
Calv.Ease BW WW YW Milk HPG Stay Maint.En.  
EPDs **11 -3.7 52 86 20 7 15 -3.0**  
Marb **+0.61** REA **-0.02** Bfat **+0.03**

**133 BECKTON WARRIOR B654 N7**  
1-A 100% # 1706216 Tat.: BKT4 B654



Birth: 4-8-14

Beckton Warrior T248 L5  
**BECKTON WARRIOR Z936 N6**  
Ref. W-1

Beckton Freyja W462 N

Beckton Nebula T269 E2  
**BECKTON LAKME Z405 N**  
Beckton Lakme T692 EP

Beckton Warrior N645 T1  
Beckton Kit R503 LN  
Beckton Nebula T054 H3  
Beckton Freyja T147 HI  
Beckton Nebula M045  
Beckton Ruth M967 EP  
Beckton Epic KM M115  
Beckton Lakme P513 EP

BWt **81**  
WR **113**  
ADG **3.92**  
YWt. **1131**  
YR **109**  
Scr. **35**  
Fr. **6.0**

**DAM**  
Age 2  
Wt 934  
Prog.BW 81  
WR 113  
YR 109  
Wean Pct. 54%  
Cow Eff. 113

RAAA HerdBuilder index: **170** (Top 6% of all RA bulls)  
RAAA GridMaster index: **50** (Top 45% of all RA bulls)  
Calv.Ease BW WW YW Milk HPG Stay Maint.En.  
EPDs **7 0.1 62 99 18 10 16 -5.3**  
Marb **+0.42** REA **+0.08** Bfat **+0.03**

★★★★★ for Low Maintenance, Marbling, Superior Cow, High Cow Efficiency, Calving Ease, Stayability.

★★★★★ for Low Maintenance, Growth, Marbling, Superior Cow, Calving Ease, Stayability.

**131 BECKTON LIKABLE B766 E3**  
1-A 100% # 1705969 Tat.: BKT4 B766



Birth: 4-18-14

Beckton Likable S633  
**BECKTON LIKABLE U130 L2**  
Ref. L-2

Beckton Kit S478 LN

Beckton Emcee S466  
**BECKTON ROSE W346 E**  
Beckton Rose L083 LN

Beckton Lancer F442 T  
Beckton Kit F468 JL  
Beckton Lancer F442 T  
Beckton Kit F468 JL  
Beckton Epic K4 N795  
Beckton Larkaba H798 WR  
Beckton Lancer T4 J536  
Beckton Rose J152 LN

BWt **73**  
WR **104**  
ADG **3.30**  
YWt. **1059**  
YR **96**  
Scr. **35**  
Fr. **5.5**

**DAM**  
Age 5  
Wt 1108  
Prog.BW 68  
WR 100  
YR 97  
Wean Pct. 49%  
Cow Eff. 104

RAAA HerdBuilder index: **157** (Top 11% of all RA bulls)  
RAAA GridMaster index: **52** (Top 16% of all RA bulls)  
Calv.Ease BW WW YW Milk HPG Stay Maint.En.  
EPDs **10 -4.5 53 82 20 8 14 -4.3**  
Marb **+0.52** REA **+0.38** Bfat **+0.05**

★★★★★ for Low Maintenance, Marbling, Rib-eye area, Calving Ease, Stayability.

**134 BECKTON EPIC B429 H7**  
1-A 100% # 1705444 Tat.: BSF4 B429



Birth: 3-26-14

Beckton Epic T330 L5  
**BECKTON EPIC X816 C6**  
Ref. E-4

Beckton Mona R198 CQ

Beckton Herald FV J537  
**BECKTON BARMAID P323 HR**  
Beckton Barmaid J012 CO

Beckton Epic K4 N795  
Beckton Belga K202 LN  
Beckton Cherokee N N479  
Beckton Mona N009 JE  
Beckton Herald F FA20  
Beckton Kuruba F588 VG  
Beckton Copper JT G095  
Beckton Barmaid G565 LN

BWt **73**  
WR **95**  
ADG **4.09**  
YWt. **1065**  
YR **96**  
Scr. **37**  
Fr. **5.0**

**DAM**  
Age 10  
Wt 1164  
Prog.BW 72  
WR 106  
YR 102  
Wean Pct. 43%  
Cow Eff. 90

RAAA HerdBuilder index: **153** (Top 13% of all RA bulls)  
RAAA GridMaster index: **52** (Top 13% of all RA bulls)  
Calv.Ease BW WW YW Milk HPG Stay Maint.En.  
EPDs **10 -4.3 44 75 31 12 14 -1.6**  
Marb **+0.67** REA **-0.03** Bfat **+0.04**

★★★★★ for Low Maintenance, Gainability, Marbling, Calving Ease, Stayability.

**132 BECKTON JULIAN B540 N4**  
1-A 100% # 1706071 Tat.: BKT4 B540



Birth: 3-30-14

Beckton Julian 7526G  
**BECKTON JULIAN GG B571**  
Ref. J-1

Bkt Marta 9A13 JL

Beckton Nebula T054 H3  
**BECKTON LARKABA X719 N**  
Beckton Larkaba S863 JC

Beckton Julian 6592  
Bkt Belga 6746 GS  
Beckton Julian 7526G  
Bkt Marta 6498 XM  
Beckton Nebula J R475  
BKT Pine Marie R401 HU  
Beckton Justice CH M056  
Beckton Larkaba L088 WR

BWt **82**  
WR **94**  
ADG **3.98**  
YWt. **1074**  
YR **98**  
Scr. **35**  
Fr. **5.5**

**DAM**  
Age 4  
Wt 1238  
Prog.BW 77  
WR 93  
YR 95  
Wean Pct. 41%  
Cow Eff. 86

RAAA HerdBuilder index: **177** (Top 4% of all RA bulls)  
RAAA GridMaster index: **51** (Top 31% of all RA bulls)  
Calv.Ease BW WW YW Milk HPG Stay Maint.En.  
EPDs **15 -2.5 55 85 17 12 14 -2.2**  
Marb **+0.54** REA **+0.21** Bfat **+0.01**

★★★★★ for Low Maintenance, Marbling, Rib-eye area, Calving Ease, Stayability.



• Bulls •

**135** **BECKTON SCAMP B311 N4** 

1-A 100% # 1705557 Tat.: BSF4 B311

Birth: 3-21-14

Beckton Scamp T A825  
**BECKTON SCAMP X494 E3**  
 Ref. S-1 Beckton Lana S074 EP

Beckton Scamp 8954  
 Bkt Encino 8459 TJ  
 Beckton Epic KH P678  
 Beckton Lana P317 JL  
 Beckton Nebula M045  
 Beckton Lakme LA06 JL  
 Beckton Warrior T C371  
 Beckton Freyja B572 JL

BWt **83**  
 WR **94**  
 ADG **3.69**  
 YWt **1022**  
 YR **93**  
 Scr. **32**  
 Fr. **5.0**

Beckton Nebula G S237  
**BECKTON FREYJA W806 N**  
 Beckton Freyja M659 WR

**DAM**  
 Age 5  
 Wt 1262  
 Prog.BW 68  
 WR 98  
 YR 98  
 Wean Pct. 39%  
 Cow Eff. 82

RAAA HerdBuilder index: **161** (Top 9% of all RA bulls)  
 RAAA GridMaster index: **50** (Top 52% of all RA bulls)  
 Calv.Ease BW WW YW Milk HPG Stay Maint.En.  
 EPDs **10 -2.2 53 81 23 12 14 -6.8**  
 Marb **+0.36** REA **-0.07** Bfat **-0.01**

★★★★★ for Low Maintenance, Marbling, Calving Ease, Stayability.

**138** **BSF JAVELIN B476 N3** 

1-B 99% # 1706311 Tat.: BKB4 B476

Birth: 3-27-14

Beckton Javelin 6587  
**BKT JAVELIN 7466 R**  
 Ref. J-2 Beckton Rose 6807 RZ

Beckton Trojan 5253  
 Beckton Ileximka -3  
 Beckton Raza 2308-N  
 Bkt Baya Rose 5195  
 Beckton Nebula L P093  
 Beckton Minerva J615 VG  
 Beckton Julian G3 P608  
 BSF Lanette P754

BWt **70**  
 WR **109**  
 ADG **3.37**  
 YWt **1083**  
 YR **98**  
 Scr. **40**  
 Fr. **5.5**

Beckton Nebula T398 V3  
**BSF LANETTE X808 N**  
 BSF Lanette T717 JL

**DAM**  
 Age 4  
 Wt 992  
 Prog.BW 60  
 WR 108  
 YR 101  
 Wean Pct. 59%  
 Cow Eff. 125

RAAA HerdBuilder index: **189** (Top 2% of all RA bulls)  
 RAAA GridMaster index: **51** (Top 25% of all RA bulls)  
 Calv.Ease BW WW YW Milk HPG Stay Maint.En.  
 EPDs **15 -6.8 32 49 29 13 14 -14.9**  
 Marb **+0.51** REA **-1.10** Bfat **+0.01**

★★★★★ for Low Maintenance, Marbling, High Cow Efficiency, Calving Ease, Stayability.

**136** **BSF NEBULA B645 D4** 

1-B 98% # 1705462 Tat.: BSF4 B645

Birth: 4-7-14

Beckton Nebula L P093  
**BECKTON NEBULA W486 D3**  
 Ref. N-4 Beckton Belga R716 DM

Beckton Nebula M045  
 Beckton Marta M021 LN  
 Beckton Dominor ZC M919  
 Beckton Belga K285 JL  
 Beckton Dominor Z E401  
 Beckton Barmaid J012 CO  
 Beckton Clifftop T C075  
 BSF Regus F712

BWt **75**  
 WR **103**  
 ADG **3.82**  
 YWt **1114**  
 YR **101**  
 Scr. **37**  
 Fr. **5.0**

Beckton Dominor ZC M919  
**BSF DOMINIQUE R653 DM**  
 BSF Regus L683 CT

**DAM**  
 Age 9  
 Wt 1416  
 Prog.BW 65  
 WR 108  
 YR 105  
 Wean Pct. 41%  
 Cow Eff. 86

RAAA HerdBuilder index: **196** (Top 1% of all RA bulls)  
 RAAA GridMaster index: **52** (Top 23% of all RA bulls)  
 Calv.Ease BW WW YW Milk HPG Stay Maint.En.  
 EPDs **12 -4.4 48 80 22 11 19 1.8**  
 Marb **+0.53** REA **+0.03** Bfat **+0.01**

★★★★★ for Low Maintenance, Marbling, Superior Cow, Calving Ease, Stayability.

**139** **BSF NEBULA B531 A4** 

1-B 99% # 1705581 Tat.: BSF4 B531

Birth: 3-30-14

Beckton Nebula E P084  
**BECKTON NEBULA EN S347**  
 Ref. N-3 Beckton Eola P530 NB

Beckton Nebula M045  
 BKT Pine Marie M119 EP  
 Beckton Nebula M045  
 Beckton Eola M663 EP  
 Beckton Cody K1 P014  
 Beckton Susan R022 CQ  
 BKT Clifftop TP R288  
 BSF Regus F175

BWt **75**  
 WR **108**  
 ADG **3.60**  
 YWt **1146**  
 YR **104**  
 Scr. **36**  
 Fr. **5.0**

Beckton Accent U777 C2  
**BSF CLIFFTANA X100 A**  
 BSF Cliftana U177 CT

**DAM**  
 Age 4  
 Wt 1132  
 Prog.BW 71  
 WR 113  
 YR 104  
 Wean Pct. 51%  
 Cow Eff. 108

RAAA HerdBuilder index: **197** (Top 1% of all RA bulls)  
 RAAA GridMaster index: **54** (Top 2% of all RA bulls)  
 Calv.Ease BW WW YW Milk HPG Stay Maint.En.  
 EPDs **12 -4.9 50 74 33 15 16 -6.1**  
 Marb **+0.72** REA **-0.23** Bfat **+0.04**

★★★★★ for Low Maintenance, Marbling, Superior Cow, Calving Ease, Stayability.

**137** **BSF LEGEND B175 L4** 

1-B 99% # 1705734 Tat.: BSF4 B175

Birth: 3-10-14

Beckton Legend X561 J2  
**BECKTON LEGEND Z689 J3**  
 Ref. L-4 Beckton Larkaba W868 J

Beckton Legend S670  
 Beckton Lana T279 JO  
 Beckton Julian G5 S107  
 Beckton Larkaba S663 JE  
 Beckton Legend S670  
 Beckton Lana T279 JO  
 Beckton Roman J S158  
 BSF Red F608

BWt **77**  
 WR **101**  
 ADG **3.99**  
 YWt **1101**  
 YR **106**  
 Scr. **34**  
 Fr. **5.0**

Beckton Legend X561 J2  
**BSF JOANIE Z344 L**  
 BSF Joanie W716 J

**DAM**  
 Age 2  
 Wt 814  
 Prog.BW 77  
 WR 101  
 YR 106  
 Wean Pct. 54%  
 Cow Eff. 113

RAAA HerdBuilder index: **160** (Top 9% of all RA bulls)  
 RAAA GridMaster index: **51** (Top 34% of all RA bulls)  
 Calv.Ease BW WW YW Milk HPG Stay Maint.En.  
 EPDs **7 0.1 65 99 17 9.3 16 -8.4**  
 Marb **+0.54** REA **+0.26** Bfat **+0.01**

★★★★★ for Low Maintenance, Growth, Marbling, Rib-eye area, Calving Ease, Stayability.

**140** **BSF JAVELIN B427 N3** 

1-B 99% # 1705613 Tat.: BSF4 B427

Birth: 3-26-14

Beckton Javelin 6587  
**BKT JAVELIN 7466 R**  
 Ref. J-2 Beckton Rose 6807 RZ

Beckton Trojan 5253  
 Beckton Ileximka -3  
 Beckton Raza 2308-N  
 Bkt Baya Rose 5195  
 Beckton Nebula L P093  
 Beckton Minerva J615 VG  
 TR Julian RT561  
 BSF Helena R016 CQ

BWt **72**  
 WR **98**  
 ADG **3.88**  
 YWt **1084**  
 YR **98**  
 Scr. **35**  
 Fr. **5.5**

Beckton Nebula T398 V3  
**BSF HELENA X529 N**  
 BSF Helena T014 JD

**DAM**  
 Age 4  
 Wt 994  
 Prog.BW 68  
 WR 100  
 YR 97  
 Wean Pct. 53%  
 Cow Eff. 111

RAAA HerdBuilder index: **171** (Top 5% of all RA bulls)  
 RAAA GridMaster index: **50** (Top 42% of all RA bulls)  
 Calv.Ease BW WW YW Milk HPG Stay Maint.En.  
 EPDs **14 -5.9 29 42 26 13 14 -12.3**  
 Marb **+0.49** REA **-1.10** Bfat **+0.00**

★★★★★ for Low Maintenance, Marbling, Calving Ease, Stayability.

• Bulls •

**141** **BSF LIKABLE B002 M5** 

1-B 99% # 1706207 Tat.: BKT4 B002

Birth: 2-9-14

Beckton Likable U130 L2  
Beckton Indigo U658 JL  
Beckton Likable U120 L2  
Beckton Minola U188 NB  
Red Angus multiple sire  
Red Angus dam  
Beckton Heritage T270 J2  
Beckton Mona T150 JC

Beckton Likable X445 J3  
Beckton LIKABLE Z057 L4  
Ref. L  
Beckton Minola X107 L

Beckton Regina Z350 M  
Red Angus multiple sire  
Beckton Mona W045 H

**DAM**  
Age 2  
Wt 816  
Prog. BW 60  
WR 106  
YR 100  
Wean Pct. 53%  
Cow Eff. 111

BWT **60**  
WR **106**  
ADG **4.10**  
YWT **1036**  
YR **100**  
Scr. **36**  
Fr. **5.0**

RAAA HerdBuilder index: **178** (Top 4% of all RA bulls)  
RAAA GridMaster index: **53** (Top 8% of all RA bulls)

	Calv. Ease	BW	WW	YW	Milk	HPG	Stay	Maint. En.
EPDs	13	-6.4	49	79	21	8.5	13	-11.8
	Marb <b>+0.61</b>		REA <b>+1.19</b>			Bfat <b>+0.2</b>		

**143** **BSF WARRIOR B447 N5** 

1-B 99% # 1728944 Tat.: BSF4 B447

Birth: 3-27-14

Beckton Warrior CL M686  
Beckton Christy K101 CD  
Beckton Nebula P F707  
Beckton Larkeisa P688 CH  
Beckton Neptune R2 K065  
Beckton Belga K285 JL  
Beckton Justice C K449  
BSF Regus K341 JC

Beckton Warrior C1 S337  
Beckton LIKABLE W534 N4  
Ref. W  
BKT Larkeisa S055 NB

Beckton Nebula M045  
BSF NEBULANN R664 NB  
BSF Regus M043 JC

**DAM**  
Age 9  
Wt 1098  
Prog. BW 61  
WR 104  
YR 100  
Wean Pct. 47%  
Cow Eff. 100

BWT **70**  
WR **99**  
ADG **3.65**  
YWT **1039**  
YR **94**  
Scr. **37**  
Fr. **5.0**

RAAA HerdBuilder index: **177** (Top 4% of all RA bulls)  
RAAA GridMaster index: **54** (Top 3% of all RA bulls)

	Calv. Ease	BW	WW	YW	Milk	HPG	Stay	Maint. En.
EPDs	16	-6.1	47	75	22	14	14	-6.8
	Marb <b>+0.66</b>		REA <b>-0.04</b>			Bfat <b>+0.05</b>		

★★★★★ for Low Maintenance, Gainability, Marbling, Rib-eye area, Calving Ease, Stayability.

★★★★★ for Low Maintenance, Marbling, Calving Ease, Stayability.



**144** **BSF LIKABLE B544 A5** 

1-B 99% # 1729771 Tat.: BKB4 B544

Birth: 3-31-14

Beckton Likable U130 L2  
Beckton Indigo U658 JL  
Beckton Likable U120 L2  
Beckton Minola U188 NB  
Beckton Cody K1 P014  
Beckton Christy R046 CQ  
Beckton Cherokee N N479  
BSF Hustle P246

Beckton Likable X445 J3  
Beckton LIKABLE Z057 L4  
Ref. L  
Beckton Minola X107 L

Beckton Accent W180 C2  
BSF HUSTELLE Z692 A  
BSF Hustelle T531 CQ

**DAM**  
Age 2  
Wt 902  
Prog. BW 55  
WR 101  
YR 112  
Wean Pct. 49%  
Cow Eff. 102

BWT **55**  
WR **101**  
ADG **4.49**  
YWT **1161**  
YR **112**  
Scr. **35**  
Fr. **5.5**

RAAA HerdBuilder index: **162** (Top 8% of all RA bulls)  
RAAA GridMaster index: **52** (Top 12% of all RA bulls)

	Calv. Ease	BW	WW	YW	Milk	HPG	Stay	Maint. En.
EPDs	11	-5.2	55	91	21	12	15	-7.3
	Marb <b>+0.55</b>		REA <b>+0.30</b>			Bfat <b>+0.03</b>		

★★★★★ for Low Maintenance, Growth, Gainability, Marbling, Rib-eye area, Calving Ease, Stayability.

**142** **BSF CLIFFTOP B776 J4** 

1-B 99% # 1705603 Tat.: BSF4 B776

Birth: 4-20-14

Beckton Clifftop T C075  
Beckton Christy K209 CO  
Beckton Epic KM M115  
Beckton Lydia M607 LO  
Beckton Julian GJ P535  
Beckton Minola P826 DM  
Beckton Lancer T6 M467  
BSF Regus M383 CH

BKT Clifftop TP R288  
Beckton CLIFFTOP W692 E3  
Ref. C-1  
Beckton Lydia S274 EP

Beckton Julian G5 S107  
BSF LANETTE X408 J  
BSF Lanette P177

**DAM**  
Age 4  
Wt 1130  
Prog. BW 74  
WR 107  
YR 101  
Wean Pct. 54%  
Cow Eff. 113

BWT **81**  
WR **119**  
ADG **3.32**  
YWT **1150**  
YR **104**  
Scr. **38**  
Fr. **5.5**

RAAA HerdBuilder index: **177** (Top 4% of all RA bulls)  
RAAA GridMaster index: **53** (Top 10% of all RA bulls)

	Calv. Ease	BW	WW	YW	Milk	HPG	Stay	Maint. En.
EPDs	9	-1.9	59	100	26	11	16	-4.6
	Marb <b>+0.55</b>		REA <b>-0.20</b>			Bfat <b>+0.06</b>		

★★★★★ for Low Maintenance, Marbling, Calving Ease, Stayability.

**145** **BSF CARDINAL B094 S** 

1-2 99% # 1705717 Tat.: BSF4 B094

Birth: 2-26-14

BFCK Cherokee Cnyn 4912  
TR Dyna LT111  
Beckton Justice C1 R483  
Beckton Lana H544 WR  
Beckton Scamp T A825  
BKT Pine Marie R401 HU  
Beckton Nebula G S237  
BSF June S698 JJ

TR Ricardo DOS  
TR DOUBLE EAGLE ZT220  
Ref. C-4  
Beckton Lana U182 JC

Beckton Scamp X458 H3  
BSF JUNE Z202 S  
BSF June W761 N

**DAM**  
Age 2  
Wt 904  
Prog. BW 58  
WR 100  
YR 99  
Wean Pct. 44%  
Cow Eff. 94

BWT **58**  
WR **100**  
ADG **3.93**  
YWT **1032**  
YR **99**  
Scr. **32**  
Fr. **5.5**

RAAA HerdBuilder index: **173** (Top 5% of all RA bulls)  
RAAA GridMaster index: **53** (Top 8% of all RA bulls)

	Calv. Ease	BW	WW	YW	Milk	HPG	Stay	Maint. En.
EPDs	12	-6.2	54	85	20	10	7	-7.2
	Marb <b>+0.51</b>		REA <b>+0.17</b>			Bfat <b>+0.01</b>		

★★★★★ for Low Maintenance, Marbling, Rib-eye area, Calving Ease.

• Bulls •

**146** **BSF CARDINAL B127 J** 

1-B 99% # 1705678 Tat.: BSF4 B127

Birth: 3-3-14

TR Ricardo DOS  
**TR DOUBLE EAGLE ZT220**  
 Ref. C-4  
 Beckton Lana U182 JC

Beckton Julian X465 J5  
**BSF JUSTICIA Z006 J**  
 BSF Justicia X006 H

BFCK Cherokee Cnyn 4912  
 TR Dyna LT111  
 Beckton Justice C1 R483  
 Beckton Lana H544 WR  
 Beckton Julian G5 S107  
 Beckton Suffeina P643 JL  
 Beckton Hasten U108 J3  
 BSF Justicia U290 JC

BWt **66**  
 WR **96**  
 ADG **4.38**  
 YWt **1100**  
 YR **106**  
 Scr. **37**  
 Fr. **5.0**

**DAM**  
 Age 2  
 Wt 884  
 Prog.BW 66  
 WR 96  
 YR 106  
 Wean Pct. 43%  
 Cow Eff. 91

RAAA HerdBuilder index: **187** (Top 2% of all RA bulls)  
 RAAA GridMaster index: **53** (Top 11% of all RA bulls)

Calv.Ease	BW	WW	YW	Milk	HPG	Stay	Maint.En.
EPDs <b>11</b>	<b>-3.6</b>	<b>59</b>	<b>95</b>	<b>18</b>	<b>12</b>	<b>8.8</b>	<b>-8.2</b>

Marb **+0.60** REA **+0.21** Bfat **+0.02**

★★★★★ for Low Maintenance, Growth, Gainability, Marbling, Rib-eye area, Calving Ease.



**147** **BSF LEGEND B718 L2** 

1-B 99% # 1705659 Tat.: BSF4 B718

Birth: 4-14-14

Beckton Lancer F442 T  
**BECKTON LEGEND S670**  
 Ref. L-1  
 Beckton Kit F468 JL

BSF Lancer W007 N5  
**BSF NEBULANN Y430 L**  
 BSF Nebulann W177 N

Beckton Lancer T A664  
 Bkt Suffeina A828 DM  
 Beckton Julian GG B571  
 Beckton Kit A517 NP  
 Beckton Lancer T371 H4  
 BSF Dominique T338 NB  
 Beckton Nebula PJ S543  
 BSF Regus M535 EP

BWt **72**  
 WR **106**  
 ADG **3.88**  
 YWt **1099**  
 YR **103**  
 Scr. **32**  
 Fr. **5.5**

**DAM**  
 Age 3  
 Wt 854  
 Prog.BW 68  
 WR 105  
 YR 103  
 Wean Pct. 60%  
 Cow Eff. 126

RAAA HerdBuilder index: **184** (Top 3% of all RA bulls)  
 RAAA GridMaster index: **52** (Top 14% of all RA bulls)

Calv.Ease	BW	WW	YW	Milk	HPG	Stay	Maint.En.
EPDs <b>9</b>	<b>-2.2</b>	<b>61</b>	<b>92</b>	<b>12</b>	<b>8</b>	<b>17</b>	<b>-5.8</b>

Marb **+0.66** REA **+0.29** Bfat **+0.02**

★★★★★ for Low Maintenance, Marbling, Rib-eye area, Superior Cow, High Cow Efficiency, Calving Ease, Stayability.

**149** **BSF EPIC B131 E7** 

1-B 99% # 1705740 Tat.: BSF4 B131

Birth: 3-3-14

Beckton Epic U749 D5  
**BECKTON EPIC Z434 L6**  
 Ref. E-6  
 Beckton Sierra N403 LN

Beckton Epic X816 C6  
**BSF JUSTICIA Z461 E**  
 BSF Justicia X608 E

Beckton Epic K4 N795  
 Beckton Denise R308 DM  
 Beckton Lancer TH K417  
 Beckton Sierra J659 DM  
 Beckton Epic T330 L5  
 Beckton Mona R198 CQ  
 Beckton Epic K6 S569  
 BSF Justicia P007

BWt **63**  
 WR **103**  
 ADG **4.49**  
 YWt **1105**  
 YR **107**  
 Scr. **30**  
 Fr. **5.5**

**DAM**  
 Age 2  
 Wt 812  
 Prog.BW 63  
 WR 103  
 YR 107  
 Wean Pct. 51%  
 Cow Eff. 108

RAAA HerdBuilder index: **140** (Top 21% of all RA bulls)  
 RAAA GridMaster index: **51** (Top 26% of all RA bulls)

Calv.Ease	BW	WW	YW	Milk	HPG	Stay	Maint.En.
EPDs <b>10</b>	<b>-4.2</b>	<b>50</b>	<b>91</b>	<b>29</b>	<b>8</b>	<b>13</b>	<b>1.7</b>

Marb **+0.54** REA **+0.18** Bfat **+0.02**

★★★★★ for Low Maintenance, Growth, Gainability, Marbling, Rib-eye area, Superior Cow, Calving Ease, Stayability.

**148** **BSF EPIC B743 E7** 

1- 99% # Tat.: BSF4 B743

Birth: 4-16-14

Beckton Epic T330 L5  
**BECKTON EPIC X330 L6**  
 Ref. E-2  
 Beckton Kit R503 LN

Beckton Epic T330 L5  
**BSF ANDREA Y449 E**  
 BSF Andrea T146 JR

Beckton Epic K4 N795  
 Beckton Belga K202 LN  
 Beckton Lancer F442 T  
 Beckton Kit F468 JL  
 Beckton Epic K4 N795  
 Beckton Belga K202 LN  
 Beckton Jupiter R478  
 BSF Andrea R028 JJ

BWt **65**  
 WR **105**  
 ADG **4.27**  
 YWt **1144**  
 YR **105**  
 Scr. **33**  
 Fr. **5.5**

**DAM**  
 Age 3  
 Wt 814  
 Prog.BW 70  
 WR 109  
 YR 106  
 Wean Pct. 61%  
 Cow Eff. 128

RAAA HerdBuilder index: **NA** (Top NA% of all RA bulls)  
 RAAA GridMaster index: **NA** (Top NA% of all RA bulls)

Calv.Ease	BW	WW	YW	Milk	HPG	Stay	Maint.En.
EPDs <b>11.8</b>	<b>-5.0</b>	<b>36.3</b>	<b>69</b>	<b>15.5</b>	<b>6.5</b>	<b>13.5</b>	<b>-2.8</b>

Marb **+0.50** REA **+0.17** Bfat **+0.03**

★★★★★ for Low Maintenance, Growth, Gainability, Marbling, Rib-eye area, Superior Cow, High Cow Efficiency, Calving Ease, Stayability.

**150** **BSF EPIC B464 J6** 

1-B 99% # 1705460 Tat.: BSF4 B464

Birth: 3-27-14

Beckton Epic K4 N795  
**BECKTON EPIC U749 D5**  
 Ref. E-1  
 Beckton Denise R308 DM

Beckton Jules L429  
**BSF JULESTE R644 JE**  
 BSF Regus D616

Beckton Epic KJ J722  
 Beckton Sierra J789 EP  
 Beckton Dominor ZC M919  
 Beckton Denise L639 JL  
 Beckton Julian G1 J526  
 Beckton Barona J591 EP  
 Beckton Dominor S B431  
 BSF Regus B319

BWt **85**  
 WR **91**  
 ADG **3.76**  
 YWt **1048**  
 YR **95**  
 Scr. **33**  
 Fr. **5.0**

**DAM**  
 Age 9  
 Wt 1372  
 Prog.BW 68  
 WR 104  
 YR 103  
 Wean Pct. 37%  
 Cow Eff. 78

RAAA HerdBuilder index: **129** (Top 31% of all RA bulls)  
 RAAA GridMaster index: **50** (Top 58% of all RA bulls)

Calv.Ease	BW	WW	YW	Milk	HPG	Stay	Maint.En.
EPDs <b>11</b>	<b>-2.6</b>	<b>47</b>	<b>79</b>	<b>23</b>	<b>9</b>	<b>12</b>	<b>-0.6</b>

Marb **+0.53** REA **+0.24** Bfat **-0.01**

★★★★★ for Low Maintenance, Marbling, Rib-eye area, Calving Ease.

• Bulls •

**151** **BECKTON SCAMP B831 C4**   
 1-A 100% # 1705634 Tat.: BSF4 B831  
 Birth: 4-27-14  
 Beckton Scamp T A825 < Beckton Scamp 8954  
 Bkt Encino 8459 TJ  
**BECKTON SCAMP X458 H3** < Beckton Hustler C2 L079  
 Ref. S-3 < BKT Pine Marie R401 HU < Bkt Pine Marie LC30 CD  
 BWT **64**  
 WR **101**  
 ADG **3.82**  
 YWt. **1126**  
 YR **102**  
 Scr. **35**  
 Fr. **5.5**  
 Beckton Cherokee T450 L3 < Beckton Cherokee N N479  
**BECKTON LANA X767 C** < Beckton Annie M337 LN  
 Beckton Lana T674 JL < Beckton Julian 7526G  
 Beckton Lana L665 VG  
**DAM**  
 Age 4  
 Wt 1038  
 Prog.BW 59  
 WR 106  
 YR 106  
 Wean Pct. 52%  
 Cow Eff. 110  
 RAAA HerdBuilder index: **160** (Top 9% of all RA bulls)  
 RAAA GridMaster index: **51** (Top 28% of all RA bulls)  
 Calv.Ease BW WW YW Milk HPG Stay Maint.En.  
 EPDs **12 -6.2 39 66 21 11 12 -10.1**  
 Marb **+0.40** REA **+1.1** Bfat **+0.2**

★★★★★ for Low Maintenance, Marbling, Superior Cow, Calving Ease.

**154** **BECKTON JULIAN B095 D8**   
 1-A 100% # 1706174 Tat.: BKT4 B095  
 Birth: 2-26-14  
 Beckton Julian X721 E6 < Beckton Julian U699 L5  
 Beckton Lana U329 EP  
**BECKTON JULIAN Z382 J7** < Beckton Julian U699 L5  
 Ref. J-5 < Beckton Larkaba X064 J < Beckton Larkaba U475 CT  
 BWT **60**  
 WR **92**  
 ADG **3.54**  
 YWt. **996**  
 YR **96**  
 Scr. **33**  
 Fr. **5.0**  
 Beckton Dominor W640 C5 < Beckton Mona R166 CQ  
**BECKTON KIT Z181 D** < Beckton Lancer F442 T  
 Beckton Kit R503 LN < Beckton Kit F468 JL  
**DAM**  
 Age 2  
 Wt 866  
 Prog.BW 60  
 WR 92  
 YR 96  
 Wean Pct. 45%  
 Cow Eff. 95  
 RAAA HerdBuilder index: **194** (Top 2% of all RA bulls)  
 RAAA GridMaster index: **53** (Top 10% of all RA bulls)  
 Calv.Ease BW WW YW Milk HPG Stay Maint.En.  
 EPDs **14 -6.7 51 78 22 12 16 -8.5**  
 Marb **+0.48** REA **+0.26** Bfat **+0.03**

★★★★★ for Low Maintenance, Marbling, Rib-eye area, Calving Ease, Stayability.

**152** **BECKTON NEBULA B539 D3**   
 1-A 100% # 1705455 Tat.: BSF4 B539  
 Birth: 3-30-14  
 Beckton Nebula M045 < Beckton Neptune R2 K065  
 Beckton Belga K285 JL  
**BECKTON NEBULA P P707** < Beckton Epic K1 K863  
 Ref. N-2 < Beckton Lana M809 EP < Beckton Lana K253 DM  
 BWT **75**  
 WR **82**  
 ADG **4.44**  
 YWt. **1075**  
 YR **97**  
 Scr. **33**  
 Fr. **5.0**  
 Beckton Dominor ZC M919 < Beckton Dominor Z E401  
**BECKTON LARKABA R338 DM** < Beckton Barmaid J012 CO  
 Beckton Larkaba D170 JV < Beckton Javelin RN Z358  
 Beckton Larkaba Z257 ZN  
**DAM**  
 Age 9  
 Wt 1218  
 Prog.BW 73  
 WR 103  
 YR 102  
 Wean Pct. 35%  
 Cow Eff. 74  
 RAAA HerdBuilder index: **187** (Top 2% of all RA bulls)  
 RAAA GridMaster index: **53** (Top 10% of all RA bulls)  
 Calv.Ease BW WW YW Milk HPG Stay Maint.En.  
 EPDs **13 -4.6 43 74 22 12 16 -4.2**  
 Marb **+0.82** REA **-0.21** Bfat **-0.01**

★★★★★ for Low Maintenance, Gainability, Marbling, Calving Ease, Stayability.

**155** **BECKTON SCAMP B187 W4**   
 1-A 100% # 1705614 Tat.: BSF4 B187  
 Birth: 3-12-14  
 Beckton Scamp T A825 < Beckton Scamp 8954  
 Bkt Encino 8459 TJ  
**BECKTON SCAMP X494 E3** < Beckton Epic KH P678  
 Ref. S-1 < Beckton Lana S074 EP < Beckton Lana P317 JL  
 BWT **57**  
 WR **84**  
 ADG **3.71**  
 YWt. **1023**  
 YR **93**  
 Scr. **40**  
 Fr. **5.0**  
 Beckton Warrior T248 L5 < Beckton Warrior N645 T1  
**BECKTON MARTA X534 W** < Beckton Kit R503 LN  
 Beckton Marta S772 LO < Beckton Loki C M740  
 Beckton Marta C314 JL  
**DAM**  
 Age 4  
 Wt 910  
 Prog.BW 58  
 WR 89  
 YR 97  
 Wean Pct. 46%  
 Cow Eff. 98  
 RAAA HerdBuilder index: **169** (Top 6% of all RA bulls)  
 RAAA GridMaster index: **51** (Top 24% of all RA bulls)  
 Calv.Ease BW WW YW Milk HPG Stay Maint.En.  
 EPDs **11 -8.1 39 64 21 11 14 -9.8**  
 Marb **+0.34** REA **+0.07** Bfat **+0.01**

★★★★★ for Low Maintenance, Marbling, Calving Ease, Stayability.

**153** **BECKTON CLIFFTOP B678 L5**   
 1-A 100% # 1705840 Tat.: BKT4 B678  
 Birth: 4-9-14  
 Beckton Clifftop W692 E3 < BKT Clifftop TP R288  
 Beckton Lydia S274 EP  
**BECKTON CLIFFTOP Y012 C4** < BKT Clifftop TP R288  
 Ref. C-2 < Beckton Lana W240 C < Beckton Lana L923 CD  
 BWT **68**  
 WR **94**  
 ADG **3.99**  
 YWt. **1092**  
 YR **99**  
 Scr. **34**  
 Fr. **5.0**  
 Beckton Lancer T9 N586 < Beckton Lancer TA K644  
**BECKTON MONA S621 LN** < BKT Larkeisa H232 SC  
 Beckton Mona N444 HU < Beckton Hustler C2 L079  
 Beckton Mona L136 JL  
**DAM**  
 Age 8  
 Wt 1034  
 Prog.BW 61  
 WR 93  
 YR 96  
 Wean Pct. 48%  
 Cow Eff. 100  
 RAAA HerdBuilder index: **183** (Top 3% of all RA bulls)  
 RAAA GridMaster index: **51** (Top 24% of all RA bulls)  
 Calv.Ease BW WW YW Milk HPG Stay Maint.En.  
 EPDs **13 -6.2 45 71 19 11 15 -9.1**  
 Marb **+0.38** REA **-0.02** Bfat **+0.00**

★★★★★ for Low Maintenance, Marbling, Calving Ease, Stayability.



• Bulls •

**156 BECKTON CLIFFTOP B122 J5**  
1-A 100% # 1706156 Tat.: BKT4 B122



Birth: 3-3-14

Beckton Clifftop W577 E3  
**BECKTON CLIFFTOP Z824 C4**  
 Ref. C-3  
 Beckton Tamara R175 CQ

Beckton Julian X465 J5  
**BECKTON SCARLETT Z076 J**  
 Beckton Scarlett X414 H

BKT Clifftop TP R288  
 BKT Pine Marie R213 EP  
 Beckton Cherokee N N479  
 Beckton Tamara N765 CO  
 Beckton Julian G5 S107  
 Beckton Suffeina P643 JL  
 Beckton Heritage T270 J2  
 Beckton Scarlett R808 NB

BWt	65
WR	104
ADG	3.82
YWt	1056
YR	102
Scr.	36
Fr.	5.5

DAM	
Age	2
Wt	744
Prog.BW	65
WR	104
YR	102
Wean Pct.	57%
Cow Eff.	119

RAAA HerdBuilder index: **194** (Top 2% of all RA bulls)  
 RAAA GridMaster index: **53** (Top 5% of all RA bulls)

Calv.Ease	BW	WW	YW	Milk	HPG	Stay	Maint.En.	
EPDs	9	-3.6	48	78	25	12	18	-6.5

Marb **+0.71** REA **+0.02** Bfat **+0.05**

**159 BECKTON LEGEND B331 A3**  
1-A 100% # 1706314 Tat.: BKB4 B331



Birth: 3-22-14

Beckton Legend S670  
**BECKTON LEGEND U331 E2**  
 Ref. L  
 Beckton Lana S669 EP

Beckton Accent U777 C2  
**BECKTON INDIGO Y204 A**  
 Beckton Indigo U004 NB

Beckton Lancer F442 T  
 Beckton Kit F468 JL  
 Beckton Epic K4 N795  
 Beckton Lana M597 LO  
 Beckton Cody K1 P014  
 Beckton Susan R022 CQ  
 Beckton Nebula G S237  
 Beckton Indigo S354 JT

BWt	59
WR	94
ADG	3.54
YWt	1056
YR	97
Scr.	34
Fr.	5.5

DAM	
Age	3
Wt	790
Prog.BW	51
WR	95
YR	97
Wean Pct.	55%
Cow Eff.	116

RAAA HerdBuilder index: **178** (Top 4% of all RA bulls)  
 RAAA GridMaster index: **54** (Top 2% of all RA bulls)

Calv.Ease	BW	WW	YW	Milk	HPG	Stay	Maint.En.	
EPDs	14	-7.7	41	67	20	6	15	-7.6

Marb **+0.83** REA **+0.10** Bfat **+0.03**

★★★★★ for Low Maintenance, Marbling, High Cow Efficiency, Calving Ease, Stayability.

★★★★★ for Low Maintenance, Marbling, High Cow Efficiency, Calving Ease, Stayability.

**157 BECKTON NEBULA B435 A3**  
1-A 100% # 1706086 Tat.: BKT4 B435



Birth: 3-26-14

Beckton Nebula M045  
**BECKTON NEBULA P P707**  
 Ref. N-2  
 Beckton Lana M809 EP

Beckton Accent W180 C2  
**BECKTON LAKME Y027 A**  
 Beckton Lakme W267 L

Beckton Neptune R2 K065  
 Beckton Belga K285 JL  
 Beckton Epic K1 K863  
 Beckton Lana K253 DM  
 Beckton Cody K1 P014  
 Beckton Christy R046 CQ  
 Beckton Loki CL S284  
 Beckton Lakme M669 EP

BWt	65
WR	97
ADG	3.88
YWt	1070
YR	98
Scr.	37
Fr.	5.0

DAM	
Age	3
Wt	978
Prog.BW	65
WR	97
YR	98
Wean Pct.	46%
Cow Eff.	98

RAAA HerdBuilder index: **198** (Top 1% of all RA bulls)  
 RAAA GridMaster index: **55** (Top 2% of all RA bulls)

Calv.Ease	BW	WW	YW	Milk	HPG	Stay	Maint.En.	
EPDs	14	-5.4	59	98	19	10	17	-2.7

Marb **+0.73** REA **-0.09** Bfat **+0.03**

★★★★★ for Low Maintenance, Marbling, Calving Ease, Stayability.

**160 BECKTON NEBULA B67 H4**  
1-A 100% # 1705945 Tat.: BKT4 B667



Birth: 4-9-14

Beckton Nebula L P093  
**BECKTON NEBULA W486 D3**  
 Ref. N-4  
 Beckton Belga R716 DM

Beckton Heritage T270 J2  
**BECKTON ROSE W063 H**  
 Beckton Rose T297 JR

Beckton Nebula M045  
 Beckton Marta M021 LN  
 Beckton Dominor ZC M919  
 Beckton Belga K285 JL  
 Beckton Heritage N013  
 Beckton Coca P602 JL  
 Beckton Jupiter R478  
 Beckton Rose R185 LS

BWt	63
WR	94
ADG	3.54
YWt	1032
YR	93
Scr.	34
Fr.	5.5

DAM	
Age	5
Wt	978
Prog.BW	59
WR	94
YR	99
Wean Pct.	51%
Cow Eff.	107

RAAA HerdBuilder index: **198** (Top 1% of all RA bulls)  
 RAAA GridMaster index: **54** (Top 4% of all RA bulls)

Calv.Ease	BW	WW	YW	Milk	HPG	Stay	Maint.En.	
EPDs	13	-7.1	51	80	18	11	17	-2.4

Marb **+0.56** REA **+0.01** Bfat **+0.02**

★★★★★ for Low Maintenance, Marbling, Calving Ease, Stayability.

**158 BECKTON CLIFFTOP B092 N5**  
1-A 100% # 1706280 Tat.: BKT4 B092



Birth: 2-26-14

Beckton Clifftop W577 E3  
**BECKTON CLIFFTOP Z824 C4**  
 Ref. C-3  
 Beckton Tamara R175 CQ

Beckton Nebula T269 E2  
**BECKTON LANA Z832 N**  
 Beckton Lana W113 N

BKT Clifftop TP R288  
 BKT Pine Marie R213 EP  
 Beckton Cherokee N N479  
 Beckton Tamara N765 CO  
 Beckton Nebula M045  
 Beckton Ruth M967 EP  
 Beckton Nebula T252 L3  
 Beckton Lana T226 NB

BWt	67
WR	97
ADG	3.60
YWt	1035
YR	100
Scr.	33
Fr.	5.0

DAM	
Age	2
Wt	754
Prog.BW	67
WR	97
YR	100
Wean Pct.	51%
Cow Eff.	108

RAAA HerdBuilder index: **199** (Top 1% of all RA bulls)  
 RAAA GridMaster index: **52** (Top 22% of all RA bulls)

Calv.Ease	BW	WW	YW	Milk	HPG	Stay	Maint.En.	
EPDs	9	-3.4	45	75	24	11	19	-6.1

Marb **+0.52** REA **+0.21** Bfat **+0.04**

★★★★★ for Low Maintenance, Marbling, Rib-eye area, Calving Ease, Stayability.

**161 BECKTON SCAMP B607 N4**  
1-A 100% # 1706108 Tat.: BKT4 B607



Birth: 4-4-14

Beckton Scamp T A825  
**BECKTON SCAMP X494 E3**  
 Ref. S-1  
 Beckton Lana S074 EP

Beckton Nebula P P707  
**BECKTON BELGA Y254 N**  
 Beckton Belga S747 EP

Beckton Scamp 8954  
 Bkt Encino 8459 TJ  
 Beckton Epic KH P678  
 Beckton Lana P317 JL  
 Beckton Nebula M045  
 Beckton Lana M809 EP  
 Beckton Epic K3 M606  
 Beckton Belga K202 LN

BWt	68
WR	96
ADG	3.65
YWt	1060
YR	97
Scr.	38
Fr.	5.0

DAM	
Age	3
Wt	834
Prog.BW	61
WR	102
YR	97
Wean Pct.	54%
Cow Eff.	114

RAAA HerdBuilder index: **175** (Top 4% of all RA bulls)  
 RAAA GridMaster index: **51** (Top 25% of all RA bulls)

Calv.Ease	BW	WW	YW	Milk	HPG	Stay	Maint.En.	
EPDs	13	-5.0	48	79	24	10	15	-6.3

Marb **+0.43** REA **-0.08** Bfat **-0.01**

★★★★★ for Low Maintenance, Marbling, Calving Ease, Stayability.

• Bulls •

**162** BECKTON ACCENT B273 H3  
1-A 100% # 1706175 Tat.: BKT4 B273



Birth: 3-19-14

Beckton Accent W180 C2  
Beckton Cody K1 P014  
Beckton Christy R046 CQ  
Beckton Kit S478 LN

**BECKTON ACCENT Z506 J3**  
Ref. A-5  
Beckton Susan P857 JO  
Beckton Lasso P741  
Beckton Julio L233  
BKT Pine Marie S802 LO  
Beckton Susan G199 CO  
BKT Pine Marie P475 LN

Beckton Heritage X403 L3  
Beckton Nebula U206 V3  
Beckton Heritago T270 J2  
Beckton Nebula P P707  
Beckton Indigo H150 LN  
Beckton Minerva J615 VG

**BECKTON MINOLA Z185 H**  
Beckton Minola W064 N  
Beckton Nebula T054 H3  
Beckton Julian GG B571  
Beckton Minola T675 JC  
Beckton Christy A111 VQ

BWT	77
WR	104
ADG	3.93
YWT	1077
YR	104
Scr.	30
Fr.	5.5

**DAM**  
Age 2  
Wt 922  
Prog.BW 77  
WR 104  
YR 104  
Wean Pct. 45%  
Cow Eff. 96

RAAA HerdBuilder index: **169** (Top 6% of all RA bulls)  
RAAA GridMaster index: **53** (Top 8% of all RA bulls)

Calv.Ease	BW	WW	YW	Milk	HPG	Stay	Maint.En.	
EPDs	10	-0.9	70	108	21	9	15	-3.4

Marb **+0.53** REA **+1.10** Bfat **+0.05**

**164** BECKTON LIKABLE B706 N4  
1-A 100% # 1705676 Tat.: BSF4 B706



Birth: 4-12-14

Beckton Likable U130 L2  
Beckton Kit S478 LN  
Beckton Lasso P741  
Beckton Julio L233  
BKT Pine Marie S802 LO  
Beckton Susan G199 CO  
BKT Pine Marie P475 LN

**BECKTON LIKABLE Y124 L3**  
Ref. L-3

Beckton Nebula U206 V3  
Beckton Heritago T270 J2  
Beckton Nebula P P707  
Beckton Indigo H150 LN  
Beckton Minerva J615 VG

**BECKTON CHRISTY Y686 N**  
Beckton Christy J743 JL  
Beckton Julian GG B571  
Beckton Christy A111 VQ

BWT	68
WR	106
ADG	3.88
YWT	1121
YR	103
Scr.	40
Fr.	5.5

**DAM**  
Age 3  
Wt 912  
Prog.BW 62  
WR 105  
YR 103  
Wean Pct. 55%  
Cow Eff. 115

RAAA HerdBuilder index: **177** (Top 4% of all RA bulls)  
RAAA GridMaster index: **52** (Top 17% of all RA bulls)

Calv.Ease	BW	WW	YW	Milk	HPG	Stay	Maint.En.	
EPDs	12	-4.1	52	84	22	11	16	-2.5

Marb **+0.57** REA **+1.18** Bfat **+0.03**

★★★★★ for Low Maintenance, Marbling, Superior Cow, Calving Ease, Stayability.

★★★★★ for Low Maintenance, Marbling, Rib-eye area, Superior Cow, Calving Ease, Stayability.



Lot 163

**165** BECKTON SCAMP B087 W5  
1-A 100% # 1706221 Tat.: BKT4 B087



Birth: 2-26-14

Beckton Scamp X458 H3  
Beckton Scamp T A825  
Beckton Lancer F442 T  
Beckton Kit S478 LN  
**BECKTON SCAMP Z460 L4**  
Ref. S-2  
Beckton Belga W405 L  
Beckton Belga K285 JL  
Beckton Warrior T248 L5  
Beckton Warrior X547 N6  
Beckton Eola S011 NB  
**BKT PINE MARIE Z435 W**  
Beckton Epic D404  
BKT Pine Marie W625 E  
BKT Pine Marie J556 EP

BWT	61
WR	96
ADG	4.33
YWT	1054
YR	102
Scr.	32
Fr.	5.5

**DAM**  
Age 2  
Wt 858  
Prog.BW 61  
WR 96  
YR 102  
Wean Pct. 45%  
Cow Eff. 94

RAAA HerdBuilder index: **177** (Top 4% of all RA bulls)  
RAAA GridMaster index: **51** (Top 27% of all RA bulls)

Calv.Ease	BW	WW	YW	Milk	HPG	Stay	Maint.En.	
EPDs	10	-5.0	52	84	16	8	14.3	-9.3

Marb **+0.38** REA **+1.13** Bfat **+0.01**

★★★★★ for Low Maintenance, Gainability, Marbling, Rib-eye area, Calving Ease, Stayability.

**163** BECKTON EPIC B578 C6  
1-A 100% # 1705571 Tat.: BSF4 B578



Birth: 4-2-14

Beckton Epic K4 N795  
Beckton Epic KJ J722  
Beckton Sierra J789 EP  
**BECKTON EPIC U749 D5**  
Ref. E-1  
Beckton Denise R308 DM  
Beckton Dominor ZC M919  
Beckton Denise L639 JL  
BKT Clifftop TP R288  
Beckton Larkabel N769 HR

Beckton Clifftop U575 H3  
Beckton Larkabel N769 HR  
Beckton Clifftop T3 N800  
**BECKTON SIERRA X018 C**  
Beckton Sierra U462 CT  
Beckton Sierra R144 NW

BWT	79
WR	93
ADG	3.82
YWT	1087
YR	98
Scr.	33
Fr.	5.0

**DAM**  
Age 4  
Wt 970  
Prog.BW 65  
WR 97  
YR 99  
Wean Pct. 48%  
Cow Eff. 101

RAAA HerdBuilder index: **132** (Top 28% of all RA bulls)  
RAAA GridMaster index: **50** (Top 49% of all RA bulls)

Calv.Ease	BW	WW	YW	Milk	HPG	Stay	Maint.En.	
EPDs	10	-2.4	47	86	20	7	14	2.9

Marb **+0.57** REA **+0.30** Bfat **+0.04**

★★★★★ for Low Maintenance, Marbling, Rib-eye area, Calving Ease, Stayability.

**166** BECKTON LOKI B535 C5  
1-A 100% # 1705562 Tat.: BSF4 B535



Birth: 3-30-14

Beckton Loki CL S284  
Beckton Loki C M740  
Beckton Lakme J460 LT  
**BECKTON LOKI X507 L4**  
Ref. L  
Beckton Lana L538 LN  
Beckton Lancer TL G626  
Beckton Lana G514 CD  
Beckton Cody KH M390  
Beckton Rose M126 WR

Beckton Cody K1 P014  
Beckton Rose M126 WR  
**BECKTON INDIGO W866 A**  
Beckton Indigo D780 JL  
Beckton Julian GN 9A45  
Beckton Indigo Z193 DM

BWT	71
WR	110
ADG	3.41
YWT	1047
YR	95
Scr.	36
Fr.	5.0

**DAM**  
Age 5  
Wt 1136  
Prog.BW 68  
WR 112  
YR 105  
Wean Pct. 51%  
Cow Eff. 107

RAAA HerdBuilder index: **146** (Top 17% of all RA bulls)  
RAAA GridMaster index: **50** (Top 44% of all RA bulls)

Calv.Ease	BW	WW	YW	Milk	HPG	Stay	Maint.En.	
EPDs	12	-5.0	41	67	27	9	14	-2.8

Marb **+0.46** REA **+0.09** Bfat **-0.01**

★★★★★ for Low Maintenance, Marbling, Superior Cow, Calving Ease, Stayability.

• Bulls •

**167 BECKTON CARDINAL B123 J**  
 1-A 100% # 1705772 Tat.: BSF4 B123



Birth: 3-3-14

TR Ricardo DOS  
**TR DOUBLE EAGLE ZT220**  
 Ref. C-4 Beckton Lana U182 JC

Beckton Julian U699 L5  
**BECKTON MINOLA Z796 J**  
 Beckton Minola K527 CO

BFCK Cherokee Cryn 4912  
 TR Dyna LT111  
 Beckton Justice C1 R483  
 Beckton Lana H544 WR  
 Beckton Julian G1 J526  
 Beckton Rose L311 LN  
 Beckton Copper JT G095  
 Beckton Minola F003 CR

BWt	55
WR	121
ADG	3.64
YWt.	1104
YR	106
Scr.	35
Fr.	4.5

DAM									
Age	2								
Wt	724								
Prog.BW	55								
WR	121								
YR	106								
Wean Pct.	69%								
Cow Eff.	144								

RAAA HerdBuilder index: **183** (Top 3% of all RA bulls)  
 RAAA GridMaster index: **53** (Top 6% of all RA bulls)

Calv.Ease	BW	WW	YW	Milk	HPG	Stay	Maint.En.	
EPDs	12	-6.3	54	80	23	12	15	-10.6
Marb	+.45		REA	+.02		Bfat		+.02



★★★★★ for Low Maintenance, Growth, Marbling, Superior Cow, High Cow Efficiency, Calving Ease, Stayability.

**168 BECKTON EPIC B438 L6**  
 1-A 100% # 1705817 Tat.: BKT4 B438



Birth: 3-26-14

Beckton Epic K4 N795  
**BECKTON EPIC U749 D5**  
 Ref. E-1 Beckton Denise R308 DM

Beckton Lancer F442 T  
**BECKTON KIT R441 LN**  
 Beckton Kit F468 JL

Beckton Epic KJ J722  
 Beckton Sierra J789 EP  
 Beckton Dominor ZC M919  
 Beckton Denise L639 JL  
 Beckton Lancer T A664  
 Bkt Suffeina A828 DM  
 Beckton Julian GG B571  
 Beckton Kit A517 NP

BWt	74
WR	103
ADG	3.64
YWt.	1092
YR	99
Scr.	36
Fr.	5.0

DAM									
Age	9								
Wt	1090								
Prog.BW	67								
WR	101								
YR	95								
Wean Pct.	50%								
Cow Eff.	104								

RAAA HerdBuilder index: **132** (Top 28% of all RA bulls)  
 RAAA GridMaster index: **50** (Top 56% of all RA bulls)

Calv.Ease	BW	WW	YW	Milk	HPG	Stay	Maint.En.	
EPDs	10	-3.6	49	81	18	6	13	-2.3
Marb	+.49		REA	+.44		Bfat		+.00

★★★★★ for Low Maintenance, Marbling, Rib-eye area, Calving Ease, Stayability.

**170 BECKTON NEW ERA B291 L2**  
 1-A 100% # 1705894 Tat.: BKT4 B291



Birth: 3-19-14

Beckton Nebula P P707  
**BECKTON NEW ERA Y194**  
 Ref. N-6 BKT Larkeisa T310 JC

Beckton Legend S670  
**BECKTON LARKABA U153 LE**  
 Beckton Larkaba S299 EP

Beckton Nebula M045  
 Beckton Lana M809 EP  
 Beckton Justice C1 R483  
 BKT Larkeisa R775 JC  
 Beckton Lancer F442 T  
 Beckton Kit F468 JL  
 Beckton Epic K4 N795  
 Beckton Larkaba D170 JV

BWt	71
WR	95
ADG	3.86
YWt.	1049
YR	95
Scr.	32
Fr.	4.5

DAM									
Age	6								
Wt	1078								
Prog.BW	65								
WR	96								
YR	98								
Wean Pct.	49%								
Cow Eff.	104								

RAAA HerdBuilder index: **171** (Top 6% of all RA bulls)  
 RAAA GridMaster index: **54** (Top 3% of all RA bulls)

Calv.Ease	BW	WW	YW	Milk	HPG	Stay	Maint.En.	
EPDs	9	-4.1	59	97	18	8	14	-8.3
Marb	+.70		REA	+.06		Bfat		+.03

★★★★★ for Low Maintenance, Marbling, Calving Ease, Stayability.

**169 BECKTON JULIAN B365 N4**  
 1-A 100% # 1705955 Tat.: BKT4 B365



Birth: 3-24-14

Beckton Julian 7526G  
**BECKTON JULIAN GG B571**  
 Ref. J-1 Bkt Marta 9A13 JL

Beckton Nebula T398 V3  
**BECKTON INDIGO W165 N**  
 Beckton Indigo T298 JM

Beckton Julian 6592  
 Bkt Belga 6746 GS  
 Beckton Julian 7526G  
 Bkt Marta 6498 XM  
 Beckton Nebula L P093  
 Beckton Minerva J615 VG  
 Beckton Jerome E N786  
 Beckton Indigo P078 NP

BWt	68
WR	103
ADG	3.41
YWt.	1089
YR	99
Scr.	37
Fr.	4.5

DAM									
Age	5								
Wt	1206								
Prog.BW	65								
WR	98								
YR	100								
Wean Pct.	45%								
Cow Eff.	94								

RAAA HerdBuilder index: **193** (Top 2% of all RA bulls)  
 RAAA GridMaster index: **53** (Top 10% of all RA bulls)

Calv.Ease	BW	WW	YW	Milk	HPG	Stay	Maint.En.	
EPDs	16	-6.3	49	76	22	10	16	-2.0
Marb	+.53		REA	+.14		Bfat		+.02

★★★★★ for Low Maintenance, Marbling, Rib-eye area, Calving Ease, Stayability.

**171 BECKTON DOMINOR B407 C6**  
 1-A 100% # 1705499 Tat.: BSF4 B407



Birth: 3-25-14

Beckton Dominor Z1 R610  
**BECKTON DOMINOR W640 C5**  
 Ref. D-1 Beckton Mona R166 CQ

BKT Clifftop TP R288  
**BECKTON LANA U386 CT**  
 Beckton Lana P026 DM

Beckton Dominor ZC M919  
 Beckton Sierra K557 LO  
 Beckton Cherokee N N479  
 Beckton Mona N342 HU  
 Beckton Clifftop T C075  
 Beckton Christy K209 CO  
 Beckton Dominor ZC M919  
 Beckton Lana M552 WR

BWt	70
WR	98
ADG	2.96
YWt.	1040
YR	94
Scr.	34
Fr.	5.0

DAM									
Age	6								
Wt	1002								
Prog.BW	64								
WR	98								
YR	98								
Wean Pct.	54%								
Cow Eff.	115								

RAAA HerdBuilder index: **178** (Top 4% of all RA bulls)  
 RAAA GridMaster index: **52** (Top 14% of all RA bulls)

Calv.Ease	BW	WW	YW	Milk	HPG	Stay	Maint.En.	
EPDs	13	-5.9	40	65	25	12	15	-5.2
Marb	+.58		REA	+.02		Bfat		+.04

★★★★★ for Low Maintenance, Marbling, Calving Ease, Stayability.



• Bulls •

**172 BECKTON RANGER B047 E5**  
1-A 100% # 1705728 Tat.: BSF4 B047



Birth: 2-19-14

Beckton Ranger T603 H3  
Beckton Ranger 9479R  
Beckton Rose N044 HU  
Beckton Jet L P491  
Beckton Mona P874 WR  
Beckton Epic X816 C6  
Beckton Epic T330 L5  
Beckton Mona R198 CQ  
Beckton Heritage T270 J2  
Beckton Lana R241 JC

**BECKTON RANGER Z225 J4**  
Ref. R-1  
Beckton Mona U564 JT

**BECKTON LANA Z291 E**  
Beckton Lana X158 H

BWt	58
WR	95
ADG	4.21
YWt	1069
YR	103
Scr.	31
Fr.	5.0

DAM	
Age	2
Wt	766
Prog.BW	58
WR	95
YR	103
Wean Pct.	50%
Cow Eff.	106

RAAA HerdBuilder index: **159** (Top 9% of all RA bulls)  
RAAA GridMaster index: **53** (Top 4% of all RA bulls)

Calv.Ease	BW	WW	YW	Milk	HPG	Stay	Maint.En.
EPDs	12	-5.8	50	80	21	12	-6.5

Marb **+0.60** REA **-0.03** Bfat **+0.4**

★★★★★ for Low Maintenance, Gainability, Marbling, Calving Ease.

**174 BECKTON EPIC B502 D7**  
1-A 100% # 1706003 Tat.: BKT4 B502



Birth: 3-28-14

Beckton Epic T330 L5  
Beckton Epic K4 N795  
Beckton Belga K202 LN  
Beckton Cherokee N N479  
Beckton Mona N009 JE  
Beckton Dominor ZC M919  
Beckton Sierra K557 LO  
Beckton Dominor Z1 R610  
Beckton Lancer T7 M089  
Beckton Vernice R374 LN  
Beckton Vernice K798 CD

**BECKTON EPIC X816 C6**  
Ref. E-4  
Beckton Mona R198 CQ

**BECKTON VERNICE W780 D**

BWt	80
WR	99
ADG	3.69
YWt	1005
YR	91
Scr.	42
Fr.	5.0

DAM	
Age	5
Wt	1270
Prog.BW	69
WR	99
YR	97
Wean Pct.	43%
Cow Eff.	91

RAAA HerdBuilder index: **144** (Top 18% of all RA bulls)  
RAAA GridMaster index: **51** (Top 26% of all RA bulls)

Calv.Ease	BW	WW	YW	Milk	HPG	Stay	Maint.En.
EPDs	9	-2.0	55	92	24	12	14

Marb **+0.56** REA **-0.01** Bfat **+0.02**

★★★★★ for Low Maintenance, Marbling, Calving Ease, Stayability.

**173 BECKTON LEGEND B527 H2**  
1-A 100% # 1705935 Tat.: BKT4 B527



Birth: 3-29-14

Beckton Lancer F442 T  
Beckton Lancer T A664  
Bkt Suffeina A828 DM  
Beckton Julian GG B571  
Beckton Kit A517 NP  
Beckton Heritage T270 J2  
Beckton Heritage N013  
Beckton Coca P602 JL  
Beckton Justice CH M056  
Beckton Lana G730 JL

**BECKTON LEGEND S670**  
Ref. L-1  
Beckton Kit F468 JL

**BECKTON LANA W019 H**  
Beckton Lana T699 JC

BWt	77
WR	100
ADG	3.07
YWt	1007
YR	91
Scr.	34
Fr.	5.0

DAM	
Age	5
Wt	1110
Prog.BW	69
WR	105
YR	102
Wean Pct.	50%
Cow Eff.	106

RAAA HerdBuilder index: **188** (Top 2% of all RA bulls)  
RAAA GridMaster index: **53** (Top 9% of all RA bulls)

Calv.Ease	BW	WW	YW	Milk	HPG	Stay	Maint.En.
EPDs	12	-3.9	54	74	16	9	-9.5

Marb **+0.73** REA **+0.26** Bfat **+0.01**

★★★★★ for Low Maintenance, Marbling, Rib-eye area, Calving Ease, Stayability.

**175 BECKTON RANGER B040 N5**  
1-A 100% # 1706203 Tat.: BKT4 B040



Birth: 2-19-14

Beckton Ranger T603 H3  
Beckton Ranger 9479R  
Beckton Rose N044 HU  
Beckton Jet L P491  
Beckton Mona P874 WR  
Beckton Nebula M045  
Beckton Ruth M967 EP  
Beckton Laramie L044  
Beckton Ruth L277 VG

**BECKTON RANGER Z225 J4**  
Ref. R-1  
Beckton Mona U564 JT

**BECKTON RUTH Z337 N**  
Beckton Ruth N010 LM

BWt	63
WR	110
ADG	3.47
YWt	1008
YR	97
Scr.	32
Fr.	5.0

DAM	
Age	2
Wt	1026
Prog.BW	63
WR	110
YR	97
Wean Pct.	47%
Cow Eff.	100

RAAA HerdBuilder index: **154** (Top 12% of all RA bulls)  
RAAA GridMaster index: **52** (Top 12% of all RA bulls)

Calv.Ease	BW	WW	YW	Milk	HPG	Stay	Maint.En.
EPDs	9	-3.6	57	92	22	12	13

Marb **+0.47** REA **-0.02** Bfat **+0.03**

★★★★★ for Low Maintenance, Marbling, Calving Ease, Stayability.



**176 BECKTON CLIFFTOP B242 J4**  
1-A 100% # 1705465 Tat.: BSF4 B242



Birth: 3-17-14

BKT Clifftop TP R288  
Beckton Clifftop T C075  
Beckton Christy K209 CO  
Beckton Epic KM M115  
Beckton Lydia M607 LO  
TR Julian LT151  
Beckton Minerva L278 LN  
Beckton Herald FV J537  
Beckton Encino G341 NP

**BECKTON CLIFFTOP W692 E3**  
Ref. C-1  
Beckton Lydia S274 EP

**BECKTON ENCINO S059 JT**  
Beckton Jet L P491  
Beckton Encino P871 HR

BWt	65
WR	102
ADG	2.61
YWt	961
YR	87
Scr.	35
Fr.	4.5

DAM	
Age	8
Wt	1178
Prog.BW	66
WR	105
YR	96
Wean Pct.	48%
Cow Eff.	102

RAAA HerdBuilder index: **179** (Top 4% of all RA bulls)  
RAAA GridMaster index: **53** (Top 5% of all RA bulls)

Calv.Ease	BW	WW	YW	Milk	HPG	Stay	Maint.En.
EPDs	13	-7.3	40	68	30	10	-2.3

Marb **+0.61** REA **-0.01** Bfat **+0.03**

★★★★★ for Low Maintenance, Marbling, Calving Ease, Stayability.

• Bulls •



**179** BECKTON DOMINOR B453 J6  
1-A 100% # 1705927 Tat.: BKT4 B453



Birth: 3-27-14

Beckton Dominor Z1 R610	Beckton Dominor ZC M919	BWT <b>79</b>
Beckton Sierra K557 LO	Beckton Sierra K557 LO	
<b>BECKTON DOMINOR W640 C5</b>	Beckton Cherokee N N479	ADG <b>3.69</b>
Ref. D-1	Beckton Mona R166 CQ	Ywt. <b>1091</b>
	Beckton Mona N342 HU	YR <b>99</b>
	Beckton Julian G3 P608	Scr. <b>32</b>
<b>BECKTON EOLA U689 JL</b>	Bkt Suffeina A828 DM	Fr. <b>5.0</b>
	Beckton Lancer T4 J536	
	Beckton Eola N491 LN	
	Beckton Eola C611 SC	

<b>DAM</b>	
Age <b>6</b>	
Wt <b>1124</b>	
Prog. BW <b>70</b>	
WR <b>105</b>	
YR <b>102</b>	
Wean Pct. <b>50%</b>	
Cow Eff. <b>105</b>	

RAAA HerdBuilder index: **173** (Top 5% of all RA bulls)  
RAAA GridMaster index: **52** (Top 14% of all RA bulls)

Calv. Ease	BW	WW	YW	Milk	HPG	Stay	Maint. En.
EPDs <b>13</b>	<b>-4.1</b>	<b>46</b>	<b>72</b>	<b>23</b>	<b>13</b>	<b>15</b>	<b>-3.1</b>
Marb <b>+0.65</b>	REA <b>-0.05</b>	Bfat <b>+0.03</b>					

★★★★★ for Low Maintenance, Marbling, Calving Ease, Stayability.

**177** BECKTON NEW ERA B244 W2  
1-A 100% # 1705907 Tat.: BKT4 B244



Birth: 3-17-14

Beckton Nebula P P707	Beckton Nebula M045	BWT <b>69</b>
Beckton Lana M809 EP	Beckton Lana M809 EP	
<b>BECKTON NEW ERA Y194</b>	Beckton Justice C1 R483	ADG <b>3.24</b>
Ref. N-6	BKT Larkeisa T310 JC	Ywt. <b>1013</b>
	BKT Larkeisa R775 JC	YR <b>92</b>
	Beckton Warrior T1 H281	Scr. <b>29</b>
	Beckton Rose H074 EP	Fr. <b>5.0</b>
	Beckton Laser N602	
	Beckton Annie R523 LS	
	Beckton Annie N794 JO	

<b>DAM</b>	
Age <b>6</b>	
Wt <b>1066</b>	
Prog. BW <b>68</b>	
WR <b>101</b>	
YR <b>100</b>	
Wean Pct. <b>55%</b>	
Cow Eff. <b>115</b>	

RAAA HerdBuilder index: **173** (Top 5% of all RA bulls)  
RAAA GridMaster index: **54** (Top 4% of all RA bulls)

Calv. Ease	BW	WW	YW	Milk	HPG	Stay	Maint. En.
EPDs <b>12</b>	<b>-5.4</b>	<b>60</b>	<b>99</b>	<b>18</b>	<b>12</b>	<b>13</b>	<b>-3.8</b>
Marb <b>+0.51</b>	REA <b>-0.16</b>	Bfat <b>+0.02</b>					

★★★★★ for Low Maintenance, Marbling, Calving Ease, Stayability.

**180** BECKTON EPIC B714 C6  
1-A 100% # 1705821 Tat.: BKT4 B714



Birth: 4-13-14

Beckton Epic K4 N795	Beckton Epic KJ J722	BWT <b>82</b>
Beckton Sierra J789 EP	Beckton Sierra J789 EP	
<b>BECKTON EPIC U749 D5</b>	Beckton Dominor ZC M919	ADG <b>2.39</b>
Ref. E-1	Beckton Denise R308 DM	Ywt. <b>1021</b>
	Beckton Denise L639 JL	YR <b>93</b>
	Beckton Cody K G701	Scr. <b>34</b>
	Beckton Tamara J124 HR	Fr. <b>5.5</b>
	Beckton Lancer F442 T	
	Beckton Coca K295 CO	

<b>DAM</b>	
Age <b>9</b>	
Wt <b>1242</b>	
Prog. BW <b>70</b>	
WR <b>96</b>	
YR <b>103</b>	
Wean Pct. <b>50%</b>	
Cow Eff. <b>106</b>	

RAAA HerdBuilder index: **117** (Top 45% of all RA bulls)  
RAAA GridMaster index: **50** (Top 56% of all RA bulls)

Calv. Ease	BW	WW	YW	Milk	HPG	Stay	Maint. En.
EPDs <b>10</b>	<b>-1.6</b>	<b>57</b>	<b>99</b>	<b>22</b>	<b>6</b>	<b>12</b>	<b>2.2</b>
Marb <b>+0.45</b>	REA <b>+0.30</b>	Bfat <b>+0.01</b>					

★★★★★ for Low Maintenance, Marbling, Rib-eye area, Calving Ease.

**178** BECKTON WARRIOR B796 H5  
1-A 100% # 1705552 Tat.: BSF4 B796



Birth: 4-23-14

Beckton Warrior C1 S337	Beckton Warrior CL M686	BWT <b>71</b>
Beckton Christy K101 CD	Beckton Christy K101 CD	
<b>BECKTON WARRIOR W534 N4</b>	Beckton Nebula P P707	ADG <b>3.58</b>
Ref. W	BKT Larkeisa S055 NB	Ywt. <b>1065</b>
	Beckton Larkeisa P688 CH	YR <b>96</b>
	Beckton Hasten P292	Scr. <b>36</b>
	Beckton Lakme G128 HD	Fr. <b>5.0</b>
	Beckton Jet L P491	
	Beckton Encino P300 LN	

<b>DAM</b>	
Age <b>5</b>	
Wt <b>1018</b>	
Prog. BW <b>66</b>	
WR <b>97</b>	
YR <b>97</b>	
Wean Pct. <b>51%</b>	
Cow Eff. <b>106</b>	

RAAA HerdBuilder index: **196** (Top 1% of all RA bulls)  
RAAA GridMaster index: **52** (Top 12% of all RA bulls)

Calv. Ease	BW	WW	YW	Milk	HPG	Stay	Maint. En.
EPDs <b>15</b>	<b>-5.6</b>	<b>42</b>	<b>66</b>	<b>24</b>	<b>12</b>	<b>16</b>	<b>-10.1</b>
Marb <b>+0.58</b>	REA <b>+0.09</b>	Bfat <b>+0.04</b>					

★★★★★ for Low Maintenance, Marbling, Calving Ease, Stayability.

**181** BECKTON NEBULA B523 D3  
1-A 100% # 1706037 Tat.: BKT4 B523



Birth: 3-29-14

Beckton Nebula M045	Beckton Neptune R2 K065	BWT <b>72</b>
Beckton Belga K285 JL	Beckton Belga K285 JL	
<b>BECKTON NEBULA P P707</b>	Beckton Epic K1 K863	ADG <b>4.09</b>
Ref. N-2	Beckton Lana M809 EP	Ywt. <b>1139</b>
	Beckton Lana K253 DM	YR <b>103</b>
	Beckton Dominor ZC M919	Scr. <b>36</b>
	Beckton Sierra K557 LO	Fr. <b>4.5</b>
	Beckton Laser N602	
	Beckton Firefly N562 VG	

<b>DAM</b>	
Age <b>4</b>	
Wt <b>1208</b>	
Prog. BW <b>74</b>	
WR <b>104</b>	
YR <b>106</b>	
Wean Pct. <b>42%</b>	
Cow Eff. <b>89</b>	

RAAA HerdBuilder index: **178** (Top 4% of all RA bulls)  
RAAA GridMaster index: **54** (Top 3% of all RA bulls)

Calv. Ease	BW	WW	YW	Milk	HPG	Stay	Maint. En.
EPDs <b>13</b>	<b>-4.6</b>	<b>54</b>	<b>90</b>	<b>20</b>	<b>11</b>	<b>15</b>	<b>-0.9</b>
Marb <b>+0.73</b>	REA <b>-0.24</b>	Bfat <b>+0.03</b>					

★★★★★ for Low Maintenance, Gainability, Marbling, Superior Cow, Calving Ease, Stayability.

• Bulls •

**182 BECKTON LEGEND B655 C2**  
1-A 100% # 1705445 Tat.: BSF4 B655



Birth: 4-8-14

Beckton Lancer F442 T  
Beckton Lancer T A664  
Bkt Suffeina A828 DM

**BECKTON LEGEND S670**  
Ref. L-1  
Beckton Kit F468 JL  
Beckton Julian GG B571  
Beckton Kit A517 NP

Beckton Champ R1 H024  
Beckton Champ RH F275  
Beckton Lana F138 LN

**BECKTON CHRISTY P333 CH**  
Beckton Christy K209 CO  
Beckton Copper JT G095  
Beckton Christy A111 VQ

BWt	65
WR	97
ADG	3.81
YWt	1052
YR	95
Scr.	34
Fr.	5.0

DAM  
Age 10  
Wt 958  
Prog.BW 57  
WR 103  
YR 100  
Wean Pct. 53%  
Cow Eff. 112

RAAA HerdBuilder index: **197** (Top 1% of all RA bulls)  
RAAA GridMaster index: **51** (Top 28% of all RA bulls)

Calv.Ease	BW	WW	YW	Milk	HPG	Stay	Maint.En.	
EPDs	12	-6.6	36	52	21	10	18	-13.3
Marb	+.59		REA	+.38		Bfat		+.01

**184 BECKTON NEBULA B789 J5**  
1-A 100% # 1705972 Tat.: BKT4 B789



Birth: 4-22-14

Beckton Nebula U206 V3  
Beckton Nebula P P707  
Beckton Minerva J615 VG

**BECKTON NEBULA X096 N4**  
Ref. N-5  
Beckton Tamara U185 NB  
Beckton Nebula P P707  
Beckton Tamara P813 CH

Beckton Jet L P491  
TR Julian LT151  
Beckton Minerva L278 LN

**BKT PINE MARIE W404 J**  
BKT Pine Marie R056 CQ  
Beckton Cherokee N N479  
BKT Pine Marie N783 CO

BWt	73
WR	105
ADG	3.64
YWt	1132
YR	103
Scr.	39
Fr.	4.5

DAM  
Age 5  
Wt 910  
Prog.BW 75  
WR 108  
YR 103  
Wean Pct. 61%  
Cow Eff. 128

RAAA HerdBuilder index: **197** (Top 1% of all RA bulls)  
RAAA GridMaster index: **52** (Top 13% of all RA bulls)

Calv.Ease	BW	WW	YW	Milk	HPG	Stay	Maint.En.	
EPDs	12	-5.0	50	81	26	11	19	-2.5
Marb	+.65		REA	+.09		Bfat		-.01

★★★★★ for Low Maintenance, Marbling, Rib-eye area, Calving Ease, Stayability.

★★★★★ for Low Maintenance, Marbling, High Cow Efficiency, Calving Ease, Stayability.

**183 BECKTON ACCENT B337 N3**  
1-A 100% # 1706115 Tat.: BKT4 B337



Birth: 3-22-14

Beckton Accent U777 C2  
Beckton Cody K1 P014  
Beckton Susan R022 CQ

**BECKTON ACCENT Y312 N3**  
Ref. A-4  
BKT Larkeisa S055 NB  
Beckton Nebula P P707  
Beckton Larkeisa P688 CH

Beckton Nebula U206 V3  
Beckton Nebula P P707  
Beckton Minerva J615 VG

**BECKTON SUSAN Y318 N**  
Beckton Susan U092 JL  
Beckton Julian G5 S107  
Beckton Susan S306 JL

BWt	61
WR	107
ADG	4.21
YWt	1120
YR	103
Scr.	34
Fr.	4.5

DAM  
Age 3  
Wt 944  
Prog.BW 56  
WR 105  
YR 103  
Wean Pct. 54%  
Cow Eff. 113

RAAA HerdBuilder index: **201** (Top 1% of all RA bulls)  
RAAA GridMaster index: **54** (Top 4% of all RA bulls)

Calv.Ease	BW	WW	YW	Milk	HPG	Stay	Maint.En.	
EPDs	13	-5.8	51	80	24	11	17	-5.9
Marb	+.61		REA	-.02		Bfat		+.05

★★★★★ for Low Maintenance, Gainability, Marbling, Calving Ease, Stayability.

**185 BECKTON ACCENT B223 N3**  
1-A 100% # 1706307 Tat.: BKB4 B223



Birth: 3-15-14

Beckton Cody K1 P014  
Beckton Cody KH M390  
Beckton Rose M126 WR

**BECKTON ACCENT W180 C2**  
Ref. A-2  
Beckton Christy R046 CQ  
Beckton Cherokee N N479  
Beckton Christy N740 HR

Beckton Nebula U031 D3  
Beckton Nebula G S237  
Beckton Marta S459 DM

**BECKTON INDIGO X142 N**  
Beckton Indigo U004 NB  
Beckton Nebula G S237  
Beckton Indigo S354 JT

BWt	68
WR	91
ADG	3.92
YWt	1046
YR	95
Scr.	36
Fr.	4.5

DAM  
Age 4  
Wt 800  
Prog.BW 54  
WR 86  
YR 95  
Wean Pct. 57%  
Cow Eff. 121

RAAA HerdBuilder index: **184** (Top 3% of all RA bulls)  
RAAA GridMaster index: **54** (Top 4% of all RA bulls)

Calv.Ease	BW	WW	YW	Milk	HPG	Stay	Maint.En.	
EPDs	14	-6.6	50	79	20	11	15	-6.1
Marb	+.69		REA	+.02		Bfat		+.02

★★★★★ for Low Maintenance, Marbling, High Cow Efficiency, Calving Ease, Stayability.



**186 BECKTON ACCENT B254 J3**  
1-A 100% # 1705988 Tat.: BKT4 B254



Birth: 3-18-14

Beckton Accent U777 C2  
Beckton Cody K1 P014  
Beckton Susan R022 CQ

**BECKTON ACCENT Y312 N3**  
Ref. A-4  
BKT Larkeisa S055 NB  
Beckton Nebula P P707  
Beckton Larkeisa P688 CH

Beckton Justice T124 C1  
Beckton Justice C1 R483  
Beckton Scarlett R808 NB

**BECKTON TAMARA W579 J**  
Beckton Tamara S623 RA  
TR Romeo NT379  
Beckton Tamara N456 VG

BWt	57
WR	96
ADG	3.52
YWt	1022
YR	93
Scr.	39
Fr.	4.5

DAM  
Age 5  
Wt 992  
Prog.BW 61  
WR 105  
YR 102  
Wean Pct. 51%  
Cow Eff. 107

RAAA HerdBuilder index: **193** (Top 2% of all RA bulls)  
RAAA GridMaster index: **55** (Top 2% of all RA bulls)

Calv.Ease	BW	WW	YW	Milk	HPG	Stay	Maint.En.	
EPDs	16	-9.7	39	67	30	11	15	-8.3
Marb	+.60		REA	+.07		Bfat		+.06

★★★★★ for Low Maintenance, Marbling, Calving Ease, Stayability.

• Bulls •

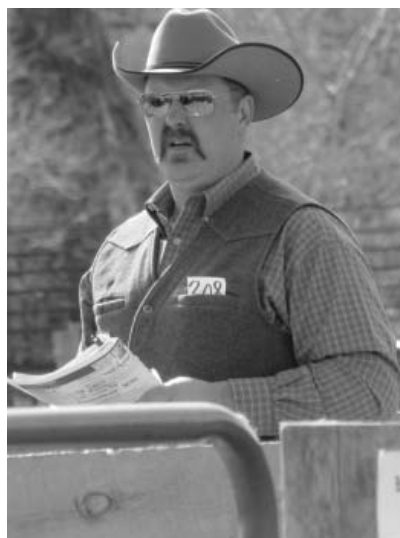

**187 BECKTON WARRIOR B202 J5**  
1-A 100% # 1705990 Tat.: BKT4 B202

Birth: 3-13-14

Beckton Warrior C1 S337  
Beckton Christy K101 CD  
Beckton Nebula P P707  
Beckton Larkeisa P688 CH  
TR Julian LT151  
Beckton Minerva L278 LN  
Beckton Julian GG B571  
Beckton Tara J266 HR

**BECKTON WARRIOR W534 N4**  
Ref. W  
BKT Larkeisa S055 NB

**BECKTON TARA W615 J**  
Beckton Jet L P491  
Beckton Tara M635 JL

BWt	61
WR	84
ADG	3.86
YWt	1018
YR	92
Scr.	36
Fr.	4.5

**DAM**  
Age 5  
Wt 1014  
Prog.BW 61  
WR 91  
YR 94  
Wean Pct. 44%  
Cow Eff. 92

RAAA HerdBuilder index: **201** (Top 1% of all RA bulls)  
RAAA GridMaster index: **54** (Top 4% of all RA bulls)

Calv.Ease	BW	WW	YW	Milk	HPG	Stay	Maint.En.	
EPDs	17	-9.2	26	41	26	11	15	-9.6

Marb **+0.94** REA **+0.00** Bfat **+0.03**

★★★★★ for Low Maintenance, Marbling, Calving Ease, Stayability.

**188 BECKTON LEGEND B641 E2**  
1-A 100% # 1705607 Tat.: BSF4 B641

Birth: 4-6-14

Beckton Lancer T A664  
Bkt Suffeina A828 DM  
Beckton Julian GG B571  
Beckton Kit A517 NP  
Beckton Epic K4 N795  
Beckton Belga K202 LN  
Beckton Dominor ZC M919  
Beckton Lana H725 CH

**BECKTON LEGEND S670**  
Ref. L-1  
Beckton Lancer F442 T  
Beckton Kit F468 JL

**BECKTON LANA X475 E**  
Beckton Epic T330 L5  
Beckton Lana S476 DM

BWt	69
WR	101
ADG	3.81
YWt	1087
YR	99
Scr.	35
Fr.	5.0

**DAM**  
Age 4  
Wt 1072  
Prog.BW 59  
WR 106  
YR 102  
Wean Pct. 51%  
Cow Eff. 107

RAAA HerdBuilder index: **188** (Top 2% of all RA bulls)  
RAAA GridMaster index: **53** (Top 7% of all RA bulls)

Calv.Ease	BW	WW	YW	Milk	HPG	Stay	Maint.En.	
EPDs	12	-5.4	45	74	20	9	16	-9.4

Marb **+0.83** REA **+0.24** Bfat **+0.03**

★★★★★ for Low Maintenance, Marbling, Rib-eye area, Calving Ease, Stayability.

**190 BECKTON EPIC B624 J7**  
1-A 100% # 1706034 Tat.: BKT4 B624

Birth: 4-5-14

Beckton Epic T330 L5  
Beckton Epic K4 N795  
Beckton Belga K202 LN  
Beckton Cherokee N N479  
Beckton Mona N009 JE  
Beckton Javelin 6587  
Beckton Rose 6807 RZ  
Beckton Lancer F442 T  
Beckton Kit F468 JL

**BECKTON EPIC X816 C6**  
Ref. E-4  
Beckton Mona R198 CQ

**BECKTON KIT X237 L**  
Bkt Javelin 7466 R  
Beckton Kit S545 LN

BWt	65
WR	95
ADG	4.21
YWt	1098
YR	100
Scr.	31
Fr.	5.0

**DAM**  
Age 4  
Wt 862  
Prog.BW 65  
WR 99  
YR 100  
Wean Pct. 59%  
Cow Eff. 125

RAAA HerdBuilder index: **160** (Top 9% of all RA bulls)  
RAAA GridMaster index: **52** (Top 20% of all RA bulls)

Calv.Ease	BW	WW	YW	Milk	HPG	Stay	Maint.En.	
EPDs	12	-6.6	35	59	28	10	14	-7.2

Marb **+0.61** REA **+0.13** Bfat **+0.03**

★★★★★ for Low Maintenance, Gainability, Marbling, Rib-eye area, High Cow Efficiency, Calving Ease, Stayability.

**189 BECKTON EPIC B675 C7**  
1-A 100% # 1706131 Tat.: BKT4 B675

Birth: 4-9-14

Beckton Epic T330 L5  
Beckton Epic K4 N795  
Beckton Belga K202 LN  
Beckton Lancer F442 T  
Beckton Kit F468 JL  
BKT Clifftop TP R288  
BKT Pine Marie R213 EP  
Beckton Nomad T 9A14  
Beckton Suffeina P603 JL

**BECKTON EPIC X330 L6**  
Ref. E-2  
Beckton Kit R503 LN

**BECKTON SUFFEINA Y489 C**  
Beckton Clifftop W577 E3  
Beckton Suffeina W369 N

BWt	73
WR	114
ADG	3.81
YWt	1116
YR	105
Scr.	33
Fr.	5.5

**DAM**  
Age 3  
Wt 948  
Prog.BW 69  
WR 106  
YR 104  
Wean Pct. 59%  
Cow Eff. 124

RAAA HerdBuilder index: **160** (Top 9% of all RA bulls)  
RAAA GridMaster index: **52** (Top 23% of all RA bulls)

Calv.Ease	BW	WW	YW	Milk	HPG	Stay	Maint.En.	
EPDs	10	-2.3	55	91	21	9	15	-4.2

Marb **+0.63** REA **+0.14** Bfat **+0.03**

★★★★★ for Low Maintenance, Marbling, Rib-eye area, Superior Cow, High Cow Efficiency, Calving Ease, Stayability.

**191 BECKTON NEW ERA B424 C2**  
1-A 100% # 1706067 Tat.: BKT4 B424

Birth: 3-26-14

Beckton Nebula P P707  
Beckton Nebula M045  
Beckton Lana M809 EP  
Beckton Justice C1 R483  
BKT Larkeisa R775 JC  
Beckton Cherokee N N479  
Beckton Annie M337 LN  
Beckton Warrior T C371  
Beckton Rose D741 LN

**BECKTON NEW ERA Y194**  
Ref. N-6  
BKT Larkeisa T310 JC

**BECKTON ROSE X662 C**  
Beckton Cherokee T450 L3  
Beckton Rose M126 WR

BWt	80
WR	113
ADG	4.49
YWt	1109
YR	112
Scr.	35
Fr.	5.0

**DAM**  
Age 4  
Wt 1175  
Prog.BW 69  
WR 107  
YR 107  
Wean Pct. 39%  
Cow Eff. 83

RAAA HerdBuilder index: **170** (Top 6% of all RA bulls)  
RAAA GridMaster index: **52** (Top 12% of all RA bulls)

Calv.Ease	BW	WW	YW	Milk	HPG	Stay	Maint.En.	
EPDs	12	-2.8	60	103	25	10	15	-3.5

Marb **+0.54** REA **-0.08** Bfat **+0.03**

★★★★★ for Low Maintenance, Growth, Gainability, Marbling, Superior Cow, Calving Ease, Stayability.

• Bulls •

**192** **BECKTON NEBULA B166 N5**   
 1-A 100% # 1706154 Tat.: BKT4 B166  
 Birth: 3-9-14

Beckton Nebula X353 E3  
**BECKTON NEBULA Z180 H4**  
 Ref. N-8  
 Beckton Mona X817 H

Beckton Nebula G S237  
 Beckton Lana R058 EP  
 Beckton Heritage T270 J2  
 Beckton Mona T794 CD  
 Beckton Nebula G S237  
 Beckton Lana R058 EP  
 Beckton Cherokee T450 L3  
 Beckton Rose M126 WR

BWt **50**  
 WR **101**  
 ADG **3.41**  
 YWt. **1037**  
 YR **100**  
 Scr. **31**  
 Fr. **5.5**

Beckton Nebula X353 E3  
**BECKTON ROSE Z048 N**  
 Beckton Rose X662 C

**DAM**  
 Age 2  
 Wt 962  
 Prog.BW 50  
 WR 101  
 YR 100  
 Wean Pct. 46%  
 Cow Eff. 97

RAAA HerdBuilder index: **165** (Top 7% of all RA bulls)  
 RAAA GridMaster index: **53** (Top 5% of all RA bulls)  
 Calv.Ease BW WW YW Milk HPG Stay Maint.En.  
 EPDs **12 -7.4 54 95 21 6 15.3 1.6**  
 Marb **+0.51** REA **+1.1** Bfat **+0.3**

★★★★★ for Low Maintenance, Marbling, Calving Ease, Stayability.

**194** **BECKTON EPIC B573 L7**   
 1-A 100% # 1705818 Tat.: BKT4 B573  
 Birth: 4-2-14

Beckton Epic T330 L5  
**BECKTON EPIC X816 C6**  
 Ref. E-4  
 Beckton Mona R198 CQ

Beckton Epic K4 N795  
 Beckton Belga K202 LN  
 Beckton Cherokee N N479  
 Beckton Mona N009 JE  
 Beckton Lancer T A664  
 Bkt Suffeina A828 DM  
 Beckton Julian GG B571  
 Beckton Kit A517 NP

BWt **82**  
 WR **92**  
 ADG **3.41**  
 YWt. **1037**  
 YR **94**  
 Scr. **34**  
 Fr. **5.0**

Beckton Lancer F442 T  
**BECKTON KIT R503 LN**  
 Beckton Kit F468 JL

**DAM**  
 Age 9  
 Wt 1118  
 Prog.BW 67  
 WR 97  
 YR 96  
 Wean Pct. 46%  
 Cow Eff. 96

RAAA HerdBuilder index: **143** (Top 19% of all RA bulls)  
 RAAA GridMaster index: **50** (Top 46% of all RA bulls)  
 Calv.Ease BW WW YW Milk HPG Stay Maint.En.  
 EPDs **10 -3.0 46 75 22 9 13 -5.9**  
 Marb **+0.58** REA **+0.33** Bfat **+0.02**

★★★★★ for Low Maintenance, Marbling, Rib-eye area, Calving Ease, Stayability.

**193** **BECKTON JULIAN B142 E8**   
 1-A 100% # 1705774 Tat.: BSF4 B142  
 Birth: 3-5-14

Beckton Julian X721 E6  
**BECKTON JULIAN Z382 J7**  
 Ref. J-5  
 Beckton Larkaba X064 J

Beckton Julian U699 L5  
 Beckton Lana U329 EP  
 Beckton Julian U699 L5  
 Beckton Larkaba U475 CT  
 Beckton Epic K4 N795  
 Beckton Larkaba H798 WR  
 Beckton Warhawk N560  
 Beckton Larkabel N769 HR

BWt **77**  
 WR **111**  
 ADG **4.32**  
 YWt. **1143**  
 YR **110**  
 Scr. **35**  
 Fr. **5.5**

Beckton Emcee S466  
**BECKTON LARKABEL Z812 E**  
 BKT Larkabel R038 WA

**DAM**  
 Age 2  
 Wt 844  
 Prog.BW 77  
 WR 111  
 YR 110  
 Wean Pct. 54%  
 Cow Eff. 113

RAAA HerdBuilder index: **167** (Top 7% of all RA bulls)  
 RAAA GridMaster index: **51** (Top 26% of all RA bulls)  
 Calv.Ease BW WW YW Milk HPG Stay Maint.En.  
 EPDs **12 -1.9 64 98 25 12 14 -6.3**  
 Marb **+0.47** REA **+0.15** Bfat **+0.03**

★★★★★ for Low Maintenance, Growth, Gainability, Marbling, Rib-eye area, Superior Cow, Calving Ease, Stayability.

**195** **BECKTON EPIC B309 N6**   
 1-A 100% # 1706091 Tat.: BKT4 B309  
 Birth: 3-20-14

Beckton Epic K6 S569  
**BECKTON EPIC X464 L5**  
 Ref. E-3  
 Beckton Lana M393 LN

Beckton Epic KM M115  
 Beckton Sierra N703 LM  
 Beckton Lancer T3 J396  
 Beckton Lana F081 LN  
 Beckton Nebula PJ S543  
 Beckton Lana S197 JT  
 Beckton Loki CL S284  
 Beckton Ruth P591 LN

BWt **73**  
 WR **101**  
 ADG **3.24**  
 YWt. **1020**  
 YR **94**  
 Scr. **34**  
 Fr. **5.5**

Beckton Nebula W778 J4  
**BECKTON RUTH Y047 N**  
 Beckton Ruth W246 L

**DAM**  
 Age 3  
 Wt 960  
 Prog.BW 66  
 WR 99  
 YR 96  
 Wean Pct. 49%  
 Cow Eff. 104

RAAA HerdBuilder index: **161** (Top 9% of all RA bulls)  
 RAAA GridMaster index: **51** (Top 31% of all RA bulls)  
 Calv.Ease BW WW YW Milk HPG Stay Maint.En.  
 EPDs **11 -2.6 58 95 25 7 15 -1.5**  
 Marb **+0.47** REA **+0.06** Bfat **-0.01**

★★★★★ for Low Maintenance, Marbling, Calving Ease, Stayability.



**196** **BECKTON JULIAN B603 J5**   
 1-A 100% # 1705543 Tat.: BSF4 B603  
 Birth: 4-4-14

Beckton Julian GG B571  
**BECKTON JULIAN G3 P608**  
 Ref. J  
 Bkt Suffeina A828 DM

Beckton Julian 7526G  
 Bkt Marta 9A13 JL  
 Beckton Dominor 9455  
 Bkt Suffeina 9493 TT  
 Beckton Julian G1 J526  
 Beckton Barona J591 EP  
 Beckton Herald F1 L151  
 Beckton Indigo LC22 LO

BWt **64**  
 WR **98**  
 ADG **3.41**  
 YWt. **1058**  
 YR **96**  
 Scr. **35**  
 Fr. **4.5**

Beckton Jules L429  
**BECKTON INDIGO W419 J**  
 Beckton Indigo N754 HR

**DAM**  
 Age 5  
 Wt 1200  
 Prog.BW 62  
 WR 104  
 YR 103  
 Wean Pct. 46%  
 Cow Eff. 96

RAAA HerdBuilder index: **180** (Top 3% of all RA bulls)  
 RAAA GridMaster index: **53** (Top 6% of all RA bulls)  
 Calv.Ease BW WW YW Milk HPG Stay Maint.En.  
 EPDs **15 -7.3 40 69 21 14 14 -7.1**  
 Marb **+0.73** REA **-0.13** Bfat **-0.01**

★★★★★ for Low Maintenance, Marbling, Superior Cow, Calving Ease, Stayability.

• Bulls •

**197 BECKTON NEW ERA B389 E2**  
1-A 100% # 1705857 Tat.: BKT4 B389



Birth: 3-25-14

Beckton Nebula P P707  
Beckton Nebula M045  
Beckton Lana M809 EP  
Beckton Justice C1 R483  
BKT Larkeisa T310 JC  
BKT Larkeisa R775 JC  
Beckton Epic K F075  
Beckton Minerva F495 CH  
Beckton Justice C K449  
Beckton Barmaid G565 LN

**BECKTON NEW ERA Y194**  
Ref. N-6

**BECKTON BARMAID T193 EP**  
Beckton Epic KM M115  
Beckton Barmaid N258 JC

BWT	71
WR	87
ADG	3.81
YWt.	1026
YR	93
Scr.	36
Fr.	4.5

**DAM**

Age	7
Wt	1332
Prog.BW	69
WR	102
YR	105
Wean Pct.	37%
Cow Eff.	77

RAAA HerdBuilder index: **170** (Top 6% of all RA bulls)  
RAAA GridMaster index: **55** (Top 2% of all RA bulls)

Calv.Ease	BW	WW	YW	Milk	HPG	Stay	Maint.En.	
EPDs	12	-5.7	58	98	23	11	14	0.5

Marb **+0.71** REA **-0.25** Bfat **+0.02**

★★★★★ for Low Maintenance, Marbling, Calving Ease, Stayability.

**199 BECKTON SCAMP B026 S5**  
1-A 100% # 1706289 Tat.: BKT4 B026



Birth: 2-15-14

Beckton Scamp X458 H3  
Beckton Scamp T A825  
BKT Pine Marie R401 HU  
Beckton Lancer F442 T  
Beckton Belga W405 L  
Beckton Belga K285 JL  
Beckton Scamp T A825  
BKT Pine Marie R401 HU  
Beckton Epic K4 N795  
Beckton Encino S566 JL

**BECKTON SCAMP Z460 L4**  
Ref. S-2

**BECKTON ENCINO Z883 S**  
Beckton Scamp X458 H3  
Beckton Encino W439 E

BWT	45
WR	102
ADG	3.52
YWt.	1016
YR	98
Scr.	34
Fr.	5.0

**DAM**

Age	2
Wt	826
Prog.BW	45
WR	102
YR	98
Wean Pct.	49%
Cow Eff.	104

RAAA HerdBuilder index: **156** (Top 11% of all RA bulls)  
RAAA GridMaster index: **53** (Top 11% of all RA bulls)

Calv.Ease	BW	WW	YW	Milk	HPG	Stay	Maint.En.	
EPDs	12	-8.3	43	79	20	8.3	12	-4.9

Marb **+0.45** REA **+0.12** Bfat **+0.01**

★★★★★ for Low Maintenance, Marbling, Calving Ease.



**200 BECKTON ACCENT B025 A3**  
1-A 100% # 1706296 Tat.: BKT4 B025



Birth: 2-15-14

Beckton Accent W180 C2  
Beckton Cody K1 P014  
Beckton Christy R046 CQ  
Beckton Julio L233  
Beckton Susan P857 JO  
Beckton Susan G199 CO  
Beckton Cody K1 P014  
Beckton Christy R046 CQ  
Beckton Julian G1 J526  
Beckton Lana H533 LN

**BECKTON ACCENT Z506 J3**  
Ref. A-5

**BECKTON LANA Z916 A**  
Beckton Accent W180 C2  
Beckton Lana N664 JL

BWT	62
WR	94
ADG	3.98
YWt.	1053
YR	101
Scr.	30
Fr.	5.0

**DAM**

Age	2
Wt	1004
Prog.BW	62
WR	94
YR	101
Wean Pct.	40%
Cow Eff.	85

RAAA HerdBuilder index: **171** (Top 6% of all RA bulls)  
RAAA GridMaster index: **53** (Top 8% of all RA bulls)

Calv.Ease	BW	WW	YW	Milk	HPG	Stay	Maint.En.	
EPDs	10	-4.0	58	88	25	9	16	-3.0

Marb **+0.44** REA **+0.18** Bfat **+0.05**

★★★★★ for Low Maintenance, Marbling, Rib-eye area, Calving Ease, Stayability.

**198 BECKTON CLIFFTOP B182 E5**  
1-A 100% # 1706223 Tat.: BKT4 B182



Birth: 3-12-14

Beckton Clifftop W577 E3  
BKT Clifftop TP R288  
BKT Pine Marie R213 EP  
Beckton Cherokee N N479  
Beckton Tamara N765 CO  
Beckton Emcee S466  
Beckton Larkaba P645 JL  
BKT Clifftop TP R288  
Beckton Lana R128 LS

**BECKTON CLIFFTOP Z824 C4**  
Ref. C-3

**BECKTON LANA Z455 E**  
Beckton Emcee W526 J2  
Beckton Lana T104 CT

BWT	63
WR	113
ADG	3.98
YWt.	1115
YR	107
Scr.	32
Fr.	5.0

**DAM**

Age	2
Wt	902
Prog.BW	63
WR	113
YR	107
Wean Pct.	51%
Cow Eff.	108

RAAA HerdBuilder index: **188** (Top 2% of all RA bulls)  
RAAA GridMaster index: **52** (Top 14% of all RA bulls)

Calv.Ease	BW	WW	YW	Milk	HPG	Stay	Maint.En.	
EPDs	11	-4.8	46	73	28	11	18	-5.3

Marb **+0.57** REA **+0.17** Bfat **+0.04**

★★★★★ for Low Maintenance, Growth, Marbling, Rib-eye area, Superior Cow, Calving Ease, Stayability.

**201 BECKTON SCAMP B589 N4**  
1-A 100% # 1706114 Tat.: BKT4 B589



Birth: 4-3-14

Beckton Scamp T A825  
Beckton Scamp 8954  
Bkt Encino 8459 TJ  
Beckton Epic KH P678  
Beckton Lana P317 JL  
Beckton Nebula M045  
Beckton Lana M809 EP  
TR Julian LT151  
Beckton Sierra K557 LO

**BECKTON SCAMP X494 E3**  
Ref. S-1

**BECKTON SIERRA Y308 N**  
Beckton Nebula P P707  
Beckton Sierra P551 JT

BWT	57
WR	107
ADG	3.98
YWt.	1105
YR	103
Scr.	33
Fr.	5.0

**DAM**

Age	3
Wt	1095
Prog.BW	61
WR	111
YR	106
Wean Pct.	46%
Cow Eff.	96

RAAA HerdBuilder index: **182** (Top 3% of all RA bulls)  
RAAA GridMaster index: **54** (Top 4% of all RA bulls)

Calv.Ease	BW	WW	YW	Milk	HPG	Stay	Maint.En.	
EPDs	13	-6.3	54	89	26	9	15	-6.4

Marb **+0.58** REA **-0.04** Bfat **+0.01**

★★★★★ for Low Maintenance, Marbling, Superior Cow, Calving Ease, Stayability.

• Bulls •

**202 BECKTON EPIC B528 E6**  
1-A 100% # 1706021 Tat.: BKT4 B528



Birth: 3-29-14

Beckton Epic K4 N795  
Beckton Sierra J789 EP  
Beckton Dominor ZC M919  
Beckton Denise L639 JL  
Beckton Epic U126 J5  
Beckton Ruth S076 JT  
Beckton Cherokee N N479  
Beckton Emera P378 LN

**BECKTON EPIC U749 D5**  
Ref. E-1  
Beckton Denise R308 DM

**BECKTON EMERA X106 E**  
Beckton Emera U675 CQ

BWt	70
WR	94
ADG	3.75
YWt	1073
YR	97
Scr.	32
Fr.	5.0

**DAM**  
Age 4  
Wt 900  
Prog.BW 65  
WR 98  
YR 100  
Wean Pct. 56%  
Cow Eff. 118

RAAA HerdBuilder index: **158** (Top 10% of all RA bulls)  
RAAA GridMaster index: **51** (Top 37% of all RA bulls)  
Calv.Ease BW WW YW Milk HPG Stay Maint.En.  
EPDs **11 -5.1 45 80 20 9 14 -5.2**  
Marb **+0.51** REA **+0.26** Bfat **+0.01**

★★★★★ for Low Maintenance, Marbling, Rib-eye area, High Cow Efficiency, Calving Ease, Stayability.

**204 BECKTON JULIAN B231 J8**  
1-A 100% # 1706169 Tat.: BKT4 B231



Birth: 3-16-14

Beckton Julian X721 E6  
Beckton Lana U329 EP  
Beckton Julian U699 L5  
Beckton Larkaba X064 J  
Beckton Julian U699 L5  
Beckton Lana U329 EP  
Beckton Julian U699 L5  
Beckton Tamara X587 J  
Beckton Tamara S432 DM

**BECKTON JULIAN Z382 J7**  
Ref. J-5

**BECKTON TAMARA Z163 J**

BWt	64
WR	103
ADG	3.69
YWt	1032
YR	99
Scr.	33
Fr.	5.0

**DAM**  
Age 2  
Wt 850  
Prog.BW 64  
WR 103  
YR 99  
Wean Pct. 53%  
Cow Eff. 112

RAAA HerdBuilder index: **199** (Top 1% of all RA bulls)  
RAAA GridMaster index: **53** (Top 11% of all RA bulls)  
Calv.Ease BW WW YW Milk HPG Stay Maint.En.  
EPDs **12 -5.0 62 96 25 12.5 18.3 -9.3**  
Marb **+0.38** REA **+0.25** Bfat **+0.03**

★★★★★ for Low Maintenance, Marbling, Rib-eye area, Calving Ease, Stayability.

**203 BECKTON LIKABLE B570 J3**  
1-A 100% # 1705855 Tat.: BKT4 B570



Birth: 4-2-14

Beckton Likable S633  
Beckton Lancer F442 T  
Beckton Kit F468 JL  
Beckton Lancer F442 T  
Beckton Kit F468 JL  
Beckton Julian G1 J526  
Beckton Serena D760 KR  
Beckton Justice G302  
Bkt Larkeisa G448 CT

**BECKTON LIKABLE U130 L2**  
Ref. L-2  
Beckton Kit S478 LN

**BKT LARKEISA T149 JJ**  
Beckton Juno N493  
Beckton Larkeisa M138 JC

BWt	80
WR	97
ADG	3.47
YWt	1021
YR	92
Scr.	35
Fr.	5.0

**DAM**  
Age 7  
Wt 1066  
Prog.BW 65  
WR 101  
YR 96  
Wean Pct. 48%  
Cow Eff. 101

RAAA HerdBuilder index: **168** (Top 7% of all RA bulls)  
RAAA GridMaster index: **51** (Top 30% of all RA bulls)  
Calv.Ease BW WW YW Milk HPG Stay Maint.En.  
EPDs **12 -3.8 54 77 14 9 14 -8.2**  
Marb **+0.41** REA **+0.36** Bfat **+0.02**

★★★★★ for Low Maintenance, Marbling, Rib-eye area, Calving Ease, Stayability.

**205 BECKTON CARDINAL B124 S**  
1-A 100% # 1706228 Tat.: BKT4 B124



Birth: 3-3-14

TR Ricardo DOS  
BFCk Cherokee Cnyn 4912  
TR Dyna LT111  
Beckton Justice C1 R483  
Beckton Lana H544 WR  
Beckton Scamp T A825  
BKT Pine Marie R401 HU  
Beckton Heritage T270 J2  
Beckton Lana T699 JC

**TR DOUBLE EAGLE ZT220**  
Ref. C-4  
Beckton Lana U182 JC

**BECKTON LANA Z489 S**  
Beckton Scamp X458 H3  
Beckton Lana W019 H

BWt	66
WR	106
ADG	3.86
YWt	1046
YR	101
Scr.	31
Fr.	4.5

**DAM**  
Age 2  
Wt 924  
Prog.BW 66  
WR 106  
YR 101  
Wean Pct. 46%  
Cow Eff. 98

RAAA HerdBuilder index: **170** (Top 6% of all RA bulls)  
RAAA GridMaster index: **52** (Top 12% of all RA bulls)  
Calv.Ease BW WW YW Milk HPG Stay Maint.En.  
EPDs **11 -3.8 62 94 19 11 6.8 -6.7**  
Marb **+0.52** REA **+0.13** Bfat **+0.01**

★★★★★ for Low Maintenance, Marbling, Rib-eye area, Calving Ease.



**206 BECKTON WARRIOR B782 J5**  
1-A 100% # 1705501 Tat.: BSF4 B782



Birth: 4-9-14

Beckton Warrior C1 S337  
Beckton Warrior CL M686  
Beckton Christy K101 CD  
Beckton Nebula P P707  
Beckton Larkeisa P688 CH  
Beckton Julian GJ P535  
Beckton Mona D086 JL  
Beckton Christy P333 CH  
Beckton Champ R1 H024  
Beckton Christy K209 CO

**BECKTON WARRIOR W534 N4**  
Ref. W

**BECKTON CHRISTY U415 JL**

BWt	NA
WR	94
ADG	3.98
YWt	1043
YR	95
Scr.	35
Fr.	4.5

**DAM**  
Age 6  
Wt 1142  
Prog.BW 54  
WR 94  
YR 95  
Wean Pct. 46%  
Cow Eff. 97

RAAA HerdBuilder index: **197** (Top 1% of all RA bulls)  
RAAA GridMaster index: **53** (Top 10% of all RA bulls)  
Calv.Ease BW WW YW Milk HPG Stay Maint.En.  
EPDs **16 -8.3 28 44 23 14 15 -10.5**  
Marb **+0.65** REA **+0.09** Bfat **+0.05**

★★★★★ for Low Maintenance, Marbling, Calving Ease, Stayability.

• Bulls •



**209** **BSF CLIFFTOP B767 L4** 

1-B 99% # 1706309 Tat.: BKB4 B767

Birth: 4-19-14

BKT Clifftop TP R288

**BECKTON CLIFFTOP W692 E3**

Ref. C-1

Beckton Lydia S274 EP

Beckton Clifftop T C075

Beckton Christy K209 CO

Beckton Epic KM M115

Beckton Lydia M607 LO

Beckton Lancer F442 T

Beckton Minola E589 TO

Beckton Julio L233

BSF Regus M604 LN

**BSF JULIA X752 L**

Beckton Laser N602

BSF Julia T175 JO

BWT	77
WR	105
ADG	3.37
YWT	1143
YR	104
Scr.	34
Fr.	5.0

DAM

Age 4

Wt 1052

Prog. BW 67

WR 106

YR 103

Wean Pct. 54%

Cow Eff. 113

RAAA HerdBuilder index: **168** (Top 6% of all RA bulls)

RAAA GridMaster index: **52** (Top 17% of all RA bulls)

Calv. Ease	BW	WW	YW	Milk	HPG	Stay	Maint. En.	
EPDs	11	-3.9	47	80	26	9	15	-5.0

Marb **+0.52** REA **-0.13** Bfat **+0.05**

★★★★★ for Low Maintenance, Marbling, Calving Ease, Stayability.

**207** **BECKTON ACCENT B239 N2** 

1-A 100% # 1706148 Tat.: BKT4 B239

Birth: 3-17-14

Beckton Cody K1 P014

**BECKTON ACCENT W180 C2**

Ref. A-2

Beckton Christy R046 CQ

Beckton Cody KH M390

Beckton Rose M126 WR

Beckton Cherokee N N479

Beckton Christy N740 HR

Beckton Nebula P P707

Beckton Minerva J615 VG

Beckton Juno N493

Beckton Minola R720 JJ

Beckton Minola N751 JL

BWt	55
WR	97
ADG	3.75
YWT	1044
YR	98
Scr.	32
Fr.	4.5

DAM

Age 3

Wt 912

Prog. BW 48

WR 96

YR 103

Wean Pct. 51%

Cow Eff. 108

RAAA HerdBuilder index: **178** (Top 4% of all RA bulls)

RAAA GridMaster index: **54** (Top 3% of all RA bulls)

Calv. Ease	BW	WW	YW	Milk	HPG	Stay	Maint. En.	
EPDs	11	-7.2	56	88	21	11	15	-4.5

Marb **+0.51** REA **+0.17** Bfat **+0.03**

★★★★★ for Low Maintenance, Marbling, Rib-eye area, Calving Ease, Stayability.

**210** **BSF WARRIOR B449 N5** 

1-B 99% # 1705536 Tat.: BSF4 B449

Birth: 3-27-14

Beckton Warrior C1 S337

**BECKTON WARRIOR W534 N4**

Ref. W

BKT Larkeisa S055 NB

Beckton Warrior CL M686

Beckton Christy K101 CD

Beckton Nebula P P707

Beckton Larkeisa P688 CH

Beckton Nebula M045

Beckton Larkeisa M138 JC

Beckton Julio L233

BSF Regus L013 CT

BWt	60
WR	106
ADG	3.20
YWT	1074
YR	97
Scr.	36
Fr.	4.5

DAM

Age 5

Wt 1008

Prog. BW 59

WR 100

YR 97

Wean Pct. 55%

Cow Eff. 116

RAAA HerdBuilder index: **207** (Top 1% of all RA bulls)

RAAA GridMaster index: **54** (Top 3% of all RA bulls)

Calv. Ease	BW	WW	YW	Milk	HPG	Stay	Maint. En.	
EPDs	16	-9.1	37	61	22	11	16	-13.6

Marb **+0.64** REA **+0.03** Bfat **+0.05**

★★★★★ for Low Maintenance, Marbling, Calving Ease, Stayability.

**208** **BECKTON WARRIOR B030 J7** 

1-A 100% # 1706272 Tat.: BKT4 B030

Birth: 2-16-14

Beckton Warrior T248 L5

**BECKTON WARRIOR Z936 N6**

Ref. W-1

Beckton Freyja W462 N

Beckton Warrior N645 T1

Beckton Kit R503 LN

Beckton Nebula T054 H3

Beckton Freyja T147 HI

Beckton Julian G5 S107

Beckton Kit L399 HR

BKT Clifftop TP R288

Beckton Lana R310 JE

BWt	73
WR	102
ADG	4.38
YWT	1095
YR	105
Scr.	36
Fr.	4.5

DAM

Age 2

Wt 910

Prog. BW 73

WR 102

YR 105

Wean Pct. 43%

Cow Eff. 91

RAAA HerdBuilder index: **163** (Top 8% of all RA bulls)

RAAA GridMaster index: **50** (Top 44% of all RA bulls)

Calv. Ease	BW	WW	YW	Milk	HPG	Stay	Maint. En.	
EPDs	7	-1.0	55	86	16	13	15	-7.8

Marb **+0.51** REA **+0.17** Bfat **+0.03**

★★★★★ for Low Maintenance, Gainability, Marbling, Rib-eye area, Calving Ease, Stayability.

**211** **BSF EMPEROR B106 N4** 

1-B 99% # 1705684 Tat.: BSF4 B106

Birth: 2-27-14

Beckton Emperor T641 E2

**BECKTON EMPEROR Z750 N3**

Ref. E-8

Beckton Lana U789 NB

Beckton Emperor R100

Beckton Vernice R416 EP

Beckton Nebula M045

Beckton Lana P073 EP

Beckton Nomad V 9871

Beckton Birdie S110 NB

Beckton Heritage T270 J2

BSF Julianne P152

BWt	64
WR	100
ADG	4.83
YWT	1117
YR	107
Scr.	34
Fr.	5.0

DAM

Age 2

Wt 840

Prog. BW 64

WR 100

YR 107

Wean Pct. 46%

Cow Eff. 97

RAAA HerdBuilder index: **173** (Top 5% of all RA bulls)

RAAA GridMaster index: **53** (Top 7% of all RA bulls)

Calv. Ease	BW	WW	YW	Milk	HPG	Stay	Maint. En.	
EPDs	13	-5.3	52	80	22	8	14	-6.2

Marb **+0.57** REA **-0.17** Bfat **+0.03**

★★★★★ for Low Maintenance, Growth, Gainability, Marbling, Calving Ease, Stayability.



• Bulls •



**214** **BSF EPIC B709 A7** 

1-B 99% # 1705654 Tat.: BSF4 B709

Birth: 4-13-14

Beckton Epic T330 L5  
 Beckton Epic K4 N795  
 Beckton Belga K202 LN

**BECKTON EPIC X330 L6**  
 Ref. E-2  
 Beckton Kit R503 LN  
 Beckton Lancer F442 T  
 Beckton Kit F468 JL

Beckton Accent U777 C2  
 Beckton Cody K1 P014  
 Beckton Susan R022 CQ

**BSF LANETTE Y347 A**  
 BSF Lanette U478 LN  
 Beckton Lancer T A664  
 BSF Regus M595 LN

BWT	60
WR	110
ADG	3.93
YWT	1133
YR	104
Scr.	36
Fr.	5.5

DAM

Age	3
Wt	882
Prog. BW	57
WR	106
YR	103
Wean Pct.	59%
Cow Eff.	124

RAAA HerdBuilder index: **177** (Top 4% of all RA bulls)  
 RAAA GridMaster index: **53** (Top 8% of all RA bulls)

Calv. Ease	BW	WW	YW	Milk	HPG	Stay	Maint. En.	
EPDs	13	-7.1	49	82	23	9	15	-4.6
Marb	+0.57		REA	+0.20		Bfat		+0.01

★★★★★ for Low Maintenance, Marbling, Rib-eye area, Superior Cow, High Cow Efficiency, Calving Ease, Stayability.

**212** **BSF ACCENT B334 W3** 

1-B 99% # 1705619 Tat.: BSF4 B334

Birth: 3-22-14

Beckton Accent U777 C2  
 Beckton Cody K1 P014  
 Beckton Susan R022 CQ

**BECKTON ACCENT Y312 N3**  
 Ref. A-4  
 BKT Larkeisa S055 NB  
 Beckton Nebula P P707  
 Beckton Larkeisa P688 CH

Beckton Warrior T248 L5  
 Beckton Warrior N645 T1  
 Beckton Kit R503 LN

**BSF LANETTE X568 W**  
 BSF Lanette P615  
 Beckton Lancer T4 J536  
 BSF Regus F697

BWT	72
WR	96
ADG	3.76
YWT	1061
YR	96
Scr.	33
Fr.	5.0

DAM

Age	4
Wt	1044
Prog. BW	60
WR	101
YR	100
Wean Pct.	46%
Cow Eff.	97

RAAA HerdBuilder index: **191** (Top 2% of all RA bulls)  
 RAAA GridMaster index: **52** (Top 13% of all RA bulls)

Calv. Ease	BW	WW	YW	Milk	HPG	Stay	Maint. En.	
EPDs	13	-5.9	46	75	24	12	16	-5.9
Marb	+0.47		REA	+0.04		Bfat		+0.04

★★★★★ for Low Maintenance, Marbling, Calving Ease, Stayability.

**215** **BSF EPIC B768 L7** 

1-B 99% # 1705599 Tat.: BSF4 B768

Birth: 4-19-14

Beckton Epic T330 L5  
 Beckton Epic K4 N795  
 Beckton Belga K202 LN

**BECKTON EPIC X330 L6**  
 Ref. E-2  
 Beckton Kit R503 LN  
 Beckton Lancer F442 T  
 Beckton Kit F468 JL

Beckton Likable U091 J2  
 Beckton Likable S633  
 Beckton Lana S157 JT

**BSF JUSTICIA X326 L**  
 BSF Justicia U261 NM  
 Beckton Nomad V 9871  
 BSF Justicia P007

BWT	65
WR	98
ADG	3.93
YWT	1113
YR	101
Scr.	35
Fr.	5.0

DAM

Age	4
Wt	914
Prog. BW	57
WR	103
YR	100
Wean Pct.	54%
Cow Eff.	113

RAAA HerdBuilder index: **166** (Top 7% of all RA bulls)  
 RAAA GridMaster index: **53** (Top 10% of all RA bulls)

Calv. Ease	BW	WW	YW	Milk	HPG	Stay	Maint. En.	
EPDs	13	-7.3	45	75	25	9	13	-10.6
Marb	+0.54		REA	+0.25		Bfat		+0.03

★★★★★ for Low Maintenance, Marbling, Rib-eye area, Calving Ease, Stayability.

**213** **BSF EPIC B091 N7** 

1-B 99% # 1705677 Tat.: BSF4 B091

Birth: 2-26-14

Beckton Epic U749 D5  
 Beckton Epic K4 N795  
 Beckton Denise R308 DM

**BECKTON EPIC Z674 E6**  
 Ref. E-7  
 Beckton Indigo U504 EP  
 Beckton Epic K6 S569  
 Beckton Indigo S016 NB

Beckton Nebula X603 J4  
 Beckton Nebula T398 V3  
 Beckton Firefly T003 JC

**BSF LAUREL Z003 N**  
 BSF Laurel X711 L  
 Beckton Loki CL S284  
 BSF Laurel N411 LO

BWT	76
WR	102
ADG	4.21
YWT	1043
YR	100
Scr.	31
Fr.	5.0

DAM

Age	2
Wt	872
Prog. BW	76
WR	102
YR	100
Wean Pct.	47%
Cow Eff.	99

RAAA HerdBuilder index: **183** (Top 3% of all RA bulls)  
 RAAA GridMaster index: **52** (Top 12% of all RA bulls)

Calv. Ease	BW	WW	YW	Milk	HPG	Stay	Maint. En.	
EPDs	11	-2.0	59	96	23	8	17	-5.5
Marb	+0.69		REA	+0.17		Bfat		+0.05

★★★★★ for Low Maintenance, Gainability, Marbling, Rib-eye area, Calving Ease, Stayability.

**216** **BSF HERITAGE B260 J4** 

1-B 99% # 1728940 Tat.: BSF4 B260

Birth: 3-18-14

Beckton Heritage T270 J2  
 Beckton Heritage N013  
 Beckton Coca P602 JL

**BECKTON HERITAGE X403 L3**  
 Ref. H-1  
 Beckton Indigo H150 LN  
 Beckton Lancer TE F363  
 Beckton Indigo F376 CT

Beckton Justice C K449  
 Beckton Justice G302  
 Bkt Larkabel C742 CF

**BSF JUSTICIA R147 JC**  
 BSF Regus J698  
 Beckton Epic K F075  
 BSF Regus F492

BWT	73
WR	91
ADG	4.10
YWT	1014
YR	92
Scr.	33
Fr.	4.5

DAM

Age	9
Wt	1240
Prog. BW	69
WR	101
YR	99
Wean Pct.	39%
Cow Eff.	81

RAAA HerdBuilder index: **156** (Top 10% of all RA bulls)  
 RAAA GridMaster index: **54** (Top 5% of all RA bulls)

Calv. Ease	BW	WW	YW	Milk	HPG	Stay	Maint. En.	
EPDs	11	-4.2	61	91	18	11	12	0.6
Marb	+0.53		REA	+0.01		Bfat		+0.03

★★★★★ for Low Maintenance, Gainability, Marbling, Calving Ease.

• Bulls •

**217 BECKTON ACCENT B611 M3** 

1-B 99% # 1706140 Tat.: BKT4 B611

Birth: 4-4-14

Beckton Accent W180 C2 < Beckton Cody K1 P014  
Beckton Christy R046 CQ

**BECKTON ACCENT Y260 L3**  
Ref. A-3 < Beckton Lana W463 L < Beckton Loki CL S284  
< Beckton Lana R327 EP

Beckton Regina Y600 M < Red Angus multiple sire < Red Angus multiple sire  
< Red Angus dam < Red Angus dam

Beckton Larkaba U153 LE < Beckton Legend S670  
< Beckton Larkaba S299 EP

BWt	76
WR	107
ADG	3.76
YWt.	1103
YR	104
Scr.	32
Fr.	5.5

**DAM**

Age	3
Wt	808
Prog.BW	70
WR	109
YR	104
Wean Pct.	65%
Cow Eff.	136

RAAA HerdBuilder index: **159** (Top 10% of all RA bulls)  
RAAA GridMaster index: **52** (Top 21% of all RA bulls)

Calv.Ease	BW	WW	YW	Milk	HPG	Stay	Maint.En.	
EPDs	7	-1.6	62	91	20	6.5	14	-10.7
Marb	+0.52		REA	+0.11		Bfat		+0.02

★★★★★ for Low Maintenance, Marbling, Superior Cow, High Cow Efficiency, Calving Ease, Stayability.

**220 BSF LEGEND B297 N4** 

1-B 99% # 1705704 Tat.: BSF4 B297

Birth: 3-20-14

Beckton Legend X561 J2 < Beckton Legend S670  
Beckton Lana T279 JO

**BECKTON LEGEND Z689 J3**  
Ref. L-4 < Beckton Julian G5 S107  
< Beckton Larkaba S663 JE

Beckton Nebula X353 E3 < Beckton Nebula G S237  
Beckton Lana R058 EP

**BSF WENDIE Z142 N**  
< Beckton Jet U473 L2  
< BSF Wendie U231 CQ

BWt	88
WR	106
ADG	3.76
YWt.	1076
YR	104
Scr.	31
Fr.	5.5

**DAM**

Age	2
Wt	976
Prog.BW	88
WR	106
YR	104
Wean Pct.	44%
Cow Eff.	92

RAAA HerdBuilder index: **163** (Top 8% of all RA bulls)  
RAAA GridMaster index: **51** (Top 24% of all RA bulls)

Calv.Ease	BW	WW	YW	Milk	HPG	Stay	Maint.En.	
EPDs	7	2.1	73	114	17	8	16.3	-3.0
Marb	+0.63		REA	+0.13		Bfat		+0.03

★★★★★ for Low Maintenance, Marbling, Rib-eye area, Superior Cow, Calving Ease, Stayability.

**218 BSF JULIAN B009 C8** 

1-B 99% # 1705762 Tat.: BSF4 B009

Birth: 2-12-14

Beckton Julian X721 E6 < Beckton Julian U699 L5  
Beckton Lana U329 EP

**BECKTON JULIAN Z382 J7**  
Ref. J-5 < Beckton Julian U699 L5  
< Beckton Larkaba U475 CT

Beckton Clifftop W692 E3 < BKT Clifftop TP R288  
Beckton Lydia S274 EP

**BSF JULIANNE Z719 C**  
BSF Julianne U150 VA < Beckton Vega P079  
< BSF Julianne R593 JL

BWt	60
WR	100
ADG	3.03
YWt.	979
YR	94
Scr.	35
Fr.	5.0

**DAM**

Age	2
Wt	916
Prog.BW	60
WR	100
YR	94
Wean Pct.	47%
Cow Eff.	100

RAAA HerdBuilder index: **196** (Top 2% of all RA bulls)  
RAAA GridMaster index: **53** (Top 8% of all RA bulls)

Calv.Ease	BW	WW	YW	Milk	HPG	Stay	Maint.En.	
EPDs	13	-6.2	53	87	25	12	17	-5.6
Marb	+0.53		REA	-0.11		Bfat		+0.04

★★★★★ for Low Maintenance, Marbling, Calving Ease, Stayability.

**221 BSF DOMINOR B758 L6** 

1-B 99% # 1728949 Tat.: BSF4 B758

Birth: 4-18-14

Beckton Dominor Z1 R610 < Beckton Dominor ZC M919  
Beckton Sierra K557 LO

**BECKTON DOMINOR W640 C5**  
Ref. D-1 < Beckton Cherokee N N479  
< Beckton Mona N342 HU

Beckton Laser N602 < Beckton Lancer F442 T  
Beckton Minola E589 TO

**BSF JEWEL R614 LS**  
BSF Jewel N039 JO < Beckton Julio L233  
< BSF Regus L013 CT

BWt	64
WR	96
ADG	3.43
YWt.	1050
YR	95
Scr.	33
Fr.	5.0

**DAM**

Age	9
Wt	1124
Prog.BW	74
WR	105
YR	103
Wean Pct.	48%
Cow Eff.	100

RAAA HerdBuilder index: **155** (Top 11% of all RA bulls)  
RAAA GridMaster index: **53** (Top 10% of all RA bulls)

Calv.Ease	BW	WW	YW	Milk	HPG	Stay	Maint.En.	
EPDs	13	-6.8	40	62	24	9	14	-5.5
Marb	+0.52		REA	-0.07		Bfat		+0.03

★★★★★ for Low Maintenance, Marbling, Superior Cow, Calving Ease, Stayability.

**219 BSF SCAMP B754 H4** 

1-B 99% # 1728947 Tat.: BSF4 B754

Birth: 4-17-14

Beckton Scamp T A825 < Beckton Scamp 8954  
Bkt Encino 8459 TJ

**BECKTON SCAMP X458 H3**  
Ref. S < Beckton Hustler C2 L079  
Bkt Pine Marie LC30 CD

Beckton Hustler C2 L079 < Beckton Hustler CN J102  
Beckton Barmaid J012 CO

**BSF HUSTLE P246**  
BSF Regus E323 < Beckton Hadrian A100  
< BSF Regus 8183-2

BWt	65
WR	91
ADG	4.10
YWt.	1051
YR	95
Scr.	35
Fr.	5.0

**DAM**

Age	10
Wt	1236
Prog.BW	72
WR	102
YR	102
Wean Pct.	39%
Cow Eff.	81

RAAA HerdBuilder index: **116** (Top 45% of all RA bulls)  
RAAA GridMaster index: **50** (Top 44% of all RA bulls)

Calv.Ease	BW	WW	YW	Milk	HPG	Stay	Maint.En.	
EPDs	10	-4.9	46	73	19	11	10	-6.9
Marb	+0.34		REA	+0.04		Bfat		-0.02

★★★★★ for Low Maintenance, Gainability, Marbling, Calving Ease.

**222 BSF EMPEROR B614 N4** 

1-B 99% # 1705753 Tat.: BSF4 B614

Birth: 4-4-14

Beckton Emperor T641 E2 < Beckton Emperor R100  
Beckton Vernice R416 EP

**BECKTON EMPEROR Z750 N3**  
Ref. E-8 < Beckton Nebula M045  
Beckton Lana P073 EP

Beckton Nebula W040 E4 < Beckton Nebula T054 H3  
BKT Suffeina T110 EM

**BSF JUSTICIA Z620 N**  
BSF Justicia U219 LE < Beckton Legend S670  
< BSF Justicia S818 JC

BWt	72
WR	101
ADG	3.93
YWt.	1049
YR	101
Scr.	33
Fr.	5.5

**DAM**

Age	2
Wt	788
Prog.BW	72
WR	101
YR	101
Wean Pct.	51%
Cow Eff.	108

RAAA HerdBuilder index: **172** (Top 5% of all RA bulls)  
RAAA GridMaster index: **52** (Top 22% of all RA bulls)

Calv.Ease	BW	WW	YW	Milk	HPG	Stay	Maint.En.	
EPDs	14	-4.3	49	79	20	9	14	-8.1
Marb	+0.55		REA	+0.08		Bfat		+0.02

★★★★★ for Low Maintenance, Marbling, Calving Ease, Stayability.

• Bulls •

**223** **BSF EPIC B066 C7** 1-B 99% # 1705765 Tat.: BSF4 B066



Birth: 2-22-14

Beckton Epic U749 D5  
**BECKTON EPIC Z674 E6** Ref. E-7  
 Beckton Indigo U504 EP

Beckton Epic K4 N795  
 Beckton Denise R308 DM  
 Beckton Epic K6 S569  
 Beckton Indigo S016 NB  
 BKT Clifftop TP R288  
 BKT Pine Marie R213 EP  
 Beckton Dominor ZC M919  
 BSF Regus L683 CT

BWT **64**  
 WR **86**  
 ADG **3.60**  
 YWt. **974**  
 YR **94**  
 Scr. **32**  
 Fr. **5.5**

Beckton Clifftop W577 E3  
**BSF DOMINIQUE Z751 C**  
 BSF Dominique R653 DM

**DAM**  
 Age 2  
 Wt 834  
 Prog.BW 64  
 WR 86  
 YR 94  
 Wean Pct. 41%  
 Cow Eff. 85

RAAA HerdBuilder index: **177** (Top 4% of all RA bulls)  
 RAAA GridMaster index: **52** (Top 17% of all RA bulls)  
 Calv.Ease BW WW YW Milk HPG Stay Maint.En.  
 EPDs **11 -4.7 42 78 25 9 17 -1.1**  
 Marb **+0.71** REA **+0.08** Bfat **+0.03**

★★★★★ for Low Maintenance, Marbling, Calving Ease, Stayability.

**225** **BECKTON JULIAN B731 N6** 1-A 100% # 1706116 Tat.: BKT4 B731



Birth: 4-15-14

Beckton Julian G5 S107  
**BECKTON JULIAN X465 J5** Ref. J-4  
 Beckton Suffeina P643 JL

Beckton Julian GJ P535  
 Beckton Minola P826 DM  
 Beckton Julian GG B571  
 Bkt Suffeina A828 DM  
 Beckton Nebula P P707  
 Beckton Minerva J615 VG  
 Beckton Clifftop T3 N800  
 Beckton Rose R545 DM

BWT **65**  
 WR **100**  
 ADG **3.54**  
 YWt. **1042**  
 YR **98**  
 Scr. **34**  
 Fr. **5.5**

Beckton Nebula U206 V3  
**BECKTON ROSE Y357 N**  
 Beckton Rose U726 CT

**DAM**  
 Age 3  
 Wt 888  
 Prog.BW 54  
 WR 102  
 YR 98  
 Wean Pct. 54%  
 Cow Eff. 114

RAAA HerdBuilder index: **188** (Top 2% of all RA bulls)  
 RAAA GridMaster index: **53** (Top 6% of all RA bulls)  
 Calv.Ease BW WW YW Milk HPG Stay Maint.En.  
 EPDs **10 -3.7 52 87 18 12 16 -6.9**  
 Marb **+0.76** REA **-0.07** Bfat **+0.03**

★★★★★ for Low Maintenance, Marbling, Calving Ease, Stayability.

**224** **BECKTON NEBULA B347 N6** 1-A 100% # 1705681 Tat.: BSF4 B347



Birth: 3-23-14

Beckton Nebula X096 N4  
**BECKTON NEBULA Z111 N5** Ref. N-7  
 Beckton Minola X670 N

Beckton Nebula U206 V3  
 Beckton Tamara U185 NB  
 Beckton Nebula T054 H3  
 Beckton Minola S103 JL  
 Beckton Nebula U206 V3  
 Beckton Lana U383 NB  
 Beckton Hasten U108 J3  
 Beckton Belga U103 JC

BWT **68**  
 WR **101**  
 ADG **3.32**  
 YWt. **1015**  
 YR **98**  
 Scr. **34**  
 Fr. **5.0**

Beckton Nebula X028 N4  
**BECKTON BELGA Z013 N**  
 Beckton Belga X019 H

**DAM**  
 Age 2  
 Wt 942  
 Prog.BW 68  
 WR 101  
 YR 98  
 Wean Pct. 47%  
 Cow Eff. 98

RAAA HerdBuilder index: **198** (Top 1% of all RA bulls)  
 RAAA GridMaster index: **52** (Top 20% of all RA bulls)  
 Calv.Ease BW WW YW Milk HPG Stay Maint.En.  
 EPDs **10 -2.6 56 94 16 9.8 15.8 -3.6**  
 Marb **+0.53** REA **-0.03** Bfat **+0.01**

★★★★★ for Low Maintenance, Marbling, Calving Ease, Stayability.

**226** **BECKTON NEBULA B156 N6** 1-A 100% # 1705718 Tat.: BSF4 B156



Birth: 3-7-14

Beckton Nebula X096 N4  
**BECKTON NEBULA Z111 N5** Ref. N-7  
 Beckton Minola X670 N

Beckton Nebula U206 V3  
 Beckton Tamara U185 NB  
 Beckton Nebula T054 H3  
 Beckton Minola S103 JL  
 Beckton Nebula U206 V3  
 Beckton Tamara U185 NB  
 Beckton Hasten U108 J3  
 Beckton Minola U630 NB

BWT **61**  
 WR **94**  
 ADG **4.05**  
 YWt. **1040**  
 YR **100**  
 Scr. **29**  
 Fr. **5.5**

Beckton Nebula X096 N4  
**BECKTON MINOLA Z219 N**  
 Beckton Minola X015 H

**DAM**  
 Age 2  
 Wt 880  
 Prog.BW 61  
 WR 94  
 YR 100  
 Wean Pct. 46%  
 Cow Eff. 97

RAAA HerdBuilder index: **202** (Top 1% of all RA bulls)  
 RAAA GridMaster index: **53** (Top 10% of all RA bulls)  
 Calv.Ease BW WW YW Milk HPG Stay Maint.En.  
 EPDs **11 -4.5 56 95 15 9.5 15.8 -1.5**  
 Marb **+0.53** REA **+0.11** Bfat **+0.01**

★★★★★ for Low Maintenance, Gainability, Marbling, Calving Ease, Stayability.



**227** **BECKTON SCAMP B180 N5** 1-A 100% # 1705754 Tat.: BSF4 B180



Birth: 3-12-14

Beckton Scamp X458 H3  
**BECKTON SCAMP Z460 L4** Ref. S-2  
 Beckton Belga W405 L

Beckton Scamp T A825  
 BKT Pine Marie R401 HU  
 Beckton Lancer F442 T  
 Beckton Belga K285 JL  
 Beckton Nebula T269 E2  
 Beckton Firefly T006 DM  
 Beckton Nebula L P093  
 Beckton Minola R678 JE

BWT **62**  
 WR **105**  
 ADG **3.99**  
 YWt. **1056**  
 YR **102**  
 Scr. **36**  
 Fr. **5.5**

Beckton Nebula W130 D3  
**BECKTON MINOLA Z625 N**  
 Beckton Minola U630 NB

**DAM**  
 Age 2  
 Wt 875  
 Prog.BW 62  
 WR 105  
 YR 102  
 Wean Pct. 48%  
 Cow Eff. 102

RAAA HerdBuilder index: **187** (Top 2% of all RA bulls)  
 RAAA GridMaster index: **52** (Top 12% of all RA bulls)  
 Calv.Ease BW WW YW Milk HPG Stay Maint.En.  
 EPDs **13 -5.5 51 84 20 9.8 17 -2.6**  
 Marb **+0.47** REA **-0.04** Bfat **+0.03**

★★★★★ for Low Maintenance, Marbling, Calving Ease, Stayability.

• Bulls •

**228** BECKTON LEGEND B644 W2  
1-A 100% # 1706123 Tat.: BKT4 B644



Birth: 4-7-14

Beckton Lancer F442 T  
Beckton Lancer T A664  
Bkt Suffeina A828 DM

**BECKTON LEGEND S670**  
Ref. L-1  
Beckton Kit F468 JL  
Beckton Julian GG B571  
Beckton Kit A517 NP

Beckton Warrior T248 L5  
Beckton Warrior N645 T1  
Beckton Kit R503 LN

**BECKTON LANA Y420 W**  
Beckton Lana T211 JL  
Beckton Julian G2 M345  
Beckton Lana G592 LN

BWt	57
WR	96
ADG	3.65
YWt	1090
YR	102
Scr.	33
Fr.	5.0

**DAM**  
Age 3  
Wt 896  
Prog.BW 57  
WR 99  
YR 103  
Wean Pct. 52%  
Cow Eff. 109

RAAA HerdBuilder index: **195** (Top 2% of all RA bulls)  
RAAA GridMaster index: **53** (Top 11% of all RA bulls)

Calv.Ease	BW	WW	YW	Milk	HPG	Stay	Maint.En.	
EPDs	11	-6.5	43	66	13	10	17	-13.3

Marb **+0.67** REA **+0.33** Bfat **+0.02**

★★★★★ for Low Maintenance, Marbling, Rib-eye area, Calving Ease, Stayability.

**231** BECKTON ACCENT B788 C2  
1-A 100% # 1705454 Tat.: BSF4 B788



Birth: 4-22-14

Beckton Cody K1 P014  
Beckton Rose M126 WR  
Beckton Cherokee N N479

**BECKTON ACCENT U777 C2**  
Ref. A-1  
Beckton Susan R022 CQ  
Beckton Susan N023 JE  
BFCK Cherokee Cnyn 4912

Beckton Cherokee N N479  
Beckton Dinah C440 NM  
Beckton Jules L429

**BECKTON MONA R198 CQ**  
Beckton Mona N009 JE  
Beckton Mona L618 LR

BWt	66
WR	97
ADG	3.82
YWt	1060
YR	96
Scr.	35
Fr.	5.5

**DAM**  
Age 9  
Wt 1244  
Prog.BW 65  
WR 105  
YR 106  
Wean Pct. 41%  
Cow Eff. 86

RAAA HerdBuilder index: **163** (Top 8% of all RA bulls)  
RAAA GridMaster index: **53** (Top 7% of all RA bulls)

Calv.Ease	BW	WW	YW	Milk	HPG	Stay	Maint.En.	
EPDs	13	-7.3	41	65	30	12	14	-4.3

Marb **+0.60** REA **+0.16** Bfat **+0.03**

★★★★★ for Low Maintenance, Marbling, Rib-eye area, Superior Cow, Calving Ease, Stayability.

**229** BECKTON CLIFFTOP B821 A5  
1-A 100% # 1705588 Tat.: BSF4 B821



Birth: 4-26-14

Beckton Clifftop W692 E3  
Beckton Lydia S274 EP  
BKT Clifftop TP R288

**BECKTON CLIFFTOP Y012 C4**  
Ref. C-2  
Beckton Lana W240 C  
Beckton Lana L923 CD  
Beckton Cody K1 P014

Beckton Accent U777 C2  
Beckton Susan R022 CQ  
Beckton Julian G3 P608

**BECKTON MINOLA X198 A**  
Beckton Minola U378 JL  
Beckton Minola M155 CE

BWt	75
WR	97
ADG	3.82
YWt	1104
YR	100
Scr.	34
Fr.	5.5

**DAM**  
Age 4  
Wt 892  
Prog.BW 65  
WR 102  
YR 96  
Wean Pct. 58%  
Cow Eff. 123

RAAA HerdBuilder index: **193** (Top 2% of all RA bulls)  
RAAA GridMaster index: **51** (Top 26% of all RA bulls)

Calv.Ease	BW	WW	YW	Milk	HPG	Stay	Maint.En.	
EPDs	12	-4.5	46	77	27	12	17	-10.5

Marb **+0.51** REA **+0.02** Bfat **+0.02**

★★★★★ for Low Maintenance, Marbling, High Cow Efficiency, Calving Ease, Stayability.

**232** BECKTON LIKABLE B559 N4  
1-A 100% # 1706122 Tat.: BKT4 B559



Birth: 4-1-14

Beckton Likable U130 L2  
Beckton Likable S633  
Beckton Kit S478 LN

**BECKTON LIKABLE Y124 L3**  
Ref. L-3  
BKT Pine Marie S802 LO  
Beckton Lasso P741  
BKT Pine Marie P475 LN

Beckton Nebula U206 V3  
Beckton Minerva J615 VG  
Beckton Epic K4 N795

**BECKTON CHRISTY Y413 N**  
Beckton Christy S475 EP  
Beckton Christy L654 JL

BWt	65
WR	92
ADG	3.93
YWt	1039
YR	98
Scr.	35
Fr.	5.0

**DAM**  
Age 3  
Wt 1076  
Prog.BW 59  
WR 96  
YR 98  
Wean Pct. 41%  
Cow Eff. 86

RAAA HerdBuilder index: **164** (Top 8% of all RA bulls)  
RAAA GridMaster index: **53** (Top 10% of all RA bulls)

Calv.Ease	BW	WW	YW	Milk	HPG	Stay	Maint.En.	
EPDs	12	-5.2	49	83	21	9	15	-0.3

Marb **+0.61** REA **+0.13** Bfat **+0.04**

★★★★★ for Low Maintenance, Marbling, Rib-eye area, Calving Ease, Stayability.

**230** BECKTON EPIC B250 N7  
1-A 100% # 1706152 Tat.: BKT4 B250



Birth: 3-17-14

Beckton Epic U749 D5  
Beckton Denise R308 DM  
Beckton Epic K6 S569

**BECKTON EPIC Z674 E6**  
Ref. E-7  
Beckton Indigo U504 EP  
Beckton Indigo S016 NB  
Beckton Nebula T398 V3

Beckton Nebula X603 J4  
Beckton Firefly T003 JC  
Beckton Hasten H S462

**BECKTON ENCINO Z033 N**  
Beckton Encino X243 H  
Beckton Encino G238 BR

BWt	59
WR	100
ADG	4.10
YWt	1033
YR	100
Scr.	32
Fr.	5.0

**DAM**  
Age 2  
Wt 876  
Prog.BW 59  
WR 100  
YR 100  
Wean Pct. 46%  
Cow Eff. 97

RAAA HerdBuilder index: **171** (Top 5% of all RA bulls)  
RAAA GridMaster index: **53** (Top 10% of all RA bulls)

Calv.Ease	BW	WW	YW	Milk	HPG	Stay	Maint.En.	
EPDs	12	-6.0	45	78	25	9	15	-4.2

Marb **+0.59** REA **+0.10** Bfat **+0.03**

★★★★★ for Low Maintenance, Gainability, Marbling, Calving Ease, Stayability.

**233** BECKTON EMPEROR B049 W4  
1-A 100% # 1706295 Tat.: BKT4 B049



Birth: 2-19-14

Beckton Emperor T641 E2  
Beckton Emperor R100  
Beckton Vernice R416 EP

**BECKTON EMPEROR Z750 N3**  
Ref. E-8  
Beckton Lana U789 NB  
Beckton Nebula M045  
Beckton Lana P073 EP

Beckton Warrior T248 L5  
Beckton Warrior N645 T1  
Beckton Kit R503 LN

**BECKTON LANA Z915 W**  
Beckton Lana W712 N  
Beckton Nebula T269 E2  
Beckton Lana T817 CT

BWt	58
WR	91
ADG	3.76
YWt	976
YR	94
Scr.	33
Fr.	5.0

**DAM**  
Age 2  
Wt 758  
Prog.BW 58  
WR 91  
YR 94  
Wean Pct. 51%  
Cow Eff. 108

RAAA HerdBuilder index: **165** (Top 7% of all RA bulls)  
RAAA GridMaster index: **51** (Top 24% of all RA bulls)

Calv.Ease	BW	WW	YW	Milk	HPG	Stay	Maint.En.	
EPDs	11	-5.7	42	74	20	8	15	-4.8

Marb **+0.44** REA **-0.10** Bfat **+0.03**

★★★★★ for Low Maintenance, Marbling, Calving Ease, Stayability.

• Bulls •

**234** BECKTON EMCEE B774 N3  
1-A 100% # 1705605 Tat.: BSF4 B774



Birth: 4-20-14

Beckton Emcee S466  
Beckton Larkaba P645 JL

**BECKTON EMCEE W526 J2**  
Ref. E

Beckton Larkaba H798 WR  
Beckton Julian GG B571  
Beckton Larkaba L312 LN  
Beckton Nebula L P093  
Beckton Minerva J615 VG  
BKT Clifftop TP R288  
Beckton Angel R155 CT

**BECKTON ANGEL X450 N**

**DAM**  
Age 4  
Wt 1060  
Prog. BW 65  
WR 101  
YR 101  
Wean Pct. 46%  
Cow Eff. 96

RAAA HerdBuilder index: **172** (Top 5% of all RA bulls)  
RAAA GridMaster index: **52** (Top 13% of all RA bulls)

Calv. Ease	BW	WW	YW	Milk	HPG	Stay	Maint. En.
EPDs 14	-6.5	38	58	24	10	15	-6.0

Marb **+0.69** REA **+1.18** Bfat **+0.2**

BWt **69**  
WR **96**  
ADG **3.93**  
Ywt. **1053**  
YR **95**  
Scr. **42**  
Fr. **5.5**

**236** BECKTON SCAMP B702 N4  
1-A 100% # 1706062 Tat.: BKT4 B702



Birth: 4-12-14

Beckton Scamp T A825  
Beckton Lana S074 EP

**BECKTON SCAMP X494 E3**  
Ref. S-1

Beckton Scamp 8954  
Bkt Encino 8459 TJ  
Beckton Epic KH P678  
Beckton Lana P317 JL  
Beckton Nebula P P707  
Beckton Lana P685 JO  
TR Julian RT561  
BKT Pine Marie R456 LO

**BKT PINE MARIE X596 N**

**DAM**  
Age 4  
Wt 1026  
Prog. BW 67  
WR 102  
YR 103  
Wean Pct. 47%  
Cow Eff. 100

RAAA HerdBuilder index: **159** (Top 10% of all RA bulls)  
RAAA GridMaster index: **52** (Top 21% of all RA bulls)

Calv. Ease	BW	WW	YW	Milk	HPG	Stay	Maint. En.
EPDs 12	-4.0	55	87	18	8	14	-2.3

Marb **+0.43** REA **-0.03** Bfat **+0.00**

BWt **75**  
WR **96**  
ADG **3.37**  
Ywt. **1038**  
YR **94**  
Scr. **33**  
Fr. **5.5**

★★★★★ for Low Maintenance, Marbling, Rib-eye area, Calving Ease, Stayability.

★★★★★ for Low Maintenance, Marbling, Calving Ease, Stayability.

**235** BECKTON CARDINAL B228 N  
1-A 100% # 1705683 Tat.: BSF4 B228



Birth: 3-16-14

TR Ricardo DOS  
Beckton Lana U182 JC

**TR DOUBLE EAGLE ZT220**  
Ref. C-4

BFCK Cherokee Cnyn 4912  
TR Dyna LT111  
Beckton Justice C1 R483  
Beckton Lana H544 WR  
Beckton Nebula T398 V3  
Beckton Firefly T003 JC  
Beckton Hasten H S462  
Beckton Dinah R328 JE

**BECKTON DINAH Z016 N**

**DAM**  
Age 2  
Wt 908  
Prog. BW 60  
WR 102  
YR 99  
Wean Pct. 45%  
Cow Eff. 95

RAAA HerdBuilder index: **183** (Top 3% of all RA bulls)  
RAAA GridMaster index: **53** (Top 8% of all RA bulls)

Calv. Ease	BW	WW	YW	Milk	HPG	Stay	Maint. En.
EPDs 14	-6.4	53	84	22	12	7.8	-7.4

Marb **+0.50** REA **+0.31** Bfat **+0.03**

BWt **60**  
WR **102**  
ADG **3.48**  
Ywt. **1024**  
YR **99**  
Scr. **35**  
Fr. **5.0**

★★★★★ for Low Maintenance, Marbling, Rib-eye area, Calving Ease.

**237** BECKTON SCAMP B751 N4  
1-A 100% # 1706120 Tat.: BKT4 B751



Birth: 4-17-14

Beckton Scamp T A825  
Beckton Lana S074 EP

**BECKTON SCAMP X494 E3**  
Ref. S-1

Beckton Scamp 8954  
Bkt Encino 8459 TJ  
Beckton Epic KH P678  
Beckton Lana P317 JL  
Beckton Nebula L P093  
Beckton Minerva J615 VG  
Beckton Lancer T7 M089  
Beckton Lakme M669 EP

**BECKTON LAKME Y400 N**

**DAM**  
Age 3  
Wt 968  
Prog. BW 62  
WR 106  
YR 102  
Wean Pct. 54%  
Cow Eff. 114

RAAA HerdBuilder index: **163** (Top 8% of all RA bulls)  
RAAA GridMaster index: **50** (Top 44% of all RA bulls)

Calv. Ease	BW	WW	YW	Milk	HPG	Stay	Maint. En.
EPDs 10	-4.2	51	80	25	11	15	-5.5

Marb **+0.30** REA **+0.10** Bfat **-0.01**

BWt **NA**  
WR **107**  
ADG **3.60**  
Ywt. **1061**  
YR **98**  
Scr. **35**  
Fr. **5.5**

★★★★★ for Low Maintenance, Marbling, Calving Ease, Stayability.



**238** BECKTON NEW ERA B280 L2  
1-A 100% # 1705800 Tat.: BKT4 B280



Birth: 3-19-14

Beckton Nebula P P707  
BKT Larkeisa T310 JC

**BECKTON NEW ERA Y194**  
Ref. N-6

Beckton Nebula M045  
Beckton Lana M809 EP  
Beckton Justice C1 R483  
BKT Larkeisa R775 JC  
Beckton Lancer TZ D525  
Beckton Vernice D121 VG  
Beckton Warrior C C355  
Beckton Emera D880 CB

**BECKTON EMERA P378 LN**

**DAM**  
Age 10  
Wt 1226  
Prog. BW 69  
WR 99  
YR 98  
Wean Pct. 35%  
Cow Eff. 74

RAAA HerdBuilder index: **177** (Top 4% of all RA bulls)  
RAAA GridMaster index: **53** (Top 10% of all RA bulls)

Calv. Ease	BW	WW	YW	Milk	HPG	Stay	Maint. En.
EPDs 11	-3.9	56	92	19	11	15	-4.6

Marb **+0.49** REA **-0.26** Bfat **+0.01**

BWt **76**  
WR **82**  
ADG **3.82**  
Ywt. **937**  
YR **85**  
Scr. **32**  
Fr. **5.0**

★★★★★ for Low Maintenance, Marbling, Calving Ease, Stayability.

• Bulls •

**239** **BSF EPIC B771 H7** 

1-B 99% # 1705587 Tat.: BSF4 B771

Birth: 4-19-14

Beckton Epic T330 L5  
Beckton Epic K4 N795  
Beckton Belga K202 LN  
Beckton Lancer F442 T  
Beckton Kit F468 JL  
Beckton Heritage N013  
Beckton Coca P602 JL  
Beckton Loki C M740  
Beckton Regus F700

**BECKTON EPIC X330 L6**  
Ref. E-2  
Beckton Kit R503 LN

**BSF LOKETTA X132 H**  
Beckton Heritage T270 J2  
Beckton Coca P602 JL  
Beckton Loki C M740  
BSF Loketta R368 LO  
BSF Regus F700

DAM
Age 4
Wt 1124
Prog.BW 71
WR 106
YR 106
Wean Pct. 47%
Cow Eff. 99

RAAA HerdBuilder index: **151** (Top 14% of all RA bulls)  
RAAA GridMaster index: **53** (Top 6% of all RA bulls)

Calv.Ease	BW	WW	YW	Milk	HPG	Stay	Maint.En.	
EPDs	9	-3.7	59	94	21	6	14	-2.8

Marb **+0.69** REA **+0.20** Bfat **+0.04**

★★★★★ for Low Maintenance, Marbling, Rib-eye area, Superior Cow, Calving Ease, Stayability.

**241** **BSF NEW ERA B797 W2** 

1-B 99% # 1705618 Tat.: BSF4 B797

Birth: 4-23-14

Beckton Nebula P P707  
Beckton Nebula M045  
Beckton Lana M809 EP  
Beckton Justice C1 R483  
Beckton Kit R503 LN  
Beckton Warrior N645 T1  
Beckton Kit R503 LN  
Beckton Juno N493  
Beckton Regus M563 EP

**BECKTON NEW ERA Y194**  
Ref. N-6  
BKT Larkeisa T310 JC  
BKT Larkeisa R775 JC

**BSF JUNE X567 W**  
Beckton Warrior T248 L5  
BSF June S698 JJ  
Beckton Regus M563 EP

DAM
Age 4
Wt 1156
Prog.BW 67
WR 111
YR 102
Wean Pct. 47%
Cow Eff. 99

RAAA HerdBuilder index: **177** (Top 4% of all RA bulls)  
RAAA GridMaster index: **54** (Top 3% of all RA bulls)

Calv.Ease	BW	WW	YW	Milk	HPG	Stay	Maint.En.	
EPDs	11	-5.8	59	96	21	9	14	-6.2

Marb **+0.57** REA **-0.07** Bfat **+0.03**

★★★★★ for Low Maintenance, Marbling, Calving Ease, Stayability.

**240** **BSF CLIFFTOP B729 C4** 

1-B 99% # 1728948 Tat.: BSF4 B729

Birth: 4-15-14

BKT Clifftop TP R288  
Beckton Clifftop T C075  
Beckton Christy K209 CO  
Beckton Epic KM M115  
Beckton Lydia M607 LO  
BFCK Cherokee Cryn 4912  
Beckton Dinah C440 NM  
Beckton Herald FJ J776  
BSF Regus C791

**BECKTON CLIFFTOP W692 E3**  
Ref. C-1  
Beckton Lydia S274 EP

**BSF HELENA R016 CQ**  
Beckton Cherokee N N479  
BSF Helena N186 HR

DAM
Age 9
Wt 1236
Prog.BW 63
WR 100
YR 100
Wean Pct. 40%
Cow Eff. 85

RAAA HerdBuilder index: **155** (Top 11% of all RA bulls)  
RAAA GridMaster index: **53** (Top 8% of all RA bulls)

Calv.Ease	BW	WW	YW	Milk	HPG	Stay	Maint.En.	
EPDs	11	-5.6	46	76	25	13	14	-2.3

Marb **+0.56** REA **-0.04** Bfat **+0.05**

★★★★★ for Low Maintenance, Marbling, Calving Ease, Stayability.

**242** **BSF EMPEROR B145 S4** 

1-B 99% # 1705759 Tat.: BSF4 B145

Birth: 3-5-14

Beckton Emperor T641 E2  
Beckton Emperor R100  
Beckton Vernice R416 EP  
Beckton Nebula M045  
Beckton Lana P073 EP  
Beckton Scamp T A825  
BKT Pine Marie R401 HU  
Beckton Emperor T641 E2  
BSF Laurel T171 HT

**BECKTON EMPEROR Z750 N3**  
Ref. E-8  
Beckton Lana U789 NB

**BSF LAUREL Z687 S**  
Beckton Scamp X458 H3  
BSF Laurel W170 E

DAM
Age 2
Wt 790
Prog.BW 57
WR 94
YR 96
Wean Pct. 47%
Cow Eff. 99

RAAA HerdBuilder index: **160** (Top 10% of all RA bulls)  
RAAA GridMaster index: **52** (Top 18% of all RA bulls)

Calv.Ease	BW	WW	YW	Milk	HPG	Stay	Maint.En.	
EPDs	14	-6.9	41	72	21	8	13	-5.8

Marb **+0.44** REA **-0.08** Bfat **+0.03**

★★★★★ for Low Maintenance, Marbling, Calving Ease, Stayability.



**243** **BSF EPIC B726 E6** 

1-B 99% # 1728945 Tat.: BSF4 B726

Birth: 4-14-14

Beckton Epic K4 N795  
Beckton Epic KJ J722  
Beckton Sierra J789 EP  
Beckton Dominor ZC M919  
Beckton Denise L639 JL  
Beckton Epic K F075  
Beckton Minerva F495 CH  
Beckton Epic K F075  
BSF Regus H508

**BECKTON EPIC U749 D5**  
Ref. E-1  
Beckton Denise R308 DM

**BSF EPIQUETTE R729 EP**  
Beckton Epic KM M115  
BSF Regus M602 EP

DAM
Age 9
Wt 1022
Prog.BW 72
WR 101
YR 101
Wean Pct. 41%
Cow Eff. 87

RAAA HerdBuilder index: **127** (Top 33% of all RA bulls)  
RAAA GridMaster index: **50** (Top 41% of all RA bulls)

Calv.Ease	BW	WW	YW	Milk	HPG	Stay	Maint.En.	
EPDs	8	-2.0	54	96	22	9	12	-1.4

Marb **+0.45** REA **+0.15** Bfat **+0.04**

★★★★★ for Low Maintenance, Marbling, Rib-eye area, Calving Ease.

• Bulls •

**244** **BSF EPIC B631 J7** 

1-B 99% # 1705640 Tat.: BSF4 B631

Birth: 4-6-14

Beckton Epic T330 L5  
**BECKTON EPIC X330 L6**  
 Ref. E-2  
 Beckton Kit R503 LN

Beckton Epic K4 N795  
 Beckton Belga K202 LN  
 Beckton Lancer F442 T  
 Beckton Kit F468 JL  
 Beckton Julian G5 S107  
 Beckton Kit L399 HR  
 Beckton Nebula H R233  
 BSF Lanette P615

BWt **54**  
 WR **90**  
 ADG **3.65**  
 YWt **1000**  
 YR **92**  
 Scr. **32**  
 Fr. **5.0**

Beckton Julian W743 H5  
**BSF LANETTE Y054 J**  
 BSF Lanette W106 N

DAM	
Age	3
Wt	928
Prog.BW	54
WR	99
YR	94
Wean Pct.	45%
Cow Eff.	95

RAAA HerdBuilder index: **179** (Top 4% of all RA bulls)  
 RAAA GridMaster index: **53** (Top 5% of all RA bulls)

Calv.Ease	BW	WW	YW	Milk	HPG	Stay	Maint.En.	
EPDs	<b>12</b>	<b>-7.6</b>	<b>42</b>	<b>72</b>	<b>21</b>	<b>11</b>	<b>15</b>	<b>-3.4</b>

Marb **+0.63** REA **+0.08** Bfat **+0.03**

★★★★★ for Low Maintenance, Marbling, Calving Ease, Stayability.

**247** **BECKTON LOKI B695 E5** 

1-A 100% # 1706018 Tat.: BKT4 B695

Birth: 4-11-14

Beckton Loki CL S284  
**BECKTON LOKI X507 L4**  
 Ref. L  
 Beckton Lana L538 LN

Beckton Loki C M740  
 Beckton Lakme J460 LT  
 Beckton Lancer TL G626  
 Beckton Lana G514 CD  
 Beckton Epic K4 N795  
 Beckton Denise R308 DM  
 Beckton Epic K4 N795  
 Beckton Indigo H150 LN

BWt **79**  
 WR **86**  
 ADG **3.60**  
 YWt **1021**  
 YR **93**  
 Scr. **34**  
 Fr. **5.0**

Beckton Epic U749 D5  
**BECKTON INDIGO X066 E**  
 Beckton Indigo U258 EP

DAM	
Age	4
Wt	1122
Prog.BW	69
WR	94
YR	93
Wean Pct.	39%
Cow Eff.	81

RAAA HerdBuilder index: **133** (Top 27% of all RA bulls)  
 RAAA GridMaster index: **50** (Top 39% of all RA bulls)

Calv.Ease	BW	WW	YW	Milk	HPG	Stay	Maint.En.	
EPDs	<b>12</b>	<b>-3.7</b>	<b>41</b>	<b>71</b>	<b>18</b>	<b>4</b>	<b>13</b>	<b>1.3</b>

Marb **+0.62** REA **+0.14** Bfat **+0.02**

★★★★★ for Low Maintenance, Marbling, Rib-eye area, Calving Ease, Stayability.

**245** **BECKTON WARRIOR B442 N5** 

1-A 100% # 1705464 Tat.: BSF4 B442

Birth: 3-26-14

Beckton Warrior C1 S337  
**BECKTON WARRIOR W534 N4**  
 Ref. W  
 BKT Larkeisa S055 NB

Beckton Warrior CL M686  
 Beckton Christy K101 CD  
 Beckton Nebula P P707  
 Beckton Larkeisa P688 CH  
 Beckton Nebula M045  
 Beckton Lana M809 EP  
 Beckton Champ R3 H338  
 Beckton Lana F483 ZN

BWt **63**  
 WR **79**  
 ADG **3.37**  
 YWt. **968**  
 YR **88**  
 Scr. **34**  
 Fr. **4.5**

Beckton Nebula P P707  
**BECKTON LANA S034 NB**  
 Beckton Lana P368 CH

DAM	
Age	8
Wt	NA
Prog.BW	72
WR	100
YR	103
Wean Pct.	NA%
Cow Eff.	NA

RAAA HerdBuilder index: **183** (Top 3% of all RA bulls)  
 RAAA GridMaster index: **53** (Top 7% of all RA bulls)

Calv.Ease	BW	WW	YW	Milk	HPG	Stay	Maint.En.	
EPDs	<b>15</b>	<b>-8.0</b>	<b>34</b>	<b>58</b>	<b>19</b>	<b>11</b>	<b>15</b>	<b>-3.9</b>

Marb **+0.70** REA **+0.01** Bfat **+0.03**

★★★★★ for Low Maintenance, Marbling, Calving Ease, Stayability.

**248** **BECKTON CLIFFTOP B226 N5** 

1-A 100% # 1706261 Tat.: BKT4 B226

Birth: 3-16-14

Beckton Clifftop W577 E3  
**BECKTON CLIFFTOP Z824 C4**  
 Ref. C-3  
 Beckton Tamara R175 CQ

BKT Clifftop TP R288  
 BKT Pine Marie R213 EP  
 Beckton Cherokee N N479  
 Beckton Tamara N765 CO  
 Beckton Nebula P P707  
 Beckton Minerva J615 VG  
 Beckton Nebula L P093  
 Beckton Rose L311 LN

BWt **67**  
 WR **103**  
 ADG **3.48**  
 YWt. **980**  
 YR **94**  
 Scr. **31**  
 Fr. **5.0**

Beckton Nebula U206 V3  
**BECKTON ROSE Z729 N**  
 Beckton Rose W402 N

DAM	
Age	2
Wt	796
Prog.BW	67
WR	103
YR	94
Wean Pct.	52%
Cow Eff.	110

RAAA HerdBuilder index: **195** (Top 2% of all RA bulls)  
 RAAA GridMaster index: **52** (Top 18% of all RA bulls)

Calv.Ease	BW	WW	YW	Milk	HPG	Stay	Maint.En.	
EPDs	<b>8</b>	<b>-3.1</b>	<b>52</b>	<b>81</b>	<b>24</b>	<b>12</b>	<b>19</b>	<b>-3.7</b>

Marb **+0.52** REA **+0.14** Bfat **+0.02**

★★★★★ for Low Maintenance, Marbling, Rib-eye area, Calving Ease, Stayability.

**246** **BECKTON NOMAD B318 L3** 

1-A 100% # 1705594 Tat.: BSF4 B318

Birth: 3-21-14

Beckton Nomad 7496  
**BECKTON NOMAD V 9871**  
 Ref. V  
 Bkt Barmaid 6986 VR

Beckton Neva 5562  
 Bkt Bolt Tamrck 3913  
 Beckton Varo 5642  
 Bkt Lahrogno-3  
 Beckton Lancer F442 T  
 Beckton Coca F276 HV  
 Beckton Vega P079  
 Beckton Tamara P579 VG

BWt **74**  
 WR **87**  
 ADG **3.20**  
 YWt. **948**  
 YR **86**  
 Scr. **32**  
 Fr. **5.0**

Beckton Lancer T371 H4  
**BECKTON TAMARA X235 L**  
 Beckton Tamara S694 VA

DAM	
Age	4
Wt	1584
Prog.BW	70
WR	97
YR	94
Wean Pct.	28%
Cow Eff.	58

RAAA HerdBuilder index: **101** (Top 65% of all RA bulls)  
 RAAA GridMaster index: **50** (Top 47% of all RA bulls)

Calv.Ease	BW	WW	YW	Milk	HPG	Stay	Maint.En.	
EPDs	<b>13</b>	<b>-5.1</b>	<b>40</b>	<b>53</b>	<b>21</b>	<b>7</b>	<b>8</b>	<b>0.1</b>

Marb **+0.35** REA **-0.01** Bfat **-0.02**

★★★★★ for Low Maintenance, Marbling, Calving Ease.

**249** **BECKTON NEBULA B098 L5** 

1-A 100% # 1706200 Tat.: BKT4 B098

Birth: 2-27-14

Beckton Nebula X353 E3  
**BECKTON NEBULA Z180 H4**  
 Ref. N-8  
 Beckton Mona X817 H

Beckton Nebula G S237  
 Beckton Lana R058 EP  
 Beckton Heritage T270 J2  
 Beckton Mona T794 CD  
 Beckton Likable S633  
 Beckton Lana S718 LN  
 Beckton Julian G3 P608  
 Beckton Encino P733 HU

BWt **55**  
 WR **84**  
 ADG **3.88**  
 YWt. **981**  
 YR **94**  
 Scr. **33**  
 Fr. **5.0**

Beckton Likable U120 L2  
**BECKTON ENCINO Z315 L**  
 Beckton Encino S566 JL

DAM	
Age	2
Wt	862
Prog.BW	55
WR	84
YR	94
Wean Pct.	41%
Cow Eff.	87

RAAA HerdBuilder index: **159** (Top 10% of all RA bulls)  
 RAAA GridMaster index: **52** (Top 13% of all RA bulls)

Calv.Ease	BW	WW	YW	Milk	HPG	Stay	Maint.En.	
EPDs	<b>13</b>	<b>-6.7</b>	<b>48</b>	<b>81</b>	<b>18</b>	<b>8</b>	<b>14</b>	<b>-0.8</b>

Marb **+0.58** REA **+0.33** Bfat **+0.01**

★★★★★ for Low Maintenance, Marbling, Rib-eye area, Calving Ease, Stayability.

• Bulls •

**250** **BECKTON LEGEND B619 J4**   
 1-A 100% # 1706194 Tat.: BKT4 B619  
 Birth: 4-5-14

Beckton Legend X561 J2	Beckton Legend S670	BWt	<b>70</b>
Beckton Lana T279 JO	Beckton Lana T279 JO	WR	<b>111</b>
Beckton Julian G5 S107	Beckton Julian G5 S107	ADG	<b>2.81</b>
Beckton Larkaba W868 J	Beckton Larkaba S663 JE	YWt.	<b>1007</b>
Beckton Julian U699 L5	Beckton Julian G1 J526	YR	<b>97</b>
Beckton Rose L311 LN	Beckton Rose L311 LN	Scr.	<b>32</b>
Beckton Epic K F075	Beckton Epic K F075	Fr.	<b>5.5</b>
Bkt Pine Marie D126 JL	Bkt Pine Marie D126 JL		

**BECKTON LEGEND Z689 J3**  
 Ref. L-4

**BKT PINE MARIE Z286 J**  
 BKT Pine Marie M119 EP

<b>DAM</b>	
Age	2
Wt	780
Prog.BW	70
WR	111
YR	97
Wean Pct.	63%
Cow Eff.	132

RAAA HerdBuilder index: **191** (Top 2% of all RA bulls)  
 RAAA GridMaster index: **53** (Top 7% of all RA bulls)

Calv.Ease	BW	WW	YW	Milk	HPG	Stay	Maint.En.
EPDs	<b>11</b>	<b>-3.1</b>	<b>60</b>	<b>91</b>	<b>20</b>	<b>10</b>	<b>16</b>
Marb	<b>+.58</b>	REA	<b>+.05</b>	Bfat	<b>+.04</b>		

**252** **BECKTON ACCENT B132 N4**   
 1-A 100% # 1706259 Tat.: BKT4 B132  
 Birth: 3-4-14

Beckton Accent W180 C2	Beckton Cody K1 P014	BWt	<b>60</b>
Beckton Christy R046 CQ	Beckton Christy R046 CQ	WR	<b>97</b>
Beckton Julian L233	Beckton Julian L233	ADG	<b>3.71</b>
Beckton Susan P857 JO	Beckton Susan G199 CO	YWt.	<b>1004</b>
Beckton Nebula U206 V3	Beckton Nebula P P707	YR	<b>97</b>
Beckton Minerva J615 VG	Beckton Minerva J615 VG	Scr.	<b>30</b>
Beckton Action T061 D1	Beckton Action T061 D1	Fr.	<b>4.5</b>
Beckton Coca T499 SC	Beckton Coca T499 SC		

**BECKTON ACCENT Z506 J3**  
 Ref. A-5

**BECKTON COCA Z713 N**  
 Beckton Coca W107 A

<b>DAM</b>	
Age	2
Wt	804
Prog.BW	60
WR	97
YR	97
Wean Pct.	48%
Cow Eff.	102

RAAA HerdBuilder index: **189** (Top 2% of all RA bulls)  
 RAAA GridMaster index: **53** (Top 9% of all RA bulls)

Calv.Ease	BW	WW	YW	Milk	HPG	Stay	Maint.En.
EPDs	<b>13</b>	<b>-5.6</b>	<b>52</b>	<b>83</b>	<b>24</b>	<b>9</b>	<b>17</b>
Marb	<b>+.56</b>	REA	<b>+.09</b>	Bfat	<b>+.04</b>		

★★★★★ for Low Maintenance, Marbling, High Cow Efficiency, Calving Ease, Stayability.

★★★★★ for Low Maintenance, Marbling, Calving Ease, Stayability.



**253** **BECKTON ACCENT B107 N3**   
 1-A 100% # 1705739 Tat.: BSF4 B107  
 Birth: 2-27-14

Beckton Accent W180 C2	Beckton Cody K1 P014	BWt	<b>64</b>
Beckton Christy R046 CQ	Beckton Christy R046 CQ	WR	<b>89</b>
Beckton Julian L233	Beckton Julian L233	ADG	<b>3.88</b>
Beckton Susan P857 JO	Beckton Susan G199 CO	YWt.	<b>961</b>
Beckton Nebula U206 V3	Beckton Nebula P P707	YR	<b>93</b>
Beckton Minerva J615 VG	Beckton Minerva J615 VG	Scr.	<b>33</b>
Beckton Loki C M740	Beckton Loki C M740	Fr.	<b>5.0</b>
Beckton Larkaba R357 LO	Beckton Larkaba F394 VG		

**BECKTON ACCENT Z506 J3**  
 Ref. A-5

**BECKTON LARKABA Z446 N**  
 Beckton Larkaba R357 LO

<b>DAM</b>	
Age	2
Wt	990
Prog.BW	64
WR	89
YR	93
Wean Pct.	35%
Cow Eff.	74

RAAA HerdBuilder index: **170** (Top 6% of all RA bulls)  
 RAAA GridMaster index: **52** (Top 14% of all RA bulls)

Calv.Ease	BW	WW	YW	Milk	HPG	Stay	Maint.En.
EPDs	<b>9</b>	<b>-3.4</b>	<b>58</b>	<b>90</b>	<b>21</b>	<b>8</b>	<b>17</b>
Marb	<b>+.41</b>	REA	<b>-.03</b>	Bfat	<b>+.03</b>		

★★★★★ for Low Maintenance, Marbling, Calving Ease, Stayability.

**251** **BECKTON EPIC B587 W7**   
 1-A 100% # 1706117 Tat.: BKT4 B587  
 Birth: 4-3-14

Beckton Epic T330 L5	Beckton Epic K4 N795	BWt	<b>77</b>
Beckton Belga K202 LN	Beckton Belga K202 LN	WR	<b>103</b>
Beckton Lancer F442 T	Beckton Lancer F442 T	ADG	<b>3.32</b>
Beckton Kit F468 JL	Beckton Kit F468 JL	YWt.	<b>1000</b>
Beckton Warrior N645 T1	Beckton Warrior N645 T1	YR	<b>92</b>
Beckton Kit R503 LN	Beckton Kit R503 LN	Scr.	<b>36</b>
Beckton Hawk P248	Beckton Hawk P248	Fr.	<b>5.0</b>
Beckton Belga P443 JO	Beckton Belga P443 JO		

**BECKTON EPIC X330 L6**  
 Ref. E-2

**BECKTON BELGA Y383 W**  
 Beckton Belga S166 HW

<b>DAM</b>	
Age	3
Wt	1000
Prog.BW	76
WR	99
YR	92
Wean Pct.	48%
Cow Eff.	101

RAAA HerdBuilder index: **146** (Top 16% of all RA bulls)  
 RAAA GridMaster index: **51** (Top 30% of all RA bulls)

Calv.Ease	BW	WW	YW	Milk	HPG	Stay	Maint.En.
EPDs	<b>8</b>	<b>-1.2</b>	<b>61</b>	<b>96</b>	<b>16</b>	<b>8</b>	<b>13</b>
Marb	<b>+.55</b>	REA	<b>+.17</b>	Bfat	<b>+.01</b>		

★★★★★ for Low Maintenance, Marbling, Rib-eye area, Calving Ease, Stayability.

**254** **BECKTON NEBULA B393 A2**   
 1-A 100% # 1706133 Tat.: BKT4 B393  
 Birth: 3-25-14

Beckton Neptune R2 K065	Beckton Neptune RR B284	BWt	<b>60</b>
Beckton Lana C735 TP	Beckton Lana C735 TP	WR	<b>88</b>
Beckton Julian GG B571	Beckton Julian GG B571	ADG	<b>3.54</b>
Beckton Belga G493 HR	Beckton Belga G493 HR	YWt.	<b>1017</b>
Beckton Cody K1 P014	Beckton Cody K1 P014	YR	<b>94</b>
Beckton Susan R022 CQ	Beckton Susan R022 CQ	Scr.	<b>32</b>
Beckton Justice C1 R483	Beckton Justice C1 R483	Fr.	<b>5.0</b>
Beckton Freyja M659 WR	Beckton Freyja M659 WR		

**BECKTON NEBULA M045**  
 Ref. N-1

**BECKTON FREYJA Y544 A**  
 Beckton Freyja U464 JC

<b>DAM</b>	
Age	3
Wt	1018
Prog.BW	60
WR	88
YR	94
Wean Pct.	40%
Cow Eff.	84

RAAA HerdBuilder index: **191** (Top 2% of all RA bulls)  
 RAAA GridMaster index: **52** (Top 13% of all RA bulls)

Calv.Ease	BW	WW	YW	Milk	HPG	Stay	Maint.En.
EPDs	<b>14</b>	<b>-6.7</b>	<b>38</b>	<b>62</b>	<b>20</b>	<b>12</b>	<b>16</b>
Marb	<b>+.53</b>	REA	<b>-.14</b>	Bfat	<b>+.02</b>		

★★★★★ for Low Maintenance, Marbling, Calving Ease, Stayability.



• Bulls •

**255** BECKTON SCAMP B167 E5  
1-A 100% # 1706287 Tat.: BKT4 B167



Birth: 3-9-14

Beckton Scamp X458 H3  
**BECKTON SCAMP Z460 L4**  
 Ref. S-2 Beckton Belga W405 L

Beckton Scamp T A825  
 BKT Pine Marie R401 HU  
 Beckton Lancer F442 T  
 Beckton Belga K285 JL  
 Beckton Emperor R100  
 Beckton Vernice R416 EP  
 Beckton Nebula H R233  
 Beckton Tamara L132 CT

BWt **61**  
 WR **98**  
 ADG **2.92**  
 YWt. **947**  
 YR **91**  
 Scr. **40**  
 Fr. **5.0**

Beckton Emperor T641 E2  
**BECKTON TAMARA Z861 E**  
 Beckton Tamara W136 N

**DAM**  
 Age 2  
 Wt 808  
 Prog.BW 61  
 WR 98  
 YR 91  
 Wean Pct. 48%  
 Cow Eff. 102

RAAA HerdBuilder index: **166** (Top 7% of all RA bulls)  
 RAAA GridMaster index: **51** (Top 31% of all RA bulls)

Calv.Ease	BW	WW	YW	Milk	HPG	Stay	Maint.En.
EPDs <b>12</b>	<b>-5.1</b>	<b>47</b>	<b>79</b>	<b>19</b>	<b>8</b>	<b>14</b>	<b>-9.2</b>

Marb **+4.0** REA **+0.0** Bfat **+0.1**

★★★★★ for Low Maintenance, Marbling, Calving Ease, Stayability.

**258** BECKTON SCAMP B211 E5  
1-A 100% # 1706297 Tat.: BKT4 B211



Birth: 3-14-14

Beckton Scamp X458 H3  
**BECKTON SCAMP Z460 L4**  
 Ref. S-2 Beckton Belga W405 L

Beckton Scamp T A825  
 BKT Pine Marie R401 HU  
 Beckton Lancer F442 T  
 Beckton Belga K285 JL  
 Beckton Emperor R100  
 Beckton Vernice R416 EP  
 Beckton Justice CH M056  
 Beckton Tamara M731 EP

BWt **66**  
 WR **91**  
 ADG **3.76**  
 YWt. **967**  
 YR **93**  
 Scr. **31**  
 Fr. **5.0**

Beckton Emperor T641 E2  
**BECKTON TAMARA Z930 E**  
 Beckton Tamara T254 JC

**DAM**  
 Age 2  
 Wt 820  
 Prog.BW 66  
 WR 91  
 YR 93  
 Wean Pct. 44%  
 Cow Eff. 92

RAAA HerdBuilder index: **156** (Top 11% of all RA bulls)  
 RAAA GridMaster index: **51** (Top 39% of all RA bulls)

Calv.Ease	BW	WW	YW	Milk	HPG	Stay	Maint.En.
EPDs <b>13</b>	<b>-4.6</b>	<b>45</b>	<b>73</b>	<b>19</b>	<b>8</b>	<b>13</b>	<b>-8.5</b>

Marb **+4.7** REA **+1.1** Bfat **+0.1**

★★★★★ for Low Maintenance, Marbling, Calving Ease, Stayability.

**256** BECKTON SCAMP B656 J4  
1-A 100% # 1705823 Tat.: BKT4 B656



Birth: 4-8-14

Beckton Scamp T A825  
**BECKTON SCAMP X494 E3**  
 Ref. S-1 Beckton Lana S074 EP

Beckton Scamp 8954  
 Bkt Encino 8459 TJ  
 Beckton Epic KH P678  
 Beckton Lana P317 JL  
 Beckton Justice C K449  
 Beckton Ruth K802 HD  
 Beckton Neptune RR B284  
 Beckton Tamara C931 CL

BWt **76**  
 WR **103**  
 ADG **4.33**  
 YWt. **1048**  
 YR **106**  
 Scr. **32**  
 Fr. **5.0**

Beckton Justice CH M056  
**BECKTON TAMARA R834 JC**  
 Beckton Tamara J229 NP

**DAM**  
 Age 9  
 Wt 1265  
 Prog.BW 75  
 WR 98  
 YR 101  
 Wean Pct. 35%  
 Cow Eff. 73

RAAA HerdBuilder index: **155** (Top 12% of all RA bulls)  
 RAAA GridMaster index: **51** (Top 38% of all RA bulls)

Calv.Ease	BW	WW	YW	Milk	HPG	Stay	Maint.En.
EPDs <b>10</b>	<b>-3.1</b>	<b>52</b>	<b>83</b>	<b>22</b>	<b>13</b>	<b>13</b>	<b>-6.4</b>

Marb **+4.0** REA **-.04** Bfat **+0.0**

★★★★★ for Low Maintenance, Growth, Gainability, Marbling, Calving Ease, Stayability.



**257** BECKTON JULIAN B100 J8  
1-A 100% # 1706171 Tat.: BKT4 B100



Birth: 2-27-14

Beckton Julian X721 E6  
**BECKTON JULIAN Z382 J7**  
 Ref. J-5 Beckton Larkaba X064 J

Beckton Julian U699 L5  
 Beckton Lana U329 EP  
 Beckton Julian U699 L5  
 Beckton Larkaba U475 CT  
 Beckton Julian U699 L5  
 Beckton Lana U329 EP  
 Beckton Emperor T641 E2  
 Beckton Ruth S871 WR

BWt **58**  
 WR **93**  
 ADG **3.76**  
 YWt. **993**  
 YR **96**  
 Scr. **33**  
 Fr. **4.5**

Beckton Julian X721 E6  
**BECKTON RUTH Z166 J**  
 Beckton Ruth X476 E

**DAM**  
 Age 2  
 Wt 804  
 Prog.BW 58  
 WR 93  
 YR 96  
 Wean Pct. 46%  
 Cow Eff. 96

RAAA HerdBuilder index: **183** (Top 3% of all RA bulls)  
 RAAA GridMaster index: **52** (Top 13% of all RA bulls)

Calv.Ease	BW	WW	YW	Milk	HPG	Stay	Maint.En.
EPDs <b>13</b>	<b>-6.6</b>	<b>54</b>	<b>85</b>	<b>23</b>	<b>12.3</b>	<b>17</b>	<b>-8.4</b>

Marb **+3.33** REA **+2.27** Bfat **+0.03**

★★★★★ for Low Maintenance, Marbling, Rib-eye area, Calving Ease, Stayability.

**259** BECKTON LEGEND B103 N4  
1-A 100% # 1705715 Tat.: BSF4 B103



Birth: 2-27-14

Beckton Legend X561 J2  
**BECKTON LEGEND Z689 J3**  
 Ref. L-4 Beckton Larkaba W868 J

Beckton Legend S670  
 Beckton Lana T279 JO  
 Beckton Julian G5 S107  
 Beckton Larkaba S663 JE  
 Beckton Nebula M045  
 Beckton Ruth M967 EP  
 Beckton Lancer T A664  
 Beckton Christy K209 CO

BWt **63**  
 WR **102**  
 ADG **3.32**  
 YWt. **989**  
 YR **95**  
 Scr. **33**  
 Fr. **5.0**

Beckton Nebula T269 E2  
**BECKTON CHRISTY Z191 N**  
 Beckton Christy N626 LN

**DAM**  
 Age 2  
 Wt 800  
 Prog.BW 63  
 WR 102  
 YR 95  
 Wean Pct. 51%  
 Cow Eff. 108

RAAA HerdBuilder index: **193** (Top 2% of all RA bulls)  
 RAAA GridMaster index: **52** (Top 14% of all RA bulls)

Calv.Ease	BW	WW	YW	Milk	HPG	Stay	Maint.En.
EPDs <b>10</b>	<b>-3.7</b>	<b>55</b>	<b>88</b>	<b>19</b>	<b>9</b>	<b>18</b>	<b>-7.1</b>

Marb **+5.7** REA **+1.12** Bfat **+0.03**

★★★★★ for Low Maintenance, Marbling, Calving Ease, Stayability.

# The Yearling Heifers

Beckton females are nearly ideal for today's industry – moderately sized, efficient producers. They combine calving ease, growth, and desirable carcass traits. They are feminine, maternal and quiet, with nice udders and sound feet. All of our heifer calves trailed up with their mothers into the Bighorn Mountains to spend their first summer. They have learned the meaning of mothering ability. And they have the productive capacity to produce

the bulls that you see in our sale. The sale heifers are a select group from the top of our replacements.

If you wish, we can also keep any sale heifers through the summer and breed them in natural service to the same herd sires we use with our own replacements. There will be a charge of \$250 per heifer plus delivery at cost in the fall. Visit with Cam about this program.

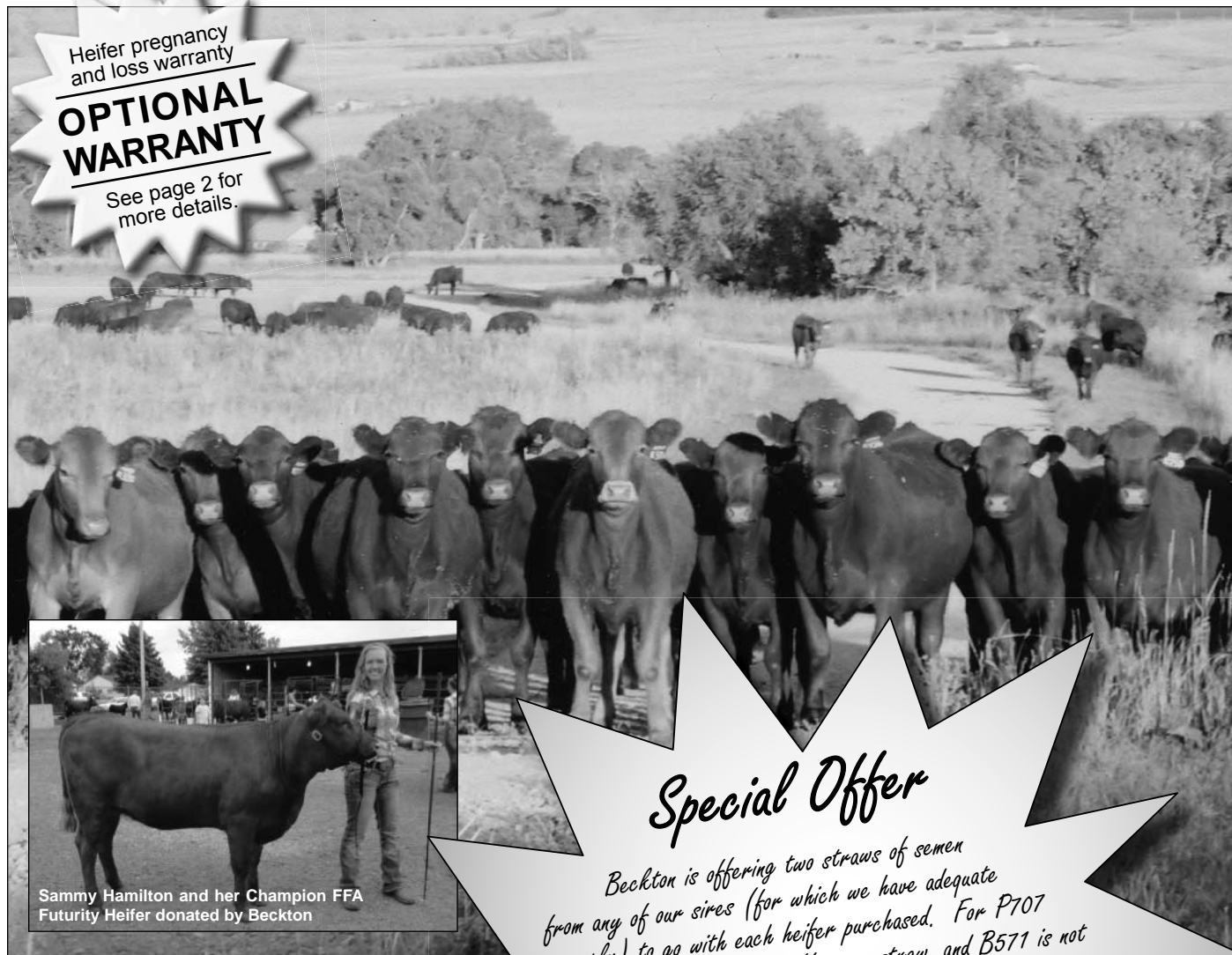

Heifer pregnancy and loss warranty  
**OPTIONAL WARRANTY**  
See page 2 for more details.



Sammy Hamilton and her Champion FFA Futurity Heifer donated by Beckton

## Special Offer

*Beckton is offering two straws of semen from any of our sires (for which we have adequate supply) to go with each heifer purchased. For P707 semen we are only able to offer one straw, and B571 is not available. The buyer will only be responsible for shipping from Billings, MT. The buyer may use the semen on any animal they would like.*

• Heifers •

**301 BECKTON MINERVA B496 N**  
1-A 100% # 1706051 Tattoo: BKT4 B496

Birth: 3-28-14	Beckton Nebula M045	Beckton Neptune R2 K065	
	Beckton Nebula P P707	Beckton Belga K285 JL	BWt <b>95</b>
Ref. N-2	Beckton Lana M809 EP	Beckton Epic K1 K863	WR <b>122</b>
		Beckton Lana K253 DM	YR <b>121</b>
	Beckton Epic K6 S569	Beckton Epic KM M115	Fr. <b>med</b>
<b>BECKTON MINERVA X455 E</b>	Beckton Sierra N703 LM	Beckton Vegas PK F485	
	Beckton Minerva J615 VG	Beckton Minerva F433 VG	

<b>DAM</b>	RAAA HerdBuilder index: <b>171</b> (Top 5% of all RA bulls)									
Age	RAAA GridMaster index: <b>52</b> (Top 17% of all RA bulls)									
Wt	880	Calv.Ease	BW	WW	YW	Milk	HPG	Stay	Maint.En.	
Prog.BW	83	EPDs	<b>14</b>	<b>0.5</b>	<b>65</b>	<b>103</b>	<b>30</b>	<b>9</b>	<b>14</b>	<b>-5.9</b>
WR	116	Marb	<b>+0.65</b>		REA	<b>-0.15</b>		Bfat	<b>+0.01</b>	
YR	114									
Cow Eff.	141									

★★★★★ for Low Maintenance, Growth, Marbling, Superior Cow, High Cow Efficiency, Calving Ease, Stayability.

**303 BECKTON TAMARA B199 A**  
1-A 100% # 1705834 Tattoo: BKT4 B199

Birth: 3-13-14	Beckton Accent W180 C2	Beckton Cody K1 P014	
	<b>BECKTON ACCENT Y260 L3</b>	Beckton Christy R046 CQ	BWt <b>93</b>
Ref. A-3	Beckton Lana W463 L	Beckton Loki CL S284	WR <b>118</b>
		Beckton Lana R327 EP	YR <b>120</b>
	Beckton Dominor ZC M919	Beckton Dominor Z E401	Fr. <b>med</b>
<b>BECKTON TAMARA S432 DM</b>	Beckton Barmaid J012 CO	Beckton Justice G302	
	Beckton Tamara M878 JC	Beckton Tamara J586 CL	

<b>DAM</b>	RAAA HerdBuilder index: <b>163</b> (Top 7% of all RA bulls)									
Age	RAAA GridMaster index: <b>51</b> (Top 29% of all RA bulls)									
Wt	1160	Calv.Ease	BW	WW	YW	Milk	HPG	Stay	Maint.En.	
Prog.BW	81	EPDs	<b>8</b>	<b>2.9</b>	<b>76</b>	<b>119</b>	<b>19</b>	<b>12</b>	<b>15</b>	<b>-1.5</b>
WR	101	Marb	<b>+0.57</b>		REA	<b>+0.10</b>		Bfat	<b>+0.02</b>	
YR	105									
Cow Eff.	104									

★★★★★ for Low Maintenance, Growth, Marbling, Calving Ease, Stayability.



**304 BECKTON LANA B304 N**  
1-A 100% # 1705548 Tattoo: BSF4 B304

Birth: 3-20-14	Beckton Nebula L P093	Beckton Nebula M045	
	<b>BECKTON NEBULA W486 D3</b>	Beckton Marta M021 LN	BWt <b>71</b>
Ref. N-4	Beckton Belga R716 DM	Beckton Dominor ZC M919	WR <b>107</b>
		Beckton Belga K285 JL	YR <b>113</b>
	Beckton Nebula EN S347	Beckton Nebula E P084	Fr. <b>med</b>
<b>BECKTON LANA W518 N</b>	Beckton Eola P530 NB	Beckton Epic KM M115	
	Beckton Lana P073 EP	Beckton Lana M393 LN	

<b>DAM</b>	RAAA HerdBuilder index: <b>201</b> (Top 1% of all RA bulls)									
Age	RAAA GridMaster index: <b>54</b> (Top 3% of all RA bulls)									
Wt	1070	Calv.Ease	BW	WW	YW	Milk	HPG	Stay	Maint.En.	
Prog.BW	67	EPDs	<b>13</b>	<b>-4.9</b>	<b>53</b>	<b>85</b>	<b>31</b>	<b>12</b>	<b>18</b>	<b>-0.4</b>
WR	112	Marb	<b>+0.65</b>		REA	<b>-0.10</b>		Bfat	<b>+0.04</b>	
YR	113									
Cow Eff.	104									

★★★★★ for Low Maintenance, Growth, Marbling, Superior Cow, Calving Ease, Stayability.

**302 BECKTON LAKME B412 N**  
2 100% # 1706064 Tattoo: BKT4 B412

Birth: 3-25-14	Beckton Nebula M045	Beckton Neptune R2 K065	
	<b>BECKTON NEBULA P P707</b>	Beckton Belga K285 JL	BWt <b>79</b>
Ref. N-2	Beckton Lana M809 EP	Beckton Epic K1 K863	WR <b>123</b>
		Beckton Lana K253 DM	YR <b>118</b>
	Beckton Epic K6 S569	Beckton Epic KM M115	Fr. <b>lar</b>
<b>BECKTON LAKME X636 E</b>	Beckton Sierra N703 LM	Beckton Epic KM M115	
	Beckton Lakme T437 EP	Beckton Lakme G128 HD	

<b>DAM</b>	RAAA HerdBuilder index: <b>169</b> (Top 5% of all RA bulls)									
Age	RAAA GridMaster index: <b>54</b> (Top 2% of all RA bulls)									
Wt	1125	Calv.Ease	BW	WW	YW	Milk	HPG	Stay	Maint.En.	
Prog.BW	71	EPDs	<b>13</b>	<b>-2.1</b>	<b>67</b>	<b>111</b>	<b>29</b>	<b>8</b>	<b>14</b>	<b>1.7</b>
WR	123	Marb	<b>+0.71</b>		REA	<b>-0.23</b>		Bfat	<b>+0.03</b>	
YR	118									
Cow Eff.	114									

★★★★★ for Low Maintenance, Growth, Marbling, Superior Cow, Calving Ease, Stayability.

**305 BECKTON MINERVA B372 J**  
1-A 100% # 1705895 Tattoo: BKT4 B372

Birth: 3-24-14	Beckton Julian G5 S107	Beckton Julian GJ P535	
	<b>BECKTON JULIAN W841 J5</b>	Beckton Minola P826 DM	BWt <b>69</b>
Ref. J-3	Beckton Christy J743 JL	Beckton Julian GG B571	WR <b>108</b>
		Beckton Christy A111 VQ	YR <b>110</b>
	Beckton Cody K2 R168	Beckton Cody KH M390	Fr. <b>med</b>
<b>BECKTON MINERVA U169 CD</b>	Beckton Tamara K249 VG	Beckton Lancer T3 J396	
	Beckton Minerva L324 LN	Beckton Minerva J232 LN	

<b>DAM</b>	RAAA HerdBuilder index: <b>168</b> (Top 6% of all RA bulls)									
Age	RAAA GridMaster index: <b>53</b> (Top 5% of all RA bulls)									
Wt	1205	Calv.Ease	BW	WW	YW	Milk	HPG	Stay	Maint.En.	
Prog.BW	64	EPDs	<b>12</b>	<b>-3.8</b>	<b>61</b>	<b>99</b>	<b>21</b>	<b>12</b>	<b>14</b>	<b>2.5</b>
WR	106	Marb	<b>+0.49</b>		REA	<b>+0.06</b>		Bfat	<b>+0.06</b>	
YR	112									
Cow Eff.	92									

★★★★★ for Low Maintenance, Growth, Marbling, Superior Cow, Calving Ease, Stayability.

• Heifers •

**306** **BSF LANETTE B461 N**  
 1-B 99% # 1728951 Tattoo: BSF4 B461  
 Birth: 3-27-14  
 Beckton Nebula P P707 < Beckton Nebula M045  
 Beckton Lana M809 EP  
**BECKTON NEW ERA Y194** BWT **97**  
 Ref. N-6 BKT Larkeisa T310 JC < Beckton Justice C1 R483  
 BKT Larkeisa R775 JC WR **119**  
 Beckton Lancer T1 H080 < Beckton Lancer TN F726  
 Beckton Belga F657 TP YR **113**  
**BSF LANETTE P497** Fr. **med**  
 Beckton Nomad V 9871  
 BSF Regus B368 < BSF Red 8101

<b>DAM</b>	RAAA HerdBuilder index: <b>116</b> (Top <b>43%</b> of all RA bulls)									
Age	RAAA GridMaster index: <b>51</b> (Top <b>25%</b> of all RA bulls)									
Wt	1170	Calv.Ease	BW	WW	YW	Milk	HPG	Stay	Maint.En.	
Prog.BW	80	EPDs	<b>9</b>	<b>0.7</b>	<b>67</b>	<b>107</b>	<b>28</b>	<b>10</b>	<b>11</b>	<b>-1.4</b>
WR	120	Marb	<b>+0.63</b>		REA	<b>-0.08</b>		Bfat	<b>+0.01</b>	
YR	114									
Cow Eff.	104									

★★★★★ for Low Maintenance, Growth, Marbling, Superior Cow, Calving Ease.

**308** **BECKTON LANA B279 A**  
 1-A 100% # 1705826 Tattoo: BKT4 B279  
 Birth: 3-19-14  
 Beckton Cody K1 P014 < Beckton Cody KH M390  
 Beckton Rose M126 WR  
**BECKTON ACCENT U777 C2** BWT **58**  
 Ref. A-1 Beckton Susan R022 CQ < Beckton Cherokee N N479  
 Beckton Susan N023 JE WR **110**  
 Beckton Lasso P741 < Beckton Lancer T1 H080  
 Beckton Ruth G534 NP YR **104**  
**BECKTON LANA S049 LO** Fr. **med**  
 Beckton Lana P265 JO < Beckton Julio L233  
 Beckton Lana J131 CT

<b>DAM</b>	RAAA HerdBuilder index: <b>152</b> (Top <b>12%</b> of all RA bulls)									
Age	RAAA GridMaster index: <b>53</b> (Top <b>6%</b> of all RA bulls)									
Wt	1075	Calv.Ease	BW	WW	YW	Milk	HPG	Stay	Maint.En.	
Prog.BW	63	EPDs	<b>13</b>	<b>-7.9</b>	<b>40</b>	<b>64</b>	<b>30</b>	<b>9</b>	<b>13</b>	<b>-5.3</b>
WR	107	Marb	<b>+0.60</b>		REA	<b>-0.03</b>		Bfat	<b>+0.01</b>	
YR	103									
Cow Eff.	110									

★★★★★ for Low Maintenance, Marbling, Calving Ease, Stayability.



**309** **BECKTON LANA B295 A**  
 1-A 100% # 1705471 Tattoo: BSF4 B295  
 Birth: 3-20-14  
 Beckton Accent W180 C2 < Beckton Cody K1 P014  
 Beckton Christy R046 CQ  
**BECKTON ACCENT Y260 L3** BWT **71**  
 Ref. A-3 Beckton Lana W463 L < Beckton Loki CL S284  
 Beckton Lana R327 EP WR **101**  
 Beckton Lancer T7 M089 < Beckton Lancer F442 T  
 Beckton Tamara G141 HE YR **103**  
**BECKTON LANA S417 LN** Fr. **med**  
 Beckton Lana C954 CB < Beckton Cobalt K Z100  
 Beckton Lana 9077 DT

<b>DAM</b>	RAAA HerdBuilder index: <b>147</b> (Top <b>15%</b> of all RA bulls)									
Age	RAAA GridMaster index: <b>50</b> (Top <b>40%</b> of all RA bulls)									
Wt	1140	Calv.Ease	BW	WW	YW	Milk	HPG	Stay	Maint.En.	
Prog.BW	74	EPDs	<b>8</b>	<b>-3.0</b>	<b>57</b>	<b>88</b>	<b>22</b>	<b>10</b>	<b>14</b>	<b>-1.7</b>
WR	105	Marb	<b>+0.34</b>		REA	<b>+0.09</b>		Bfat	<b>-0.02</b>	
YR	102									
Cow Eff.	95									

★★★★★ for Low Maintenance, Marbling, Calving Ease, Stayability.

**307** **BSF HUSTELLE B338 N**  
 1-B 99% # 1705502 Tattoo: BSF4 B338  
 Birth: 3-22-14  
 Beckton Nebula P P707 < Beckton Nebula M045  
 Beckton Lana M809 EP  
**BECKTON NEW ERA Y194** BWT **92**  
 Ref. N-6 BKT Larkeisa T310 JC < Beckton Justice C1 R483  
 BKT Larkeisa R775 JC WR **109**  
 Beckton HalfmannHustler R588 < Beckton Hustler CN J102  
 Beckton Vernice F513 CL YR **110**  
**BSF HUSTELLE U447 HH** Fr. **med**  
 BSF Regus G191 < Beckton Caesar M D023  
 BSF Regus Z112

<b>DAM</b>	RAAA HerdBuilder index: <b>173</b> (Top <b>5%</b> of all RA bulls)									
Age	RAAA GridMaster index: <b>53</b> (Top <b>5%</b> of all RA bulls)									
Wt	1135	Calv.Ease	BW	WW	YW	Milk	HPG	Stay	Maint.En.	
Prog.BW	71	EPDs	<b>12</b>	<b>0.3</b>	<b>73</b>	<b>118</b>	<b>19</b>	<b>11</b>	<b>14</b>	<b>-3.4</b>
WR	104	Marb	<b>+0.64</b>		REA	<b>-0.19</b>		Bfat	<b>+0.04</b>	
YR	103									
Cow Eff.	100									

★★★★★ for Low Maintenance, Growth, Marbling, Calving Ease, Stayability.

**310** **BECKTON TAMARA B469 E**  
 1-A 100% # 1705859 Tattoo: BKT4 B469  
 Birth: 3-27-14  
 Beckton Epic U749 D5 < Beckton Epic K4 N795  
 Beckton Denise R308 DM  
**BECKTON EPIC Y484 N6** BWT **90**  
 Ref. E-5 Beckton Lydia S069 NB < Beckton Nebula P P707  
 Beckton Lydia P583 WR WR **115**  
 Beckton Clifftop T3 N800 < Bkt Clifftop TV G672  
 Beckton Lana J384 CD YR **113**  
**BECKTON TAMARA T201 CT** Fr. **med**  
 Beckton Tamara L214 LN < Beckton Lancer TS D390  
 Beckton Tamara A023 BF

<b>DAM</b>	RAAA HerdBuilder index: <b>144</b> (Top <b>17%</b> of all RA bulls)									
Age	RAAA GridMaster index: <b>50</b> (Top <b>39%</b> of all RA bulls)									
Wt	1175	Calv.Ease	BW	WW	YW	Milk	HPG	Stay	Maint.En.	
Prog.BW	76	EPDs	<b>7</b>	<b>2.3</b>	<b>72</b>	<b>116</b>	<b>17</b>	<b>6</b>	<b>15</b>	<b>-0.8</b>
WR	99	Marb	<b>+0.58</b>		REA	<b>+0.10</b>		Bfat	<b>+0.01</b>	
YR	102									
Cow Eff.	102									

★★★★★ for Low Maintenance, Growth, Marbling, Calving Ease, Stayability.

• Heifers •



**313** **BECKTON RUTH B293 D**  
1-A 100% # 1705903 Tattoo: BKT4 B293

Birth: 3-19-14	Beckton Dominor Z1 R610	Beckton Dominor ZC M919	
		Beckton Sierra K557 LO	
<b>BECKTON DOMINOR W640 C5</b>	Ref. D-1	Beckton Cherokee N N479	BWt <b>76</b>
	Beckton Mona R166 CQ	Beckton Mona N342 HU	WR <b>103</b>
	Beckton Warrior N645 T1	Beckton Warrior T1 H281	YR <b>97</b>
<b>BECKTON RUTH U325 WR</b>		Beckton Rose H074 EP	Fr. <b>med</b>
	Beckton Ruth M047 NP	Beckton Neptune R2 K065	
		Beckton Ruth K464 JL	

<b>DAM</b>	RAAA HerdBuilder index: <b>153</b> (Top <b>12%</b> of all RA bulls)									
Age	RAAA GridMaster index: <b>53</b> (Top <b>8%</b> of all RA bulls)									
Wt	6	Calv.Ease	BW	WW	YW	Milk	HPG	Stay	Maint.En.	
Prog.BW	1185	10	-2.6	55	82	21	14	13	0.5	
WR	73	EPDs								
YR	109	Marb	+0.63	REA	-0.11	Bfat	+0.03			
Cow Eff.	102									
	89									

★★★★★ for Low Maintenance, Marbling, Calving Ease, Stayability.

**311** **BECKTON EOLA B739 E**  
1-A 100% # 1705984 Tattoo: BKT4 B739

Birth: 4-16-14	Beckton Epic K6 S569	Beckton Epic KM M115	
		Beckton Sierra N703 LM	
<b>BECKTON EPIC X464 L5</b>	Ref. E-3	Beckton Lancer T3 J396	BWt <b>92</b>
	Beckton Lana M393 LN	Beckton Lana F081 LN	WR <b>121</b>
	Beckton Hasten H S462	Beckton Hasten P292	YR <b>108</b>
<b>BECKTON EOLA W539 H</b>		Beckton Lakme G128 HD	Fr. <b>med</b>
	Beckton Eola N491 LN	Beckton Lancer T4 J536	
		Beckton Eola C611 SC	

<b>DAM</b>	RAAA HerdBuilder index: <b>126</b> (Top <b>33%</b> of all RA bulls)									
Age	RAAA GridMaster index: <b>49</b> (Top <b>75%</b> of all RA bulls)									
Wt	5	Calv.Ease	BW	WW	YW	Milk	HPG	Stay	Maint.En.	
Prog.BW	1250	10	1.2	65	103	31	8	12	0.6	
WR	72	EPDs								
YR	111	Marb	+0.28	REA	+0.11	Bfat	-0.01			
Cow Eff.	107									
	99									

★★★★★ for Low Maintenance, Growth, Marbling, Superior Cow, Calving Ease.



**312** **BSF HUSTELLE B178 C**  
1-B 99% # 1705459 Tattoo: BSF4 B178

Birth: 3-11-14	Beckton Clifftop W692 E3	BKT Clifftop TP R288	
		Beckton Lydia S274 EP	
<b>BECKTON CLIFFTOP Y012 C4</b>	Ref. C-2	BKT Clifftop TP R288	BWt <b>76</b>
	Beckton Lana W240 C	Beckton Lana L923 CD	WR <b>104</b>
	Beckton Hustler CN J102	Beckton Hustler C G407	YR <b>99</b>
<b>BSF HUSTELLE R608 HU</b>		Beckton Belga G355 NP	Fr. <b>med</b>
	BSF Regus L862 CL	Beckton Clipper KH F416	
		BSF Regus Z776	

<b>DAM</b>	RAAA HerdBuilder index: <b>147</b> (Top <b>15%</b> of all RA bulls)									
Age	RAAA GridMaster index: <b>50</b> (Top <b>51%</b> of all RA bulls)									
Wt	9	Calv.Ease	BW	WW	YW	Milk	HPG	Stay	Maint.En.	
Prog.BW	1125	13	-3.9	44	74	28	10	13	-1.5	
WR	69	EPDs								
YR	103	Marb	+0.33	REA	-0.08	Bfat	-0.01			
Cow Eff.	103									
	96									

★★★★★ for Low Maintenance, Marbling, Calving Ease, Stayability.

**314** **BECKTON EOLA B289 N**  
1-A 100% # 1706004 Tattoo: BKT4 B289

Birth: 3-19-14	Beckton Nebula P P707	Beckton Nebula M045	
		Beckton Lana M809 EP	
<b>BECKTON NEW ERA Y194</b>	Ref. N-6	Beckton Justice C1 R483	BWt <b>86</b>
	BKT Larkeisa T310 JC	BKT Larkeisa R775 JC	WR <b>111</b>
	Beckton Nebula L P093	Beckton Nebula M045	YR <b>107</b>
<b>BECKTON EOLA W796 N</b>		Beckton Marta M021 LN	Fr. <b>med</b>
	Beckton Eola S023 JT	Beckton Jet L P491	
		Beckton Eola P336 CE	

<b>DAM</b>	RAAA HerdBuilder index: <b>173</b> (Top <b>4%</b> of all RA bulls)									
Age	RAAA GridMaster index: <b>52</b> (Top <b>11%</b> of all RA bulls)									
Wt	5	Calv.Ease	BW	WW	YW	Milk	HPG	Stay	Maint.En.	
Prog.BW	1205	9	0.3	73	118	20	11	16	2.4	
WR	84	EPDs								
YR	113	Marb	+0.55	REA	-0.11	Bfat	+0.03			
Cow Eff.	113									
	96									

★★★★★ for Low Maintenance, Growth, Marbling, Superior Cow, Calving Ease, Stayability.

• Heifers •

**315** **BECKTON SERENA B395 A**  
1-A 100% # 1705970 Tattoo: BKT4 B395

Birth: 3-25-14  
 Beckton Cody K1 P014 < Beckton Cody KH M390  
 Beckton Rose M126 WR  
**BECKTON ACCENT U777 C2** BWT **65**  
 Ref. A-1 < Beckton Susan R022 CQ < Beckton Cherokee N N479  
 Beckton Susan N023 JE WR **108**  
 Beckton Emcee S466 < Beckton Epic K4 N795  
**BECKTON SERENA W366 E** YR **105**  
 Beckton Larkaba H798 WR Fr. **med**  
 Beckton Warrior TD L493  
 Beckton Serena N088 WR < Beckton Serena L591 VG

<b>DAM</b>	RAAA HerdBuilder index: <b>157</b> (Top 10% of all RA bulls)									
Age	RAAA GridMaster index: <b>52</b> (Top 19% of all RA bulls)									
Wt	5	Calv.Ease	BW	WW	YW	Milk	HPG	Stay	Maint.En.	
Prog.BW	965	EPDs	12	-6.0	45	74	31	9	14	-6.4
WR	62	Marb	+.48		REA	+.05		Bfat	+.01	
YR	106									
Cow Eff.	106									

★★★★★ for Low Maintenance, Marbling, Superior Cow, High Cow Efficiency, Calving Ease, Stayability.

**317** **BSF JUSTICIA B596 J**  
2 99% # 1705568 Tattoo: BSF4 B596

Birth: 4-3-14  
 Beckton Julian G5 S107 < Beckton Julian GJ P535  
 Beckton Minola P826 DM  
**BECKTON JULIAN X465 J5** BWT **82**  
 Ref. J-4 < Beckton Julian GG B571  
 Beckton Suffeina P643 JL < Bkt Suffeina A828 DM WR **117**  
 Beckton Hasten U108 J3 < Beckton Hasten H S462  
**BSF JUSTICIA X006 H** YR **108**  
 BSF Justicia U290 JC < Beckton Encino S456 JC Fr. **med**  
 BSF Regus K326 WH

<b>DAM</b>	RAAA HerdBuilder index: <b>188</b> (Top 2% of all RA bulls)									
Age	RAAA GridMaster index: <b>52</b> (Top 11% of all RA bulls)									
Wt	4	Calv.Ease	BW	WW	YW	Milk	HPG	Stay	Maint.En.	
Prog.BW	956	EPDs	11	-0.9	63	104	19	13	16	-8.2
WR	74	Marb	+.62		REA	-.16		Bfat	+.02	
YR	112									
Cow Eff.	107									

★★★★★ for Low Maintenance, Growth, Marbling, Superior Cow, High Cow Efficiency, Calving Ease, Stayability.

**316** **BSF JULIANNE B367 J**  
1-B 99% # 1705496 Tattoo: BSF4 B367

Birth: 3-24-14  
 Beckton Javelin 6587 < Beckton Trojan 5253  
 Beckton Ileximka -3  
**BKT JAVELIN 7466 R** BWT **79**  
 Ref. J-2 < Beckton Raza 2308-N  
 Beckton Rose 6807 RZ < Bkt Baya Rose 5195 WR **109**  
 Beckton Likable S633 < Beckton Lancer F442 T  
**BSF JULIANNE U375 LI** YR **107**  
 BSF Julianne S127 JT < Beckton Kit F468 JL Fr. **med**  
 Beckton Jet L P491  
 BSF Julianne P881

<b>DAM</b>	RAAA HerdBuilder index: <b>165</b> (Top 7% of all RA bulls)									
Age	RAAA GridMaster index: <b>50</b> (Top 39% of all RA bulls)									
Wt	6	Calv.Ease	BW	WW	YW	Milk	HPG	Stay	Maint.En.	
Prog.BW	1170	EPDs	13	-3.4	39	53	26	12	13	-12.5
WR	71	Marb	+.53		REA	+.01		Bfat	+.02	
YR	103									
Cow Eff.	98									

★★★★★ for Low Maintenance, Marbling, Calving Ease, Stayability.

**318** **BECKTON LARKEISA B168 N**  
1-A 100% # 1705795 Tattoo: BKT4 B168

Birth: 3-9-14  
 Beckton Nebula U206 V3 < Beckton Nebula P P707  
 Beckton Minerva J615 VG  
**BECKTON NEBULA X096 N4** BWT **90**  
 Ref. N-5 < Beckton Nebula P P707  
 Beckton Tamara U185 NB < Beckton Tamara P813 CH WR **100**  
 Beckton Neptune R2 K065 < Beckton Neptune RR B284  
**BECKTON LARKEISA P136 NP** YR **110**  
 Bkt Larkeisa G448 CT < Beckton Lana C735 TP Fr. **med**  
 Beckton Cliffort T C075  
 Bkt Larkeisa C894 JV

<b>DAM</b>	RAAA HerdBuilder index: <b>174</b> (Top 4% of all RA bulls)									
Age	RAAA GridMaster index: <b>50</b> (Top 48% of all RA bulls)									
Wt	10	Calv.Ease	BW	WW	YW	Milk	HPG	Stay	Maint.En.	
Prog.BW	1245	EPDs	10	0.3	59	94	26	12	17	-0.3
WR	73	Marb	+.45		REA	-.08		Bfat	+.00	
YR	110									
Cow Eff.	109									

★★★★★ for Low Maintenance, Growth, Marbling, Superior Cow, Calving Ease, Stayability.



**319** **BECKTON SIERRA B326 J**  
1-A 100% # 1706079 Tattoo: BKT4 B326

Birth: 3-21-14  
 Beckton Julian G5 S107 < Beckton Julian GJ P535  
 Beckton Minola P826 DM  
**BECKTON JULIAN X465 J5** BWT **85**  
 Ref. J-4 < Beckton Julian GG B571  
 Beckton Suffeina P643 JL < Bkt Suffeina A828 DM WR **101**  
 Beckton Cherokee T450 L3 < Beckton Cherokee N N479  
**BECKTON SIERRA X818 C** YR **102**  
 Beckton Sierra G615 WR < Beckton Annie M337 LN Fr. **med**  
 Beckton Warrior C C355  
 Beckton Sierra D804 JL

<b>DAM</b>	RAAA HerdBuilder index: <b>148</b> (Top 14% of all RA bulls)									
Age	RAAA GridMaster index: <b>50</b> (Top 43% of all RA bulls)									
Wt	4	Calv.Ease	BW	WW	YW	Milk	HPG	Stay	Maint.En.	
Prog.BW	1055	EPDs	5	2.4	64	104	16	13	14	-3.3
WR	79	Marb	+.61		REA	-.05		Bfat	+.02	
YR	98									
Cow Eff.	113									

★★★★★ for Low Maintenance, Marbling, Stayability.

• Heifers •

**320** **BECKTON MONA B772 E**  
1-A 100% # 1705853 Tattoo: BKT4 B772

Birth: 4-20-14	Beckton Epic K4 N795	Beckton Epic KJ J722	
	Beckton Denise R308 DM	Beckton Sierra J789 EP	BWt <b>85</b>
<b>BECKTON EPIC U749 D5</b>		Beckton Dominor ZC M919	WR <b>119</b>
Ref. E-1		Beckton Denise L639 JL	YR <b>106</b>
	Beckton Nebula N R573	Beckton Nebula M045	Fr. <b>med</b>
<b>BECKTON MONA T125 NB</b>		Beckton Lana M621 LN	
	Beckton Monna R408 HT	Beckton Heritage N013	
		Beckton Monna N444 HU	

<b>DAM</b>	RAAA HerdBuilder index: <b>111</b> (Top <b>49%</b> of all RA bulls)									
Age	RAAA GridMaster index: <b>50</b> (Top <b>45%</b> of all RA bulls)									
Wt	7	Calv.Ease	BW	WW	YW	Milk	HPG	Stay	Maint.En.	
Prog.BW	1350	EPDs	<b>5</b>	<b>1.9</b>	<b>69</b>	<b>116</b>	<b>18</b>	<b>8</b>	<b>12</b>	<b>6.7</b>
WR	94	Marb	<b>+.54</b>		REA	<b>+.14</b>		Bfat	<b>+.02</b>	
YR	120									
Cow Eff.	117									

★★★★★ for Growth, Marbling, Rib-eye area, Superior Cow.

**322** **BECKTON ENCINO B513 J**  
1-A 100% # 1705477 Tattoo: BSF4 B513

Birth: 3-29-14	Beckton Julian G5 S107	Beckton Julian GJ P535	
	Beckton Suffeina P643 JL	Beckton Minola P826 DM	BWt <b>82</b>
<b>BECKTON JULIAN X465 J5</b>		Beckton Julian GG B571	WR <b>96</b>
Ref. J-4		Bkt Suffeina A828 DM	YR <b>99</b>
	Beckton Jupiter R478	Beckton Julian G1 J526	Fr. <b>med</b>
<b>BECKTON ENCINO T128 JR</b>		Beckton Serena L042 CR	
	Beckton Encino R488 JL	Beckton Julian G1 J526	
		Beckton Encino C644 ZN	

<b>DAM</b>	RAAA HerdBuilder index: <b>191</b> (Top <b>2%</b> of all RA bulls)									
Age	RAAA GridMaster index: <b>53</b> (Top <b>5%</b> of all RA bulls)									
Wt	7	Calv.Ease	BW	WW	YW	Milk	HPG	Stay	Maint.En.	
Prog.BW	1005	EPDs	<b>9</b>	<b>0.2</b>	<b>69</b>	<b>104</b>	<b>17</b>	<b>14</b>	<b>16</b>	<b>-6.3</b>
WR	70	Marb	<b>+.70</b>		REA	<b>-.23</b>		Bfat	<b>+.02</b>	
YR	100									
Cow Eff.	101									

★★★★★ for Low Maintenance, Marbling, Calving Ease, Stayability.

**321** **BSF LAUREL B665 J**  
2 99% # 1729767 Tattoo: BSF4 B665

Birth: 4-9-14	Beckton Julian G5 S107	Beckton Julian GJ P535	
	Beckton Suffeina P643 JL	Beckton Minola P826 DM	BWt <b>65</b>
<b>BECKTON JULIAN X465 J5</b>		Beckton Julian GG B571	WR <b>115</b>
Ref. J-4		Bkt Suffeina A828 DM	YR <b>113</b>
	Beckton Warrior T248 L5	Beckton Warrior N645 T1	Fr. <b>med</b>
<b>BSF LAUREL Y568 W</b>		Beckton Kit R503 LN	
	BSF Laurel S572 DM	Beckton Dominor ZC M919	
		BSF Laurel N839 LN	

<b>DAM</b>	RAAA HerdBuilder index: <b>NA</b> (Top <b>NA%</b> of all RA bulls)									
Age	RAAA GridMaster index: <b>NA</b> (Top <b>NA%</b> of all RA bulls)									
Wt	3	Calv.Ease	BW	WW	YW	Milk	HPG	Stay	Maint.En.	
Prog.BW	1020	EPDs	<b>9</b>	<b>-1.5</b>	<b>56</b>	<b>95</b>	<b>17</b>	<b>13</b>	<b>15</b>	<b>-6.7</b>
WR	64	Marb	<b>+.75</b>		REA	<b>-.07</b>		Bfat	<b>+.02</b>	
YR	110									
Cow Eff.	106									

★★★★★ for Low Maintenance, Growth, Marbling, Superior Cow, Calving Ease, Stayability.

**323** **BECKTON ENCINO B723 N**  
1-A 100% # 1705579 Tattoo: BSF4 B723

Birth: 4-14-14	Beckton Nebula L P093	Beckton Nebula M045	
	Beckton Belga R716 DM	Beckton Marta M021 LN	BWt <b>59</b>
<b>BECKTON NEBULA W486 D3</b>		Beckton Dominor ZC M919	WR <b>104</b>
Ref. N-4		Beckton Belga K285 JL	YR <b>103</b>
	Beckton Clifftop U575 H3	BKT Clifftop TP R288	Fr. <b>med</b>
<b>BECKTON ENCINO X075 C</b>		Beckton Larkabel N769 HR	
	Beckton Encino U186 NB	Beckton Nebula N R573	
		Beckton Encino P871 HR	

<b>DAM</b>	RAAA HerdBuilder index: <b>198</b> (Top <b>1%</b> of all RA bulls)									
Age	RAAA GridMaster index: <b>53</b> (Top <b>9%</b> of all RA bulls)									
Wt	4	Calv.Ease	BW	WW	YW	Milk	HPG	Stay	Maint.En.	
Prog.BW	895	EPDs	<b>13</b>	<b>-6.9</b>	<b>44</b>	<b>72</b>	<b>25</b>	<b>11</b>	<b>18</b>	<b>0.5</b>
WR	60	Marb	<b>+.50</b>		REA	<b>+.04</b>		Bfat	<b>+.03</b>	
YR	112									
Cow Eff.	106									

★★★★★ for Low Maintenance, Marbling, Superior Cow, High Cow Efficiency, Calving Ease, Stayability.



**324** **BECKTON LARKABA B050 A**  
1-A 100% # 1706242 Tattoo: BKT4 B050

Birth: 2-19-14	Beckton Accent W180 C2	Beckton Cody K1 P014	
	Beckton Susan P857 JO	Beckton Christy R046 CQ	BWt <b>69</b>
<b>BECKTON ACCENT Z506 J3</b>		Beckton Julio L233	WR <b>97</b>
Ref. A-5		Beckton Susan G199 CO	YR <b>108</b>
	Beckton Nebula W130 D3	Beckton Nebula T269 E2	Fr. <b>med</b>
<b>BECKTON LARKABA Z573 N</b>		Beckton Firefly T006 DM	
	Beckton Larkaba S083 JL	Beckton Julian G3 P608	
		Beckton Larkaba P645 JL	

<b>DAM</b>	RAAA HerdBuilder index: <b>185</b> (Top <b>3%</b> of all RA bulls)									
Age	RAAA GridMaster index: <b>53</b> (Top <b>6%</b> of all RA bulls)									
Wt	2	Calv.Ease	BW	WW	YW	Milk	HPG	Stay	Maint.En.	
Prog.BW	910	EPDs	<b>11</b>	<b>-1.9</b>	<b>61</b>	<b>99</b>	<b>25</b>	<b>9</b>	<b>16</b>	<b>-4.0</b>
WR	69	Marb	<b>+.64</b>		REA	<b>+.07</b>		Bfat	<b>+.07</b>	
YR	97									
Cow Eff.	108									

★★★★★ for Low Maintenance, Growth, Marbling, Calving Ease, Stayability.

• Heifers •

**325 BECKTON LARKABA B514 N**  
1-A 100% # 1705495 Tattoo: BSF4 B514

Birth: 3-29-14

Beckton Neptune R2 K065 < Beckton Neptune RR B284  
Beckton Lana C735 TP

**BECKTON NEBULA M045**  
Ref. N-1 < Beckton Julian GG B571  
Beckton Belga K285 JL < Beckton Belga G493 HR

Beckton Julian G3 P608 < Beckton Julian GG B571  
Beckton Larkaba U274 JL < Bkt Suffeina A828 DM

Beckton Herald FJ J776  
Beckton Larkaba N708 HR < Beckton Larkaba G311 CT

BWt **59**  
WR **90**  
YR **92**  
Fr. **med**

DAM		RAAA HerdBuilder index: <b>207</b> (Top 1% of all RA bulls)
Age	6	RAAA GridMaster index: <b>54</b> (Top 2% of all RA bulls)
Wt	1025	Calv.Ease BW WW YW Milk HPG Stay Maint.En.
Prog.BW	60	EPDs <b>17 -8.4 40 69 17 13 16 -9.1</b>
WR	95	Marb <b>+0.68</b> REA <b>-.24</b> Bfat <b>+0.02</b>
YR	95	
Cow Eff.	91	

★★★★★ for Low Maintenance, Marbling, Calving Ease, Stayability.

**327 BECKTON LANA B096 R**  
1-A 100% # 1705747 Tattoo: BSF4 B096

Birth: 2-26-14

Beckton Ranger T603 H3 < Beckton Ranger 9479R  
Beckton Rose N044 HU

**BECKTON RANGER Z225 J4**  
Ref. R-1 < Beckton Jet L P491  
Beckton Mona U564 JT < Beckton Mona P874 WR

Beckton Clifftop W577 E3 < BKT Clifftop TP R288  
**BECKTON LANA Z580 C** < BKT Pine Marie R213 EP

Beckton Epic KM M115  
Beckton Lana P073 EP < Beckton Lana M393 LN

BWt **52**  
WR **96**  
YR **100**  
Fr. **med**

DAM		RAAA HerdBuilder index: <b>164</b> (Top 7% of all RA bulls)
Age	2	RAAA GridMaster index: <b>53</b> (Top 4% of all RA bulls)
Wt	910	Calv.Ease BW WW YW Milk HPG Stay Maint.En.
Prog.BW	52	EPDs <b>11 -7.2 42 74 26 12 13 -6.0</b>
WR	96	Marb <b>+0.58</b> REA <b>-.08</b> Bfat <b>+0.05</b>
YR	100	
Cow Eff.	88	

★★★★★ for Low Maintenance, Marbling, Calving Ease, Stayability.



**326 BECKTON COCA B388 E**  
1-A 100% # 1705868 Tattoo: BKT4 B388

Birth: 3-25-14

Beckton Epic T330 L5 < Beckton Epic K4 N795  
Beckton Belga K202 LN

**BECKTON EPIC X816 C6**  
Ref. E-4 < Beckton Cherokee N N479  
Beckton Mona R198 CQ < Beckton Mona N009 JE

Beckton Nexus L016 < Beckton Neptune R1 J245  
**BECKTON COCA T454 NX** < Beckton Coca J276 CL

Beckton Cody V E023  
Beckton Coca P597 CD < Beckton Coca G112 NM

BWt **80**  
WR **118**  
YR **109**  
Fr. **sma**

DAM		RAAA HerdBuilder index: <b>145</b> (Top 17% of all RA bulls)
Age	7	RAAA GridMaster index: <b>52</b> (Top 17% of all RA bulls)
Wt	1170	Calv.Ease BW WW YW Milk HPG Stay Maint.En.
Prog.BW	68	EPDs <b>11 -2.7 54 92 30 12 13 0.1</b>
WR	113	Marb <b>+0.53</b> REA <b>-.05</b> Bfat <b>+0.04</b>
YR	109	
Cow Eff.	103	

★★★★★ for Low Maintenance, Growth, Marbling, Superior Cow, Calving Ease, Stayability.

**328 BECKTON UCOLA B672 A**  
1-A 100% # 1705545 Tattoo: BSF4 B672

Birth: 4-9-14

Beckton Cody K1 P014 < Beckton Cody KH M390  
Beckton Rose M126 WR

**BECKTON ACCENT U777 C2**  
Ref. A-1 < Beckton Cherokee N N479  
Beckton Susan R022 CQ < Beckton Susan N023 JE

Beckton Nebula EN S347 < Beckton Nebula E P084  
**BECKTON UCOLA W459 N** < Beckton Eola P530 NB

Beckton Hustler C2 L079  
Beckton Ucola S513 HU < Beckton Ucola L781 HU

BWt **66**  
WR **97**  
YR **103**  
Fr. **med**

DAM		RAAA HerdBuilder index: <b>176</b> (Top 4% of all RA bulls)
Age	5	RAAA GridMaster index: <b>53</b> (Top 8% of all RA bulls)
Wt	NA	Calv.Ease BW WW YW Milk HPG Stay Maint.En.
Prog.BW	64	EPDs <b>12 -6.0 45 66 29 13 14 -6.1</b>
WR	105	Marb <b>+0.55</b> REA <b>-.07</b> Bfat <b>+0.02</b>
YR	102	
Cow Eff.	NA	

★★★★★ for Low Maintenance, Marbling, Calving Ease, Stayability.



• Heifers •



**329** **BECKTON LANA B038 L**  
2 100% # 1706213 Tattoo: BKT4 B038

Birth: 2-18-14  
 Beckton Legend X561 J2 < Beckton Legend S670  
 Beckton Lana T279 JO  
**BECKTON LEGEND Z689 J3** BWT **64**  
 Ref. L-4 < Beckton Julian G5 S107  
 Beckton Larkaba W868 J < Beckton Larkaba S663 JE WR **103**  
 Beckton Nebula J R475 < Beckton Nebula M045 YR **105**  
**BECKTON LANA Z387 N** Fr. **med**  
 Beckton Lana S669 EP < Beckton Larkeisa M138 JC  
 Beckton Epic K4 N795  
 Beckton Lana M597 LO

<b>DAM</b>	RAAA HerdBuilder index: <b>169</b> (Top 6% of all RA bulls)									
Age	RAAA GridMaster index: <b>53</b> (Top 7% of all RA bulls)									
Wt	2	Calv.Ease	BW	WW	YW	Milk	HPG	Stay	Maint.En.	
Prog.BW	885	9	-2.5	60	99	15	8	15	-5.7	
WR	64	EPDs								
YR	103	Marb	+0.64	REA	+0.09	Bfat	+0.04			
Cow Eff.	105									
	97									

★★★★★ for Low Maintenance, Growth, Marbling, Superior Cow, Calving Ease, Stayability.

**330** **BECKTON LAKME B258 C**  
1-A 100% # 1705879 Tattoo: BKT4 B258

Birth: 3-18-14  
 Beckton Clifftop W692 E3 < BKT Clifftop TP R288  
 Beckton Lydia S274 EP  
**BECKTON CLIFFTOP Y012 C4** BWT **62**  
 Ref. C-2 < Beckton Lana W240 C < BKT Clifftop TP R288  
 Beckton Lana L923 CD WR **90**  
 Beckton Epic KM M115 < Beckton Epic K F075 YR **89**  
**BECKTON LAKME T692 EP** Fr. **med**  
 Beckton Lakme P513 EP < Beckton Minerva F495 CH  
 Beckton Epic K F075  
 Beckton Lakme K697 CT

<b>DAM</b>	RAAA HerdBuilder index: <b>186</b> (Top 2% of all RA bulls)									
Age	RAAA GridMaster index: <b>52</b> (Top 14% of all RA bulls)									
Wt	7	Calv.Ease	BW	WW	YW	Milk	HPG	Stay	Maint.En.	
Prog.BW	1185	9	-6.1	45	82	28	11	17	-4.1	
WR	67	EPDs								
YR	101	Marb	+0.42	REA	-0.05	Bfat	+0.05			
Cow Eff.	104									
	79									

★★★★★ for Low Maintenance, Marbling, Calving Ease, Stayability.

**332** **BECKTON COCA B332 A**  
1-A 100% # 1705544 Tattoo: BSF4 B332

Birth: 3-22-14  
 Beckton Cody K1 P014 < Beckton Cody KH M390  
 Beckton Rose M126 WR  
**BECKTON ACCENT U777 C2** BWT **50**  
 Ref. A-1 < Beckton Susan R022 CQ < Beckton Cherokee N N479  
 Beckton Susan N023 JE WR **89**  
 Beckton Nebula M045 < Beckton Neptune R2 K065 YR **90**  
**BECKTON COCA W438 N** Fr. **sma**  
 Beckton Coca T080 NB < Beckton Belga K285 JL  
 Beckton Nebula N R573  
 Beckton Coca R375 WR

<b>DAM</b>	RAAA HerdBuilder index: <b>204</b> (Top 1% of all RA bulls)									
Age	RAAA GridMaster index: <b>54</b> (Top 2% of all RA bulls)									
Wt	5	Calv.Ease	BW	WW	YW	Milk	HPG	Stay	Maint.En.	
Prog.BW	888	15	-10.6	35	57	25	11	16	-10.8	
WR	53	EPDs								
YR	100	Marb	+0.50	REA	-0.11	Bfat	+0.04			
Cow Eff.	103									

★★★★★ for Low Maintenance, Marbling, Calving Ease, Stayability.

**331** **BECKTON BELGA B321 N**  
1-A 100% # 1705665 Tattoo: BSF4 B321

Birth: 3-21-14  
 Beckton Nebula E P084 < Beckton Nebula M045  
 BKT Pine Marie M119 EP  
**BECKTON NEBULA EN S347** BWT **57**  
 Ref. N-3 < Beckton Nebula M045 < Beckton Eola P530 NB  
 Beckton Eola M663 EP WR **94**  
 Beckton Nebula U206 V3 < Beckton Nebula P P707 YR **96**  
**BECKTON BELGA Y515 N** Fr. **sma**  
 Beckton Minerva J615 VG  
 Beckton Justice C1 R483  
 Beckton Belga U103 JC < Beckton Belga M883 DM

<b>DAM</b>	RAAA HerdBuilder index: <b>200</b> (Top 1% of all RA bulls)									
Age	RAAA GridMaster index: <b>54</b> (Top 2% of all RA bulls)									
Wt	3	Calv.Ease	BW	WW	YW	Milk	HPG	Stay	Maint.En.	
Prog.BW	1050	15	-7.4	41	61	29	15	16	-1.8	
WR	57	EPDs								
YR	94	Marb	+0.69	REA	-0.26	Bfat	+0.03			
Cow Eff.	96									
	84									

★★★★★ for Low Maintenance, Marbling, Calving Ease, Stayability.

**333** **BECKTON TAMARA B728 A**  
1-A 100% # 1706047 Tattoo: BKT4 B728

Birth: 4-15-14  
 Beckton Accent U777 C2 < Beckton Cody K1 P014  
 Beckton Susan R022 CQ  
**BECKTON ACCENT Y312 N3** BWT **76**  
 Ref. A-4 < BKT Larkeisa S055 NB < Beckton Nebula P P707  
 Beckton Larkeisa P688 CH WR **99**  
 Beckton Legend S670 < Beckton Lancer F442 T YR **93**  
**BECKTON TAMARA X409 L** Fr. **med**  
 Beckton Tamara P243 JO < Beckton Kit F468 JL  
 Beckton Julio L233  
 Beckton Tamara K767 HR

<b>DAM</b>	RAAA HerdBuilder index: <b>179</b> (Top 3% of all RA bulls)									
Age	RAAA GridMaster index: <b>53</b> (Top 8% of all RA bulls)									
Wt	4	Calv.Ease	BW	WW	YW	Milk	HPG	Stay	Maint.En.	
Prog.BW	1070	12	-3.3	51	77	24	9	15	-7.8	
WR	71	EPDs								
YR	103	Marb	+0.71	REA	+0.16	Bfat	+0.05			
Cow Eff.	100									
	95									

★★★★★ for Low Maintenance, Marbling, Rib-eye area, Calving Ease, Stayability.

• Heifers •



**335** **BECKTON LAKME B541 A**  
1-A 100% # 1705987 Tattoo: BKT4 B541

Birth: 3-31-14	Beckton Cody K1 P014	Beckton Cody KH M390	
		Beckton Rose M126 WR	
<b>BECKTON ACCENT U777 C2</b>			BWt <b>64</b>
Ref. A-1	Beckton Susan R022 CQ	Beckton Cherokee N N479	WR <b>92</b>
		Beckton Susan N023 JE	YR <b>86</b>
	Beckton Epic K4 N795	Beckton Epic KJ J722	Fr. <b>sma</b>
<b>BECKTON LAKME W569 E</b>		Beckton Sierra J789 EP	
	Beckton Lakme R626 LN	Beckton Lancer T7 M089	
		Beckton Lakme M669 EP	

<b>DAM</b>	RAAA HerdBuilder index: <b>130</b> (Top <b>28%</b> of all RA bulls)
Age <b>5</b>	RAAA GridMaster index: <b>52</b> (Top <b>18%</b> of all RA bulls)
Wt <b>1085</b>	Calv.Ease BW WW YW Milk HPG Stay Maint.En.
Prog.BW <b>70</b>	EPDs <b>8 -4.9 47 81 23 4 13 -0.4</b>
WR <b>98</b>	Marb <b>+0.55</b> REA <b>+0.10</b> Bfat <b>+0.02</b>
YR <b>97</b>	
Cow Eff. <b>87</b>	

★★★★★ for Low Maintenance, Marbling, Calving Ease, Stayability.

**334** **BECKTON INDIGO B865 A**  
1-A 100% # 1705550 Tattoo: BSF4 B865

Birth: 5-4-14	Beckton Cody K1 P014	Beckton Cody KH M390	
		Beckton Rose M126 WR	
<b>BECKTON ACCENT U777 C2</b>			BWt <b>84</b>
Ref. A-1	Beckton Susan R022 CQ	Beckton Cherokee N N479	WR <b>90</b>
		Beckton Susan N023 JE	YR <b>94</b>
	Beckton Nebula L P093	Beckton Nebula M045	Fr. <b>med</b>
<b>BECKTON INDIGO W626 N</b>		Beckton Marta M021 LN	
	Beckton Indigo T832 HT	Beckton Heritage N013	
		Beckton Indigo D780 JL	

<b>DAM</b>	RAAA HerdBuilder index: <b>164</b> (Top <b>7%</b> of all RA bulls)
Age <b>5</b>	RAAA GridMaster index: <b>51</b> (Top <b>31%</b> of all RA bulls)
Wt <b>1065</b>	Calv.Ease BW WW YW Milk HPG Stay Maint.En.
Prog.BW <b>82</b>	EPDs <b>8 -0.6 59 88 20 11 16 -3.1</b>
WR <b>105</b>	Marb <b>+0.56</b> REA <b>+0.06</b> Bfat <b>+0.01</b>
YR <b>102</b>	
Cow Eff. <b>91</b>	

★★★★★ for Low Maintenance, Marbling, Calving Ease, Stayability.

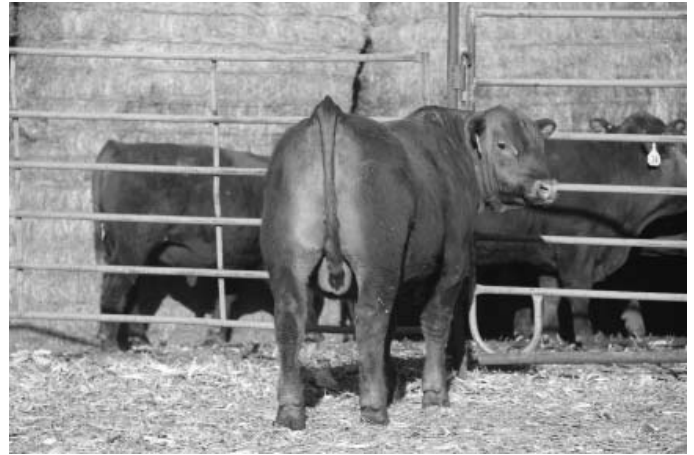

# Reference Sires

The goal for Beckton's program has always been to develop breeding seedstock which offer increased levels of performance for the commercial cattleman. Increased performance does not mean maximizing weight and size, which have already reached the upper limit of economic

value for the packer and consumer. It does, however, mean increasing performance related to calving percentage and weaning percentage; and increasing performance related to cow maintenance requirements and "pounds of calf per acre" efficiency.



***Beckton Julian B571 (Ref. Sire J-1)***

• Reference Sires •

**A-1 BECKTON ACCENT U777 C2**  
1-A 100% # 1259524 Tattoo: BKT8 U777

Birth: 4-13-08	Beckton Cody KH M390	Beckton Cody K G701	BWt	<b>66</b>
	Beckton Rose M126 WR	Beckton Tamara J124 HR	WR	<b>117</b>
<b>BECKTON CODY K1 P014</b>	Ref. A	Beckton Warrior T C371	ADG	<b>4.59</b>
	Beckton Rose D741 LN	Beckton Rose D741 LN	YR	<b>112</b>
	Beckton Cherokee N N479	BFCK Cherokee Cnyn 4912	Scr.	<b>38</b>
<b>BECKTON SUSAN R022 CQ</b>		Beckton Dinah C440 NM	Fr.	<b>5.0</b>
	Beckton Susan N023 JE	Beckton Jules L429		
		Beckton Susan L258 LR		

RAAA HerdBuilder index: **164** (Top 11% of all RA bulls)

RAAA GridMaster index: **52** (Top 28% of all RA bulls)

<b>DAM</b>	Age	3	Calv.Ease	BW	WW	YW	Milk	HPG	Stay	Maint.En.	
	Wt	<b>915</b>	EPDs	<b>11</b>	<b>-5.1</b>	<b>48</b>	<b>74</b>	<b>29</b>	<b>9</b>	<b>15</b>	<b>-6.0</b>
	Wean Pct.	<b>68%</b>	Acc.	(.67)	(.76)	(.73)	(.72)	(.65)	(.28)	(.22)	(.67)
	Cow Eff.	<b>144</b>	Marb	<b>+.53</b>	(.26)	REA	<b>+.16</b>	(.22)	Bfat	<b>+.02</b>	(.35)

★★★★★ for Low Maintenance, Growth, Gainability, Marbling, Rib-eye area, High Cow Efficiency, Calving Ease, Stayability.

**A-4 BECKTON ACCENT Y312 N3**  
1-A 100% # 1451236 Tattoo: BKT1 Y312

Birth: 3-25-11	Beckton Cody K1 P014	Beckton Cody KH M390	BWt	<b>69</b>
	Beckton Rose M126 WR	Beckton Rose M126 WR	WR	<b>109</b>
<b>BECKTON ACCENT U777 C2</b>	Ref. A-1	Beckton Cherokee N N479	ADG	<b>4.20</b>
	Beckton Susan R022 CQ	Beckton Susan N023 JE	YR	<b>112</b>
	Beckton Nebula P P707	Beckton Nebula M045	Scr.	<b>38</b>
<b>BKT LARKEISA S055 NB</b>		Beckton Lana M809 EP	Fr.	<b>5.0</b>
	Beckton Larkeisa P688 CH	Beckton Champ R3 H338		
		BKT Larkeisa J564 HR		

RAAA HerdBuilder index: **211** (Top 2% of all RA bulls)

RAAA GridMaster index: **55** (Top 4% of all RA bulls)

<b>DAM</b>	Age	5	Calv.Ease	BW	WW	YW	Milk	HPG	Stay	Maint.En.	
	Wt	<b>995</b>	EPDs	<b>15</b>	<b>-6.4</b>	<b>51</b>	<b>81</b>	<b>26</b>	<b>10</b>	<b>18</b>	<b>-6.6</b>
	Wean Pct.	<b>63%</b>	Acc.	(.31)	(.60)	(.50)	(.48)	(.27)	(.13)	(.08)	(.19)
	Cow Eff.	<b>132</b>	Marb	<b>+.70</b>	(.18)	REA	<b>+.03</b>	(.16)	Bfat	<b>+.08</b>	(.29)

★★★★★ for Low Maintenance, Growth, Gainability, Marbling, High Cow Efficiency, Calving Ease, Stayability.

**A-2 BECKTON ACCENT W180 C2**  
1-A 100% # 1331776 Tattoo: BSF9 W180

Birth: 3-12-09	Beckton Cody KH M390	Beckton Cody K G701	BWt	<b>77</b>
	Beckton Rose M126 WR	Beckton Tamara J124 HR	WR	<b>116</b>
<b>BECKTON CODY K1 P014</b>	Ref. A	Beckton Warrior T C371	ADG	<b>4.23</b>
	Beckton Rose D741 LN	Beckton Rose D741 LN	YR	<b>114</b>
	Beckton Cherokee N N479	BFCK Cherokee Cnyn 4912	Scr.	<b>39</b>
<b>BECKTON CHRISTY R046 CQ</b>		Beckton Dinah C440 NM	Fr.	<b>5.5</b>
	Beckton Christy N740 HR	Beckton Herald FJ J776		
		Beckton Christy K141 VG		

RAAA HerdBuilder index: **163** (Top 12% of all RA bulls)

RAAA GridMaster index: **54** (Top 8% of all RA bulls)

<b>DAM</b>	Age	4	Calv.Ease	BW	WW	YW	Milk	HPG	Stay	Maint.En.	
	Wt	<b>1140</b>	EPDs	<b>11</b>	<b>-4.5</b>	<b>70</b>	<b>112</b>	<b>23</b>	<b>12</b>	<b>14</b>	<b>-1.3</b>
	Wean Pct.	<b>57%</b>	Acc.	(.57)	(.72)	(.67)	(.67)	(.55)	(.17)	(.19)	(.64)
	Cow Eff.	<b>121</b>	Marb	<b>+.56</b>	(.25)	REA	<b>+.41</b>	(.22)	Bfat	<b>+.05</b>	(.37)

★★★★★ for Low Maintenance, Growth, Gainability, Marbling, Rib-eye area, High Cow Efficiency, Calving Ease, Stayability.

**A-5 BECKTON ACCENT Z506 J3**  
1-A 100% # 1544593 Tattoo: BKT2 Z506

Birth: 3-26-12	Beckton Cody K1 P014	Beckton Cody KH M390	BWt	<b>72</b>
	Beckton Rose M126 WR	Beckton Rose M126 WR	WR	<b>111</b>
<b>BECKTON ACCENT W180 C2</b>	Ref. A-2	Beckton Cherokee N N479	ADG	<b>3.86</b>
	Beckton Christy R046 CQ	Beckton Christy N740 HR	YR	<b>109</b>
	Beckton Julio L233	Beckton Julian G1 J526	Scr.	<b>36</b>
<b>BECKTON SUSAN P857 JO</b>		Beckton Rose J725 EP	Fr.	<b>5.5</b>
	Beckton Susan G199 CO	Beckton Copper J E616		
		Beckton Susan E140 TP		

RAAA HerdBuilder index: **159** (Top 9% of all RA bulls)

RAAA GridMaster index: **53** (Top 7% of all RA bulls)

<b>DAM</b>	Age	8	Calv.Ease	BW	WW	YW	Milk	HPG	Stay	Maint.En.	
	Wt	<b>1010</b>	EPDs	<b>10</b>	<b>-4.2</b>	<b>59</b>	<b>93</b>	<b>30</b>	<b>7</b>	<b>14</b>	<b>-3.0</b>
	Wean Pct.	<b>65%</b>	Acc.	(.21)	(.37)	(.33)	(.37)	(.21)	(.11)	(.12)	(.25)
	Cow Eff.	<b>138</b>	Marb	<b>+.51</b>	(.18)	REA	<b>+.16</b>	(.17)	Bfat	<b>+.06</b>	(.15)

★★★★★ for Low Maintenance, Growth, Marbling, Rib-eye area, High Cow Efficiency, Calving Ease, Stayability.

**A-3 BECKTON ACCENT Y260 L3**  
1-A 100% # 1451513 Tattoo: BKT1 Y260

Birth: 3-24-11	Beckton Cody K1 P014	Beckton Cody KH M390	BWt	<b>68</b>
	Beckton Rose M126 WR	Beckton Rose M126 WR	WR	<b>111</b>
<b>BECKTON ACCENT W180 C2</b>	Ref. A-2	Beckton Cherokee N N479	ADG	<b>2.95</b>
	Beckton Christy R046 CQ	Beckton Christy N740 HR	YR	<b>108</b>
	Beckton Loki CL S284	Beckton Loki C M740	Scr.	<b>34</b>
<b>BECKTON LANA W463 L</b>		Beckton Lakme J460 LT	Fr.	<b>5.5</b>
	Beckton Lana R327 EP	Beckton Epic KM M115		
		Beckton Lana K840 LN		

RAAA HerdBuilder index: **184** (Top 3% of all RA bulls)

RAAA GridMaster index: **53** (Top 10% of all RA bulls)

<b>DAM</b>	Age	2	Calv.Ease	BW	WW	YW	Milk	HPG	Stay	Maint.En.	
	Wt	<b>815</b>	EPDs	<b>9</b>	<b>-2.6</b>	<b>72</b>	<b>110</b>	<b>22</b>	<b>9</b>	<b>18</b>	<b>-2.0</b>
	Wean Pct.	<b>70%</b>	Acc.	(.28)	(.55)	(.48)	(.47)	(.24)	(.01)	(.01)	(.04)
	Cow Eff.	<b>146</b>	Marb	<b>+.50</b>	(.16)	REA	<b>+.10</b>	(.14)	Bfat	<b>+.01</b>	(.29)

★★★★★ for Low Maintenance, Growth, Marbling, High Cow Efficiency, Calving Ease, Stayability.

**C-1 BECKTON CLIFFTOP W692 E3**  
1-A 100% # 1332252 Tattoo: BKT9 W692

Birth: 4-12-09	Beckton Clifftop T C075	BJR Topper 5241	BWt	<b>72</b>
	Beckton Christy K209 CO	Beckton Barmaid A761 TR	WR	<b>116</b>
<b>BKT CLIFFTOP TP R288</b>	Ref. C	Beckton Copper JT G095	ADG	<b>4.10</b>
	Beckton Epic KM M115	Beckton Christy A111 VQ	YR	<b>115</b>
	Beckton Lydia M607 LO	Beckton Epic K F075	Scr.	<b>40</b>
<b>BECKTON LYDIA S274 EP</b>		Beckton Minerva F495 CH	Fr.	<b>5.0</b>
		Beckton Loki F251		
		Beckton Lydia J801 CD		

RAAA HerdBuilder index: **178** (Top 7% of all RA bulls)

RAAA GridMaster index: **53** (Top 12% of all RA bulls)

<b>DAM</b>	Age	3	Calv.Ease	BW	WW	YW	Milk	HPG	Stay	Maint.En.	
	Wt	<b>980</b>	EPDs	<b>11</b>	<b>-5.1</b>	<b>43</b>	<b>82</b>	<b>28</b>	<b>10</b>	<b>16</b>	<b>-3.1</b>
	Wean Pct.	<b>63%</b>	Acc.	(.59)	(.73)	(.69)	(.68)	(.56)	(.10)	(.13)	(.62)
	Cow Eff.	<b>132</b>	Marb	<b>+.65</b>	(.27)	REA	<b>-.24</b>	(.24)	Bfat	<b>+.08</b>	(.38)

★★★★★ for Low Maintenance, Growth, Gainability, Marbling, High Cow Efficiency, Calving Ease, Stayability.

• Reference Sires •

**C-2 BECKTON CLIFFTOP Y012 C4**  
1-A 100% # 1451482 Tattoo: BKT1 Y012

Birth: 2-20-11	BKT Clifftop TP R288	Beckton Clifftop T C075	BWt <b>53</b>
		Beckton Christy K209 CO	WR <b>108</b>
<b>BECKTON CLIFFTOP W692 E3</b>	Ref. C-1	Beckton Epic KM M115	ADG <b>3.25</b>
	Beckton Lydia S274 EP	Beckton Lydia M607 LO	YR <b>112</b>
		Beckton Clifftop T C075	Scr. <b>34</b>
<b>BECKTON LANA W240 C</b>	BKT Clifftop TP R288	Beckton Christy K209 CO	Fr. <b>5.0</b>
	Beckton Lana L923 CD	Beckton Cody K G701	
		Beckton Lana D232 HV	

RAAA HerdBuilder index: **195** (Top 2% of all RA bulls)

RAAA GridMaster index: **51** (Top 26% of all RA bulls)

<b>DAM</b>	Calv.Ease	BW	WW	YW	Milk	HPG	Stay	Maint.En.
Age <b>2</b>	EPDs <b>12</b>	<b>-5.2</b>	<b>45</b>	<b>81</b>	<b>26</b>	<b>12</b>	<b>17</b>	<b>-6.4</b>
Wt <b>780</b>	Acc. (.28)	(.55)	(.47)	(.45)	(.23)	(.01)	(.01)	(.04)
Wean Pct. <b>64%</b>								
Cow Eff. <b>134</b>	Marb <b>+.46</b>	(.16)	REA <b>+.03</b>	(.14)	Bfat <b>+.03</b>	(.27)		

★★★★★ for Low Maintenance, Growth, Marbling, High Cow Efficiency, Calving Ease, Stayability.

**C-4 TR DOUBLE EAGLE ZT220**  
1-A 100% # 1519714 Tattoo: TR2A2 ZT22

Birth: 3-20-12	BFCK Cherokee Cnyn 4912	Buf Crk Chf 824-1658	BWt <b>76</b>
		MRM 1431 8611 9109	WR <b>124</b>
<b>TR RICARDO DOS</b>	Ref.	Beckton Julian GG B571	ADG <b>2.97</b>
	TR Dyna LT111	BSF Dyna JT976	YR <b>117</b>
		Beckton Justice CH M056	Scr. <b>NA</b>
<b>BECKTON LANA U182 JC</b>	Beckton Justice C1 R483	Beckton Tamara J124 HR	Fr. <b>4.5</b>
	Beckton Lana H544 WR	Beckton Warrior TC E801	
		Beckton Lana E545 CL	

RAAA HerdBuilder index: **175** (Top 5% of all RA bulls)

RAAA GridMaster index: **52** (Top 13% of all RA bulls)

<b>DAM</b>	Calv.Ease	BW	WW	YW	Milk	HPG	Stay	Maint.En.
Age <b>4</b>	EPDs <b>12</b>	<b>-4.2</b>	<b>64</b>	<b>98</b>	<b>19</b>	<b>12</b>	<b>15</b>	<b>-8.5</b>
Wt <b>NA</b>	Acc. (.28)	(.48)	(.39)	(.38)	(.23)	(.08)	(.01)	(.19)
Wean Pct. <b>NA%</b>								
Cow Eff. <b>NA</b>	Marb <b>+.56</b>	(.19)	REA <b>+.37</b>	(.17)	Bfat <b>+.01</b>	(.30)		

★★★★★ for Low Maintenance, Growth, Marbling, Rib-eye area, Calving Ease, Stayability.

**C-3 BECKTON CLIFFTOP Z824 C4**  
1-A 100% # 1544600 Tattoo: BKT2 Z824

Birth: 4-16-12	BKT Clifftop TP R288	Beckton Clifftop T C075	BWt <b>88</b>
		Beckton Christy K209 CO	WR <b>104</b>
<b>BECKTON CLIFFTOP W577 E3</b>	Ref. C	Beckton Epic KM M115	ADG <b>3.17</b>
	BKT Pine Marie R213 EP	BKT Pine Marie H175 NP	YR <b>105</b>
		BFCK Cherokee Cnyn 4912	Scr. <b>36</b>
<b>BECKTON TAMARA R175 CQ</b>	Beckton Cherokee N N479	Beckton Dinah C440 NM	Fr. <b>5.0</b>
	Beckton Tamara N765 CO	Beckton Copper JT G095	
		Beckton Tamara HA54 LN	

RAAA HerdBuilder index: **171** (Top 5% of all RA bulls)

RAAA GridMaster index: **51** (Top 35% of all RA bulls)

<b>DAM</b>	Calv.Ease	BW	WW	YW	Milk	HPG	Stay	Maint.En.
Age <b>7</b>	EPDs <b>10</b>	<b>-2.0</b>	<b>43</b>	<b>70</b>	<b>30</b>	<b>12</b>	<b>17</b>	<b>-5.0</b>
Wt <b>1020</b>	Acc. (.20)	(.35)	(.32)	(.36)	(.20)	(.13)	(.09)	(.25)
Wean Pct. <b>61%</b>								
Cow Eff. <b>128</b>	Marb <b>+.66</b>	(.10)	REA <b>+.11</b>	(.09)	Bfat <b>+.05</b>	(.14)		

★★★★★ for Low Maintenance, Marbling, High Cow Efficiency, Calving Ease, Stayability.

**D-1 BECKTON DOMINOR W640 C5**  
1-A 100% # 1331787 Tattoo: BSF9 W640

Birth: 4-7-09	Beckton Dominor ZC M919	Beckton Dominor Z E401	BWt <b>80</b>
		Beckton Barmaid J012 CO	WR <b>109</b>
<b>BECKTON DOMINOR Z1 R610</b>	Ref. D	Beckton Loki F251	ADG <b>3.65</b>
	Beckton Sierra K557 LO	Beckton Sierra C157 CL	YR <b>108</b>
		BFCK Cherokee Cnyn 4912	Scr. <b>35</b>
<b>BECKTON MONA R166 CQ</b>	Beckton Cherokee N N479	Beckton Dinah C440 NM	Fr. <b>5.5</b>
	Beckton Mona N342 HU	Beckton Hustler C2 L079	
		Beckton Mona L890 CO	

RAAA HerdBuilder index: **174** (Top 8% of all RA bulls)

RAAA GridMaster index: **54** (Top 7% of all RA bulls)

<b>DAM</b>	Calv.Ease	BW	WW	YW	Milk	HPG	Stay	Maint.En.
Age <b>4</b>	EPDs <b>14</b>	<b>-6.7</b>	<b>42</b>	<b>66</b>	<b>25</b>	<b>12</b>	<b>14</b>	<b>-0.5</b>
Wt <b>1160</b>	Acc. (.54)	(.72)	(.67)	(.67)	(.52)	(.10)	(.13)	(.64)
Wean Pct. <b>54%</b>								
Cow Eff. <b>114</b>	Marb <b>+.70</b>	(.25)	REA <b>-.06</b>	(.22)	Bfat <b>+.06</b>	(.37)		

★★★★★ for Low Maintenance, Growth, Marbling, Calving Ease, Stayability.



Dianne Vanet

Beckton Epic K4 N795  
Sire of Beckton Epic U749 (E-1); Ref. Sire E-1

**E-1 BECKTON EPIC U749 D5**  
1-A 100% # 1259558 Tattoo: BKT8 U749

Birth: 4-9-08	Beckton Epic KJ J722	Beckton Epic K F075	BWt <b>77</b>
		Beckton Lana F891 JL	WR <b>111</b>
<b>BECKTON EPIC K4 N795</b>	Ref. E	Beckton Epic D404	ADG <b>4.49</b>
	Beckton Sierra J789 EP	Beckton Sierra C157 CL	YR <b>112</b>
		Beckton Dominor ZC M919	Scr. <b>34</b>
<b>BECKTON DENISE R308 DM</b>	Beckton Dominor ZC M919	Beckton Barmaid J012 CO	Fr. <b>5.5</b>
	Beckton Denise L639 JL	Beckton Julian GG B571	
		Beckton Denise J550 CD	

RAAA HerdBuilder index: **102** (Top 55% of all RA bulls)

RAAA GridMaster index: **49** (Top 69% of all RA bulls)

<b>DAM</b>	Calv.Ease	BW	WW	YW	Milk	HPG	Stay	Maint.En.
Age <b>3</b>	EPDs <b>10</b>	<b>-2.4</b>	<b>51</b>	<b>102</b>	<b>20</b>	<b>4</b>	<b>11</b>	<b>4.8</b>
Wt <b>1025</b>	Acc. (.61)	(.76)	(.72)	(.72)	(.59)	(.32)	(.20)	(.66)
Wean Pct. <b>59%</b>								
Cow Eff. <b>123</b>	Marb <b>+.54</b>	(.29)	REA <b>+.50</b>	(.25)	Bfat <b>+.02</b>	(.39)		

★★★★★ for Growth, Gainability, Marbling, Rib-eye area, High Cow Efficiency, Calving Ease.

• Reference Sires •

**E-2 BECKTON EPIC X330 L6**  
1-A 100% # 1382765 Tattoo: BKT0 X330

Birth: 3-20-10	Beckton Epic K4 N795	Beckton Epic KJ J722	BWt	<b>71</b>
		Beckton Sierra J789 EP	WR	<b>103</b>
<b>BECKTON EPIC T330 L5</b>	Beckton Belga K202 LN	Beckton Lancer T A664	ADG	<b>3.71</b>
Ref. E		Beckton Belga D460 KR	YR	<b>108</b>
	Beckton Lancer F442 T	Beckton Lancer T A664	Scr.	<b>37</b>
<b>BECKTON KIT R503 LN</b>	Beckton Kit F468 JL	Bkt Suffeina A828 DM	Fr.	<b>5.5</b>
		Beckton Julian GG B571		
		Beckton Kit A517 NP		

RAAA HerdBuilder index: **143**(Top **21%** of all RA bulls)

RAAA GridMaster index: **52**(Top **24%** of all RA bulls)

<b>DAM</b>	Age	5	Calv.Ease	BW	WW	YW	Milk	HPG	Stay	Maint.En.	
	Wt	<b>940</b>	EPDs	<b>9</b>	<b>-3.8</b>	<b>59</b>	<b>98</b>	<b>19</b>	<b>6</b>	<b>13</b>	<b>-3.8</b>
	Wean Pct.	<b>65%</b>	Acc.	(.41)	(.67)	(.60)	(.59)	(.38)	(.16)	(.10)	(.55)
	Cow Eff.	<b>137</b>	Marb	<b>+0.66</b>	(.26)	REA	<b>+0.35</b>	(.23)	Bfat	<b>+0.02</b>	(.36)

★★★★★ for Low Maintenance, Growth, Marbling, Rib-eye area, High Cow Efficiency, Calving Ease, Stayability.

**E-5 BECKTON EPIC Y484 N6**  
1-A 100% # 1451237 Tattoo: BKT1 Y484

Birth: 4-8-11	Beckton Epic K4 N795	Beckton Epic KJ J722	BWt	<b>77</b>
		Beckton Sierra J789 EP	WR	<b>116</b>
<b>BECKTON EPIC U749 D5</b>	Beckton Denise R308 DM	Beckton Dominor ZC M919	ADG	<b>3.60</b>
Ref. E-1		Beckton Denise L639 JL	YR	<b>116</b>
	Beckton Nebula P P707	Beckton Nebula M045	Scr.	<b>38</b>
<b>BECKTON LYDIA S069 NB</b>	Beckton Lydia P583 WR	Beckton Lana M809 EP	Fr.	<b>5.5</b>
		Beckton Warrior CL M686		
		Beckton Lydia M121 WR		

RAAA HerdBuilder index: **166** (Top **7%** of all RA bulls)

RAAA GridMaster index: **51**(Top **35%** of all RA bulls)

<b>DAM</b>	Age	5	Calv.Ease	BW	WW	YW	Milk	HPG	Stay	Maint.En.	
	Wt	<b>980</b>	EPDs	<b>10</b>	<b>-1.9</b>	<b>66</b>	<b>116</b>	<b>16</b>	<b>9</b>	<b>16</b>	<b>-1.4</b>
	Wean Pct.	<b>71%</b>	Acc.	(.31)	(.58)	(.48)	(.46)	(.26)	(.07)	(.06)	(.19)
	Cow Eff.	<b>149</b>	Marb	<b>+0.56</b>	(.18)	REA	<b>+0.45</b>	(.16)	Bfat	<b>+0.00</b>	(.30)

★★★★★ for Low Maintenance, Growth, Marbling, Rib-eye area, High Cow Efficiency, Calving Ease, Stayability.

**E-3 BECKTON EPIC X464 L5**  
1-A 100% # 1382853 Tattoo: BSF0 X464

Birth: 3-27-10	Beckton Epic KM M115	Beckton Epic K F075	BWt	<b>73</b>
		Beckton Minerva F495 CH	WR	<b>117</b>
<b>BECKTON EPIC K6 S569</b>	Beckton Sierra N703 LM	Beckton Laramie L044	ADG	<b>4.14</b>
Ref. E		Beckton Sierra L887 LN	YR	<b>115</b>
	Beckton Lancer T3 J396	Beckton Lancer TL G626	Scr.	<b>39</b>
<b>BECKTON LANA M393 LN</b>	Beckton Lana F081 LN	Beckton Angel G356 HR	Fr.	<b>5.5</b>
		Beckton Lancer TS D390		
		Beckton Lana D550 CB		

RAAA HerdBuilder index: **124**(Top **35%** of all RA bulls)

RAAA GridMaster index: **49**(Top **65%** of all RA bulls)

<b>DAM</b>	Age	8	Calv.Ease	BW	WW	YW	Milk	HPG	Stay	Maint.En.	
	Wt	<b>1145</b>	EPDs	<b>10</b>	<b>-2.9</b>	<b>53</b>	<b>95</b>	<b>37</b>	<b>6</b>	<b>12</b>	<b>-2.4</b>
	Wean Pct.	<b>61%</b>	Acc.	(.39)	(.61)	(.53)	(.51)	(.35)	(.17)	(.15)	(.51)
	Cow Eff.	<b>128</b>	Marb	<b>+0.42</b>	(.21)	REA	<b>+0.25</b>	(.19)	Bfat	<b>-0.01</b>	(.32)

★★★★★ for Low Maintenance, Growth, Gainability, Marbling, Rib-eye area, High Cow Efficiency, Calving Ease.

**E-6 BECKTON EPIC Z434 L6**  
1-A 100% # 1544571 Tattoo: BKT2 Z434

Birth: 3-22-12	Beckton Epic K4 N795	Beckton Epic KJ J722	BWt	<b>76</b>
		Beckton Sierra J789 EP	WR	<b>120</b>
<b>BECKTON EPIC U749 D5</b>	Beckton Denise R308 DM	Beckton Dominor ZC M919	ADG	<b>4.35</b>
Ref. E-1		Beckton Denise L639 JL	YR	<b>120</b>
	Beckton Lancer TH K417	Beckton Lancer T A664	Scr.	<b>35</b>
<b>BECKTON SIERRA N403 LN</b>	Beckton Sierra J659 DM	Beckton Angel G356 HR	Fr.	<b>6.0</b>
		Beckton Dominor ZR G223		
		Beckton Sierra G671 DM		

RAAA HerdBuilder index: **117**(Top **40%** of all RA bulls)

RAAA GridMaster index: **50**(Top **57%** of all RA bulls)

<b>DAM</b>	Age	9	Calv.Ease	BW	WW	YW	Milk	HPG	Stay	Maint.En.	
	Wt	<b>1195</b>	EPDs	<b>9</b>	<b>-2.5</b>	<b>50</b>	<b>100</b>	<b>29</b>	<b>8</b>	<b>12</b>	<b>4.3</b>
	Wean Pct.	<b>60%</b>	Acc.	(.21)	(.36)	(.33)	(.37)	(.21)	(.14)	(.11)	(.25)
	Cow Eff.	<b>125</b>	Marb	<b>+0.56</b>	(.18)	REA	<b>+0.36</b>	(.17)	Bfat	<b>+0.00</b>	(.15)

★★★★★ for Growth, Gainability, Marbling, Rib-eye area, High Cow Efficiency, Calving Ease.

**E-4 BECKTON EPIC X816 C6**  
1-A 100% # 1382935 Tattoo: BSF0 X816

Birth: 5-5-10	Beckton Epic K4 N795	Beckton Epic KJ J722	BWt	<b>60</b>
		Beckton Sierra J789 EP	WR	<b>110</b>
<b>BECKTON EPIC T330 L5</b>	Beckton Belga K202 LN	Beckton Lancer T A664	ADG	<b>3.67</b>
Ref. E		Beckton Belga D460 KR	YR	<b>106</b>
	Beckton Cherokee N N479	BFCK Cherokee Cnyn 4912	Scr.	<b>33</b>
<b>BECKTON MONA R198 CQ</b>	Beckton Mona N009 JE	Beckton Dinah C440 NM	Fr.	<b>5.5</b>
		Beckton Jules L429		
		Beckton Mona L618 LR		

RAAA HerdBuilder index: **144**(Top **20%** of all RA bulls)

RAAA GridMaster index: **52**(Top **22%** of all RA bulls)

<b>DAM</b>	Age	5	Calv.Ease	BW	WW	YW	Milk	HPG	Stay	Maint.En.	
	Wt	<b>1210</b>	EPDs	<b>13</b>	<b>-6.0</b>	<b>42</b>	<b>78</b>	<b>31</b>	<b>9</b>	<b>13</b>	<b>1.3</b>
	Wean Pct.	<b>54%</b>	Acc.	(.34)	(.59)	(.50)	(.49)	(.30)	(.08)	(.06)	(.37)
	Cow Eff.	<b>114</b>	Marb	<b>+0.65</b>	(.19)	REA	<b>+0.11</b>	(.17)	Bfat	<b>+0.04</b>	(.30)

★★★★★ for Low Maintenance, Growth, Marbling, Calving Ease, Stayability.

**E-7 BECKTON EPIC Z674 E6**  
1-2 100% # 1544788 Tattoo: BKT2 Z674

Birth: 4-2-12	Beckton Epic K4 N795	Beckton Epic KJ J722	BWt	<b>80</b>
		Beckton Sierra J789 EP	WR	<b>115</b>
<b>BECKTON EPIC U749 D5</b>	Beckton Denise R308 DM	Beckton Dominor ZC M919	ADG	<b>3.75</b>
Ref. E-1		Beckton Denise L639 JL	YR	<b>114</b>
	Beckton Epic K6 S569	Beckton Epic KM M115	Scr.	<b>32</b>
<b>BECKTON INDIGO U504 EP</b>	Beckton Indigo S016 NB	Beckton Sierra N703 LM	Fr.	<b>5.5</b>
		Beckton Nebula P P707		
		Beckton Indigo P062 NB		

RAAA HerdBuilder index: **152**(Top **12%** of all RA bulls)

RAAA GridMaster index: **52**(Top **20%** of all RA bulls)

<b>DAM</b>	Age	4	Calv.Ease	BW	WW	YW	Milk	HPG	Stay	Maint.En.	
	Wt	<b>825</b>	EPDs	<b>11</b>	<b>-2.5</b>	<b>53</b>	<b>97</b>	<b>26</b>	<b>7</b>	<b>14</b>	<b>-3.7</b>
	Wean Pct.	<b>81%</b>	Acc.	(.20)	(.36)	(.32)	(.36)	(.19)	(.12)	(.07)	(.22)
	Cow Eff.	<b>170</b>	Marb	<b>+0.74</b>	(.12)	REA	<b>+0.20</b>	(.09)	Bfat	<b>+0.03</b>	(.16)

★★★★★ for Low Maintenance, Growth, Marbling, Rib-eye area, High Cow Efficiency, Calving Ease, Stayability.

• Reference Sires •



Beckton Julian B571  
Sire of lots 1, 2, 3, 66, 132, 169; Ref. Sire J-1

**J-1 BECKTON JULIAN GG B571**  
1-A 100% # 387580 Tattoo: WF2 B571

Birth: 3-27-92

Beckton Julian 6592	Beckton Trojan 5253	BWt	<b>65</b>
	Lchmn Christy 2339	WR	<b>113</b>
<b>BECKTON JULIAN 7526G</b>	Beckton Gisa 4454	ADG	<b>3.18</b>
Ref. Bkt Belga 6746 GS	Beckton Lalaxigu -2	YR	<b>112</b>
	Beckton Julian 6592	Scr.	<b>NA</b>
	Bkt Belga 6746 GS	Fr.	<b>5.0</b>
	Beckton Xime 4736		
	Beckton Marwa -K		

RAAA HerdBuilder index: **228** (Top 1% of all RA bulls)  
RAAA GridMaster index: **54** (Top 11% of all RA bulls)

<b>DAM</b>	Calv.Ease	BW	WW	YW	Milk	HPG	Stay	Maint.En.
Age <b>3</b>	EPDs <b>24</b>	<b>-6.2</b>	<b>28</b>	<b>55</b>	<b>15</b>	<b>13</b>	<b>21</b>	<b>-6.2</b>
Wt <b>1015</b>	Acc. (.92)	(.93)	(.92)	(.92)	(.91)	(.88)	(.82)	(.64)
Wean Pct. <b>56%</b>								
Cow Eff. <b>118</b>	Marb <b>+.20</b>	(.89)	REA <b>+.30</b>	(.89)	Bfat <b>+.02</b>	(.90)		

★★★★★ for Low Maintenance, Marbling, Rib-eye area, High Cow Efficiency, Calving Ease, Stayability.

**E-8 BECKTON EMPEROR Z750 N3**  
1-A 100% # 1545192 Tattoo: BSF2 Z750

Birth: 4-7-12

Beckton Emperor R100	Beckton Epic K4 N795	BWt	<b>70</b>
	Beckton Tamara N180 JO	WR	<b>123</b>
<b>BECKTON EMPEROR T641 E2</b>	Beckton Epic K3 M606	ADG	<b>4.13</b>
Ref. E Beckton Vernice R416 EP	Beckton Vernice K482 HD	YR	<b>119</b>
	Beckton Neptune R2 K065	Scr.	<b>38</b>
	Beckton Belga K285 JL	Fr.	<b>5.5</b>
	Beckton Epic KM M115		
	Beckton Lana M393 LN		

RAAA HerdBuilder index: **153** (Top 12% of all RA bulls)  
RAAA GridMaster index: **53** (Top 10% of all RA bulls)

<b>DAM</b>	Calv.Ease	BW	WW	YW	Milk	HPG	Stay	Maint.En.
Age <b>4</b>	EPDs <b>13</b>	<b>-4.8</b>	<b>55</b>	<b>97</b>	<b>22</b>	<b>6</b>	<b>13</b>	<b>-2.7</b>
Wt <b>1260</b>	Acc. (.21)	(.36)	(.32)	(.36)	(.20)	(.13)	(.11)	(.23)
Wean Pct. <b>56%</b>								
Cow Eff. <b>118</b>	Marb <b>+.48</b>	(.12)	REA <b>-.13</b>	(.11)	Bfat <b>+.04</b>	(.14)		

★★★★★ for Low Maintenance, Growth, Gainability, Marbling, High Cow Efficiency, Calving Ease, Stayability.

**J-2 BKT JAVELIN 7466 R**  
1-A 100% # 173533 Tattoo: WF4 7466

Birth: 3-17-84

Beckton Trojan 5253	Beckton Dito 4374	BWt	<b>66</b>
	Bkt Mana Anexa 4473	WR	<b>107</b>
<b>BECKTON JAVELIN 6587</b>	Bkt Ry Mtn 1195	ADG	<b>3.56</b>
Ref. Beckton Ileximka -3	Beckton Lsa 1632 96	YR	<b>114</b>
	Choctaw Chief 373	Scr.	<b>NA</b>
	Bkt Osalaxi -L	Fr.	<b>NA</b>
	Beckton Raza 2308-N		
	Beckton Rose 6807 RZ		
	Bkt Baya Rose 5195		
	Beckton Jiba 1067-C		
	Bkt Ximi Rose 4218		

RAAA HerdBuilder index: **167** (Top 11% of all RA bulls)  
RAAA GridMaster index: **50** (Top 61% of all RA bulls)

<b>DAM</b>	Calv.Ease	BW	WW	YW	Milk	HPG	Stay	Maint.En.
Age <b>2</b>	EPDs <b>15</b>	<b>-6.2</b>	<b>-6</b>	<b>-5</b>	<b>11</b>	<b>7</b>	<b>7</b>	<b>-13.0</b>
Wt <b>791</b>	Acc. (.64)	(.80)	(.72)	(.70)	(.64)	(.46)	(.56)	(.45)
Wean Pct. <b>56%</b>								
Cow Eff. <b>112</b>	Marb <b>-.04</b>	(.52)	REA <b>-.42</b>	(.56)	Bfat <b>-.01</b>	(.46)		

★★★★★ for Low Maintenance, Calving Ease.

**H-1 BECKTON HERITAGE X403 L3**  
1-A 100% # 1382810 Tattoo: BSF0 X403

Birth: 3-24-10

Beckton Heritage N013	Beckton Hustler C2 L079	BWt	<b>68</b>
	Beckton Lana L007 JL	WR	<b>106</b>
<b>BECKTON HERITAGE T270 J2</b>	Beckton Julian GG B571	ADG	<b>3.57</b>
Ref. H Beckton Coca P602 JL	Beckton Coca J270 CD	YR	<b>105</b>
	Beckton Lancer TA664	Scr.	<b>37</b>
	Beckton Lana Z275 ZN	Fr.	<b>5.5</b>
	Beckton Clifftop T C075		
	Beckton Indigo A735 LN		

RAAA HerdBuilder index: **174** (Top 8% of all RA bulls)  
RAAA GridMaster index: **56** (Top 3% of all RA bulls)

<b>DAM</b>	Calv.Ease	BW	WW	YW	Milk	HPG	Stay	Maint.En.
Age <b>12</b>	EPDs <b>12</b>	<b>-4.8</b>	<b>66</b>	<b>100</b>	<b>18</b>	<b>9</b>	<b>13</b>	<b>-4.1</b>
Wt <b>1045</b>	Acc. (.42)	(.61)	(.54)	(.51)	(.35)	(.16)	(.15)	(.50)
Wean Pct. <b>59%</b>								
Cow Eff. <b>123</b>	Marb <b>+.66</b>	(.20)	REA <b>-.01</b>	(.18)	Bfat <b>+.07</b>	(.31)		

★★★★★ for Low Maintenance, Marbling, High Cow Efficiency, Calving Ease, Stayability.

**J-3 BECKTON JULIAN W841 J5**  
1-A 100% # 1331638 Tattoo: BSF9 W841

Birth: 4-30-09

Beckton Julian GJ P535	Beckton Julian 7526G	BWt	<b>66</b>
	Beckton Mona D086 JL	WR	<b>102</b>
<b>BECKTON JULIAN G5 S107</b>	Beckton Dominor ZC M919	ADG	<b>3.51</b>
Ref. J Beckton Minola P826 DM	Beckton Minola M641 WR	YR	<b>103</b>
	Beckton Julian 7526G	Scr.	<b>36</b>
	Bkt Marta 9A13 JL	Fr.	<b>4.5</b>
	Beckton Julian GG B571		
	Beckton Christy J743 JL		
	Beckton Christy A111 VQ		
	Beckton Vanquish 9977		
	Bkt Christy 9A01 CL		

RAAA HerdBuilder index: **196** (Top 2% of all RA bulls)  
RAAA GridMaster index: **53** (Top 7% of all RA bulls)

<b>DAM</b>	Calv.Ease	BW	WW	YW	Milk	HPG	Stay	Maint.En.
Age <b>10</b>	EPDs <b>13</b>	<b>-3.8</b>	<b>52</b>	<b>88</b>	<b>14</b>	<b>13</b>	<b>15</b>	<b>-3.5</b>
Wt <b>1240</b>	Acc. (.41)	(.46)	(.45)	(.46)	(.37)	(.18)	(.16)	(.54)
Wean Pct. <b>49%</b>								
Cow Eff. <b>103</b>	Marb <b>+.50</b>	(.20)	REA <b>+.11</b>	(.18)	Bfat <b>+.10</b>	(.31)		

★★★★★ for Low Maintenance, Marbling, Calving Ease, Stayability.

• Reference Sires •

**J-4 BECKTON JULIAN X465 J5**  
1-A 100% # 1382724 Tattoo: BKT0 X465

Birth: 3-27-10

Beckton Julian GJ P535 < Beckton Julian 7526G  
Beckton Mona D086 JL

**BECKTON JULIAN G5 S107**  
Ref. J < Beckton Dominor ZC M919  
Beckton Minola P826 DM < Beckton Minola M641 WR

Beckton Julian GG B571 < Beckton Julian 7526G  
Beckton Julia 9A13 JL

**BECKTON SUFFEINA P643 JL**  
Bkt Suffeina A828 DM < Beckton Dominor 9455  
Bkt Suffeina 9493 TT

BWt	84
WR	113
ADG	4.48
YR	114
Scr.	39
Fr.	5.5

RAAA HerdBuilder index: **184** (Top 6% of all RA bulls)  
RAAA GridMaster index: **54** (Top 9% of all RA bulls)

DAM	
Age	6
Wt	1085
Wean Pct.	62%
Cow Eff.	131

Calv.Ease	BW	WW	YW	Milk	HPG	Stay	Maint.En.	
EPDs	8	0.4	69	115	16	14	16	-5.2
Acc.	(.42)	(.67)	(.60)	(.59)	(.38)	(.18)	(.10)	(.53)

Marb **+.95** (.24) REA **-.14** (.21) Bfat **+.03** (.35)

★★★★★ for Low Maintenance, Growth, Gainability, Marbling, High Cow Efficiency, Calving Ease, Stayability.

**L-2 BECKTON LIKABLE U130 L2**  
1-A 100% # 1258774 Tattoo: BKT8 U130

Birth: 3-6-08

Beckton Lancer F442 T < Beckton Lancer T A664  
Bkt Suffeina A828 DM

**BECKTON LIKABLE S633**  
Ref. L < Beckton Julian GG B571  
Beckton Kit F468 JL < Beckton Kit A517 NP

Beckton Lancer F442 T < Beckton Lancer T A664  
Bkt Suffeina A828 DM

**BECKTON KIT S478 LN**  
Beckton Kit F468 JL < Beckton Julian GG B571  
Beckton Kit A517 NP

BWt	68
WR	100
ADG	3.93
YR	104
Scr.	35
Fr.	5.0

RAAA HerdBuilder index: **156** (Top 15% of all RA bulls)  
RAAA GridMaster index: **51** (Top 43% of all RA bulls)

DAM	
Age	2
Wt	875
Wean Pct.	54%
Cow Eff.	115

Calv.Ease	BW	WW	YW	Milk	HPG	Stay	Maint.En.	
EPDs	8	-3.4	59	89	13	8	15	-4.7
Acc.	(.61)	(.68)	(.65)	(.65)	(.53)	(.08)	(.13)	(.65)

Marb **+.43** (.28) REA **+.78** (.25) Bfat **+.05** (.38)

★★★★★ for Low Maintenance, Marbling, Rib-eye area, Calving Ease, Stayability.

**J-5 BECKTON JULIAN Z382 J7**  
1-A 100% # 1544962 Tattoo: BKT2 Z382

Birth: 3-20-12

Beckton Julian U699 L5 < Beckton Julian G1 J526  
Beckton Rose L311 LN

**BECKTON JULIAN X721 E6**  
Ref. J < Beckton Epic K6 S569  
Beckton Lana U329 EP < Beckton Lana S477 LN

Beckton Julian U699 L5 < Beckton Julian G1 J526  
Beckton Rose L311 LN

**BECKTON LARKABA X064 J**  
Beckton Larkaba U475 CT < BKT Clifftop TP R288  
Beckton Larkaba R809 NB

BWt	47
WR	125
ADG	2.99
YR	113
Scr.	33
Fr.	5.0

RAAA HerdBuilder index: **204** (Top 1% of all RA bulls)  
RAAA GridMaster index: **54** (Top 6% of all RA bulls)

DAM	
Age	2
Wt	755
Wean Pct.	80%
Cow Eff.	168

Calv.Ease	BW	WW	YW	Milk	HPG	Stay	Maint.En.	
EPDs	15	-8.5	53	84	29	13	16	-9.9
Acc.	(.17)	(.34)	(.30)	(.34)	(.16)	(.06)	(.02)	(.21)

Marb **+.37** (.15) REA **+.33** (.14) Bfat **+.03** (.12)

★★★★★ for Low Maintenance, Growth, Marbling, Rib-eye area, High Cow Efficiency, Calving Ease, Stayability.

**L-3 BECKTON LIKABLE Y124 L3**  
1-A 100% # 1451666 Tattoo: BSF1 Y124

Birth: 3-15-11

Beckton Likable S633 < Beckton Lancer F442 T  
Beckton Kit F468 JL

**BECKTON LIKABLE U130 L2**  
Ref. L-2 < Beckton Lancer F442 T  
Beckton Kit S478 LN < Beckton Kit F468 JL

Beckton Lasso P741 < Beckton Lancer T1 H080  
Beckton Ruth G534 NP

**BKT PINE MARIE S802 LO**  
BKT Pine Marie P475 LN < Beckton Lancer T4 J536  
Bkt Pine Marie LC30 CD

BWt	72
WR	109
ADG	3.50
YR	112
Scr.	38
Fr.	5.5

RAAA HerdBuilder index: **163** (Top 8% of all RA bulls)  
RAAA GridMaster index: **53** (Top 6% of all RA bulls)

DAM	
Age	5
Wt	1080
Wean Pct.	58%
Cow Eff.	121

Calv.Ease	BW	WW	YW	Milk	HPG	Stay	Maint.En.	
EPDs	11	-5.9	47	80	21	11	14	-1.8
Acc.	(.34)	(.56)	(.47)	(.46)	(.25)	(.06)	(.06)	(.19)

Marb **+.73** (.17) REA **+.21** (.15) Bfat **+.06** (.29)

★★★★★ for Low Maintenance, Growth, Marbling, Rib-eye area, High Cow Efficiency, Calving Ease, Stayability.

**L-1 BECKTON LEGEND S670**  
1-A 100% # 1119132 Tattoo: WF6 S670

Birth: 3-31-06

Beckton Lancer T A664 < Beckton Lancer 9380  
Beckton Coca 9119 TJ

**BECKTON LANCER F442 T**  
Ref. < Beckton Dominor 9455  
Bkt Suffeina A828 DM < Bkt Suffeina 9493 TT

Beckton Julian GG B571 < Beckton Julian 7526G  
Beckton Julia 9A13 JL

**BECKTON KIT F468 JL**  
Beckton Kit A517 NP < Bkt Neptune 8460 R  
BchRch Kit935 35L416

BWt	76
WR	89
ADG	3.87
YR	94
Scr.	36
Fr.	5.0

RAAA HerdBuilder index: **210** (Top 2% of all RA bulls)  
RAAA GridMaster index: **53** (Top 19% of all RA bulls)

DAM	
Age	10
Wt	NA
Wean Pct.	NA
Cow Eff.	NA

Calv.Ease	BW	WW	YW	Milk	HPG	Stay	Maint.En.	
EPDs	10	-3.9	50	68	11	8	19	-16.9
Acc.	(.66)	(.75)	(.72)	(.72)	(.64)	(.47)	(.49)	(.66)

Marb **+.91** (.42) REA **+.57** (.37) Bfat **+.01** (.45)

★★★★★ for Low Maintenance, Marbling, Rib-eye area, Calving Ease, Stayability.



Beckton Lancer F442 T  
Sire of Beckton Legend S670 (L-1)



• Reference Sires •

**L-4 BECKTON LEGEND Z689 J3**  
1-A 100% # 1544949 Tattoo: BKT2 Z689

Birth: 4-3-12	Beckton Legend S670	Beckton Lancer F442 T	BWt	<b>77</b>
		Beckton Kit F468 JL	WR	<b>121</b>
<b>BECKTON LEGEND X561 J2</b>	Beckton Lana T279 JO	Beckton Julio L233	ADG	<b>3.86</b>
Ref. L		Beckton Lana L923 CD	YR	<b>110</b>
	Beckton Julian G5 S107	Beckton Julian GJ P535	Scr.	<b>36</b>
<b>BECKTON LARKABA W868 J</b>	Beckton Larkaba S663 JE	Beckton Minola P826 DM	Fr.	<b>5.5</b>
		Beckton Jules L429		
		Beckton Larkaba K530 EP		

RAAA HerdBuilder index: **170** (Top 6% of all RA bulls)  
 RAAA GridMaster index: **53** (Top 12% of all RA bulls)

	Calv.Ease	BW	WW	YW	Milk	HPG	Stay	Maint.En.
EPDs	<b>9</b>	<b>-0.6</b>	<b>68</b>	<b>104</b>	<b>18</b>	<b>9</b>	<b>14</b>	<b>-10.0</b>
Acc.	(.17)	(.34)	(.30)	(.34)	(.16)	(.07)	(.04)	(.21)
	Marb <b>+.60</b>	(.08)	REA <b>+.16</b>	(.07)	Bfat <b>+.03</b>	(.11)		

<b>DAM</b>	
Age	<b>3</b>
Wt	<b>1020</b>
Wean Pct.	<b>64%</b>
Cow Eff.	<b>135</b>



Beckton Nebula P707  
Sire of lots 4, 32, 117, 152, 157 and 181; Ref. Sire N-2

★★★★★ for Low Maintenance, Growth, Marbling, Rib-eye area, High Cow Efficiency, Calving Ease, Stayability.

**N-1 BECKTON NEBULA M045**  
1-A 100% # 854775 Tattoo: BKT2 M045

Birth: 2-19-02	Beckton Neptune RR B284	Bkt Neptune 8460 R	BWt	<b>59</b>
		Beckton Eola 8600 RR	WR	<b>108</b>
<b>BECKTON NEPTUNE R2 K065</b>	Beckton Lana C735 TP	RDD B Topper 1675	ADG	<b>3.51</b>
Ref.		Beckton Lana A714 TR	YR	<b>106</b>
	Beckton Julian GG B571	Beckton Julian 7526G	Scr.	<b>35</b>
<b>BECKTON BELGA K285 JL</b>	Beckton Belga G493 HR	Bkt Marta 9A13 JL	Fr.	<b>5.0</b>
		Beckton Herald K B244		
		Beckton Belga D776 CL		

RAAA HerdBuilder index: **216** (Top 1% of all RA bulls)  
 RAAA GridMaster index: **56** (Top 3% of all RA bulls)

	Calv.Ease	BW	WW	YW	Milk	HPG	Stay	Maint.En.
EPDs	<b>17</b>	<b>-8.0</b>	<b>44</b>	<b>77</b>	<b>10</b>	<b>11</b>	<b>13</b>	<b>-9.1</b>
Acc.	(.88)	(.91)	(.90)	(.90)	(.88)	(.75)	(.60)	(.68)
	Marb <b>+.62</b>	(.70)	REA <b>-.38</b>	(.68)	Bfat <b>+.06</b>	(.67)		

<b>DAM</b>	
Age	<b>2</b>
Wt	<b>860</b>
Wean Pct.	<b>59%</b>
Cow Eff.	<b>125</b>

★★★★★ for Low Maintenance, Growth, Marbling, High Cow Efficiency, Calving Ease, Stayability.



Beckton Nebula M045  
Sire of lots 105 and 254 Ref. Sire N-1

**N-2 BECKTON NEBULA P P707**  
1-A 100% # 979031 Tattoo: BKT4 P707

Birth: 4-1-04	Beckton Neptune R2 K065	Beckton Neptune RR B284	BWt	<b>68</b>
		Beckton Lana C735 TP	WR	<b>127</b>
<b>BECKTON NEBULA M045</b>	Beckton Belga K285 JL	Beckton Julian GG B571	ADG	<b>3.85</b>
Ref. N-1		Beckton Belga G493 HR	YR	<b>122</b>
	Beckton Epic K1 K863	Beckton Epic KN H110	Scr.	<b>37</b>
<b>BECKTON LANA M809 EP</b>	Beckton Lana K253 DM	Beckton Rose H019 SC	Fr.	<b>5.0</b>
		Beckton Dominor ZJ H657		
		Beckton Lana HA34 DM		

RAAA HerdBuilder index: **212** (Top 2% of all RA bulls)  
 RAAA GridMaster index: **57** (Top 1% of all RA bulls)

	Calv.Ease	BW	WW	YW	Milk	HPG	Stay	Maint.En.
EPDs	<b>17</b>	<b>-6.3</b>	<b>60</b>	<b>105</b>	<b>19</b>	<b>10</b>	<b>16</b>	<b>-3.0</b>
Acc.	(.89)	(.90)	(.90)	(.90)	(.88)	(.66)	(.51)	(.70)
	Marb <b>+.97</b>	(.61)	REA <b>-.34</b>	(.58)	Bfat <b>+.02</b>	(.60)		

<b>DAM</b>	
Age	<b>2</b>
Wt	<b>890</b>
Wean Pct.	<b>71%</b>
Cow Eff.	<b>150</b>

★★★★★ for Low Maintenance, Growth, Marbling, High Cow Efficiency, Calving Ease, Stayability.

**N-3 BECKTON NEBULA EN S347**  
1-A 100% # 1118810 Tattoo: WF6 S347

Birth: 3-13-06	Beckton Nebula M045	Beckton Neptune R2 K065	BWt	<b>55</b>
		Beckton Belga K285 JL	WR	<b>97</b>
<b>BECKTON NEBULA E P084</b>	BKT Pine Marie M119 EP	Beckton Epic K F075	ADG	<b>4.13</b>
Ref. N		Bkt Pine Marie D126 JL	YR	<b>97</b>
	Beckton Nebula M045	Beckton Neptune R2 K065	Scr.	<b>NA</b>
<b>BECKTON EOLA P530 NB</b>	Beckton Eola M663 EP	Beckton Belga K285 JL	Fr.	<b>4.5</b>
		Beckton Epic K1 K863		
		Beckton Eola K178 EP		

RAAA HerdBuilder index: **225** (Top 1% of all RA bulls)  
 RAAA GridMaster index: **58** (Top 1% of all RA bulls)

	Calv.Ease	BW	WW	YW	Milk	HPG	Stay	Maint.En.
EPDs	<b>20</b>	<b>-9.0</b>	<b>42</b>	<b>58</b>	<b>28</b>	<b>17</b>	<b>15</b>	<b>-8.1</b>
Acc.	(.60)	(.67)	(.64)	(.65)	(.56)	(.37)	(.01)	(.63)
	Marb <b>+.95</b>	(.27)	REA <b>-.45</b>	(.24)	Bfat <b>+.05</b>	(.37)		

<b>DAM</b>	
Age	<b>2</b>
Wt	<b>750</b>
Wean Pct.	<b>60%</b>
Cow Eff.	<b>127</b>

★★★★★ for Low Maintenance, Gainability, Marbling, High Cow Efficiency, Calving Ease, Stayability.

• Reference Sires •

**N-4 BECKTON NEBULA W486 D3**  
1-A 100% # 1332209 Tattoo: BKT9 W486

Birth: 3-28-09	Beckton Nebula M045	Beckton Neptune R2 K065	BWt <b>77</b>
		Beckton Belga K285 JL	WR <b>105</b>
<b>BECKTON NEBULA L P093</b>	Beckton Lancer TA K644		ADG <b>4.37</b>
Ref. N	Beckton Marta M021 LN	Beckton Marta K254 LN	YR <b>109</b>
	Beckton Dominor ZC M919	Beckton Dominor Z E401	Scr. <b>36</b>
<b>BECKTON BELGA R716 DM</b>	Beckton Barmaid J012 CO		Fr. <b>5.5</b>
	Beckton Julian GG B571		
	Beckton Belga K285 JL	Beckton Belga G493 HR	

RAAA HerdBuilder index: **205** (Top 2% of all RA bulls)

RAAA GridMaster index: **52** (Top 23% of all RA bulls)

DAM	
Age	4
Wt	1030
Wean Pct.	57%
Cow Eff.	120

Calv.Ease	BW	WW	YW	Milk	HPG	Stay	Maint.En.
EPDs <b>12</b>	<b>-4.8</b>	<b>53</b>	<b>87</b>	<b>20</b>	<b>9</b>	<b>20</b>	<b>0.7</b>
Acc. (.39)	(.67)	(.60)	(.60)	(.36)	(.20)	(.17)	(.52)
Marb <b>+.55</b>	(.27)	REA <b>+.12</b>	(.24)	Bfat <b>+.02</b>	(.37)		



Beckton Nebula L P093  
Sire of Beckton Nebula W486 (N-4)

★★★★★ for Low Maintenance, Growth, Gainability, Marbling, High Cow Efficiency, Calving Ease, Stayability.

**N-5 BECKTON NEBULA X096 N4**  
1-A 100% # 1383327 Tattoo: BKT0 X096

Birth: 2-28-10	Beckton Nebula P P707	Beckton Nebula M045	BWt <b>67</b>
		Beckton Lana M809 EP	WR <b>121</b>
<b>BECKTON NEBULA U206 V3</b>	Beckton Vegas PK F485		ADG <b>3.76</b>
Ref. N	Beckton Minerva J615 VG	Beckton Minerva F433 VG	YR <b>116</b>
	Beckton Nebula P P707	Beckton Nebula M045	Scr. <b>34</b>
<b>BECKTON TAMARA U185 NB</b>	Beckton Lana M809 EP		Fr. <b>5.5</b>
	Beckton Champ R3 H338		
	Beckton Tamara P813 CH	Beckton Tamara H625 CH	

RAAA HerdBuilder index: **188** (Top 5% of all RA bulls)

RAAA GridMaster index: **51** (Top 35% of all RA bulls)

DAM	
Age	2
Wt	818
Wean Pct.	71%
Cow Eff.	150

Calv.Ease	BW	WW	YW	Milk	HPG	Stay	Maint.En.
EPDs <b>9</b>	<b>-2.4</b>	<b>63</b>	<b>104</b>	<b>21</b>	<b>10</b>	<b>19</b>	<b>2.3</b>
Acc. (.43)	(.56)	(.52)	(.52)	(.39)	(.07)	(.04)	(.55)
Marb <b>+.54</b>	(.23)	REA <b>+.10</b>	(.20)	Bfat <b>-.01</b>	(.33)		

★★★★★ for Low Maintenance, Growth, Marbling, High Cow Efficiency, Calving Ease, Stayability.

**N-7 BECKTON NEBULA Z111 N5**  
1-A 100% # 1545278 Tattoo: BKT2 Z111

Birth: 2-26-12	Beckton Nebula U206 V3	Beckton Nebula P P707	BWt <b>61</b>
		Beckton Minerva J615 VG	WR <b>105</b>
<b>BECKTON NEBULA X096 N4</b>	Beckton Nebula P P707		ADG <b>3.93</b>
Ref. N-5	Beckton Tamara U185 NB	Beckton Tamara P813 CH	YR <b>115</b>
	Beckton Nebula T054 H3	Beckton Nebula J R475	Scr. <b>35</b>
<b>BECKTON MINOLA X670 N</b>	BKT Pine Marie R401 HU		Fr. <b>5.5</b>
	Beckton Julian G3 P608		
	Beckton Minola S103 JL	Beckton Minola P205 JC	

RAAA HerdBuilder index: **183** (Top 3% of all RA bulls)

RAAA GridMaster index: **52** (Top 19% of all RA bulls)

DAM	
Age	2
Wt	690
Wean Pct.	72%
Cow Eff.	151

Calv.Ease	BW	WW	YW	Milk	HPG	Stay	Maint.En.
EPDs <b>12</b>	<b>-3.9</b>	<b>54</b>	<b>97</b>	<b>16</b>	<b>12</b>	<b>17</b>	<b>-1.6</b>
Acc. (.17)	(.34)	(.30)	(.34)	(.15)	(.06)	(.03)	(.21)
Marb <b>+.63</b>	(.15)	REA <b>+.10</b>	(.14)	Bfat <b>+.00</b>	(.11)		

★★★★★ for Low Maintenance, Growth, Marbling, High Cow Efficiency, Calving Ease, Stayability.

**N-6 BECKTON NEW ERA Y194**  
1-A 100% # 1451309 Tattoo: BKT1 Y194

Birth: 3-20-11	Beckton Nebula M045	Beckton Neptune R2 K065	BWt <b>67</b>
		Beckton Belga K285 JL	WR <b>132</b>
<b>BECKTON NEBULA P P707</b>	Beckton Epic K1 K863		ADG <b>3.50</b>
Ref. N-2	Beckton Lana M809 EP	Beckton Lana K253 DM	YR <b>121</b>
	Beckton Justice C1 R483	Beckton Justice CH M056	Scr. <b>36</b>
<b>BKT LARKEISA T310 JC</b>	Beckton Tamara J124 HR		Fr. <b>5.5</b>
	BKT Larkeisa R775 JC	Beckton Justice C K449	
		BKT Larkeisa L149 CK	

RAAA HerdBuilder index: **190** (Top 4% of all RA bulls)

RAAA GridMaster index: **56** (Top 3% of all RA bulls)

DAM	
Age	4
Wt	950
Wean Pct.	82%
Cow Eff.	174

Calv.Ease	BW	WW	YW	Milk	HPG	Stay	Maint.En.
EPDs <b>12</b>	<b>-4.2</b>	<b>71</b>	<b>120</b>	<b>21</b>	<b>10</b>	<b>15</b>	<b>-3.1</b>
Acc. (.42)	(.75)	(.67)	(.63)	(.31)	(.31)	(.42)	(.19)
Marb <b>+.70</b>	(.38)	REA <b>-.21</b>	(.32)	Bfat <b>+.04</b>	(.41)		

★★★★★ for Low Maintenance, Growth, Marbling, High Cow Efficiency, Calving Ease, Stayability.

**N-8 BECKTON NEBULA Z180 H4**  
1-A 100% # 1545294 Tattoo: BKT2 Z180

Birth: 3-8-12	Beckton Nebula G S237	Beckton Nebula M045	BWt <b>58</b>
		Beckton Lakme LA06 JL	WR <b>112</b>
<b>BECKTON NEBULA X353 E3</b>	Beckton Epic K4 N795		ADG <b>3.28</b>
Ref. N	Beckton Lana R058 EP	Beckton Lana N388 LO	YR <b>108</b>
	Beckton Heritage T270 J2	Beckton Heritage N013	Scr. <b>34</b>
<b>BECKTON MONA X817 H</b>	Beckton Coca P602 JL		Fr. <b>5.0</b>
	Beckton Cody K2 R168		
	Beckton Mona T794 CD	Beckton Mona R764 LN	

RAAA HerdBuilder index: **150** (Top 13% of all RA bulls)

RAAA GridMaster index: **53** (Top 7% of all RA bulls)

DAM	
Age	2
Wt	855
Wean Pct.	63%
Cow Eff.	132

Calv.Ease	BW	WW	YW	Milk	HPG	Stay	Maint.En.
EPDs <b>12</b>	<b>-4.3</b>	<b>68</b>	<b>107</b>	<b>19</b>	<b>8</b>	<b>13</b>	<b>2.5</b>
Acc. (.18)	(.34)	(.30)	(.34)	(.16)	(.07)	(.04)	(.22)
Marb <b>+.48</b>	(.14)	REA <b>+.19</b>	(.14)	Bfat <b>+.03</b>	(.11)		

★★★★★ for Low Maintenance, Growth, Marbling, Rib-eye area, High Cow Efficiency, Calving Ease, Stayability.

• Reference Sires •

**R-1 BECKTON RANGER Z225 J4**  
1-A 100% # 1544800 Tattoo: BKT2 Z225

Birth: 3-12-12  
 Beckton Ranger 9479R < Beckton Ranger 7003  
 Beckton Eola 7470 RZ  
**BECKTON RANGER T603 H3**  
 Ref. R < Beckton Hustler C2 L079  
 Beckton Rose N044 HU < Beckton Rose L669 JL  
 Beckton Jet L P491 < TR Julian LT151  
**BECKTON MONA U564 JT**  
 Beckton Mona P874 WR < Beckton Minerva L278 LN  
 Beckton Warrior T1 H281  
 Beckton Mona L724 CO

DAM	
Age	4
Wt	1080
Wean Pct.	59%
Cow Eff.	124

RAAA HerdBuilder index: **142**(Top 17% of all RA bulls)  
 RAAA GridMaster index: **51**(Top 23% of all RA bulls)

	Calv.Ease	BW	WW	YW	Milk	HPG	Stay	Maint.En.
EPDs	12	-4.4	44	74	19	15	9	-11.5
Acc.	(.20)	(.36)	(.32)	(.36)	(.20)	(.10)	(.10)	(.25)
Marb	+.51 (.17)		REA -.09 (.16)		Bfat +.02 (.14)			

★★★★★ for Low Maintenance, Growth, Marbling, High Cow Efficiency, Calving Ease.

**S-3 BECKTON SCAMP X458 H3**  
1-A 100% # 1382759 Tattoo: BKT0 X458

Birth: 3-26-10  
 Beckton Scamp 8954 < Beckton Julian 7526G  
 Bkt Kusi Annie 5462  
**BECKTON SCAMP T A825**  
 Ref. < Beckton Trojan 7061P  
 Bkt Encino 8459 TJ < BCH Kit 7132-784  
 Beckton Hustler C2 L079 < Beckton Hustler CN J102  
**BKT PINE MARIE R401 HU**  
 Bkt Pine Marie LC30 CD < Beckton Barmaid J012 CO  
 Beckton Cody V E023  
 Bkt Pine Marie D764 HD

DAM	
Age	5
Wt	1270
Wean Pct.	49%
Cow Eff.	104

RAAA HerdBuilder index: **131**(Top 29% of all RA bulls)  
 RAAA GridMaster index: **50**(Top 56% of all RA bulls)

	Calv.Ease	BW	WW	YW	Milk	HPG	Stay	Maint.En.
EPDs	10	-4.2	48	80	21	12	10	-8.6
Acc.	(.50)	(.59)	(.56)	(.55)	(.46)	(.19)	(.20)	(.57)
Marb	+.38 (.25)		REA +.05 (.23)		Bfat -.01 (.33)			

★★★★★ for Low Maintenance, Growth, Gainability, Marbling, Calving Ease.

**S-1 BECKTON SCAMP X494 E3**  
1-A 100% # 1382791 Tattoo: BKT0 X494

Birth: 3-28-10  
 Beckton Scamp 8954 < Beckton Julian 7526G  
 Bkt Kusi Annie 5462  
**BECKTON SCAMP T A825**  
 Ref. < Beckton Trojan 7061P  
 Bkt Encino 8459 TJ < BCH Kit 7132-784  
 Beckton Epic KH P678 < Beckton Epic K F075  
**BECKTON LANA S074 EP**  
 Beckton Lana P317 JL < BKT Larkeisa L274 HU  
 Beckton Julian G2 M345  
 Beckton Lana M078 LN

DAM	
Age	4
Wt	1060
Wean Pct.	63%
Cow Eff.	133

RAAA HerdBuilder index: **155**(Top 15% of all RA bulls)  
 RAAA GridMaster index: **50**(Top 51% of all RA bulls)

	Calv.Ease	BW	WW	YW	Milk	HPG	Stay	Maint.En.
EPDs	12	-5.1	50	78	27	11	12	-9.9
Acc.	(.47)	(.70)	(.63)	(.62)	(.43)	(.10)	(.18)	(.57)
Marb	+.25 (.28)		REA +.04 (.25)		Bfat +.00 (.38)			

★★★★★ for Low Maintenance, Growth, Marbling, High Cow Efficiency, Calving Ease.

**W-1 BECKTON WARRIOR Z936 N6**  
1-A 100% # 1544900 Tattoo: BKT2 Z936

Birth: 5-8-12  
 Beckton Warrior N645 T1 < Beckton Warrior T1 H281  
 Beckton Rose H074 EP  
**BECKTON WARRIOR T248 L5**  
 Ref. W < Beckton Lancer F442 T  
 Beckton Kit R503 LN < Beckton Kit F468 JL  
 Beckton Nebula T054 H3 < Beckton Nebula J R475  
**BECKTON FREYJA W462 N**  
 Beckton Freyja T147 HI < BKT Pine Marie R401 HU  
 Beckton Hilltop R157  
 Beckton Freyja R417 HU

DAM	
Age	3
Wt	880
Wean Pct.	68%
Cow Eff.	143

RAAA HerdBuilder index: **141**(Top 18% of all RA bulls)  
 RAAA GridMaster index: **49**(Top 63% of all RA bulls)

	Calv.Ease	BW	WW	YW	Milk	HPG	Stay	Maint.En.
EPDs	8	-0.5	57	88	11	12	12	-9.0
Acc.	(.20)	(.36)	(.32)	(.36)	(.20)	(.10)	(.07)	(.23)
Marb	+.40 (.09)		REA +.21 (.08)		Bfat +.00 (.11)			

★★★★★ for Low Maintenance, Marbling, Rib-eye area, High Cow Efficiency, Calving Ease.

**S-2 BECKTON SCAMP Z460 L4**  
1-A 100% # 1544893 Tattoo: BKT2 Z460

Birth: 3-24-12  
 Beckton Scamp T A825 < Beckton Scamp 8954  
 Bkt Encino 8459 TJ  
**BECKTON SCAMP X458 H3**  
 Ref. S < Beckton Hustler C2 L079  
 BKT Pine Marie R401 HU < Bkt Pine Marie LC30 CD  
 Beckton Lancer F442 T < Beckton Lancer T A664  
 Bkt Suffeina A828 DM  
**BECKTON BELGA W405 L**  
 Beckton Belga K285 JL < Beckton Julian GG B571  
 Beckton Belga G493 HR

DAM	
Age	3
Wt	840
Wean Pct.	67%
Cow Eff.	142

RAAA HerdBuilder index: **146**(Top 15% of all RA bulls)  
 RAAA GridMaster index: **50**(Top 54% of all RA bulls)

	Calv.Ease	BW	WW	YW	Milk	HPG	Stay	Maint.En.
EPDs	11	-3.7	51	86	20	8	13	-9.3
Acc.	(.18)	(.34)	(.30)	(.34)	(.17)	(.10)	(.12)	(.21)
Marb	+.37 (.18)		REA +.23 (.17)		Bfat +.00 (.14)			

★★★★★ for Low Maintenance, Growth, Marbling, Rib-eye area, High Cow Efficiency, Calving Ease, Stayability.

**W-2 BECKTON WARRIOR W534 N4**  
1-A 100% # 1332228 Tattoo: BKT9 W534

Birth: 3-31-09  
 Beckton Warrior CL M686 < Beckton Warrior C C355  
 Beckton Christy J223 LN  
**BECKTON WARRIOR C1 S337**  
 Ref. W < Beckton Cody V E023  
 Beckton Christy K101 CD < Beckton Christy C306 JL  
 Beckton Nebula P P707 < Beckton Nebula M045  
**BKT LARKEISA S055 NB**  
 Beckton Larkeisa P688 CH < Beckton Lana M809 EP  
 Beckton Champ R3 H338  
 BKT Larkeisa J564 HR

DAM	
Age	3
Wt	880
Wean Pct.	61%
Cow Eff.	129

RAAA HerdBuilder index: **194** (Top 4% of all RA bulls)  
 RAAA GridMaster index: **53**(Top 11% of all RA bulls)

	Calv.Ease	BW	WW	YW	Milk	HPG	Stay	Maint.En.
EPDs	16	-7.0	35	56	25	12	15	-10.9
Acc.	(.57)	(.70)	(.66)	(.65)	(.55)	(.16)	(.11)	(.64)
Marb	+.79 (.25)		REA +.14 (.22)		Bfat +.07 (.36)			

★★★★★ for Low Maintenance, Marbling, Rib-eye area, High Cow Efficiency, Calving Ease, Stayability.

# RAAA Herd EPD Tables

## Proven and Genetic Opportunity Sires (2014)

	HB	GM	CED	BW	WW	YW	MILK	ME	HPG	CEM	ST	MARB	YG	CW	REA	FAT
Min.	-4	43	-13	-13.3	-10	-18	-12	-27	-5	-16	0	-.31	-.37	-52	-.80	-.08
<b>Avg.</b>	<b>107</b>	<b>50</b>	<b>5</b>	<b>-1.5</b>	<b>57</b>	<b>89</b>	<b>20</b>	<b>1</b>	<b>10</b>	<b>5</b>	<b>10</b>	<b>.48</b>	<b>.03</b>	<b>21</b>	<b>.12</b>	<b>.00</b>
Max.	241	60	23	5.9	104	180	42	24	22	20	22	1.79	.55	80	.98	.12
1%	215	57	19	-7.7	92	146	37	-15	19	17	18	.98	-.21	55	.64	-.05
2%	202	56	17	-7.0	88	139	35	-13	18	16	17	.92	-.18	51	.58	-.05
3%	196	56	16	-6.6	85	135	34	-12	18	15	16	.89	-.16	48	.54	-.04
4%	189	55	16	-6.2	83	132	33	-11	17	14	16	.86	-.15	46	.51	-.04
5%	184	55	15	-5.9	81	129	32	-11	17	14	16	.83	-.14	45	.49	-.04
<b>10%</b>	<b>168</b>	<b>54</b>	<b>13</b>	<b>-4.9</b>	<b>76</b>	<b>120</b>	<b>29</b>	<b>-8</b>	<b>15</b>	<b>12</b>	<b>14</b>	<b>.75</b>	<b>-.10</b>	<b>40</b>	<b>.41</b>	<b>-.03</b>
15%	154	53	11	-4.3	72	114	27	-6	14	10	13	.70	-.08	36	.35	-.02
20%	144	52	10	-3.8	70	110	26	-5	13	9	13	.66	-.06	33	.31	-.02
25%	137	52	9	-3.3	67	105	25	-4	13	9	12	.62	-.04	31	.27	-.01
30%	130	52	8	-2.9	65	102	24	-3	12	8	12	.59	-.03	29	.23	-.01
35%	124	51	7	-2.5	63	98	23	-2	12	7	11	.56	-.01	27	.20	-.01
40%	119	51	7	-2.2	61	95	22	-1	11	6	11	.53	.00	25	.17	.00
45%	113	51	6	-1.8	59	92	21	0	11	6	10	.50	.01	23	.14	.00
<b>50%</b>	<b>107</b>	<b>50</b>	<b>5</b>	<b>-1.5</b>	<b>57</b>	<b>89</b>	<b>20</b>	<b>1</b>	<b>10</b>	<b>5</b>	<b>10</b>	<b>.48</b>	<b>.03</b>	<b>21</b>	<b>.12</b>	<b>.00</b>
55%	101	50	4	-1.2	55	86	19	2	9	4	10	.45	.04	19	.09	.01
60%	97	50	3	-0.8	53	83	18	3	9	4	9	.42	.05	17	.06	.01
65%	91	49	3	-0.5	51	80	17	4	8	3	9	.39	.07	15	.03	.01
70%	86	49	2	-0.1	49	76	16	5	8	2	8	.36	.08	13	.00	.02
75%	80	49	1	0.3	47	73	15	6	7	1	8	.33	.09	11	-.04	.02
80%	74	48	0	0.8	44	68	14	7	7	1	7	.29	.11	9	-.08	.02
85%	68	48	-1	1.3	42	64	13	8	6	0	7	.25	.13	6	-.12	.03
<b>90%</b>	<b>59</b>	<b>47</b>	<b>-3</b>	<b>1.9</b>	<b>38</b>	<b>58</b>	<b>11</b>	<b>10</b>	<b>5</b>	<b>-2</b>	<b>6</b>	<b>.20</b>	<b>.16</b>	<b>2</b>	<b>-.18</b>	<b>.04</b>
95%	44	46	-5	2.9	33	49	8	13	3	-4	4	.12	.19	-3	-.26	.04

## Active Cows (2014)

	HB	GM	CED	BW	WW	YW	MILK	ME	HPG	CEM	ST	MARB	YG	CW	REA	FAT
Min.	-10	39	-12	-11.4	-14	-25	-10	-31	-5	-16	0	-.48	-.41	-53	-.78	-.10
<b>Avg.</b>	<b>100</b>	<b>49</b>	<b>4</b>	<b>-1.0</b>	<b>54</b>	<b>83</b>	<b>20</b>	<b>2</b>	<b>10</b>	<b>5</b>	<b>10</b>	<b>.42</b>	<b>.01</b>	<b>18</b>	<b>.07</b>	<b>.00</b>
Max.	256	60	20	9.7	100	173	51	32	22	20	22	1.66	.43	77	1.13	.14
1%	188	54	13	-6.1	80	127	34	-11	15	13	17	.85	-.19	48	.52	-.05
2%	177	54	12	-5.5	77	122	32	-10	15	12	16	.80	-.16	45	.47	-.05
3%	170	53	12	-5.1	75	119	31	-9	14	12	15	.77	-.15	43	.43	-.04
4%	165	53	11	-4.9	74	116	30	-8	14	11	15	.74	-.14	41	.41	-.04
5%	160	53	11	-4.6	72	114	30	-7	14	11	15	.72	-.13	39	.39	-.04
<b>10%</b>	<b>145</b>	<b>52</b>	<b>9</b>	<b>-3.8</b>	<b>68</b>	<b>107</b>	<b>28</b>	<b>-5</b>	<b>13</b>	<b>9</b>	<b>14</b>	<b>.66</b>	<b>-.10</b>	<b>35</b>	<b>.32</b>	<b>-.03</b>
15%	136	51	8	-3.3	66	103	26	-4	12	9	13	.61	-.08	32	.27	-.02
20%	129	51	7	-2.9	63	99	25	-3	12	8	12	.57	-.06	29	.23	-.02
25%	123	51	7	-2.5	62	96	24	-2	12	7	12	.54	-.05	27	.20	-.02
30%	118	50	6	-2.2	60	93	23	-1	11	7	11	.51	-.03	25	.17	-.01
35%	113	50	6	-1.8	58	90	22	0	11	6	11	.49	-.02	23	.15	-.01
40%	109	50	5	-1.6	57	88	22	1	11	6	11	.46	-.01	21	.12	-.01
45%	104	50	5	-1.3	55	85	21	1	10	5	10	.44	.00	20	.10	-.01
<b>50%</b>	<b>100</b>	<b>49</b>	<b>4</b>	<b>-1.0</b>	<b>54</b>	<b>83</b>	<b>20</b>	<b>2</b>	<b>10</b>	<b>5</b>	<b>10</b>	<b>.42</b>	<b>.01</b>	<b>18</b>	<b>.07</b>	<b>.00</b>
55%	96	49	3	-0.7	53	81	19	3	10	5	10	.39	.02	16	.05	.00
60%	92	49	3	-0.4	51	78	18	3	9	4	9	.37	.03	15	.02	.00
65%	88	49	2	-0.2	50	76	18	4	9	4	9	.35	.05	13	.00	.01
70%	84	48	2	0.2	48	73	17	5	9	3	9	.32	.06	11	-.03	.01
75%	79	48	1	0.5	46	70	16	6	8	3	8	.29	.07	9	-.06	.01
80%	75	48	1	0.9	45	67	15	7	8	2	8	.26	.09	7	-.09	.01
85%	69	47	0	1.3	42	63	14	8	8	1	7	.22	.10	4	-.13	.02
<b>90%</b>	<b>63</b>	<b>47</b>	<b>-1</b>	<b>1.8</b>	<b>40</b>	<b>59</b>	<b>12</b>	<b>9</b>	<b>7</b>	<b>1</b>	<b>6</b>	<b>.18</b>	<b>.12</b>	<b>1</b>	<b>-.18</b>	<b>.02</b>
95%	53	46	-3	2.6	36	52	10	11	6	-1	5	.11	.15	-3	-.25	.03

## Non-Parents (2014)

	HB	GM	CED	BW	WW	YW	MILK	ME	HPG	CEM	ST	MARB	YG	CW	REA	FAT
Min.	39	44	-16	-11.2	8	5	-2	-19	0	-12	-3	-.27	-.50	-35	-.65	-.16
<b>Avg.</b>	<b>109</b>	<b>50</b>	<b>5</b>	<b>-1.3</b>	<b>57</b>	<b>89</b>	<b>20</b>	<b>1</b>	<b>10</b>	<b>4</b>	<b>10</b>	<b>.45</b>	<b>.02</b>	<b>21</b>	<b>.12</b>	<b>.00</b>
Max.	254	61	20	8.6	103	163	37	22	22	20	21	1.60	.51	71	1.13	.16
1%	197	55	14	-6.2	82	131	30	-12	15	10	16	.91	-.19	49	.55	-.05
2%	187	54	13	-5.6	79	126	29	-10	14	10	16	.86	-.16	46	.50	-.05
3%	181	54	12	-5.3	77	123	28	-9	14	9	15	.83	-.15	44	.47	-.04
4%	176	53	12	-5.0	75	121	28	-9	14	9	15	.80	-.14	42	.44	-.04
5%	171	53	11	-4.8	74	119	27	-8	13	9	15	.78	-.13	41	.42	-.04
<b>10%</b>	<b>157</b>	<b>52</b>	<b>10</b>	<b>-4.0</b>	<b>71</b>	<b>112</b>	<b>26</b>	<b>-6</b>	<b>13</b>	<b>8</b>	<b>14</b>	<b>.71</b>	<b>-.09</b>	<b>37</b>	<b>.35</b>	<b>-.03</b>
15%	147	52	9	-3.5	68	108	25	-5	12	7	13	.66	-.07	34	.31	-.02
20%	140	52	8	-3.1	66	104	24	-4	12	6	12	.62	-.06	31	.27	-.02
25%	133	51	8	-2.7	64	101	23	-3	11	6	12	.59	-.04	29	.24	-.01
30%	128	51	7	-2.4	63	98	22	-2	11	5	11	.56	-.03	27	.21	-.01
35%	123	51	7	-2.1	61	96	22	-1	11	5	11	.53	-.02	26	.19	-.01
40%	118	50	6	-1.8	60	94	21	0	11	5	11	.50	.00	24	.16	.00
45%	114	50	5	-1.6	58	91	21	0	10	4	10	.48	.01	23	.14	.00
<b>50%</b>	<b>109</b>	<b>50</b>	<b>5</b>	<b>-1.3</b>	<b>57</b>	<b>89</b>	<b>20</b>	<b>1</b>	<b>10</b>	<b>4</b>	<b>10</b>	<b>.45</b>	<b>.02</b>	<b>21</b>	<b>.12</b>	<b>.00</b>
55%	105	50	5	-1.0	56	87	19	2	10	4	10	.43	.03	19	.09	.00
60%	100	49	4	-0.8	54	84	19	2	9	3	9	.40	.04	18	.07	.01
65%	96	49	3	-0.5	53	82	18	3	9	3	9	.38	.05	16	.05	.01
70%	92	49	3	-0.2	51	80	18	4	9	3	9	.35	.06	15	.02	.01
75%	87	49	2	0.1	50	77	17	5	9	2	8	.32	.08	13	-.01	.02
80%	81	48	2	0.5	48	74	16	6	8	2	8	.29	.09	11	-.04	.02
85%	75	48	1	0.9	46	70	15	7	8	1	7	.25	.11	8	-.08	.02
<b>90%</b>	<b>68</b>	<b>47</b>	<b>0</b>	<b>1.4</b>	<b>43</b>	<b>66</b>	<b>14</b>	<b>8</b>	<b>7</b>	<b>0</b>	<b>6</b>	<b>.20</b>	<b>.13</b>	<b>5</b>	<b>-.12</b>	<b>.03</b>
95%	58	46	-1	2.2	40	59	13	10	7	-1	5	.13	.16	1	-.19	.04

## EPD Accuracies and Possible Change

EPDs are predictions, not true values, and we can therefore expect that EPDs will change from sire evaluation, as more information (i.e. progeny data) is included. A possible change value is an estimate of the amount of change (in trait units) that can be expected for a given EPD.

Technically, there is a 68% chance that the real genetic value (an EPD with a accuracy of 1.0) for any trait lies between its EPD plus its possible change value and its EPD minus its possible change value. For example, if a sire has a weaning EPD of +25 lb. and a possible change value of 10 lb., we can expect the true genetic value to be between +15 lb. (25 - 10) and +35 lb. (25 + 10) 68% of the time. We should not be surprised if his EPD in next year's evaluation is as high as +35 or as low as +15. If next year's EPD should happen to be slightly outside of this

range, keep in mind there is nearly a one-in-three chance of that happening; however, significantly larger deviations can occur.

Possible change is simply another way of expressing accuracy of an EPD. High accuracy sires will have small possible changes and vice versa. Many breeders feel that possible change values complement accuracies and help them determine just how thoroughly an animal has been evaluated. The accuracy/possible change chart lists possible changes in EPDs that can be expected with different levels of accuracy for the various traits.

For more information on possible change values, please see the article by Dr. Bob Hough titled "Understanding EPD Accuracies and Possible Change". This article can be downloaded from the Red Angus Association of America website at [www.redangus.org](http://www.redangus.org).

Accuracy	CED	BW	WW	YW	MILK	ME	HPG	CEM	ST	MARB	YG	CW	REA	FAT
<b>0.0</b>	9	3.0	16	26	12	3	11	9	7	.26	.20	19	.43	.04
<b>0.1</b>	8	2.7	15	23	11	2	10	8	6	.23	.18	17	.39	.04
<b>0.2</b>	7	2.4	13	21	10	2	9	7	5	.21	.16	15	.34	.03
<b>0.3</b>	6	2.1	11	18	8	2	8	6	5	.18	.14	14	.30	.03
<b>0.4</b>	5	1.8	10	15	7	2	7	5	4	.16	.12	12	.26	.02
<b>0.5</b>	4	1.5	8	13	6	1	6	4	3	.13	.10	10	.22	.02
<b>0.6</b>	3	1.2	7	10	5	1	4	4	3	.10	.08	8	.17	.02
<b>0.7</b>	3	0.9	5	8	4	1	3	3	2	.08	.06	6	.13	.01
<b>0.8</b>	2	0.6	3	5	2	1	2	2	1	.05	.04	4	.09	.01
<b>0.9</b>	1	0.3	2	3	1	0	1	1	1	.03	.02	2	.04	.00
<b>1.0</b>	0	0.0	0	0	0	0	0	0	0	.00	.00	0	.00	.00

# Sire Bloodline Charts

Name Family

- Accent A
- Action A
- Champ H
- Clifftop C
- Clipper A
- Cobalt A
- Cody A
- Colt A
- Copper C
- Dominor D
- Emcee E
- Emperor E
- Epic E
- Exeter E
- Hasten H
- Herald H
- Heritage H
- Hustler H
- Javelin L
- Jet J
- Jules J
- Julian J
- Julio J
- Juniper J
- Juno J
- Jupiter J
- Justice J
- Lancer L
- Lariat L
- Legend L
- Likable L
- Loki L
- Nebula N
- Neptune N
- Neva V
- New Era N
- Nomad V
- Ranger R
- Roman O
- Scamp S
- Varo R
- Vega V
- Vegas V
- Warhawk W
- Warrior W

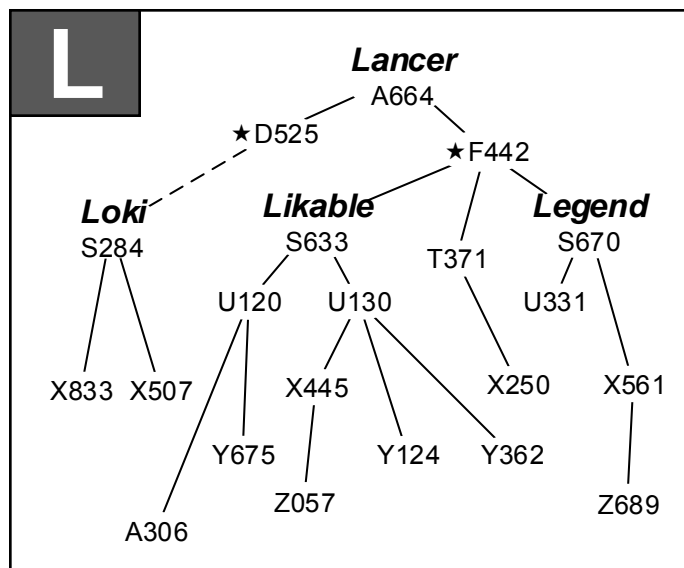
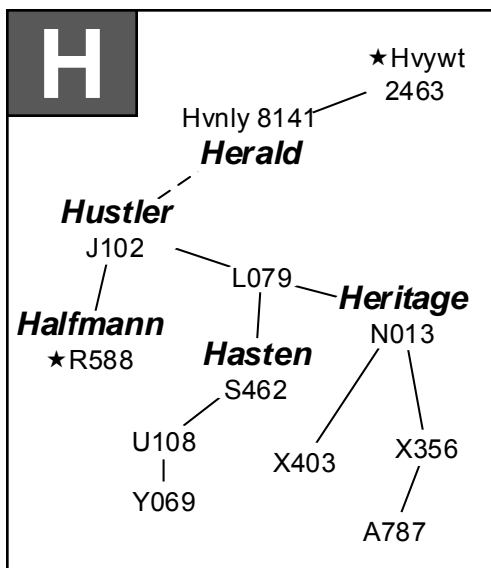
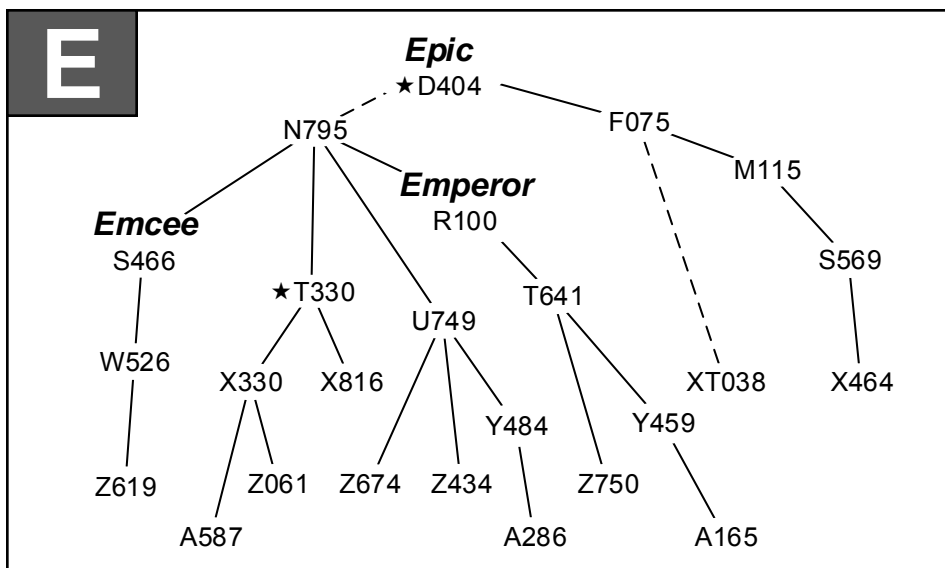
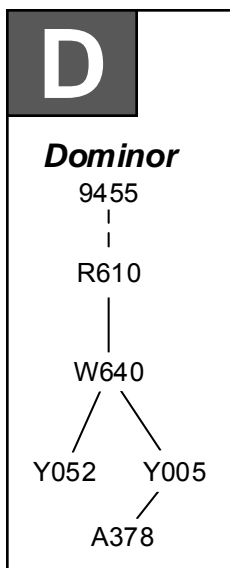
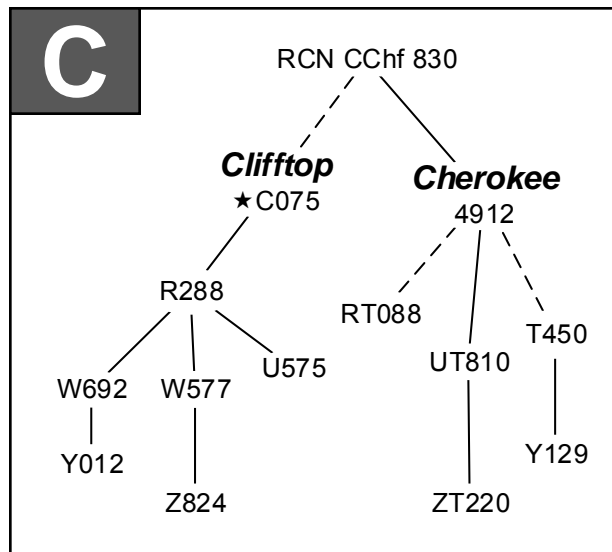
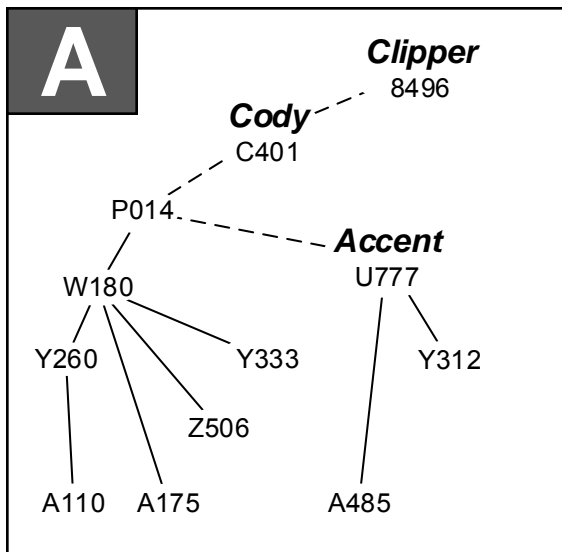

★ Red Angus Trait Leader

# J

**Javelin**  
★7466

**Julian**  
★7526

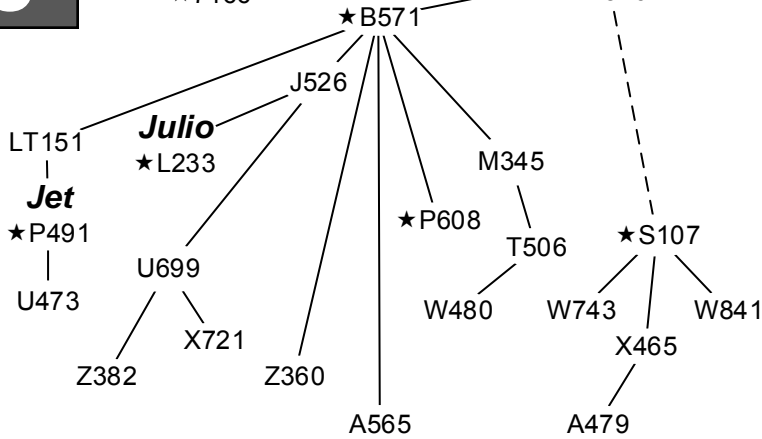

# O

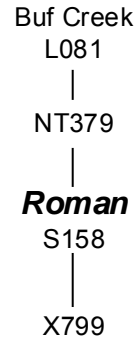

Name	Tag	Family
Javelin	7466	J-2
Julian	B571	J-1
Nebula	M045	N-1
Nebula	P707	N-2
Nebula	S347	N-3
Legend	S670	L-2
Likable	U120	L
Likable	U130	L-2
Nebula	U206	N
Epic	U749	E-1
Accent	U777	A-1
Accent	W180	A-2
Nebula	W486	N-4
Emcee	W526	E
Warrior	W534	W
Dominor	W640	D-1
Clifftop	W692	C-1
Julian	W743	J
Nebula	W778	N
Julian	W841	J-3
Nebula	X096	N-5
Nebula	X267	N
Epic	X330	E-2
Heritage	X356	H
Heritage	X403	H-1
Scamp	X458	S
Epic	X464	E-3
Julian	X465	J-4
Scamp	X494	S-1
Nebula	X603	N
Julian	X721	J
Janus	X799	O
Epic	X816	E-4
Loki	X833	L
Nebula	Y002	N
Dominor	Y005	D
Clifftop	Y012	C-2
Nebula	Y036	N
Dominor	Y052	D
Hasten	Y069	H
Warrior	Y108	W
Likable	Y124	L-3
Cherokee	Y129	C
New Era	Y194	N-6
Accent	Y260	A-3
Accent	Y312	A-4
Likable	Y362	L
Emperor	Y459	E
Epic	Y484	E-5
Likable	Y675	L
Nebula	Z111	N-7
Nebula	Z180	N-8
Ranger	Z225	R-1
Julian	Z382	J-5
Epic	Z434	E-6
Scamp	Z460	S-2
Accent	Z506	A-5
Epic	Z674	E-7
Legend	Z689	L-4
Emperor	Z750	E-8
Clifftop	Z824	C-3
Warrior	Z936	W-1
Dbl. Eagle	ZT220	C-4

# N

**Nebula**

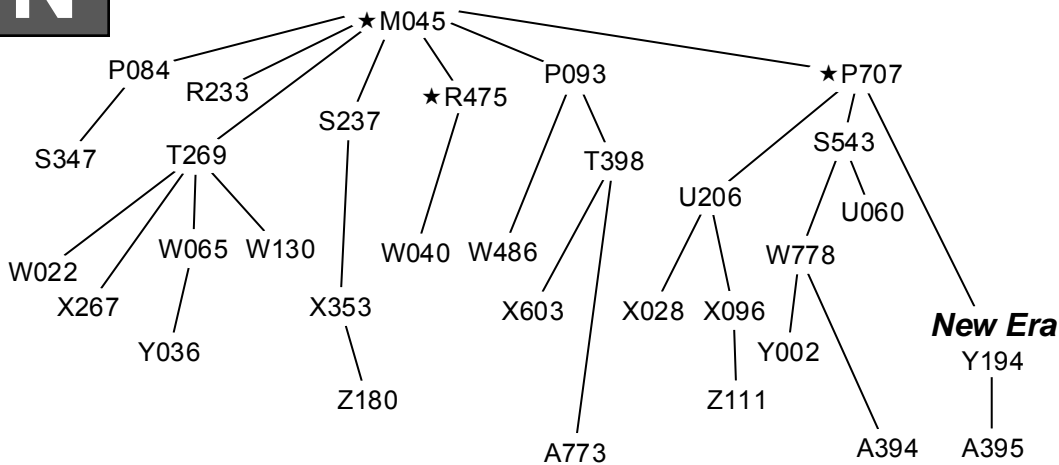

# R

**Ranger**

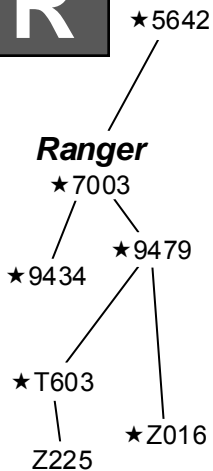

# S

**Scamp**

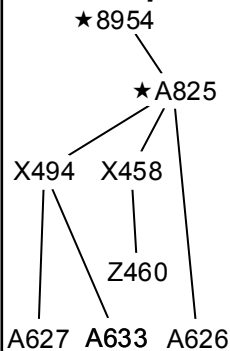

# V

**Nomad**

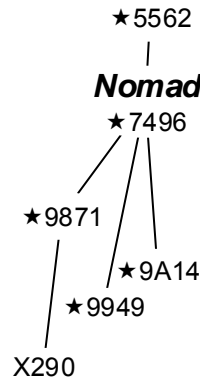

# W

**Warrior**

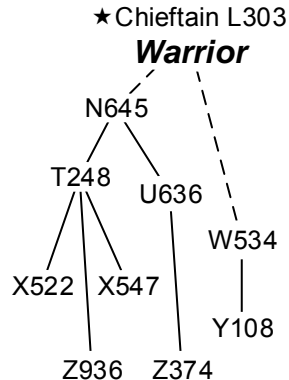

# Sale Terms and Conditions

Except for those stated in the terms and conditions below, there are no warranties, either expressed or implied, as to the merchantability or fitness for a particular purpose with respect to the cattle being sold at this auction. The warranties and guarantees set forth in the "Terms and Conditions" are in lieu of all other warranties, either expressed or implied, and the remedies provided therein shall be the sole and exclusive remedy for the Buyer, or any party claiming through Buyer, for any breach of warranty or guarantee therein provided, and all other obligations or liabilities.

The information in the catalog is believed to be accurate, and the information seller believes to be most representative. It is the nature of seller's business that the seller engages in a continual process of collecting new data and information. Therefore, any information presented at the time of sale is always subject to revision, correction or update.

## I. BIDDING

The Auctioneer in charge will settle any disputes as to bids, and his decision on such matters shall be final.

## II. TERMS

Terms of sale are cash or personal check unless satisfactory credit arrangements have been made with vendor prior to sale.

## III. PURCHASER'S RISK

Each animal becomes the risk of the purchaser as soon as sold, but it shall be the obligation of the Seller to see that animals are fed and cared for free of charge to purchaser, until loaded for shipment or until the expiration of 48 hours after the sale, whichever occurs sooner.

## IV. DELIVERY

For any animals for which seller's arrange delivery, the following terms shall apply. Each animal becomes the risk of the purchaser as soon as sold, and through the time of delivery. The seller will arrange transportation and delivery schedules, and may combine animals from one or more purchasers for convenience and to reduce costs. If delivery is arranged, seller assumes no other liability. Once the purchaser has been notified of the date and approximate time of delivery (morning, afternoon, evening, etc.), it is the responsibility of the purchaser to arrange adequate and agreeable location and facilities for unloading each animal. When unloaded at the agreed upon location, all care and management of the animal is the responsibility of the purchaser.

## V. CERTIFICATE OF REGISTRY

A transferred certificate of registry will be furnished to the purchaser for each animal for which a Registration number is listed.

## VI. HEALTH

All animals are eligible for interstate shipment, except as otherwise announced. Interstate health papers will be furnished for each animal requiring T.B, Bang's, and trich tests in accordance with federal and state regulations.

## VII. DIVISIBILITY

The percentage of ownership interest received by the buyer, whether it is 100% or 2/3 or otherwise as defined in the catalog or by the auctioneer, may not be subsequently divided without the express written consent of the seller.

## VIII. ANNOUNCEMENTS

Any changes from information of any kind in this catalog will be announced from the auction box and such announcements shall take precedence.

## IX. BREEDING GUARANTEE

Any female that has had a calf prior to the date of sale shall be considered a breeder without further guarantee. All females sold as 'bred' or 'pregnant' have been pregnancy checked by a licensed veterinarian and are guaranteed bred on the day of sale. The purchaser may elect to have any female so listed rechecked at their cost within 30 days of delivery by a licensed veterinarian of their choice. Any such female determined open by this recheck may be returned to the seller for a full

refund. Due to conditions out of seller's control, once a female leaves seller's possession, this is the only guarantee offered.

All bulls are sold as guaranteed breeders. Each bull has been officially fertility tested as "Satisfactory Breeder" prior to the sale. However, seller cannot guarantee against physical injury or illness following the sale. But if within 8 months following the sale, the buyer has evidence that the animal is not a breeder, the buyer may obtain a statement signed by a licensed veterinarian to that effect, such statement also indicating that there has been no injury or illness to the animal following the sale, and return the bull to the farm of the seller for adjustment. If the seller cannot then prove the animal to be a breeder, an adjustment will be made by the seller, either by substituting an animal of equal value, or by the refund of the full purchase price. Such adjustment shall be considered full settlement and satisfaction of all claims. No guarantees apply to animals which are shown following the sale.

## X. GENETIC DEFECT AND PARENTAGE GUARANTEE

For complete rules and regulations in regard to genetic defects or parentage guarantee contact the RAAA. Ask for Section C Registration Requirements.

Osteopetrosis: The Red Angus Association along with animal scientists have developed a DNA marker test for osteopetrosis (OS), a genetic disorder which in rare instances can cause the loss of a calf at birth. Since the test was developed, Beckton has tested every sire being used in our breeding program. Only one sire, from outside our program, tested positive as a carrier of the gene. Every sire bred and raised at Beckton has tested 'Free'. All of our major semen sires have also been tested 'Free'. We guarantee every sale animal to be OS Free, and if you have a concern, we will have any sale animal tested on request. If an animal were to test positive, we would replace the animal or refund the purchase price. The testing we have done shows no incidence of occurrence in any Beckton bloodlines for the past 30 years, and so we believe there is no safer herd than ours.

## XI. RETAINED INTEREST AND SEMEN RIGHTS:

Beckton is selling full possession and one half semen interest in all the bulls in the catalog. Seller is retaining one half interest in all bulls in the catalog. This is done so we can use some of the bulls in herd and reserve the right to collect and market semen on these bulls. Any collection on our behalf would be at our expense and could be done during the off-season and at the convenience of the buyer. The buyer would have the option to share in the collection and retain semen for the buyer's use also. If semen is marketed by either party, Seller receives one half royalty interest on gross semen sales, and buyer receives one half interest. Regardless of semen collection and marketing, the buyer retains full possession, full pasture use rights, and full salvage value in these bulls.

## XII. RIGHTS AND OBLIGATIONS

A. The above terms and conditions of sale shall constitute a contract between the Buyer and Seller of each animal and shall be equally binding upon both. Each sale or resale of an animal constitutes a separate transaction.

B. Neither the sale manager, the owner, nor any other person connected with the management of the sale, assumes any liability, legal or otherwise.



# Lot-Tag Cross Reference

ID	Lot	ID	Lot	ID	Lot	ID	Lot	ID	Lot	ID	Lot		
<i>Reference Sires</i>		<i>Bulls</i>		B157	.93	B328	.41	B504	.126	B664	.65	<i>Heifers</i>	
7466	J-2	B002	.141	B159	.50	B331	.159	B507	.72	B667	.160	B038	.329
B571	J-1	B008	.16	B165	.109	B333	.66	B508	.28	B669	.46	B050	.324
M045	N-1	B009	.218	B166	.192	B334	.212	B516	.27	B673	.127	B096	.327
P707	N-2	B010	.97	B167	.255	B336	.100	B520	.2	B675	.189	B168	.318
S347	N-3	B017	.108	B175	.137	B337	.183	B523	.181	B678	.153	B178	.312
S670	L-1	B018	.84	B180	.227	B343	.42	B527	.173	B681	.30	B199	.303
U130	L-2	B022	.43	B182	.198	B345	.4	B528	.202	B682	.49	B258	.330
U749	E-1	B023	.37	B187	.155	B347	.224	B531	.139	B683	.83	B279	.308
U777	A-1	B025	.200	B191	.102	B350	.13	B534	.10	B692	.99	B289	.314
W180	A-2	B026	.199	B202	.187	B356	.94	B535	.166	B695	.247	B293	.313
W486	N-4	B027	.110	B205	.74	B358	.87	B539	.152	B697	.44	B295	.309
W534	W-2	B030	.208	B209	.35	B365	.169	B540	.132	B702	.236	B304	.304
W640	D-1	B034	.51	B210	.67	B377	.91	B542	.103	B706	.164	B321	.331
W692	C-1	B037	.68	B211	.258	B389	.197	B544	.144	B709	.214	B326	.319
W841	J-3	B040	.175	B214	.20	B390	.15	B548	.106	B712	.114	B332	.332
X096	N-5	B047	.172	B219	.6	B392	.55	B559	.232	B714	.180	B338	.307
X330	E-2	B049	.233	B223	.185	B393	.254	B569	.25	B718	.147	B367	.316
X403	H-1	B060	.23	B226	.248	B399	.95	B570	.203	B720	.3	B372	.305
X458	S-3	B065	.125	B228	.235	B403	.113	B573	.194	B721	.98	B388	.326
X464	E-3	B066	.223	B230	.63	B407	.171	B577	.89	B722	.75	B395	.315
X465	J-4	B067	.124	B231	.204	B410	.32	B578	.163	B725	.111	B412	.302
X494	S-1	B072	.119	B233	.21	B414	.69	B579	.39	B726	.243	B461	.306
X816	E-4	B080	.76	B236	.5	B416	.22	B584	.12	B729	.240	B469	.310
Y012	C-2	B087	.165	B237	.29	B423	.82	B585	.54	B731	.225	B496	.301
Y124	L-3	B088	.115	B238	.62	B424	.191	B587	.251	B737	.78	B513	.322
Y194	N-6	B091	.213	B239	.207	B427	.140	B589	.201	B743	.148	B514	.325
Y260	A-3	B092	.158	B241	.31	B429	.134	B598	.60	B751	.237	B541	.335
Y312	A-4	B094	.145	B242	.176	B435	.157	B599	.80	B754	.219	B596	.317
Y484	E-5	B095	.154	B244	.177	B437	.33	B600	.120	B758	.221	B665	.321
Z111	N-7	B098	.249	B250	.230	B438	.168	B601	.45	B761	.121	B672	.328
Z180	N-8	B100	.257	B254	.186	B441	.117	B602	.26	B762	.36	B723	.323
Z225	R-1	B101	.122	B256	.53	B442	.245	B603	.196	B766	.131	B728	.333
Z382	J-5	B103	.259	B257	.11	B446	.17	B607	.161	B767	.209	B739	.311
Z434	E-6	B104	.123	B259	.8	B447	.143	B611	.217	B768	.215	B772	.320
Z460	S-2	B106	.211	B260	.216	B448	.48	B614	.222	B771	.239	B865	.334
Z506	A-5	B107	.253	B273	.162	B449	.210	B615	.19	B774	.234		
Z674	E-7	B109	.112	B278	.40	B451	.105	B617	.64	B776	.142		
Z689	L-4	B110	.86	B280	.238	B453	.179	B619	.250	B777	.116		
Z750	E-8	B112	.57	B284	.79	B457	.56	B624	.190	B782	.206		
Z824	C-3	B122	.156	B287	.24	B458	.92	B626	.118	B784	.85		
Z936	W-1	B123	.167	B291	.170	B462	.59	B629	.81	B788	.231		
ZT220	C-4	B124	.205	B297	.220	B464	.150	B631	.244	B789	.184		
		B127	.146	B303	.18	B468	.14	B638	.107	B796	.178		
		B131	.149	B305	.101	B476	.138	B641	.188	B797	.241		
		B132	.252	B309	.195	B478	.1	B643	.9	B815	.130		
		B139	.104	B311	.135	B479	.90	B644	.228	B820	.128		
		B142	.193	B315	.71	B487	.58	B645	.136	B821	.229		
		B145	.242	B317	.61	B488	.52	B646	.70	B824	.73		
		B154	.7	B318	.246	B491	.38	B654	.133	B827	.47		
		B155	.77	B322	.88	B500	.96	B655	.182	B830	.34		
		B156	.226	B323	.129	B502	.174	B656	.256	B831	.151		

# Notes



## Semen Available

Bull Name	Calv. Ease	BW	WW	YW	Milk	HPG	Stay	ME	Marb	REA	Bfat	Price
	Acc.	Acc.	Acc.	Acc.	Acc.	Acc.	Acc.	Acc.	Acc.	Acc.	Acc.	
<b>Beckton Lancer T A664</b>	<b>15</b>	<b>-3.0</b>	<b>28</b>	<b>59</b>	<b>6</b>	<b>-1</b>	<b>14</b>	<b>7</b>	<b>.25</b>	<b>.01</b>	<b>-.01</b>	<b>\$25</b>
Reg. 358389	.89	.92	.90	.90	.89	.80	.77	.62	.74	.72	.60	
<b>Beckton Cody KH M390</b>	<b>13</b>	<b>-4.5</b>	<b>26</b>	<b>57</b>	<b>13</b>	<b>9</b>	<b>12</b>	<b>-4</b>	<b>.01</b>	<b>-.07</b>	<b>.02</b>	<b>\$25</b>
Reg. 854892	.47	.76	.67	.62	.45	.01	.01	.34	.44	.41	.27	
<b>Beckton Cherokee N N479</b>	<b>14</b>	<b>-5.6</b>	<b>31</b>	<b>50</b>	<b>25</b>	<b>11</b>	<b>13</b>	<b>-5</b>	<b>.08</b>	<b>.27</b>	<b>.02</b>	<b>\$25</b>
Reg. 916601	.63	.76	.72	.70	.63	.36	.30	.42	.50	.47	.32	
<b>Beckton Warrior N645 T1</b>	<b>5</b>	<b>-0.2</b>	<b>40</b>	<b>78</b>	<b>8</b>	<b>9</b>	<b>10</b>	<b>-1</b>	<b>-.01</b>	<b>.01</b>	<b>.01</b>	<b>\$25</b>
Reg. 916767	.31	.66	.54	.45	.27	.15	.01	.16	.36	.34	.23	
<b>Beckton Epic K4 N795</b>	<b>8</b>	<b>-0.5</b>	<b>38</b>	<b>90</b>	<b>18</b>	<b>-8</b>	<b>10</b>	<b>6</b>	<b>.51</b>	<b>.05</b>	<b>.09</b>	<b>\$25</b>
Reg. 916917	.77	.82	.80	.81	.75	.64	.29	.57	.67	.66	.72	
<b>Beckton Nebula L P093</b>	<b>11</b>	<b>-3.8</b>	<b>61</b>	<b>93</b>	<b>4</b>	<b>10</b>	<b>14</b>	<b>2</b>	<b>.49</b>	<b>.11</b>	<b>.01</b>	<b>\$25</b>
Reg. 978419	.79	.84	.82	.82	.77	.57	.21	.67	.45	.41	.48	
<b>Beckton Epic R350 K</b>	<b>11</b>	<b>-3.7</b>	<b>25</b>	<b>54</b>	<b>17</b>	<b>11</b>	<b>11</b>	<b>1</b>	<b>.14</b>	<b>.09</b>	<b>.01</b>	<b>\$25</b>
Reg. 1042088	.23	.26	.25	.25	.25	.19	.17	.18	.01	.01	.01	
<b>Beckton Nebula PJ S543</b>	<b>16</b>	<b>-6.4</b>	<b>64</b>	<b>100</b>	<b>20</b>	<b>-1</b>	<b>13</b>	<b>4</b>	<b>.56</b>	<b>-.02</b>	<b>.01</b>	<b>\$25</b>
Reg. 1119006	.60	.74	.70	.71	.56	.37	.01	.65	.30	.26	.39	
<b>Beckton Justice T124 C1</b>	<b>14</b>	<b>-3.7</b>	<b>31</b>	<b>67</b>	<b>13</b>	<b>10</b>	<b>12</b>	<b>-6</b>	<b>.17</b>	<b>.16</b>	<b>.00</b>	<b>\$25</b>
Reg. 1178635	.13	.34	.24	.24	.14	.01	.01	.01	.25	.24	.20	
<b>Beckton Juniper T826</b>	<b>10</b>	<b>0.4</b>	<b>35</b>	<b>70</b>	<b>9</b>	<b>10</b>	<b>16</b>	<b>-4</b>	<b>.03</b>	<b>.21</b>	<b>.00</b>	<b>\$25</b>
Reg. 1179117	.17	.34	.21	.27	.19	.01	.01	.10	.01	.01	.01	

# Family who help us in many ways over the course of the year



*The extended Forbes clan attending the wedding of Cam & Trish's daughter Tallie Forbes' to Justin Lee*



*Julia Forbes and Ed Waddington  
(with Tazmin and Flinder)*



*Doug and Sheila Bingham*



*Doug Foster and Sarah Forbes*



*Sal Forbes and Elfie Forbes*



*Kate Bingham and Alison Brody*

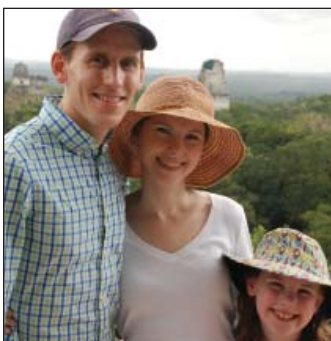

*Don Bingham, Alison Brody,  
and Kate Bingham*



*Kate's best friend, Boofy the Cow*



*Spike, Jo, and Keenan Forbes; Jeff,  
Katie, Julia, Ellen, and Sarah Durkin*



*Elfie Forbes and Ruth Sylvester*

# Beckton Stock Farm

Cam Forbes

37 Beckton Drive

Sheridan, WY 82801

Tel.: 307.674.6095, 674.8162 (evening)

Fax: 307.672.7281

Email: [becktonwyo@gmail.com](mailto:becktonwyo@gmail.com)

Web: [www.BecktonRedAngus.com](http://www.BecktonRedAngus.com)

Video of Sale Bulls available on our Website

## FIRST CLASS

The new Red Angus HERD-BUILDER Index recently developed and implemented by the Red Angus Association, combines economically relevant EPD's (maternal, growth and carcass traits), and weights each EPD for its contribution to overall herd profitability. Designed for commercial producers retaining replacement heifers, this single Index measures and compares and ranks all Red Angus sires in the breed, to provide a single measure of predicted profitability for every sire compared to all other Red Angus sires.

The Red Angus HERD-BUILDER Index is expressed in units equal to actual dollars of predicted profit, per female exposed to a sire. The median sire in the breed (50th percentile) has an Index score of 107. A sire in the 10th percentile, with an Index score of 168, is expected to produce an additional  $168 - 107 = \$59$  profit per mating. If exposed to 150 females over his service lifetime, the 10th percentile bull is expected to produce about \$9,000 more in actual dollar profit, compared to the median bull.

Almost every bull in this, Beckton's 70th Anniversary sale, ranks in the top 25% of the Red Angus breed on the HERD-BUILDER Index, with most in the top 5 or 10%. Many are in the top 1 or 2%, with an expected profitability gain over \$15,000 compared to the average Red Angus yearling bull.

The average yearling bull in Beckton's sale will have an expected profitability gain of more than \$10,000 compared to the average Red Angus bull. This is the result of Beckton's seven decades of balanced genetic selection for the profitable traits in beef cattle production.

41 of the 50 highest ranking HERD-BUILDER sires in the Red Angus breed were produced from Beckton genetics. 18 of these are 100% Beckton bred and owned sires. An additional 23 were produced using Beckton breeding by other Red Angus breeders.

There is more information about the new Red Angus Association HERD-BUILDER Index inside this catalog. Or you may contact either us or the Red Angus Association.

**Free Delivery**  
anywhere in the Continental US