

69th Anniversary Production Sale

Tuesday April 8th, 2014

Industry Leader for
Low Maintenance, Maternal Traits



1 Beckton Red Angus

Foundation Herd of the Red Angus Breed

Transportation

Great Lakes Airlines

Several daily flights to/from Denver
Contact Holiday Inn for airport transfers

Avis Car Rental

T: 307.672.2226, Sheridan Airport

Accommodations

Holiday Inn

307.672.8931, I-90, Exit 25
Ask for special Beckton Sale rate of \$71

Best Western Sheridan Center

307.674.7421, 612 N. Main Street

Days Inn

307.672.2888, 1104 Brundage Lane

Super 8 Motel

307.672.9725, 2435 N. Main Street



Auctioneer Roger Jacobs
406.698.7686

Sight-Unseen Purchase (by mail or phone)

If you are unable to attend the sale, we can help you select the bulls or females to fit your needs. Give us a phone call, letter, fax or e-mail (please refer to the back cover), and we can make arrangements to handle bidding according to your directions. Bulls are bought at the lowest price, and satisfaction is guaranteed on bulls purchased sight unseen. Many of our repeat customers buy their bulls this way.

To provide us adequate time to assist you, please contact us before noon of the day prior to the sale.

Free Delivery

We pay for delivery for all bulls, as well as for purchases of 5 or more heifers to one location, throughout the continental U.S. If you bring a trailer to haul your own, \$50 will be deducted from the price of each bull or heifer. Most of the sale cattle will be delivered from 1-3 weeks after the sale, although we will try to accommodate special needs. Although there occasionally are limitations, in most cases we can deliver the cattle directly to your ranch.

All Bulls "Trich" Tested

In all the years we have been selling and delivering bulls, Beckton has never had a bull test positive for "trich". But because an increasing number of states require testing of yearling bulls, and to avoid any delay in delivery time, we will have all the sale bulls tested negative for "trich" prior to the sale. Customers from any state may also come to the sale with their trailer and load out directly after the sale.

Payment

Payments can be made with cash, check payable to Beckton Stock Farm, Inc. or Visa/Mastercard on sale day.

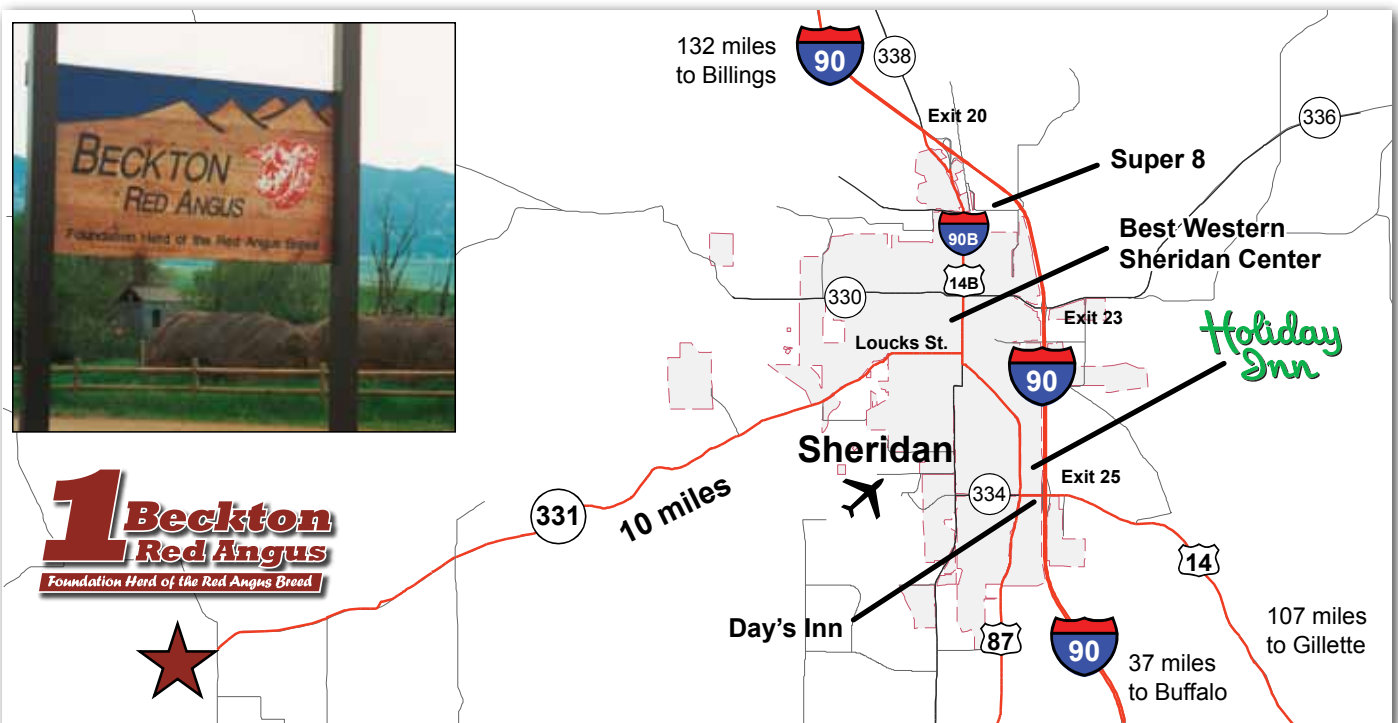

69th Anniversary Production Sale

Beckton Ranch

9½ miles West of Sheridan

Tuesday, April 8th, 2014

1 o'clock pm

Lunch at noon

253 Bulls • 40 Heifers

Selling in catalog order, heifers sell following the bulls

Please join us for a complimentary dinner after the sale at the Holiday Inn.

Phone: 307.674.6095



Cam and Trish Forbes

Some Facts about the Beckton Herd

- ▶ **This is the #1 Herd in the breed for Stayability**, and has been for many years. **Fifteen of the top 20 sires for Stayability EPD** on the RAAA Sire Summary are either Beckton sires or descended from Beckton sires, as are 74 of the top 100 (out of 1574 Red Angus sires in the breed). These are the bulls and heifers that will be with you after the others are gone.
- ▶ **Beckton is also the #1 herd for easy calving, with the best average Calving Ease EPD** of any major herd. **Thirteen of the top twenty sires** in the breed for low Birth Weight EPD are Beckton sires. No other set of bulls will come close.
- ▶ **This has also been the #1 Herd in the breed for Low Maintenance Energy requirements** for many years. **Six of the top twenty sires** in the entire breed for lowest Maintenance Energy EPD are Beckton sires. No other set of bulls will do a better job cutting your cowherd maintenance requirement and saving you feed and money.
- ▶ **Beckton bulls are leaders in total rate of growth, from birth to market weight.** The average birth weight EPD of these sale bulls is minus -4.0, and the average yearling weight EPD is plus 80. **No other set of bulls will start with such low birth weight and reach such a high yearling weight – for marketability and for less time and cost to market.**

TOTAL PERFORMANCE IN THE MOST ECONOMICALLY IMPORTANT TRAITS

High reproduction rate; high calving rate; less time and cost to market weight; and lower total feed inputs and feed costs. Plus 69 years of selection for the convenience traits – good dispositions – cowherd fertility – good udders and milk – and structurally sound cattle well adapted to both high elevation and dry range conditions.

BECKTON BULL AND HEIFER WARRANTY

Optional protection against injury or death, plus Pregnancy coverage for heifers

BULLS: Injury or loss protection coverage - If your bull is permanently injured or dies any time up to 5 months after purchase, you will receive a credit toward purchase of another bull in the amount of the original purchase price minus salvage. The cost is 5% of the purchase price paid at settlement (eg. \$150 for a \$3,000 bull).

HEIFERS: Injury or loss protection plus Pregnancy Guarantee – likewise good for 5 months after purchase. If your heifer fails to become pregnant when exposed to a bull who settles 75% of the other heifers in the same pasture; or in the event your heifer is permanently injured or dies, you will receive a credit toward purchase of another heifer in the amount of the original purchase price minus any salvage. The cost is 10% of the purchase price paid at settlement (eg. \$200 for a \$2,000 heifer).

Serving our customers for 69 years with industry leading genetics and the highest quality cattle.

Additional Sale Information

- ▶ The animals sell in catalog order. We will have a conference call available for telephone bidding. You must register in advance, and conference number and instructions will be available then.
- ▶ All bulls have passed a rigorous fertility exam that included live semen evaluation, scrotal measurements, and reproductive tract examinations.
- ▶ Beckton has a comprehensive herd-wide health program which includes vaccinations for 7-Way, IBR, BVD, PI3, BRSV, Lepto, and ivermectin. The heifers are also vaccinated for bangs and vibrio.
- ▶ When a genetic test was developed by RAAA for osteopetrosis (OS), Beckton tested every sire in use in our program, as well as our major AI sires. Every Beckton bred sire (nearly 80 in total) tested OS Free.
- ▶ We plan to have semen collected on some of the bulls before the sale. We will also work with the buyer to collect bulls after the sale.
- ▶ Beckton's focus has always been on the commercial market. From our earliest sales over 40 years ago, we have retained a 1/3 semen interest on every bull sold through our sales. This policy has been for the benefit of our commercial customers, who are not in the business of selling semen. Buyers at our sale have not had to compete with AI companies when they bid for their choice of bulls. This policy continues with this sale, and unless otherwise designated in the catalog or by the auctioneer, or other arrangements made, the following terms, restated from the terms and conditions, apply to all bulls in the sale:

Buyer receives full possession of the bull, and income from future sale of the animal itself. Buyer also has the sole privilege to determine if and when a bull is collected in the future. Seller retains a 1/3 semen interest on all sale bulls, including the privilege of in-herd use. If a bull is collected in the future, we would like to be notified so we may obtain semen, sharing pro-rata in the collection cost. On bulls from which semen is marketed commercially in the future, seller is entitled to a 1/3 royalty interest on gross semen sales, with buyer receiving 2/3 of gross sales.

This policy helps make every bull in our sale, from Lot 1 on, equally accessible to all of our customers, as well as giving the buyer full possession and control.

▶ **Special Rare Semen Option for BECKTON JULIAN B571 and BECKTON NEBULA P707:**

These are two premier sires in the Red Angus breed, offering the best of all traits for which our program is known. Semen is very limited and not on the market. We are offering a special semen package for each. Details are given on the inside back cover.



Jane Redding

We are both pleased and sad to announce that Jane Redding has retired after nearly 40 years at Beckton. She has been keeping our records accurately and doing many other things as well, as those of you who have met her or spoken to her over the telephone are well aware. She has moved back to Pennsylvania to be with her family, and we wish her nothing but the best.

Table of Contents

The Beckton Program	4
The Bulls	10
The Yearling Heifers	62
Reference Sires	71
RAAA Herd EPD Tables	82
Sire Bloodline Charts	84
Sale Terms & Conditions	86
Lot-Tag Cross Reference	87
Semen Available	88



Video of sale animals is available on our website, www.BecktonRedAngus.com

Lots with small square "QR code" barcodes similar to the one at left have video available to view on your iPhone, Android, Blackberry, or Windows Phone. Simply Scan the code with a free downloadable barcode reader app and you can view video footage of the animal right on your phone screen.

Don't have the app? Don't worry! Simply visit your phone's App Store and search for a "QR Code" app. There are lots of free apps available; "i-nigma" is one that works well on all platforms. If you can't get your phone to work you can still watch all of the videos online using a computer.

VIDEOS BY:



WWW.CATTLEINMOTION.COM



Tommy "T.V." Jones
Record Stockman
307.632.5118



Bob Hough
817.296.0976



Curt Cox
Wyoming Livestock
Roundup
307.630.4604



Jerry Gliko
Western Livestock
Journal
406.656.2515



Alan Sears
Western Livestock
Reporter
970.454.3986



Del Tinsley
Wyoming Livestock
Roundup
307.234.2700



Eric Mack
Wyoming Stockman
Farmer
406.366.2111

1 Beckton Red Angus

37 Beckton Drive • Sheridan, WY 82801 • becktonwyo@gmail.com
Office: 307.674.6095 • Evenings: 674.8162 • Fax: 674.8162

Dear Friends and Cattlemen,

On behalf of everyone here at Beckton, we welcome you to join us for our 69th Anniversary Production Sale. We have our best offering of Red Angus bulls and heifers ever, and hope you will take the opportunity to visit and see them. Following the sale, please join us at a complimentary roast beef dinner at the Holiday Inn.

The future of the beef industry looks very good. Cattle prices are strong, but there is no expansion in the nation's beef cow inventory. We are unlikely to see cheap corn again in the future, so cattle that are productive and functional, while being low cost and efficient, will be desirable now and for years ahead.

Beckton has the leading genetics in the industry to reduce maintenance requirements. This is leading herd for low cow maintenance energy EPD, and this is best sale for finding large numbers of bulls with low maintenance energy genetics. But these cattle also produce – the average yearling weight EPD of this year's sale bulls is +80, the highest ever.

We believe in bulls that work on both heifers and cows, so we need moderate birth weights and live calves on the ground, as much as weaning and yearling weight. This year's sale bulls have an average birth weight EPD of -4.1. The overall gain from 0 to 365 days is the highest we have ever had for a sale offering.

Finally, this is the breed's leading herd for Stayability. 15 out of the highest 20 sires in the breed for Stayability EPD, are Beckton sires or descended from Beckton sires. As are 74 of the top 100. About three out of every four top Stayability animals in the Red Angus breed comes from Beckton genetics. Sustained fertility, calving ease, low maintenance and growth – these are the cattle that stay in the herd.

We recently went through the bulls once more to produce our video, and they look fantastic – thickness and soundness throughout the offering. There will be a sale video up on our website shortly. Lastly, Beckton has never had a positive test for "trich", but because so many more states are requiring it, we have tested all the bulls 'trich negative' ahead of the sale, so there will be no concern on your part or delay in delivery.

Our heifer offering is smaller than past years because Forest and Sue Dunning have retired and we no longer have Tongue River cattle with us. However the heifers we did select for the sale come from the top end of Beckton's replacements. They are functional and feminine, and will make beautiful and moderate sized brood cows. These are the females that go on to produce the upper end of the bulls you see in the sale.

Again, please join us for the sale and for dinner afterward. If we can help you in any other way, we will do our best.



Cam and Trish Forbes

Sincerely,

Cam Forbes

Beckton Red Angus • Since 1945
The Foundation Herd of the Red Angus Breed

The Beckton Program

Cow Size

The goal for Beckton's program has always been to develop breeding seedstock which offer increased levels of performance for the commercial cattleman. Increased performance does not mean maximizing weight and size, which have already reached the upper limit of economic value for the packer and consumer. It does, however, mean increasing performance related to calving percentage and weaning percentage; and increasing performance related to cow maintenance requirements and "pounds of calf per acre" efficiency.

Size Matters

Beckton cattle are already big enough for the consumer and the packer. Using yearling weight EPD as the best available indicator of market size, the average for our sale bulls is +80, about the same as the Red Angus breed average, so for market size our cattle are directly comparable.

The big difference with Beckton's program is that we select for additional weaning and yearling weight, but with the restriction that we have maintained the same cow size over time. In contrast, the industry has allowed cow size to increase at the same rate as calf size. Cow size is the largest factor determining maintenance requirements. Our goal has been to increase efficiency, not size. No other seedstock breeding program has had such a goal and maintained it for so long.

Beckton Cow Weight Average (lb.)

Year	1978	1982	1986	1990	1994	1998	2002	2006	2010	2012
Wt.	1,126	1,126	1,064	1,115	1,067	1,125	1,104	1,093	1,068	1,100

(mature lactating cows taken at weaning)

Cow weights vary from year to year depending on grass, weather or other short term factors. But overall our cow size has stayed fairly constant over time.

The Industry Problem

As shown on the graph on the next page, industry-wide cow size has increased substantially, 25% over this same period. But look at the industry-wide trend in feed use per cow over the same period, shown by the use of hay:

Industry Hay Use (tons/animal unit)

Year	1978	1982	1986	1990	1994	1998	2002	2006	2010
Hay Usg.	1.43	1.62	1.91	2.00	1.94	1.99	2.08	2.05	2.08
Pct.	100%	113	134	140	136	140	146	143	146

(Src.: USDA Econ. Research Service, 2010 is newest available data)

Industry-wide, production per cow is up about 25% since the 1970s, but hay consumption per cow is up more than 40%.

Why does hay use increase at a faster rate than cow size or production per cow? Hay and grain are supplements to the cow's main diet, which is grass, and grass supply is relatively fixed by environment. Each increase in cow feed requirement must be met entirely by supplements, or by a combination of supplement and reduced stocking rate. A small increase in cow feed requirement leads to a reduction in stocking rate or a large increase in higher-cost, supplemental feed needs.

Any gains achieved in the feedlot sector due to increased animal growth, have been overwhelmed by increased cost of production in the cow-calf sector.

The Beckton Crew...



Tom Peek



Randy Zier



Alan Sanders

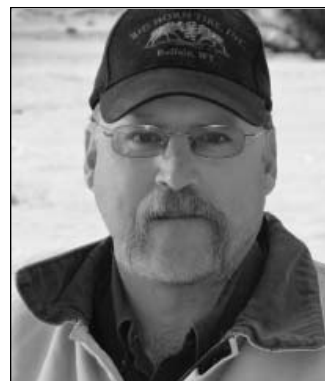

Roger Zier

Efficiency

35 Years of Change: Industry-Wide

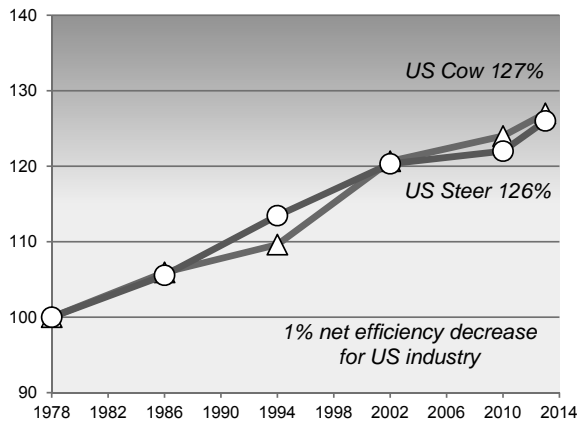

The graph at left shows how, for the U.S. cattle industry overall, the increase in average calf weights, as measured by steer slaughter weights, has been directly matched by an increase in average cow weights. (Percentages are based on USDA slaughter weight data for steers and cows respectively, using 1978 as a base year. Data for heifers slaughtered shows an identical trend.) Over 35 years, there has been minimal change in overall cowherd efficiency.

This graph shows the failure of cross-breeding and composite breeding to do little more than simply increase general cattle size. In the promotion of composites, the impact of retained heterosis on mature weight is too often ignored. Crossbreeding and composites are sold as a free lunch, but they aren't free.

We have accomplished this by selecting for growth, restricting birth weight and cow size creep, and multiplying each incremental change rapidly throughout our entire cowherd and all of our bloodlines. Usually this has meant working within our own bloodlines rather than introducing out-crosses, because the outside genetics for the direction we wanted to go haven't been available. The overall key to success is simply that we have been making small progress in multiple traits, but doing it consistently over a very long period of time.

35 Years of Change: Beckton

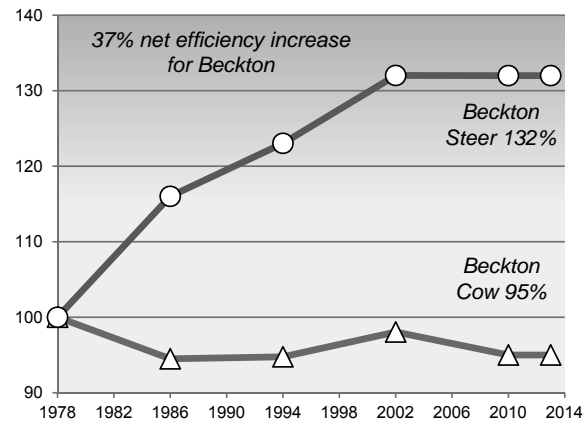

The graph at right shows Beckton cowherd data over the same time period.

1. Beckton cow size has shown no significant change over the past 35 years, while the industry has experienced a substantial increase in cow size.
2. Even without increasing cow size, we have raised the rate of early growth in Beckton cattle, using intense genetic selection and generation turnover, and by more than the rest of the industry.
3. The net change in efficiency as measured simply by "calf weight divided by cow weight" is significantly higher with Beckton's genetic program, compared to mainstream cross-breeding based on retained heterosis.

... making the Beckton Program work!



Sherry Kobielus



Matt Zier



Travis Adsit



Shelby Whitman



Tyler Miller

Management

One Bull – the Simple Solution is the Best Solution

Many cattlemen use Beckton bulls for their heifers because of their low birth weights and high calving ease. Our bulls are even better when used on cows, because replacement heifers tend to be selected from calves out of older cows. **Keeping replacement heifers sired by Beckton bulls is the quickest way to limit cow size creep and to moderate cow size for the future.** In our own program we use the same bulls on both heifers and cows. Every bull is used his first year with heifers to evaluate calving ease, and used in future years with older cows. We get calving ease, growth, and moderate-sized replacements, all with the same bull.

Quietness and Ease of Handling

The necessity of record keeping means that our cattle will be handled much more than commercial cows. **This benefits our seedstock customers because our cattle will be quieter and easier to handle.** Good disposition is one of our most valued traits.

Selection for Industry Requirements

In order to make selection decisions appropriate to the commercial beef industry, seedstock cattle need to be managed and measured under conditions which will approximate the commercial industry. **Our cows are run entirely on grass, with hay only if weather conditions require it, because that is how the commercial industry runs cows.** However, almost all commercial calves go into feedlots before slaughter, so feedlot performance and efficiency is an important trait for calves. **Simply put, a producer needs to know how his cows perform on grass, and how his calves perform with feed.**

Our bulls are run on a performance test designed to provide the fairest basis of comparison among them, and

this requires a compromise. Our bulls receive a “growing” ration high in roughage and protein and not as high in energy as a steer would receive. **We want to get a good measure of gainability with which to compare bulls, but we don’t want the bulls fat.**



Craig Uden, Darr Feeders Manager
Photo courtesy of the Lexington Clipper-Herald

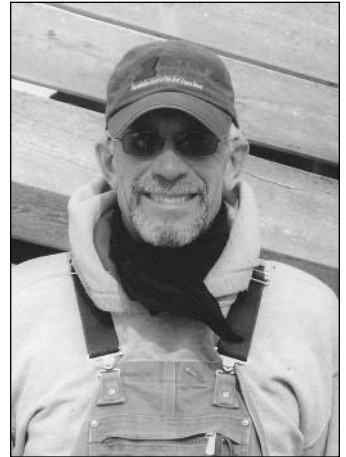

Mitch Ziebell, Darr Feeders

Mitch Ziebell, Craig Uden of Darr, NE

Since 1979 all of our bulls have been performance tested at a facility owned and managed by the Kugler family near Cozad, Nebraska. In the fall of 2005, Lane Kugler retired and the operation was bought by a neighboring operation – Darr Feeders. The overall operation is managed by Craig Uden, with the bulls under the daily management of Mitch Ziebell. **We have been very impressed with the conscientious care with which Mitch oversees all aspects of the bull management.**

Contributing to the success of the Beckton Program...



Sarah and Mark Schreiber
Our vets



Kate Roberts
Cattle-in-Motion



Cody Cunningham
Brand Inspector

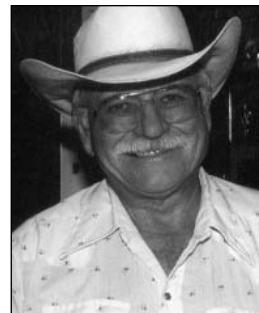

Dr. Robert Bohlander
Fertility tests the bulls



Bob Milner
Our AI tech

Additional Facts about the Beckton Program

Birth weight

- ▶ Every sire entering our own program is used first on our own heifers, then on our cows.
- ▶ We have never used high birth weight sires in any part of our program, so big birth weights are rare.
- ▶ We get the pay weight, but with lower birth weights and greater calving ease.
- ▶ Full production from heifers. We use the same bulls on heifers and cows.

Growth

- ▶ Weaning efficiency, and rate of gain to slaughter weight second to none.
- ▶ Growth traits must be consistent with maintaining maternal qualities.
- ▶ Beckton cattle are ideally sized for today's packer demand.

Hardiness

- ▶ Every cow in the herd has spent part of her life in the Big Horn Mountain summer range, at elevations from 7000 to 10,500 feet.
- ▶ In 2001 we PAP tested all of our herd sires. The herd average PAP score was 32.5 at 4000', equivalent to a herd average PAP of 39 at 8000' (excellent scores).
- ▶ By the time she is 5, our average cow will have been trailed over 80 miles, above and beyond normal pasture rotation.

Efficiency

- ▶ The typical dam of our bulls weans over 50% of her body weight in 205 days, under range conditions, with no creep-feeding.
- ▶ The average dam produces over 100% of her own body weight in a year.
- ▶ The average mature cow (age 5+) weighs about 1100-1125 pounds.

Fertility

- ▶ Every bull in our program is used in natural service, with 30-50 heifers/cows.
- ▶ Every cow in our program must cycle naturally and breed early under range conditions.

Value

- ▶ Beckton Red Angus produce more growth without high birth weights.
- ▶ They are the one-bull solution that can be used on both heifers and cows.
- ▶ Carcass quality is an extra benefit.

Reliability

- ▶ Beckton has been genetically improving Red Angus since 1945, a 30-60 year lead time over other producers.
- ▶ It is a complete, genetically sound breeding program, which demands whole-herd performance.



Long-time friends and business partners Sue and Forest Dunning have retired from the Red Angus business



*Doug Bingham
Webmaster and
database guru*



*Cody and Chad Halfmann, Halfmann Red Angus
Special thanks for helping to create the bull videos*

Beckton History



Sal keeping records.



Waldo Forbes - 1st President of the Red Angus Association.



Beckton house/office before being moved in 1905 to its current location. This house was built in the 1880s by George Beck, the original homesteader. The antlers are still on the porch, and it is one of the oldest buildings in Sheridan County.



The Waldo Forbes family in 1959: Ellen, Julia, Sal, Sarah, Cherry,, Spike, and Cam & Elfie in front.



Inspection Committee at Beckton (1954), including George and Vernice Chiga, Sal and Waldo Forbes and Spike.



Beckton Larkabeau O "220" in 1959 - the 1st Red Angus Bull at ABS



Mrs. Waldo (Sal) Forbes was honored as the first woman inducted into the Saddle and Sirloin Club's portrait gallery in Louisville, KY.

Using New Selection Tools

Maintenance EPD

This EPD predicts the relative feed energy requirement for maintenance, for cows produced by a sire or female. A bull with an ME of -3 (minus 3) is expected to sire replacement daughters which will need 10 fewer mcals of energy per month than a bull with an ME of +7.

We believe this is an important EPD because feed costs, both direct and indirect through ranch overhead, make up by far the largest proportion of operating costs. It can have much more direct impact on ranch profitability than Marbling or Ribeye EPD for example.

The Beckton herd has been one of the breed's top herd for low maintenance energy requirements for many years.

Calving Ease

The Red Angus Calving Ease EPD was introduced in 2003, and is a more direct measure of calving ease than birth weight alone. Calving Ease is defined as follows: "The expected differences of calving ease measured as the probability difference (between sires) of unassisted calvings among offspring." For Calving Ease EPD, the higher number is better.

There are two Calving Ease EPD's - "Direct", a predictor of an animal's own offspring; and "Maternal", a predictor of a daughters calving ease. Unless stated otherwise, we publish the Calving Ease Direct because most of our customers' primary concern is selecting bulls for use on first calf heifers.

Beckton's average Calving Ease EPD is +12, a full eight points higher than the the Red Angus breed average of 4, due to our long history of selection for moderate birth weights. **The average Beckton bull is in the top 4% of the entire breed for highest Calving Ease.**

Cow Efficiency

We present two indicators of efficiency. The first is Weaning Percent, a simple percentage of calf 205 day weight divided by the dam's actual weight at weaning. The second is PRI Cow Efficiency. This also measures calf weaning weight, but relative to the cow's metabolic weight, and is expressed as an index above or below 100.

These efficiency measures are best used as indicators of where an animal is relative to others, rather than directly for selection. For example, if we see an animal with a low efficiency, we would look at the actual calf and cow weights to decide if the calf is too small, or the cow too big for the environment. That in turn will suggest corrective actions. In general, select for the traits you need to change to make cattle more efficient, and efficiency will be the result.

Beckton has been performance tested selection since 1945, and we believe our cattle today are the most efficient in the industry.

Dam Information

A major difference with our catalog is the greater amount of information about the dams we provide. Weaning percent and Cow Efficiency are explained above. In addition, with each sale animal we give the dam's age when this calf was born, and the dam's actual weight when the calf was weaned the previous fall. We also provide her progeny averages – the average birth weight, weaning ratio, and yearling ratio – of her calves.



The Bulls

Our bulls are managed in a manner to gain important performance data and information, and equally importantly, to develop and provide our customers with many years of productive service. We have been testing breeding bulls over 50 years, longer than almost any other producer. Our own breeding is based primarily on natural service, not AI, so we see how our bulls work in the pasture. We use bulls raised and managed just this way, with our own cows and heifers, on every kind of terrain, and high in the Bighorn Mountains.

For the first twenty years our bulls were tested at home here in Wyoming. They received some grain, but otherwise grass pasture and dry hay. In 1979 we moved our test to a facility managed by the Kugler family in Cozad, Nebraska, where the bulls got a ration including silage, corn and protein. When we brought our first bulls home from Kuglers' and used them with our own cowherd, we discovered a dramatic increase in libido and breeding performance. The effect of proper

nutrition was apparent, and the bulls would maintain condition and hold up better through the entire breeding season. We have continued managing our bulls at the same facility ever since (now managed by Craig Uden), and we continue to see the same benefits.

We have since used over 500 of these bulls natural service in our own breeding program, on dry range and in the mountains, and have never had a bull fall out of our program early due to his feeding or testing management. Beckton Julian B571, Lancer F442, Nebula M045, Nebula P707, and all of our other great sires were fed and managed in Cozad. While it is possible to feed bulls improperly under any structure, we would strongly question those who promote the notion of any advantage to "forage-raised" bulls. Every year we see the results and success of our bull management program, and we serve many satisfied customers.



• Bulls •

1 **BECKTON JULIAN A434 N6** 

1-A 100% # 1626302 Tat.: BKT3 A434

Birth: 3-27-13

BECKTON JULIAN X465 J5
Ref. J-4

BECKTON LAKME T689 NX

Beckton Julian G5 S107
Beckton Sufaina P643 JL
Beckton Nexus L016
Beckton Lakme M669 EP

Beckton Julian GJ P535
Beckton Minola P826 DM
Beckton Julian GG B571
Bkt Sufaina A828 DM
Beckton Neptune R1 J245
Beckton Coca J276 CL
Beckton Epic K F075
Beckton Lakme F560 TP

DAM		Calv.Ease	BW	WW	YW	Milk	HPG	Stay	Maint.En.
Age	6	9	-1.8	60	102	17	12	15	-3.8
Wt	1085								
Prog.BW	72		Marb +.65		REA +.00		Bfat +.03		
WR	107								
YR	107								
Wean Pct.	57%	BWt	WWt	WR	ADG	YWt	YR	Scr.	Fr.
Cow Eff.	121	75	622	112	4.16	1207	112	33	6.0

Mitch Ziebell has taken care of our bulls for many years, and works with them throughout the year. We ask him to evaluate the bulls for phenotype. Julian A434 was one of his very top picks this year. With his high yearling weight and low maintenance EPD, A434 is Lot 1. His Lakme dam is a 5 year old with an excellent progeny record, and his granddam has produced 10 calves for us.



Beckton Nebula M045
Sire of lot 182; Ref. Sire N-1

2 **BECKTON NEW ERA A409 N2** 

1-A 100% # 1626466 Tat.: BKT3 A409

Birth: 3-26-13

BECKTON NEW ERA Y194
Ref. N-9

BECKTON EOLA W796 N

Beckton Nebula P P707
BKT Larkeisa T310 JC
Beckton Nebula L P093
Beckton Eola S023 JT

Beckton Nebula M045
Beckton Lana M809 EP
Beckton Justice C1 R483
BKT Larkeisa R775 JC
Beckton Nebula M045
Beckton Marta M021 LN
Beckton Jet L P491
Beckton Eola P336 CE

DAM		Calv.Ease	BW	WW	YW	Milk	HPG	Stay	Maint.En.
Age	4	11	0.6	80	126	14	12	14	-1.8
Wt	1270								
Prog.BW	83		Marb +.62		REA +.00		Bfat +.03		
WR	115								
YR	118								
Wean Pct.	47%	BWt	WWt	WR	ADG	YWt	YR	Scr.	Fr.
Cow Eff.	99	87	615	115	4.27	1253	118	35	6.0

Beckton New Era Y194 is probably the best new young sire we have ever produced at Beckton. A409 was one of our highest bulls on test this winter, and is potentially one of the best bulls ever in our sale. He is a linebred Nebula M045 and another of Mitch's top picks for phenotype. He also received a top score of 10 for Tenderness genes on Igenity's DNA profile. We would like to collect semen from several of these herd bull prospects after the sale if the buyers are willing, and A409 would definitely be one to collect.

3 **BECKTON EPIC A098 H6** 

1-A 100% # 1626251 Tat.: BKT3 A098

Birth: 3-14-13

BECKTON EPIC T330 L5
Ref. E-1

BECKTON LARKABA S838 HS

Beckton Epic K4 N795
Beckton Belga K202 LN
Beckton Hasten P292
Beckton Larkaba M715 WR

Beckton Epic KJ J722
Beckton Sierra J789 EP
Beckton Lancer T A664
Beckton Belga D460 KR
Beckton Hustler C2 L079
Beckton Sheba L644 CH
Beckton Warrior C C355
Beckton Larkaba D388 SC

DAM		Calv.Ease	BW	WW	YW	Milk	HPG	Stay	Maint.En.
Age	7	12	-6.3	33	55	27	9	14	-3.8
Wt	1080								
Prog.BW	65		Marb +.56		REA +.17		Bfat +.02		
WR	102								
YR	102								
Wean Pct.	47%	BWt	WWt	WR	ADG	YWt	YR	Scr.	Fr.
Cow Eff.	99	65	509	91	4.27	1146	106	39	5.5

Epic sires are making a name for themselves at in both registered and commercial herds, and at AI services. Lot 3 combines growth with exceptional calving ease potential. His dam is going on eight years of age and has calved every year in the first two and a half weeks of the calving season. The two grand-dams have produced 18 calves for us!! Fertility is probably the most valuable trait of all.

4 **BECKTON NEW ERA A344 D2** 

1-A 100% # 1626249 Tat.: BKT3 A344

Birth: 3-24-13

BECKTON NEW ERA Y194
Ref. N-9

BECKTON LANA S742 DM

Beckton Nebula P P707
BKT Larkeisa T310 JC
Beckton Dominor ZC M919
Beckton Lana N473 WR

Beckton Nebula M045
Beckton Lana M809 EP
Beckton Justice C1 R483
BKT Larkeisa R775 JC
Beckton Dominor Z E401
Beckton Barmaid J012 CO
Beckton Warrior T1 H281
Beckton Lana K237 EP

DAM		Calv.Ease	BW	WW	YW	Milk	HPG	Stay	Maint.En.
Age	7	11	-0.5	62	108	21	13	16	-2.3
Wt	1080								
Prog.BW	76		Marb +.70		REA -.05		Bfat +.05		
WR	110								
YR	110								
Wean Pct.	56%	BWt	WWt	WR	ADG	YWt	YR	Scr.	Fr.
Cow Eff.	117	87	600	108	3.93	1185	110	35	6.0

Another New Era son with outstanding phenotype and performance records. He offers excellent phenotype and a tremendous spread from birth to yearling. His dam, Lana S742, was singled out from our herd and purchased by Kerry Sheaman, and you can see from her progeny averages what a cow she is. Both grand-dams are also in the very upper part of the herd. Lot 4 was also one of a few bulls DNA profiled this winter, and he received the top score of 10 for Tenderness.

5 **BECKTON JULIAN A293 J6** 

1-A 100% # 1625857 Tat.: BSF3 A293

Birth: 3-23-13

BECKTON JULIAN W743 H5
Ref. J-3

BECKTON TAMARA U249 JC

Beckton Julian G5 S107
Beckton Kit L399 HR
Beckton Justice C1 R483
Beckton Tamara M823 LN

Beckton Julian GJ P535
Beckton Minola P826 DM
Beckton Herald F FA20
Beckton Kit F468 JL
Beckton Justice CH M056
Beckton Tamara J124 HR
Beckton Lancer TL G626
Beckton Tamara F269 CH

DAM		Calv.Ease	BW	WW	YW	Milk	HPG	Stay	Maint.En.
Age	5	12	-0.6	56	90	23	12	14	2.2
Wt	1185								
Prog.BW	70		Marb +.50		REA +.01		Bfat +.04		
WR	109								
YR	108								
Wean Pct.	52%	BWt	WWt	WR	ADG	YWt	YR	Scr.	Fr.
Cow Eff.	110	85	620	111	3.43	1153	107	36	5.5

Top sires usually come from outstanding dams. If you look back through our catalogs you will Tamara cows appearing frequently with sons at the front of the sale. This dam is no exception, with a very high progeny record. A293 is Julian top and bottom in the pedigree and has the phenotype to go with his performance records.

6 **BECKTON NEBULA A678 N4** 
1-A 100% # 1626421 Tat.: BKT3 A678

Birth: 4-7-13

BECKTON NEBULA T398 V3
Ref. N-4

- Beckton Nebula L P093
- Beckton Minerva J615 VG

BECKTON LANA W400 N

- Beckton Nebula T398 V3
- Beckton Lana T535 NB

- Beckton Nebula M045
- Beckton Marta M021 LN
- Beckton Vegas PK F485
- Beckton Minerva F433 VG
- Beckton Nebula L P093
- Beckton Minerva J615 VG
- Beckton Nebula L P093
- Beckton Lana N485 LN

DAM		Calv.Ease	BW	WW	YW	Milk	HPG	Stay	Maint.En.
Age	4	10	0.8	75	112	8	11	14	-4.1
Wt	1095	Marb +0.53		REA +0.09		Bfat +0.04			
Prog.BW	85	BWt	WWt	WR	ADG	YWt	YR	Scr.	Fr.
WR	88	87	652	122	4.33	1244	118	38	6.5
YR	118								
Wean Pct.	58%								
Cow Eff.	122								

Another Nebula who was up with Lot 2 at the top of our bull test this winter. Lot 6 is very powerful in the growth numbers, as well as phenotype. His Maintenance Energy EPD is minus -4, making him a very strong herd sire prospect.



Beckton Julian B571
Sire of lot 100; Ref. Sire J-1

8 **BECKTON JULIAN A538 N5** 
1-A 100% # 1626364 Tat.: BKT3 A538

Birth: 3-31-13

BECKTON JULIAN G5 S107
Ref. J-2

- Beckton Julian GJ P535
- Beckton Minola P826 DM

BKT PINE MARIE U621 NB

- Beckton Nebula P P707
- BKT Pine Marie P475 LN

- Beckton Julian 7526G
- Beckton Mona D086 JL
- Beckton Dominor ZC M919
- Beckton Minola M641 WR
- Beckton Nebula M045
- Beckton Lana M809 EP
- Beckton Lancer T4 J536
- Bkt Pine Marie LC30 CD

DAM		Calv.Ease	BW	WW	YW	Milk	HPG	Stay	Maint.En.
Age	5	11	-4.8	54	98	19	15	15	-3.8
Wt	1065	Marb +0.64		REA -0.03		Bfat +0.06			
Prog.BW	61	BWt	WWt	WR	ADG	YWt	YR	Scr.	Fr.
WR	106	64	625	112	3.54	1187	110	39	5.5
YR	107								
Wean Pct.	59%								
Cow Eff.	124								

One of the biggest spreads between birth and yearling weight EPD's in the entire sale. An excellent scrotal (also, the scrotals were taken quite early this winter, at the beginning of February). Julian A538 has a Pine Marie dam with all of her calves in the top third of the calf crop at weaning and yearling.



Sue and Forest Dunning

7 **BECKTON ACCENT A192 E3** 
1-A 100% # 1626273 Tat.: BKT3 A192

Birth: 3-19-13

BECKTON ACCENT W180 C2
Ref. A-2

- Beckton Cody K1 P014
- Beckton Christy R046 CQ

BECKTON LANA T200 EM

- Beckton Emperor R100
- Beckton Lana R327 EP

- Beckton Cody KH M390
- Beckton Rose M126 WR
- Beckton Cherokee N N479
- Beckton Christy N740 HR
- Beckton Epic K4 N795
- Beckton Tamara N180 JO
- Beckton Epic KM M115
- Beckton Lana K840 LN

DAM		Calv.Ease	BW	WW	YW	Milk	HPG	Stay	Maint.En.
Age	6	11	-4.1	54	90	26	9	15	0.9
Wt	1130	Marb +0.62		REA +0.04		Bfat +0.05			
Prog.BW	69	BWt	WWt	WR	ADG	YWt	YR	Scr.	Fr.
WR	109	71	561	105	3.88	1112	105	36	5.5
YR	106								
Wean Pct.	50%								
Cow Eff.	105								

Accent 180 has risen up from one of our less well known sire lines, to be what I believe is one of our top half dozen herd sires overall in our program. This Accent was a high pick of Mitch's for phenotype. We only got DNA gene profiles on a few of our bulls, in connection with parentage verification. Lot 7 was one of these, and he received a 10 (the highest score) for Tenderness genes on Igenity's DNA profile.

9 **BECKTON NEBULA A212 C3** 
1-A 100% # 1626263 Tat.: BKT3 A212

Birth: 3-19-13

BECKTON NEBULA T269 E2
Ref. N-3

- Beckton Nebula M045
- Beckton Ruth M967 EP

BECKTON TAMARA T111 CQ

- Beckton Cherokee N N479
- Beckton Tamara J229 NP

- Beckton Neptune R2 K065
- Beckton Belga K285 JL
- Beckton Epic KN H110
- Beckton Ruth A905 SG
- BFCK Cherokee Cnyn 4912
- Beckton Dinah C440 NM
- Beckton Neptune RR B284
- Beckton Tamara C931 CL

DAM		Calv.Ease	BW	WW	YW	Milk	HPG	Stay	Maint.En.
Age	6	12	-1.2	58	83	15	10	14	-9.1
Wt	1030	Marb +0.40		REA +0.08		Bfat +0.03			
Prog.BW	67	BWt	WWt	WR	ADG	YWt	YR	Scr.	Fr.
WR	99	85	603	113	3.88	1168	110	36	5.5
YR	97								
Wean Pct.	59%								
Cow Eff.	123								

Another Tamara dam with a son at the front of a sale. Tamara T11 had one of her five calves that got sick and weaned poorly – otherwise her progeny averages would be high. This grandson of Nebula M045 (the ABS bull) was very strong at both weaning and yearling, as well as phenotype at both weaning and yearling. Yet he is one of the lowest Maintenance Energy sire prospects in the breed.



12

BECKTON EPIC A159 H7

1-A 100% # 1626172 Tat.: BKT3 A159

Birth: 3-17-13

BECKTON EPIC X330 L6
Ref. E-3

BECKTON VERNICE N598 HU

Beckton Epic T330 L5
Beckton Kit R503 LN

Beckton Hustler CN J102
Beckton Vernice C047 JL

Beckton Epic K4 N795
Beckton Belga K202 LN

Beckton Lancer F442 T
Beckton Kit F468 JL

Beckton Hustler C G407
Beckton Belga G355 NP

Beckton Julian SJ A470
Beckton Vernice A140 JU

DAM		Calv.Ease	BW	WW	YW	Milk	HPG	Stay	Maint.En.
Age	10	9	-2.2	53	91	18	9	12	-0.5
Wt	1125								
Prog.BW	79								
WR	111			Marb +.43	REA +.24			Bfat +.02	
YR	108								
Wean Pct.	54%								
Cow Eff.	113	BWt	WWt	WR	ADG	YWt	YR	Scr.	Fr.
		75	601	108	3.03	1096	101	36	5.5

Epic A159 has to stand out as just a top all-around sire prospect. Low Maintenance Energy; high Calving Ease; high Yearling Weight; good Marbling and Rib-Eye Area EPD's. An Igenity DNA gene score of 10 for Tenderness genes. And he is out of what could be the highest performing dam in our herd. Vernice (a cow line that goes way back, named after Vernice Chiga) N598 has had nine calves, with no misses, and every calf with a weaning ratio from 104 up to 117.

10

BECKTON NEBULA A203 C4

1-A 100% # 1625799 Tat.: BSF3 A203

Birth: 3-19-13

BECKTON NEBULA T398 V3
Ref. N-4

BECKTON CHRISTY R046 CQ

Beckton Nebula L P093
Beckton Minerva J615 VG

Beckton Cherokee N N479
Beckton Christy N740 HR

Beckton Nebula M045
Beckton Marta M021 LN

Beckton Vegas PK F485
Beckton Minerva F433 VG

BFCK Cherokee Cnyn 4912
Beckton Dinah C440 NM

Beckton Herald FJ J776
Beckton Christy K141 VG

DAM		Calv.Ease	BW	WW	YW	Milk	HPG	Stay	Maint.En.
Age	8	10	-3.4	58	88	21	15	12	-3.2
Wt	1165								
Prog.BW	65								
WR	109			Marb +.52	REA +.31			Bfat +.03	
YR	106								
Wean Pct.	51%								
Cow Eff.	106	BWt	WWt	WR	ADG	YWt	YR	Scr.	Fr.
		73	588	110	3.71	1158	109	39	5.5

Nebulas are proving themselves as top all-around sires throughout the breed, with top herd sire after top herd sire. Here is a low Maintenance Energy, high Calving Ease, and high Yearling Weight sire that typifies our breeding program. His Christy dam has been exceptional, with four calves ratio-ing over 110 at weaning.



11

BECKTON LIKABLE A353 N3

1-A 100% # 1626321 Tat.: BKT3 A353

Birth: 3-25-13

BECKTON LIKABLE U120 L2
Ref. L-3

BECKTON ROSE U122 NB

Beckton Likable S633
Beckton Lana S718 LN

Beckton Nebula PJ S543
Beckton Rose S106 HW

Beckton Lancer F442 T
Beckton Kit F468 JL

Beckton Lancer F442 T
Beckton Lana F891 JL

Beckton Nebula P P707
Beckton Lana P685 JO

Beckton Hawk P248
Beckton Rose P015 LN

DAM		Calv.Ease	BW	WW	YW	Milk	HPG	Stay	Maint.En.
Age	5	8	-1.4	58	89	14	5	14	5.3
Wt	1280								
Prog.BW	78								
WR	104			Marb +.55	REA +.25			Bfat -.01	
YR	112								
Wean Pct.	44%								
Cow Eff.	93	BWt	WWt	WR	ADG	YWt	YR	Scr.	Fr.
		76	566	106	3.76	1129	107	34	5.5

The Lancer line has been known for carcass traits ever since Beckton Lancer F442 went to ABS and established a record of strength for both Marbling and Rib-eye area. Likable A353 follows the same path. As mentioned elsewhere, we DNA profiled a few of our yearling bulls this winter in connection with parentage verification, and A353 also received the top score of 10 on Igenity's Tenderness scale.

13

BECKTON LANCER A127 A5

1-A 100% # 1626312 Tat.: BKT3 A127

Birth: 3-15-13

BECKTON LANCER T371 H4
Ref. L-2

BECKTON MINERVA T864 CK

Beckton Lancer F442 T
Beckton Coca F276 HV

Beckton Colt K M609
Beckton Minerva M179 LN

Beckton Lancer T A664
Bkt Suffeina A828 DM

Leachman Heavenly 8141
Beckton Coca B112 CB

Beckton Colt G552
Beckton Angel H164 LO

Beckton Lancer T3 J396
Beckton Minerva E932 JL

DAM		Calv.Ease	BW	WW	YW	Milk	HPG	Stay	Maint.En.
Age	6	10	-2.0	58	91	14	7	12	2.2
Wt	1130								
Prog.BW	68								
WR	105			Marb +.27	REA +.00			Bfat -.02	
YR	102								
Wean Pct.	55%								
Cow Eff.	116	BWt	WWt	WR	ADG	YWt	YR	Scr.	Fr.
		77	623	117	3.65	1185	112	35	6.0

★★★★★ for Low Maintenance, Growth, Marbling, High Cow Efficiency, Calving Ease.

• Bulls •

14 BECKTON ACCENT A045 N3

1-A 100% # 1626458 Tat.: BKT3 A045

Birth: 3-9-13

Beckton Cody K1 P014
Beckton Susan R022 CQ

Beckton Nebula L P093
Beckton Lana F891 JL

Beckton Cody KH M390
Beckton Rose M126 WR

Beckton Cherokee N N479
Beckton Susan N023 JE

Beckton Nebula M045
Beckton Marta M021 LN

Beckton Clifftop T C075
Beckton Lana 9610 TP



DAM		Calv.Ease	BW	WW	YW	Milk	HPG	Stay	Maint.En.
Age	4	9	-0.2	61	94	20	7	14	2.4
Wt	1105								
Prog.BW	82								
WR	115								
YR	107								
Wean Pct.	58%								
Cow Eff.	123								
		Marb			REA				Bfat
		BWt	WWt	WR	ADG	YWt	YR	Scr.	Fr.
		85	665	119	3.43	1163	108	37	6.0

★★★★★ for Low Maintenance, Growth, Marbling, Superior Cow, High Cow Efficiency, Calving Ease, Stayability.

16 BECKTON CLIFFTOP A180 C4

1-A 100% # 1626399 Tat.: BKT3 A180

Birth: 3-18-13

BKT Clifftop TP R288
Beckton Lydia S274 EP

BKT Clifftop TP R288
Beckton Lydia N047 LM

Beckton Clifftop T C075
Beckton Christy K209 CO

Beckton Epic KM M115
Beckton Lydia M607 LO

Beckton Clifftop T C075
Beckton Christy K209 CO

Beckton Laramie L044
Beckton Lydia L647 JL



DAM		Calv.Ease	BW	WW	YW	Milk	HPG	Stay	Maint.En.
Age	4	10	-1.1	52	90	29	10	17	-1.8
Wt	1110								
Prog.BW	69								
WR	111								
YR	110								
Wean Pct.	56%								
Cow Eff.	118								
		Marb			REA				Bfat
		BWt	WWt	WR	ADG	YWt	YR	Scr.	Fr.
		83	643	115	4.27	1273	118	37	5.5

★★★★★ for Low Maintenance, Growth, Gainability, Marbling, Superior Cow, High Cow Efficiency, Calving Ease, Stayability.

15 BECKTON ACCENT A226 E3

1-A 100% # 1626360 Tat.: BKT3 A226

Birth: 3-20-13

Beckton Cody K1 P014
Beckton Susan R022 CQ

Beckton Epic R350 K
Beckton Suffeina P577 LN

Beckton Cody KH M390
Beckton Rose M126 WR

Beckton Cherokee N N479
Beckton Susan N023 JE

Beckton Epic K F075
Beckton Larkaba E042 CD

Beckton Lancer F442 T
Bkt Suffeina A828 DM



DAM		Calv.Ease	BW	WW	YW	Milk	HPG	Stay	Maint.En.
Age	5	9	-1.5	50	78	23	9	14	-1.1
Wt	1125								
Prog.BW	77								
WR	102								
YR	104								
Wean Pct.	49%								
Cow Eff.	103								
		Marb			REA				Bfat
		BWt	WWt	WR	ADG	YWt	YR	Scr.	Fr.
		80	549	103	3.93	1159	110	36	6.0

★★★★★ for Low Maintenance, Growth, Marbling, Calving Ease, Stayability.

17 BECKTON NEW ERA A466 N2

1-A 100% # 1626314 Tat.: BKT3 A466

Birth: 3-28-13

Beckton Nebula P P707
BKT Larkeisa T310 JC

Beckton Nebula EN S347
Beckton Eola S317 LO

Beckton Nebula M045
Beckton Lana M809 EP

Beckton Justice C1 R483
BKT Larkeisa R775 JC

Beckton Nebula E P084
Beckton Eola P530 NB

Beckton Loki C M740
Beckton Eola J454 JL



DAM		Calv.Ease	BW	WW	YW	Milk	HPG	Stay	Maint.En.
Age	5	15	-3.3	67	105	21	12	16	-5.1
Wt	975								
Prog.BW	65								
WR	117								
YR	111								
Wean Pct.	66%								
Cow Eff.	139								
		Marb			REA				Bfat
		BWt	WWt	WR	ADG	YWt	YR	Scr.	Fr.
		78	645	121	3.60	1174	111	40	6.0

★★★★★ for Low Maintenance, Growth, Marbling, Superior Cow, High Cow Efficiency, Calving Ease, Stayability.



18 BECKTON ACCENT A134 E3

1-A 100% # 1626290 Tat.: BKT3 A134

Birth: 3-16-13

Beckton Cody K1 P014
Beckton Christy R046 CQ

Beckton Epic KM M115
Bkt Bayberry LC31 SC

Beckton Cody KH M390
Beckton Rose M126 WR

Beckton Cherokee N N479
Beckton Christy N740 HR

Beckton Epic K F075
Beckton Minerva F495 CH

Beckton Scamp TR FB22
Bkt Bayberry D736 GL



DAM		Calv.Ease	BW	WW	YW	Milk	HPG	Stay	Maint.En.
Age	6	10	-3.0	57	92	26	11	12	0.8
Wt	1185								
Prog.BW	71								
WR	109								
YR	105								
Wean Pct.	50%								
Cow Eff.	106								
		Marb			REA				Bfat
		BWt	WWt	WR	ADG	YWt	YR	Scr.	Fr.
		76	596	107	3.65	1162	108	39	5.5

★★★★★ for Low Maintenance, Growth, Marbling, Superior Cow, Calving Ease.

• Bulls •



21 **BECKTON EPIC A281 A6** 

1-A 100% # 1625891 Tat.: BSF3 A281

Birth: 3-22-13

BECKTON EPIC U749 D5
Ref. E-2

BECKTON ANGEL U746 CD

DAM

Age	5	Calv.Ease	BW	WW	YW	Milk	HPG	Stay	Maint.En.
Wt	975	10	-2.0	58	104	22	3	14	4.0
Prog.BW	72	Marb +0.55		REA +0.35		Bfat +0.02			
WR	103	BWt	WWt	WR	ADG	YWt	YR	Scr.	Fr.
YR	103	77	586	105	3.93	1151	107	34	5.5
Wean Pct.	60%								
Cow Eff.	127								

Beckton Epic K4 N795
Beckton Epic KJ J722
Beckton Sierra J789 EP
Beckton Dominor ZC M919
Beckton Denise L639 JL
Beckton Cody KH M390
Beckton Rose M126 WR
Beckton Loki F251
Beckton Angel F571 LN

★★★★★ for Low Maintenance, Growth, Marbling, Rib-eye area, High Cow Efficiency, Calving Ease, Stayability.

19 **BECKTON JULIAN A622 N6** 

1-A 100% # 1626266 Tat.: BKT3 A622

Birth: 4-3-13

BECKTON JULIAN W743 H5
Ref. J-3

BECKTON LANA T127 NB

DAM

Age	6	Calv.Ease	BW	WW	YW	Milk	HPG	Stay	Maint.En.
Wt	1040	12	0.3	60	91	18	13	14	-2.1
Prog.BW	73	Marb +0.50		REA -0.08		Bfat +0.03			
WR	110	BWt	WWt	WR	ADG	YWt	YR	Scr.	Fr.
YR	111	89	598	107	3.99	1213	112	35	5.5
Wean Pct.	58%								
Cow Eff.	121								

Beckton Julian G5 S107
Beckton Minola P826 DM
Beckton Herald F FA20
Beckton Kit F468 JL
Beckton Nebula M045
Beckton Lana M621 LN
Beckton Herald F FA20
Beckton Kit F468 JL
Beckton Nebula M045
Beckton Lana M621 LN
Beckton Champ R1 H024
Beckton Lana G730 JL

★★★★★ for Low Maintenance, Growth, Marbling, Superior Cow, High Cow Efficiency, Calving Ease, Stayability.

22 **BECKTON EPIC A508 N6** 

1-A 100% # 1626220 Tat.: BKT3 A508

Birth: 3-30-13

BECKTON EPIC T330 L5
Ref. E-1

BKT LARKEISA S055 NB

DAM

Age	7	Calv.Ease	BW	WW	YW	Milk	HPG	Stay	Maint.En.
Wt	1100	15	-5.5	49	86	20	7	13	-1.0
Prog.BW	61	Marb +0.67		REA -0.05		Bfat +0.06			
WR	103	BWt	WWt	WR	ADG	YWt	YR	Scr.	Fr.
YR	102	71	579	108	4.16	1161	110	38	5.5
Wean Pct.	53%								
Cow Eff.	111								

Beckton Epic K4 N795
Beckton Epic KJ J722
Beckton Sierra J789 EP
Beckton Lancer T A664
Beckton Belga K202 LN
Beckton Belga D460 KR
Beckton Nebula P P707
Beckton Nebula M045
Beckton Lana M809 EP
Beckton Champ R3 H338
Beckton Larkeisa P688 CH
BKT Larkeisa J564 HR

★★★★★ for Low Maintenance, Growth, Gainability, Marbling, Calving Ease, Stayability.

20 **BECKTON JULIAN A152 L6** 

1-A 100% # 1626152 Tat.: BKT3 A152

Birth: 3-17-13

BECKTON JULIAN X465 J5
Ref. J-4

BECKTON ROSE L311 LN

DAM

Age	12	Calv.Ease	BW	WW	YW	Milk	HPG	Stay	Maint.En.
Wt	970	10	-1.0	54	91	17	12	15	-7.0
Prog.BW	76	Marb +0.57		REA +0.06		Bfat +0.02			
WR	105	BWt	WWt	WR	ADG	YWt	YR	Scr.	Fr.
YR	107	81	576	103	3.48	1140	105	41	5.5
Wean Pct.	57%								
Cow Eff.	121								

Beckton Julian G5 S107
Beckton Minola P826 DM
Beckton Julian GG B571
Bkt Suffeina A828 DM
Beckton Lancer T A664
Bkt Suffeina A828 DM
Beckton Hadrian F C486
Beckton Rose A528 PC
Beckton Lancer F442 T
Beckton Suffeina P643 JL
Beckton Rose H292 HD

★★★★★ for Low Maintenance, Growth, Marbling, Superior Cow, High Cow Efficiency, Calving Ease, Stayability.



• Bulls •



25 BECKTON JULIAN A682 D5 

1-A 100% # 1626261 Tat.: BKT3 A682

Birth: 4-7-13

Beckton Julian GJ P535
Beckton Julian 7526G
Beckton Mona D086 JL

BECKTON JULIAN G5 S107
Ref. J-2 Beckton Minola P826 DM
Beckton Dominor ZC M919
Beckton Minola M641 WR

Beckton Dominor Z1 R610
BECKTON EOLA T070 DM
Beckton Eola R708 DM
Beckton Dominor ZC M919
Beckton Sierra K557 LO
Beckton Dominor ZC M919
Beckton Eola M559 LN

DAM		Calv.Ease	BW	WW	YW	Milk	HPG	Stay	Maint.En.
Age	6	8	0.6	58	100	17	13	16	-1.1
Wt	1125								
Prog.BW	82								
WR	101								
YR	110								
Wean Pct.	53%								
Cow Eff.	112								
		Marb	+0.59		REA	-0.06		Bfat	+0.07
		BWt	83	WWt	597	WR	107	ADG	3.99
		YWt	1185	YR	110	Scr.	34	Fr.	5.5

★★★★★ for Low Maintenance, Growth, Marbling, Calving Ease, Stayability.

23 BECKTON JULIAN A649 N6 

1-A 100% # 1625922 Tat.: BSF3 A649

Birth: 4-5-13

Beckton Julian G5 S107
BECKTON JULIAN X465 J5
Ref. J-4 Beckton Suffeina P643 JL

Beckton Julian GJ P535
Beckton Minola P826 DM

Beckton Julian GG B571
Bkt Suffeina A828 DM

Beckton Nebula G S237
BECKTON ANGEL W326 N
Beckton Angel R197 JJ

Beckton Nebula M045
Beckton Lakme LA06 JL
Beckton Juno N493
Beckton Angel N115 HR

DAM		Calv.Ease	BW	WW	YW	Milk	HPG	Stay	Maint.En.
Age	4	12	-3.9	51	85	18	7	16	2.5
Wt	1025								
Prog.BW	65								
WR	115								
YR	110								
Wean Pct.	58%								
Cow Eff.	122								
		Marb	+0.69		REA	-0.08		Bfat	+0.02
		BWt	68	WWt	614	WR	110	ADG	3.76
		YWt	1196	YR	111	Scr.	34	Fr.	6.5

★★★★★ for Low Maintenance, Growth, Marbling, Superior Cow, High Cow Efficiency, Calving Ease, Stayability.

26 BECKTON NEBULA A376 D4 

1-A 100% # 1626211 Tat.: BKT3 A376

Birth: 3-26-13

Beckton Nebula L P093
BECKTON NEBULA W486 D3
Ref. N-5 Beckton Belga R716 DM

Beckton Nebula M045
Beckton Marta M021 LN

Beckton Dominor ZC M919
Beckton Belga K285 JL

Beckton Dominor ZC M919
BKT LARKEISA R676 DM
BKT Larkeisa M816 EP

Beckton Dominor Z E401
Beckton Barmaid J012 CO
Beckton Epic KJ J722
BKT Larkeisa J076 DM

DAM		Calv.Ease	BW	WW	YW	Milk	HPG	Stay	Maint.En.
Age	8	11	-2.8	47	81	23	6	13	-1.8
Wt	1105								
Prog.BW	68								
WR	103								
YR	104								
Wean Pct.	53%								
Cow Eff.	111								
		Marb	+0.58		REA	+0.16		Bfat	+0.02
		BWt	72	WWt	580	WR	104	ADG	3.43
		YWt	1135	YR	105	Scr.	36	Fr.	5.5

★★★★★ for Low Maintenance, Marbling, Rib-eye area, Superior Cow, Calving Ease, Stayability.

24 BECKTON NEBULA A072 N4 

1-A 100% # 1626010 Tat.: BSF3 A072

Birth: 3-12-13

Beckton Nebula L P093
BECKTON NEBULA W486 D3
Ref. N-5 Beckton Belga R716 DM

Beckton Nebula M045
Beckton Marta M021 LN

Beckton Dominor ZC M919
Beckton Belga K285 JL

Beckton Nebula T269 E2
BECKTON BARMAID X231 N
Beckton Barmaid G565 LN

Beckton Nebula M045
Beckton Ruth M967 EP
Beckton Lancer T A664
Bkt Barmaid 9517 RN

DAM		Calv.Ease	BW	WW	YW	Milk	HPG	Stay	Maint.En.
Age	3	13	-4.9	46	78	16	9	16	-5.2
Wt	835								
Prog.BW	62								
WR	115								
YR	106								
Wean Pct.	71%								
Cow Eff.	150								
		Marb	+0.59		REA	+0.12		Bfat	+0.02
		BWt	62	WWt	635	WR	121	ADG	2.92
		YWt	1135	YR	108	Scr.	34	Fr.	6.0

★★★★★ for Low Maintenance, Growth, Marbling, Superior Cow, High Cow Efficiency, Calving Ease, Stayability.

27 BECKTON JULIAN A088 W6 

1-A 100% # 1626171 Tat.: BKT3 A088

Birth: 3-13-13

Beckton Julian G5 S107
BECKTON JULIAN X465 J5
Ref. J-4 Beckton Suffeina P643 JL

Beckton Julian GJ P535
Beckton Minola P826 DM

Beckton Julian GG B571
Bkt Suffeina A828 DM

Beckton Warrior TD L493
BKT PINE MARIE N582 WR
BKT Pine Marie L650 EP

Beckton Warrior T C371
Bkt Suffeina A828 DM
Beckton Epic K F075
BKT Pine Marie H175 NP

DAM		Calv.Ease	BW	WW	YW	Milk	HPG	Stay	Maint.En.
Age	10	8	-1.0	55	91	19	14	16	-1.0
Wt	1100								
Prog.BW	73								
WR	112								
YR	106								
Wean Pct.	57%								
Cow Eff.	121								
		Marb	+0.57		REA	+0.07		Bfat	+0.01
		BWt	76	WWt	631	WR	113	ADG	3.20
		YWt	1088	YR	101	Scr.	36	Fr.	5.5

★★★★★ for Low Maintenance, Marbling, Superior Cow, High Cow Efficiency, Calving Ease, Stayability.

• Bulls •

28 **BECKTON NEBULA A310 E4** 

1-A 100% # 1626271 Tat.: BKT3 A310

Birth: 3-23-13

Beckton Nebula L P093
BECKTON NEBULA T398 V3
 Ref. N-4 Beckton Minerva J615 VG

Beckton Epic KM M115
BECKTON BARMAID T193 EP
 Beckton Barmaid N258 JC

Beckton Nebula M045
 Beckton Marta M021 LN
 Beckton Vegas PK F485
 Beckton Minerva F433 VG
 Beckton Epic K F075
 Beckton Minerva F495 CH
 Beckton Justice C K449
 Beckton Barmaid G565 LN

DAM		Calv.Ease	BW	WW	YW	Milk	HPG	Stay	Maint.En.
Age	6	12	-4.6	51	84	20	13	12	-2.7
Wt	1220	Marb +58		REA -0.1		Bfat +0.1			
Prog.BW	69	BWt	WWt	WR	ADG	YWt	YR	Scr.	Fr.
WR	106	72	538	101	3.99	1107	105	39	5.5
YR	107								
Wean Pct.	44%								
Cow Eff.	93								

★★★★★ for Low Maintenance, Marbling, Superior Cow, Calving Ease.

30 **BECKTON JULIAN A596 L6** 

1-A 100% # 1625794 Tat.: BSF3 A596

Birth: 4-2-13

Beckton Julian G5 S107
BECKTON JULIAN W743 H5
 Ref. J-3 Beckton Kit L399 HR

Beckton Lancer T5 L095
BECKTON LANA P520 LN
 Beckton Lana L827 WR

Beckton Julian GJ P535
 Beckton Minola P826 DM
 Beckton Herald F FA20
 Beckton Kit F468 JL
 Beckton Lancer F442 T
 Beckton Belga J293 HR
 Beckton Warrior T C371
 Beckton Lana F028 VG

DAM		Calv.Ease	BW	WW	YW	Milk	HPG	Stay	Maint.En.
Age	9	9	1.3	55	85	22	12	13	-3.1
Wt	1085	Marb +57		REA +0.2		Bfat +0.1			
Prog.BW	80	BWt	WWt	WR	ADG	YWt	YR	Scr.	Fr.
WR	106	90	604	108	3.43	1163	108	35	6.0
YR	104								
Wean Pct.	56%								
Cow Eff.	117								

★★★★★ for Low Maintenance, Growth, Marbling, Superior Cow, High Cow Efficiency, Calving Ease, Stayability.



31 **BECKTON NEBULA A335 N5** 

1-A 100% # 1625856 Tat.: BSF3 A335

Birth: 3-24-13

Beckton Nebula PJ S543
BECKTON NEBULA U060 N4
 Ref. N Beckton Birdie S110 NB

Beckton Nebula L P093
BECKTON TAMARA U244 NB
 Beckton Tamara R200 HU

Beckton Nebula P P707
 Beckton Lana P685 JO
 Beckton Nebula P P707
 Beckton Birdie P086 WR
 Beckton Nebula M045
 Beckton Marta M021 LN
 Beckton Hustler C2 L079
 Beckton Tamara K783 VG

DAM		Calv.Ease	BW	WW	YW	Milk	HPG	Stay	Maint.En.
Age	5	13	-5.5	58	87	15	7	14	4.6
Wt	1155	Marb +51		REA +14		Bfat +0.2			
Prog.BW	70	BWt	WWt	WR	ADG	YWt	YR	Scr.	Fr.
WR	113	65	637	114	3.03	1118	103	34	5.5
YR	108								
Wean Pct.	55%								
Cow Eff.	116								

★★★★★ for Marbling, Rib-eye area, Superior Cow, High Cow Efficiency, Calving Ease, Stayability.

29 **BECKTON LANCER A429 E5** 

1-A 100% # 1626301 Tat.: BKT3 A429

Birth: 3-27-13

Beckton Lancer F442 T
BECKTON LANCER T371 H4
 Ref. L-2 Beckton Coca F276 HV

Beckton Epic K4 N795
BECKTON SUSAN T685 EP
 Beckton Susan P090 CE

Beckton Lancer T A664
 Bkt Suffeina A828 DM
 Leachman Heavenly 8141
 Beckton Coca B112 CB
 Beckton Epic KJ J722
 Beckton Sierra J789 EP
 Beckton Cruiser K118
 Beckton Susan L258 LR

DAM		Calv.Ease	BW	WW	YW	Milk	HPG	Stay	Maint.En.
Age	6	10	-2.9	62	102	11	3	12	-1.0
Wt	1105	Marb +49		REA -0.1		Bfat +0.1			
Prog.BW	68	BWt	WWt	WR	ADG	YWt	YR	Scr.	Fr.
WR	99	72	648	116	3.37	1184	110	33	6.0
YR	107								
Wean Pct.	59%								
Cow Eff.	124								

★★★★★ for Low Maintenance, Growth, Marbling, High Cow Efficiency, Calving Ease.

32 **BECKTON JULIAN A260 J6** 

1-A 100% # 1625783 Tat.: BSF3 A260

Birth: 3-21-13

Beckton Julian G5 S107
BECKTON JULIAN W743 H5
 Ref. J-3 Beckton Kit L399 HR

Beckton Julian G1 J526
BECKTON MINOLA N751 JL
 Beckton Minola J091 JL

Beckton Julian GJ P535
 Beckton Minola P826 DM
 Beckton Herald F FA20
 Beckton Kit F468 JL
 Beckton Julian GG B571
 Beckton Annie F743 LN
 Beckton Julian GG B571
 Beckton Minola D330 JL

DAM		Calv.Ease	BW	WW	YW	Milk	HPG	Stay	Maint.En.
Age	10	15	-5.4	48	74	18	11	15	-3.0
Wt	1160	Marb +54		REA -0.2		Bfat +0.2			
Prog.BW	63	BWt	WWt	WR	ADG	YWt	YR	Scr.	Fr.
WR	101	66	545	102	3.26	1096	104	34	5.5
YR	101								
Wean Pct.	47%								
Cow Eff.	99								

★★★★★ for Low Maintenance, Marbling, Calving Ease, Stayability.

• Bulls •

33 BECKTON SCAMP A135 N4 
 1-A 100% # 1626156 Tat.: BKT3 A135
 Birth: 3-16-13

Beckton Scamp T A825
BECKTON SCAMP X494 E3
 Ref. S-1 Beckton Lana S074 EP

Beckton Scamp 8954
 Bkt Encino 8459 TJ
 Beckton Epic KH P678
 Beckton Lana P317 JL
 Beckton Neptune RR B284
 Beckton Lana C735 TP
 Beckton Julian GG B571
 Beckton Ruth A905 SG

Beckton Neptune R2 K065
BECKTON RUTH M047 NP
 Beckton Ruth K464 JL

DAM		Calv.Ease	BW	WW	YW	Milk	HPG	Stay	Maint.En.
Age	11	11	-0.8	57	85	22	11	12	-10.2
Wt	970								
Prog.BW	80								
WR	109		Marb	+52	REA	-06	Bfat	+01	
YR	105								
Wean Pct.	60%	BWt	WWt	WR	ADG	YWt	YR	Scr.	Fr.
Cow Eff.	127	85	604	108	3.26	1078	100	33	5.5

★★★★★ for Low Maintenance, Marbling, Superior Cow, High Cow Efficiency, Calving Ease.



35 BECKTON EPIC A118 N7 
 1-A 100% # 1626295 Tat.: BKT3 A118
 Birth: 3-15-13

Beckton Epic T330 L5
BECKTON EPIC X330 L6
 Ref. E-3 Beckton Kit R503 LN

Beckton Epic K4 N795
 Beckton Belga K202 LN
 Beckton Lancer F442 T
 Beckton Kit F468 JL
 Beckton Nebula M045
 Beckton Coca H132 HD
 Beckton Cherokee N N479
 Beckton Christy N740 HR

Beckton Nebula H R233
BECKTON CHRISTY T592 NB
 Beckton Christy R046 CQ

DAM		Calv.Ease	BW	WW	YW	Milk	HPG	Stay	Maint.En.
Age	6	10	-3.5	55	90	16	13	15	-0.2
Wt	1180								
Prog.BW	67								
WR	105		Marb	+71	REA	+25	Bfat	+04	
YR	106								
Wean Pct.	47%	BWt	WWt	WR	ADG	YWt	YR	Scr.	Fr.
Cow Eff.	98	72	548	103	3.65	1113	105	35	5.5

★★★★★ for Low Maintenance, Growth, Marbling, Rib-eye area, Superior Cow, Calving Ease, Stayability.

36 BECKTON ACCENT A398 V3 
 1-A 100% # 1625884 Tat.: BSF3 A398
 Birth: 3-26-13

Beckton Cody K1 P014
BECKTON ACCENT W180 C2
 Ref. A-2 Beckton Christy R046 CQ

Beckton Cody KH M390
 Beckton Rose M126 WR
 Beckton Cherokee N N479
 Beckton Christy N740 HR
 Beckton Vegas S1 K316
 Beckton Lydia H159 JL
 Beckton Hustler C2 L079
 Beckton Lana H544 WR

Beckton Vega P079
BECKTON LANA U640 VA
 Beckton Lana R810 HU

DAM		Calv.Ease	BW	WW	YW	Milk	HPG	Stay	Maint.En.
Age	5	10	-0.7	64	101	20	8	13	2.9
Wt	1160								
Prog.BW	80								
WR	109		Marb	+58	REA	+24	Bfat	+03	
YR	109								
Wean Pct.	51%	BWt	WWt	WR	ADG	YWt	YR	Scr.	Fr.
Cow Eff.	108	84	593	111	3.15	1142	108	35	5.5

★★★★★ for Low Maintenance, Growth, Marbling, Rib-eye area, Superior Cow, Calving Ease, Stayability.

34 BECKTON JULIAN A483 N6 
 1-A 100% # 1625919 Tat.: BSF3 A483
 Birth: 3-29-13

Beckton Julian G5 S107
BECKTON JULIAN W743 H5
 Ref. J-3 Beckton Kit L399 HR

Beckton Julian GJ P535
 Beckton Minola P826 DM
 Beckton Herald F FA20
 Beckton Kit F468 JL
 Beckton Nebula M045
 Beckton Marta M021 LN
 Beckton Loki C M740
 Beckton Encino N076 PG

Beckton Nebula L P093
BECKTON ENCINO W287 N
 Beckton Encino S303 LO

DAM		Calv.Ease	BW	WW	YW	Milk	HPG	Stay	Maint.En.
Age	4	11	-2.9	59	97	15	9	14	4.5
Wt	1085								
Prog.BW	76								
WR	116		Marb	+54	REA	-10	Bfat	+03	
YR	108								
Wean Pct.	55%	BWt	WWt	WR	ADG	YWt	YR	Scr.	Fr.
Cow Eff.	116	70	615	115	3.09	1117	106	37	6.0

★★★★★ for Growth, Marbling, Superior Cow, Calving Ease, Stayability.



• Bulls •

37 BECKTON LEGEND A254 E2

1-B 99% # 1625834 Tat.: BSF3 A254

Birth: 3-21-13

Beckton Lancer F442 T
Beckton Legend S670 Ref. L-1
Beckton Kit F468 JL

Beckton Exeter R090
BSF HUSTELLE T546 EX
BSF Hustelle R505 HU

Beckton Lancer T A664
Bkt Suffeina A828 DM
Beckton Julian GG B571
Beckton Kit A517 NP
Beckton Epic K4 N795
Beckton Lana N310 EP
Beckton Hustler CN J102
BSF Regus L330 VG

DAM		Calv.Ease	BW	WW	YW	Milk	HPG	Stay	Maint.En.
Age	6	14	-4.2	51	93	19	5	10	1.8
Wt	1040	Marb +.59		REA -.03		Bfat +.04			
Prog.BW	67								
WR	107								
YR	108								
Wean Pct.	60%	BWt	WWt	WR	ADG	YWt	YR	Scr.	Fr.
Cow Eff.	126	77	624	112	3.99	1165	108	36	5.5

★★★★★ for Low Maintenance, Growth, Marbling, Superior Cow, High Cow Efficiency, Calving Ease.

40 BSF EPIC A373 C6

99% # Tat.: BSF3 A373

Birth: 3-25-13

Beckton Epic K4 N795
Beckton Epic U749 D5 Ref. E-2
Beckton Denise R308 DM

Beckton Clifftop T3 N800
BSF CLIFFTANA S379 CT
BSF Regus K090 CH

Beckton Epic KJ J722
Beckton Sierra J789 EP
Beckton Dominor ZC M919
Beckton Denise L639 JL
Bkt Clifftop TV G672
Beckton Lana J384 CD
Beckton Champ R1 H024
BSF Regus H402

DAM		Calv.Ease	BW	WW	YW	Milk	HPG	Stay	Maint.En.
Age	7	13.5	-5.0	37.5	72.5	17	6.5	12.5	7.0
Wt	1115	Marb +.42		REA +.35		Bfat +.02			
Prog.BW	65								
WR	102								
YR	101								
Wean Pct.	51%	BWt	WWt	WR	ADG	YWt	YR	Scr.	Fr.
Cow Eff.	108	64	574	103	3.71	1168	108	35	5.5

★★★★★ for Growth, Marbling, Rib-eye area, Calving Ease.

38 BSF NEBULA A550 J3

99% # Tat.: BSF3 A550

Birth: 4-1-13

Beckton Nebula M045
Beckton Nebula T269 E2 Ref. N-3
Beckton Ruth M967 EP

Beckton Juniper P381
BSF NEPTALA S006 JP
BSF Neptala P236

Beckton Neptune R2 K065
Beckton Belga K285 JL
Beckton Epic KN H110
Beckton Ruth A905 SG
Beckton Julian G2 M345
Beckton Encino M723 JL
Beckton Neptune R2 K065
BSF Regus K693 CT

DAM		Calv.Ease	BW	WW	YW	Milk	HPG	Stay	Maint.En.
Age	7	13	-3.0	44	77.5	15.5	12.5	13.5	-4.5
Wt	1155	Marb +.32		REA +.11		Bfat +.03			
Prog.BW	74								
WR	108								
YR	109								
Wean Pct.	51%	BWt	WWt	WR	ADG	YWt	YR	Scr.	Fr.
Cow Eff.	107	83	586	105	4.16	1196	111	35	6.0

★★★★★ for Low Maintenance, Growth, Gainability, Marbling, Superior Cow, Calving Ease, Stayability.

41 BSF NEBULA A274 C4

1-B 99% # 1625893 Tat.: BSF3 A274

Birth: 3-22-13

Beckton Nebula L P093
Beckton Nebula W486 D3 Ref. N-5
Beckton Belga R716 DM

Beckton Cherokee N N479
BSF CHERISE U771 CQ
BSF Regus L683 CT

Beckton Nebula M045
Beckton Marta M021 LN
Beckton Dominor ZC M919
Beckton Belga K285 JL
BFCK Cherokee Cnyn 4912
Beckton Dinah C440 NM
Beckton Clifftop T C075
BSF Regus F712

DAM		Calv.Ease	BW	WW	YW	Milk	HPG	Stay	Maint.En.
Age	5	9	-1.2	56	89	16	11	16	-0.2
Wt	1075	Marb +.42		REA +.18		Bfat +.02			
Prog.BW	70								
WR	103								
YR	104								
Wean Pct.	55%	BWt	WWt	WR	ADG	YWt	YR	Scr.	Fr.
Cow Eff.	116	82	592	106	3.71	1139	105	35	5.5

★★★★★ for Low Maintenance, Growth, Marbling, Rib-eye area, High Cow Efficiency, Calving Ease, Stayability.

39 BSF ACCENT A132 J3

99% # Tat.: BSF3 A132

Birth: 3-16-13

Beckton Cody K1 P014
Beckton Accent W180 C2 Ref. A-2
Beckton Christy R046 CQ

Beckton Justice C1 R483
BSF NEBULANN T658 JC
BSF Nebulann R163 NB

Beckton Cody KH M390
Beckton Rose M126 WR
Beckton Cherokee N N479
Beckton Christy N740 HR
Beckton Justice CH M056
Beckton Tamara J124 HR
Beckton Nebula M045
BSF Regus F175

DAM		Calv.Ease	BW	WW	YW	Milk	HPG	Stay	Maint.En.
Age	6	13.5	-4.4	44.5	80	23	12	14	-1.3
Wt	1070	Marb +.30		REA +.26		Bfat +.05			
Prog.BW	62								
WR	106								
YR	101								
Wean Pct.	58%	BWt	WWt	WR	ADG	YWt	YR	Scr.	Fr.
Cow Eff.	121	63	615	110	4.05	1197	111	37	6.0

★★★★★ for Low Maintenance, Growth, Gainability, Marbling, Rib-eye area, High Cow Efficiency, Calving Ease, Stayability.

42 BSF JULIAN A717 J6

99% # Tat.: BSF3 A717

Birth: 4-10-13

Beckton Julian G5 S107
Beckton Julian X465 J5 Ref. J-4
Beckton Suffeina P643 JL

Beckton Julio L233
BSF JULIA T623 JO
BSF Regus M006 NP

Beckton Julian GJ P535
Beckton Minola P826 DM
Beckton Julian GG B571
Bkt Suffeina A828 DM
Beckton Julian G1 J526
Beckton Rose J725 EP
Beckton Neptune R2 K065
BSF Regus K326 WH

DAM		Calv.Ease	BW	WW	YW	Milk	HPG	Stay	Maint.En.
Age	6	11.5	-2.3	42	78.5	18.5	11.5	18	-0.6
Wt	1035	Marb +.39		REA -.02		Bfat +.03			
Prog.BW	72								
WR	111								
YR	111								
Wean Pct.	60%	BWt	WWt	WR	ADG	YWt	YR	Scr.	Fr.
Cow Eff.	125	94	616	111	3.65	1244	115	38	6.5

★★★★★ for Low Maintenance, Growth, Marbling, Superior Cow, High Cow Efficiency, Calving Ease, Stayability.

• Bulls •

43 **BSF ORION A380 W2** 

1-B 99% # 1625882 Tat.: BSF3 A380

Birth: 3-26-13

BECKTON JANUS X799 L2
Ref. O-1

BSF LAUREL U629 WR

Beckton Roman J S158
Beckton Sierra K557 LO
Beckton Warrior N645 T1
BSF Laurel R107 JJ

TR Romeo NT379
Beckton Belga K285 JL
Beckton Loki F251
Beckton Sierra C157 CL
Beckton Warrior T1 H281
Beckton Rose H074 EP
Beckton Juno N493
BSF Laurel N239 LN

DAM		Calv.Ease	BW	WW	YW	Milk	HPG	Stay	Maint.En.
Age	5	11	-2.7	67	107	18	8	12	3.4
Wt	1090								
Prog.BW	66								
WR	110			Marb +.43	REA +.09			Bfat +.00	
YR	109								
Wean Pct.	58%								
Cow Eff.	123								
		BWt	WWt	WR	ADG	YWt	YR	Scr.	Fr.
		76	635	114	3.71	1181	109	35	6.0

★★★★★ for Low Maintenance, Growth, Marbling, Superior Cow, High Cow Efficiency, Calving Ease.

45 **BSF NEBULA A465 W3** 

1-B 99% # 1625878 Tat.: BSF3 A465

Birth: 3-28-13

BECKTON NEBULA T269 E2
Ref. N-3

BSF WENDIE U579 WR

Beckton Nebula M045
Beckton Ruth M967 EP
Beckton Warrior N645 T1
BSF Regus L009 JL

Beckton Neptune R2 K065
Beckton Belga K285 JL
Beckton Epic KN H110
Beckton Ruth A905 SG
Beckton Warrior T1 H281
Beckton Rose H074 EP
Beckton Julian G1 J526
BSF Regus J082

DAM		Calv.Ease	BW	WW	YW	Milk	HPG	Stay	Maint.En.
Age	5	11	-1.2	61	93	17	10	14	-1.4
Wt	1160								
Prog.BW	78								
WR	112			Marb +.45	REA -.01			Bfat +.02	
YR	111								
Wean Pct.	50%								
Cow Eff.	105								
		BWt	WWt	WR	ADG	YWt	YR	Scr.	Fr.
		87	578	104	3.99	1178	109	36	5.5

★★★★★ for Low Maintenance, Growth, Marbling, Superior Cow, Calving Ease, Stayability.



46 **BSF MAXIMUS A089 C** 

99% # Tat.: BSF3 A089

Birth: 3-14-13

BECKTON RED ANGUS SIRE
Ref.

BSF HELENA R016 CQ

Beckton Red Angus Sire
Beckton Red Angus Dam
Beckton Red Angus Sire
Beckton Red Angus Dam
Beckton Cherokee N N479
BSF Helena N186 HR

Beckton Red Angus Sire
Beckton Red Angus Dam
Beckton Red Angus Sire
Beckton Red Angus Dam
BFCK Cherokee Cnyn 4912
Beckton Dinah C440 NM
Beckton Herald FJ J776
BSF Regus C791

DAM		Calv.Ease	BW	WW	YW	Milk	HPG	Stay	Maint.En.
Age	8	6.5	-1.7	13.5	23	10	8.5	7.5	0.4
Wt	1185								
Prog.BW	63								
WR	101			Marb +.03	REA +.10			Bfat +.02	
YR	101								
Wean Pct.	48%								
Cow Eff.	101								
		BWt	WWt	WR	ADG	YWt	YR	Scr.	Fr.
		60	566	102	3.82	1102	102	36	5.5

★★★★★ for Low Maintenance, Calving Ease.

44 **BSF LIKABLE A004 N4** 

99% # Tat.: BSF3 A004

Birth: 2-27-13

BECKTON LIKABLE Y362 L3
Ref. L-6

BSF ERICA Y171 N

Beckton Likable U130 L2
Beckton Tamara M515 LN
Beckton Nebula EN S347
BSF Erica R006 EP

Beckton Likable S633
Beckton Kit S478 LN
Beckton Lancer TA K644
Beckton Tamara K322 LN
Beckton Nebula E P084
Beckton Eola P530 NB
Beckton Epic K4 N795
BSF Erica N231 EP

DAM		Calv.Ease	BW	WW	YW	Milk	HPG	Stay	Maint.En.
Age	2	12	-3.9	41.8	73.8	15.5	7	16	-1.8
Wt	910								
Prog.BW	67								
WR	118			Marb +.64	REA +.12			Bfat +.06	
YR	117								
Wean Pct.	59%								
Cow Eff.	125								
		BWt	WWt	WR	ADG	YWt	YR	Scr.	Fr.
		67	601	118	4.05	1198	117	32	5.5

★★★★★ for Low Maintenance, Growth, Gainability, Marbling, Superior Cow, High Cow Efficiency, Calving Ease, Stayability.



• Bulls •

47 BSF NEBULA A905 E4

1-B 99% # 1625913 Tat.: BSF3 A905

Birth: 5-6-13

Beckton Nebula L P093
BECKTON NEBULA T398 V3
 Ref. N-4

Beckton Nebula M045
 Beckton Marta M021 LN
 Beckton Vegas PK F485
 Beckton Minerva F433 VG

Beckton Epic K4 N795
BSF EPIQUETTE W206 E
 BSF Regus K155 CH

Beckton Epic KJ J722
 Beckton Sierra J789 EP
 Beckton Champ R2 H293
 BSF Red Roan H766

DAM		Calv.Ease	BW	WW	YW	Milk	HPG	Stay	Maint.En.
Age	4	8	0.1	66	108	17	7	11	-0.9
Wt	1260	Marb +0.53		REA +0.05		Bfat +0.03			
Prog.BW	84	BWt	WWt	WR	ADG	YWt	YR	Scr.	Fr.
WR	118	84	628	118	4.05	1225	116	35	7.0
YR	116								
Wean Pct.	48%								
Cow Eff.	102								

★★★★★ for Low Maintenance, Growth, Gainability, Marbling, Superior Cow, Calving Ease.

50 BECKTON DOMINOR A113 J6

1-A 100% # 1626253 Tat.: BKT3 A113

Birth: 3-15-13

Beckton Dominor Z1 R610
BECKTON DOMINOR W640 C5
 Ref. D-1

Beckton Dominor ZC M919
 Beckton Sierra K557 LO
 Beckton Cherokee N N479
 Beckton Mona N342 HU

Beckton Justice C1 R483
BECKTON FIREFLY T003 JC
 Beckton Firefly R064 NW

Beckton Justice CH M056
 Beckton Tamara J124 HR
 Beckton Newark Cn N567
 Beckton Firefly N655 NP

DAM		Calv.Ease	BW	WW	YW	Milk	HPG	Stay	Maint.En.
Age	6	14	-7.2	41	69	19	11	15	-7.8
Wt	905	Marb +0.73		REA +0.05		Bfat +0.08			
Prog.BW	58	BWt	WWt	WR	ADG	YWt	YR	Scr.	Fr.
WR	98	63	557	100	3.93	1134	105	38	5.0
YR	102								
Wean Pct.	62%								
Cow Eff.	130								

★★★★★ for Low Maintenance, Marbling, High Cow Efficiency, Calving Ease, Stayability.

48 BSF ACCENT A205 W3

99% # Tat.: BSF3 A205

Birth: 3-19-13

Beckton Cody K1 P014
BECKTON ACCENT W180 C2
 Ref. A-2

Beckton Cody KH M390
 Beckton Rose M126 WR
 Beckton Cherokee N N479
 Beckton Christy N740 HR

Beckton Warrior N645 T1
BSF HUSTELLE T145 WR
 BSF Hustelle R666 HU

Beckton Warrior T1 H281
 Beckton Rose H074 EP
 Beckton Hustler CN J102
 BSF Regus L114 HR

DAM		Calv.Ease	BW	WW	YW	Milk	HPG	Stay	Maint.En.
Age	6	10	-2.6	54	93	18.5	15.5	13	3.4
Wt	1055	Marb +0.23		REA +0.28		Bfat +0.03			
Prog.BW	77	BWt	WWt	WR	ADG	YWt	YR	Scr.	Fr.
WR	108	68	595	107	4.05	1133	105	33	5.5
YR	107								
Wean Pct.	56%								
Cow Eff.	119								

★★★★★ for Low Maintenance, Gainability, Marbling, Rib-eye area, Superior Cow, High Cow Efficiency, Calving Ease, Stayability.



49 BECKTON NEBULA A464 J5

1-A 100% # 1626257 Tat.: BKT3 A464

Birth: 3-28-13

Beckton Nebula PJ S543
BECKTON NEBULA W778 J4
 Ref. N-6

Beckton Nebula P P707
 Beckton Lana P685 JO
 Beckton Jet L P491
 Beckton Lana P828 LN

Beckton Jupiter R478
BECKTON FIREFLY T028 JR
 Beckton Firefly R151 LS

Beckton Julian G1 J526
 Beckton Serena L042 CR
 Beckton Laser N602
 Beckton Firefly N562 VG

DAM		Calv.Ease	BW	WW	YW	Milk	HPG	Stay	Maint.En.
Age	6	14	-3.8	57	86	19	9	14	1.4
Wt	1005	Marb +0.55		REA +0.00		Bfat +0.01			
Prog.BW	72	BWt	WWt	WR	ADG	YWt	YR	Scr.	Fr.
WR	118	78	627	113	3.99	1158	107	36	5.0
YR	113								
Wean Pct.	62%								
Cow Eff.	131								

★★★★★ for Low Maintenance, Growth, Marbling, Superior Cow, High Cow Efficiency, Calving Ease, Stayability.

51 BECKTON LEGEND A762 J3

1-A 100% # 1626358 Tat.: BKT3 A762

Birth: 4-12-13

Beckton Legend S670
BECKTON LEGEND U331 E2
 Ref. L-4

Beckton Legend F442 T
 Beckton Kit F468 JL
 Beckton Epic K4 N795
 Beckton Lana M597 LO

Beckton Jet L P491
BECKTON MONA U564 JT
 Beckton Mona P874 WR

TR Julian LT151
 Beckton Minerva L278 LN
 Beckton Warrior T1 H281
 Beckton Mona L724 CO

DAM		Calv.Ease	BW	WW	YW	Milk	HPG	Stay	Maint.En.
Age	5	14	-5.0	45	78	18	7	13	-1.5
Wt	995	Marb +0.90		REA +0.08		Bfat +0.04			
Prog.BW	68	BWt	WWt	WR	ADG	YWt	YR	Scr.	Fr.
WR	109	72	611	110	4.05	1169	108	37	5.5
YR	108								
Wean Pct.	61%								
Cow Eff.	129								

★★★★★ for Low Maintenance, Growth, Gainability, Marbling, Superior Cow, High Cow Efficiency, Calving Ease, Stayability.

• Bulls •

52 BECKTON ACCENT A243 N3 1-A 100% # 1626276 Tat.: BKT3 A243



Birth: 3-21-13

BECKTON ACCENT W180 C2
Ref. A-2

BECKTON MINOLA T233 NB
Beckton Minola M641 WR

Beckton Cody KH M390
Beckton Rose M126 WR
Beckton Cherokee N N479
Beckton Christy N740 HR
Beckton Nebula M045
BKT Pine Marie M119 EP
Beckton Warrior T C371
Beckton Minola H170 JL

DAM		Calv.Ease	BW	WW	YW	Milk	HPG	Stay	Maint.En.
Age	6	13	-4.6	58	95	18	8	14	-1.0
Wt	1125	Marb +.56		REA +.16		Bfat +.05			
Prog.BW	75	BWt	WWt	WR	ADG	YWt	YR	Scr.	Fr.
WR	89	71	559	100	3.93	1155	107	35	5.0
YR	100								
Wean Pct.	50%								
Cow Eff.	105								

★★★★★ for Low Maintenance, Growth, Marbling, Rib-eye area, Calving Ease, Stayability.

55 BECKTON NEBULA A115 J3 1-A 100% # 1625775 Tat.: BSF3 A115



Birth: 3-15-13

BECKTON NEBULA T269 E2
Ref. N-3

BECKTON LANA N163 JL
Beckton Lana K052 VG

Beckton Neptune R2 K065
Beckton Belga K285 JL
Beckton Epic KN H110
Beckton Ruth A905 SG
Beckton Julian 6592
Bkt Belga 6746 GS
Beckton Vegas SV H078
Beckton Lana H725 CH

DAM		Calv.Ease	BW	WW	YW	Milk	HPG	Stay	Maint.En.
Age	10	10	-2.0	54	82	17	14	13	-5.9
Wt	1240	Marb +.36		REA +.31		Bfat +.02			
Prog.BW	73	BWt	WWt	WR	ADG	YWt	YR	Scr.	Fr.
WR	106	76	552	103	3.54	1067	101	34	5.5
YR	104								
Wean Pct.	45%								
Cow Eff.	94								

★★★★★ for Low Maintenance, Marbling, Rib-eye area, Superior Cow, Calving Ease, Stayability.

53 BECKTON ACCENT A292 J3 1-A 100% # 1626281 Tat.: BKT3 A292



Birth: 3-23-13

BECKTON ACCENT W180 C2
Ref. A-2

BECKTON CHRISTY T410 JO
Beckton Christy K101 CD

Beckton Cody KH M390
Beckton Rose M126 WR
Beckton Cherokee N N479
Beckton Christy N740 HR
Beckton Julian G1 J526
Beckton Rose J725 EP
Beckton Cody V E023
Beckton Christy C306 JL

DAM		Calv.Ease	BW	WW	YW	Milk	HPG	Stay	Maint.En.
Age	6	12	-3.4	53	83	23	10	13	-4.6
Wt	1065	Marb +.59		REA +.18		Bfat +.05			
Prog.BW	70	BWt	WWt	WR	ADG	YWt	YR	Scr.	Fr.
WR	107	76	581	109	3.54	1101	104	36	5.5
YR	103								
Wean Pct.	55%								
Cow Eff.	115								

★★★★★ for Low Maintenance, Marbling, Rib-eye area, Superior Cow, Calving Ease, Stayability.

56 BECKTON WARRIOR A075 W6 1-A 100% # 1626570 Tat.: BKT3 A075



Birth: 3-12-13

BECKTON WARRIOR Y108 E5
Ref. W-3

BECKTON LANA Y032 W
Beckton Lana W031 E

Beckton Warrior C1 S337
BKT Larkeisa S055 NB
Beckton Epic T330 L5
Beckton Susan T048 NB
Beckton Warrior C1 S337
BKT Larkeisa S055 NB
Beckton Emperor T641 E2
Beckton Lana T200 EM

DAM		Calv.Ease	BW	WW	YW	Milk	HPG	Stay	Maint.En.
Age	2	14	-4.3	57	93	17	11	15.5	-2.8
Wt	735	Marb +.66		REA +.06		Bfat +.06			
Prog.BW	60	BWt	WWt	WR	ADG	YWt	YR	Scr.	Fr.
WR	114	60	580	114	3.88	1131	111	34	6.0
YR	111								
Wean Pct.	71%								
Cow Eff.	149								

★★★★★ for Low Maintenance, Growth, Marbling, Superior Cow, High Cow Efficiency, Calving Ease, Stayability.

54 BECKTON LANCER A233 E5 1-A 100% # 1626513 Tat.: BKT3 A233



Birth: 3-20-13

BECKTON LANCER T371 H4
Ref. L-2

BECKTON DENISE X301 E
Beckton Denise S312 LA

Beckton Lancer T A664
Bkt Suffeina A828 DM
Leachman Heavenly 8141
Beckton Coca B112 CB
Beckton Emperor R100
Beckton Vernice R416 EP
Beckton Lariat P229
Beckton Denise P830 JL

DAM		Calv.Ease	BW	WW	YW	Milk	HPG	Stay	Maint.En.
Age	3	13	-5.4	40	63	14	7	13	-6.3
Wt	925	Marb +.81		REA +.30		Bfat +.03			
Prog.BW	55	BWt	WWt	WR	ADG	YWt	YR	Scr.	Fr.
WR	108	59	591	113	3.54	1148	110	34	5.5
YR	107								
Wean Pct.	60%								
Cow Eff.	126								

★★★★★ for Low Maintenance, Growth, Marbling, Rib-eye area, Superior Cow, High Cow Efficiency, Calving Ease, Stayability.

57 BECKTON LANCER A253 N5 1-A 100% # 1625965 Tat.: BSF3 A253



Birth: 3-21-13

BECKTON LANCER T371 H4
Ref. L-2

BECKTON FREYJA W806 N
Beckton Freyja M659 WR

Beckton Lancer T A664
Bkt Suffeina A828 DM
Leachman Heavenly 8141
Beckton Coca B112 CB
Beckton Nebula M045
Beckton Lakme LA06 JL
Beckton Warrior T C371
Beckton Freyja B572 JL

DAM		Calv.Ease	BW	WW	YW	Milk	HPG	Stay	Maint.En.
Age	4	10	-4.4	50	76	9	10	14	-8.5
Wt	1185	Marb +.70		REA +.16		Bfat +.01			
Prog.BW	61	BWt	WWt	WR	ADG	YWt	YR	Scr.	Fr.
WR	100	63	581	109	3.37	1145	108	34	5.0
YR	100								
Wean Pct.	47%								
Cow Eff.	100								

★★★★★ for Low Maintenance, Growth, Marbling, Rib-eye area, Calving Ease, Stayability.

• Bulls •



60 **BECKTON EPIC A588 L6** 

1-A 100% # 1626404 Tat.: BKT3 A588

Birth: 4-2-13

BECKTON EPIC U749 D5
Ref. E-2

- Beckton Epic K4 N795
- Beckton Epic KJ J722
- Beckton Sierra J789 EP
- Beckton Dominor ZC M919
- Beckton Denise L639 JL
- Beckton Loki CL S284
- Beckton Loki C M740
- Beckton Lakme J460 LT
- Beckton Ruth W246 L
- Beckton Ruth P591 LN
- Beckton Lancer T5 L095
- Beckton Ruth E549 TP

DAM		Calv.Ease	BW	WW	YW	Milk	HPG	Stay	Maint.En.
Age	4	10	-2.0	59	102	17	5	15	2.6
Wt	1045								
Prog.BW	59								
WR	95								
YR	99								
Wean Pct.	54%								
Cow Eff.	113								
		Marb	+0.48		REA	+0.24		Bfat	+0.02
		BWt	77	WWt	581	WR	104	ADG	3.26
		YWt	1075	YR	99	Scr.	34	Fr.	6.0

★★★★★ for Low Maintenance, Marbling, Rib-eye area, Calving Ease, Stayability.

58 **BECKTON JULIAN A727 J6** 

1-A 100% # 1626355 Tat.: BKT3 A727

Birth: 4-10-13

BECKTON JULIAN W743 H5
Ref. J-3

- Beckton Julian G5 S107
- Beckton Julian GJ P535
- Beckton Minola P826 DM
- Beckton Herald F FA20
- Beckton Kit L399 HR
- Beckton Kit F468 JL
- Beckton Jet L P491
- TR Julian LT151
- Beckton Minerva L278 LN
- Beckton Lancer T5 L095
- Beckton Ruth P591 LN
- Beckton Ruth E549 TP

DAM		Calv.Ease	BW	WW	YW	Milk	HPG	Stay	Maint.En.
Age	5	11	-0.8	52	83	23	12	15	-6.4
Wt	1030								
Prog.BW	73								
WR	109								
YR	107								
Wean Pct.	57%								
Cow Eff.	120								
		Marb	+0.62		REA	-0.07		Bfat	+0.02
		BWt	82	WWt	587	WR	110	ADG	3.43
		YWt	1138	YR	108	Scr.	35	Fr.	5.5

★★★★★ for Low Maintenance, Growth, Marbling, Superior Cow, High Cow Efficiency, Calving Ease, Stayability.

61 **BSF CLIFFTOP A053 A5** 

99% # Tat.: BSF3 A053

Birth: 3-9-13

BECKTON CLIFFTOP Y012 C4
Ref. C-2

- Beckton Clifftop W692 E3
- BKT Clifftop TP R288
- Beckton Lydia S274 EP
- BKT Clifftop TP R288
- Beckton Lana W240 C
- Beckton Lana L923 CD
- Beckton Accent U777 C2
- Beckton Cody K1 P014
- Beckton Susan R022 CQ
- BSF Accatia Y162 A
- BSF Regus M604 LN
- Beckton Lancer TL G626
- BSF Regus J378

DAM		Calv.Ease	BW	WW	YW	Milk	HPG	Stay	Maint.En.
Age	2	10.5	-2.9	42	75.5	21.5	10.3	15.8	0.3
Wt	775								
Prog.BW	75								
WR	111								
YR	110								
Wean Pct.	65%								
Cow Eff.	137								
		Marb	+0.18		REA	+0.28		Bfat	+0.03
		BWt	75	WWt	563	WR	111	ADG	3.82
		YWt	1124	YR	110	Scr.	32	Fr.	6.0

★★★★★ for Low Maintenance, Growth, Marbling, Rib-eye area, Superior Cow, High Cow Efficiency, Calving Ease, Stayability.

59 **BECKTON ORION A792 N2** 

1-A 100% # 1625838 Tat.: BSF3 A792

Birth: 4-16-13

BECKTON JANUS X799 L2
Ref. O-1

- Beckton Roman J S158
- TR Romeo NT379
- Beckton Belga K285 JL
- Beckton Loki F251
- Beckton Sierra C157 CL
- Beckton Nebula EN S347
- Beckton Nebula E P084
- Beckton Eola P530 NB
- Beckton Indigo U038 NB
- Beckton Indigo S538 LO
- Beckton Loki C M740
- Beckton Indigo M585 LN

DAM		Calv.Ease	BW	WW	YW	Milk	HPG	Stay	Maint.En.
Age	5	14	-2.4	58	91	24	7	14	2.3
Wt	985								
Prog.BW	67								
WR	113								
YR	104								
Wean Pct.	64%								
Cow Eff.	135								
		Marb	+0.56		REA	-0.03		Bfat	+0.02
		BWt	81	WWt	630	WR	113	ADG	3.43
		YWt	1135	YR	105	Scr.	37	Fr.	6.0

★★★★★ for Low Maintenance, Growth, Marbling, Superior Cow, High Cow Efficiency, Calving Ease, Stayability.

62 **BSF HERITAGE A533 C3** 

1-B 99% # 1625877 Tat.: BSF3 A533

Birth: 3-31-13

BECKTON HERITAGE X356 E2
Ref. H-1

- Beckton Heritage N013
- Beckton Hustler C2 L079
- Beckton Lana L007 JL
- Beckton Epic K4 N795
- Beckton Lana E136 TP
- Beckton Clifftop T3 N800
- Bkt Clifftop TV G672
- Beckton Lana J384 CD
- BSF Laurel U563 CT
- BSF Laurel N239 LN
- Beckton Lancer T4 J536
- BSF Regus F071

DAM		Calv.Ease	BW	WW	YW	Milk	HPG	Stay	Maint.En.
Age	5	10	-5.0	49	82	17	4	12	-5.0
Wt	915								
Prog.BW	61								
WR	101								
YR	100								
Wean Pct.	64%								
Cow Eff.	135								
		Marb	+0.84		REA	-0.04		Bfat	+0.04
		BWt	69	WWt	586	WR	105	ADG	3.99
		YWt	1139	YR	105	Scr.	36	Fr.	6.0

★★★★★ for Low Maintenance, Growth, Marbling, High Cow Efficiency, Calving Ease.

• Bulls •

63 **BSF WARRIOR A817 V5** 
 1-B 99% # 1625815 Tat.: BSF3 A817

Birth: 4-19-13
 BECKTON WARRIOR W534 N4
 Ref. W-2
 BSF NEPTALA S036 VA
 Beckton Warrior C1 S337
 BKT Larkeisa S055 NB
 Beckton Vega P079
 BSF Neptala P301
 Beckton Warrior CL M686
 Beckton Christy K101 CD
 Beckton Nebula P P707
 Beckton Larkeisa P688 CH
 Beckton Vegas S1 K316
 Beckton Lydia H159 JL
 Beckton Neptune R2 K065
 BSF Regus L616 LN

DAM		Calv.Ease	BW	WW	YW	Milk	HPG	Stay	Maint.En.
Age	7	13	-6.7	42	68	17	12	14	2.0
Wt	1160	Marb +.56		REA +.16		Bfat +.05			
Prog.BW	69	BWt	WWt	WR	ADG	YWt	YR	Scr.	Fr.
WR	110	64	504	90	3.99	1126	104	32	5.5
YR	112								
Wean Pct.	43%								
Cow Eff.	91								

★★★★★ for Low Maintenance, Marbling, Rib-eye area, Superior Cow, Calving Ease, Stayability.

65 **BSF LIKABLE A268 C3** 
 1-B 99% # 1625851 Tat.: BSF3 A268

Birth: 3-21-13
 BECKTON LIKABLE U120 L2
 Ref. L-3
 BSF LAUREL U202 CQ
 Beckton Likable S633
 Beckton Lana S718 LN
 Beckton Cherokee N N479
 BSF Laurel N839 LN
 Beckton Lancer F442 T
 Beckton Kit F468 JL
 Beckton Lancer F442 T
 Beckton Lana F891 JL
 BFCK Cherokee Cnyn 4912
 Beckton Dinah C440 NM
 Beckton Lancer T1 H080
 BSF Regus E601

DAM		Calv.Ease	BW	WW	YW	Milk	HPG	Stay	Maint.En.
Age	5	10	-3.3	45	71	17	8	15	-4.6
Wt	950	Marb +.57		REA +.28		Bfat +.01			
Prog.BW	69	BWt	WWt	WR	ADG	YWt	YR	Scr.	Fr.
WR	100	76	561	101	4.05	1155	107	38	5.5
YR	100								
Wean Pct.	59%								
Cow Eff.	124								

★★★★★ for Low Maintenance, Growth, Gainability, Marbling, Rib-eye area, High Cow Efficiency, Calving Ease, Stayability.

64 **BSF MAXIMUS A391 N** 
 99% # Tat.: BSF3 A391

Birth: 3-26-13
 BECKTON RED ANGUS SIRE
 Ref.
 BSF NEBULANN P046
 Beckton Red Angus Sire
 Beckton Red Angus Dam
 Beckton Red Angus Sire
 Beckton Red Angus Dam
 Beckton Nebula M045
 BSF Regus M717 EP
 Beckton Red Angus Sire
 Beckton Red Angus Dam
 Beckton Red Angus Sire
 Beckton Red Angus Dam
 Beckton Neptune R2 K065
 Beckton Belga K285 JL
 Beckton Epic K F075
 BSF Regus H098

DAM		Calv.Ease	BW	WW	YW	Milk	HPG	Stay	Maint.En.
Age	9	9	-3.3	13	27.5	9	5.5	7	-5.1
Wt	1045	Marb +.07		REA -.07		Bfat +.03			
Prog.BW	61	BWt	WWt	WR	ADG	YWt	YR	Scr.	Fr.
WR	100	68	574	103	3.54	1107	102	36	6.0
YR	102								
Wean Pct.	55%								
Cow Eff.	116								

★★★★★ for Low Maintenance, Calving Ease.

66 **BSF NEBULA A185 N5** 
 99% # Tat.: BSF3 A185

Birth: 3-18-13
 BECKTON NEBULA W778 J4
 Ref. N-6
 BSF NEBULANN R664 NB
 Beckton Nebula PJ S543
 Beckton Lana S197 JT
 Beckton Nebula M045
 BSF Regus M043 JC
 Beckton Nebula P P707
 Beckton Lana P685 JO
 Beckton Jet L P491
 Beckton Lana P828 LN
 Beckton Neptune R2 K065
 Beckton Belga K285 JL
 Beckton Justice C K449
 BSF Regus K341 JC

DAM		Calv.Ease	BW	WW	YW	Milk	HPG	Stay	Maint.En.
Age	8	18.5	-7.5	41.5	73	18	9.5	14.5	0.9
Wt	1115	Marb +.49		REA -.01		Bfat +.03			
Prog.BW	60	BWt	WWt	WR	ADG	YWt	YR	Scr.	Fr.
WR	105	69	600	112	3.32	1043	99	31	5.5
YR	101								
Wean Pct.	54%								
Cow Eff.	113								

★★★★★ for Low Maintenance, Marbling, Calving Ease, Stayability.



67 **BECKTON LANCER A067 N5** 
 1-A 100% # 1625814 Tat.: BSF3 A067

Birth: 3-11-13
 BECKTON LANCER T371 H4
 Ref. L-2
 BECKTON LANA S034 NB
 Beckton Lancer F442 T
 Beckton Coca F276 HV
 Beckton Nebula P P707
 Beckton Lana P368 CH
 Beckton Lancer T A664
 Bkt Suffeina A828 DM
 Leachman Heavenly 8141
 Beckton Coca B112 CB
 Beckton Nebula M045
 Beckton Lana M809 EP
 Beckton Champ R3 H338
 Beckton Lana F483 ZN

DAM		Calv.Ease	BW	WW	YW	Milk	HPG	Stay	Maint.En.
Age	7	11	-4.1	55	90	11	7	13	3.1
Wt	1065	Marb +.45		REA +.05		Bfat -.01			
Prog.BW	74	BWt	WWt	WR	ADG	YWt	YR	Scr.	Fr.
WR	104	70	549	103	3.65	1040	98	36	5.0
YR	106								
Wean Pct.	52%								
Cow Eff.	109								

★★★★★ for Low Maintenance, Marbling, Superior Cow, Calving Ease, Stayability.

• Bulls •



70 **BECKTON EPIC A252 H7** 

1-A 100% # 1626376 Tat.: BKT3 A252

Birth: 3-21-13

BECKTON EPIC X330 L6
Ref. E-3

- Beckton Epic T330 L5
- Beckton Epic K4 N795
- Beckton Belga K202 LN
- Beckton Lancer F442 T
- Beckton Kit R503 LN
- Beckton Kit F468 JL

BECKTON LANA W019 H

- Beckton Heritage T270 J2
- Beckton Heritage N013
- Beckton Coca P602 JL
- Beckton Lana T699 JC
- Beckton Justice CH M056
- Beckton Lana G730 JL

DAM		Calv.Ease	BW	WW	YW	Milk	HPG	Stay	Maint.En.
Age	4	12	-5.3	49	79	16	8	15	-1.8
Wt	935	Marb +.68		REA +.15		Bfat +.04			
Prog.BW	65	BWt	WWt	WR	ADG	YWt	YR	Scr.	Fr.
WR	108	66	559	100	3.37	1067	99	35	5.5
YR	108								
Wean Pct.	58%								
Cow Eff.	122								

★★★★★ for Low Maintenance, Marbling, Rib-eye area, Superior Cow, High Cow Efficiency, Calving Ease, Stayability.

68 **BECKTON JULIAN A674 C5** 

1-A 100% # 1626296 Tat.: BKT3 A674

Birth: 4-6-13

BECKTON JULIAN G5 S107
Ref. J-2

- Beckton Julian GJ P535
- Beckton Julian 7526G
- Beckton Mona D086 JL
- Beckton Dominor ZC M919
- Beckton Minola P826 DM
- Beckton Minola M641 WR

BECKTON LYDIA T601 CT

- Beckton Clifftop T3 N800
- Beckton Lana J384 CD
- Beckton Warrior TD L493
- Beckton Lydia N081 WR
- Beckton Lydia L625 WR

DAM		Calv.Ease	BW	WW	YW	Milk	HPG	Stay	Maint.En.
Age	6	10	-1.4	52	87	15	10	13	-5.2
Wt	1020	Marb +.55		REA +.02		Bfat +.06			
Prog.BW	67	BWt	WWt	WR	ADG	YWt	YR	Scr.	Fr.
WR	102	78	602	108	3.48	1120	104	37	5.0
YR	100								
Wean Pct.	59%								
Cow Eff.	124								

★★★★★ for Low Maintenance, Marbling, High Cow Efficiency, Calving Ease, Stayability.



69 **BECKTON LIKABLE A031 N4** 

1-A 100% # 1626628 Tat.: BKT3 A031

Birth: 3-8-13

BECKTON LIKABLE Y124 L3
Ref. L-5

- Beckton Likable U130 L2
- Beckton Likable S633
- Beckton Kit S478 LN
- Beckton Lasso P741
- BKT Pine Marie S802 LO
- BKT Pine Marie P475 LN

BECKTON LARKEISA Y389 N

- Beckton Nebula W040 E4
- Beckton Nebula T054 H3
- BKT Suffeina T110 EM
- Beckton Larkeisa W770 J
- Beckton Julio L233
- Beckton Larkeisa N897 HR

DAM		Calv.Ease	BW	WW	YW	Milk	HPG	Stay	Maint.En.
Age	2	12	-3.9	50	80	15	10	14.5	-1.9
Wt	775	Marb +.72		REA +.12		Bfat +.05			
Prog.BW	61	BWt	WWt	WR	ADG	YWt	YR	Scr.	Fr.
WR	111	61	566	111	3.65	1093	107	35	5.5
YR	107								
Wean Pct.	65%								
Cow Eff.	137								

★★★★★ for Low Maintenance, Growth, Marbling, Superior Cow, High Cow Efficiency, Calving Ease, Stayability.

71 **BECKTON EPIC A423 J7** 

1-A 100% # 1625863 Tat.: BSF3 A423

Birth: 3-27-13

BECKTON EPIC X330 L6
Ref. E-3

- Beckton Epic T330 L5
- Beckton Epic K4 N795
- Beckton Belga K202 LN
- Beckton Lancer F442 T
- Beckton Kit R503 LN
- Beckton Kit F468 JL

BECKTON MINOLA U378 JL

- Beckton Julian G3 P608
- Beckton Julian GG B571
- Bkt Suffeina A828 DM
- Beckton Minola M155 CE
- Beckton Cruiser K118
- Beckton Minola K592 EP

DAM		Calv.Ease	BW	WW	YW	Milk	HPG	Stay	Maint.En.
Age	5	12	-3.9	51	88	17	9	13	-5.0
Wt	1075	Marb +.69		REA +.10		Bfat +.02			
Prog.BW	64	BWt	WWt	WR	ADG	YWt	YR	Scr.	Fr.
WR	106	71	594	111	3.82	1080	102	36	5.0
YR	101								
Wean Pct.	55%								
Cow Eff.	116								

★★★★★ for Low Maintenance, Marbling, High Cow Efficiency, Calving Ease, Stayability.

• Bulls •

72 BECKTON SCAMP A290 H4 
 1-A 100% # 1626203 Tat.: BKT3 A290

Birth: 3-23-13
 Beckton Scamp T A825
BECKTON SCAMP X494 E3
 Ref. S-1 Beckton Lana S074 EP
 Beckton Scamp 8954
 Bkt Encino 8459 TJ
 Beckton Epic KH P678
 Beckton Lana P317 JL
 Beckton Hustler CN J102
 Beckton Barmaid J012 CO
 Beckton Cody V E023
 Bkt Pine Marie D764 HD
BKT PINE MARIE R401 HU
 Beckton Hustler C2 L079
 Bkt Pine Marie LC30 CD

DAM		Calv.Ease	BW	WW	YW	Milk	HPG	Stay	Maint.En.
Age	8	9	-4.6	54	87	14	12	10	-4.3
Wt	1200								
Prog.BW	75								
WR	101			Marb +.47	REA +.09			Bfat +.00	
YR	107								
Wean Pct.	47%								
Cow Eff.	98								
DAM		BWt	WWt	WR	ADG	YWt	YR	Scr.	Fr.
		64	559	100	3.26	1053	97	38	5.5

★★★★★ for Low Maintenance, Marbling, Calving Ease.

73 BECKTON DOMINOR A592 H6 
 1-A 100% # 1626286 Tat.: BKT3 A592

Birth: 4-2-13
 Beckton Dominor Z1 R610
BECKTON DOMINOR W640 C5
 Ref. D-1 Beckton Mona R166 CQ
 Beckton Dominor ZC M919
 Beckton Sierra K557 LO
 Beckton Cherokee N N479
 Beckton Mona N342 HU
 Beckton Hustler C2 L079
 Beckton Lana L007 JL
 Beckton Lancer F442 T
 Beckton Vernice J693 HU
BECKTON VERNICE T447 HT
 Beckton Heritage N013
 Beckton Vernice N200 LN

DAM		Calv.Ease	BW	WW	YW	Milk	HPG	Stay	Maint.En.
Age	6	10	-1.9	59	89	15	9	15	-3.5
Wt	1155								
Prog.BW	78								
WR	106			Marb +.65	REA +.04			Bfat +.03	
YR	103								
Wean Pct.	49%								
Cow Eff.	104								
DAM		BWt	WWt	WR	ADG	YWt	YR	Scr.	Fr.
		82	570	102	3.88	1083	100	33	5.0

★★★★★ for Low Maintenance, Marbling, Superior Cow, Calving Ease, Stayability.



74 BECKTON SCAMP A577 N4 
 1-A 100% # 1626436 Tat.: BKT3 A577

Birth: 4-2-13
 Beckton Scamp T A825
BECKTON SCAMP X494 E3
 Ref. S-1 Beckton Lana S074 EP
 Beckton Scamp 8954
 Bkt Encino 8459 TJ
 Beckton Epic KH P678
 Beckton Lana P317 JL
 Beckton Nebula E P084
 Beckton Eola P530 NB
 Beckton Champ R1 H024
 Beckton Firefly H314 EP
BECKTON FIREFLY W511 N
 Beckton Nebula EN S347
 Beckton Firefly K180 CH

DAM		Calv.Ease	BW	WW	YW	Milk	HPG	Stay	Maint.En.
Age	4	14	-5.6	47	72	23	11	14	-9.2
Wt	850								
Prog.BW	66								
WR	104			Marb +.62	REA +.02			Bfat +.04	
YR	101								
Wean Pct.	68%								
Cow Eff.	143								
DAM		BWt	WWt	WR	ADG	YWt	YR	Scr.	Fr.
		69	597	107	3.43	1100	102	37	5.5

★★★★★ for Low Maintenance, Marbling, High Cow Efficiency, Calving Ease, Stayability.

75 BECKTON EPIC A388 L6 
 1-A 100% # 1626219 Tat.: BKT3 A388

Birth: 3-26-13
 Beckton Epic K4 N795
BECKTON EPIC U749 D5
 Ref. E-2 Beckton Denise R308 DM
 Beckton Epic KJ J722
 Beckton Sierra J789 EP
 Beckton Dominor ZC M919
 Beckton Denise L639 JL
 Beckton Lancer T1 H080
 Beckton Ruth G534 NP
 Beckton Julio L233
 Beckton Lana J131 CT
BECKTON LANA S049 LO
 Beckton Lasso P741
 Beckton Lana P265 JO

DAM		Calv.Ease	BW	WW	YW	Milk	HPG	Stay	Maint.En.
Age	7	13	-6.4	42	81	21	5	12	1.7
Wt	1030								
Prog.BW	64								
WR	107			Marb +.62	REA +.23			Bfat +.03	
YR	102								
Wean Pct.	56%								
Cow Eff.	118								
DAM		BWt	WWt	WR	ADG	YWt	YR	Scr.	Fr.
		63	579	104	3.43	1061	98	35	5.0

★★★★★ for Low Maintenance, Marbling, Rib-eye area, High Cow Efficiency, Calving Ease.

76 BECKTON CLIFFTOP A114 H4 
 1-A 100% # 1626225 Tat.: BKT3 A114

Birth: 3-15-13
 BKT Clifftop TP R288
BECKTON CLIFFTOP W692 E3
 Ref. C-1 Beckton Lydia S274 EP
 Beckton Clifftop T C075
 Beckton Christy K209 CO
 Beckton Epic KM M115
 Beckton Lydia M607 LO
 Beckton Hustler C2 L079
 Beckton Lana L498 CO
 Beckton Julio L233
 Beckton Sierra J659 DM
BECKTON SIERRA S120 HW
 Beckton Hawk P248
 Beckton Sierra P348 JO

DAM		Calv.Ease	BW	WW	YW	Milk	HPG	Stay	Maint.En.
Age	7	10	-3.6	47	82	28	9	16	-4.0
Wt	1025								
Prog.BW	72								
WR	105			Marb +.53	REA -.11			Bfat +.06	
YR	101								
Wean Pct.	57%								
Cow Eff.	120								
DAM		BWt	WWt	WR	ADG	YWt	YR	Scr.	Fr.
		72	582	109	2.30	1022	97	35	5.5

★★★★★ for Low Maintenance, Marbling, High Cow Efficiency, Calving Ease, Stayability.

• Bulls •

77 **BECKTON SCAMP A122 N4** 

1-A 100% # 1626300 Tat.: BKT3 A122

Birth: 3-15-13

Beckton Scamp T A825
BECKTON SCAMP X494 E3
 Ref. S-1 Beckton Lana S074 EP

Beckton Scamp 8954
 Bkt Encino 8459 TJ
 Beckton Epic KH P678
 Beckton Lana P317 JL
 Beckton Nebula M045
 Beckton Larkeisa M138 JC
 Beckton Colt K M609
 Beckton Larkaba M226 LN

Beckton Nebula J R475
BECKTON LARKABA T655 NB
 Beckton Larkaba R332 CK

DAM		Calv.Ease	BW	WW	YW	Milk	HPG	Stay	Maint.En.
Age	6	13	-8.3	44	72	16	12	14	-8.3
Wt	990								
Prog.BW	58								
WR	98		Marb	+4.8	REA	+0.8	Bfat	+0.2	
YR	96								
Wean Pct.	53%	BWt	WWt	WR	ADG	YWt	YR	Scr.	Fr.
Cow Eff.	112	54	526	99	3.65	1020	96	39	5.0

★★★★★ for Low Maintenance, Marbling, Calving Ease, Stayability.

80 **BSF NEBULA A436 J3** 

1-B 99% # 1626025 Tat.: BSF3 A436

Birth: 3-28-13

Beckton Nebula M045
BECKTON NEBULA E P084
 Ref. N BKT Pine Marie M119 EP

Beckton Neptune R2 K065
 Beckton Belga K285 JL
 Beckton Epic K F075
 Bkt Pine Marie D126 JL
 Beckton Julian GJ P535
 Beckton Minola P826 DM
 Beckton Hustler CN J102
 WF Regus H107

Beckton Julian G5 S107
BSF HUSTELLE X343 J
 BSF Hustle P748

DAM		Calv.Ease	BW	WW	YW	Milk	HPG	Stay	Maint.En.
Age	3	14	-3.7	58	96	17	12	14	-5.9
Wt	985								
Prog.BW	61								
WR	119		Marb	+7.0	REA	-0.9	Bfat	+0.6	
YR	107								
Wean Pct.	57%	BWt	WWt	WR	ADG	YWt	YR	Scr.	Fr.
Cow Eff.	121	69	605	116	3.99	1175	112	34	5.5

★★★★★ for Low Maintenance, Growth, Marbling, Superior Cow, High Cow Efficiency, Calving Ease, Stayability.

78 **BSF HERITAGE A103 C3** 

1-B 99% # 1625849 Tat.: BSF3 A103

Birth: 3-14-13

Beckton Heritage N013
BECKTON HERITAGE X356 E2
 Ref. H-1 Beckton Lana S489 EP

Beckton Hustler C2 L079
 Beckton Lana L007 JL
 Beckton Epic K4 N795
 Beckton Lana E136 TP
 Beckton Clifftop T C075
 Beckton Christy K209 CO
 Beckton Vegas P D462
 Bkt Regus D034

BKT Clifftop TP R288
BSF CLIFFTANA U177 CT
 BSF Regus F175

DAM		Calv.Ease	BW	WW	YW	Milk	HPG	Stay	Maint.En.
Age	5	7	-1.8	54	86	20	9	11	-3.5
Wt	1060								
Prog.BW	75								
WR	110		Marb	+7.1	REA	+0.6	Bfat	+0.4	
YR	110								
Wean Pct.	55%	BWt	WWt	WR	ADG	YWt	YR	Scr.	Fr.
Cow Eff.	116	79	586	105	3.93	1163	108	38	5.0

★★★★★ for Low Maintenance, Growth, Marbling, Superior Cow, High Cow Efficiency, Calving Ease.



79 **BSF ACCENT A531 H3** 

1-B 99% # 1625997 Tat.: BSF3 A531

Birth: 3-31-13

Beckton Cody K1 P014
BECKTON ACCENT U777 C2
 Ref. A-1 Beckton Susan R022 CQ

Beckton Cody KH M390
 Beckton Rose M126 WR
 Beckton Cherokee N N479
 Beckton Susan N023 JE
 Beckton Heritage N013
 Beckton Coca P602 JL
 Beckton Loki C M740
 BSF Regus F700

Beckton Heritage T270 J2
BSF LOKETTA X132 H
 BSF Loketta R368 LO

DAM		Calv.Ease	BW	WW	YW	Milk	HPG	Stay	Maint.En.
Age	3	11	-2.3	57	86	24	7	15	-4.1
Wt	1005								
Prog.BW	70								
WR	107		Marb	+6.1	REA	+1.0	Bfat	+0.4	
YR	110								
Wean Pct.	56%	BWt	WWt	WR	ADG	YWt	YR	Scr.	Fr.
Cow Eff.	117	75	598	114	3.88	1187	113	36	6.0

★★★★★ for Low Maintenance, Growth, Marbling, Superior Cow, High Cow Efficiency, Calving Ease, Stayability.

81 **BSF ACCENT A247 N3** 

1-B 99% # 1625946 Tat.: BSF3 A247

Birth: 3-21-13

Beckton Cody K1 P014
BECKTON ACCENT U777 C2
 Ref. A-1 Beckton Susan R022 CQ

Beckton Cody KH M390
 Beckton Rose M126 WR
 Beckton Cherokee N N479
 Beckton Susan N023 JE
 Beckton Nebula E P084
 Beckton Eola P530 NB
 Beckton Epic KM M115
 BSF Regus M602 EP

Beckton Nebula EN S347
BSF EPIQUETTE W644 N
 BSF Epiquette R729 EP

DAM		Calv.Ease	BW	WW	YW	Milk	HPG	Stay	Maint.En.
Age	4	13	-5.8	50	77	25	12	16	-5.0
Wt	1075								
Prog.BW	63								
WR	99		Marb	+5.1	REA	-0.7	Bfat	+0.4	
YR	104								
Wean Pct.	51%	BWt	WWt	WR	ADG	YWt	YR	Scr.	Fr.
Cow Eff.	108	66	569	107	3.54	1122	106	34	5.5

★★★★★ for Low Maintenance, Growth, Marbling, Calving Ease, Stayability.

• Bulls •



84 **BSF JULIAN A355 R5** 

1-B 99% # 1625903 Tat.: BSF3 A355

Birth: 3-25-13

BECKTON JULIAN G3 P608
Ref. J

- Beckton Julian GG B571
- Beckton Dominor 9455
- Bkt Suffeina A828 DM
- Bkt Suffeina 9493 TT

BSF ERICA W053 R

- Beckton Ranger T603 H3
- Beckton Ranger 9479R
- BSF Erica T609 EP
- Beckton Rose N044 HU
- Beckton Epic KM M115
- BSF Red G329

DAM		Calv.Ease	BW	WW	YW	Milk	HPG	Stay	Maint.En.
Age	4	15	-6.0	42	74	19	14	13	-9.4
Wt	1010								
Prog.BW	59								
WR	103			Marb +.80	REA -.15				Bfat +.00
YR	103								
Wean Pct.	57%								
Cow Eff.	120								
		BWt	WWt	WR	ADG	YWt	YR	Scr.	Fr.
		66	593	106	3.71	1152	107	36	5.5

★★★★★ for Low Maintenance, Growth, Marbling, Superior Cow, High Cow Efficiency, Calving Ease, Stayability.

82 **BSF EPIC A375 C6** 

1-B 99% # 1625848 Tat.: BSF3 A375

Birth: 3-26-13

BECKTON EPIC U749 D5
Ref. E-2

- Beckton Epic K4 N795
- Beckton Sierra J789 EP
- Beckton Dominor ZC M919
- Beckton Denise R308 DM
- Beckton Denise L639 JL

BSF WENDIE U152 CT

- Beckton Clifftop T3 N800
- Bkt Clifftop TV G672
- Beckton Lana J384 CD
- BSF Wendie N343 WR
- Beckton Warrior T1 H281
- BSF Regus E323

DAM		Calv.Ease	BW	WW	YW	Milk	HPG	Stay	Maint.En.
Age	5	10	-3.0	51	93	16	7	12	2.0
Wt	1075								
Prog.BW	70								
WR	106			Marb +.58	REA +.36				Bfat +.03
YR	105								
Wean Pct.	50%								
Cow Eff.	105								
		BWt	WWt	WR	ADG	YWt	YR	Scr.	Fr.
		75	538	101	3.93	1108	105	35	5.5

★★★★★ for Low Maintenance, Marbling, Rib-eye area, Superior Cow, Calving Ease.

85 **BSF LIKABLE A025 L4** 

1-B 99% # 1626700 Tat.: BKB3 A025

Birth: 3-6-13

BECKTON LIKABLE Y675 E3
Ref. L-7

- Beckton Likable U120 L2
- Beckton Likable S633
- Beckton Lana S718 LN
- Beckton Firefly T331 EP
- Beckton Epic KM M115
- Beckton Firefly N457 CO

BSF JULIANNE Y053 L

- BSF Lancer W007 N5
- Beckton Lancer T371 H4
- BSF Julianne W062 N
- BSF Dominique T338 NB
- Beckton Nebula T252 L3
- BSF Julianne T574 EP

DAM		Calv.Ease	BW	WW	YW	Milk	HPG	Stay	Maint.En.
Age	2	8	-4.1	55	91	16	8	18.5	-1.6
Wt	795								
Prog.BW	56								
WR	103			Marb +.54	REA +.16				Bfat +.03
YR	112								
Wean Pct.	59%								
Cow Eff.	123								
		BWt	WWt	WR	ADG	YWt	YR	Scr.	Fr.
		56	526	103	4.44	1144	112	38	5.5

★★★★★ for Low Maintenance, Growth, Gainability, Marbling, Rib-eye area, Superior Cow, High Cow Efficiency, Calving Ease, Stayability.

83 **BSF ACCENT A369 N3** 

1-B 99% # 1626684 Tat.: BKB3 A369

Birth: 3-25-13

BECKTON ACCENT W180 C2
Ref. A-2

- Beckton Cody K1 P014
- Beckton Cody KH M390
- Beckton Rose M126 WR
- Beckton Christy R046 CQ
- Beckton Cherokee N N479
- Beckton Christy N740 HR

BSF JULIA W039 N

- Beckton Nebula T398 V3
- Beckton Nebula L P093
- Beckton Minerva J615 VG
- BSF Julia T175 JO
- Beckton Julio L233
- BSF Regus M604 LN

DAM		Calv.Ease	BW	WW	YW	Milk	HPG	Stay	Maint.En.
Age	4	13	-7.9	50	86	22	12	15	-4.7
Wt	860								
Prog.BW	58								
WR	105			Marb +.51	REA +.25				Bfat +.04
YR	105								
Wean Pct.	66%								
Cow Eff.	138								
		BWt	WWt	WR	ADG	YWt	YR	Scr.	Fr.
		56	583	105	3.99	1165	108	35	5.5

★★★★★ for Low Maintenance, Growth, Marbling, Rib-eye area, Superior Cow, High Cow Efficiency, Calving Ease, Stayability.



• Bulls •

86 **BSF LEGEND A719 J3** 

1-B 99% # 1625983 Tat.: BSF3 A719

Birth: 4-10-13

BECKTON LEGEND U331 E2
Ref. L-4

BSF CHERISE X058 J

Beckton Legend S670
Beckton Lana S669 EP
Beckton Lancer F442 T
Beckton Kit F468 JL
Beckton Epic K4 N795
Beckton Lana M597 LO
Beckton Jet L P491
Beckton Lydia N047 LM
Beckton Cherokee N N479
BSF Regus L683 CT

DAM		Calv.Ease	BW	WW	YW	Milk	HPG	Stay	Maint.En.
Age	3	12	-3.6	50	83	20	6	17	0.8
Wt	895	Marb +0.95		REA +0.16		Bfat +0.05			
Prog.BW	67	BWt	WWt	WR	ADG	YWt	YR	Scr.	Fr.
WR	113	70	589	113	4.33	1204	115	34	5.5
YR	110								
Wean Pct.	61%								
Cow Eff.	129								

★★★★★ for Low Maintenance, Growth, Gainability, Marbling, Rib-eye area, Superior Cow, High Cow Efficiency, Calving Ease, Stayability.

89 **BSF ACCENT A362 J3** 

99% # Tat.: BSF3 A362

Birth: 3-25-13

BECKTON ACCENT W180 C2
Ref. A-2

BSF LANETTE T781 JL

Beckton Cody K1 P014
Beckton Christy R046 CQ
Beckton Cherokee N N479
Beckton Christy N740 HR
Beckton Julian GG B571
Bkt Suffeina A828 DM
Beckton Lancer T4 J536
BSF Regus F697

DAM		Calv.Ease	BW	WW	YW	Milk	HPG	Stay	Maint.En.
Age	6	13	-3.8	45	81	22	12	16.5	-3.2
Wt	1135	Marb +0.22		REA +0.25		Bfat +0.03			
Prog.BW	61	BWt	WWt	WR	ADG	YWt	YR	Scr.	Fr.
WR	106	59	591	106	3.26	1077	100	36	5.5
YR	101								
Wean Pct.	52%								
Cow Eff.	110								

★★★★★ for Low Maintenance, Marbling, Rib-eye area, Calving Ease, Stayability.

87 **BSF LIKABLE A564 J3** 

99% # Tat.: BSF3 A564

Birth: 4-1-13

BECKTON LIKABLE U120 L2
Ref. L-3

BSF JUSTICIA S777 JC

Beckton Likable S633
Beckton Lana S718 LN
Beckton Lancer F442 T
Beckton Kit F468 JL
Beckton Lancer F442 T
Beckton Lana F891 JL
Beckton Justice C K449
Beckton Ruth K802 HD
Beckton Epic K F075
BSF Regus H520

DAM		Calv.Ease	BW	WW	YW	Milk	HPG	Stay	Maint.En.
Age	7	12	-3.4	32.5	59	14.5	10	15.5	-2.9
Wt	1090	Marb +0.32		REA +0.34		Bfat +0.00			
Prog.BW	68	BWt	WWt	WR	ADG	YWt	YR	Scr.	Fr.
WR	102	66	592	106	3.82	1136	105	35	5.0
YR	101								
Wean Pct.	54%								
Cow Eff.	114								

★★★★★ for Low Maintenance, Marbling, Rib-eye area, Calving Ease, Stayability.



88 **BSF NEBULA A018 L6** 

99% # Tat.: BSF3 A018

Birth: 3-5-13

BECKTON NEBULA Y002 C5
Ref. N-7

BSF CODETTE Y150 L

Beckton Nebula W778 J4
BKT Pine Marie W102 C
Beckton Nebula PJ S543
Beckton Lana S197 JT
BKT Clifftop TP R288
BKT Pine Marie M119 EP
Beckton Likable S633
Beckton Lana S718 LN
Beckton Cody KH M390
BSF Regus L632 CK

DAM		Calv.Ease	BW	WW	YW	Milk	HPG	Stay	Maint.En.
Age	2	14	-4.6	42.8	75.5	16.3	8.5	15.3	0.7
Wt	825	Marb +0.37		REA +0.30		Bfat +0.03			
Prog.BW	61	BWt	WWt	WR	ADG	YWt	YR	Scr.	Fr.
WR	101	61	515	101	4.44	1091	107	33	5.5
YR	107								
Wean Pct.	55%								
Cow Eff.	116								

★★★★★ for Low Maintenance, Growth, Gainability, Marbling, Rib-eye area, High Cow Efficiency, Calving Ease, Stayability.

90 **BSF NEBULA A594 E5** 

99% # Tat.: BSF3 A594

Birth: 4-2-13

BECKTON NEBULA W778 J4
Ref. N-6

BSF REGUS M563 EP

Beckton Nebula PJ S543
Beckton Lana S197 JT
Beckton Nebula P P707
Beckton Lana P685 JO
Beckton Jet L P491
Beckton Lana P828 LN
Beckton Saga KJ B702
Beckton Kuruba B508 PC
Beckton Loki F251
BSF Regus E799

DAM		Calv.Ease	BW	WW	YW	Milk	HPG	Stay	Maint.En.
Age	11	16	-7.2	32.5	60	20	2.5	15.5	-4.1
Wt	1000	Marb +0.56		REA +0.05		Bfat +0.04			
Prog.BW	64	BWt	WWt	WR	ADG	YWt	YR	Scr.	Fr.
WR	102	64	572	103	4.05	1118	103	32	5.0
YR	100								
Wean Pct.	55%								
Cow Eff.	116								

★★★★★ for Low Maintenance, Gainability, Marbling, High Cow Efficiency, Calving Ease, Stayability.

• Bulls •



91 BECKTON NEBULA A454 J3
1-A 100% # 1626236 Tat.: BKT3 A454



Birth: 3-28-13

Beckton Nebula M045
Beckton Neptune R2 K065
Beckton Belga K285 JL

BECKTON NEBULA T269 E2
Ref. N-3
Beckton Ruth M967 EP
Beckton Epic KN H110
Beckton Ruth A905 SG

Beckton Jules L429
BKT PINE MARIE S467 JE
BKT Pine Marie M119 EP
Beckton Julian G1 J526
Beckton Barona J591 EP
Beckton Epic K F075
Bkt Pine Marie D126 JL

DAM		Calv.Ease	BW	WW	YW	Milk	HPG	Stay	Maint.En.
Age	7	14	-3.9	47	74	19	9	15	-5.3
Wt	1165	Marb +.60		REA +.01		Bfat +.04			
Prog.BW	64	BWt	WWt	WR	ADG	YWt	YR	Scr.	Fr.
WR	102	76	541	101	3.99	1164	110	35	6.0
YR	103								
Wean Pct.	46%								
Cow Eff.	98								

★★★★★ for Low Maintenance, Growth, Marbling, Calving Ease, Stayability.

92 BECKTON NEBULA A718 A4
1-A 100% # 1625840 Tat.: BSF3 A718



Birth: 4-10-13

Beckton Nebula L P093
Beckton Nebula M045
Beckton Marta M021 LN

BECKTON NEBULA W486 D3
Ref. N-5
Beckton Belga R716 DM
Beckton Dominor ZC M919
Beckton Belga K285 JL

Beckton Cobalt S029
BECKTON LARKABA U062 CB
Beckton Larkaba S374 NB
Beckton Cody K1 P014
Beckton Marta P633 JO
Beckton Nebula M045
Beckton Larkaba M256 JC

DAM		Calv.Ease	BW	WW	YW	Milk	HPG	Stay	Maint.En.
Age	5	14	-5.9	49	84	13	9	17	-9.1
Wt	925	Marb +.39		REA +.11		Bfat +.04			
Prog.BW	61	BWt	WWt	WR	ADG	YWt	YR	Scr.	Fr.
WR	99	64	564	106	4.33	1169	111	34	5.5
YR	104								
Wean Pct.	61%								
Cow Eff.	128								

★★★★★ for Low Maintenance, Growth, Gainability, Marbling, High Cow Efficiency, Calving Ease, Stayability.

94 BECKTON ORION A100 V2
1-A 100% # 1626333 Tat.: BKT3 A100



Birth: 3-14-13

Beckton Roman J S158
Beckton Roman J S158
TR Romeo NT379
Beckton Belga K285 JL

BECKTON JANUS X799 L2
Ref. O-1
Beckton Sierra K557 LO
Beckton Loki F251
Beckton Sierra C157 CL

Beckton Vega P079
BECKTON ROSE U298 VA
Beckton Rose P015 LN
Beckton Vegas S1 K316
Beckton Lydia H159 JL
Beckton Lancer T7 M089
Beckton Rose M131 HR

DAM		Calv.Ease	BW	WW	YW	Milk	HPG	Stay	Maint.En.
Age	5	11	-3.8	50	82	21	6	12	-0.1
Wt	1190	Marb +.31		REA +.05		Bfat -.01			
Prog.BW	65	BWt	WWt	WR	ADG	YWt	YR	Scr.	Fr.
WR	102	70	506	95	4.27	1101	104	35	5.5
YR	106								
Wean Pct.	43%								
Cow Eff.	90								

★★★★★ for Low Maintenance, Gainability, Marbling, Calving Ease.

93 BECKTON HERITAGE A810 E3
1-A 100% # 1626427 Tat.: BKT3 A810



Birth: 4-18-13

Beckton Heritage N013
Beckton Hustler C2 L079
Beckton Lana L007 JL

BECKTON HERITAGE X356 E2
Ref. H-1
Beckton Lana S489 EP
Beckton Epic K4 N795
Beckton Lana E136 TP

Beckton Epic K4 N795
BECKTON ENCINO W439 E
Beckton Encino S566 JL
Beckton Epic KJ J722
Beckton Sierra J789 EP
Beckton Julian G3 P608
Beckton Encino P733 HU

DAM		Calv.Ease	BW	WW	YW	Milk	HPG	Stay	Maint.En.
Age	4	9	-1.3	64	108	14	4	10	4.8
Wt	1100	Marb +.83		REA -.03		Bfat +.03			
Prog.BW	75	BWt	WWt	WR	ADG	YWt	YR	Scr.	Fr.
WR	98	78	588	106	4.44	1153	107	34	6.0
YR	102								
Wean Pct.	52%								
Cow Eff.	109								

★★★★★ for Growth, Gainability, Marbling, Calving Ease.

95 BECKTON JULIAN A663 N6
1-A 100% # 1626469 Tat.: BKT3 A663



Birth: 4-5-13

Beckton Julian G5 S107
Beckton Julian GJ P535
Beckton Minola P826 DM

BECKTON JULIAN X465 J5
Ref. J-4
Beckton Suffeina P643 JL
Beckton Julian GG B571
Bkt Suffeina A828 DM

Beckton Nebula G S237
BECKTON ROSE W833 N
Beckton Rose R579 JJ
Beckton Nebula M045
Beckton Lakme LA06 JL
Beckton Juno N493
Beckton Rose N524 NM

DAM		Calv.Ease	BW	WW	YW	Milk	HPG	Stay	Maint.En.
Age	4	13	-1.3	55	88	16	10	15	-4.8
Wt	1000	Marb +.70		REA -.03		Bfat +.02			
Prog.BW	69	BWt	WWt	WR	ADG	YWt	YR	Scr.	Fr.
WR	106	83	549	103	4.10	1162	110	35	5.5
YR	108								
Wean Pct.	53%								
Cow Eff.	111								

★★★★★ for Low Maintenance, Growth, Gainability, Marbling, Superior Cow, Calving Ease, Stayability.

• Bulls •

96 BECKTON NEBULA A782 E4 

1-A 100% # 1626475 Tat.: BKT3 A782

Birth: 4-14-13

BECKTON NEBULA T398 V3
Ref. N-4

BECKTON BELGA W895 E

DAM

Age	4	Calv.Ease	BW	WW	YW	Milk	HPG	Stay	Maint.En.
Wt	1070	9	-3.2	54	90	23	11	13	-3.2
Prog.BW	74	Marb		REA		Bfat			
WR	112	+53		+04		+03			
YR	106	BWt	WWt	WR	ADG	YWt	YR	Scr.	Fr.
Wean Pct.	54%	69	598	112	3.82	1167	110	33	6.0
Cow Eff.	114								

★★★★★ for Low Maintenance, Growth, Marbling, Superior Cow, Calving Ease, Stayability.



98 BECKTON NEBULA A125 N5 

1-A 100% # 1626422 Tat.: BKT3 A125

Birth: 3-15-13

BECKTON NEBULA W778 J4
Ref. N-6

BECKTON ROSE W402 N

DAM

Age	4	Calv.Ease	BW	WW	YW	Milk	HPG	Stay	Maint.En.
Wt	1105	14	-4.8	55	88	12	9	15	1.7
Prog.BW	68	Marb		REA		Bfat			
WR	99	+63		-02		+02			
YR	101	BWt	WWt	WR	ADG	YWt	YR	Scr.	Fr.
Wean Pct.	45%	73	513	96	3.60	1055	100	37	5.0
Cow Eff.	94								

★★★★★ for Low Maintenance, Marbling, Calving Ease, Stayability.

99 BECKTON ORION A482 N2 

2 100% # 1626407 Tat.: BKT3 A482

Birth: 3-29-13

BECKTON JANUS X799 L2
Ref. O-1

BECKTON LARKABA W272 N

DAM

Age	4	Calv.Ease	BW	WW	YW	Milk	HPG	Stay	Maint.En.
Wt	800	14	-6.8	40	65	26	9	14	-3.0
Prog.BW	58	Marb		REA		Bfat			
WR	106	+52		+00		+02			
YR	103	BWt	WWt	WR	ADG	YWt	YR	Scr.	Fr.
Wean Pct.	66%	61	549	99	3.48	1089	101	33	5.5
Cow Eff.	139								

★★★★★ for Low Maintenance, Marbling, Superior Cow, High Cow Efficiency, Calving Ease, Stayability.

97 BECKTON HERITAGE A739 E3 

1-A 100% # 1626250 Tat.: BKT3 A739

Birth: 4-11-13

BECKTON HERITAGE X356 E2
Ref. H-1

BECKTON BELGA S747 EP

DAM

Age	7	Calv.Ease	BW	WW	YW	Milk	HPG	Stay	Maint.En.
Wt	1100	11	-3.7	46	75	18	6	11	-1.0
Prog.BW	62	Marb		REA		Bfat			
WR	103	+63		-05		+02			
YR	103	BWt	WWt	WR	ADG	YWt	YR	Scr.	Fr.
Wean Pct.	51%	76	563	101	3.93	1120	104	34	5.5
Cow Eff.	108								

★★★★★ for Low Maintenance, Marbling, Calving Ease.

100 BECKTON JULIAN A357 E4 

1-A 100% # 1626542 Tat.: BKT3 A357

Birth: 3-25-13

BECKTON JULIAN GG B571
Ref. J-1

BECKTON TAMARA X628 E

DAM

Age	3	Calv.Ease	BW	WW	YW	Milk	HPG	Stay	Maint.En.
Wt	1120	15	-4.4	55	89	20	6	17	-2.5
Prog.BW	63	Marb		REA		Bfat			
WR	108	+63		+18		+03			
YR	105	BWt	WWt	WR	ADG	YWt	YR	Scr.	Fr.
Wean Pct.	47%	63	567	108	3.88	1103	105	35	6.0
Cow Eff.	99								

★★★★★ for Low Maintenance, Growth, Marbling, Rib-eye area, Superior Cow, Calving Ease, Stayability.

• Bulls •

101 **BECKTON SCAMP A084 C4** 

1-A 100% # 1626170 Tat.: BKT3 A084

Birth: 3-13-13

Beckton Scamp T A825
BECKTON SCAMP X494 E3
 Ref. S-1 Beckton Lana S074 EP

Beckton Nebula P P707
 Beckton Lana P685 JO
 Beckton Jet L P491
 Beckton Lana P828 LN

Beckton Copper J E616
 Beckton Ruth E549 TP
 Beckton Champ R1 H024
 Beckton Firefly H314 EP

DAM		Calv.Ease	BW	WW	YW	Milk	HPG	Stay	Maint.En.
Age	10	10	-6.0	37	60	23	9	15	-5.7
Wt	935								
Prog.BW	68								
WR	100								
YR	99								
Wean Pct.	51%								
Cow Eff.	108								
		Marb			REA			Bfat	
		BWt	WWt	WR	ADG	YWt	YR	Scr.	Fr.
		62	481	86	4.10	1059	98	34	5.0

★★★★★ for Low Maintenance, Gainability, Marbling, Calving Ease, Stayability.

103 **BECKTON NEBULA A424 E4** 

1-A 100% # 1626196 Tat.: BKT3 A424

Birth: 3-27-13

Beckton Nebula L P093
BECKTON NEBULA W486 D3
 Ref. N-5 Beckton Belga R716 DM

Beckton Nebula M045
 Beckton Marta M021 LN
 Beckton Dominor ZC M919
 Beckton Belga K285 JL

Beckton Epic K4 N795
BECKTON LANA R205 EP
 Beckton Lana N540 VG

Beckton Epic KJ J722
 Beckton Sierra J789 EP
 Beckton Vegas S1 K316
 Beckton Lana J131 CT

DAM		Calv.Ease	BW	WW	YW	Milk	HPG	Stay	Maint.En.
Age	8	12	-2.0	53	88	13	4	14	-0.9
Wt	1010								
Prog.BW	71								
WR	98								
YR	100								
Wean Pct.	53%								
Cow Eff.	112								
		Marb			REA			Bfat	
		BWt	WWt	WR	ADG	YWt	YR	Scr.	Fr.
		83	537	101	3.71	1075	102	34	5.5

★★★★★ for Low Maintenance, Marbling, Calving Ease, Stayability.

102 **BECKTON NEBULA A659 L5** 

1-A 100% # 1625782 Tat.: BSF3 A659

Birth: 4-5-13

Beckton Nebula PJ S543
BECKTON NEBULA W778 J4
 Ref. N-6 Beckton Lana S197 JT

Beckton Nebula P P707
 Beckton Lana P685 JO
 Beckton Jet L P491
 Beckton Lana P828 LN

Beckton Lancer T A664
BECKTON CHRISTY N626 LN
 Beckton Christy K209 CO

Beckton Lancer 9380
 Beckton Coca 9119 TJ
 Beckton Copper JT G095
 Beckton Christy A111 VQ

DAM		Calv.Ease	BW	WW	YW	Milk	HPG	Stay	Maint.En.
Age	10	16	-7.2	41	69	19	7	16	1.2
Wt	1110								
Prog.BW	63								
WR	102								
YR	101								
Wean Pct.	50%								
Cow Eff.	105								
		Marb			REA			Bfat	
		BWt	WWt	WR	ADG	YWt	YR	Scr.	Fr.
		65	553	99	3.60	1082	100	33	5.0

★★★★★ for Low Maintenance, Marbling, Calving Ease, Stayability.

104 **BECKTON EPIC A821 J6** 

1-A 100% # 1626277 Tat.: BKT3 A821

Birth: 4-20-13

Beckton Epic K4 N795
BECKTON EPIC U749 D5
 Ref. E-2 Beckton Denise R308 DM

Beckton Epic KJ J722
 Beckton Sierra J789 EP
 Beckton Dominor ZC M919
 Beckton Denise L639 JL

Beckton Julio L233
BECKTON LANA T279 JO
 Beckton Lana L923 CD

Beckton Julian G1 J526
 Beckton Rose J725 EP
 Beckton Cody K G701
 Beckton Lana D232 HV

DAM		Calv.Ease	BW	WW	YW	Milk	HPG	Stay	Maint.En.
Age	6	11	-3.8	54	97	19	4	14	1.2
Wt	1035								
Prog.BW	73								
WR	108								
YR	106								
Wean Pct.	57%								
Cow Eff.	120								
		Marb			REA			Bfat	
		BWt	WWt	WR	ADG	YWt	YR	Scr.	Fr.
		71	588	106	3.37	1121	104	33	5.5

★★★★★ for Low Maintenance, Marbling, Rib-eye area, Superior Cow, High Cow Efficiency, Calving Ease, Stayability.



105 **BECKTON HASTEN A170 H5** 

1-A 100% # 1626633 Tat.: BKT3 A170

Birth: 3-18-13

Beckton Hasten U108 J3
BECKTON HASTEN Y069 D4
 Ref. H-2 Beckton Marta P484 DM

Beckton Hasten H S462
 Beckton Encino S456 JC
 Beckton Dominor Z E401
 Beckton Marta K254 LN

Beckton Hasten U108 J3
BECKTON VERNICE Y434 H
 Beckton Vernice U344 WR

Beckton Hasten H S462
 Beckton Encino S456 JC
 Beckton Warrior N645 T1
 Beckton Vernice N200 LN

DAM		Calv.Ease	BW	WW	YW	Milk	HPG	Stay	Maint.En.
Age	2	11	0.2	64	103	13	12	15	-2.1
Wt	735								
Prog.BW	79								
WR	110								
YR	111								
Wean Pct.	68%								
Cow Eff.	144								
		Marb			REA			Bfat	
		BWt	WWt	WR	ADG	YWt	YR	Scr.	Fr.
		79	561	110	4.10	1133	111	31	6.0

★★★★★ for Low Maintenance, Growth, Gainability, Marbling, Superior Cow, High Cow Efficiency, Calving Ease, Stayability.

• Bulls •

106 BECKTON CLIFFTOP A073 C4 

1-A 100% # 1626254 Tat.: BKT3 A073

Birth: 3-12-13

BECKTON CLIFFTOP W692 E3
Ref. C-1

BECKTON EOLA T005 CT
Beckton Eola R280 CH

Beckton Clifftop T C075
Beckton Christy K209 CO
Beckton Epic KM M115
Beckton Lydia M607 LO
Beckton Clifftop T C075
Beckton Christy K209 CO
Beckton Champ R1 H024
Beckton Eola M663 EP

DAM		Calv.Ease	BW	WW	YW	Milk	HPG	Stay	Maint.En.
Age	6	12	-5.1	38	70	29	11	16	-2.4
Wt	1115	Marb +.49		REA +.04		Bfat +.07			
Prog.BW	67	BWt	WWt	WR	ADG	YWt	YR	Scr.	Fr.
WR	108	69	571	102	3.82	1142	106	36	4.5
YR	103								
Wean Pct.	51%								
Cow Eff.	108								

★★★★★ for Low Maintenance, Growth, Marbling, Calving Ease, Stayability.

108 BECKTON CLIFFTOP A461 J4 

1-A 100% # 1626411 Tat.: BKT3 A461

Birth: 3-28-13

BECKTON CLIFFTOP W692 E3
Ref. C-1

BECKTON ROSE W283 J
Beckton Rose P016 LN

Beckton Clifftop T C075
Beckton Christy K209 CO
Beckton Epic KM M115
Beckton Lydia M607 LO
TR Julian LT151
Beckton Minerva L278 LN
Beckton Lancer T7 M089
Beckton Rose M131 HR

DAM		Calv.Ease	BW	WW	YW	Milk	HPG	Stay	Maint.En.
Age	4	11	-2.7	49	87	27	9	15	0.6
Wt	1090	Marb +.61		REA -.01		Bfat +.05			
Prog.BW	70	BWt	WWt	WR	ADG	YWt	YR	Scr.	Fr.
WR	109	76	617	111	3.43	1137	105	36	5.0
YR	103								
Wean Pct.	55%								
Cow Eff.	115								

★★★★★ for Low Maintenance, Growth, Marbling, Calving Ease, Stayability.



109 BECKTON JULIAN A418 N6 

1-A 100% # 1625841 Tat.: BSF3 A418

Birth: 3-27-13

BECKTON JULIAN W743 H5
Ref. J-3

BECKTON ENCINO U063 NB
Beckton Encino S090 JT

Beckton Julian G5 S107
Beckton Julian GJ P535
Beckton Minola P826 DM
Beckton Herald F FA20
Beckton Kit F468 JL
Beckton Nebula M045
Beckton Lakme LA06 JL
Beckton Jet L P491
Beckton Encino P300 LN

DAM		Calv.Ease	BW	WW	YW	Milk	HPG	Stay	Maint.En.
Age	5	15	-6.5	41	69	21	11	15	-3.9
Wt	1100	Marb +.74		REA -.04		Bfat +.03			
Prog.BW	54	BWt	WWt	WR	ADG	YWt	YR	Scr.	Fr.
WR	103	64	555	104	3.76	1119	106	33	5.0
YR	101								
Wean Pct.	50%								
Cow Eff.	106								

★★★★★ for Low Maintenance, Growth, Marbling, Calving Ease, Stayability.

107 BECKTON CLIFFTOP A575 E4 

1-A 100% # 1625929 Tat.: BSF3 A575

Birth: 4-2-13

BECKTON CLIFFTOP W692 E3
Ref. C-1

BECKTON INDIGO W381 E
Beckton Indigo N467 LO

Beckton Clifftop T C075
Beckton Christy K209 CO
Beckton Epic KM M115
Beckton Lydia M607 LO
Beckton Epic K4 N795
Beckton Epic KJ J722
Beckton Sierra J789 EP
Beckton Loki F251
Beckton Indigo H150 LN

DAM		Calv.Ease	BW	WW	YW	Milk	HPG	Stay	Maint.En.
Age	4	8	-3.3	54	102	24	3	15	1.6
Wt	1070	Marb +.72		REA +.02		Bfat +.09			
Prog.BW	75	BWt	WWt	WR	ADG	YWt	YR	Scr.	Fr.
WR	115	67	611	114	3.37	1134	107	41	5.0
YR	112								
Wean Pct.	55%								
Cow Eff.	116								

★★★★★ for Low Maintenance, Growth, Marbling, Superior Cow, High Cow Efficiency, Calving Ease, Stayability.

110 BECKTON EPIC A340 L6 

1-A 100% # 1626349 Tat.: BKT3 A340

Birth: 3-24-13

BECKTON EPIC T330 L5
Ref. E-1

BECKTON COCA U510 LN
Beckton Coca H745 CS

Beckton Epic K4 N795
Beckton Epic KJ J722
Beckton Sierra J789 EP
Beckton Lancer T A664
Beckton Belga D460 KR
Beckton Lancer T A664
Bkt Suffeina A828 DM
Beckton Caesar M D023
Beckton Coca E051 CL

DAM		Calv.Ease	BW	WW	YW	Milk	HPG	Stay	Maint.En.
Age	5	11	-1.7	50	86	17	5	13	2.2
Wt	1160	Marb +.53		REA +.05		Bfat +.02			
Prog.BW	75	BWt	WWt	WR	ADG	YWt	YR	Scr.	Fr.
WR	101	84	538	101	4.05	1101	104	34	5.5
YR	106								
Wean Pct.	46%								
Cow Eff.	98								

★★★★★ for Low Maintenance, Gainability, Marbling, Calving Ease, Stayability.

• Bulls •



111 BECKTON NEW ERA A486 E2 

1-A 100% # 1626233 Tat.: BKT3 A486

Birth: 3-29-13

BECKTON NEW ERA Y194
Ref. N-9

- Beckton Nebula P P707
- Beckton Nebula M045
- Beckton Lana M809 EP
- Beckton Justice C1 R483
- BKT Larkeisa T310 JC
- BKT Larkeisa R775 JC

BECKTON KIT S424 EP

- Beckton Epic KJ J722
- Beckton Epic K F075
- Beckton Lana F891 JL
- Beckton Julian GG B571
- Beckton Kit F468 JL
- Beckton Kit A517 NP

DAM		Calv.Ease	BW	WW	YW	Milk	HPG	Stay	Maint.En.
Age	7	12	-1.9	60	96	18	9	14	-6.7
Wt	1055	Marb +0.74		REA +0.07		Bfat +0.05			
Prog.BW	70	BWt	WWt	WR	ADG	YWt	YR	Scr.	Fr.
WR	101	79	583	105	3.26	1114	103	35	5.0
YR	98								
Wean Pct.	55%								
Cow Eff.	116								

★★★★★ for Low Maintenance, Marbling, High Cow Efficiency, Calving Ease, Stayability.

112 BECKTON JULIAN A506 E6 

1-A 100% # 1626212 Tat.: BKT3 A506

Birth: 3-30-13

BECKTON JULIAN W743 H5
Ref. J-3

- Beckton Julian G5 S107
- Beckton Julian GJ P535
- Beckton Minola P826 DM
- Beckton Herald F FA20
- Beckton Kit F468 JL

BECKTON EMERA R709 EP

- Beckton Epic KM M115
- Beckton Epic K F075
- Beckton Minerva F495 CH
- Beckton Epic K F075
- Beckton Emera M259 EP
- Beckton Emera D880 CB

DAM		Calv.Ease	BW	WW	YW	Milk	HPG	Stay	Maint.En.
Age	8	10	-3.9	50	83	21	12	14	-2.4
Wt	1135	Marb +0.58		REA -0.13		Bfat +0.03			
Prog.BW	70	BWt	WWt	WR	ADG	YWt	YR	Scr.	Fr.
WR	104	68	550	99	3.48	1066	99	35	5.0
YR	105								
Wean Pct.	48%								
Cow Eff.	102								

★★★★★ for Low Maintenance, Marbling, Superior Cow, Calving Ease, Stayability.

114 BECKTON NEBULA A358 E4 

1-A 100% # 1626294 Tat.: BKT3 A358

Birth: 3-25-13

BECKTON NEBULA W486 D3
Ref. N-5

- Beckton Nebula L P093
- Beckton Nebula M045
- Beckton Marta M021 LN
- Beckton Dominor ZC M919
- Beckton Belga R716 DM
- Beckton Belga K285 JL

BECKTON MONA T558 EP

- Beckton Epic KM M115
- Beckton Epic K F075
- Beckton Minerva F495 CH
- Beckton Vegas S1 K316
- Beckton Mona P199 VG
- Beckton Mona L618 LR

DAM		Calv.Ease	BW	WW	YW	Milk	HPG	Stay	Maint.En.
Age	6	12	-4.3	54	89	18	10	15	-1.5
Wt	990	Marb +0.51		REA +0.04		Bfat +0.03			
Prog.BW	63	BWt	WWt	WR	ADG	YWt	YR	Scr.	Fr.
WR	104	71	598	107	3.09	1052	97	33	5.5
YR	102								
Wean Pct.	60%								
Cow Eff.	127								

★★★★★ for Low Maintenance, Marbling, High Cow Efficiency, Calving Ease, Stayability.

113 BECKTON NEBULA A537 V5 

1-A 100% # 1626151 Tat.: BKT3 A537

Birth: 3-31-13

BECKTON NEBULA W778 J4
Ref. N-6

- Beckton Nebula PJ S543
- Beckton Nebula P P707
- Beckton Lana P685 JO
- Beckton Jet L P491
- Beckton Lana P828 LN

BECKTON BELGA L261 VG

- Beckton Vegas PK F485
- Beckton Vegas P D462
- Beckton Lakme D399 KR
- Beckton Galahad KK B186
- Beckton Belga D054 GL
- Beckton Belga B754 RN

DAM		Calv.Ease	BW	WW	YW	Milk	HPG	Stay	Maint.En.
Age	12	17	-9.4	37	57	23	8	13	-1.0
Wt	1105	Marb +0.52		REA -0.10		Bfat +0.01			
Prog.BW	60	BWt	WWt	WR	ADG	YWt	YR	Scr.	Fr.
WR	105	58	583	109	3.54	1078	102	37	5.5
YR	100								
Wean Pct.	51%								
Cow Eff.	107								

★★★★★ for Low Maintenance, Marbling, Calving Ease, Stayability.

115 BECKTON NEW ERA A420 E2 

1-A 100% # 1626511 Tat.: BKT3 A420

Birth: 3-27-13

BECKTON NEW ERA Y194
Ref. N-9

- Beckton Nebula P P707
- Beckton Nebula M045
- Beckton Lana M809 EP
- Beckton Justice C1 R483
- BKT Larkeisa T310 JC
- BKT Larkeisa R775 JC

BECKTON LANA X284 E

- Beckton Epic T330 L5
- Beckton Epic K4 N795
- Beckton Belga K202 LN
- Beckton Loki C M740
- Beckton Lana R450 LO
- Beckton Lana M372 WR

DAM		Calv.Ease	BW	WW	YW	Milk	HPG	Stay	Maint.En.
Age	3	15	-4.7	62	103	19	10	15	-3.3
Wt	755	Marb +0.72		REA -0.10		Bfat +0.04			
Prog.BW	58	BWt	WWt	WR	ADG	YWt	YR	Scr.	Fr.
WR	112	65	586	112	3.37	1091	104	35	6.0
YR	104								
Wean Pct.	72%								
Cow Eff.	152								

★★★★★ for Low Maintenance, Marbling, Superior Cow, High Cow Efficiency, Calving Ease, Stayability.

• Bulls •

116 BECKTON ACCENT A060 L3 

1-A 100% # 1626205 Tat.: BKT3 A060

Birth: 3-10-13

BECKTON ACCENT W180 C2
Ref. A-2

BECKTON KIT R441 LN

DAM

Age	8	Calv.Ease	BW	WW	YW	Milk	HPG	Stay	Maint.En.
Wt	1050	12	-4.8	53	81	17	9	14	-4.4
Prog.BW	65	Marb		+4.8	REA		+4.1	Bfat +.03	
WR	101	BWt	WWt	WR	ADG	YWt	YR	Scr.	Fr.
YR	95	68	562	105	2.98	998	94	36	5.5
Wean Pct.	54%								
Cow Eff.	113								

Beckton Cody K1 P014
Beckton Rose M126 WR
Beckton Cherokee N N479
Beckton Christy N740 HR
Beckton Lancer T A664
Bkt Suffeina A828 DM
Beckton Julian GG B571
Beckton Kit A517 NP
Beckton Christy R046 CQ
Beckton Lancer F442 T
Beckton Kit F468 JL

★★★★★ for Low Maintenance, Marbling, Rib-eye area, Calving Ease, Stayability.



117 BECKTON NEBULA A736 E4 

1-A 100% # 1626181 Tat.: BKT3 A736

Birth: 4-11-13

BECKTON NEBULA T398 V3
Ref. N-4

BKT PINE MARIE P351 EP

DAM

Age	9	Calv.Ease	BW	WW	YW	Milk	HPG	Stay	Maint.En.
Wt	1100	8	-3.0	55	89	17	11	11	-6.7
Prog.BW	80	Marb		+4.5	REA		+0.7	Bfat +.03	
WR	109	BWt	WWt	WR	ADG	YWt	YR	Scr.	Fr.
YR	108	68	593	106	2.87	1090	101	35	5.5
Wean Pct.	54%								
Cow Eff.	114								

Beckton Nebula L P093
Beckton Nebula M045
Beckton Marta M021 LN
Beckton Vegas PK F485
Beckton Minerva F433 VG
Beckton Epic K J722
Beckton Epic K F075
Beckton Lana F891 JL
Beckton Herald FV J537
BKT Pine Marie L002 HR
BKT Pine Marie J931 RN

★★★★★ for Low Maintenance, Marbling, Superior Cow, Calving Ease.

119 BECKTON NEBULA A333 L4 

1-A 100% # 1625781 Tat.: BSF3 A333

Birth: 3-24-13

BECKTON NEBULA W486 D3
Ref. N-5

BECKTON INDIGO N467 LO

DAM

Age	10	Calv.Ease	BW	WW	YW	Milk	HPG	Stay	Maint.En.
Wt	1100	9	-2.4	52	87	14	6	17	-0.1
Prog.BW	77	Marb		+6.3	REA		-0.2	Bfat +.03	
WR	105	BWt	WWt	WR	ADG	YWt	YR	Scr.	Fr.
YR	106	74	551	99	3.26	1014	94	34	5.0
Wean Pct.	50%								
Cow Eff.	105								

Beckton Nebula L P093
Beckton Nebula M045
Beckton Marta M021 LN
Beckton Dominor ZC M919
Beckton Belga K285 JL
Beckton Lancer TZ D525
Bkt Pine Marie D126 JL
Beckton Lancer TE F363
Beckton Indigo F376 CT
Beckton Loki F251
Beckton Indigo H150 LN
Beckton Belga R716 DM

★★★★★ for Low Maintenance, Marbling, Superior Cow, Calving Ease, Stayability.

118 BECKTON HERITAGE A431 H3 

1-A 100% # 1626379 Tat.: BKT3 A431

Birth: 3-27-13

BECKTON HERITAGE X356 E2
Ref. H-1

BECKTON MONA W045 H

DAM

Age	4	Calv.Ease	BW	WW	YW	Milk	HPG	Stay	Maint.En.
Wt	880	10	-5.1	52	83	17	7	12	-4.1
Prog.BW	60	Marb		+8.2	REA		-.04	Bfat +.03	
WR	101	BWt	WWt	WR	ADG	YWt	YR	Scr.	Fr.
YR	99	65	573	103	3.32	1054	98	37	5.5
Wean Pct.	63%								
Cow Eff.	132								

Beckton Heritage N013
Beckton Hustler C2 L079
Beckton Lana L007 JL
Beckton Epic K4 N795
Beckton Lana E136 TP
Beckton Heritage T270 J2
Beckton Heritage N013
Beckton Coca P602 JL
Beckton Justice CH M056
Beckton Mona L563 VG
Beckton Lana S489 EP

★★★★★ for Low Maintenance, Marbling, High Cow Efficiency, Calving Ease.

120 BECKTON JULIAN A187 L6 

1-A 100% # 1625823 Tat.: BSF3 A187

Birth: 3-18-13

BECKTON JULIAN X465 J5
Ref. J-4

BECKTON LANA S417 LN

DAM

Age	7	Calv.Ease	BW	WW	YW	Milk	HPG	Stay	Maint.En.
Wt	1150	8	-0.2	55	91	19	11	14	-2.7
Prog.BW	75	Marb		+5.2	REA		+0.4	Bfat +.00	
WR	106	BWt	WWt	WR	ADG	YWt	YR	Scr.	Fr.
YR	102	81	564	106	2.75	990	94	36	5.5
Wean Pct.	49%								
Cow Eff.	103								

Beckton Julian G5 S107
Beckton Julian GJ P535
Beckton Minola P826 DM
Beckton Julian GG B571
Bkt Suffeina A828 DM
Beckton Lancer T7 M089
Beckton Lancer F442 T
Beckton Tamara G141 HE
Beckton Cobalt K Z100
Beckton Lana 9077 DT
Beckton Lancer T7 M089
Beckton Lana C954 CB

★★★★★ for Low Maintenance, Marbling, Calving Ease, Stayability.

• Bulls •

121 BECKTON NEBULA A296 J3

1-A 100% # 1625967 Tat.: BSF3 A296



Birth: 3-23-13

Beckton Nebula M045
 Beckton Nebula P P707
 Ref. N-2 Beckton Lana M809 EP

Beckton Neptune R2 K065
 Beckton Belga K285 JL
 Beckton Epic K1 K863
 Beckton Lana K253 DM

Beckton Justice C1 R483
 Beckton Christy W827 J
 Beckton Christy R434 CD

Beckton Justice CH M056
 Beckton Tamara J124 HR
 Beckton Cody KH M390
 Beckton Christy M362 WR

DAM		Calv.Ease	BW	WW	YW	Milk	HPG	Stay	Maint.En.
Age	4	16	-9.3	52	91	20	10	14	-4.7
Wt	1040	Marb +.67		REA -.05		Bfat +.04			
Prog.BW	56	BWt	WWt	WR	ADG	YWt	YR	Scr.	Fr.
WR	99	50	551	99	3.88	1098	102	35	5.0
YR	102								
Wean Pct.	51%								
Cow Eff.	108								

★★★★★ for Low Maintenance, Marbling, Calving Ease, Stayability.

123 BECKTON CLIFFTOP A206 C4

1-A 100% # 1626368 Tat.: BKT3 A206



Birth: 3-19-13

BKT Clifftop TP R288
 Beckton Clifftop W692 E3
 Ref. C-1 Beckton Lydia S274 EP

Beckton Clifftop T C075
 Beckton Christy K209 CO
 Beckton Epic KM M115
 Beckton Lydia M607 LO

Beckton Clifftop T3 N800
 Beckton Rose U726 CT
 Beckton Rose R545 DM

Bkt Clifftop TV G672
 Beckton Lana J384 CD
 Beckton Dominor ZC M919
 Beckton Rose G688 CD

DAM		Calv.Ease	BW	WW	YW	Milk	HPG	Stay	Maint.En.
Age	5	11	-6.6	33	67	25	8	15	-8.7
Wt	54	Marb +.64		REA -.03		Bfat +.08			
Prog.BW	54	BWt	WWt	WR	ADG	YWt	YR	Scr.	Fr.
WR	91	60	506	95	3.88	1040	98	34	4.5
YR	93								
Wean Pct.	%								
Cow Eff.									

★★★★★ for Low Maintenance, Marbling, Calving Ease, Stayability.

122 BECKTON JULIAN A820 E5

1-A 100% # 1626419 Tat.: BKT3 A820



Birth: 4-20-13

Beckton Julian GJ P535
 Beckton Julian G5 S107
 Ref. J-2 Beckton Minola P826 DM

Beckton Julian 7526G
 Beckton Mona D086 JL
 Beckton Dominor ZC M919
 Beckton Minola M641 WR

Beckton Emcee S466
 Beckton Serena W366 E
 Beckton Serena N088 WR

Beckton Epic K4 N795
 Beckton Larkaba H798 WR
 Beckton Warrior TD L493
 Beckton Serena L591 VG

DAM		Calv.Ease	BW	WW	YW	Milk	HPG	Stay	Maint.En.
Age	4	11	-3.8	46	81	21	12	13	-3.2
Wt	890	Marb +.51		REA -.04		Bfat +.05			
Prog.BW	61	BWt	WWt	WR	ADG	YWt	YR	Scr.	Fr.
WR	105	69	614	110	3.93	1206	112	35	5.0
YR	106								
Wean Pct.	67%								
Cow Eff.	141								

★★★★★ for Low Maintenance, Growth, Marbling, Superior Cow, High Cow Efficiency, Calving Ease, Stayability.

124 BECKTON JULIAN A602 N6

1-A 100% # 1625820 Tat.: BSF3 A602



Birth: 4-3-13

Beckton Julian G5 S107
 Beckton Julian W743 H5
 Ref. J-3 Beckton Kit L399 HR

Beckton Julian GJ P535
 Beckton Minola P826 DM
 Beckton Herald F FA20
 Beckton Kit F468 JL

Beckton Nebula E P084
 Beckton Christy S151 NB
 Beckton Christy P333 CH

Beckton Nebula M045
 BKT Pine Marie M119 EP
 Beckton Champ R1 H024
 Beckton Christy K209 CO

DAM		Calv.Ease	BW	WW	YW	Milk	HPG	Stay	Maint.En.
Age	7	14	-5.0	39	64	20	12	16	-7.7
Wt	920	Marb +.55		REA +.02		Bfat +.05			
Prog.BW	65	BWt	WWt	WR	ADG	YWt	YR	Scr.	Fr.
WR	98	69	556	100	3.88	1094	101	36	5.0
YR	97								
Wean Pct.	60%								
Cow Eff.	127								

★★★★★ for Low Maintenance, Marbling, High Cow Efficiency, Calving Ease, Stayability.



125 BECKTON NEW ERA A352 W2

1-A 100% # 1626493 Tat.: BKT3 A352



Birth: 3-25-13

Beckton Nebula P P707
 Beckton New Era Y194
 Ref. N-9 BKT Larkeisa T310 JC

Beckton Nebula M045
 Beckton Lana M809 EP
 Beckton Justice C1 R483
 BKT Larkeisa R775 JC

Beckton Warrior U636 J5
 Beckton Ruth X134 W
 Beckton Ruth U325 WR

Beckton Warrior N645 T1
 Beckton Lydia H159 JL
 Beckton Warrior N645 T1
 Beckton Ruth M047 NP

DAM		Calv.Ease	BW	WW	YW	Milk	HPG	Stay	Maint.En.
Age	3	12	-3.5	68	110	15	13	15	-2.6
Wt	980	Marb +.76		REA -.16		Bfat +.03			
Prog.BW	65	BWt	WWt	WR	ADG	YWt	YR	Scr.	Fr.
WR	108	65	565	108	4.05	1104	105	34	5.0
YR	105								
Wean Pct.	54%								
Cow Eff.	113								

★★★★★ for Low Maintenance, Growth, Gainability, Marbling, Superior Cow, Calving Ease, Stayability.

• Bulls •

126 BECKTON WARRIOR A266 N6 1-A 100% # 1626585 Tat.: BKT3 A266



Birth: 3-21-13

Beckton Warrior W534 N4
BECKTON WARRIOR Y108 E5
 Ref. W-3 Beckton Susan W058 E

Beckton Nebula T269 E2
BECKTON COCA Y114 N
 Beckton Coca U187 JD

Beckton Warrior C1 S337
 BKT Larkeisa S055 NB
 Beckton Epic T330 L5
 Beckton Susan T048 NB
 Beckton Nebula M045
 Beckton Ruth M967 EP
 TR Julian RT561
 Beckton Coca R490 JC

DAM		Calv.Ease	BW	WW	YW	Milk	HPG	Stay	Maint.En.
Age	2	15	-4.2	55	89	16	10	15	-4.0
Wt	785	Marb +.60		REA +.21		Bfat +.05			
Prog.BW	64	BWt	WWt	WR	ADG	YWt	YR	Scr.	Fr.
WR	107	64	545	107	3.99	1102	108	36	5.0
YR	108								
Wean Pct.	62%								
Cow Eff.	130								

★★★★★ for Low Maintenance, Growth, Marbling, Rib-eye area, Superior Cow, High Cow Efficiency, Calving Ease, Stayability.

128 BECKTON ACCENT A516 E3 1-A 100% # 1626441 Tat.: BKT3 A516



Birth: 3-30-13

Beckton Cody K1 P014
BECKTON ACCENT W180 C2
 Ref. A-2 Beckton Christy R046 CQ

Beckton Epic K4 N795
BECKTON LAKME W569 E
 Beckton Lakme R626 LN

Beckton Cody KH M390
 Beckton Rose M126 WR
 Beckton Cherokee N N479
 Beckton Christy N740 HR
 Beckton Epic KJ J722
 Beckton Sierra J789 EP
 Beckton Lancer T7 M089
 Beckton Lakme M669 EP

DAM		Calv.Ease	BW	WW	YW	Milk	HPG	Stay	Maint.En.
Age	4	9	-1.7	58	98	21	4	13	5.1
Wt	1085	Marb +.54		REA +.24		Bfat +.05			
Prog.BW	73	BWt	WWt	WR	ADG	YWt	YR	Scr.	Fr.
WR	101	80	539	97	3.65	1048	97	35	5.5
YR	102								
Wean Pct.	48%								
Cow Eff.	101								

★★★★★ for Marbling, Rib-eye area, Calving Ease, Stayability.

127 BECKTON LEGEND A354 E2 1-A 100% # 1626180 Tat.: BKT3 A354



Birth: 3-25-13

Beckton Lancer F442 T
BECKTON LEGEND S670
 Ref. L-1 Beckton Kit F468 JL

Beckton Epic KJ J722
BECKTON COCA P328 EP
 Beckton Coca J276 CL

Beckton Lancer T A664
 Bkt Suffeina A828 DM
 Beckton Julian GG B571
 Beckton Kit A517 NP
 Beckton Epic K F075
 Beckton Lana F891 JL
 Beckton Clipper KC D400
 Beckton Coca F276 HV

DAM		Calv.Ease	BW	WW	YW	Milk	HPG	Stay	Maint.En.
Age	9	10	-2.7	45	67	13	8	11	-8.4
Wt	1330	Marb +.75		REA +.25		Bfat +.04			
Prog.BW	71	BWt	WWt	WR	ADG	YWt	YR	Scr.	Fr.
WR	104	75	521	93	3.99	1039	96	34	5.0
YR	102								
Wean Pct.	39%								
Cow Eff.	83								

★★★★★ for Low Maintenance, Marbling, Rib-eye area, Calving Ease.

129 BECKTON CLIFFTOP A526 L4 1-A 100% # 1625830 Tat.: BSF3 A526



Birth: 3-31-13

BKT Clifftop TP R288
BECKTON CLIFFTOP W692 E3
 Ref. C-1 Beckton Lydia S274 EP

Beckton Lasso P741
BKT PINE MARIE S802 LO
 BKT Pine Marie P475 LN

Beckton Clifftop T C075
 Beckton Christy K209 CO
 Beckton Epic KM M115
 Beckton Lydia M607 LO
 Beckton Lancer T1 H080
 Beckton Ruth G534 NP
 Beckton Lancer T4 J536
 Bkt Pine Marie LC30 CD

DAM		Calv.Ease	BW	WW	YW	Milk	HPG	Stay	Maint.En.
Age	7	11	-5.8	34	71	28	11	14	-0.7
Wt	1105	Marb +.65		REA -.06		Bfat +.06			
Prog.BW	70	BWt	WWt	WR	ADG	YWt	YR	Scr.	Fr.
WR	105	65	515	96	3.82	1053	100	37	5.0
YR	107								
Wean Pct.	47%								
Cow Eff.	98								

★★★★★ for Low Maintenance, Marbling, Superior Cow, Calving Ease, Stayability.



130 BECKTON NEBULA A549 D4 1-A 100% # 1625785 Tat.: BSF3 A549



Birth: 4-1-13

Beckton Nebula L P093
BECKTON NEBULA W486 D3
 Ref. N-5 Beckton Belga R716 DM

Beckton Dominor ZC M919
BECKTON LANA P026 DM
 Beckton Lana M552 WR

Beckton Nebula M045
 Beckton Marta M021 LN
 Beckton Dominor ZC M919
 Beckton Belga K285 JL
 Beckton Dominor Z E401
 Beckton Barmaid J012 CO
 Beckton Warrior T C371
 Beckton Lana J235 JL

DAM		Calv.Ease	BW	WW	YW	Milk	HPG	Stay	Maint.En.
Age	9	10	-5.1	42	74	15	11	16	-3.9
Wt	1025	Marb +.47		REA +.05		Bfat +.01			
Prog.BW	67	BWt	WWt	WR	ADG	YWt	YR	Scr.	Fr.
WR	105	63	544	98	3.71	1054	98	37	5.0
YR	105								
Wean Pct.	53%								
Cow Eff.	112								

★★★★★ for Low Maintenance, Marbling, Superior Cow, Calving Ease, Stayability.

• Bulls •

131 BECKTON NEW ERA A332 E2 

1-A 100% # 1626416 Tat.: BKT3 A332
 Birth: 3-24-13
 Beckton Nebula P P707
BECKTON NEW ERA Y194
 Ref. N-9 BKT Larkeisa T310 JC
 Beckton Nebula M045
 Beckton Lana M809 EP
 Beckton Justice C1 R483
 BKT Larkeisa R775 JC
 Beckton Epic K4 N795
 Beckton Larkaba H798 WR
BECKTON ROSE W346 E
 Beckton Emcee S466
 Beckton Rose L083 LN
 Beckton Lancer T4 J536
 Beckton Rose J152 LN

DAM		Calv.Ease	BW	WW	YW	Milk	HPG	Stay	Maint.En.
Age	4	13	-6.2	49	83	21	9	14	-2.4
Wt	1000	Marb +0.67		REA -0.06		Bfat +0.06			
Prog.BW	65	BWt	WWt	WR	ADG	YWt	YR	Scr.	Fr.
WR	98	64	526	94	3.43	1046	97	36	5.5
YR	98								
Wean Pct.	51%								
Cow Eff.	107								

★★★★★ for Low Maintenance, Marbling, Calving Ease, Stayability.

134 BECKTON ORION A799 N2 

1-A 100% # 1625945 Tat.: BSF3 A799
 Birth: 4-17-13
 Beckton Roman J S158
BECKTON JANUS X799 L2
 Ref. O-1 Beckton Sierra K557 LO
 TR Romeo NT379
 Beckton Belga K285 JL
 Beckton Loki F251
 Beckton Sierra C157 CL
 Beckton Nebula M045
 Beckton Marta M021 LN
BECKTON INDIGO W626 N
 Beckton Nebula L P093
 Beckton Indigo T832 HT
 Beckton Heritage N013
 Beckton Indigo D780 JL

DAM		Calv.Ease	BW	WW	YW	Milk	HPG	Stay	Maint.En.
Age	4	9	-0.4	66	104	15	8	12	-0.4
Wt	1010	Marb +0.46		REA +0.12		Bfat +0.01			
Prog.BW	80	BWt	WWt	WR	ADG	YWt	YR	Scr.	Fr.
WR	113	80	561	101	3.43	1066	99	34	6.0
YR	106								
Wean Pct.	54%								
Cow Eff.	113								

★★★★★ for Low Maintenance, Marbling, Superior Cow, Calving Ease.

132 BECKTON NEBULA A870 C3 

1-A 100% # 1625966 Tat.: BSF3 A870
 Birth: 4-26-13
 Beckton Nebula M045
BECKTON NEBULA T269 E2
 Ref. N-3 Beckton Ruth M967 EP
 Beckton Neptune R2 K065
 Beckton Belga K285 JL
 Beckton Epic KN H110
 Beckton Ruth A905 SG
BECKTON MINOLA W808 C
 BKT Clifftop TP R288
 Beckton Clifftop T C075
 Beckton Christy K209 CO
 Beckton Cody KH M390
 Beckton Minola M310 CD

DAM		Calv.Ease	BW	WW	YW	Milk	HPG	Stay	Maint.En.
Age	4	11	-2.8	52	83	18	6	14	-3.6
Wt	1010	Marb +0.42		REA +0.06		Bfat +0.04			
Prog.BW	72	BWt	WWt	WR	ADG	YWt	YR	Scr.	Fr.
WR	110	76	591	106	3.65	1125	104	33	5.5
YR	102								
Wean Pct.	57%								
Cow Eff.	119								

★★★★★ for Low Maintenance, Marbling, High Cow Efficiency, Calving Ease, Stayability.



133 BECKTON JULIAN A445 L6 

1-A 100% # 1626324 Tat.: BKT3 A445
 Birth: 3-28-13
 Beckton Julian G5 S107
BECKTON JULIAN W743 H5
 Ref. J-3 Beckton Kit L399 HR
 Beckton Julian GJ P535
 Beckton Minola P826 DM
 Beckton Herald F FA20
 Beckton Kit F468 JL
BECKTON LARKABA U153 LE
 Beckton Legend S670
 Beckton Lancer F442 T
 Beckton Kit F468 JL
 Beckton Epic K4 N795
 Beckton Larkaba D170 JV

DAM		Calv.Ease	BW	WW	YW	Milk	HPG	Stay	Maint.En.
Age	5	10	-3.0	46	76	17	10	15	-6.7
Wt	965	Marb +0.73		REA +0.05		Bfat +0.04			
Prog.BW	64	BWt	WWt	WR	ADG	YWt	YR	Scr.	Fr.
WR	97	70	501	94	3.71	1009	95	35	5.5
YR	99								
Wean Pct.	52%								
Cow Eff.	109								

★★★★★ for Low Maintenance, Marbling, Calving Ease, Stayability.

135 BECKTON EPIC A786 L7 

1-A 100% # 1625767 Tat.: BSF3 A786
 Birth: 4-15-13
 Beckton Epic T330 L5
BECKTON EPIC X330 L6
 Ref. E-3 Beckton Kit R503 LN
 Beckton Epic K4 N795
 Beckton Belga K202 LN
 Beckton Lancer F442 T
 Beckton Kit F468 JL
BECKTON INDIGO LC22 LO
 Beckton Loki F251
 Beckton Indigo E370 RN
 Beckton Lancer TZ D525
 Bkt Pine Marie D126 JL
 Beckton Ranger H Z095
 Beckton Indigo A735 LN

DAM		Calv.Ease	BW	WW	YW	Milk	HPG	Stay	Maint.En.
Age	12	9	-3.2	50	81	17	6	15	-4.9
Wt	1280	Marb +0.71		REA +0.11		Bfat +0.03			
Prog.BW	75	BWt	WWt	WR	ADG	YWt	YR	Scr.	Fr.
WR	106	71	590	111	3.37	1105	105	32	5.5
YR	101								
Wean Pct.	45%								
Cow Eff.	94								

★★★★★ for Low Maintenance, Marbling, Calving Ease, Stayability.

• Bulls •

136 **BSF NEBULA A041 N5** 

1-B 99% # 1626699 Tat.: BKB3 A041

Birth: 3-8-13

BECKTON NEBULA Y036 N4
Ref. N-8

- Beckton Nebula W065 C3
- Beckton Rose W402 N
- Beckton Nebula T269 E2
- Beckton Lana T104 CT
- Beckton Nebula L P093
- Beckton Rose L311 LN
- Beckton Nebula T269 E2
- Beckton Firefly T006 DM
- Beckton Warrior T248 L5
- BSF Lanette T717 JL

BSF LANETTE Y017 N
BSF Lanette W025 W

DAM		Calv.Ease	BW	WW	YW	Milk	HPG	Stay	Maint.En.
Age	2	12	-4.5	52	89	15	11	17.5	-3.9
Wt	780	Marb +0.54		REA +0.23		Bfat +0.04			
Prog.BW	61	BWt	WWt	WR	ADG	YWt	YR	Scr.	Fr.
WR	106	61	541	106	4.16	1136	111	36	5.0
YR	111								
Wean Pct.	62%								
Cow Eff.	130								

★★★★★ for Low Maintenance, Growth, Gainability, Marbling, Rib-eye area, Superior Cow, High Cow Efficiency, Calving Ease, Stayability.

139 **BSF EMPEROR A327 J4** 

99% # Tat.: BSF3 A327

Birth: 3-24-13

BECKTON EMPEROR Y459 J3
Ref. E-4

- Beckton Emperor T641 E2
- Beckton Indigo S354 JT
- Beckton Emperor R100
- Beckton Vernice R416 EP
- Beckton Jet L P491
- Beckton Indigo P676 LN
- Beckton Justice CH M056
- Beckton Tamara J124 HR
- Beckton Nebula M045
- BSF Regus M043 JC

BSF NEBULANN T046 JC
BSF Nebulann R664 NB

DAM		Calv.Ease	BW	WW	YW	Milk	HPG	Stay	Maint.En.
Age	6	13.5	-6.2	39	62	19.5	8.5	16	-0.9
Wt	1085	Marb +0.61		REA +0.05		Bfat -0.01			
Prog.BW	59	BWt	WWt	WR	ADG	YWt	YR	Scr.	Fr.
WR	110	58	580	109	3.65	1090	103	41	4.5
YR	104								
Wean Pct.	53%								
Cow Eff.	113								

★★★★★ for Low Maintenance, Marbling, Superior Cow, Calving Ease, Stayability.

137 **BSF EPIC A832 J6** 

99% # Tat.: BSF3 A832

Birth: 4-21-13

BECKTON EPIC U749 D5
Ref. E-2

- Beckton Epic K4 N795
- Beckton Denise R308 DM
- Beckton Epic KJ J722
- Beckton Sierra J789 EP
- Beckton Dominor ZC M919
- Beckton Denise L639 JL
- Beckton Justice CH M056
- Beckton Tamara M878 JC
- Beckton Justice C K449
- BSF Regus J698

BSF JUSTICIA T087 JC
BSF Justicia R147 JC

DAM		Calv.Ease	BW	WW	YW	Milk	HPG	Stay	Maint.En.
Age	6	13.5	-4.4	46.5	88	19.5	8	14	7.3
Wt	995	Marb +0.49		REA +0.39		Bfat +0.03			
Prog.BW	63	BWt	WWt	WR	ADG	YWt	YR	Scr.	Fr.
WR	113	63	603	108	3.48	1141	106	34	5.5
YR	109								
Wean Pct.	61%								
Cow Eff.	128								

★★★★★ for Growth, Marbling, Rib-eye area, Superior Cow, High Cow Efficiency, Calving Ease, Stayability.

140 **BSF CLIFFTOP A853 L4** 

99% # Tat.: BSF3 A853

Birth: 4-23-13

BECKTON CLIFFTOP W692 E3
Ref. C-1

- BKT Clifftop TP R288
- Beckton Lydia S274 EP
- Beckton Clifftop T C075
- Beckton Christy K209 CO
- Beckton Epic KM M115
- Beckton Lydia M607 LO
- Beckton Loki F251
- BKT Larkeisa J051 CK
- Beckton Kannon D202
- BSF Regus D524

BSF LOKETTA R368 LO
BSF Regus F700

DAM		Calv.Ease	BW	WW	YW	Milk	HPG	Stay	Maint.En.
Age	8	11	-3.1	42	73.5	19.5	7.5	15.5	-0.3
Wt	1050	Marb +0.43		REA +0.10		Bfat +0.07			
Prog.BW	73	BWt	WWt	WR	ADG	YWt	YR	Scr.	Fr.
WR	98	71	549	99	3.71	1112	103	35	5.0
YR	95								
Wean Pct.	52%								
Cow Eff.	110								

★★★★★ for Low Maintenance, Marbling, Calving Ease, Stayability.

138 **BSF CLIFFTOP A315 J4** 

1-B 99% # 1625806 Tat.: BSF3 A315

Birth: 3-23-13

BECKTON CLIFFTOP W692 E3
Ref. C-1

- BKT Clifftop TP R288
- Beckton Lydia S274 EP
- Beckton Clifftop T C075
- Beckton Christy K209 CO
- Beckton Epic KM M115
- Beckton Lydia M607 LO
- Beckton Justice G302
- Bkt Larkabel C742 CF
- Beckton Lancer F442 T
- BSF Regus J155

BSF JUSTICIA R553 JC
BSF Regus L104 LN

DAM		Calv.Ease	BW	WW	YW	Milk	HPG	Stay	Maint.En.
Age	8	10	-1.9	62	104	18	10	13	-2.0
Wt	1165	Marb +0.55		REA +0.07		Bfat +0.05			
Prog.BW	75	BWt	WWt	WR	ADG	YWt	YR	Scr.	Fr.
WR	106	80	657	118	3.65	1113	103	34	4.5
YR	105								
Wean Pct.	56%								
Cow Eff.	119								

★★★★★ for Low Maintenance, Marbling, Superior Cow, High Cow Efficiency, Calving Ease, Stayability.

141 **BSF LANCER A628 J5** 

99% # Tat.: BSF3 A628

Birth: 4-4-13

BECKTON LANCER T371 H4
Ref. L-2

- Beckton Lancer F442 T
- Beckton Coca F276 HV
- Beckton Lancer T A664
- Bkt Suffeina A828 DM
- Leachman Heavenly 8141
- Beckton Coca B112 CB
- Beckton Justice C K449
- Beckton Ruth K802 HD
- Beckton Herald FN K641
- BSF Regus K745 CT

BSF JUSTICIA P007
BSF Regus M024 HR

DAM		Calv.Ease	BW	WW	YW	Milk	HPG	Stay	Maint.En.
Age	9	11	-3.1	46.5	82.5	16	7	11.5	1.5
Wt	1045	Marb +0.16		REA +0.02		Bfat -0.03			
Prog.BW	63	BWt	WWt	WR	ADG	YWt	YR	Scr.	Fr.
WR	100	60	561	101	3.48	1081	100	34	5.0
YR	99								
Wean Pct.	54%								
Cow Eff.	113								

★★★★★ for Low Maintenance, Marbling, Calving Ease.

• Bulls •



144 **BSF CLIFFTOP A080 J4** 

99% # Tat.: BSF3 A080
 Birth: 3-13-13
 BKT Clifftop TP R288
BECKTON CLIFFTOP W692 E3
 Ref. C-1 Beckton Lydia S274 EP
 Beckton Clifftop T C075
 Beckton Christy K209 CO
 Beckton Epic KM M115
 Beckton Lydia M607 LO
 Beckton Julian G1 J526
 Beckton Barona J591 EP
 Beckton Jules L429
BSF VIOLET S326 JE
 BSF Violet N382 VG
 Beckton Vegas S1 K316
 BSF Red H119

DAM		Calv.	Ease	BW	WW	YW	Milk	HPG	Stay	Maint.En.
Age	7	11	-2.7	47	83	18.5	11	16	1.2	
Wt	1240									
Prog.BW	64									
WR	100									
YR	98									
Wean Pct.	43%									
Cow Eff.	91									
		BWt	WWt	WR	ADG	YWt	YR	Scr.	Fr.	
		71	537	101	3.32	1007	95	32	5.0	

★★★★★ for Low Maintenance, Marbling, Calving Ease, Stayability.

142 **BSF LANCER A500 N5** 

1-B 99% # 1625958 Tat.: BSF3 A500
 Birth: 3-30-13
 Beckton Lancer F442 T
BECKTON LANCER T371 H4
 Ref. L-2 Beckton Coca F276 HV
 Beckton Nebula J R475
BSF NEBULANN W751 N
 BSF Regus K739 EP
 Beckton Lancer T A664
 Bkt Suffeina A828 DM
 Leachman Heavenly 8141
 Beckton Coca B112 CB
 Beckton Nebula M045
 Beckton Larkeisa M138 JC
 Beckton Epic D404
 BSF Regus G195

DAM		Calv.	Ease	BW	WW	YW	Milk	HPG	Stay	Maint.En.
Age	4	12	-6.2	47	78	10	9	14	-5.6	
Wt	925									
Prog.BW	61									
WR	95									
YR	100									
Wean Pct.	56%									
Cow Eff.	119									
		BWt	WWt	WR	ADG	YWt	YR	Scr.	Fr.	
		63	542	97	3.82	1080	100	35	5.5	

★★★★★ for Low Maintenance, Marbling, High Cow Efficiency, Calving Ease, Stayability.

145 **BSF EPIC A184 H7** 

1-B 99% # 1625976 Tat.: BSF3 A184
 Birth: 3-18-13
 Beckton Epic T330 L5
BECKTON EPIC X330 L6
 Ref. E-3 Beckton Kit R503 LN
 Beckton Epic K4 N795
 Beckton Belga K202 LN
 Beckton Lancer F442 T
 Beckton Kit F468 JL
 Beckton Hasten H S462
 Beckton Encino S456 JC
 Beckton Justice C1 R483
 BSF Regus K326 WH

DAM		Calv.	Ease	BW	WW	YW	Milk	HPG	Stay	Maint.En.
Age	3	13	-4.2	48	84	18	8	16	-4.4	
Wt	835									
Prog.BW	70									
WR	110									
YR	107									
Wean Pct.	64%									
Cow Eff.	134									
		BWt	WWt	WR	ADG	YWt	YR	Scr.	Fr.	
		70	571	109	3.60	1079	103	34	5.0	

★★★★★ for Low Maintenance, Marbling, Superior Cow, High Cow Efficiency, Calving Ease, Stayability.

143 **BSF LEGEND A606 O2** 

1-B 99% # 1625963 Tat.: BSF3 A606
 Birth: 4-3-13
 Beckton Lancer F442 T
BECKTON LEGEND S670
 Ref. L-1 Beckton Kit F468 JL
 Beckton Roman J S158
BSF JOANIE W782 J
 BSF Regus L897 WR
 Beckton Lancer T A664
 Bkt Suffeina A828 DM
 Beckton Julian GG B571
 Beckton Kit A517 NP
 TR Romeo NT379
 Beckton Belga K285 JL
 Beckton Warrior T C371
 BSF Regus H341

DAM		Calv.	Ease	BW	WW	YW	Milk	HPG	Stay	Maint.En.
Age	4	11	-4.8	48	72	16	7	13	-9.7	
Wt	930									
Prog.BW	59									
WR	103									
YR	98									
Wean Pct.	64%									
Cow Eff.	134									
		BWt	WWt	WR	ADG	YWt	YR	Scr.	Fr.	
		65	611	110	3.43	1082	100	34	5.5	

★★★★★ for Low Maintenance, Marbling, Rib-eye area, High Cow Efficiency, Calving Ease, Stayability.

146 **BSF ACCENT A476 L3** 

1-B 99% # 1625930 Tat.: BSF3 A476
 Birth: 3-29-13
 Beckton Cody K1 P014
BECKTON ACCENT U777 C2
 Ref. A-1 Beckton Susan R022 CQ
 Beckton Cody KH M390
 Beckton Rose M126 WR
 Beckton Cherokee N N479
 Beckton Susan N023 JE
 Beckton Loki C M740
 Beckton Lakme J460 LT
 Beckton Julio L233
 BSF Regus J569

DAM		Calv.	Ease	BW	WW	YW	Milk	HPG	Stay	Maint.En.
Age	4	12	-7.0	43	72	24	6	16	2.0	
Wt	1215									
Prog.BW	63									
WR	97									
YR	99									
Wean Pct.	43%									
Cow Eff.	90									
		BWt	WWt	WR	ADG	YWt	YR	Scr.	Fr.	
		60	540	97	3.82	1089	101	36	5.5	

★★★★★ for Low Maintenance, Marbling, Calving Ease, Stayability.

• Bulls •

147 BSF EMPEROR A066 C4 

99% # Tat.: BSF3 A066
 Birth: 3-11-13
BECKTON EMPEROR Y459 J3
 Ref. E-4
BSF CHERISE Y076 C

DAM		Calv.Ease	BW	WW	YW	Milk	HPG	Stay	Maint.En.
Age	2	11.3	-3.8	34.3	60	22	9.5	15.8	-2.7
Wt	925	Marb +36		REA +16		Bfat +01			
Prog.BW	63	BWt	WWt	WR	ADG	YWt	YR	Scr.	Fr.
WR	105	63	532	105	3.54	1074	105	32	5.5
YR	105								
Wean Pct.	51%								
Cow Eff.	107								

★★★★★ for Low Maintenance, Marbling, Rib-eye area, Superior Cow, Calving Ease, Stayability.

149 BSF MAXIMUS A685 E 

2 99% # 1625869 Tat.: BSF3 A685
 Birth: 4-7-13
BECKTON RED ANGUS SIRE
 Ref.
BSF JEWEL U431 EC

DAM		Calv.Ease	BW	WW	YW	Milk	HPG	Stay	Maint.En.
Age	5	5	-4.4	23	40	12	3	7	1.1
Wt	955	Marb +19		REA +33		Bfat -03			
Prog.BW	69	BWt	WWt	WR	ADG	YWt	YR	Scr.	Fr.
WR	108	67	556	100	3.32	1076	100	36	5.0
YR	103								
Wean Pct.	58%								
Cow Eff.	123								

★★★★★ for Low Maintenance, Marbling, Rib-eye area, Superior Cow, High Cow Efficiency, Calving Ease.

148 BSF LIKABLE A349 E3 

1-B 99% # 1625887 Tat.: BSF3 A349
 Birth: 3-25-13
BECKTON LIKABLE U120 L2
 Ref. L-3
BSF CODETTE U667 EY

DAM		Calv.Ease	BW	WW	YW	Milk	HPG	Stay	Maint.En.
Age	5	10	-5.3	36	61	17	6	14	-6.4
Wt	910	Marb +49		REA +09		Bfat +01			
Prog.BW	69	BWt	WWt	WR	ADG	YWt	YR	Scr.	Fr.
WR	105	64	539	97	3.54	1052	97	34	5.0
YR	103								
Wean Pct.	59%								
Cow Eff.	125								

★★★★★ for Low Maintenance, Marbling, Superior Cow, High Cow Efficiency, Calving Ease, Stayability.

150 BSF ACCENT A178 E3 

99% # Tat.: BSF3 A178
 Birth: 3-18-13
BECKTON ACCENT U777 C2
 Ref. A-1
BSF JULIANNE T063 EX

DAM		Calv.Ease	BW	WW	YW	Milk	HPG	Stay	Maint.En.
Age	6	12.5	-4.1	42	72.5	18.5	7.5	16.5	0.6
Wt	1090	Marb +36		REA +17		Bfat +03			
Prog.BW	68	BWt	WWt	WR	ADG	YWt	YR	Scr.	Fr.
WR	93	66	483	90	3.03	998	94	36	5.5
YR	99								
Wean Pct.	44%								
Cow Eff.	93								

★★★★★ for Low Maintenance, Marbling, Rib-eye area, Calving Ease, Stayability.



151 BECKTON DOMINOR A038 J7 











1-A 100% # 1626083 Tat.: BSF3 A038
 Birth: 3-8-13
BECKTON DOMINOR Y052 N6
 Ref. D-3
BECKTON TARA Y111 J

DAM		Calv.Ease	BW	WW	YW	Milk	HPG	Stay	Maint.En.
Age	2	14	-2.3	60	100	18	10	17.5	-4.3
Wt	900	Marb +67		REA +06		Bfat +05			
Prog.BW	69	BWt	WWt	WR	ADG	YWt	YR	Scr.	Fr.
WR	111	69	551	111	3.76	1091	109	36	4.5
YR	109								
Wean Pct.	55%								
Cow Eff.	115								

★★★★★ for Low Maintenance, Growth, Marbling, Superior Cow, Calving Ease, Stayability.

• Bulls •













152 **BSF MAXIMUS A805 J** 

2 99% # 1625973 Tat.: BSF3 A805
 Birth: 4-17-13
BECKTON RED ANGUS SIRE
 Ref.  Beckton Red Angus Sire  Beckton Red Angus Dam
 Beckton Red Angus Sire  Beckton Red Angus Dam
BECKTON MARTA W883 J
 Beckton Julian G5 S107  Beckton Julian GJ P535
 Beckton Marta L280 LN  Beckton Minola P826 DM
 Beckton Lancer F442 T
 Beckton Marta C314 JL

DAM		Calv.Ease	BW	WW	YW	Milk	HPG	Stay	Maint.En.
Age	4	5	-2.8	39	63	7	6	8	-0.3
Wt	1065								
Prog.BW	70								
WR	105			Marb +.18	REA +.31			Bfat -.02	
YR	107								
Wean Pct.	53%	BWt	WWt	WR	ADG	YWt	YR	Scr.	Fr.
Cow Eff.	111	68	583	105	3.65	1159	107	36	5.0

★★★★★ for Low Maintenance, Growth, Marbling, Rib-eye area, Superior Cow, Calving Ease.













155 **BECKTON LEGEND A504 C2** 

1-A 100% # 1626193 Tat.: BKT3 A504
 Birth: 3-30-13
BECKTON LEGEND S670
 Ref. L-1  Beckton Lancer F442 T  Beckton Lancer T A664
 Beckton Kit F468 JL  Bkt Suffeina A828 DM
 Beckton Cherokee N N479  Beckton Julian GG B571
BKT PINE MARIE R056 CQ  BKT Pine Marie N783 CO  Beckton Kit A517 NP
 BFCK Cherokee Cnyn 4912
 Beckton Dinah C440 NM
 Beckton Copper JT G095
 Bkt Pine Marie D319 VG

DAM		Calv.Ease	BW	WW	YW	Milk	HPG	Stay	Maint.En.
Age	8	10	-5.7	40	59	16	10	16	-7.3
Wt	1220								
Prog.BW	64								
WR	99			Marb +.74	REA +.38			Bfat +.02	
YR	99								
Wean Pct.	43%	BWt	WWt	WR	ADG	YWt	YR	Scr.	Fr.
Cow Eff.	91	63	530	99	3.15	1035	98	34	5.0

★★★★★ for Low Maintenance, Marbling, Rib-eye area, Calving Ease, Stayability.

153 **BECKTON NEBULA A528 C3** 













1-A 100% # 1626346 Tat.: BKT3 A528
 Birth: 3-31-13
BECKTON NEBULA G S237
 Ref. N  Beckton Nebula M045  Beckton Neptune R2 K065
 Beckton Lakme LA06 JL  Beckton Belga K285 JL
 Beckton Julian GG B571
 Beckton Lakme B370 HV
 Beckton Clifftop T C075
BECKTON LARKABA U475 CT  BKT Clifftop TP R288  Beckton Christy K209 CO
 Beckton Larkaba R809 NB  Beckton Nebula M045
 Beckton Larkaba M116 CE

DAM		Calv.Ease	BW	WW	YW	Milk	HPG	Stay	Maint.En.
Age	5	17	-8.6	30	51	17	10	13	-8.0
Wt	810								
Prog.BW	51								
WR	100			Marb +.62	REA -.05			Bfat +.01	
YR	100								
Wean Pct.	65%	BWt	WWt	WR	ADG	YWt	YR	Scr.	Fr.
Cow Eff.	137	62	527	95	3.99	1068	99	34	4.5

★★★★★ for Low Maintenance, Marbling, High Cow Efficiency, Calving Ease, Stayability.















154 **BECKTON JULIAN A502 C6** 

1-A 100% # 1625962 Tat.: BSF3 A502
 Birth: 3-30-13
BECKTON JULIAN W743 H5
 Ref. J-3  Beckton Julian G5 S107  Beckton Julian GJ P535
 Beckton Kit L399 HR  Beckton Minola P826 DM
 Beckton Herald F FA20
 Beckton Kit F468 JL
 Beckton Clifftop T C075
BECKTON CHRISTY W779 C  BKT Clifftop TP R288  Beckton Christy K209 CO
 Beckton Christy S151 NB  Beckton Nebula E P084
 Beckton Christy P333 CH

DAM		Calv.Ease	BW	WW	YW	Milk	HPG	Stay	Maint.En.
Age	4	12	-5.1	40	68	19	12	16	-5.6
Wt	935								
Prog.BW	65								
WR	93			Marb +.62	REA +.01			Bfat +.05	
YR	101								
Wean Pct.	56%	BWt	WWt	WR	ADG	YWt	YR	Scr.	Fr.
Cow Eff.	117	65	541	97	3.43	1096	101	36	4.5

★★★★★ for Low Maintenance, Marbling, High Cow Efficiency, Calving Ease, Stayability.

156 **BECKTON NEBULA A567 L3** 

1-A 100% # 1626522 Tat.: BKT3 A567
 Birth: 4-2-13
BECKTON NEBULA T269 E2
 Ref. N-3  Beckton Nebula M045  Beckton Neptune R2 K065
 Beckton Ruth M967 EP  Beckton Belga K285 JL
 Beckton Epic KN H110
 Beckton Ruth A905 SG
 Beckton Lancer F442 T
 Beckton Coca F276 HV
 Beckton Loki F251
 Beckton Lana G056 CO
BECKTON LANA X371 L  Beckton Lancer T371 H4
 Beckton Lana M793 LO

DAM		Calv.Ease	BW	WW	YW	Milk	HPG	Stay	Maint.En.
Age	3	11	-3.7	52	82	16	6	15	-4.5
Wt	890								
Prog.BW	66								
WR	110			Marb +.52	REA -.08			Bfat +.04	
YR	108								
Wean Pct.	60%	BWt	WWt	WR	ADG	YWt	YR	Scr.	Fr.
Cow Eff.	127	65	575	111	3.54	1105	106	35	5.0

★★★★★ for Low Maintenance, Growth, Marbling, Superior Cow, High Cow Efficiency, Calving Ease, Stayability.

• Bulls •

157 BECKTON DOMINOR A847 V6 

1-A 100% # 1626178 Tat.: BKT3 A847

Birth: 4-23-13

Beckton Dominor Z1 R610
BECKTON DOMINOR W640 C5
 Ref. D-1 Beckton Mona R166 CQ

Beckton Vegas S1 K316
BECKTON LARKEISA P268 VG
 BKT Larkeisa K053 HR

Beckton Dominor ZC M919
 Beckton Sierra K557 LO
 Beckton Cherokee N N479
 Beckton Mona N342 HU
 Beckton Vegas SV H078
 Beckton Eola H073 EP
 Beckton Herald H1 H348
 BKT Larkeisa H443 DM

DAM		Calv.Ease	BW	WW	YW	Milk	HPG	Stay	Maint.En.
Age	9	11	-2.5	50	77	22	10	12	-3.1
Wt	1005	Marb +.57		REA -.02		Bfat +.03			
Prog.BW	74	BWt	WWt	WR	ADG	YWt	YR	Scr.	Fr.
WR	109	80	584	105	3.48	1086	100	36	5.0
YR	107								
Wean Pct.	58%								
Cow Eff.	122								

★★★★★ for Low Maintenance, Marbling, Superior Cow, High Cow Efficiency, Calving Ease.

160 BECKTON EPIC A689 N6 

1-A 100% # 1626447 Tat.: BKT3 A689

Birth: 4-7-13

Beckton Epic K4 N795
BECKTON EPIC U749 D5
 Ref. E-2 Beckton Denise R308 DM

Beckton Nebula EN S347
BKT PINE MARIE W623 N
 BKT Pine Marie R246 JE

Beckton Epic KJ J722
 Beckton Sierra J789 EP
 Beckton Dominor ZC M919
 Beckton Denise L639 JL
 Beckton Nebula E P084
 Beckton Eola P530 NB
 Beckton Jules L429
 BKT Pine Marie J556 EP

DAM		Calv.Ease	BW	WW	YW	Milk	HPG	Stay	Maint.En.
Age	4	13	-6.0	49	89	20	10	15	-1.5
Wt	935	Marb +.63		REA +.14		Bfat +.05			
Prog.BW	60	BWt	WWt	WR	ADG	YWt	YR	Scr.	Fr.
WR	104	63	545	102	3.60	1086	103	34	5.0
YR	106								
Wean Pct.	56%								
Cow Eff.	118								

★★★★★ for Low Maintenance, Marbling, Rib-eye area, Superior Cow, High Cow Efficiency, Calving Ease, Stayability.

158 BECKTON NEBULA A458 N5 

1-A 100% # 1625935 Tat.: BSF3 A458

Birth: 3-28-13

Beckton Nebula PJ S543
BECKTON NEBULA W778 J4
 Ref. N-6 Beckton Lana S197 JT

Beckton Nebula M045
BECKTON COCA W438 N
 Beckton Coca T080 NB

Beckton Nebula P P707
 Beckton Lana P685 JO
 Beckton Jet L P491
 Beckton Lana P828 LN
 Beckton Neptune R2 K065
 Beckton Belga K285 JL
 Beckton Nebula N R573
 Beckton Coca R375 WR

DAM		Calv.Ease	BW	WW	YW	Milk	HPG	Stay	Maint.En.
Age	4	19	-10.5	41	69	16	9	15	-3.8
Wt	765	Marb +.69		REA -.19		Bfat +.03			
Prog.BW	55	BWt	WWt	WR	ADG	YWt	YR	Scr.	Fr.
WR	105	54	552	99	3.43	1058	98	33	5.0
YR	100								
Wean Pct.	70%								
Cow Eff.	147								

★★★★★ for Low Maintenance, Marbling, High Cow Efficiency, Calving Ease, Stayability.

161 BECKTON DOMINOR A328 N6 

1-A 100% # 1626215 Tat.: BKT3 A328

Birth: 3-24-13

Beckton Dominor Z1 R610
BECKTON DOMINOR W640 C5
 Ref. D-1 Beckton Mona R166 CQ

Beckton Nebula M045
BECKTON SCARLETT R808 NB
 Andras Scarlett 2029

Beckton Dominor ZC M919
 Beckton Sierra K557 LO
 Beckton Cherokee N N479
 Beckton Mona N342 HU
 Beckton Neptune R2 K065
 Beckton Belga K285 JL
 Andras Sleep Easy 802
 COF Scarlett

DAM		Calv.Ease	BW	WW	YW	Milk	HPG	Stay	Maint.En.
Age	8	13	-7.3	34	58	20	12	14	-9.7
Wt	1000	Marb +.63		REA -.15		Bfat +.07			
Prog.BW	65	BWt	WWt	WR	ADG	YWt	YR	Scr.	Fr.
WR	102	63	520	93	3.88	1026	95	33	4.5
YR	101								
Wean Pct.	52%								
Cow Eff.	110								

★★★★★ for Low Maintenance, Marbling, Calving Ease, Stayability.

159 BECKTON CLIFFTOP A263 L4 

2 100% # 1626012 Tat.: BSF3 A263

Birth: 3-21-13

BKT Clifftop TP R288
BECKTON CLIFFTOP W692 E3
 Ref. C-1 Beckton Lydia S274 EP

Beckton Lancer T371 H4
BECKTON TAMARA X235 L
 Beckton Tamara S694 VA

Beckton Clifftop T C075
 Beckton Christy K209 CO
 Beckton Epic KM M115
 Beckton Lydia M607 LO
 Beckton Lancer F442 T
 Beckton Coca F276 HV
 Beckton Vega P079
 Beckton Tamara P579 VG

DAM		Calv.Ease	BW	WW	YW	Milk	HPG	Stay	Maint.En.
Age	3	11	-4.2	45	83	22	6	16	-0.4
Wt	1185	Marb +.39		REA +.13		Bfat +.05			
Prog.BW	65	BWt	WWt	WR	ADG	YWt	YR	Scr.	Fr.
WR	107	65	527	107	3.15	1042	102	34	5.5
YR	102								
Wean Pct.	41%								
Cow Eff.	87								

★★★★★ for Low Maintenance, Marbling, Rib-eye area, Calving Ease, Stayability.

162 BECKTON CLIFFTOP A076 E5 

1-A 100% # 1626080 Tat.: BSF3 A076

Birth: 3-13-13

Beckton Clifftop W692 E3
BECKTON CLIFFTOP Y012 C4
 Ref. C-2 Beckton Lana W240 C

Beckton Emcee W271 L2
BECKTON ANGEL Y082 E
 Beckton Angel W290 J

BKT Clifftop TP R288
 Beckton Lydia S274 EP
 BKT Clifftop TP R288
 Beckton Lana L923 CD
 Beckton Emcee S466
 Beckton Lana M621 LN
 Beckton Julian G3 P608
 Beckton Angel K360 CO

DAM		Calv.Ease	BW	WW	YW	Milk	HPG	Stay	Maint.En.
Age	2	10	-2.1	56	95	23	10.5	16	-3.2
Wt	825	Marb +.52		REA +.07		Bfat +.03			
Prog.BW	66	BWt	WWt	WR	ADG	YWt	YR	Scr.	Fr.
WR	109	66	556	109	3.09	1020	100	33	5.5
YR	100								
Wean Pct.	60%								
Cow Eff.	126								

★★★★★ for Low Maintenance, Marbling, High Cow Efficiency, Calving Ease, Stayability.

• Bulls •



165 BECKTON LEGEND A146 H2 

1-A 100% # 1626445 Tat.: BKT3 A146

Birth: 3-16-13

BECKTON LEGEND S670
Ref. L-1

BECKTON LARKABA W612 H

Beckton Lancer F442 T
Beckton Kit F468 JL
Beckton Lancer T A664
Bkt Suffeina A828 DM
Beckton Julian GG B571
Beckton Kit A517 NP
Beckton Hasten P292
Beckton Lakme G128 HD
Beckton Warhawk N560
Beckton Larkaba N394 HR

DAM		Calv.Ease	BW	WW	YW	Milk	HPG	Stay	Maint.En.
Age	4	15	-8.9	35	54	13	9	14	-8.8
Wt	980	Marb +.57		REA +.33		Bfat +.02			
Prog.BW	53	BWt	WWt	WR	ADG	YWt	YR	Scr.	Fr.
WR	93	54	484	87	3.65	1030	95	32	5.0
YR	97								
Wean Pct.	47%								
Cow Eff.	100								

★★★★★ for Low Maintenance, Marbling, Rib-eye area, Calving Ease, Stayability.

163 BECKTON EPIC A237 C7 

1-A 100% # 1626371 Tat.: BKT3 A237

Birth: 3-20-13

BECKTON EPIC X330 L6
Ref. E-3

BECKTON MINOLA U839 CT

Beckton Epic T330 L5
Beckton Kit R503 LN
Beckton Epic K4 N795
Beckton Belga K202 LN
Beckton Lancer F442 T
Beckton Kit F468 JL
Beckton Clifftop T C075
Beckton Christy K209 CO
Beckton Juno N493
Beckton Minola N751 JL

DAM		Calv.Ease	BW	WW	YW	Milk	HPG	Stay	Maint.En.
Age	5	12	-8.1	39	68	16	9	16	-10.9
Wt	975	Marb +.60		REA +.24		Bfat +.06			
Prog.BW	56	BWt	WWt	WR	ADG	YWt	YR	Scr.	Fr.
WR	96	55	489	92	4.10	1033	98	34	4.5
YR	99								
Wean Pct.	50%								
Cow Eff.	106								

★★★★★ for Low Maintenance, Gainability, Marbling, Rib-eye area, Calving Ease, Stayability.

166 BSF HERITAGE A815 E3 

99% # Tat.: BSF3 A815

Birth: 4-19-13

BECKTON HERITAGE X356 E2
Ref. H-1

BSF EPIQUETTE R729 EP

Beckton Heritage N013
Beckton Lana S489 EP
Beckton Hustler C2 L079
Beckton Lana L007 JL
Beckton Epic K4 N795
Beckton Lana E136 TP
Beckton Epic K F075
Beckton Minerva F495 CH
Beckton Epic K F075
BSF Regus H508

DAM		Calv.Ease	BW	WW	YW	Milk	HPG	Stay	Maint.En.
Age	8	8.5	-2.3	44	75	17.5	9	14.5	-2.1
Wt	1035	Marb +.49		REA -.08		Bfat +.03			
Prog.BW	71	BWt	WWt	WR	ADG	YWt	YR	Scr.	Fr.
WR	101	71	578	108	3.43	1081	102	34	5.0
YR	100								
Wean Pct.	56%								
Cow Eff.	118								

★★★★★ for Low Maintenance, Marbling, High Cow Efficiency, Calving Ease, Stayability.

164 BECKTON EPIC A195 L6 

1-A 100% # 1626334 Tat.: BKT3 A195

Birth: 3-19-13

BECKTON EPIC U749 D5
Ref. E-2

BECKTON MINERVA U310 LO

Beckton Epic K4 N795
Beckton Denise R308 DM
Beckton Epic KJ J722
Beckton Sierra J789 EP
Beckton Dominor ZC M919
Beckton Denise L639 JL
Beckton Loki C M740
Beckton Lakme J460 LT
Beckton Hustler C2 L079
Beckton Minerva J615 VG

DAM		Calv.Ease	BW	WW	YW	Milk	HPG	Stay	Maint.En.
Age	5	14	-7.8	42	77	18	4	14	-0.9
Wt	925	Marb +.41		REA +.19		Bfat +.01			
Prog.BW	55	BWt	WWt	WR	ADG	YWt	YR	Scr.	Fr.
WR	97	59	510	92	3.26	974	90	34	4.5
YR	96								
Wean Pct.	55%								
Cow Eff.	116								

★★★★★ for Low Maintenance, Marbling, Rib-eye area, High Cow Efficiency, Calving Ease, Stayability.

167 BSF JULIAN A665 E6 

1-B 99% # 1625846 Tat.: BSF3 A665

Birth: 4-6-13

BECKTON JULIAN W743 H5
Ref. J-3

BSF EPIQUETTE U148 EC

Beckton Julian G5 S107
Beckton Kit L399 HR
Beckton Emcee S466
BSF Epiquette S433 EP
Beckton Julian GJ P535
Beckton Minola P826 DM
Beckton Herald F FA20
Beckton Kit F468 JL
Beckton Epic K4 N795
Beckton Larkaba H798 WR
Beckton Epic K4 N795
BSF Regus M638 WR

DAM		Calv.Ease	BW	WW	YW	Milk	HPG	Stay	Maint.En.
Age	5	11	-3.3	46	79	22	8	12	3.3
Wt	925	Marb +.59		REA +.01		Bfat +.06			
Prog.BW	57	BWt	WWt	WR	ADG	YWt	YR	Scr.	Fr.
WR	103	54	496	100	3.71	1037	102	35	5.0
YR	104								
Wean Pct.	%								
Cow Eff.	%								

★★★★★ for Low Maintenance, Marbling, Calving Ease.

• Bulls •

168 **BSF ORION A677 E2** 

1-B 99% # 1625912 Tat.: BSF3 A677

Birth: 4-7-13

Beckton Roman J S158
BECKTON JANUS X799 L2
 Ref. O-1 Beckton Sierra K557 LO

TR Romeo NT379
 Beckton Belga K285 JL
 Beckton Loki F251
 Beckton Sierra C157 CL

Beckton Emperor T641 E2
BSF LAUREL W170 E
 BSF Laurel T171 HT

Beckton Emperor R100
 Beckton Vernice R416 EP
 Beckton Heritage N013
 BSF Laurel N619 LN

DAM		Calv.Ease	BW	WW	YW	Milk	HPG	Stay	Maint.En.
Age	4	12	-4.2	48	76	18	5	12	-1.8
Wt	935	Marb +4.2		REA +1.3		Bfat +0.1			
Prog.BW	63	BWt	WWt	WR	ADG	YWt	YR	Scr.	Fr.
WR	92	71	517	97	3.71	1058	100	36	5.5
YR	97								
Wean Pct.	53%								
Cow Eff.	112								

★★★★★ for Low Maintenance, Marbling, Rib-eye area, Calving Ease.

170 **BSF ACCENT A044 W4** 

99% # Tat.: BSF3 A044

Birth: 3-9-13

Beckton Accent W180 C2
BECKTON ACCENT Y260 L3
 Ref. A-3 Beckton Lana W463 L

Beckton Cody K1 P014
 Beckton Christy R046 CQ
 Beckton Loki CL S284
 Beckton Lana R327 EP

Beckton Warrior T248 L5
BSF LAUREL Y568 W
 BSF Laurel S572 DM

Beckton Warrior N645 T1
 Beckton Kit R503 LN
 Beckton Dominor ZC M919
 BSF Laurel N839 LN

DAM		Calv.Ease	BW	WW	YW	Milk	HPG	Stay	Maint.En.
Age	2	11.3	-3.5	44.8	79.8	18.3	10.3	16.8	-1.9
Wt	775	Marb +3.1		REA +1.3		Bfat +0.1			
Prog.BW	62	BWt	WWt	WR	ADG	YWt	YR	Scr.	Fr.
WR	105	62	534	105	3.54	1017	100	36	5.0
YR	100								
Wean Pct.	61%								
Cow Eff.	129								

★★★★★ for Low Maintenance, Marbling, Rib-eye area, High Cow Efficiency, Calving Ease, Stayability.

169 **BSF EPIC A697 J7** 

99% # Tat.: BKB3 A697

Birth: 4-8-13

Beckton Epic T330 L5
BECKTON EPIC X330 L6
 Ref. E-3 Beckton Kit R503 LN

Beckton Epic K4 N795
 Beckton Belga K202 LN
 Beckton Lancer F442 T
 Beckton Kit F468 JL

Beckton Julio L233
BSF JULIA T175 JO
 BSF Regus M604 LN

Beckton Julian G1 J526
 Beckton Rose J725 EP
 Beckton Lancer TL G626
 BSF Regus J378

DAM		Calv.Ease	BW	WW	YW	Milk	HPG	Stay	Maint.En.
Age	6	14.5	-5.4	31	63.5	19	6	17.5	-2.8
Wt	980	Marb +4.3		REA +2.2		Bfat +0.3			
Prog.BW	64	BWt	WWt	WR	ADG	YWt	YR	Scr.	Fr.
WR	103	70	500	90	3.32	1044	97	33	5.5
YR	104								
Wean Pct.	51%								
Cow Eff.	107								

★★★★★ for Low Maintenance, Marbling, Rib-eye area, Superior Cow, Calving Ease, Stayability.

171 **BSF HASTEN A545 L5** 

1-B 99% # 1626119 Tat.: BSF3 A545

Birth: 3-31-13

Beckton Hasten U108 J3
BECKTON HASTEN Y069 D4
 Ref. H-2 Beckton Marta P484 DM

Beckton Hasten H S462
 Beckton Encino S456 JC
 Beckton Dominor Z E401
 Beckton Marta K254 LN

BSF Lancer W007 N5
BSF NEBULANN Y490 L
 BSF Nebulann W751 N

Beckton Lancer T371 H4
 BSF Dominique T338 NB
 Beckton Nebula J R475
 BSF Regus K739 EP

DAM		Calv.Ease	BW	WW	YW	Milk	HPG	Stay	Maint.En.
Age	2	11	-5.2	53	95	13	10	17	-4.9
Wt	805	Marb +4.5		REA -0.1		Bfat +0.3			
Prog.BW	53	BWt	WWt	WR	ADG	YWt	YR	Scr.	Fr.
WR	103	53	524	103	3.43	1070	105	32	5.5
YR	105								
Wean Pct.	58%								
Cow Eff.	121								

★★★★★ for Low Maintenance, Marbling, Superior Cow, High Cow Efficiency, Calving Ease, Stayability.



172 **BSF ACCENT A052 E4** 

1-B 99% # 1626120 Tat.: BSF3 A052

Birth: 3-9-13

Beckton Accent W180 C2
BECKTON ACCENT Y260 L3
 Ref. A-3 Beckton Lana W463 L

Beckton Cody K1 P014
 Beckton Christy R046 CQ
 Beckton Loki CL S284
 Beckton Lana R327 EP

Beckton Emcee W271 L2
BSF NEBULANN Y491 E
 BSF Nebulann W700 N

Beckton Emcee S466
 Beckton Lana M621 LN
 Beckton Nebula T054 H3
 BSF Nebulann T046 JC

DAM		Calv.Ease	BW	WW	YW	Milk	HPG	Stay	Maint.En.
Age	2	13	-5.3	55	88	20	10	15.5	-0.8
Wt	725	Marb +4.3		REA +1.3		Bfat +0.3			
Prog.BW	59	BWt	WWt	WR	ADG	YWt	YR	Scr.	Fr.
WR	105	59	519	105	3.26	1010	101	35	5.5
YR	101								
Wean Pct.	63%								
Cow Eff.	133								

★★★★★ for Low Maintenance, Marbling, Rib-eye area, High Cow Efficiency, Calving Ease, Stayability.

• Bulls •

173 **BSF NEBULA A599 L4** 

99% # Tat.: BSF3 A599
 Birth: 4-2-13
BECKTON NEBULA T398 V3
 Ref. N-4
BSF LAUREL N411 LO

DAM	Calv.Ease	BW	WW	YW	Milk	HPG	Stay	Maint.En.
Age 10	11.5	-3.7	34	57	20	6	15	-5.1
Wt 1045	Marb +0.40		REA +0.25		Bfat +0.06			
Prog.BW 72	BWt	WWt	WR	ADG	YWt	YR	Scr.	Fr.
WR 100	72	521	93	3.60	1031	95	32	5.0
YR 100								
Wean Pct. 50%								
Cow Eff. 105								

★★★★★ for Low Maintenance, Marbling, Rib-eye area, Calving Ease, Stayability.

175 **BSF ACCENT A896 N3** 

1-B 99% # 1625974 Tat.: BSF3 A896
 Birth: 5-4-13
BECKTON ACCENT U777 C2
 Ref. A-1
BSF VIOLET X004 N

DAM	Calv.Ease	BW	WW	YW	Milk	HPG	Stay	Maint.En.
Age 3	11	-1.6	56	90	25	9	15	-1.5
Wt 870	Marb +0.45		REA +0.08		Bfat +0.02			
Prog.BW 70	BWt	WWt	WR	ADG	YWt	YR	Scr.	Fr.
WR 107	77	612	117	3.71	1121	107	33	5.5
YR 105								
Wean Pct. 66%								
Cow Eff. 139								

★★★★★ for Low Maintenance, Growth, Marbling, Superior Cow, High Cow Efficiency, Calving Ease, Stayability.



176 **BSF LIKABLE A173 N4** 

1-B 99% # 1626137 Tat.: BSF3 A173
 Birth: 3-18-13
BECKTON LIKABLE Y124 L3
 Ref. L-5
BSF JUSTICIA Y672 N

DAM	Calv.Ease	BW	WW	YW	Milk	HPG	Stay	Maint.En.
Age 2	9	-1.8	59	94	11	9	14	0.4
Wt 895	Marb +0.67		REA +0.13		Bfat +0.04			
Prog.BW 67	BWt	WWt	WR	ADG	YWt	YR	Scr.	Fr.
WR 105	67	520	105	2.92	1041	102	32	5.0
YR 102								
Wean Pct. 51%								
Cow Eff. 108								

★★★★★ for Low Maintenance, Marbling, Rib-eye area, Calving Ease, Stayability.

174 **BSF SCAMP A481 A4** 

1-B 99% # 1625892 Tat.: BSF3 A481
 Birth: 3-29-13
BECKTON SCAMP X494 E3
 Ref. S-1
BSF JULESTE U757 CD

DAM	Calv.Ease	BW	WW	YW	Milk	HPG	Stay	Maint.En.
Age 5	12	-6.3	48	82	18	11	12	-4.7
Wt 1160	Marb +0.47		REA +0.14		Bfat +0.02			
Prog.BW 67	BWt	WWt	WR	ADG	YWt	YR	Scr.	Fr.
WR 100	64	508	95	3.48	980	93	36	5.5
YR 100								
Wean Pct. 44%								
Cow Eff. 92								

★★★★★ for Low Maintenance, Marbling, Rib-eye area, Calving Ease.



• Bulls •

177 **BSF NEBULA A218 L3** 

1-B 99% # 1626041 Tat.: BSF3 A218

Birth: 3-19-13

BECKTON NEBULA T269 E2
Ref. N-3

- Beckton Nebula M045
- Beckton Ruth M967 EP

BSF COQUETTE X506 L

- Beckton Loki CL S284
- BSF Coquette R240 LN

- Beckton Neptune R2 K065
- Beckton Belga K285 JL
- Beckton Epic KN H110
- Beckton Ruth A905 SG
- Beckton Loki C M740
- Beckton Lakme J460 LT
- Beckton Lancer T8 N337
- BSF Coquette N706 CE

DAM		Calv.Ease	BW	WW	YW	Milk	HPG	Stay	Maint.En.
Age	3	12	-3.0	54	85	15	8	14	-0.6
Wt	1065	Marb +.34		REA -.07		Bfat +.03			
Prog.BW	64	BWt	WWt	WR	ADG	YWt	YR	Scr.	Fr.
WR	102	71	572	111	2.30	983	94	34	5.5
YR	97								
Wean Pct.	50%								
Cow Eff.	105								

★★★★★ for Low Maintenance, Marbling, Calving Ease, Stayability.

180 **BSF EPIC A695 N7** 

1-B 99% # 1626688 Tat.: BKB3 A695

Birth: 4-8-13

BECKTON EPIC X330 L6
Ref. E-3

- Beckton Epic T330 L5
- Beckton Kit R503 LN

BSF BAYBERRY W111 N

- Beckton Nebula PJ S543
- BSF Bayberry N137 HU

- Beckton Epic K4 N795
- Beckton Belga K202 LN
- Beckton Lancer F442 T
- Beckton Kit F468 JL
- Beckton Nebula P P707
- Beckton Lana P685 JO
- BSF Hustler C1 L004
- Bkt Bayberry LC31 SC

DAM		Calv.Ease	BW	WW	YW	Milk	HPG	Stay	Maint.En.
Age	4	13	-7.3	46	78	15	4	13	1.1
Wt	1065	Marb +.55		REA +.21		Bfat +.02			
Prog.BW	56	BWt	WWt	WR	ADG	YWt	YR	Scr.	Fr.
WR	92	60	518	97	3.32	1041	98	32	6.0
YR	92								
Wean Pct.	47%								
Cow Eff.	98								

★★★★★ for Low Maintenance, Marbling, Rib-eye area, Calving Ease, Stayability.

178 **BSF LEGEND A931 E3** 

1-B 99% # 1625771 Tat.: BSF3 A931

Birth: 5-15-13

BECKTON LEGEND U331 E2
Ref. L-4

- Beckton Legend S670
- Beckton Lana S669 EP

BSF REGUS M507 EP

- Beckton Epic K F075
- BSF Red Roan J119

- Beckton Lancer F442 T
- Beckton Kit F468 JL
- Beckton Epic K4 N795
- Beckton Lana M597 LO
- Beckton Epic D404
- Beckton Belga D483 KR
- Beckton Clipper KC D400
- BSF Regus C059

DAM		Calv.Ease	BW	WW	YW	Milk	HPG	Stay	Maint.En.
Age	11	10	-4.4	46	81	16	7	14	2.2
Wt	1190	Marb +.81		REA +.24		Bfat +.04			
Prog.BW	85	BWt	WWt	WR	ADG	YWt	YR	Scr.	Fr.
WR	115	67	558	105	4.05	1112	105	34	6.0
YR	111								
Wean Pct.	45%								
Cow Eff.	95								

★★★★★ for Low Maintenance, Growth, Gainability, Marbling, Rib-eye area, Superior Cow, Calving Ease, Stayability.

181 **BECKTON EPIC A542 J6** 

1-A 100% # 1626350 Tat.: BKT3 A542

Birth: 3-31-13

BECKTON EPIC U749 D5
Ref. E-2

- Beckton Epic K4 N795
- Beckton Denise R308 DM

BECKTON MAIATA U518 JL

- Beckton Julian GG B571
- Beckton Maiata M854 JC

- Beckton Epic KJ J722
- Beckton Sierra J789 EP
- Beckton Dominor ZC M919
- Beckton Denise L639 JL
- Beckton Julian 7526G
- Bkt Marta 9A13 JL
- Beckton Justice G302
- Beckton Maiata C997 CB

DAM		Calv.Ease	BW	WW	YW	Milk	HPG	Stay	Maint.En.
Age	5	12	-4.5	52	91	16	6	14	3.1
Wt	1160	Marb +.51		REA +.33		Bfat +.02			
Prog.BW	65	BWt	WWt	WR	ADG	YWt	YR	Scr.	Fr.
WR	102	68	497	93	3.71	1028	97	33	5.0
YR	103								
Wean Pct.	43%								
Cow Eff.	90								

★★★★★ for Low Maintenance, Marbling, Rib-eye area, Calving Ease, Stayability.

179 **BSF DOMINOR A639 C6** 

1-B 99% # 1625941 Tat.: BSF3 A639

Birth: 4-4-13

BECKTON DOMINOR W640 C5
Ref. D-1

- Beckton Dominor Z1 R610
- Beckton Mona R166 CQ

BSF WARRITA W536 C

- BKT Clifftop TP R288
- BSF Warrita S236 WR

- Beckton Dominor ZC M919
- Beckton Sierra K557 LO
- Beckton Cherokee N N479
- Beckton Mona N342 HU
- Beckton Clifftop T C075
- Beckton Christy K209 CO
- Beckton Warrior CL M686
- BSF Regus L114 HR

DAM		Calv.Ease	BW	WW	YW	Milk	HPG	Stay	Maint.En.
Age	4	12	-4.9	47	75	20	14	16	-3.5
Wt	860	Marb +.53		REA +.19		Bfat +.06			
Prog.BW	68	BWt	WWt	WR	ADG	YWt	YR	Scr.	Fr.
WR	101	70	588	106	2.70	984	91	33	5.5
YR	97								
Wean Pct.	66%								
Cow Eff.	139								

★★★★★ for Low Maintenance, Marbling, Rib-eye area, High Cow Efficiency, Calving Ease, Stayability.

182 **BECKTON NEBULA A460 L2** 

1-A 100% # 1626480 Tat.: BKT3 A460

Birth: 3-28-13

BECKTON NEBULA M045
Ref. N-1

- Beckton Neptune R2 K065
- Beckton Belga K285 JL

BECKTON MARTA X031 L

- Beckton Likable U130 L2
- Beckton Marta U273 JL

- Beckton Neptune RR B284
- Beckton Lana C735 TP
- Beckton Julian GG B571
- Beckton Belga G493 HR
- Beckton Likable S633
- Beckton Kit S478 LN
- Beckton Julian GJ P535
- Beckton Marta G675 LN

DAM		Calv.Ease	BW	WW	YW	Milk	HPG	Stay	Maint.En.
Age	3	16	-8.6	45	74	6	11	15	.0
Wt	900	Marb +.55		REA +.11		Bfat +.05			
Prog.BW	45	BWt	WWt	WR	ADG	YWt	YR	Scr.	Fr.
WR	87	52	530	101	4.05	1061	101	35	5.0
YR	101								
Wean Pct.	55%								
Cow Eff.	115								

★★★★★ for Low Maintenance, Gainability, Marbling, Calving Ease, Stayability.

• Bulls •

183 BECKTON LIKABLE A061 R4 

1-A 100% # 1626676 Tat.: BKT3 A061
 Birth: 3-10-13
 Beckton Likable U130 L2
BECKTON LIKABLE Y362 L3
 Ref. L-6 Beckton Tamara M515 LN
 Beckton Likable S633
 Beckton Kit S478 LN
 Beckton Lancer TA K644
 Beckton Tamara K322 LN
 Beckton Ranger 9479R
 Beckton Rose N044 HU
BECKTON COCA Y715 R
 Beckton Ranger T603 H3
 Beckton Coca T168 NB
 Beckton Nebula M045
 Beckton Coca H256 JL

DAM		Calv.Ease	BW	WW	YW	Milk	HPG	Stay	Maint.En.
Age	2	11	-6.7	40	75	10	12	14	-4.6
Wt	760	Marb +0.63		REA +1.10		Bfat +0.06			
Prog.BW	NA	BWt	WWt	WR	ADG	YWt	YR	Scr.	Fr.
WR	NA	58	470	92	4.21	1100	108	32	5.5
YR	NA								
Wean Pct.	54%								
Cow Eff.	114								

★★★★★ for Low Maintenance, Growth, Gainability, Marbling, Calving Ease, Stayability.

185 BECKTON ACCENT A614 L3 

1-A 100% # 1626484 Tat.: BKT3 A614
 Birth: 4-3-13
 Beckton Cody K1 P014
BECKTON ACCENT U777 C2
 Ref. A-1 Beckton Susan R022 CQ
 Beckton Cody KH M390
 Beckton Rose M126 WR
 Beckton Cherokee N N479
 Beckton Susan N023 JE
 Beckton Likable S633
 Beckton Lana S718 LN
BECKTON LARKABA X054 L
 Beckton Likable U120 L2
 Beckton Larkaba U153 LE
 Beckton Legend S670
 Beckton Larkaba S299 EP

DAM		Calv.Ease	BW	WW	YW	Milk	HPG	Stay	Maint.En.
Age	3	10	-4.8	43	71	23	6	16	-5.2
Wt	790	Marb +0.64		REA +0.26		Bfat +0.03			
Prog.BW	66	BWt	WWt	WR	ADG	YWt	YR	Scr.	Fr.
WR	105	61	539	103	3.93	1109	106	36	5.5
YR	105								
Wean Pct.	63%								
Cow Eff.	133								

★★★★★ for Low Maintenance, Growth, Marbling, Rib-eye area, Superior Cow, High Cow Efficiency, Calving Ease, Stayability.



186 BECKTON DOMINOR A801 E6 

1-A 100% # 1625928 Tat.: BSF3 A801
 Birth: 4-17-13
 Beckton Dominor Z1 R610
BECKTON DOMINOR W640 C5
 Ref. D-1 Beckton Mona R166 CQ
 Beckton Dominor ZC M919
 Beckton Sierra K557 LO
 Beckton Cherokee N N479
 Beckton Mona N342 HU
BECKTON LANA W370 E
 Beckton Epic K4 N795
 Beckton Lana P520 LN
 Beckton Epic KJ J722
 Beckton Sierra J789 EP
 Beckton Lancer T5 L095
 Beckton Lana L827 WR

DAM		Calv.Ease	BW	WW	YW	Milk	HPG	Stay	Maint.En.
Age	4	10	-4.0	46	76	20	7	14	-0.2
Wt	920	Marb +0.70		REA +0.03		Bfat +0.05			
Prog.BW	66	BWt	WWt	WR	ADG	YWt	YR	Scr.	Fr.
WR	102	71	542	97	3.82	1106	102	32	5.5
YR	102								
Wean Pct.	57%								
Cow Eff.	120								

★★★★★ for Low Maintenance, Marbling, High Cow Efficiency, Calving Ease, Stayability.

184 BECKTON NEBULA A299 E4 

1-A 100% # 1626164 Tat.: BKT3 A299
 Birth: 3-23-13
 Beckton Nebula L P093
BECKTON NEBULA W486 D3
 Ref. N-5 Beckton Belga R716 DM
 Beckton Nebula M045
 Beckton Marta M021 LN
 Beckton Dominor ZC M919
 Beckton Belga K285 JL
 Beckton Epic K F075
 Beckton Lana F891 JL
BKT LARKEISA M816 EP
 Beckton Epic KJ J722
 BKT Larkeisa J076 DM
 Beckton Dominor ZR G223
 Bkt Larkeisa G591 CD

DAM		Calv.Ease	BW	WW	YW	Milk	HPG	Stay	Maint.En.
Age	11	7	-0.4	50	84	14	7	14	-2.6
Wt		Marb +0.55		REA +0.06		Bfat +0.03			
Prog.BW	76	BWt	WWt	WR	ADG	YWt	YR	Scr.	Fr.
WR	104	60	465	94	4.05	1070	105	35	5.5
YR	106								
Wean Pct.	%								
Cow Eff.									

★★★★★ for Low Maintenance, Growth, Gainability, Marbling, Superior Cow, Calving Ease, Stayability.

187 BECKTON SCAMP A696 H4 

1-A 100% # 1625868 Tat.: BSF3 A696
 Birth: 4-8-13
 Beckton Scamp T A825
BECKTON SCAMP X494 E3
 Ref. S-1 Beckton Lana S074 EP
 Beckton Scamp 8954
 Bkt Encino 8459 TJ
 Beckton Epic KH P678
 Beckton Lana P317 JL
BECKTON BELGA U424 HT
 Beckton Heritage N013
 Beckton Belga R032 NW
 Beckton Hustler C2 L079
 Beckton Lana L007 JL
 Beckton Newark Cn N567
 Beckton Belga N308 NP

DAM		Calv.Ease	BW	WW	YW	Milk	HPG	Stay	Maint.En.
Age	5	11	-3.8	50	76	18	10	12	-8.2
Wt	985	Marb +0.62		REA +0.04		Bfat +0.03			
Prog.BW	68	BWt	WWt	WR	ADG	YWt	YR	Scr.	Fr.
WR	98	75	514	92	4.44	1073	99	39	5.0
YR	101								
Wean Pct.	52%								
Cow Eff.	110								

★★★★★ for Low Maintenance, Gainability, Marbling, Calving Ease.

• Bulls •

188 BECKTON NEBULA A716 N4 1-A 100% # 1626365 Tat.: BKT3 A716



Birth: 4-10-13

Beckton Nebula L P093
BECKTON NEBULA W486 D3
 Ref. N-5 Beckton Belga R716 DM

Beckton Nebula L P093
BECKTON BELGA U624 NB
 Beckton Belga R173 JC

Beckton Nebula M045
 Beckton Marta M021 LN
 Beckton Dominor ZC M919
 Beckton Belga K285 JL
 Beckton Nebula M045
 Beckton Marta M021 LN
 Beckton Justice Cc N265
 Beckton Belga N528 EP

DAM		Calv.Ease	BW	WW	YW	Milk	HPG	Stay	Maint.En.
Age	5	9	-0.8	64	102	4	11	15	1.7
Wt	1215	Marb +0.45		REA +0.06		Bfat +0.03			
Prog.BW	71	BWt	WWt	WR	ADG	YWt	YR	Scr.	Fr.
WR	89	80	524	98	3.93	1070	101	35	5.5
YR	101								
Wean Pct.	43%								
Cow Eff.	91								

★★★★★ for Low Maintenance, Marbling, Calving Ease, Stayability.

190 BECKTON DOMINOR A276 H7 1-A 100% # 1626142 Tat.: BSF3 A276



Birth: 3-22-13

Beckton Dominor W640 C5
BECKTON DOMINOR Y052 N6
 Ref. D-3 Beckton Indigo W772 N

Beckton Hasten U108 J3
BECKTON ROSE Y714 H
 Beckton Rose R114 LN

Beckton Dominor Z1 R610
 Beckton Mona R166 CQ
 Beckton Nebula T398 V3
 Beckton Indigo T613 JT
 Beckton Hasten H S462
 Beckton Encino S456 JC
 Beckton Lancer T9 N586
 Beckton Rose N375 LN

DAM		Calv.Ease	BW	WW	YW	Milk	HPG	Stay	Maint.En.
Age	2	13	-2.9	51	79	19	12	16.5	-5.5
Wt	750	Marb +0.59		REA -0.09		Bfat +0.04			
Prog.BW	NA	BWt	WWt	WR	ADG	YWt	YR	Scr.	Fr.
WR	NA	80	520	102	4.21	1074	105	33	5.0
YR	NA								
Wean Pct.	61%								
Cow Eff.	129								

★★★★★ for Low Maintenance, Growth, Gainability, Marbling, High Cow Efficiency, Calving Ease, Stayability.

189 BECKTON NEBULA A164 N6 1-A 100% # 1626613 Tat.: BKT3 A164



Birth: 3-17-13

Beckton Nebula W778 J4
BECKTON NEBULA Y002 C5
 Ref. N-7 BKT Pine Marie W102 C

Beckton Nebula W778 J4
BECKTON SUFFEINA Y273 N
 Beckton Suffeina W489 W

Beckton Nebula PJ S543
 Beckton Lana S197 JT
 BKT Clifftop TP R288
 BKT Pine Marie M119 EP
 Beckton Nebula PJ S543
 Beckton Lana S197 JT
 Beckton Warrior T248 L5
 BKT Suffeina T500 EP

DAM		Calv.Ease	BW	WW	YW	Milk	HPG	Stay	Maint.En.
Age	2	16	-5.5	53	85	16	8	16.5	-2.7
Wt	810	Marb +0.74		REA +0.03		Bfat +0.02			
Prog.BW	61	BWt	WWt	WR	ADG	YWt	YR	Scr.	Fr.
WR	101	61	514	101	3.99	1100	108	31	5.0
YR	108								
Wean Pct.	56%								
Cow Eff.	118								

★★★★★ for Low Maintenance, Growth, Marbling, High Cow Efficiency, Calving Ease, Stayability.

191 BECKTON NEBULA A777 J3 1-A 100% # 1626488 Tat.: BKT3 A777



Birth: 4-14-13

Beckton Nebula M045
BECKTON NEBULA T269 E2
 Ref. N-3 Beckton Ruth M967 EP

Beckton Julian U699 L5
BECKTON LARKABA X064 J
 Beckton Larkaba U475 CT

Beckton Neptune R2 K065
 Beckton Belga K285 JL
 Beckton Epic KN H110
 Beckton Ruth A905 SG
 Beckton Julian G1 J526
 Beckton Rose L311 LN
 BKT Clifftop TP R288
 Beckton Larkaba R809 NB

DAM		Calv.Ease	BW	WW	YW	Milk	HPG	Stay	Maint.En.
Age	3	15	-9.0	35	57	21	10	16	-8.3
Wt	800	Marb +0.47		REA +0.08		Bfat +0.03			
Prog.BW	49	BWt	WWt	WR	ADG	YWt	YR	Scr.	Fr.
WR	114	50	537	103	3.71	1110	106	34	5.5
YR	109								
Wean Pct.	62%								
Cow Eff.	131								

★★★★★ for Low Maintenance, Marbling, Superior Cow, High Cow Efficiency, Calving Ease, Stayability.



192 BECKTON CLIFFTOP A314 E4 1-A 100% # 1626455 Tat.: BKT3 A314



Birth: 3-23-13

BKT Clifftop TP R288
BECKTON CLIFFTOP W692 E3
 Ref. C-1 Beckton Lydia S274 EP

Beckton Epic K4 N795
BECKTON KIT W708 E
 Beckton Kit R503 LN

Beckton Clifftop T C075
 Beckton Christy K209 CO
 Beckton Epic KM M115
 Beckton Lydia M607 LO
 Beckton Epic KJ J722
 Beckton Sierra J789 EP
 Beckton Lancer F442 T
 Beckton Kit F468 JL

DAM		Calv.Ease	BW	WW	YW	Milk	HPG	Stay	Maint.En.
Age	4	10	-3.8	42	81	24	5	14	-2.1
Wt	1085	Marb +0.65		REA +0.15		Bfat +0.08			
Prog.BW	NA	BWt	WWt	WR	ADG	YWt	YR	Scr.	Fr.
WR	NA	72	493	92	4.44	1114	105	31	5.0
YR	NA								
Wean Pct.	44%								
Cow Eff.	92								

★★★★★ for Low Maintenance, Growth, Gainability, Marbling, Rib-eye area, Calving Ease, Stayability.

• Bulls •

193 BECKTON LANCER A611 E5 

1-A 100% # 1626490 Tat.: BKT3 A611
 Birth: 4-3-13
 Beckton Lancer T A664
 Bkt Suffeina A828 DM
BECKTON LANCER T371 H4
 Ref. L-2 Beckton Coca F276 HV
 Leachman Heavenly 8141
 Beckton Coca B112 CB
BECKTON EMERA X106 E
 Beckton Epic U126 J5
 Beckton Ruth S076 JT
 Beckton Cherokee N N479
 Beckton Emera U675 CQ
 Beckton Emera P378 LN

DAM		Calv.Ease	BW	WW	YW	Milk	HPG	Stay	Maint.En.
Age	3	12	-4.5	50	76	14	8	14	-3.8
Wt	835	Marb +0.37		REA +0.03		Bfat -.02			
Prog.BW	63	BWt	WWt	WR	ADG	YWt	YR	Scr.	Fr.
WR	100	65	538	104	3.71	1059	102	33	5.5
YR	101								
Wean Pct.	60%								
Cow Eff.	126								

★★★★★ for Low Maintenance, Marbling, High Cow Efficiency, Calving Ease, Stayability.

195 BECKTON DOMINOR A679 L6 

1-A 100% # 1626529 Tat.: BKT3 A679
 Birth: 4-7-13
 Beckton Dominor Z1 R610
 Beckton Sierra K557 LO
BECKTON DOMINOR W640 C5
 Ref. D-1 Beckton Mona R166 CQ
 Beckton Cherokee N N479
 Beckton Mona N342 HU
BECKTON TARA X437 L
 Beckton Lancer T371 H4
 Beckton Ruth S076 JT
 Beckton Cherokee N N479
 Beckton Emera P378 LN
 Beckton Tara T227 JC
 Beckton Justice C1 R483
 Beckton Tara R609 JC

DAM		Calv.Ease	BW	WW	YW	Milk	HPG	Stay	Maint.En.
Age	3	14	-5.6	44	72	17	9	16	0.1
Wt	855	Marb +0.54		REA +0.06		Bfat +0.03			
Prog.BW	63	BWt	WWt	WR	ADG	YWt	YR	Scr.	Fr.
WR	95	65	499	95	3.88	1075	103	31	5.5
YR	100								
Wean Pct.	54%								
Cow Eff.	113								

★★★★★ for Low Maintenance, Marbling, Calving Ease, Stayability.



196 BECKTON HERITAGE A797 L3 

1-A 100% # 1626535 Tat.: BKT3 A797
 Birth: 4-17-13
 Beckton Heritage N013
 Beckton Lana L007 JL
BECKTON HERITAGE X356 E2
 Ref. H-1 Beckton Lana S489 EP
 Beckton Epic K4 N795
 Beckton Lana E136 TP
BECKTON LARKABA X549 L
 Beckton Loki CL S284
 Beckton Larkaba R615 JE
 Beckton Loki C M740
 Beckton Lakme J460 LT
 Beckton Jules L429
 Beckton Larkaba M715 WR

DAM		Calv.Ease	BW	WW	YW	Milk	HPG	Stay	Maint.En.
Age	3	12	-3.1	51	80	16	7	14	-3.4
Wt	915	Marb +0.66		REA -0.03		Bfat +0.04			
Prog.BW	55	BWt	WWt	WR	ADG	YWt	YR	Scr.	Fr.
WR	92	73	548	105	3.65	1095	105	33	5.5
YR	105								
Wean Pct.	56%								
Cow Eff.	117								

★★★★★ for Low Maintenance, Marbling, High Cow Efficiency, Calving Ease, Stayability.

194 BECKTON SCAMP A648 N4 

1-A 100% # 1626401 Tat.: BKT3 A648
 Birth: 4-5-13
 Beckton Scamp T A825
 Beckton Scamp 8954
 Bkt Encino 8459 TJ
BECKTON SCAMP X494 E3
 Ref. S-1 Beckton Lana S074 EP
 Beckton Epic KH P678
 Beckton Lana P317 JL
BECKTON LANA W208 N
 Beckton Nebula L P093
 Beckton Marta M021 LN
 Beckton Nebula M045
 Beckton Loki F251
 Beckton Lana G056 CO

DAM		Calv.Ease	BW	WW	YW	Milk	HPG	Stay	Maint.En.
Age	4	10	-4.2	50	80	15	10	14	-6.8
Wt	1015	Marb +0.54		REA +0.08		Bfat +0.03			
Prog.BW	67	BWt	WWt	WR	ADG	YWt	YR	Scr.	Fr.
WR	95	70	485	87	3.82	1055	98	36	5.0
YR	100								
Wean Pct.	46%								
Cow Eff.	97								

★★★★★ for Low Maintenance, Marbling, Calving Ease, Stayability.

197 BECKTON JULIAN A580 H5 

1-A 100% # 1625949 Tat.: BSF3 A580
 Birth: 4-2-13
 Beckton Julian GJ P535
 Beckton Julian 7526G
 Beckton Mona D086 JL
BECKTON JULIAN G5 S107
 Ref. J-2 Beckton Minola P826 DM
 Beckton Dominor ZC M919
 Beckton Minola M641 WR
BECKTON ENCINO W675 H
 Beckton Hasten H S462
 Beckton Encino S090 JT
 Beckton Hasten P292
 Beckton Lakme G128 HD
 Beckton Jet L P491
 Beckton Encino P300 LN

DAM		Calv.Ease	BW	WW	YW	Milk	HPG	Stay	Maint.En.
Age	4	12	-3.3	46	79	21	13	15	-4.9
Wt	970	Marb +0.45		REA -0.02		Bfat +0.05			
Prog.BW	64	BWt	WWt	WR	ADG	YWt	YR	Scr.	Fr.
WR	97	75	521	98	3.65	1035	98	36	5.0
YR	97								
Wean Pct.	52%								
Cow Eff.	109								

★★★★★ for Low Maintenance, Marbling, Calving Ease, Stayability.

• Bulls •



200 **BECKTON JULIAN A275 L6** 

1-A 100% # 1626526 Tat.: BKT3 A275

Birth: 3-22-13

Beckton Julian G5 S107
BECKTON JULIAN X465 J5
 Ref. J-4 Beckton Suffeina P643 JL
 Beckton Julian GJ P535
 Beckton Minola P826 DM
 Beckton Julian GG B571
 Bkt Suffeina A828 DM
 Beckton Loki C M740
 Beckton Lakme J460 LT
 Beckton Nebula P P707
 Beckton Larkeisa P688 CH

DAM		Calv.Ease	BW	WW	YW	Milk	HPG	Stay	Maint.En.
Age	3	13	-4.4	47	80	16	10	17	-2.9
Wt	970	Marb +0.88		REA -1.13		Bfat +0.04			
Prog.BW	56	BWt	WWt	WR	ADG	YWt	YR	Scr.	Fr.
WR	90	64	484	94	3.76	1013	97	35	5.5
YR	97								
Wean Pct.	46%								
Cow Eff.	96								

★★★★★ for Low Maintenance, Marbling, Calving Ease, Stayability.

198 **BECKTON NEBULA A621 N4** 

1-A 100% # 1626327 Tat.: BKT3 A621

Birth: 4-3-13

Beckton Nebula L P093
BECKTON NEBULA T398 V3
 Ref. N-4 Beckton Minerva J615 VG
 Beckton Nebula M045
 Beckton Marta M021 LN
 Beckton Vegas PK F485
 Beckton Minerva F433 VG
 Beckton Nebula P P707
BECKTON TAMARA U185 NB
 Beckton Tamara P813 CH
 Beckton Nebula M045
 Beckton Lana M809 EP
 Beckton Champ R3 H338
 Beckton Tamara H625 CH

DAM		Calv.Ease	BW	WW	YW	Milk	HPG	Stay	Maint.En.
Age	5	13	-7.2	38	66	20	11	13	-4.5
Wt	1070	Marb +0.65		REA +1.12		Bfat +0.02			
Prog.BW	61	BWt	WWt	WR	ADG	YWt	YR	Scr.	Fr.
WR	104	60	487	91	3.76	1014	96	35	5.0
YR	101								
Wean Pct.	46%								
Cow Eff.	96								

★★★★★ for Low Maintenance, Marbling, Calving Ease, Stayability.

201 **BECKTON SCAMP A643 L4** 

1-A 100% # 1626244 Tat.: BKT3 A643

Birth: 4-4-13

Beckton Scamp T A825
BECKTON SCAMP X494 E3
 Ref. S-1 Beckton Lana S074 EP
 Beckton Scamp 8954
 Bkt Encino 8459 TJ
 Beckton Epic KH P678
 Beckton Lana P317 JL
 Beckton Lancer TA K644
BKT LARKEISA S605 LN
 BKT Larkeisa M816 EP
 Beckton Epic KJ J722
 BKT Larkeisa J076 DM

DAM		Calv.Ease	BW	WW	YW	Milk	HPG	Stay	Maint.En.
Age	7	9	-0.3	50	75	16	9	11	-10.7
Wt	1190	Marb +0.50		REA +1.13		Bfat +0.00			
Prog.BW	79	BWt	WWt	WR	ADG	YWt	YR	Scr.	Fr.
WR	96	84	479	90	3.60	1010	96	37	5.0
YR	98								
Wean Pct.	40%								
Cow Eff.	85								

★★★★★ for Low Maintenance, Marbling, Rib-eye area, Calving Ease.

199 **BECKTON NEBULA A883 O3** 

1-A 100% # 1625889 Tat.: BSF3 A883

Birth: 4-30-13

Beckton Nebula M045
BECKTON NEBULA T269 E2
 Ref. N-3 Beckton Ruth M967 EP
 Beckton Roman J S158
BECKTON CHRISTY U702 RA
 Beckton Christy S699 JL
 Beckton Neptune R2 K065
 Beckton Belga K285 JL
 Beckton Epic KN H110
 Beckton Ruth A905 SG
 TR Romeo NT379
 Beckton Belga K285 JL
 Beckton Julian G2 M345
 Beckton Christy C306 JL

DAM		Calv.Ease	BW	WW	YW	Milk	HPG	Stay	Maint.En.
Age	5	12	-1.6	55	87	17	7	14	-2.6
Wt	1110	Marb +0.42		REA +1.17		Bfat +0.02			
Prog.BW	72	BWt	WWt	WR	ADG	YWt	YR	Scr.	Fr.
WR	110	81	562	101	3.15	1089	101	33	5.0
YR	107								
Wean Pct.	51%								
Cow Eff.	107								

★★★★★ for Low Maintenance, Marbling, Rib-eye area, Superior Cow, Calving Ease, Stayability.

202 **BECKTON DOMINOR A279 N7** 

1-A 100% # 1626574 Tat.: BKT3 A279

Birth: 3-22-13

Beckton Dominor W640 C5
BECKTON DOMINOR Y052 N6
 Ref. D-3 Beckton Indigo W772 N
 Beckton Dominor Z1 R610
 Beckton Mona R166 CQ
 Beckton Nebula T398 V3
 Beckton Indigo T613 JT
 Beckton Nebula L P093
 Beckton Belga R716 DM
 Beckton Hasten H S462
 Beckton Eola N491 LN

DAM		Calv.Ease	BW	WW	YW	Milk	HPG	Stay	Maint.En.
Age	2	11	-1.3	56	91	17	9.5	17	-3.6
Wt	840	Marb +0.60		REA +0.06		Bfat +0.04			
Prog.BW	73	BWt	WWt	WR	ADG	YWt	YR	Scr.	Fr.
WR	101	73	515	101	3.88	1053	103	32	5.0
YR	103								
Wean Pct.	54%								
Cow Eff.	114								

★★★★★ for Low Maintenance, Marbling, Calving Ease, Stayability.

• Bulls •

203 **BECKTON JULIAN A419 C6** 

1-A 100% # 1625978 Tat.: BSF3 A419

Birth: 3-27-13

BECKTON JULIAN X465 J5
Ref. J-4

- Beckton Julian G5 S107
- Beckton Suffeina P643 JL

BECKTON SIERRA X018 C

- Beckton Clifftop U575 H3
- Beckton Sierra U462 CT

- Beckton Julian GJ P535
- Beckton Minola P826 DM
- Beckton Julian GG B571
- Bkt Suffeina A828 DM
- BKT Clifftop TP R288
- Beckton Larkabel N769 HR
- Beckton Clifftop T3 N800
- Beckton Sierra R144 NW

DAM		Calv.Ease	BW	WW	YW	Milk	HPG	Stay	Maint.En.
Age	3	9	-4.4	43	78	17	11	17	-4.0
Wt	875								
Prog.BW	59								
WR	99		Marb	+73	REA	+08		Bfat	+03
YR	100								
Wean Pct.	52%	BWt	WWt	WR	ADG	YWt	YR	Scr.	Fr.
Cow Eff.	110	57	496	96	4.05	1030	99	33	5.0

★★★★★ for Low Maintenance, Gainability, Marbling, Calving Ease, Stayability.

205 **BECKTON NEBULA A731 E4** 

1-A 100% # 1626204 Tat.: BKT3 A731

Birth: 4-10-13

BECKTON NEBULA T398 V3
Ref. N-4

- Beckton Nebula L P093
- Beckton Minerva J615 VG

BECKTON VERNICE R416 EP

- Beckton Epic K3 M606
- Beckton Vernice K482 HD

- Beckton Nebula M045
- Beckton Marta M021 LN
- Beckton Vegas PK F485
- Beckton Minerva F433 VG
- Beckton Epic KJ J722
- Beckton Lana F268 CT
- Beckton Hadrian F C486
- Beckton Vernice F513 CL

DAM		Calv.Ease	BW	WW	YW	Milk	HPG	Stay	Maint.En.
Age	8	12	-3.9	42	67	16	12	10	-6.7
Wt	1225								
Prog.BW	68								
WR	100		Marb	+31	REA	+03		Bfat	+01
YR	103								
Wean Pct.	41%	BWt	WWt	WR	ADG	YWt	YR	Scr.	Fr.
Cow Eff.	87	74	507	95	3.26	1018	96	35	5.0

★★★★★ for Low Maintenance, Marbling, Calving Ease.



206 **BECKTON SCAMP A551 J4** 

1-A 100% # 1625921 Tat.: BSF3 A551

Birth: 4-1-13

BECKTON SCAMP X494 E3
Ref. S-1

- Beckton Scamp T A825
- Beckton Lana S074 EP

BECKTON LANA W314 J

- Beckton Jet L P491
- Beckton Lana S866 CH

- Beckton Scamp 8954
- Bkt Encino 8459 TJ
- Beckton Epic KH P678
- Beckton Lana P317 JL
- TR Julian LT151
- Beckton Minerva L278 LN
- Beckton Champ R1 H024
- Beckton Lana L519 CH

DAM		Calv.Ease	BW	WW	YW	Milk	HPG	Stay	Maint.En.
Age	4	13	-4.6	44	69	20	10	13	-7.5
Wt	970								
Prog.BW	65								
WR	92		Marb	+53	REA	+19		Bfat	+01
YR	97								
Wean Pct.	46%	BWt	WWt	WR	ADG	YWt	YR	Scr.	Fr.
Cow Eff.	97	72	468	88	3.09	967	91	35	5.5

★★★★★ for Low Maintenance, Marbling, Rib-eye area, Calving Ease, Stayability.

204 **BECKTON EPIC A753 N7** 

1-A 100% # 1626551 Tat.: BKT3 A753

Birth: 4-12-13

BECKTON EPIC X330 L6
Ref. E-3

- Beckton Epic T330 L5
- Beckton Kit R503 LN

BECKTON COCA X701 N

- Beckton Nebula T398 V3
- Beckton Coca T499 SC

- Beckton Epic K4 N795
- Beckton Belga K202 LN
- Beckton Lancer F442 T
- Beckton Kit F468 JL
- Beckton Nebula L P093
- Beckton Minerva J615 VG
- Beckton Scamp T A825
- Beckton Coca M528 JC

DAM		Calv.Ease	BW	WW	YW	Milk	HPG	Stay	Maint.En.
Age	3	11	-4.5	48	82	16	9	14	-7.0
Wt	845								
Prog.BW	63								
WR	105		Marb	+59	REA	+27		Bfat	+03
YR	100								
Wean Pct.	60%	BWt	WWt	WR	ADG	YWt	YR	Scr.	Fr.
Cow Eff.	126	63	545	104	3.43	1062	101	33	5.5

★★★★★ for Low Maintenance, Marbling, Rib-eye area, High Cow Efficiency, Calving Ease, Stayability.



• Bulls •

207 BECKTON NEBULA A608 N3 

1-A 100% # 1626451 Tat.: BKT3 A608

Birth: 4-3-13

Beckton Nebula M045
BECKTON NEBULA T269 E2
 Ref. N-3 Beckton Ruth M967 EP

Beckton Neptune R2 K065
 Beckton Belga K285 JL
 Beckton Epic KN H110
 Beckton Ruth A905 SG

Beckton Nebula T398 V3
BECKTON LARKEISA W687 N
 BKT Larkeisa T525 EP

Beckton Nebula L P093
 Beckton Minerva J615 VG
 Beckton Epic KM M115
 Beckton Larkeisa P519 NM

DAM		Calv.Ease	BW	WW	YW	Milk	HPG	Stay	Maint.En.
Age	4	13	-7.1	35	58	20	9	13	-6.5
Wt	1100	Marb +.48		REA -.03		Bfat +.02			
Prog.BW	68	BWt	WWt	WR	ADG	YWt	YR	Scr.	Fr.
WR	97	62	460	83	3.65	1010	93	34	5.5
YR	97								
Wean Pct.	40%								
Cow Eff.	84								

★★★★★ for Low Maintenance, Marbling, Calving Ease, Stayability.

210 BECKTON LANCER A752 L5 

1-A 100% # 1625992 Tat.: BSF3 A752

Birth: 4-11-13

Beckton Lancer F442 T
BECKTON LANCER T371 H4
 Ref. L-2 Beckton Coca F276 HV

Beckton Lancer T A664
 Bkt Suffeina A828 DM
 Leachman Heavenly 8141
 Beckton Coca B112 CB

Beckton Likable U120 L2
BECKTON MINOLA X107 L
 Beckton Minola U188 NB

Beckton Likable S633
 Beckton Lana S718 LN
 Beckton Nebula P P707
 Beckton Minola N729 JL

DAM		Calv.Ease	BW	WW	YW	Milk	HPG	Stay	Maint.En.
Age	3	11	-4.3	53	84	13	7	15	-1.1
Wt	820	Marb +.48		REA +.12		Bfat -.01			
Prog.BW	59	BWt	WWt	WR	ADG	YWt	YR	Scr.	Fr.
WR	105	64	568	110	2.87	1031	99	33	5.5
YR	106								
Wean Pct.	65%								
Cow Eff.	136								

★★★★★ for Low Maintenance, Marbling, Superior Cow, High Cow Efficiency, Calving Ease, Stayability.

208 BECKTON DOMINOR A019 J7 

1-A 100% # 1626702 Tat.: BKB3 A019

Birth: 3-5-13

Beckton Dominor W640 C5
BECKTON DOMINOR Y052 N6
 Ref. D-3 Beckton Indigo W772 N

Beckton Dominor Z1 R610
 Beckton Mona R166 CQ
 Beckton Nebula T398 V3
 Beckton Indigo T613 JT

Beckton Julian W743 H5
BECKTON INDIGO Y248 J
 Beckton Indigo W456 E

Beckton Julian G5 S107
 Beckton Kit L399 HR
 Beckton Epitomy S250
 Beckton Indigo M514 CH

DAM		Calv.Ease	BW	WW	YW	Milk	HPG	Stay	Maint.En.
Age	2	12	-5.3	44	77	17	9.5	17	-3.2
Wt	805	Marb +.64		REA -.15		Bfat +.04			
Prog.BW	52	BWt	WWt	WR	ADG	YWt	YR	Scr.	Fr.
WR	94	52	480	94	3.71	1008	99	34	5.0
YR	99								
Wean Pct.	52%								
Cow Eff.	110								

★★★★★ for Low Maintenance, Marbling, Calving Ease, Stayability.

211 BECKTON HERITAGE A688 J3 

1-A 100% # 1626187 Tat.: BKT3 A688

Birth: 4-7-13

Beckton Heritage N013
BECKTON HERITAGE X356 E2
 Ref. H-1 Beckton Lana S489 EP

Beckton Hustler C2 L079
 Beckton Lana L007 JL
 Beckton Epic K4 N795
 Beckton Lana E136 TP

Beckton Julian GG B571
BECKTON SUFFEINA P643 JL
 Bkt Suffeina A828 DM

Beckton Julian 7526G
 Bkt Marta 9A13 JL
 Beckton Dominor 9455
 Bkt Suffeina 9493 TT

DAM		Calv.Ease	BW	WW	YW	Milk	HPG	Stay	Maint.En.
Age	9	10	-1.3	56	91	17	7	13	-3.4
Wt	1110	Marb +.85		REA +.07		Bfat +.01			
Prog.BW	78	BWt	WWt	WR	ADG	YWt	YR	Scr.	Fr.
WR	107	81	582	104	3.26	1086	100	37	5.0
YR	107								
Wean Pct.	53%								
Cow Eff.	110								

★★★★★ for Low Maintenance, Marbling, Superior Cow, Calving Ease, Stayability.

209 BECKTON HERITAGE A652 L3 

1-A 100% # 1626182 Tat.: BKT3 A652

Birth: 4-5-13

Beckton Heritage N013
BECKTON HERITAGE X356 E2
 Ref. H-1 Beckton Lana S489 EP

Beckton Hustler C2 L079
 Beckton Lana L007 JL
 Beckton Epic K4 N795
 Beckton Lana E136 TP

Beckton Lancer T4 J536
BECKTON EMERA P378 LN
 Beckton Emera L405 WR

Beckton Lancer TZ D525
 Beckton Vernice D121 VG
 Beckton Warrior C C355
 Beckton Emera D880 CB

DAM		Calv.Ease	BW	WW	YW	Milk	HPG	Stay	Maint.En.
Age	9	8	-4.1	51	83	16	8	12	-4.2
Wt	1140	Marb +.64		REA -.08		Bfat +.02			
Prog.BW	68	BWt	WWt	WR	ADG	YWt	YR	Scr.	Fr.
WR	101	69	505	95	3.09	1007	95	35	5.0
YR	100								
Wean Pct.	44%								
Cow Eff.	93								

★★★★★ for Low Maintenance, Marbling, Calving Ease.



• Bulls •

212 BECKTON NEBULA A204 J3 1-A 100% # 1626372 Tat.: BKT3 A204 

Birth: 3-19-13

Beckton Nebula M045
BECKTON NEBULA T269 E2
 Ref. N-3 Beckton Ruth M967 EP

Beckton Neptune R2 K065
 Beckton Belga K285 JL
 Beckton Epic KN H110
 Beckton Ruth A905 SG

Beckton Julian G5 S107
BECKTON LANA U840 JL
 Beckton Lana S827 JL

Beckton Julian GJ P535
 Beckton Minola P826 DM
 Beckton Julian G2 M345
 Beckton Lana N163 JL

DAM		Calv.Ease	BW	WW	YW	Milk	HPG	Stay	Maint.En.
Age	5	14	-8.1	35	61	18	10	15	-7.1
Wt	960	Marb +.44		REA -.01		Bfat +.06			
Prog.BW	51	BWt	WWt	WR	ADG	YWt	YR	Scr.	Fr.
WR	105	55	527	95	3.43	1032	96	35	4.5
YR	101								
Wean Pct.	55%								
Cow Eff.	116								

★★★★★ for Low Maintenance, Marbling, Calving Ease, Stayability.

215 BECKTON DOMINOR A620 J6 1-A 100% # 1626280 Tat.: BKT3 A620 

Birth: 4-3-13

Beckton Dominor Z1 R610
BECKTON DOMINOR W640 C5
 Ref. D-1 Beckton Mona R166 CQ

Beckton Dominor ZC M919
 Beckton Sierra K557 LO
 Beckton Cherokee N N479
 Beckton Mona N342 HU

Beckton Julian G2 M345
BECKTON COCA T363 JL
 Beckton Coca P435 CH

Beckton Julian GG B571
 Beckton Lana H544 WR
 Beckton Champ R1 H024
 Beckton Coca J882 HR

DAM		Calv.Ease	BW	WW	YW	Milk	HPG	Stay	Maint.En.
Age	6	13	-5.3	48	75	17	11	14	-5.6
Wt	1035	Marb +.60		REA +.03		Bfat +.03			
Prog.BW	70	BWt	WWt	WR	ADG	YWt	YR	Scr.	Fr.
WR	102	69	563	101	3.09	1071	99	36	5.0
YR	103								
Wean Pct.	54%								
Cow Eff.	115								

★★★★★ for Low Maintenance, Marbling, Calving Ease, Stayability.

213 BECKTON JULIAN A086 C6 1-A 100% # 1626392 Tat.: BKT3 A086 

Birth: 3-13-13

Beckton Julian G5 S107
BECKTON JULIAN X465 J5
 Ref. J-4 Beckton Suffeina P643 JL

Beckton Julian GJ P535
 Beckton Minola P826 DM
 Beckton Julian GG B571
 Bkt Suffeina A828 DM

BKT Clifftop TP R288
BKT PINE MARIE W102 C
 BKT Pine Marie M119 EP

Beckton Clifftop T C075
 Beckton Christy K209 CO
 Beckton Epic K F075
 Bkt Pine Marie D126 JL

DAM		Calv.Ease	BW	WW	YW	Milk	HPG	Stay	Maint.En.
Age	4	12	-7.1	40	73	20	13	17	-8.5
Wt	920	Marb +.73		REA +.04		Bfat +.04			
Prog.BW	60	BWt	WWt	WR	ADG	YWt	YR	Scr.	Fr.
WR	105	55	545	98	3.26	1019	94	35	5.0
YR	103								
Wean Pct.	57%								
Cow Eff.	120								

★★★★★ for Low Maintenance, Marbling, Superior Cow, High Cow Efficiency, Calving Ease, Stayability.

216 BECKTON NEBULA A478 H4 2 100% # 1626288 Tat.: BKT3 A478 

Birth: 3-29-13

Beckton Nebula L P093
BECKTON NEBULA W486 D3
 Ref. N-5 Beckton Belga R716 DM

Beckton Nebula M045
 Beckton Marta M021 LN
 Beckton Dominor ZC M919
 Beckton Belga K285 JL

Beckton Heritage N013
BKT SUFFEINA T467 HT
 Beckton Suffeina P671 LN

Beckton Hustler C2 L079
 Beckton Lana L007 JL
 Beckton Lancer T A664
 Bkt Suffeina A828 DM

DAM		Calv.Ease	BW	WW	YW	Milk	HPG	Stay	Maint.En.
Age	6	5.5	-4.9	32	54	7	4	6	3.3
Wt	1190	Marb +.31		REA +.27		Bfat -.03			
Prog.BW	68	BWt	WWt	WR	ADG	YWt	YR	Scr.	Fr.
WR	105	64	588	106	2.98	1053	97	37	5.0
YR	102								
Wean Pct.	49%								
Cow Eff.	104								

★★★★★ for Low Maintenance, Marbling, Rib-eye area, Calving Ease.

214 BECKTON HERITAGE A541 J3 1-A 100% # 1626269 Tat.: BKT3 A541 

Birth: 3-31-13

Beckton Heritage N013
BECKTON HERITAGE X356 E2
 Ref. H-1 Beckton Lana S489 EP

Beckton Hustler C2 L079
 Beckton Lana L007 JL
 Beckton Epic K4 N795
 Beckton Lana E136 TP

Beckton Justice CE R599
BECKTON BELGA T166 JC
 Beckton Belga R127 JC

Beckton Justice C K449
 Beckton Belga M050 EP
 Beckton Justice Cc N265
 Beckton Belga N550 EP

DAM		Calv.Ease	BW	WW	YW	Milk	HPG	Stay	Maint.En.
Age	6	9	-5.3	54	86	17	10	11	-2.5
Wt	1065	Marb +.70		REA -.03		Bfat +.03			
Prog.BW	62	BWt	WWt	WR	ADG	YWt	YR	Scr.	Fr.
WR	105	62	563	105	3.71	1040	98	33	5.0
YR	102								
Wean Pct.	53%								
Cow Eff.	111								

★★★★★ for Low Maintenance, Marbling, Calving Ease.

217 BECKTON LIKABLE A463 C3 1-A 100% # 1626357 Tat.: BKT3 A463 

Birth: 3-28-13

Beckton Likable S633
BECKTON LIKABLE U120 L2
 Ref. L-3 Beckton Lana S718 LN

Beckton Lancer F442 T
 Beckton Kit F468 JL
 Beckton Lancer F442 T
 Beckton Lana F891 JL

Beckton Cherokee N N479
BECKTON EOLA U562 CQ
 Beckton Eola R030 JJ

BFCK Cherokee Cnyn 4912
 Beckton Dinah C440 NM
 Beckton Juno N493
 Beckton Eola N491 LN

DAM		Calv.Ease	BW	WW	YW	Milk	HPG	Stay	Maint.En.
Age	5	8	-3.4	50	74	19	6	15	-5.3
Wt	975	Marb +.51		REA +.38		Bfat +.01			
Prog.BW	75	BWt	WWt	WR	ADG	YWt	YR	Scr.	Fr.
WR	112	71	581	104	2.87	1037	96	36	5.0
YR	106								
Wean Pct.	60%								
Cow Eff.	126								

★★★★★ for Low Maintenance, Marbling, Rib-eye area, Superior Cow, High Cow Efficiency, Calving Ease, Stayability.

• Bulls •

218 **BECKTON JAVELIN A389 J3** 

1-A 100% # 1625816 Tat.: BSF3 A389
 Birth: 3-26-13
BKT JAVELIN 7466 R
 Ref. J
BECKTON ENCINO S059 JT
 Beckton Javelin 6587
 Beckton Rose 6807 RZ
 Beckton Trojan 5253
 Beckton Ileximka -3
 Beckton Raza 2308-N
 Bkt Baya Rose 5195
 Beckton Jet L P491
 Beckton Encino P871 HR
 TR Julian LT151
 Beckton Minerva L278 LN
 Beckton Herald FV J537
 Beckton Encino G341 NP

DAM		Calv.Ease	BW	WW	YW	Milk	HPG	Stay	Maint.En.
Age	7	15	-5.8	28	39	28	12	12	-9.1
Wt	1100	Marb +5.3		REA -0.06		Bfat +0.1			
Prog.BW	67	BWt	WWt	WR	ADG	YWt	YR	Scr.	Fr.
WR	106	72	594	107	2.58	1014	94	35	4.5
YR	98								
Wean Pct.	54%								
Cow Eff.	114								

★★★★★ for Low Maintenance, Marbling, Calving Ease.

220 **BECKTON ACCENT A032 N4** 

1-A 100% # 1626597 Tat.: BKT3 A032
 Birth: 3-8-13
BECKTON ACCENT Y260 L3
 Ref. A-3
BECKTON BELGA Y192 N
 Beckton Accent W180 C2
 Beckton Lana W463 L
 Beckton Cody K1 P014
 Beckton Christy R046 CQ
 Beckton Loki CL S284
 Beckton Lana R327 EP
 Beckton Nebula T398 V3
 Beckton Belga S026 NB
 Beckton Nebula L P093
 Beckton Minerva J615 VG
 Beckton Nebula L P093
 Beckton Belga P119 EP

DAM		Calv.Ease	BW	WW	YW	Milk	HPG	Stay	Maint.En.
Age	2	12	-3.7	59	93	19	10	16.5	-2.6
Wt	750	Marb +5.2		REA +0.09		Bfat +0.3			
Prog.BW	61	BWt	WWt	WR	ADG	YWt	YR	Scr.	Fr.
WR	111	61	562	111	2.75	961	94	35	4.5
YR	94								
Wean Pct.	67%								
Cow Eff.	141								

★★★★★ for Low Maintenance, Marbling, High Cow Efficiency, Calving Ease, Stayability.



221 **BECKTON WARRIOR A325 J5** 

1-A 100% # 1626330 Tat.: BKT3 A325
 Birth: 3-24-13
BECKTON WARRIOR W534 N4
 Ref. W-2
BECKTON MARTA U273 JL
 Beckton Warrior C1 S337
 BKT Larkeisa S055 NB
 Beckton Warrior CL M686
 Beckton Christy K101 CD
 Beckton Nebula P P707
 Beckton Larkeisa P688 CH
 Beckton Julian GJ P535
 Beckton Marta G675 LN
 Beckton Julian 7526G
 Beckton Mona D086 JL
 Beckton Lancer T A664
 Bkt Marta 9A13 JL

DAM		Calv.Ease	BW	WW	YW	Milk	HPG	Stay	Maint.En.
Age	5	17	-7.3	44	69	12	12	15	-5.7
Wt	970	Marb +6.2		REA +0.02		Bfat +0.05			
Prog.BW	56	BWt	WWt	WR	ADG	YWt	YR	Scr.	Fr.
WR	94	63	541	97	2.92	1004	93	32	4.5
YR	94								
Wean Pct.	56%								
Cow Eff.	117								

★★★★★ for Low Maintenance, Marbling, High Cow Efficiency, Calving Ease, Stayability.

219 **BECKTON LANCER A579 N5** 

1-A 100% # 1625936 Tat.: BSF3 A579
 Birth: 4-2-13
BECKTON LANCER T371 H4
 Ref. L-2
BECKTON UCOLA W459 N
 Beckton Lancer F442 T
 Beckton Coca F276 HV
 Beckton Nebula EN S347
 Beckton Ucola S513 HU
 Beckton Lancer T A664
 Bkt Suffeina A828 DM
 Leachman Heavenly 8141
 Beckton Coca B112 CB
 Beckton Nebula E P084
 Beckton Eola P530 NB
 Beckton Hustler C2 L079
 Beckton Ucola L781 HU

DAM		Calv.Ease	BW	WW	YW	Milk	HPG	Stay	Maint.En.
Age	4	11	-5.9	49	75	15	10	13	-1.2
Wt	815	Marb +4.4		REA -1.12		Bfat -0.1			
Prog.BW	64	BWt	WWt	WR	ADG	YWt	YR	Scr.	Fr.
WR	107	62	589	106	3.20	1032	95	34	5.5
YR	102								
Wean Pct.	70%								
Cow Eff.	147								

★★★★★ for Low Maintenance, Marbling, High Cow Efficiency, Calving Ease, Stayability.

222 **BECKTON DOMINOR A026 N7** 

1-A 100% # 1626634 Tat.: BKT3 A026
 Birth: 3-7-13
BECKTON DOMINOR Y005 V6
 Ref. D-2
BECKTON SIERRA Y441 N
 Beckton Dominor W640 C5
 Beckton Belga W108 V
 Beckton Nebula T269 E2
 Beckton Sierra S120 HW
 Beckton Dominor Z1 R610
 Beckton Mona R166 CQ
 Beckton Vega P079
 Beckton Belga K476 JL
 Beckton Nebula M045
 Beckton Ruth M967 EP
 Beckton Hawk P248
 Beckton Sierra P348 JO

DAM		Calv.Ease	BW	WW	YW	Milk	HPG	Stay	Maint.En.
Age	2	14	-5.9	50	81	22	9	16.5	-3.8
Wt	785	Marb +6.6		REA +0.07		Bfat +0.3			
Prog.BW	54	BWt	WWt	WR	ADG	YWt	YR	Scr.	Fr.
WR	111	54	549	111	3.09	993	100	34	5.0
YR	100								
Wean Pct.	62%								
Cow Eff.	131								

★★★★★ for Low Maintenance, Marbling, High Cow Efficiency, Calving Ease, Stayability.

• Bulls •

223 **BECKTON NEBULA A617 J3** 

1-A 100% # 1626186 Tat.: BKT3 A617

Birth: 4-3-13

Beckton Nebula M045
BECKTON NEBULA T269 E2
 Ref. N-3 Beckton Ruth M967 EP

Beckton Neptune R2 K065
 Beckton Belga K285 JL
 Beckton Epic KN H110
 Beckton Ruth A905 SG
 Beckton Justice C K449
 Beckton Ruth K802 HD
 Beckton Justice C K449
 Beckton Sheba M054 JC
 Beckton Sheba K206 JC

DAM		Calv.Ease	BW	WW	YW	Milk	HPG	Stay	Maint.En.
Age	9	11	-5.0	50	79	13	10	13	-5.1
Wt	1055	Marb +.55		REA +.02		Bfat +.02			
Prog.BW	76	BWt	WWt	WR	ADG	YWt	YR	Scr.	Fr.
WR	104	64	537	96	3.32	1007	93	35	5.0
YR	103								
Wean Pct.	51%								
Cow Eff.	107								

★★★★★ for Low Maintenance, Marbling, Superior Cow, Calving Ease, Stayability.

225 **BECKTON JULIAN A374 N6** 

1-A 100% # 1626518 Tat.: BKT3 A374

Birth: 3-25-13

Beckton Julian G5 S107
BECKTON JULIAN W743 H5
 Ref. J-3 Beckton Kit L399 HR

Beckton Julian GJ P535
 Beckton Minola P826 DM
 Beckton Herald F FA20
 Beckton Kit F468 JL
 Beckton Nebula M045
 Beckton Ruth M967 EP
 Beckton Jules L429
 BKT Pine Marie M119 EP

DAM		Calv.Ease	BW	WW	YW	Milk	HPG	Stay	Maint.En.
Age	3	13	-4.0	45	74	21	11	17	-5.6
Wt	885	Marb +.58		REA -.04		Bfat +.05			
Prog.BW	64	BWt	WWt	WR	ADG	YWt	YR	Scr.	Fr.
WR	107	67	549	106	3.43	1010	97	35	5.0
YR	101								
Wean Pct.	58%								
Cow Eff.	121								

★★★★★ for Low Maintenance, Marbling, High Cow Efficiency, Calving Ease, Stayability.

224 **BECKTON JAVELIN A308 C3** 

1-A 100% # 1626554 Tat.: BKT3 A308

Birth: 3-23-13

Beckton Javelin 6587
BKT JAVELIN 7466 R
 Ref. J Beckton Rose 6807 RZ

Beckton Trojan 5253
 Beckton Ileximka -3
 Beckton Raza 2308-N
 Bkt Baya Rose 5195
 Beckton Cherokee N N479
 Beckton Annie M337 LN
 Beckton Julian GG B571
 Beckton Denise J550 CD

DAM		Calv.Ease	BW	WW	YW	Milk	HPG	Stay	Maint.En.
Age	3	14	-5.4	31	49	24	13	13	-9.8
Wt	1000	Marb +.52		REA -.10		Bfat +.02			
Prog.BW	61	BWt	WWt	WR	ADG	YWt	YR	Scr.	Fr.
WR	104	63	542	104	3.26	1007	96	36	5.0
YR	96								
Wean Pct.	50%								
Cow Eff.	106								

★★★★★ for Low Maintenance, Marbling, Calving Ease, Stayability.

226 **BECKTON LEGEND A788 E2** 

1-A 100% # 1626337 Tat.: BKT3 A788

Birth: 4-15-13

Beckton Lancer F442 T
BECKTON LEGEND S670
 Ref. L-1 Beckton Kit F468 JL

Beckton Lancer T A664
 Bkt Suffeina A828 DM
 Beckton Julian GG B571
 Beckton Kit A517 NP
 Beckton Epic KM M115
 Beckton Sierra N703 LM
 Beckton Lancer T9 N586
 Beckton Lana L007 JL

DAM		Calv.Ease	BW	WW	YW	Milk	HPG	Stay	Maint.En.
Age	5	12	-7.0	43	69	19	9	14	-6.6
Wt	1075	Marb +.76		REA +.37		Bfat +.04			
Prog.BW	69	BWt	WWt	WR	ADG	YWt	YR	Scr.	Fr.
WR	112	57	572	107	2.64	1027	97	35	5.0
YR	106								
Wean Pct.	53%								
Cow Eff.	112								

★★★★★ for Low Maintenance, Marbling, Rib-eye area, Superior Cow, Calving Ease, Stayability.



227 **BECKTON DOMINOR A634 N6** 

2 100% # 1626439 Tat.: BKT3 A634

Birth: 4-4-13

Beckton Dominor Z1 R610
BECKTON DOMINOR W640 C5
 Ref. D-1 Beckton Mona R166 CQ

Beckton Dominor ZC M919
 Beckton Sierra K557 LO
 Beckton Cherokee N N479
 Beckton Mona N342 HU
 Beckton Nebula M045
 Beckton Marta M021 LN
 Beckton Nebula M045
 Beckton Eola M663 EP

DAM		Calv.Ease	BW	WW	YW	Milk	HPG	Stay	Maint.En.
Age	4	16	-7.5	43	67	17	12	15	-4.0
Wt	905	Marb +.64		REA -.14		Bfat +.06			
Prog.BW	61	BWt	WWt	WR	ADG	YWt	YR	Scr.	Fr.
WR	102	65	534	100	2.98	992	94	33	4.5
YR	97								
Wean Pct.	57%								
Cow Eff.	120								

★★★★★ for Low Maintenance, Marbling, High Cow Efficiency, Calving Ease, Stayability.

• Bulls •

228 BECKTON WARRIOR A334 J5 1-A 100% # 1626230 Tat.: BKT3 A334



Birth: 3-24-13

Beckton Warrior C1 S337
BECKTON WARRIOR W534 N4
 Ref. W-2 BKT Larkeisa S055 NB

Beckton Warrior CL M686
 Beckton Christy K101 CD
 Beckton Nebula P P707
 Beckton Larkeisa P688 CH

Beckton Julian G1 J526
BECKTON KIT S271 JL
 Beckton Kit L399 HR

Beckton Julian GG B571
 Beckton Annie F743 LN
 Beckton Herald F FA20
 Beckton Kit F468 JL

DAM		Calv.Ease	BW	WW	YW	Milk	HPG	Stay	Maint.En.
Age	7	17	-11.0	38	60	19	10	14	-1.5
Wt	1130	Marb +0.70		REA +0.20		Bfat +0.06			
Prog.BW	55	BWt	WWt	WR	ADG	YWt	YR	Scr.	Fr.
WR	106	46	512	96	3.76	1039	98	35	4.0
YR	104								
Wean Pct.	45%								
Cow Eff.	95								

★★★★★ for Low Maintenance, Marbling, Rib-eye area, Superior Cow, Calving Ease, Stayability.

230 BECKTON VANTAGE A640 J2 1-A 100% # 1626462 Tat.: BKT3 A640



Birth: 4-4-13

Beckton Nomad 7496
BECKTON NOMAD T 9A14
 Ref. v-1 Beckton Lana 7152 TJ

Beckton Neva 5562
 Bkt Bolt Tamrck 3913
 Beckton Trojan 5253
 Bkt Signal Lana 5599

Beckton Julio L233
BECKTON LARKEISA W770 J
 Beckton Larkeisa N897 HR

Beckton Julian G1 J526
 Beckton Rose J725 EP
 Beckton Herald H1 H348
 Bkt Larkeisa D262 JL

DAM		Calv.Ease	BW	WW	YW	Milk	HPG	Stay	Maint.En.
Age	4	16	-5.4	27	34	17	11	10	-7.2
Wt	915	Marb +0.40		REA -0.23		Bfat +0.02			
Prog.BW	66	BWt	WWt	WR	ADG	YWt	YR	Scr.	Fr.
WR	102	76	550	99	2.98	992	92	36	5.0
YR	98								
Wean Pct.	58%								
Cow Eff.	122								

★★★★★ for Low Maintenance, Marbling, High Cow Efficiency, Calving Ease.



231 BECKTON LANCER A657 J5 1-A 100% # 1626339 Tat.: BKT3 A657



Birth: 4-5-13

Beckton Lancer F442 T
BECKTON LANCER T371 H4
 Ref. L-2 Beckton Coca F276 HV

Beckton Lancer T A664
 Bkt Suffeina A828 DM
 Leachman Heavenly 8141
 Beckton Coca B112 CB

Beckton Julian G3 P608
BECKTON LANA U422 JL
 Beckton Lana R128 LS

Beckton Julian GG B571
 Bkt Suffeina A828 DM
 Beckton Laser N602
 Beckton Lana N378 LN

DAM		Calv.Ease	BW	WW	YW	Milk	HPG	Stay	Maint.En.
Age	5	11	-6.5	45	76	12	7	13	-1.2
Wt	1090	Marb +0.43		REA +0.04		Bfat -0.03			
Prog.BW	63	BWt	WWt	WR	ADG	YWt	YR	Scr.	Fr.
WR	95	59	520	93	3.48	1013	94	32	5.0
YR	96								
Wean Pct.	48%								
Cow Eff.	100								

★★★★★ for Low Maintenance, Marbling, Calving Ease, Stayability.

229 BECKTON EPIC A039 E7 1-A 100% # 1626099 Tat.: BSF3 A039



Birth: 3-8-13

Beckton Epic U749 D5
BECKTON EPIC Y484 N6
 Ref. E-5 Beckton Lydia S069 NB

Beckton Epic K4 N795
 Beckton Denise R308 DM
 Beckton Nebula P P707
 Beckton Lydia P583 WR

Beckton Epic U749 D5
BECKTON LARKABEL Y286 E
 Bkt Larkabel K768 EP

Beckton Epic K4 N795
 Beckton Denise R308 DM
 Beckton Epic K F075
 Bkt Larkabel E645 MB

DAM		Calv.Ease	BW	WW	YW	Milk	HPG	Stay	Maint.En.
Age	2	11	-2.6	60	104	17	8	15	0.1
Wt	855	Marb +0.56		REA +0.28		Bfat +0.02			
Prog.BW	66	BWt	WWt	WR	ADG	YWt	YR	Scr.	Fr.
WR	104	66	513	104	3.37	1020	102	31	5.0
YR	102								
Wean Pct.	53%								
Cow Eff.	111								

★★★★★ for Low Maintenance, Marbling, Rib-eye area, Calving Ease, Stayability.

232 BECKTON CLIFFTOP A303 N4 1-A 100% # 1626514 Tat.: BKT3 A303



Birth: 3-23-13

BKT Clifftop TP R288
BECKTON CLIFFTOP W692 E3
 Ref. C-1 Beckton Lydia S274 EP

Beckton Clifftop T C075
 Beckton Christy K209 CO
 Beckton Epic KM M115
 Beckton Lydia M607 LO

Beckton Nebula T269 E2
BECKTON ANGEL X317 N
 Beckton Angel T772 NB

Beckton Nebula M045
 Beckton Ruth M967 EP
 Beckton Nebula L P093
 Beckton Angel N150 LN

DAM		Calv.Ease	BW	WW	YW	Milk	HPG	Stay	Maint.En.
Age	3	13	-7.7	41	78	22	9	16	-3.3
Wt	940	Marb +0.57		REA -0.10		Bfat +0.07			
Prog.BW	50	BWt	WWt	WR	ADG	YWt	YR	Scr.	Fr.
WR	98	50	507	98	3.99	1103	106	33	4.5
YR	106								
Wean Pct.	50%								
Cow Eff.	105								

★★★★★ for Low Maintenance, Growth, Marbling, Calving Ease, Stayability.

• Bulls •

233 BECKTON DOMINOR A267 W7 1-A 100% # 1626632 Tat.: BKT3 A267



Birth: 3-21-13

BECKTON DOMINOR Y005 V6
Ref. D-2

- Beckton Dominor W640 C5
- Beckton Belga W108 V
- Beckton Dominor Z1 R610
- Beckton Mona R166 CQ
- Beckton Vega P079
- Beckton Belga K476 JL
- Beckton Warrior N645 T1
- Beckton Kit R503 LN
- Beckton Julian G2 M345
- Beckton Lana G592 LN

BECKTON LANA Y420 W
Beckton Lana T211 JL

DAM		Calv.Ease	BW	WW	YW	Milk	HPG	Stay	Maint.En.
Age	2	14	-5.5	48	78	16	11	16	-3.5
Wt	785	Marb +.62		REA +.07		Bfat +.03			
Prog.BW	56	BWt	WWt	WR	ADG	YWt	YR	Scr.	Fr.
WR	101	56	515	101	3.76	1053	103	35	5.0
YR	103								
Wean Pct.	58%								
Cow Eff.	122								

★★★★★ for Low Maintenance, Marbling, High Cow Efficiency, Calving Ease, Stayability.

235 BECKTON LIKABLE A609 C4 1-A 100% # 1626642 Tat.: BKT3 A609



Birth: 4-3-13

BECKTON LIKABLE Y362 L3
Ref. L-6

- Beckton Likable U130 L2
- Beckton Tamara M515 LN
- Beckton Likable S633
- Beckton Kit S478 LN
- Beckton Lancer TA K644
- Beckton Tamara K322 LN
- BKT Clifftop TP R288
- BKT Pine Marie R213 EP
- Beckton Nomad T 9A14
- Beckton Suffeina P603 JL

BECKTON SUFFEINA Y489 C
Beckton Suffeina W369 N

DAM		Calv.Ease	BW	WW	YW	Milk	HPG	Stay	Maint.En.
Age	2	11	-2.6	45	77	15	10	15	-2.1
Wt	765	Marb +.67		REA +.18		Bfat +.05			
Prog.BW	65	BWt	WWt	WR	ADG	YWt	YR	Scr.	Fr.
WR	98	65	497	98	4.10	1061	104	34	5.0
YR	104								
Wean Pct.	57%								
Cow Eff.	120								

★★★★★ for Low Maintenance, Gainability, Marbling, Rib-eye area, High Cow Efficiency, Calving Ease, Stayability.

234 BECKTON LIKABLE A033 L4 1-A 100% # 1626115 Tat.: BSF3 A033



Birth: 3-8-13

BECKTON LIKABLE Y675 E3
Ref. L-7

- Beckton Likable U120 L2
- Beckton Firefly T331 EP
- Beckton Likable S633
- Beckton Lana S718 LN
- Beckton Epic KM M115
- Beckton Firefly N457 CO
- Beckton Likable S633
- Beckton Lana S718 LN
- Beckton Champ R1 H024
- Beckton Christy K209 CO

BECKTON CHRISTY Y428 L
Beckton Christy P333 CH

DAM		Calv.Ease	BW	WW	YW	Milk	HPG	Stay	Maint.En.
Age	2	9	-5.7	40	65	21	8	18	-1.7
Wt	745	Marb +.52		REA +.35		Bfat +.01			
Prog.BW	51	BWt	WWt	WR	ADG	YWt	YR	Scr.	Fr.
WR	97	51	495	97	3.65	985	96	35	4.5
YR	96								
Wean Pct.	58%								
Cow Eff.	123								

★★★★★ for Low Maintenance, Marbling, Rib-eye area, High Cow Efficiency, Calving Ease, Stayability.

236 BECKTON HERITAGE A779 H3 1-A 100% # 1626380 Tat.: BKT3 A779



Birth: 4-14-13

BECKTON HERITAGE X356 E2
Ref. H-1

- Beckton Heritage N013
- Beckton Lana S489 EP
- Beckton Hustler C2 L079
- Beckton Lana L007 JL
- Beckton Epic K4 N795
- Beckton Lana E136 TP
- Beckton Heritage N013
- Beckton Coca P602 JL
- Beckton Heritage N013
- Beckton Suffeina P671 LN

BECKTON SUFFEINA W047 H
BKT Suffeina T467 HT

DAM		Calv.Ease	BW	WW	YW	Milk	HPG	Stay	Maint.En.
Age	4	9	-4.8	59	95	15	5	12	-1.6
Wt	1015	Marb +.84		REA +.02		Bfat +.04			
Prog.BW	66	BWt	WWt	WR	ADG	YWt	YR	Scr.	Fr.
WR	111	62	531	95	3.09	1031	95	33	5.0
YR	100								
Wean Pct.	50%								
Cow Eff.	106								

★★★★★ for Low Maintenance, Marbling, Calving Ease.



237 BECKTON JULIAN A505 E6 1-A 100% # 1626491 Tat.: BKT3 A505



Birth: 3-30-13

BECKTON JULIAN W743 H5
Ref. J-3

- Beckton Julian G5 S107
- Beckton Kit L399 HR
- Beckton Julian GJ P535
- Beckton Minola P826 DM
- Beckton Herald F FA20
- Beckton Kit F468 JL
- Beckton Epic K7 S583
- Beckton Ruth S076 JT
- Beckton Epic K7 S583
- Beckton Susan S266 EP

BECKTON SUSAN X112 E
Beckton Susan U015 EP

DAM		Calv.Ease	BW	WW	YW	Milk	HPG	Stay	Maint.En.
Age	3	12	-1.9	46	74	21	11	14	-6.1
Wt	740	Marb +.67		REA -.05		Bfat +.04			
Prog.BW	65	BWt	WWt	WR	ADG	YWt	YR	Scr.	Fr.
WR	100	74	522	100	3.54	1022	98	33	5.0
YR	98								
Wean Pct.	65%								
Cow Eff.	137								

★★★★★ for Low Maintenance, Marbling, High Cow Efficiency, Calving Ease, Stayability.

• Bulls •

238 BECKTON CLIFFTOP A778 N4 

1-A 100% # 1626013 Tat.: BSF3 A778

Birth: 4-14-13
BECKTON CLIFFTOP W692 E3
 Ref. C-1

Beckton Cliff TP R288
 Beckton Lydia S274 EP
BECKTON INDIGO X239 N
 Beckton Nebula J R475
 Beckton Indigo R567 WA

Beckton Clifftop T C075
 Beckton Christy K209 CO
 Beckton Epic KM M115
 Beckton Lydia M607 LO
 Beckton Nebula M045
 Beckton Larkeisa M138 JC
 Beckton Warhawk N560
 Beckton Indigo N754 HR

DAM		Calv.Ease	BW	WW	YW	Milk	HPG	Stay	Maint.En.
Age	3	11	-3.8	48	88	17	13	15	-2.1
Wt	985								
Prog.BW	64								
WR	89			Marb +.59	REA +.02			Bfat +.07	
YR	101								
Wean Pct.	50%								
Cow Eff.	105								
DAM		BWt	WWt	WR	ADG	YWt	YR	Scr.	Fr.
		65	532	102	3.09	1059	101	32	4.5

★★★★★ for Low Maintenance, Marbling, Calving Ease, Stayability.



239 BECKTON LEGEND A865 E3 

1-A 100% # 1626449 Tat.: BKT3 A865

Birth: 4-25-13
BECKTON LEGEND U331 E2
 Ref. L-4

Beckton Legend S670
 Beckton Lana S669 EP
BECKTON ROSE W656 E
 Beckton Epic K4 N795
 Beckton Rose S269 EP

Beckton Lancer F442 T
 Beckton Kit F468 JL
 Beckton Epic K4 N795
 Beckton Lana M597 LO
 Beckton Epic KJ J722
 Beckton Sierra J789 EP
 Beckton Epic K5 P071
 Beckton Rose P684 JE

DAM		Calv.Ease	BW	WW	YW	Milk	HPG	Stay	Maint.En.
Age	4	12	-4.3	46	81	18	2	14	0.8
Wt	1035								
Prog.BW	72								
WR	108			Marb +1.03	REA -.01			Bfat +.07	
YR	103								
Wean Pct.	53%								
Cow Eff.	111								
DAM		BWt	WWt	WR	ADG	YWt	YR	Scr.	Fr.
		72	567	102	3.99	1073	99	34	5.0

★★★★★ for Low Maintenance, Marbling, Superior Cow, Calving Ease, Stayability.

241 BECKTON LIKABLE A372 L4 

1-A 100% # 1626604 Tat.: BKT3 A372

Birth: 3-25-13
BECKTON LIKABLE Y675 E3
 Ref. L-7

Beckton Likable U120 L2
 Beckton Firefly T331 EP
BKT PINE MARIE Y230 L
 Beckton Likable U120 L2
 BKT Pine Marie R056 CQ

Beckton Likable S633
 Beckton Lana S718 LN
 Beckton Epic KM M115
 Beckton Firefly N457 CO
 Beckton Likable S633
 Beckton Lana S718 LN
 Beckton Cherokee N N479
 BKT Pine Marie N783 CO

DAM		Calv.Ease	BW	WW	YW	Milk	HPG	Stay	Maint.En.
Age	2	6	-3.6	45	72	20	8	19	0.2
Wt	770								
Prog.BW	55								
WR	96			Marb +.65	REA +.21			Bfat +.01	
YR	100								
Wean Pct.	56%								
Cow Eff.	117								
DAM		BWt	WWt	WR	ADG	YWt	YR	Scr.	Fr.
		55	489	96	3.60	1021	100	33	5.0

★★★★★ for Low Maintenance, Marbling, Rib-eye area, High Cow Efficiency, Calving Ease, Stayability.

240 BECKTON LIKABLE A735 N3 

1-A 100% # 1625947 Tat.: BSF3 A735

Birth: 4-10-13
BECKTON LIKABLE U120 L2
 Ref. L-3

Beckton Likable S633
 Beckton Lana S718 LN
BECKTON LANA W664 N
 Beckton Nebula PJ S543
 Beckton Lana S827 JL

Beckton Lancer F442 T
 Beckton Kit F468 JL
 Beckton Lancer F442 T
 Beckton Lana F891 JL
 Beckton Nebula P P707
 Beckton Lana P685 JO
 Beckton Julian G2 M345
 Beckton Lana N163 JL

DAM		Calv.Ease	BW	WW	YW	Milk	HPG	Stay	Maint.En.
Age	4	13	-7.2	43	68	11	7	16	-7.3
Wt	815								
Prog.BW	61								
WR	87			Marb +.54	REA +.29			Bfat +.01	
YR	93								
Wean Pct.	62%								
Cow Eff.	130								
DAM		BWt	WWt	WR	ADG	YWt	YR	Scr.	Fr.
		57	521	93	3.71	1026	95	33	5.0

★★★★★ for Low Maintenance, Marbling, Rib-eye area, High Cow Efficiency, Calving Ease, Stayability.

242 BECKTON NEW ERA A529 L2 

1-A 100% # 1626564 Tat.: BKT3 A529

Birth: 3-31-13
BECKTON NEW ERA Y194
 Ref. N-9

Beckton Nebula P P707
 BKT Larkeisa T310 JC
BECKTON LANA X839 L
 Beckton Legend S670
 Beckton Lana S371 DM

Beckton Nebula M045
 Beckton Lana M809 EP
 Beckton Justice C1 R483
 BKT Larkeisa R775 JC
 Beckton Lancer F442 T
 Beckton Kit F468 JL
 Beckton Dominor ZC M919
 Beckton Lana L367 LN

DAM		Calv.Ease	BW	WW	YW	Milk	HPG	Stay	Maint.En.
Age	3	12	-5.0	63	103	15	10	18	-6.6
Wt	900								
Prog.BW	57								
WR	102			Marb +.89	REA +.09			Bfat +.04	
YR	97								
Wean Pct.	55%								
Cow Eff.	115								
DAM		BWt	WWt	WR	ADG	YWt	YR	Scr.	Fr.
		57	532	102	3.43	1015	97	32	5.0

★★★★★ for Low Maintenance, Marbling, Calving Ease, Stayability.

• Bulls •

243 **BECKTON NEBULA A754 N3** 

1-A 100% # 1626549 Tat.: BKT3 A754
 Birth: 4-12-13
 Beckton Nebula M045
BECKTON NEBULA T269 E2
 Ref. N-3 Beckton Ruth M967 EP
 Beckton Neptune R2 K065
 Beckton Belga K285 JL
 Beckton Epic KN H110
 Beckton Ruth A905 SG
 Beckton Nebula L P093
 Beckton Minerva J615 VG
BKT PINE MARIE X688 N
 Beckton Nebula T398 V3
 BKT Pine Marie T593 HT
 Beckton Heritage N013
 BKT Pine Marie P143 LN

DAM		Calv.Ease	BW	WW	YW	Milk	HPG	Stay	Maint.En.
Age	3	13	-5.7	43	68	16	8	13	-6.9
Wt	760	Marb +5.4		REA +0.5		Bfat +0.3			
Prog.BW	59	BWt	WWt	WR	ADG	YWt	YR	Scr.	Fr.
WR	99	61	523	100	3.32	1020	97	38	5.5
YR	98								
Wean Pct.	64%								
Cow Eff.	134								

★★★★★ for Low Maintenance, Marbling, High Cow Efficiency, Calving Ease, Stayability.

246 **BSF EPIC A345 J6** 

1-B 99% # 1625809 Tat.: BSF3 A345
 Birth: 3-25-13
 Beckton Epic K4 N795
BECKTON EPIC U749 D5
 Ref. E-2 Beckton Denise R308 DM
 Beckton Epic KJ J722
 Beckton Sierra J789 EP
 Beckton Dominor ZC M919
 Beckton Denise L639 JL
 Beckton Julian G1 J526
 Beckton Barona J591 EP
BSF JULESTE R644 JE
 Beckton Jules L429
 BSF Regus D616
 Beckton Dominor S B431
 BSF Regus B319

DAM		Calv.Ease	BW	WW	YW	Milk	HPG	Stay	Maint.En.
Age	8	12	-7.4	43	78	22	8	14	0.7
Wt	1270	Marb +5.5		REA +2.6		Bfat +0.1			
Prog.BW	66	BWt	WWt	WR	ADG	YWt	YR	Scr.	Fr.
WR	106	59	505	95	3.09	965	91	33	4.5
YR	104								
Wean Pct.	40%								
Cow Eff.	84								

★★★★★ for Low Maintenance, Marbling, Rib-eye area, Superior Cow, Calving Ease, Stayability.

244 **BSF LEGEND A527 J2** 

1-B 99% # 1626021 Tat.: BSF3 A527
 Birth: 3-31-13
 Beckton Lancer F442 T
BECKTON LEGEND S670
 Ref. L-1 Beckton Kit F468 JL
 Beckton Lancer T A664
 Bkt Suffeina A828 DM
 Beckton Julian GG B571
 Beckton Kit A517 NP
 Beckton Julian GG B571
 Beckton Lana H544 WR
BSF JULIA X297 J
 Beckton Julian G2 M345
 BSF Julia S169 CD
 Beckton Cody K1 P014
 BSF Julia P361

DAM		Calv.Ease	BW	WW	YW	Milk	HPG	Stay	Maint.En.
Age	3	12	-4.0	49	75	11	6	13	-8.3
Wt	890	Marb +7.9		REA +2.9		Bfat +0.3			
Prog.BW	66	BWt	WWt	WR	ADG	YWt	YR	Scr.	Fr.
WR	98	66	511	98	3.88	1059	101	32	5.0
YR	101								
Wean Pct.	53%								
Cow Eff.	112								

★★★★★ for Low Maintenance, Marbling, Rib-eye area, Calving Ease, Stayability.

247 **BSF ACCENT A014 N4** 

1-B 99% # 1626094 Tat.: BSF3 A014
 Birth: 3-4-13
 Beckton Accent U777 C2
BECKTON ACCENT Y312 N3
 Ref. A-4 BKT Larkeisa S055 NB
 Beckton Cody K1 P014
 Beckton Susan R022 CQ
 Beckton Nebula P P707
 Beckton Larkeisa P688 CH
 Beckton Nebula M045
 Beckton Ruth M967 EP
BSF NEBULANN Y217 N
 Beckton Nebula T269 E2
 BSF Regus J077
 Beckton Copper JT G095
 BSF Red G041

DAM		Calv.Ease	BW	WW	YW	Milk	HPG	Stay	Maint.En.
Age	2	12	-4.5	51	83	21	8	17	-6.0
Wt	800	Marb +6.6		REA -0.7		Bfat +0.6			
Prog.BW	59	BWt	WWt	WR	ADG	YWt	YR	Scr.	Fr.
WR	107	59	545	107	3.76	1057	103	32	4.5
YR	103								
Wean Pct.	61%								
Cow Eff.	128								

★★★★★ for Low Maintenance, Marbling, Superior Cow, High Cow Efficiency, Calving Ease, Stayability.

245 **BSF EPIC A708 E7** 

99% # Tat.: BSF3 A708
 Birth: 4-8-13
 Beckton Epic U749 D5
BECKTON EPIC Y484 N6
 Ref. E-5 Beckton Lydia S069 NB
 Beckton Epic K4 N795
 Beckton Denise R308 DM
 Beckton Nebula P P707
 Beckton Lydia P583 WR
 Beckton Epic K4 N795
 Beckton Belga K202 LN
BSF ANDREA Y449 E
 Beckton Epic T330 L5
 BSF Andrea T146 JR
 Beckton Jupiter R478
 BSF Andrea R028 JJ

DAM		Calv.Ease	BW	WW	YW	Milk	HPG	Stay	Maint.En.
Age	2	13.3	-4.5	43.8	80.5	16.5	6.5	15	1.4
Wt	785	Marb +3.9		REA +2.6		Bfat +0.1			
Prog.BW	74	BWt	WWt	WR	ADG	YWt	YR	Scr.	Fr.
WR	113	74	572	113	3.54	1082	106	31	6.0
YR	106								
Wean Pct.	65%								
Cow Eff.	137								

★★★★★ for Low Maintenance, Growth, Marbling, Rib-eye area, Superior Cow, High Cow Efficiency, Calving Ease, Stayability.

248 **BSF CHEROKEE A282 J5** 

1-B 99% # 1626121 Tat.: BSF3 A282
 Birth: 3-22-13
 Beckton Cherokee T450 L3
BECKTON CHEROKEE Y129 E4
 Ref. C-3 Beckton Lana M809 EP
 Beckton Cherokee N N479
 Beckton Annie M337 LN
 Beckton Epic K1 K863
 Beckton Lana K253 DM
 Beckton Julian G3 P608
 Beckton Rose M126 WR
BSF NEBULANN Y504 J
 Beckton Julian U742 W5
 BSF Nebulann U227 CD
 Beckton Cody K2 R168
 BSF Nebulann P046

DAM		Calv.Ease	BW	WW	YW	Milk	HPG	Stay	Maint.En.
Age	2	14	-5.4	44	76	24	7	16	-4.6
Wt	745	Marb +6.4		REA -0.3		Bfat +0.3			
Prog.BW	59	BWt	WWt	WR	ADG	YWt	YR	Scr.	Fr.
WR	101	59	514	101	3.32	1008	99	34	5.0
YR	99								
Wean Pct.	61%								
Cow Eff.	128								

★★★★★ for Low Maintenance, Marbling, High Cow Efficiency, Calving Ease, Stayability.

• Bulls •

249 **BSF CHEROKEE A510 R5** 

99% # Tat.: BSF3 A510
 Birth: 3-30-13
 Beckton Cherokee T450 L3
BECKTON CHEROKEE Y129 E4
 Ref. C-3
 Beckton Cherokee N479
 Beckton Annie M337 LN
 Beckton Epic K1 K863
 Beckton Lana K253 DM
 Beckton Ranger T603 H3
BSF JEWEL Y453 R
 BSF Jewel T099 CT
 Beckton Ranger 9479R
 Beckton Rose N044 HU
 BKT Clifftop TP R288
 BSF Jewel R119 LS

DAM		Calv.Ease	BW	WW	YW	Milk	HPG	Stay	Maint.En.
Age	2	11.8	-4.1	31.5	57.5	21.3	9.3	15.3	-4.9
Wt	725	Marb +0.37		REA +0.06		Bfat +0.04			
Prog.BW	65	BWt	WWt	WR	ADG	YWt	YR	Scr.	Fr.
WR	104	65	515	104	3.60	1034	104	32	5.5
YR	104								
Wean Pct.	63%								
Cow Eff.	132								

★★★★★ for Low Maintenance, Marbling, Superior Cow, High Cow Efficiency, Calving Ease, Stayability.

251 **BSF LIKABLE A063 A4** 

88% # Tat.: BSF3 A063
 Birth: 3-11-13
 Beckton Likable U130 L2
BECKTON LIKABLE Y124 L3
 Ref. L-5
 Beckton Likable S633
 Beckton Kit S478 LN
 Beckton Lasso P741
 BKT Pine Marie P475 LN
 Beckton Accent U777 C2
BSF PANSY Y091 A
 BKT Pinzgauer P217
 Beckton Cody K1 P014
 Beckton Susan R022 CQ
 Pinzgauer sire
 Beckton Firefly E020 WR

DAM		Calv.Ease	BW	WW	YW	Milk	HPG	Stay	Maint.En.
Age	2	9.8	-2.2	40	68	17	9.8	13	-0.2
Wt	900	Marb +0.35		REA +0.23		Bfat +0.03			
Prog.BW	51	BWt	WWt	WR	ADG	YWt	YR	Scr.	Fr.
WR	101	51	500	101	3.26	988	99	32	5.0
YR	99								
Wean Pct.	49%								
Cow Eff.	103								

★★★★★ for Low Maintenance, Marbling, Rib-eye area, Calving Ease, Stayability.



252 **BSF CLIFFTOP A709 J4** 

1-B 99% # 1626032 Tat.: BSF3 A709
 Birth: 4-8-13
 BKT Clifftop TP R288
BECKTON CLIFFTOP W692 E3
 Ref. C-1
 Beckton Lydia S274 EP
 Beckton Clifftop T C075
 Beckton Christy K209 CO
 Beckton Epic KM M115
 Beckton Lydia M607 LO
 Beckton Julian GJ P535
 Beckton Minola P826 DM
 Beckton Lancer T6 M467
BSF LANETTE X408 J
 BSF Lanette P177
 BSF Lanette M383 CH

DAM		Calv.Ease	BW	WW	YW	Milk	HPG	Stay	Maint.En.
Age	3	10	-3.7	41	79	25	11	16	-3.9
Wt	1005	Marb +0.52		REA -0.06		Bfat +0.08			
Prog.BW	71	BWt	WWt	WR	ADG	YWt	YR	Scr.	Fr.
WR	101	67	506	97	3.65	1019	97	33	5.0
YR	100								
Wean Pct.	46%								
Cow Eff.	98								

★★★★★ for Low Maintenance, Marbling, Calving Ease, Stayability.

250 **BSF EMCEE A512 L3** 

1-B 99% # 1625900 Tat.: BSF3 A512
 Birth: 3-30-13
 Beckton Emcee S466
BECKTON EMCEE W526 J2
 Ref. E
 Beckton Larkaba P645 JL
 Beckton Epic K4 N795
 Beckton Larkaba H798 WR
 Beckton Julian GG B571
 Beckton Larkaba L312 LN
 Beckton Lancer F442 T
 Beckton Coca F276 HV
 Beckton Justice C1 R483
BSF NEBULANN W009 L
 BSF Nebulann T658 JC
 BSF Nebulann R163 NB

DAM		Calv.Ease	BW	WW	YW	Milk	HPG	Stay	Maint.En.
Age	4	15	-6.6	46	70	19	6	15	-2.0
Wt	935	Marb +0.62		REA +0.17		Bfat +0.02			
Prog.BW	67	BWt	WWt	WR	ADG	YWt	YR	Scr.	Fr.
WR	90	67	479	90	3.43	976	92	33	5.5
YR	92								
Wean Pct.	49%								
Cow Eff.	103								

★★★★★ for Low Maintenance, Marbling, Rib-eye area, Calving Ease, Stayability.

253 **BSF EMPEROR A421 E4** 

1-B 99% # 1626109 Tat.: BSF3 A421
 Birth: 3-27-13
 Beckton Emperor T641 E2
BECKTON EMPEROR Y459 J3
 Ref. E-4
 Beckton Indigo S354 JT
 Beckton Emperor R100
 Beckton Vernice R416 EP
 Beckton Jet L P491
 Beckton Indigo P676 LN
 Beckton Epic D404
BSF ERICA Y368 E
 BSF Regus G191
 Beckton Saga KJ B702
 Beckton Kuruba B508 PC
 Beckton Caesar M D023
 BSF Regus Z112

DAM		Calv.Ease	BW	WW	YW	Milk	HPG	Stay	Maint.En.
Age	2	10	-2.8	46	73	16	7	14	-8.5
Wt	805	Marb +0.65		REA -0.05		Bfat +0.02			
Prog.BW	66	BWt	WWt	WR	ADG	YWt	YR	Scr.	Fr.
WR	101	66	515	101	3.15	1018	100	32	5.5
YR	100								
Wean Pct.	57%								
Cow Eff.	119								

★★★★★ for Low Maintenance, Marbling, High Cow Efficiency, Calving Ease, Stayability.

The Yearling Heifers

Beckton females are nearly ideal for today's industry – moderately sized, efficient producers. They combine calving ease, growth, and desirable carcass traits. They are feminine, maternal and quiet, with nice udders and sound feet. All of our heifer calves trailed up with their mothers into the Bighorn Mountains to spend their first summer. They have learned the meaning of mothering ability. And they have the productive capacity to produce

the bulls that you see in our sale. The sale heifers are a select group from the top of our replacements.

If you wish, we can also keep any sale heifers through the summer and breed them in natural service to the same herd sires we use with our own replacements. There will be a charge of \$250 per heifer plus delivery at cost in the fall. Visit with Cam about this program.



Heifer pregnancy and loss warranty
OPTIONAL WARRANTY
See page 1 for more details.

Special Offer

Beckton is offering two straws of semen from any of our sires (for which we have adequate supply) to go with each heifer purchased. For P707 semen we are only able to offer one straw, and B571 is not available. The buyer will only be responsible for shipping from Billings, MT. The buyer may use the semen on any animal they would like.

• Heifers •

301 **BECKTON ROSE A093 L**
1-A 100% # 1626308 Tattoo: BKT3 A093

Birth: 3-14-13

Beckton Lancer F442 T
BECKTON LANCER T371 H4
Ref. L-2

Beckton Lancer T A664
Bkt Suffeina A828 DM

Beckton Coca F276 HV

Leachman Heavenly 8141
Beckton Coca B112 CB

Beckton Jupiter R478
BECKTON ROSE T776 JR

Beckton Julian G1 J526
Beckton Serena L042 CR

Beckton Laser N602
Beckton Rose N607 CO

DAM		Calv.Ease	BW	WW	YW	Milk	HPG	Stay	Maint.En.		
Age	6	8	0.8	65	97	11	7	14	6.5		
Wt	1250										
Prog.BW	75										
WR	106										
YR	106										
Cow Eff.	88										
		Marb	+0.38	REA	-0.04	Bfat	-0.01	BWt	WR	YR	Fr.
								83	114	113	med

★★★★★ for Growth, Marbling, Superior Cow, Calving Ease, Stayability. Color: medium

303 **BECKTON ROSE A068 H**
1-A 100% # 1626639 Tattoo: BKT3 A068

Birth: 3-11-13

Beckton Hasten U108 J3
BECKTON HASTEN Y069 D4
Ref. H-2

Beckton Hasten H S462
Beckton Encino S456 JC

Beckton Marta P484 DM

Beckton Dominor Z E401
Beckton Marta K254 LN

Beckton Nebula T269 E2
BECKTON ROSE Y467 N

Beckton Ruth M967 EP

Beckton Rose T770 HI

Beckton Hilltop R157
Beckton Rose R507 CT

DAM		Calv.Ease	BW	WW	YW	Milk	HPG	Stay	Maint.En.		
Age	2	10	0.8	64	104	17	7	16	-0.7		
Wt	800										
Prog.BW	75										
WR	130										
YR	128										
Cow Eff.	131										
		Marb	+0.45	REA	-0.01	Bfat	+0.03	BWt	WR	YR	Fr.
								75	130	128	med

★★★★★ for Low Maintenance, Growth, Marbling, Superior Cow, Calving Ease, Stayability. Color: medium



304 **BECKTON FIREFLY A106 E**
1-A 100% # 1625866 Tattoo: BSF3 A106

Birth: 3-14-13

Beckton Epic K4 N795
BECKTON EPIC U749 D5
Ref. E-2

Beckton Sierra J789 EP

Beckton Denise R308 DM

Beckton Dominor ZC M919
Beckton Denise L639 JL

TR Julian RT561
BECKTON FIREFLY U409 JD

Beckton Cody V E023
Beckton Firefly E684 NP

DAM		Calv.Ease	BW	WW	YW	Milk	HPG	Stay	Maint.En.		
Age	5	11	-3.2	50	90	17	6	12	2.6		
Wt	1005										
Prog.BW	63										
WR	103										
YR	102										
Cow Eff.	102										
		Marb	+0.55	REA	+0.18	Bfat	+0.01	BWt	WR	YR	Fr.
								67	106	108	med

★★★★★ for Low Maintenance, Growth, Marbling, Rib-eye area, Calving Ease. Color: cherry

302 **BECKTON INDIGO A143 N**
1-A 100% # 1626297 Tattoo: BKT3 A143

Birth: 3-16-13

Beckton Nebula L P093
BECKTON NEBULA W486 D3
Ref. N-5

Beckton Nebula M045
Beckton Marta M021 LN

Beckton Belga R716 DM

Beckton Dominor ZC M919
Beckton Belga K285 JL

TR Julian LT151
BECKTON INDIGO T613 JT

Beckton Julian GG B571
MS Geometric 917

Beckton Indigo N467 LO

Beckton Loki F251
Beckton Indigo H150 LN

DAM		Calv.Ease	BW	WW	YW	Milk	HPG	Stay	Maint.En.		
Age	6	12	-2.5	63	105	13	8	16	-2.2		
Wt	965										
Prog.BW	64										
WR	102										
YR	106										
Cow Eff.	119										
		Marb	+0.64	REA	+0.08	Bfat	+0.03	BWt	WR	YR	Fr.
								69	116	117	med

★★★★★ for Low Maintenance, Growth, Marbling, Calving Ease, Stayability. Color: medium

305 **BECKTON SIERRA A071 A**
1-A 100% # 1625817 Tattoo: BSF3 A071

Birth: 3-12-13

Beckton Cody K1 P014
BECKTON ACCENT U777 C2
Ref. A-1

Beckton Cody KH M390
Beckton Rose M126 WR

Beckton Susan R022 CQ

Beckton Cherokee N N479
Beckton Susan N023 JE

Beckton Lasso P741
BECKTON SIERRA S065 LO

Beckton Ruth G534 NP

Beckton Sierra P027 LN

Beckton Lancer T6 M467
Beckton Sierra M258 LN

DAM		Calv.Ease	BW	WW	YW	Milk	HPG	Stay	Maint.En.		
Age	7	9	-3.4	47	79	30	7	13	3.5		
Wt	1250										
Prog.BW	75										
WR	108										
YR	110										
Cow Eff.	88										
		Marb	+0.45	REA	-0.04	Bfat	+0.02	BWt	WR	YR	Fr.
								66	111	104	med

★★★★★ for Low Maintenance, Marbling, Superior Cow, Calving Ease, Stayability. Color: medium

• Heifers •

306 **BECKTON SERENA A791 H**
1-A 100% # 1626459 Tattoo: BKT3 A791

Birth: 4-16-13

Beckton Heritage N013
BECKTON HERITAGE X356 E2
Ref. H-1

Beckton Lana S489 EP

Beckton Nebula PJ S543
BECKTON SERENA W738 N
Beckton Serena S649 LO

Beckton Hustler C2 L079
Beckton Lana L007 JL

Beckton Epic K4 N795
Beckton Lana E136 TP

Beckton Nebula P P707
Beckton Lana P685 JO

Beckton Loki C M740
Beckton Serena F248 CZ

DAM		Calv.Ease	BW	WW	YW	Milk	HPG	Stay	Maint.En.
Age	4	11	-0.9	67	104	15	4	12	2.2
Wt	1005								
Prog.BW	75								
WR	114								
YR	117								
Cow Eff.	110								

Marb **+0.70** REA **-0.10** Bfat **+0.02** BWt **79** WR **115** YR **114** Fr. **med**

★★★★★ for Low Maintenance, Growth, Marbling, Superior Cow, Calving Ease. Color: medium

308 **BECKTON INDIGO A725 J**
1-A 100% # 1626229 Tattoo: BKT3 A725

Birth: 4-10-13

Beckton Julian GJ P535
BECKTON JULIAN G5 S107
Ref. J-2

Beckton Minola P826 DM

Beckton Justice CH M056
BECKTON INDIGO S262 JC
Beckton Indigo L588 LN

Beckton Julian 7526G
Beckton Mona D086 JL

Beckton Dominor ZC M919
Beckton Minola M641 WR

Beckton Justice C K449
Beckton Ruth K802 HD

Beckton Lancer TL G626
Bkt Indigo 9235 GL

DAM		Calv.Ease	BW	WW	YW	Milk	HPG	Stay	Maint.En.
Age	7	9	1.9	60	98	17	14	14	-1.3
Wt	1145								
Prog.BW	73								
WR	106								
YR	105								
Cow Eff.	94								

Marb **+0.54** REA **-0.02** Bfat **+0.04** BWt **87** WR **109** YR **110** Fr. **med**

★★★★★ for Low Maintenance, Growth, Marbling, Superior Cow, Calving Ease, Stayability. Color: medium light



309 **BECKTON EOLA A367 J**
1-A 100% # 1626367 Tattoo: BKT3 A367

Birth: 3-25-13

Beckton Julian GJ P535
BECKTON JULIAN G5 S107
Ref. J-2

Beckton Minola P826 DM

Beckton Julian G3 P608
BECKTON EOLA U689 JL
Beckton Eola N491 LN

Beckton Julian 7526G
Beckton Mona D086 JL

Beckton Dominor ZC M919
Beckton Minola M641 WR

Beckton Julian GG B571
Bkt Suffeina A828 DM

Beckton Lancer T4 J536
Beckton Eola C611 SC

DAM		Calv.Ease	BW	WW	YW	Milk	HPG	Stay	Maint.En.
Age	5	11	-2.2	50	86	19	14	14	-5.6
Wt	1000								
Prog.BW	67								
WR	106								
YR	103								
Cow Eff.	109								

Marb **+0.55** REA **-0.01** Bfat **+0.04** BWt **71** WR **109** YR **103** Fr. **med**

★★★★★ for Low Maintenance, Marbling, Superior Cow, Calving Ease, Stayability. Color: cherry

307 **BECKTON LARKEISA A235 N**
1-A 100% # 1626177 Tattoo: BKT3 A235

Birth: 3-20-13

Beckton Nebula M045
BECKTON NEBULA P P707
Ref. N-2

Beckton Lana M809 EP

Beckton Neptune R2 K065
BECKTON LARKEISA P136 NP
Bkt Larkeisa G448 CT

Beckton Neptune R2 K065
Beckton Belga K285 JL

Beckton Epic K1 K863
Beckton Lana K253 DM

Beckton Neptune RR B284
Beckton Lana C735 TP

Beckton Cliffot T C075
Bkt Larkeisa C894 JV

DAM		Calv.Ease	BW	WW	YW	Milk	HPG	Stay	Maint.En.
Age	9	13	-7.4	48	85	24	12	14	-3.2
Wt	1180								
Prog.BW	70								
WR	111								
YR	109								
Cow Eff.	89								

Marb **+0.63** REA **-0.25** Bfat **+0.03** BWt **54** WR **106** YR **103** Fr. **med**

★★★★★ for Low Maintenance, Marbling, Superior Cow, Calving Ease, Stayability. Color: cherry

310 **BECKTON LANA A312 N**
2 100% # 1625939 Tattoo: BSF3 A312

Birth: 3-23-13

Beckton Nebula M045
BECKTON NEBULA P P707
Ref. N-2

Beckton Lana M809 EP

Beckton Nebula EN S347
BECKTON LANA W518 N
Beckton Lana P073 EP

Beckton Neptune R2 K065
Beckton Belga K285 JL

Beckton Epic K1 K863
Beckton Lana K253 DM

Beckton Nebula E P084
Beckton Eola P530 NB

Beckton Epic KM M115
Beckton Lana M393 LN

DAM		Calv.Ease	BW	WW	YW	Milk	HPG	Stay	Maint.En.
Age	4	15	-5.4	57	95	27	13	15	-4.0
Wt	1005								
Prog.BW	65								
WR	115								
YR	113								
Cow Eff.	108								

Marb **+0.83** REA **-0.28** Bfat **+0.05** BWt **65** WR **113** YR **114** Fr. **med**

★★★★★ for Low Maintenance, Growth, Marbling, Superior Cow, Calving Ease, Stayability. Color: medium

• Heifers •



313 BECKTON EOLA A493 N
1-A 100% # 1626284 Tattoo: BKT3 A493

Birth: 3-29-13

Beckton Nebula L P093
BECKTON NEBULA W486 D3
 Ref. N-5 Beckton Belga R716 DM

Beckton Nebula M045
 Beckton Marta M021 LN
 Beckton Dominor ZC M919
 Beckton Belga K285 JL
 Beckton Nebula M045
 Beckton Marta M021 LN
 Beckton Cruiser K118
 Beckton Eola C611 SC

BECKTON EOLA T435 NB
 Beckton Nebula L P093
 Beckton Eola P336 CE

DAM		Calv.Ease	BW	WW	YW	Milk	HPG	Stay	Maint.En.
Age	6	11	-1.4	56	89	7	11	15	-1.6
Wt	1075	Marb	+0.34	REA	+0.04	Bfat	+0.02	BWt	75
Prog.BW	69	WR		YR		FR		105	104
WR	93								med
YR	98								
Cow Eff.	97								

★★★★★ for Low Maintenance, Marbling, Calving Ease, Stayability.

311 BECKTON MINERVA A440 V
1-A 100% # 1626206 Tattoo: BKT3 A440

Birth: 3-28-13

Beckton Nomad 7496
BECKTON NOMAD T 9A14
 Ref. v-1 Beckton Lana 7152 TJ

Beckton Neva 5562
 Bkt Bolt Tamrck 3913
 Beckton Trojan 5253
 Bkt Signal Lana 5599
 Beckton Epic K F075
 Beckton Minerva F495 CH
 Beckton Epic KJ J722
 Beckton Minerva H394 CL

Beckton Epic KM M115
BECKTON MINERVA R467 EP
 Beckton Minerva M651 EP

DAM		Calv.Ease	BW	WW	YW	Milk	HPG	Stay	Maint.En.
Age	8	13	-5.7	39	61	18	12	9	-6.3
Wt	1150	Marb	+0.34	REA	-.27	Bfat	+0.01	BWt	62
Prog.BW	67	WR		YR		FR		111	104
WR	107								med
YR	106								
Cow Eff.	96								

★★★★★ for Low Maintenance, Marbling, Superior Cow, Calving Ease.



312 BECKTON PINE MARIE A658 O
1-A 100% # 1626473 Tattoo: BKT3 A658

Birth: 4-5-13

Beckton Roman J S158
BECKTON JANUS X799 L2
 Ref. O-1 Beckton Sierra K557 LO

TR Romeo NT379
 Beckton Belga K285 JL
 Beckton Loki F251
 Beckton Sierra C157 CL
 Beckton Epic KM M115
 Beckton Sierra N703 LM
 Beckton Heritage N013
 BKT Pine Marie P143 LN

Beckton Epic K6 S569
BKT PINE MARIE W857 E
 BKT Pine Marie T593 HT

DAM		Calv.Ease	BW	WW	YW	Milk	HPG	Stay	Maint.En.
Age	4	12	-3.9	58	95	24	5	12	-0.2
Wt	840	Marb	+0.46	REA	+0.11	Bfat	+0.02	BWt	62
Prog.BW	63	WR		YR		FR		115	106
WR	109								med
YR	108								
Cow Eff.	129								

★★★★★ for Low Maintenance, Growth, Marbling, Superior Cow, Calving Ease.

314 BECKTON MARTA A351 N
1-A 100% # 1625813 Tattoo: BSF3 A351

Birth: 3-25-13

Beckton Nebula M045
BECKTON NEBULA T269 E2
 Ref. N-3 Beckton Ruth M967 EP

Beckton Neptune R2 K065
 Beckton Belga K285 JL
 Beckton Epic KN H110
 Beckton Ruth A905 SG
 Beckton Epic KJ J722
 Beckton Lana F268 CT
 Beckton Julian 7526G
 Beckton Marta 8955KR

Beckton Epic K3 M606
BECKTON MARTA R790 EP
 Beckton Marta C314 JL

DAM		Calv.Ease	BW	WW	YW	Milk	HPG	Stay	Maint.En.
Age	8	11	-5.1	42	69	17	7	12	-5.8
Wt	1045	Marb	+0.35	REA	-.03	Bfat	+0.03	BWt	59
Prog.BW	69	WR		YR		FR		92	99
WR	99								sma
YR	102								
Cow Eff.	88								

★★★★★ for Low Maintenance, Marbling, Calving Ease.

• Heifers •

315 BECKTON INDIGO A181 N
2 100% # 1626176 Tattoo: BKT3 A181

Birth: 3-18-13

Beckton Nebula PJ S543
Beckton Nebula P P707
Beckton Lana P685 JO

BECKTON NEBULA W778 J4
Ref. N-6
Beckton Lana S197 JT
Beckton Jet L P491
Beckton Lana P828 LN

Beckton Loki C M740
Beckton Loki F251
BKT Larkeisa J051 CK

BECKTON INDIGO P043 LO
Beckton Indigo M571 EP
Beckton Epic K F075
Beckton Indigo C106 LN

DAM		Calv.Ease	BW	WW	YW	Milk	HPG	Stay	Maint.En.
Age	9	13	-4.2	56	89	18	5	15	3.8
Wt	NA	Marb	+0.68	REA	-0.13	Bfat	+0.03	BWt	WR
Prog.BW	74							68	113
WR	108							99	med
YR	104								
Cow Eff.	NA								

★★★★★ for Low Maintenance, Marbling, Superior Cow, Calving Ease, Stayability.

318 BECKTON MINOLA A803 N
1-A 100% # 1625795 Tattoo: BSF3 A803

Birth: 4-17-13

Beckton Nebula L P093
Beckton Nebula M045
Beckton Marta M021 LN

BECKTON NEBULA W486 D3
Ref. N-5
Beckton Belga R716 DM
Beckton Dominor ZC M919
Beckton Belga K285 JL

Beckton Lancer T7 M089
Beckton Lancer F442 T
Beckton Tamara G141 HE

BECKTON MINOLA P596 LN
Beckton Minola M155 CE
Beckton Cruiser K118
Beckton Minola K592 EP

DAM		Calv.Ease	BW	WW	YW	Milk	HPG	Stay	Maint.En.
Age	9	7	-1.2	57	93	14	11	14	1.5
Wt	1170	Marb	+0.30	REA	+0.03	Bfat	-0.02	BWt	WR
Prog.BW	82							71	106
WR	108							104	sma
YR	107								
Cow Eff.	90								

★★★★★ for Low Maintenance, Marbling, Superior Cow, Calving Ease, Stayability.

316 BECKTON LARKABA A366 N
1-A 100% # 1626329 Tattoo: BKT3 A366

Birth: 3-25-13

Beckton Nebula E P084
Beckton Nebula M045
BKT Pine Marie M119 EP

BECKTON NEBULA EN S347
Ref. N
Beckton Eola P530 NB
Beckton Nebula M045
Beckton Eola M663 EP

Beckton Epic KJ J722
Beckton Epic K F075
Beckton Lana F891 JL

BECKTON LARKABA U211 EP
Beckton Larkaba N643 HR
Beckton Herald FJ J776
Beckton Larkaba J765 CH

DAM		Calv.Ease	BW	WW	YW	Milk	HPG	Stay	Maint.En.
Age	5	14	-6.1	42	64	23	12	14	-7.3
Wt	1125	Marb	+0.70	REA	-0.24	Bfat	+0.05	BWt	WR
Prog.BW	68							60	95
WR	102							97	sma
YR	103								
Cow Eff.	82								

★★★★★ for Low Maintenance, Marbling, Calving Ease, Stayability.

319 BECKTON SHEBA A495 J
1-A 100% # 1626515 Tattoo: BKT3 A495

Birth: 3-29-13

Beckton Julian G5 S107
Beckton Julian GJ P535
Beckton Minola P826 DM

BECKTON JULIAN W743 H5
Ref. J-3
Beckton Kit L399 HR
Beckton Herald F FA20
Beckton Kit F468 JL

Beckton Nebula G S237
Beckton Nebula M045
Beckton Lakme LA06 JL

BECKTON SHEBA X320 N
Beckton Sheba S428 EP
Beckton Epic KM M115
Beckton Sheba N497 CE

DAM		Calv.Ease	BW	WW	YW	Milk	HPG	Stay	Maint.En.
Age	3	14	-4.6	46	77	21	13	14	-2.4
Wt	870	Marb	+0.57	REA	-0.19	Bfat	+0.04	BWt	WR
Prog.BW	52							59	106
WR	108							105	med
YR	101								
Cow Eff.	107								

★★★★★ for Low Maintenance, Marbling, Calving Ease, Stayability.

317 BECKTON FREYJA A136 C
1-A 100% # 1625772 Tattoo: BSF3 A136

Birth: 3-16-13

BKT Clifftop TP R288
Beckton Clifftop T C075
Beckton Christy K209 CO

BECKTON CLIFFTOP W692 E3
Ref. C-1
Beckton Lydia S274 EP
Beckton Epic KM M115
Beckton Lydia M607 LO

Beckton Warrior T C371
JKG Chiefton L303
Beckton Tamla A671 TR

BECKTON FREYJA M659 WR
Beckton Freyja B572 JL
Beckton Julian GN 9A45
Bkt Freyja 8039 JV

DAM		Calv.Ease	BW	WW	YW	Milk	HPG	Stay	Maint.En.
Age	11	8	-2.8	38	70	25	12	15	-5.3
Wt	1145	Marb	+0.40	REA	+0.02	Bfat	+0.05	BWt	WR
Prog.BW	78							68	98
WR	101							98	sma
YR	103								
Cow Eff.	81								

★★★★★ for Low Maintenance, Marbling, Calving Ease, Stayability.



• Heifers •

320 **BECKTON TAMARA A647 N**
1-A 100% # 1625969 Tattoo: BSF3 A647

Birth: 4-5-13
 Beckton Nebula M045
BECKTON NEBULA T269 E2
 Ref. N-3 Beckton Ruth M967 EP

Beckton Neptune R2 K065
 Beckton Belga K285 JL
 Beckton Epic KN H110
 Beckton Ruth A905 SG
 TR Romeo NT379
 Beckton Belga K285 JL
 Beckton Hustler C2 L079
 Beckton Tamara M823 LN

Beckton Roman J S158
BECKTON TAMARA W861 J
 Beckton Tamara S314 HU

DAM	
Age	4
Wt	995
Prog.BW	73
WR	113
YR	96
Cow Eff.	99

Calv.Ease	BW	WW	YW	Milk	HPG	Stay	Maint.En.
10	-2.2	53	80	19	5	12	0.7
Marb	REA	Bfat	BWt	WR	YR	Fr.	
+0.37	+0.02	+0.00	69	106	101	med	

★★★★★ for Low Maintenance, Marbling, Calving Ease.

323 **BSF CODETTE A095 J**
1-2 99% # 1626008 Tattoo: BSF3 A095

Birth: 3-14-13
 Beckton Julian G5 S107
BECKTON JULIAN X465 J5
 Ref. J-4 Beckton Suffeina P643 JL

Beckton Julian GJ P535
 Beckton Minola P826 DM
 Beckton Julian GG B571
 Bkt Suffeina A828 DM
 Beckton Nebula L P093
 Beckton Minerva J615 VG
 Beckton Cody KH M390
 BSF Regus L632 CK

Beckton Nebula T398 V3
BSF CODETTE X219 N
 BSF Codette S162 CD

DAM	
Age	3
Wt	890
Prog.BW	59
WR	109
YR	107
Cow Eff.	102

Calv.Ease	BW	WW	YW	Milk	HPG	Stay	Maint.En.
10	-3.5	51	90	17	11	15	-3.8
Marb	REA	Bfat	BWt	WR	YR	Fr.	
+0.54	+0.11	+0.03	58	105	109	med	

★★★★★ for Low Maintenance, Growth, Marbling, Superior Cow, Calving Ease, Stayability. Color: cherry

321 **BSF NEPTALA A359 J**
1-B 99% # pending Tattoo: BSF3 A359

Birth: 3-25-13
 Beckton Julian G5 S107
BECKTON JULIAN W743 H5
 Ref. J-3 Beckton Kit L399 HR

Beckton Julian GJ P535
 Beckton Minola P826 DM
 Beckton Herald F FA20
 Beckton Kit F468 JL
 Beckton Justice C K449
 Beckton Ruth K802 HD
 Beckton Neptune R2 K065
 BSF Regus L616 LN

Beckton Justice CH M056
BSF NEPTALA T541 JC
 BSF Neptala P301

DAM	
Age	6
Wt	1010
Prog.BW	82
WR	113
YR	106
Cow Eff.	109

Calv.Ease	BW	WW	YW	Milk	HPG	Stay	Maint.En.
11	-1.6	48	83	17	13	14	2.7
Marb	REA	Bfat	BWt	WR	YR	Fr.	
+0.43	-0.02	+0.02	82	111	115	med	

★★★★★ for Low Maintenance, Growth, Marbling, Superior Cow, Calving Ease, Stayability. Color: medium

324 **BSF NEENA A755 N**
1-B 99% # 1625780 Tattoo: BSF3 A755

Birth: 4-12-13
 Beckton Nebula PJ S543
BECKTON NEBULA W778 J4
 Ref. N-6 Beckton Lana S197 JT

Beckton Nebula P P707
 Beckton Lana P685 JO
 Beckton Jet L P491
 Beckton Lana P828 LN
 Beckton Neptune RR B284
 Beckton Lana C735 TP
 Red Angus multiple sire
 BSF Regus B655

Beckton Neptune R2 K065
BSF NEENA N333 NP
 BSF Brockle G498

DAM	
Age	10
Wt	1015
Prog.BW	73
WR	110
YR	108
Cow Eff.	101

Calv.Ease	BW	WW	YW	Milk	HPG	Stay	Maint.En.
13	-4.7	50	77	22	8	13	-1.1
Marb	REA	Bfat	BWt	WR	YR	Fr.	
+0.63	-0.09	+0.02	69	106	109	med	

★★★★★ for Low Maintenance, Growth, Marbling, Superior Cow, Calving Ease, Stayability. Color: medium

322 **BSF HUSTELLE A141 J**
1-B 99% # 1625807 Tattoo: BSF3 A141

Birth: 3-16-13
 Beckton Julian G5 S107
BECKTON JULIAN W743 H5
 Ref. J-3 Beckton Kit L399 HR

Beckton Julian GJ P535
 Beckton Minola P826 DM
 Beckton Herald F FA20
 Beckton Kit F468 JL
 Beckton Hustler C G407
 Beckton Belga G355 NP
 Beckton Clipper KH F416
 BSF Regus Z776

Beckton Hustler CN J102
BSF HUSTELLE R608 HU
 BSF Regus L862 CL

DAM	
Age	8
Wt	1085
Prog.BW	68
WR	103
YR	103
Cow Eff.	95

Calv.Ease	BW	WW	YW	Milk	HPG	Stay	Maint.En.
12	-2.8	43	72	24	11	12	-1.0
Marb	REA	Bfat	BWt	WR	YR	Fr.	
+0.41	-0.12	+0.01	74	106	102	med	

★★★★★ for Low Maintenance, Marbling, Calving Ease. Color: cherry

325 **BSF CODETTE A399 D**
1-B 99% # pending Tattoo: BSF3 A399

Birth: 3-26-13
 Beckton Dominor Z1 R610
BECKTON DOMINOR W640 C5
 Ref. D-1 Beckton Mona R166 CQ

Beckton Dominor ZC M919
 Beckton Sierra K557 LO
 Beckton Cherokee N N479
 Beckton Mona N342 HU
 Beckton Cody K G701
 Beckton Tamara J124 HR
 Beckton Colt G552
 BSF Regus Z112

Beckton Cody KH M390
BSF CODETTE S162 CD
 BSF Regus L632 CK

DAM	
Age	7
Wt	1060
Prog.BW	67
WR	101
YR	103
Cow Eff.	101

Calv.Ease	BW	WW	YW	Milk	HPG	Stay	Maint.En.
11	-2.4	48	83	18	10	15	4.9
Marb	REA	Bfat	BWt	WR	YR	Fr.	
+0.18	+0.12	+0.03	75	110	98	med	

★★★★★ for Marbling, Calving Ease, Stayability. Color: medium

• Heifers •



328 **BECKTON MONA A825 H**
1-A 100% # pending Tattoo: BKT3 A825

Birth: 4-20-13

Beckton Heritage N013
 Beckton Hustler C2 L079
 Beckton Lana L007 JL

BECKTON HERITAGE X356 E2
 Ref. H-1 Beckton Lana S489 EP
 Beckton Epic K4 N795
 Beckton Lana E136 TP

Beckton Action T061 D1
 Beckton Cody K2 R168
 Beckton Belga R716 DM

BECKTON MONA W528 A
 Beckton Mona T794 CD
 Beckton Cody K2 R168
 Beckton Mona R764 LN

DAM		Calv.Ease	BW	WW	YW	Milk	HPG	Stay	Maint.En.
Age	4	10	-3.4	62	100	19	6	14	6.2
Wt	1085								
Prog.BW	65								
WR	95								
YR	105								
Cow Eff.	82	Marb +.57	REA +.15	Bfat +.03		BWt 65	WR 95	YR 105	Fr. med

★★★★★ for Marbling, Rib-eye area, Calving Ease, Stayability. Color: medium

326 **BECKTON JANE A311 W**
1-A 100% # 1625961 Tattoo: BSF3 A311

Birth: 3-23-13

Beckton Warrior T1 H281
 Beckton Minerva B609 RN

BECKTON WARHAWK N560
 Ref. W-1 Beckton Firefly H195 HD
 Beckton Hadrian A100
 Beckton Firefly C999 CB

Beckton Julian G5 S107
 Beckton Julian GJ P535
 Beckton Minola P826 DM

BECKTON JANE W776 J
 Beckton Jane P410 NP
 Beckton Neptune R2 K065
 Beckton Jane J874 CC

DAM		Calv.Ease	BW	WW	YW	Milk	HPG	Stay	Maint.En.
Age	4	13	-7.0	33	57	14	19	13	-4.6
Wt	955								
Prog.BW	62								
WR	95								
YR	102								
Cow Eff.	82	Marb +.53	REA -.08	Bfat +.03		BWt 56	WR 83	YR 96	Fr. sma

★★★★★ for Low Maintenance, Marbling, Calving Ease, Stayability. Color: cherry

329 **BECKTON TAMARA A107 N**
1-A 100% # 1626414 Tattoo: BKT3 A107

Birth: 3-14-13

Beckton Nebula L P093
 Beckton Marta M021 LN

BECKTON NEBULA W486 D3
 Ref. N-5 Beckton Belga R716 DM
 Beckton Dominor ZC M919
 Beckton Belga K285 JL

Beckton Nebula G S237
 Beckton Nebula M045
 Beckton Lakme LA06 JL

BECKTON TAMARA W304 N
 Beckton Tamara S627 NB
 Beckton Nebula M045
 Beckton Tamara N712 JL

DAM		Calv.Ease	BW	WW	YW	Milk	HPG	Stay	Maint.En.
Age	4	13	-5.1	45	74	11	9	15	-2.2
Wt	910								
Prog.BW	56								
WR	95								
YR	93								
Cow Eff.	100	Marb +.48	REA -.15	Bfat +.03		BWt 62	WR 97	YR 93	Fr. sma

★★★★★ for Low Maintenance, Marbling, Calving Ease, Stayability. Color: medium

327 **BECKTON BELGA A101 L**
1-A 100% # 1625787 Tattoo: BSF3 A101

Birth: 3-14-13

Beckton Lancer F442 T
 Beckton Lancer T A664
 Bkt Suffeina A828 DM

BECKTON LANCER T371 H4
 Ref. L-2 Beckton Coca F276 HV
 Leachman Heavenly 8141
 Beckton Coca B112 CB

Beckton Epic KJ J722
 Beckton Epic K F075
 Beckton Lana F891 JL

BECKTON BELGA P119 EP
 Beckton Belga K476 JL
 Beckton Julian 7526G
 Beckton Belga F772 VG

DAM		Calv.Ease	BW	WW	YW	Milk	HPG	Stay	Maint.En.
Age	9	9	-3.4	44	68	15	5	13	-1.0
Wt	1135								
Prog.BW	74								
WR	95								
YR	97								
Cow Eff.	70	Marb +.35	REA -.04	Bfat +.02		BWt 67	WR 80	YR 92	Fr. med

★★★★★ for Low Maintenance, Marbling, Calving Ease, Stayability. Color: cherry

330 **BECKTON LARKEISA A030 W**
2 100% # 1626125 Tattoo: BSF3 A030

Birth: 3-7-13

Beckton Warrior W534 N4
 Beckton Warrior C1 S337
 BKT Larkeisa S055 NB

BECKTON WARRIOR Y108 E5
 Ref. W-3 Beckton Susan W058 E
 Beckton Epic T330 L5
 Beckton Susan T048 NB

Beckton Warrior W534 N4
 Beckton Warrior C1 S337
 BKT Larkeisa S055 NB

BECKTON LARKEISA Y524 W
 BKT Larkeisa U583 NB
 Beckton Nebula L P093
 Bkt Larkeisa E578 HB

DAM		Calv.Ease	BW	WW	YW	Milk	HPG	Stay	Maint.En.
Age	2	13	-4.0	59	95	14	11	15	-3.1
Wt	780								
Prog.BW	57								
WR	110								
YR	102								
Cow Eff.	111	Marb +.53	REA +.07	Bfat +.04		BWt 57	WR 110	YR 102	Fr. med

★★★★★ for Low Maintenance, Marbling, Calving Ease, Stayability. Color: medium

• Heifers •

331 **BSF JEWEL A447 W**
1-B 99% # 1644985 Tattoo: BSF3 A447

Birth: 3-28-13

Beckton Warrior T1 H281
Beckton Warrior TC E801
Beckton Minerva B609 RN

BECKTON WARHAWK N560
Ref. W-1
Beckton Firefly H195 HD
Beckton Hadrian A100
Beckton Firefly C999 CB

Beckton Champ R1 H024
Beckton Champ RH F275
Beckton Lana F138 LN

BSF JEWEL S875 CH
Beckton Jules L429
BSF Jewel N355 JE
BSF Regus L683 CT

DAM		Calv.Ease	BW	WW	YW	Milk	HPG	Stay	Maint.En.
Age	7	16	-5.6	21	43	16	15	13	-5.6
Wt	NA								
Prog.BW	64								
WR	101								
YR	104								
Cow Eff.	NA								

Marb -.04 REA +.10 Bfat -.03 Bwt 61 WR 106 YR 106 sma

★★★★★ for Low Maintenance, Calving Ease.

333 **BSF LANETTE A262 N**
1-B 99% # 1625836 Tattoo: BSF3 A262

Birth: 3-21-13

Beckton Nebula M045
Beckton Neptune R2 K065
Beckton Belga K285 JL

BECKTON NEBULA G S237
Ref. N
Beckton Lakme LA06 JL
Beckton Julian GG B571
Beckton Lakme B370 HV

Beckton Roman J S158
TR Romeo NT379
Beckton Belga K285 JL

BSF LANETTE U009 RA
Beckton Hawk P248
BSF Lanette S490 HW
BSF Lanette P804

DAM		Calv.Ease	BW	WW	YW	Milk	HPG	Stay	Maint.En.
Age	5	13	-5.6	42	67	18	6	11	-3.1
Wt	1015								
Prog.BW	67								
WR	108								
YR	105								
Cow Eff.	93								

Marb +.49 REA -.11 Bfat +.01 Bwt 62 WR 97 YR 95 med

★★★★★ for Low Maintenance, Marbling, Superior Cow, Calving Ease.

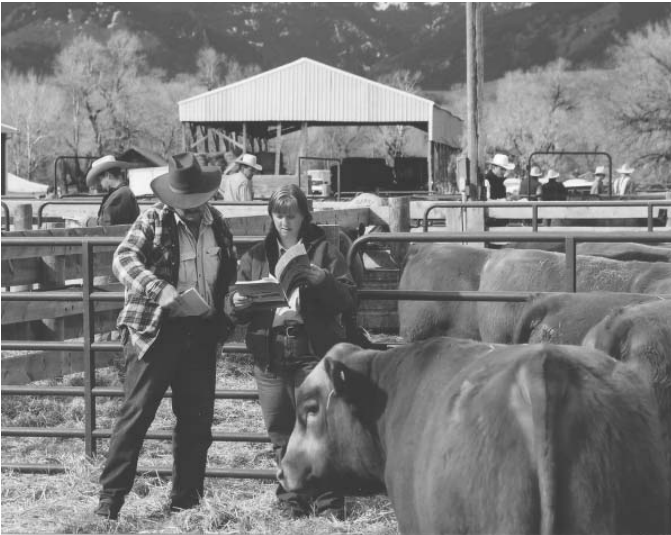

334 **BSF CRUSITA A503 D**
1-B 99% # pending Tattoo: BSF3 A503

Birth: 3-30-13

Beckton Dominor Z1 R610
Beckton Sierra K557 LO

BECKTON DOMINOR W640 C5
Ref. D-1
Beckton Mona R166 CQ
Beckton Cherokee N N479
Beckton Mona N342 HU

Beckton Epic K5 P071
Beckton Epic KM M115
Beckton Minerva M179 LN

BSF CRUSITA S081 EP
Beckton Cruiser K118
BSF Crusita P716
BKB Red KC64 HR

DAM		Calv.Ease	BW	WW	YW	Milk	HPG	Stay	Maint.En.
Age	7	10	-2.1	43	75	19	12	15	2.5
Wt	1020								
Prog.BW	58								
WR	101								
YR	100								
Cow Eff.	104								

Marb +.37 REA +.02 Bfat +.03 Bwt 53 WR 107 YR 101 sma

★★★★★ for Low Maintenance, Marbling, Calving Ease, Stayability.

332 **BSF LANETTE A474 J**
2 99% # pending Tattoo: BSF3 A474

Birth: 3-29-13

Beckton Julian G5 S107
Beckton Julian GJ P535
Beckton Minola P826 DM

BECKTON JULIAN X465 J5
Ref. J-4
Beckton Suffeina P643 JL
Beckton Julian GG B571
Bkt Suffeina A828 DM

Beckton Jet L P491
TR Julian LT151
Beckton Minerva L278 LN

BSF LANETTE S529 JT
Beckton Lancer T4 J536
BSF Lanette P754
BSF Regus L619 JL

DAM		Calv.Ease	BW	WW	YW	Milk	HPG	Stay	Maint.En.
Age	7	13	-3.0	39	70	18	12	20	2.1
Wt	965								
Prog.BW	66								
WR	102								
YR	103								
Cow Eff.	94								

Marb +.44 REA +.10 Bfat +.03 Bwt 55 WR 93 YR 104 sma

★★★★★ for Low Maintenance, Marbling, Calving Ease, Stayability.

335 **BSF JULIANNE A552 L**
1-B 99% # 1626118 Tattoo: BSF3 A552

Birth: 4-1-13

Beckton Likable U130 L2
Beckton Likable S633
Beckton Kit S478 LN

BECKTON LIKABLE Y362 L3
Ref. L-6
Beckton Tamara M515 LN
Beckton Lancer TA K644
Beckton Tamara K322 LN

Beckton Likable U130 L2
Beckton Likable S633
Beckton Kit S478 LN

BSF JULIANNE Y488 L
Beckton Warrior N645 T1
BSF Julianne R692 JL

DAM		Calv.Ease	BW	WW	YW	Milk	HPG	Stay	Maint.En.
Age	2	10	-1.2	63	98	8	10	15	2.4
Wt	715								
Prog.BW	68								
WR	107								
YR	109								
Cow Eff.	119								

Marb +.59 REA +.33 Bfat +.06 Bwt 68 WR 107 YR 109 med

★★★★★ for Low Maintenance, Growth, Marbling, Rib-eye area, Superior Cow, Calving Ease, Stayability.

• Heifers •



338 **BECKTON ROSE A450 N**
1-A 100% # 1626555 Tattoo: BKT3 A450

Birth: 3-28-13

Beckton Nebula P P707
Beckton Nebula M045
Beckton Lana M809 EP

BECKTON NEW ERA Y194
Ref. N-9 \ BKT Larkeisa T310 JC
Beckton Justice C1 R483
BKT Larkeisa R775 JC

Beckton Nebula PJ S543
Beckton Nebula P P707
Beckton Lana P685 JO

BECKTON ROSE X727 N
Beckton Rose T468 JL
Beckton Julian 7526G
Beckton Rose P011 EP

DAM		Calv.Ease	BW	WW	YW	Milk	HPG	Stay	Maint.En.
Age	3	13	-2.3	70	113	15	7	16	-1.9
Wt	900	Marb +.59	REA -.05	Bfat +.03	BWt	WR	YR	Fr.	
Prog.BW	66				66	103	100	med	
WR	103								
YR	100								
Cow Eff.	100								

★★★★★ for Low Maintenance, Marbling, Calving Ease, Stayability.

336 **BECKTON SUSAN A346 N**
1-A 100% # 1626558 Tattoo: BKT3 A346

Birth: 3-25-13

Beckton Neptune R2 K065
Beckton Neptune RR B284
Beckton Lana C735 TP

BECKTON NEBULA M045
Ref. N-1 \ Beckton Belga K285 JL
Beckton Julian GG B571
Beckton Belga G493 HR

Beckton Nebula EN S347
Beckton Nebula E P084
Beckton Eola P530 NB

BECKTON SUSAN X753 N
Beckton Susan T685 EP
Beckton Epic K4 N795
Beckton Susan P090 CE

DAM		Calv.Ease	BW	WW	YW	Milk	HPG	Stay	Maint.En.
Age	3	15	-5.7	55	91	13	11	14	-7.3
Wt	980	Marb +.65	REA -.39	Bfat +.06	BWt	WR	YR	Fr.	
Prog.BW	55				55	100	100	med	
WR	100								
YR	100								
Cow Eff.	89								

★★★★★ for Low Maintenance, Marbling, Calving Ease, Stayability.

339 **BECKTON LANA A794 L**
1-A 100% # 1626200 Tattoo: BKT3 A794

Birth: 4-16-13

Beckton Lancer F442 T
Beckton Lancer T A664
Bkt Suffeina A828 DM

BECKTON LANCER T371 H4
Ref. L-2 \ Beckton Coca F276 HV
Leachman Heavenly 8141
Beckton Coca B112 CB

Beckton Epic KM M115
Beckton Epic K F075
Beckton Minerva F495 CH

BECKTON LANA R327 EP
Beckton Lana K840 LN
Beckton Lancer TS D390
Beckton Lana F891 JL

DAM		Calv.Ease	BW	WW	YW	Milk	HPG	Stay	Maint.En.
Age	8	9	-5.5	52	85	19	8	13	1.3
Wt	1150	Marb +.41	REA -.19	Bfat -.01	BWt	WR	YR	Fr.	
Prog.BW	66				66	104	96	med	
WR	110								
YR	106								
Cow Eff.	90								

★★★★★ for Low Maintenance, Marbling, Superior Cow, Calving Ease, Stayability.

337 **BECKTON SUFFEINA A721 L**
1-A 100% # 1626095 Tattoo: BSF3 A721

Birth: 4-10-13

Beckton Likable U130 L2
Beckton Likable S633
Beckton Kit S478 LN

BECKTON LIKABLE Y124 L3
Ref. L-5 \ BKT Pine Marie S802 LO
Beckton Lasso P741
BKT Pine Marie P475 LN

Beckton Nebula PJ S543
Beckton Nebula P P707
Beckton Lana P685 JO

BECKTON SUFFEINA Y221 N
Beckton Suffeina P671 LN
Beckton Lancer T A664
Bkt Suffeina A828 DM

DAM		Calv.Ease	BW	WW	YW	Milk	HPG	Stay	Maint.En.
Age	2	12	-4.1	52	86	12	8	15	4.1
Wt	945	Marb +.70	REA +.11	Bfat +.04	BWt	WR	YR	Fr.	
Prog.BW	57				57	99	108	sma	
WR	99								
YR	108								
Cow Eff.	79								

★★★★★ for Growth, Marbling, Calving Ease, Stayability.

340 **BECKTON MINOLA A392 J**
2 100% # 1626004 Tattoo: BSF3 A392

Birth: 3-26-13

Beckton Julian G5 S107
Beckton Julian GJ P535
Beckton Minola P826 DM

BECKTON JULIAN X465 J5
Ref. J-4 \ Beckton Suffeina P643 JL
Beckton Julian GG B571
Bkt Suffeina A828 DM

Beckton Accent U777 C2
Beckton Cody K1 P014
Beckton Susan R022 CQ

BECKTON MINOLA X198 A
Beckton Minola U378 JL
Beckton Julian G3 P608
Beckton Minola M155 CE

DAM		Calv.Ease	BW	WW	YW	Milk	HPG	Stay	Maint.En.
Age	3	11	-1.8	53	90	21	12	17	-4.9
Wt	NA	Marb +.66	REA +.05	Bfat +.02	BWt	WR	YR	Fr.	
Prog.BW	60				60	98	92	sma	
WR	105								
YR	94								
Cow Eff.	NA								

★★★★★ for Low Maintenance, Marbling, Calving Ease, Stayability.

Reference Sires

The goal for Beckton's program has always been to develop breeding seedstock which offer increased levels of performance for the commercial cattleman. Increased performance does not mean maximizing weight and size, which have already reached the upper limit of economic

value for the packer and consumer. It does, however, mean increasing performance related to calving percentage and weaning percentage; and increasing performance related to cow maintenance requirements and "pounds of calf per acre" efficiency.



Beckton Julian B571 (Ref. Sire J-1)

• Reference Sires •

A-1 BECKTON ACCENT U777 C2
1-A 100% # 1259524 Tattoo: BKT8 U777

Birth: 4-13-08
 Beckton Cody KH M390
BECKTON CODY K1 P014
 Ref. A
 Beckton Rose M126 WR
 Beckton Cherokee N N479
BECKTON SUSAN R022 CQ
 Beckton Susan N023 JE
 Beckton Cody K G701
 Beckton Tamara J124 HR
 Beckton Warrior T C371
 Beckton Rose D741 LN
 BFCK Cherokee Cnyn 4912
 Beckton Dinah C440 NM
 Beckton Jules L429
 Beckton Susan L258 LR

DAM		Calv.Ease	BW	WW	YW	Milk	HPG	Stay	Maint.En.
Age	3	12	-5.8	44	72	30	7	16	-3.4
Wt	915	(.47)	(.67)	(.61)	(.61)	(.43)	(.16)	(.08)	(.63)
Wean Pct.	68%	Marb +.47 (.24)		REA +.13 (.20)		Bfat +.01 (.11)			
Cow Eff.	144	BWt	WWt	WR	ADG	YWt	YR	Scr.	Fr.
		66	666	117	5	1209	112	38	5.0

★★★★★ for Low Maintenance, Growth, Gainability, Marbling, Rib-eye area, High Cow Efficiency, Calving Ease, Stayability.

A-4 BECKTON ACCENT Y312 N3
1-A 100% # 1451236 Tattoo: BKT1 Y312

Birth: 3-25-11
 Beckton Cody K1 P014
BECKTON ACCENT U777 C2
 Ref. A-1
 Beckton Susan R022 CQ
 Beckton Nebula P P707
BKT LARKEISA S055 NB
 Beckton Larkeisa P688 CH
 Beckton Cody KH M390
 Beckton Rose M126 WR
 Beckton Cherokee N N479
 Beckton Susan N023 JE
 Beckton Nebula M045
 Beckton Lana M809 EP
 Beckton Champ R3 H338
 BKT Larkeisa J564 HR

DAM		Calv.Ease	BW	WW	YW	Milk	HPG	Stay	Maint.En.
Age	5	13	-5.6	52	86	24	9	17	-4.6
Wt	995	(.19)	(.34)	(.31)	(.32)	(.23)	(.06)	(.02)	(.18)
Wean Pct.	63%	Marb +.61 (.17)		REA +.00 (.15)		Bfat +.04 (.09)			
Cow Eff.	132	BWt	WWt	WR	ADG	YWt	YR	Scr.	Fr.
		69	624	109	4	1195	112	38	5.0

★★★★★ for Low Maintenance, Growth, Gainability, Marbling, High Cow Efficiency, Calving Ease, Stayability.

A-2 BECKTON ACCENT W180 C2
1-A 100% # 1331776 Tattoo: BSF9 W180

Birth: 3-12-09
 Beckton Cody KH M390
BECKTON CODY K1 P014
 Ref. A
 Beckton Rose M126 WR
 Beckton Cherokee N N479
BECKTON CHRISTY R046 CQ
 Beckton Christy N740 HR
 Beckton Cody K G701
 Beckton Tamara J124 HR
 Beckton Warrior T C371
 Beckton Rose D741 LN
 BFCK Cherokee Cnyn 4912
 Beckton Dinah C440 NM
 Beckton Herald FJ J776
 Beckton Christy K141 VG

DAM		Calv.Ease	BW	WW	YW	Milk	HPG	Stay	Maint.En.
Age	4	12	-5.2	60	99	23	10	14	-0.1
Wt	1140	(.32)	(.57)	(.50)	(.52)	(.26)	(.17)	(.07)	(.58)
Wean Pct.	57%	Marb +.50 (.22)		REA +.36 (.19)		Bfat +.06 (.34)			
Cow Eff.	121	BWt	WWt	WR	ADG	YWt	YR	Scr.	Fr.
		77	674	116	4	1217	114	39	5.5

★★★★★ for Low Maintenance, Growth, Gainability, Marbling, Rib-eye area, High Cow Efficiency, Calving Ease, Stayability.

C-1 BECKTON CLIFFTOP W692 E3
1-A 100% # 1332252 Tattoo: BKT9 W692

Birth: 4-12-09
 Beckton Clifftop T C075
BKT CLIFFTOP TP R288
 Ref. C
 Beckton Christy K209 CO
 Beckton Epic KM M115
BECKTON LYDIA S274 EP
 Beckton Lydia M607 LO
 BJR Topper 5241
 Beckton Barmaid A761 TR
 Beckton Copper JT G095
 Beckton Christy A111 VQ
 Beckton Epic K F075
 Beckton Minerva F495 CH
 Beckton Loki F251
 Beckton Lydia J801 CD

DAM		Calv.Ease	BW	WW	YW	Milk	HPG	Stay	Maint.En.
Age	3	11	-4.9	37	79	31	10	16	-3.6
Wt	980	(.30)	(.58)	(.51)	(.51)	(.26)	(.10)	(.06)	(.58)
Wean Pct.	63%	Marb +.58 (.24)		REA +.02 (.21)		Bfat +.11 (.34)			
Cow Eff.	132	BWt	WWt	WR	ADG	YWt	YR	Scr.	Fr.
		72	653	116	4	1188	115	40	5.0

★★★★★ for Low Maintenance, Growth, Gainability, Marbling, High Cow Efficiency, Calving Ease, Stayability.

A-3 BECKTON ACCENT Y260 L3
1-A 100% # 1451513 Tattoo: BKT1 Y260

Birth: 3-24-11
 Beckton Cody K1 P014
BECKTON ACCENT W180 C2
 Ref. A-2
 Beckton Christy R046 CQ
 Beckton Loki CL S284
BECKTON LANA W463 L
 Beckton Lana R327 EP
 Beckton Cody KH M390
 Beckton Rose M126 WR
 Beckton Cherokee N N479
 Beckton Christy N740 HR
 Beckton Loki C M740
 Beckton Lakme J460 LT
 Beckton Epic KM M115
 Beckton Lana K840 LN

DAM		Calv.Ease	BW	WW	YW	Milk	HPG	Stay	Maint.En.
Age	2	12	-4.8	60	99	23	9	18	-0.7
Wt	815	(.14)	(.23)	(.27)	(.29)	(.17)	(.01)	(.01)	(.03)
Wean Pct.	70%	Marb +.44 (.16)		REA +.09 (.13)		Bfat +.02 (.28)			
Cow Eff.	146	BWt	WWt	WR	ADG	YWt	YR	Scr.	Fr.
		68	627	111	3	1125	108	34	5.5

★★★★★ for Low Maintenance, Growth, Marbling, High Cow Efficiency, Calving Ease, Stayability.



Beckton Ricardo R288
Sire of Beckton Clifftop W692 (C-1)

• Reference Sires •

C-2 BECKTON CLIFFTOP Y012 C4
1-A 100% # 1451482 Tattoo: BKT1 Y012

Birth: 2-20-11
 ↙ BKT Clifftop TP R288 ↘ Beckton Clifftop T C075
BECKTON CLIFFTOP W692 E3 ↙ Beckton Christy K209 CO
 Ref. C-1 ↘ Beckton Lydia S274 EP ↘ Beckton Epic KM M115
 ↙ Beckton Clifftop T C075 ↘ Beckton Lydia M607 LO
BECKTON LANA W240 C ↙ BKT Clifftop TP R288 ↘ Beckton Christy K209 CO
 ↘ Beckton Lana L923 CD ↘ Beckton Cody K G701
 ↘ Beckton Lana D232 HV

DAM		Calv.Ease	BW	WW	YW	Milk	HPG	Stay	Maint.En.
Age	2	11	-4.3	44	83	26	12	17	-6.6
Wt	780	(.14)	(.23)	(.27)	(.29)	(.17)	(.01)	(.01)	(.03)
Wean Pct.	64%	Marb	+4.3	(.15)	REA	+1.7	(.14)	Bfat	+0.5
Cow Eff.	134	BWt	53	556	108	3	1100	112	34
		WWt				YR		Scr.	Fr.
		WR				ADG			
		ADG				YWt			
		YR				YR			
		Scr.				Fr.			
		Fr.							

★★★★★ for Low Maintenance, Growth, Marbling, Rib-eye area, High Cow Efficiency, Calving Ease, Stayability.

D-2 BECKTON DOMINOR Y005 V6
1-A 100% # 1451049 Tattoo: BSF1 Y005

Birth: 2-17-11
 ↙ Beckton Dominor Z1 R610 ↘ Beckton Dominor ZC M919
BECKTON DOMINOR W640 C5 ↘ Beckton Sierra K557 LO
 Ref. D-1 ↘ Beckton Mona R166 CQ ↘ Beckton Cherokee N N479
 ↘ Beckton Vega P079 ↘ Beckton Mona N342 HU
BECKTON BELGA W108 V ↘ Beckton Lydia H159 JL
 ↘ Beckton Julian 7526G
 ↘ Beckton Belga F772 VG

DAM		Calv.Ease	BW	WW	YW	Milk	HPG	Stay	Maint.En.
Age	2	14	-5.7	49	81	22	11	18	-2.5
Wt	820	(.13)	(.24)	(.28)	(.29)	(.17)	(.01)	(.01)	(.03)
Wean Pct.	66%	Marb	+6.1	(.16)	REA	+1.6	(.14)	Bfat	+0.4
Cow Eff.	139	BWt	64	600	106	3	1155	110	37
		WWt				YR		Scr.	Fr.
		WR				ADG			
		ADG				YWt			
		YR				YR			
		Scr.				Fr.			
		Fr.							

★★★★★ for Low Maintenance, Growth, Marbling, Rib-eye area, High Cow Efficiency, Calving Ease, Stayability.

C-3 BECKTON CHEROKEE Y129 E4
1-A 100% # 1451153 Tattoo: BKT1 Y129

Birth: 3-15-11
 ↙ Beckton Cherokee N N479 ↘ BFCK Cherokee Cnyn 4912
BECKTON CHEROKEE T450 L3 ↘ Beckton Dinah C440 NM
 Ref. C ↘ Beckton Lancer TL G626
 ↘ Beckton Annie M337 LN ↘ Beckton Annie F743 LN
 ↙ Beckton Epic K1 K863 ↘ Beckton Epic KN H110
BECKTON LANA M809 EP ↘ Beckton Rose H019 SC
 ↘ Beckton Lana K253 DM ↘ Beckton Dominor ZJ H657
 ↘ Beckton Lana HA34 DM

DAM		Calv.Ease	BW	WW	YW	Milk	HPG	Stay	Maint.En.
Age	9	11	-4.0	43	71	30	9	17	-1.6
Wt	1120	(.17)	(.34)	(.31)	(.32)	(.21)	(.15)	(.01)	(.18)
Wean Pct.	57%	Marb	+6.3	(.19)	REA	+0.6	(.17)	Bfat	+0.3
Cow Eff.	121	BWt	79	641	107	3	1149	106	40
		WWt				YR		Scr.	Fr.
		WR				ADG			
		ADG				YWt			
		YR				YR			
		Scr.				Fr.			
		Fr.							

★★★★★ for Low Maintenance, Growth, Marbling, High Cow Efficiency, Calving Ease, Stayability.

D-3 BECKTON DOMINOR Y052 N6
1-A 100% # 1451544 Tattoo: BKT1 Y052

Birth: 3-3-11
 ↙ Beckton Dominor Z1 R610 ↘ Beckton Dominor ZC M919
BECKTON DOMINOR W640 C5 ↘ Beckton Sierra K557 LO
 Ref. D-1 ↘ Beckton Mona R166 CQ ↘ Beckton Cherokee N N479
 ↘ Beckton Nebula T398 V3 ↘ Beckton Mona N342 HU
BECKTON INDIGO W772 N ↘ Beckton Minerva J615 VG
 ↘ Beckton Indigo T613 JT ↘ TR Julian LT151
 ↘ Beckton Indigo N467 LO

DAM		Calv.Ease	BW	WW	YW	Milk	HPG	Stay	Maint.En.
Age	2	12	-4.3	53	91	18	10	18	-5.5
Wt	700	(.13)	(.24)	(.28)	(.29)	(.17)	(.01)	(.01)	(.03)
Wean Pct.	77%	Marb	+6.4	(.16)	REA	+0.6	(.13)	Bfat	+0.4
Cow Eff.	163	BWt	62	601	106	4	1152	110	34
		WWt				YR		Scr.	Fr.
		WR				ADG			
		ADG				YWt			
		YR				YR			
		Scr.				Fr.			
		Fr.							

★★★★★ for Low Maintenance, Growth, Marbling, High Cow Efficiency, Calving Ease, Stayability.

D-1 BECKTON DOMINOR W640 C5
1-A 100% # 1331787 Tattoo: BSF9 W640

Birth: 4-7-09
 ↙ Beckton Dominor ZC M919 ↘ Beckton Dominor Z E401
BECKTON DOMINOR Z1 R610 ↘ Beckton Barmaid J012 CO
 Ref. D ↘ Beckton Sierra K557 LO ↘ Beckton Loki F251
 ↘ Beckton Cherokee N N479 ↘ Beckton Sierra C157 CL
BECKTON MONA R166 CQ ↘ BFCK Cherokee Cnyn 4912
 ↘ Beckton Mona N342 HU ↘ Beckton Dinah C440 NM
 ↘ Beckton Hustler C2 L079
 ↘ Beckton Lana L890 CO

DAM		Calv.Ease	BW	WW	YW	Milk	HPG	Stay	Maint.En.
Age	4	13	-6.6	43	70	21	11	16	-2.6
Wt	1160	(.29)	(.62)	(.55)	(.55)	(.26)	(.09)	(.03)	(.60)
Wean Pct.	54%	Marb	+6.3	(.23)	REA	+0.2	(.20)	Bfat	+0.7
Cow Eff.	114	BWt	80	647	109	4	1152	108	35
		WWt				YR		Scr.	Fr.
		WR				ADG			
		ADG				YWt			
		YR				YR			
		Scr.				Fr.			
		Fr.							

★★★★★ for Low Maintenance, Growth, Marbling, Calving Ease, Stayability.

E-1 BECKTON EPIC T330 L5
1-A 100% # 1178840 Tattoo: BKT7 T330

Birth: 3-15-07
 ↙ Beckton Epic KJ J722 ↘ Beckton Epic K F075
BECKTON EPIC K4 N795 ↘ Beckton Lana F891 JL
 Ref. E ↘ Beckton Sierra J789 EP ↘ Beckton Epic D404
 ↘ Beckton Lancer T A664 ↘ Beckton Sierra C157 CL
BECKTON BELGA K202 LN ↘ Beckton Lancer 9380
 ↘ Beckton Belga D460 KR ↘ Beckton Coca 9119 TJ
 ↘ Beckton Kaiser FD 9253
 ↘ Beckton Belga A573 SC

DAM		Calv.Ease	BW	WW	YW	Milk	HPG	Stay	Maint.En.
Age	7	15	-7.9	37	78	21	4	12	3.7
Wt	1105	(.54)	(.69)	(.65)	(.66)	(.52)	(.36)	(.21)	(.63)
Wean Pct.	50%	Marb	+5.7	(.30)	REA	-0.2	(.26)	Bfat	+0.4
Cow Eff.	106	BWt	65	554	100	4	1183	108	35
		WWt				YR		Scr.	Fr.
		WR				ADG			
		ADG				YWt			
		YR				YR			
		Scr.				Fr.			
		Fr.							

★★★★★ for Low Maintenance, Growth, Gainability, Marbling, Calving Ease.

• Reference Sires •

E-2 BECKTON EPIC U749 D5
1-A 100% # 1259558 Tattoo: BKT8 U749

Birth: 4-9-08
 Beckton Epic KJ J722
 Beckton Epic K F075
 Beckton Lana F891 JL
BECKTON EPIC K4 N795
 Ref. E Beckton Sierra J789 EP
 Beckton Epic D404
 Beckton Sierra C157 CL
 Beckton Dominor ZC M919
 Beckton Dominor Z E401
 Beckton Barmaid J012 CO
BECKTON DENISE R308 DM
 Beckton Denise L639 JL
 Beckton Julian GG B571
 Beckton Denise J550 CD

DAM		Calv.Ease	BW	WW	YW	Milk	HPG	Stay	Maint.En.
Age	3	10	-2.9	60	117	18	2	13	6.0
Wt	1025	(.41)	(.66)	(.59)	(.61)	(.35)	(.31)	(.13)	(.62)
Wean Pct.	59%	Marb +57 (.27)		REA +54 (.24)		Bfat +03 (.38)			
Cow Eff.	123	BWt	WWt	WR	ADG	YWt	YR	Scr.	Fr.
		77	640	111	4	1201	112	34	5.5

★★★★★ for Growth, Gainability, Marbling, Rib-eye area, High Cow Efficiency, Calving Ease, Stayability.

E-4 BECKTON EMPEROR Y459 J3
1-A 100% # 1451554 Tattoo: BKB1 Y459

Birth: 4-5-11
 Beckton Emperor R100
 Beckton Epic K4 N795
 Beckton Tamara N180 JO
BECKTON EMPEROR T641 E2
 Ref. E Beckton Vernice R416 EP
 Beckton Epic K3 M606
 Beckton Vernice K482 HD
 Beckton Jet L P491
 TR Julian LT151
 Beckton Minerva L278 LN
BECKTON INDIGO S354 JT
 Beckton Indigo P676 LN
 Beckton Lancer T5 L095
 Beckton Indigo L588 LN

DAM		Calv.Ease	BW	WW	YW	Milk	HPG	Stay	Maint.En.
Age	5	12	-5.0	42	69	17	7	14	-4.9
Wt	1050	(.20)	(.34)	(.31)	(.32)	(.24)	(.07)	(.04)	(.18)
Wean Pct.	58%	Marb +63 (.16)		REA +19 (.14)		Bfat +00 (.07)			
Cow Eff.	122	BWt	WWt	WR	ADG	YWt	YR	Scr.	Fr.
		72	607	102	3	1111	103	36	5.5

★★★★★ for Low Maintenance, Marbling, Rib-eye area, High Cow Efficiency, Calving Ease, Stayability.



Beckton Epic K4 N795
Sire of Beckton Epic T330 (E-1) and Beckton Epic U749 (E-2)

E-5 BECKTON EPIC Y484 N6
1-A 100% # 1451237 Tattoo: BKT1 Y484

Birth: 4-8-11
 Beckton Epic K4 N795
 Beckton Sierra J789 EP
BECKTON EPIC U749 D5
 Ref. E-2 Beckton Denise R308 DM
 Beckton Dominor ZC M919
 Beckton Denise L639 JL
 Beckton Nebula P P707
 Beckton Nebula M045
 Beckton Lana M809 EP
BECKTON LYDIA S069 NB
 Beckton Lydia P583 WR
 Beckton Warrior CL M686
 Beckton Lydia M121 WR

DAM		Calv.Ease	BW	WW	YW	Milk	HPG	Stay	Maint.En.
Age	5	11	-3.3	63	113	15	7	16	-0.4
Wt	980	(.17)	(.34)	(.30)	(.32)	(.22)	(.07)	(.01)	(.18)
Wean Pct.	71%	Marb +48 (.18)		REA +55 (.16)		Bfat +00 (.29)			
Cow Eff.	149	BWt	WWt	WR	ADG	YWt	YR	Scr.	Fr.
		77	692	116	4	1251	116	38	5.5

★★★★★ for Low Maintenance, Growth, Marbling, Rib-eye area, High Cow Efficiency, Calving Ease, Stayability.

E-3 BECKTON EPIC X330 L6
1-A 100% # 1382765 Tattoo: BKT0 X330

Birth: 3-20-10
 Beckton Epic K4 N795
 Beckton Epic KJ J722
 Beckton Sierra J789 EP
BECKTON EPIC T330 L5
 Ref. E-1 Beckton Belga K202 LN
 Beckton Lancer T A664
 Beckton Belga D460 KR
 Beckton Lancer T A664
 Bkt Suffeina A828 DM
BECKTON KIT R503 LN
 Beckton Kit F468 JL
 Beckton Julian GG B571
 Beckton Kit A517 NP

DAM		Calv.Ease	BW	WW	YW	Milk	HPG	Stay	Maint.En.
Age	5	10	-3.9	50	89	14	6	15	-3.6
Wt	940	(.29)	(.49)	(.41)	(.42)	(.24)	(.16)	(.03)	(.50)
Wean Pct.	65%	Marb +71 (.22)		REA +39 (.19)		Bfat +05 (.33)			
Cow Eff.	137	BWt	WWt	WR	ADG	YWt	YR	Scr.	Fr.
		71	610	103	4	1165	108	37	5.5

★★★★★ for Low Maintenance, Growth, Marbling, Rib-eye area, High Cow Efficiency, Calving Ease, Stayability.

H-1 BECKTON HERITAGE X356 E2
1-A 100% # 1383152 Tattoo: BKT0 X356

Birth: 3-21-10
 Beckton Hustler C2 L079
 Beckton Hustler CN J102
 Beckton Barmaid J012 CO
BECKTON HERITAGE N013
 Ref. H Beckton Lana L007 JL
 Beckton Julian G1 J526
 Beckton Lana J790 EP
 Beckton Epic K4 N795
 Beckton Epic KJ J722
 Beckton Sierra J789 EP
BECKTON LANA S489 EP
 Beckton Lana E136 TP
 RDD B Topper 1675
 Beckton Lana 9714 LS

DAM		Calv.Ease	BW	WW	YW	Milk	HPG	Stay	Maint.En.
Age	4	7	-2.7	60	96	14	4	10	-2.2
Wt	1115	(.29)	(.47)	(.41)	(.42)	(.25)	(.10)	(.12)	(.48)
Wean Pct.	55%	Marb +91 (.24)		REA -03 (.22)		Bfat +04 (.33)			
Cow Eff.	115	BWt	WWt	WR	ADG	YWt	YR	Scr.	Fr.
		84	630	105	4	1207	109	36	5.5

★★★★★ for Low Maintenance, Growth, Marbling, Calving Ease.

• Reference Sires •

H-2 BECKTON HASTEN Y069 D4
1-A 100% # 1451614 Tattoo: BSF1 Y069

Birth: 3-6-11
 Beckton Hasten H S462
BECKTON HASTEN U108 J3
 Ref. H Beckton Encino S456 JC
 Beckton Dominor Z E401
BECKTON MARTA P484 DM
 Beckton Marta K254 LN
 Beckton Hasten P292
 Beckton Lakme G128 HD
 Beckton Justice G302
 Beckton Encino J431 DM
 Beckton Dominor 9455
 Beckton Belga B061 ZN
 Beckton Lancer T A664
 Beckton Marta G512 LN

DAM		Calv.Ease	BW	WW	YW	Milk	HPG	Stay	Maint.En.
Age	7	12	-4.7	51	90	15	10	16	-2.5
Wt	1195	(.19)	(.34)	(.31)	(.32)	(.24)	(.14)	(.04)	(.18)
Wean Pct.	52%	Marb +.41 (.18)		REA -.12 (.16)		Bfat +.02 (.29)			
Cow Eff.	109	BWt	WWt	WR	ADG	YWt	YR	Scr.	Fr.
		78	618	108	4	1243	117	36	5.5

★★★★★ for Low Maintenance, Growth, Gainability, Marbling, Calving Ease, Stayability.

J-3 BECKTON JULIAN W743 H5
1-A 100% # 1331657 Tattoo: BSF9 W743

Birth: 4-18-09
 Beckton Julian GJ P535
BECKTON JULIAN G5 S107
 Ref. J-2 Beckton Minola P826 DM
 Beckton Herald F FA20
BECKTON KIT L399 HR
 Beckton Kit F468 JL
 Beckton Julian 7526G
 Beckton Mona D086 JL
 Beckton Dominor ZC M919
 Beckton Minola M641 WR
 Leachman Heavenly 8141
 Beckton Barona C548 FF
 Beckton Julian GG B571
 Beckton Kit A517 NP

DAM		Calv.Ease	BW	WW	YW	Milk	HPG	Stay	Maint.En.
Age	8	12	-2.8	61	97	19	13	15	1.3
Wt	1190	(.29)	(.43)	(.38)	(.39)	(.25)	(.15)	(.01)	(.43)
Wean Pct.	54%	Marb +.62 (.20)		REA +.09 (.17)		Bfat +.05 (.31)			
Cow Eff.	113	BWt	WWt	WR	ADG	YWt	YR	Scr.	Fr.
		69	640	110	4	1219	114	39	5.5

★★★★★ for Low Maintenance, Growth, Gainability, Marbling, Calving Ease, Stayability.

J-1 BECKTON JULIAN GG B571
1-A 100% # 387580 Tattoo: WF2 B571

Birth: 3-27-92
 Beckton Julian 6592
BECKTON JULIAN 7526G
 Ref. J Bkt Belga 6746 GS
 Beckton Julian 7526G
BKT MARTA 9A13 JL
 Bkt Marta 6498 XM
 Beckton Trojan 5253
 Lchmn Christy 2339
 Beckton Gisa 4454
 Beckton Lalaxigu -2
 Beckton Julian 6592
 Bkt Belga 6746 GS
 Beckton Xime 4736
 Beckton Marwa -K

DAM		Calv.Ease	BW	WW	YW	Milk	HPG	Stay	Maint.En.
Age	3	24	-6.2	28	55	15	13	21	-6.2
Wt	1015	(.92)	(.93)	(.92)	(.92)	(.91)	(.88)	(.82)	(.64)
Wean Pct.	56%	Marb +.20 (.89)		REA +.30 (.89)		Bfat +.02 (.90)			
Cow Eff.	118	BWt	WWt	WR	ADG	YWt	YR	Scr.	Fr.
		65	627	113	3	1140	112	NA	5.0

★★★★★ for Low Maintenance, Marbling, Rib-eye area, High Cow Efficiency, Calving Ease, Stayability.

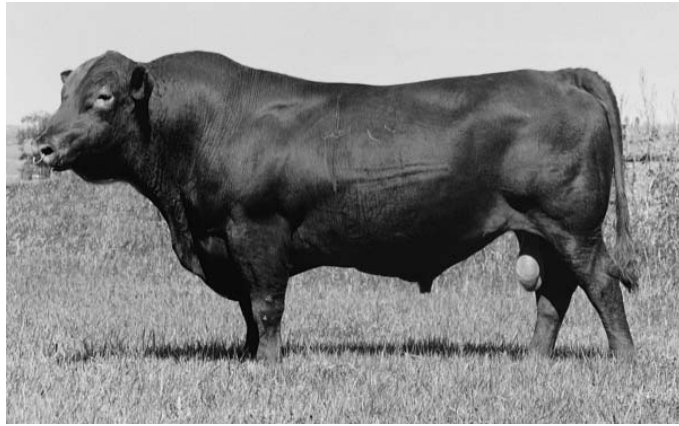

Beckton Julian B571
Sire of lot 100; Ref. Sire J-1

J-2 BECKTON JULIAN G5 S107
1-A 100% # 1118570 Tattoo: WF6 S107

Birth: 2-21-06
 Beckton Julian 7526G
BECKTON JULIAN GJ P535
 Ref. J Beckton Mona D086 JL
 Beckton Dominor ZC M919
BECKTON MINOLA P826 DM
 Beckton Minola M641 WR
 Beckton Julian 6592
 Bkt Belga 6746 GS
 Beckton Julian GV Z693
 Beckton Mona 9356 KR
 Beckton Dominor Z E401
 Beckton Barmaid J012 CO
 Beckton Warrior T C371
 Beckton Minola H170 JL

DAM		Calv.Ease	BW	WW	YW	Milk	HPG	Stay	Maint.En.
Age	2	9	-1.5	55	92	18	15	17	-1.1
Wt	1010	(.60)	(.72)	(.67)	(.68)	(.57)	(.32)	(.01)	(.64)
Wean Pct.	55%	Marb +.50 (.27)		REA +.05 (.23)		Bfat +.10 (.38)			
Cow Eff.	116	BWt	WWt	WR	ADG	YWt	YR	Scr.	Fr.
		74	640	115	4	1237	113	43	4.5

★★★★★ for Low Maintenance, Growth, Gainability, Marbling, High Cow Efficiency, Calving Ease, Stayability.

J-4 BECKTON JULIAN X465 J5
1-A 100% # 1382724 Tattoo: BKT0 X465

Birth: 3-27-10
 Beckton Julian GJ P535
BECKTON JULIAN G5 S107
 Ref. J-2 Beckton Minola P826 DM
 Beckton Julian GG B571
BECKTON SUFFEINA P643 JL
 Bkt Suffeina A828 DM
 Beckton Julian 7526G
 Beckton Mona D086 JL
 Beckton Dominor ZC M919
 Beckton Minola M641 WR
 Beckton Julian 7526G
 Bkt Marta 9A13 JL
 Beckton Dominor 9455
 Bkt Suffeina 9493 TT

DAM		Calv.Ease	BW	WW	YW	Milk	HPG	Stay	Maint.En.
Age	6	8	-0.1	60	106	16	13	17	-5.4
Wt	1085	(.31)	(.49)	(.41)	(.41)	(.25)	(.17)	(.04)	(.49)
Wean Pct.	62%	Marb +.80 (.20)		REA +.09 (.18)		Bfat +.04 (.31)			
Cow Eff.	131	BWt	WWt	WR	ADG	YWt	YR	Scr.	Fr.
		84	676	113	4	1261	114	39	5.5

★★★★★ for Low Maintenance, Growth, Gainability, Marbling, High Cow Efficiency, Calving Ease, Stayability.

• Reference Sires •

L-1 BECKTON LEGEND S670
1-A 100% # 1119132 Tattoo: WF6 S670

Birth: 3-31-06
 Beckton Lancer T A664
BECKTON LANCER F442 T
 Ref. L \ Bkt Suffeina A828 DM
 Beckton Lancer 9380
 Beckton Coca 9119 TJ
 Beckton Dominor 9455
 Bkt Suffeina 9493 TT
 Beckton Julian 7526G
 Bkt Marta 9A13 JL
BECKTON KIT F468 JL
 \ Beckton Kit A517 NP
 \ Bkt Neptune 8460 R
 \ BchRch Kit935 35L416

DAM		Calv.Ease	BW	WW	YW	Milk	HPG	Stay	Maint.En.
Age	10	12	-3.7	46	64	7	8	19	-13.2
Wt	NA	(.64)	(.68)	(.66)	(.66)	(.62)	(.47)	(.48)	(.63)
Wean Pct.	NA	Marb +1.01 (.41)		REA +56 (.36)		Bfat +03 (.43)			
Cow Eff.	NA	BWt	WWt	WR	ADG	YWt	YR	Scr.	Fr.
		76	523	89	4	1017	94	36	5.0

★★★★★ for Low Maintenance, Marbling, Rib-eye area, Calving Ease, Stayability.

L-3 BECKTON LIKABLE U120 L2
1-A 100% # 1258806 Tattoo: BKT8 U120

Birth: 3-4-08
 Beckton Lancer F442 T
BECKTON LIKABLE S633
 Ref. L \ Beckton Kit F468 JL
 Beckton Lancer T A664
 Bkt Suffeina A828 DM
 Beckton Julian GG B571
 Beckton Kit A517 NP
 Beckton Lancer T A664
 Bkt Suffeina A828 DM
BECKTON LANA S718 LN
 \ Beckton Lana F891 JL
 \ Beckton Clifftop T C075
 \ Beckton Lana 9610 TP

DAM		Calv.Ease	BW	WW	YW	Milk	HPG	Stay	Maint.En.
Age	2	8	-2.9	43	69	14	6	16	-2.3
Wt	1010	(.51)	(.64)	(.60)	(.62)	(.48)	(.08)	(.03)	(.62)
Wean Pct.	53%	Marb +52 (.28)		REA +49 (.25)		Bfat +00 (.38)			
Cow Eff.	111	BWt	WWt	WR	ADG	YWt	YR	Scr.	Fr.
		67	594	104	4	1069	103	35	5.5

★★★★★ for Low Maintenance, Gainability, Marbling, Rib-eye area, Calving Ease, Stayability.



Beckton Lancer F442 T
Sire of Beckton Legend S670 (L-1) and Beckton Lancer T371 (L-2)

L-4 BECKTON LEGEND U331 E2
1-A 100% # 1258800 Tattoo: BKT8 U331

Birth: 3-17-08
 Beckton Lancer F442 T
BECKTON LEGEND S670
 Ref. L-1 \ Beckton Kit F468 JL
 Beckton Lancer T A664
 Bkt Suffeina A828 DM
 Beckton Julian GG B571
 Beckton Kit A517 NP
 Beckton Epic K4 N795
BECKTON LANA S669 EP
 \ Beckton Lana M597 LO
 \ Beckton Epic KJ J722
 \ Beckton Sierra J789 EP
 \ Beckton Loki F251
 \ Beckton Lana J131 CT

DAM		Calv.Ease	BW	WW	YW	Milk	HPG	Stay	Maint.En.
Age	2	14	-6.5	40	70	15	2	16	-1.3
Wt	955	(.39)	(.47)	(.46)	(.47)	(.36)	(.29)	(.03)	(.46)
Wean Pct.	49%	Marb +1.29 (.21)		REA +15 (.19)		Bfat +03 (.12)			
Cow Eff.	103	BWt	WWt	WR	ADG	YWt	YR	Scr.	Fr.
		57	526	98	4	1026	101	33	5.0

★★★★★ for Low Maintenance, Gainability, Marbling, Rib-eye area, Calving Ease, Stayability.

L-2 BECKTON LANCER T371 H4
1-A 100% # 1178419 Tattoo: BKT7 T371

Birth: 3-16-07
 Beckton Lancer T A664
BECKTON LANCER F442 T
 Ref. L \ Bkt Suffeina A828 DM
 Beckton Lancer 9380
 Beckton Coca 9119 TJ
 Beckton Dominor 9455
 Bkt Suffeina 9493 TT
 Leachman Heavenly 8141
BECKTON COCA F276 HV
 \ Beckton Coca B112 CB
 \ Lchmn Mldd Hvywt2463
 \ Leachman Dina 7011
 \ Beckton Cobalt K Z100
 \ Beckton Coca 2075 CB

DAM		Calv.Ease	BW	WW	YW	Milk	HPG	Stay	Maint.En.
Age	11	9	-2.9	59	92	7	4	12	2.4
Wt	1245	(.64)	(.74)	(.71)	(.71)	(.63)	(.42)	(.30)	(.65)
Wean Pct.	55%	Marb +25 (.33)		REA +00 (.31)		Bfat -03 (.42)			
Cow Eff.	116	BWt	WWt	WR	ADG	YWt	YR	Scr.	Fr.
		89	722	126	4	1292	118	37	5.5

★★★★★ for Low Maintenance, Growth, Gainability, Marbling, High Cow Efficiency, Calving Ease.

L-5 BECKTON LIKABLE Y124 L3
1-A 100% # 1451666 Tattoo: BSF1 Y124

Birth: 3-15-11
 Beckton Likable S633
BECKTON LIKABLE U130 L2
 Ref. L \ Beckton Kit S478 LN
 Beckton Lancer F442 T
 Beckton Kit F468 JL
 Beckton Lancer T1 H080
 Beckton Ruth G534 NP
 Beckton Lasso P741
BKT PINE MARIE S802 LO
 \ BKT Pine Marie P475 LN
 \ Beckton Lancer T4 J536
 \ Bkt Pine Marie LC30 CD

DAM		Calv.Ease	BW	WW	YW	Milk	HPG	Stay	Maint.En.
Age	5	10	-3.6	51	86	13	10	15	3.0
Wt	1080	(.17)	(.33)	(.30)	(.31)	(.22)	(.06)	(.01)	(.18)
Wean Pct.	58%	Marb +77 (.17)		REA +24 (.15)		Bfat +07 (.28)			
Cow Eff.	121	BWt	WWt	WR	ADG	YWt	YR	Scr.	Fr.
		72	622	109	4	1192	112	38	5.5

★★★★★ for Low Maintenance, Growth, Marbling, Rib-eye area, High Cow Efficiency, Calving Ease, Stayability.

• Reference Sires •

L-6 BECKTON LIKABLE Y362 L3
1-A 100% # 1451148 Tattoo: BKT1 Y362

Birth: 3-28-11
 Beckton Likable S633
BECKTON LIKABLE U130 L2
 Ref. L Beckton Kit S478 LN
 Beckton Lancer TA K644
BECKTON TAMARA M515 LN
 Beckton Tamara K322 LN
 Beckton Lancer F442 T
 Beckton Kit F468 JL
 Beckton Lancer F442 T
 Beckton Kit F468 JL
 Beckton Lancer T A664
 Beckton Tamara B570 JL
 Beckton Lancer T A664
 Beckton Tamara G124 CH

Calv.Ease	BW	WW	YW	Milk	HPG	Stay	Maint.En.
9	-2.5	55	92	10	8	14	3.5
(.18)	(.33)	(.30)	(.31)	(.22)	(.07)	(.04)	(.18)

DAM	
Age	9
Wt	1200
Wean Pct.	55%
Cow Eff.	115

Marb	REA	Bfat
+0.74	+0.32	+0.07
(.19)	(.17)	(.30)

BWt	WWt	WR	ADG	YWt	YR	Scr.	Fr.
79	656	108	4	1211	113	35	5.5

★★★★★ for Low Maintenance, Growth, Gainability, Marbling, Rib-eye area, Calving Ease, Stayability.



Beckton Nebula M045
Sire of lot 182; Ref. Sire N-1

L-7 BECKTON LIKABLE Y675 E3
1-A 100% # 1451312 Tattoo: BKT1 Y675

Birth: 5-7-11
 Beckton Likable S633
BECKTON LIKABLE U120 L2
 Ref. L-3 Beckton Lana S718 LN
 Beckton Epic KM M115
BECKTON FIREFLY T331 EP
 Beckton Firefly N457 CO
 Beckton Lancer F442 T
 Beckton Kit F468 JL
 Beckton Lancer F442 T
 Beckton Lana F891 JL
 Beckton Epic K F075
 Beckton Minerva F495 CH
 Beckton Copper JT G095
 Beckton Firefly K180 CH

Calv.Ease	BW	WW	YW	Milk	HPG	Stay	Maint.En.
4	-0.2	57	90	20	9	20	2.3
(.18)	(.33)	(.30)	(.31)	(.22)	(.01)	(.01)	(.17)

DAM	
Age	4
Wt	1220
Wean Pct.	54%
Cow Eff.	113

Marb	REA	Bfat
+0.54	+0.23	+0.02
(.18)	(.15)	(.28)

BWt	WWt	WR	ADG	YWt	YR	Scr.	Fr.
91	673	111	3	675	63	36	NA

★★★★★ for Low Maintenance, Marbling, Rib-eye area, Stayability.

N-1 BECKTON NEPTUNE R2 K065
1-A 100% # 854775 Tattoo: BKT2 M045

Birth: 2-19-02
 Beckton Neptune RR B284
BECKTON NEPTUNE R2 K065
 Ref. Beckton Lana C735 TP
 Beckton Julian GG B571
BECKTON BELGA K285 JL
 Beckton Belga G493 HR
 Bkt Neptune 8460 R
 Beckton Eola 8600 RR
 RDD B Topper 1675
 Beckton Lana A714 TR
 Beckton Julian 7526G
 Bkt Marta 9A13 JL
 Beckton Herald K B244
 Beckton Belga D776 CL

Calv.Ease	BW	WW	YW	Milk	HPG	Stay	Maint.En.
17	-8.1	46	79	8	11	13	-8.9
(.87)	(.91)	(.89)	(.89)	(.87)	(.75)	(.54)	(.68)

DAM	
Age	2
Wt	860
Wean Pct.	59%
Cow Eff.	125

Marb	REA	Bfat
+0.52	-0.47	+0.07
(.70)	(.68)	(.67)

BWt	WWt	WR	ADG	YWt	YR	Scr.	Fr.
59	586	108	4	1080	106	35	5.0

★★★★★ for Low Maintenance, Growth, Marbling, High Cow Efficiency, Calving Ease, Stayability.



Beckton Nebula P707
Sire of lot 121; Ref. Sire N-2

N-2 BECKTON NEPTUNE R2 K065
1-A 100% # 979031 Tattoo: BKT4 P707

Birth: 4-1-04
 Beckton Neptune R2 K065
BECKTON NEPTUNE R2 K065
 Ref. N-1 Beckton Belga K285 JL
 Beckton Epic K1 K863
BECKTON LANA M809 EP
 Beckton Lana K253 DM
 Beckton Neptune RR B284
 Beckton Lana C735 TP
 Beckton Julian GG B571
 Beckton Belga G493 HR
 Beckton Epic KN H110
 Beckton Rose H019 SC
 Beckton Dominor ZJ H657
 Beckton Lana HA34 DM

Calv.Ease	BW	WW	YW	Milk	HPG	Stay	Maint.En.
17	-6.4	60	108	20	10	14	-4.4
(.81)	(.87)	(.85)	(.86)	(.80)	(.54)	(.47)	(.67)

DAM	
Age	2
Wt	890
Wean Pct.	71%
Cow Eff.	150

Marb	REA	Bfat
+0.94	-0.25	+0.04
(.57)	(.53)	(.55)

BWt	WWt	WR	ADG	YWt	YR	Scr.	Fr.
68	728	127	4	1265	122	37	5.0

★★★★★ for Low Maintenance, Growth, Marbling, High Cow Efficiency, Calving Ease, Stayability.

• Reference Sires •

N-3 BECKTON NEBULA T269 E2
1-A 100% # 1178779 Tattoo: BKT7 T269

Birth: 3-12-07
 Beckton Neptune R2 K065
BECKTON NEBULA M045
 Ref. N-1 Beckton Belga K285 JL
 Beckton Neptune RR B284
 Beckton Lana C735 TP
 Beckton Julian GG B571
 Beckton Belga G493 HR
 Beckton Epic KN H110
BECKTON RUTH M967 EP
 Beckton Ruth A905 SG
 Beckton Tara F633 NM
 Beckton Saga K 9731
 Beckton Ruth 9A57 VK

Calv.Ease	BW	WW	YW	Milk	HPG	Stay	Maint.En.
12	-4.2	49	79	16	6	14	-5.3
(.63)	(.76)	(.72)	(.73)	(.60)	(.41)	(.17)	(.65)
DAM		Marb +0.45 (.33)		REA -0.04 (.29)		Bfat +0.04 (.42)	
BWt	WWt	WR	ADG	YWt	YR	Scr.	Fr.
75	522	94	4	1145	105	37	5.5

DAM	
Age	5
Wt	1055
Wean Pct.	50%
Cow Eff.	104

★★★★★ for Low Maintenance, Gainability, Marbling, Calving Ease, Stayability.

N-5 BECKTON NEBULA W486 D3
1-A 100% # 1332209 Tattoo: BKT9 W486

Birth: 3-28-09
 Beckton Nebula M045
BECKTON NEBULA L P093
 Ref. N Beckton Marta M021 LN
 Beckton Neptune R2 K065
 Beckton Belga K285 JL
 Beckton Lancer TA K644
 Beckton Marta K254 LN
 Beckton Dominor ZC M919
BECKTON BELGA R716 DM
 Beckton Belga K285 JL
 Beckton Barmaid J012 CO
 Beckton Julian GG B571
 Beckton Belga G493 HR

Calv.Ease	BW	WW	YW	Milk	HPG	Stay	Maint.En.
10	-2.9	53	90	11	9	17	-1.0
(.29)	(.41)	(.40)	(.43)	(.25)	(.20)	(.08)	(.46)
DAM		Marb +0.44 (.24)		REA +0.09 (.22)		Bfat +0.03 (.35)	
BWt	WWt	WR	ADG	YWt	YR	Scr.	Fr.
77	608	105	4	1167	109	36	5.5

DAM	
Age	4
Wt	1030
Wean Pct.	57%
Cow Eff.	120

★★★★★ for Low Maintenance, Growth, Gainability, Marbling, High Cow Efficiency, Calving Ease, Stayability.

N-4 BECKTON NEBULA T398 V3
1-A 100% # 1178446 Tattoo: BKT7 T398

Birth: 3-17-07
 Beckton Nebula M045
BECKTON NEBULA L P093
 Ref. N Beckton Marta M021 LN
 Beckton Neptune R2 K065
 Beckton Belga K285 JL
 Beckton Lancer TA K644
 Beckton Marta K254 LN
 Beckton Vegas PK F485
BECKTON MINERVA J615 VG
 Beckton Minerva F433 VG
 Beckton Vegas P D462
 Beckton Lakme D399 KR
 Beckton Vegas 9433
 Beckton Minerva C556 SC

Calv.Ease	BW	WW	YW	Milk	HPG	Stay	Maint.En.
11	-4.3	48	77	17	13	11	-9.7
(.67)	(.74)	(.71)	(.72)	(.65)	(.39)	(.17)	(.65)
DAM		Marb +0.40 (.30)		REA +0.15 (.27)		Bfat +0.01 (.39)	
BWt	WWt	WR	ADG	YWt	YR	Scr.	Fr.
77	611	110	4	1234	113	40	6.0

DAM	
Age	8
Wt	1175
Wean Pct.	52%
Cow Eff.	110

★★★★★ for Low Maintenance, Growth, Gainability, Marbling, Rib-eye area, Calving Ease.

N-6 BECKTON NEBULA W778 J4
1-A 100% # 1332241 Tattoo: BKT9 W778

Birth: 4-20-09
 Beckton Nebula P P707
BECKTON NEBULA PJ S543
 Ref. N Beckton Lana P685 JO
 Beckton Nebula M045
 Beckton Lana M809 EP
 Beckton Julio L233
 Beckton Lana E083 CD
 Beckton Jet L P491
BECKTON LANA S197 JT
 Beckton Lana P828 LN
 TR Julian LT151
 Beckton Minerva L278 LN
 Beckton Lancer T4 J536
 Beckton Lana K284 LN

Calv.Ease	BW	WW	YW	Milk	HPG	Stay	Maint.En.
19	-9.4	47	79	17	6	16	2.8
(.29)	(.44)	(.40)	(.43)	(.23)	(.09)	(.04)	(.51)
DAM		Marb +0.84 (.20)		REA -0.03 (.17)		Bfat +0.03 (.32)	
BWt	WWt	WR	ADG	YWt	YR	Scr.	Fr.
63	635	113	4	1126	109	35	5.5

DAM	
Age	3
Wt	965
Wean Pct.	62%
Cow Eff.	130

★★★★★ for Low Maintenance, Growth, Marbling, High Cow Efficiency, Calving Ease, Stayability.



Dianne Vanek

Beckton Nebula P093
Sire of Beckton Nebula T398 (N-4) and Beckton Nebula W486 (N-5)

N-7 BECKTON NEBULA Y002 C5
1-A 100% # 1451460 Tattoo: BKT1 Y002

Birth: 2-12-11
 Beckton Nebula PJ S543
BECKTON NEBULA W778 J4
 Ref. N-6 Beckton Lana S197 JT
 Beckton Nebula P P707
 Beckton Lana P685 JO
 Beckton Jet L P491
 Beckton Lana P828 LN
 BKT Clifftop TP R288
BKT PINE MARIE W102 C
 BKT Pine Marie M119 EP
 Beckton Clifftop T C075
 Beckton Christy K209 CO
 Beckton Epic K F075
 Bkt Pine Marie D126 JL

Calv.Ease	BW	WW	YW	Milk	HPG	Stay	Maint.En.
17	-7.8	48	81	19	9	18	-4.5
(.13)	(.22)	(.26)	(.28)	(.17)	(.01)	(.01)	(.16)
DAM		Marb +0.73 (.15)		REA +0.09 (.13)		Bfat +0.03 (.25)	
BWt	WWt	WR	ADG	YWt	YR	Scr.	Fr.
65	599	116	3	1136	116	35	5.0

DAM	
Age	2
Wt	805
Wean Pct.	67%
Cow Eff.	141

★★★★★ for Low Maintenance, Growth, Marbling, High Cow Efficiency, Calving Ease, Stayability.

• Reference Sires •

N-8 BECKTON NEBULA Y036 N4
1-A 100% # 1451504 Tattoo: BKT1 Y036

Birth: 2-27-11
 Beckton Nebula T269 E2
BECKTON NEBULA W065 C3
 Ref. N Beckton Lana T104 CT
 Beckton Nebula M045
 Beckton Ruth M967 EP
 BKT Clifftop TP R288
 Beckton Lana R128 LS
 Beckton Nebula L P093
BECKTON ROSE W402 N
 Beckton Rose L311 LN
 Beckton Nebula M045
 Beckton Marta M021 LN
 Beckton Lancer F442 T
 Beckton Rose H292 HD

DAM		Calv.Ease	BW	WW	YW	Milk	HPG	Stay	Maint.En.
Age	2	10	-3.5	57	92	12	11	18	-2.6
Wt	920	(.14)	(.23)	(.27)	(.28)	(.17)	(.01)	(.01)	(.16)
Wean Pct.	49%	Marb	+.38 (.16)		REA	+.26 (.14)		Bfat	+.02 (.28)
Cow Eff.	103	BWt	WWt	WR	ADG	YWt	YR	Scr.	Fr.
		66	511	99	3	1031	105	37	5.5

★★★★★ for Low Maintenance, Growth, Marbling, Rib-eye area, Calving Ease, Stayability.

S-1 BECKTON SCAMP X494 E3
1-A 100% # 1382791 Tattoo: BKT0 X494

Birth: 3-28-10
 Beckton Scamp 8954
BECKTON SCAMP T A825
 Ref. S Bkt Encino 8459 TJ
 Beckton Julian 7526G
 Bkt Kusi Annie 5462
 Beckton Trojan 7061P
 BCH Kit 7132-784
 Beckton Epic K F075
BECKTON LANA S074 EP
 Beckton Lana P317 JL
 BKT Larkeisa L274 HU
 Beckton Julian G2 M345
 Beckton Lana M078 LN

DAM		Calv.Ease	BW	WW	YW	Milk	HPG	Stay	Maint.En.
Age	4	11	-4.3	56	88	21	10	12	-9.6
Wt	1060	(.29)	(.50)	(.40)	(.40)	(.24)	(.10)	(.17)	(.52)
Wean Pct.	63%	Marb	+.49 (.22)		REA	+.27 (.20)		Bfat	+.03 (.31)
Cow Eff.	133	BWt	WWt	WR	ADG	YWt	YR	Scr.	Fr.
		78	692	116	4	1190	110	40	5.5

★★★★★ for Low Maintenance, Growth, Marbling, Rib-eye area, High Cow Efficiency, Calving Ease.

N-9 BECKTON NEW ERA Y194
1-A 100% # 1451309 Tattoo: BKT1 Y194

Birth: 3-20-11
 Beckton Nebula M045
BECKTON NEBULA P P707
 Ref. N-2 Beckton Lana M809 EP
 Beckton Neptune R2 K065
 Beckton Belga K285 JL
 Beckton Epic K1 K863
 Beckton Lana K253 DM
 Beckton Justice C1 R483
BKT LARKEISA T310 JC
 BKT Larkeisa R775 JC
 Beckton Justice CH M056
 Beckton Tamara J124 HR
 Beckton Justice C K449
 BKT Larkeisa L149 CK

DAM		Calv.Ease	BW	WW	YW	Milk	HPG	Stay	Maint.En.
Age	4	17	-4.6	70	118	19	9	14	-4.3
Wt	950	(.32)	(.42)	(.37)	(.39)	(.28)	(.30)	(.40)	(.18)
Wean Pct.	82%	Marb	+.77 (.33)		REA	-.15 (.27)		Bfat	+.05 (.36)
Cow Eff.	174	BWt	WWt	WR	ADG	YWt	YR	Scr.	Fr.
		67	803	132	4	1307	121	36	5.5

★★★★★ for Low Maintenance, Growth, Marbling, High Cow Efficiency, Calving Ease, Stayability.

W-1 BECKTON WARHAWK N560
1-A 100% # 916682 Tattoo: BKT3 N560

Birth: 3-27-03
 Beckton Warrior TC E801
BECKTON WARRIOR T1 H281
 Ref. W Beckton Minerva B609 RN
 Beckton Warrior T C371
 Beckton Minola C251 NM
 Beckton Ranger H Z095
 Beckton Minerva Z936 RN
 Beckton Hadrian A100
BECKTON FIREFLY H195 HD
 Beckton Firefly C999 CB
 Beckton Julian GN 9A45
 Bkt Marta 9A13 JL
 Beckton Cobalt K Z100
 Bkt Firefly 7252 GS

DAM		Calv.Ease	BW	WW	YW	Milk	HPG	Stay	Maint.En.
Age	5	18	-7.5	19	42	14	20	9	-1.1
Wt	1070	(.62)	(.75)	(.71)	(.69)	(.63)	(.34)	(.17)	(.46)
Wean Pct.	54%	Marb	+.04 (.46)		REA	-.03 (.42)		Bfat	-.01 (.27)
Cow Eff.	115	BWt	WWt	WR	ADG	YWt	YR	Scr.	Fr.
		61	582	100	3	1014	97	33	5.0

★★★★★ for Low Maintenance, Calving Ease.

O-1 BECKTON JANUS X799 L2
1-A 100% # 1382654 Tattoo: BKT0 X799

Birth: 4-29-10
 TR Romeo NT379
BECKTON ROMAN J S158
 Ref. O Beckton Belga K285 JL
 Buffalo Creek Romeo L081
 Buf Crk Lass L420
 Beckton Julian GG B571
 Beckton Belga G493 HR
 Beckton Loki F251
BECKTON SIERRA K557 LO
 Beckton Sierra C157 CL
 Beckton Lancer TZ D525
 Bkt Pine Marie D126 JL
 Beckton Clipper JL A095
 Beckton Sierra A086 CL

DAM		Calv.Ease	BW	WW	YW	Milk	HPG	Stay	Maint.En.
Age	10	11	-2.5	56	92	23	3	11	0.6
Wt	1120	(.31)	(.50)	(.42)	(.42)	(.25)	(.17)	(.12)	(.50)
Wean Pct.	58%	Marb	+.33 (.20)		REA	+.22 (.18)		Bfat	+.00 (.31)
Cow Eff.	122	BWt	WWt	WR	ADG	YWt	YR	Scr.	Fr.
		84	651	109	4	1189	110	36	6.0

★★★★★ for Low Maintenance, Growth, Gainability, Marbling, Rib-eye area, High Cow Efficiency, Calving Ease.

W-2 BECKTON WARRIOR W534 N4
1-A 100% # 1332228 Tattoo: BKT9 W534

Birth: 3-31-09
 Beckton Warrior CL M686
BECKTON WARRIOR C1 S337
 Ref. W Beckton Christy K101 CD
 Beckton Warrior C C355
 Beckton Christy J223 LN
 Beckton Cody V E023
 Beckton Christy C306 JL
 Beckton Nebula P P707
BKT LARKEISA S055 NB
 Beckton Larkeisa P688 CH
 Beckton Nebula M045
 Beckton Lana M809 EP
 Beckton Champ R3 H338
 BKT Larkeisa J564 HR

DAM		Calv.Ease	BW	WW	YW	Milk	HPG	Stay	Maint.En.
Age	3	15	-5.7	50	78	14	12	14	-3.8
Wt	880	(.30)	(.56)	(.49)	(.50)	(.25)	(.15)	(.06)	(.59)
Wean Pct.	61%	Marb	+.74 (.23)		REA	+.14 (.20)		Bfat	+.08 (.34)
Cow Eff.	129	BWt	WWt	WR	ADG	YWt	YR	Scr.	Fr.
		56	580	103	4	1053	102	35	4.5

★★★★★ for Low Maintenance, Marbling, Rib-eye area, High Cow Efficiency, Calving Ease, Stayability.

Friends and Family

who help us in many ways over the course of the year



Dave Nelson



*Spike, Jo, and Keenan Forbes (back)
Jeff, Katie, Julia, Ellen, and Sarah Durkin (front)*



*Julia Forbes and Ed Waddington
(with Tazmin and Flinder)*



Sal Forbes and Elfie Forbes



Doug Foster and Sarah Forbes



*Don Bingham, Alison Brody,
and Kate Bingham*



Kate's best friend, Boofy the Cow



*Mary Ellen McWilliams
and Joy Miller*



Elfie Forbes and Ruth Sylvester

RAAA Herd EPD Tables

Proven and Genetic Opportunity Sires (2014)

	CED	BW	WW	YW	Milk	TM	ME	HPG	CEM	ST	MARB	YG	CW	REA	FAT
Min.	-12	-13.8	-23	-42	-12	-3	-33	-4	-15	0	-.26	-.32	-62	-.82	-.08
Avg.	5	-1.6	55	86	18	45	1	10	5	10	.45	.01	19	.12	.00
Max.	23	6.4	101	158	40	74	25	23	23	22	1.83	.43	70	1.07	.12
1%	17	-8.0	90	142	35	65	-15	18	15	17	1.02	-.26	58	.74	-.06
2%	16	-7.2	86	136	33	63	-13	17	14	16	.95	-.23	53	.67	-.05
3%	15	-6.7	83	131	32	61	-12	16	13	16	.91	-.21	50	.62	-.05
4%	14	-6.4	81	128	31	60	-11	16	13	15	.88	-.19	48	.59	-.04
5%	14	-6.1	80	126	30	59	-11	15	12	15	.85	-.18	46	.56	-.04
10%	12	-5.1	74	117	27	56	-8	14	11	14	.76	-.14	40	.46	-.03
15%	10	-4.4	40	111	26	54	-6	13	10	13	.70	-.11	36	.40	-.02
20%	9	-3.9	68	106	24	52	-5	13	9	13	.66	-.09	33	.35	-.02
25%	9	-3.4	65	102	23	51	-4	12	8	12	.61	-.07	30	.30	-.02
30%	8	-3.0	63	99	22	50	-3	12	7	12	.58	-.05	28	.26	-.01
35%	7	-2.7	61	95	21	48	-2	11	7	11	.54	-.04	25	.23	-.01
40%	6	-2.3	59	92	20	47	-1	11	6	11	.51	-.02	23	.19	.00
45%	6	-1.9	57	89	19	46	0	10	6	10	.48	-.01	21	.16	.00
50%	5	-1.7	55	86	18	45	1	10	5	10	.45	.01	19	.12	.00
55%	4	-1.3	53	83	17	44	2	10	4	10	.42	.02	17	.09	.01
60%	4	-0.9	51	80	16	43	3	9	4	9	.39	.03	15	.06	.01
65%	3	-0.5	49	77	15	42	4	9	3	9	.36	.05	13	.02	.01
70%	2	-0.2	47	73	14	40	5	8	3	8	.32	.07	10	-.01	.02
75%	1	0.2	45	70	13	39	6	8	2	8	.29	.08	8	-.05	.02
80%	1	0.7	42	66	12	38	7	7	1	7	.24	.10	5	-.10	.03
85%	0	1.2	40	61	10	36	8	7	0	7	.20	.12	2	-.15	.03
90%	-2	1.9	36	55	9	34	10	6	-1	6	.14	.15	-2	-.21	.04
95%	-4	2.9	30	46	6	31	13	5	-2	5	.05	.19	-8	-.31	.05

Active Cows (2014)

	CED	BW	WW	YW	Milk	TM	ME	HPG	CEM	ST	MARB	YG	CW	REA	FAT
Min.	-12	-12.8	1	-1	-8	18	-31	-3	-13	0	-.46	-.70	-55	-.78	-.12
Avg.	4	-1.3	55	85	19	46	2	10	5	10	.40	-.01	16	.07	.00
Max.	19	11.5	107	164	40	75	32	21	19	20	1.64	.48	84	1.34	.14
1%	13	-8.0	90	142	35	65	-12	15	13	17	.83	-.22	47	.53	-.05
2%	12	-7.2	86	136	33	63	-10	15	12	16	.78	-.20	43	.48	-.05
3%	12	-6.7	83	131	32	61	-9	14	12	15	.75	-.18	41	.45	-.04
4%	11	-6.4	81	128	31	60	-8	14	11	15	.72	-.17	39	.42	-.04
5%	11	-6.1	80	126	30	59	-8	14	11	15	.70	-.16	38	.40	-.04
10%	9	-5.1	74	117	27	56	-6	13	9	14	.64	-.13	33	.33	-.03
15%	8	-4.4	70	111	26	54	-4	12	9	13	.59	-.10	30	.28	.03
20%	7	-3.9	68	106	24	52	-3	12	8	12	.56	-.08	27	.24	-.02
25%	7	-3.4	65	102	23	51	-2	12	7	12	.53	-.07	25	.21	-.02
30%	6	-3.0	63	99	22	50	-1	11	7	11	.50	-.06	23	.18	-.01
35%	6	-2.7	61	95	21	48	0	11	6	11	.47	-.04	21	.15	-.01
40%	5	-2.3	59	92	20	47	1	11	6	11	.45	-.03	19	.12	-.01
45%	5	-1.9	57	89	19	46	1	10	5	10	.42	-.02	18	.10	-.01
50%	4	-1.6	55	86	18	45	2	10	5	10	.40	-.01	16	.07	.00
55%	3	-1.3	53	83	17	44	3	10	5	10	.38	.01	14	.05	.00
60%	3	-0.9	51	80	16	43	3	9	4	9	.35	.02	13	.02	.00
65%	2	-0.5	49	77	15	42	4	9	4	9	.33	.03	11	.00	.01
70%	2	-0.2	47	73	14	40	5	9	3	9	.30	.04	9	-.03	.01
75%	1	0.2	45	70	13	39	6	8	3	8	.28	.06	7	-.06	.01
80%	1	0.7	42	66	12	38	7	8	2	8	.25	.07	5	-.10	.02
85%	0	1.2	40	61	10	36	8	8	1	7	.21	.09	2	-.13	.02
90%	-1	1.9	36	55	9	34	10	7	1	6	.16	.11	-1	-.18	.02
95%	-3	2.9	30	48	6	31	12	6	-1	5	.10	.15	-6	-.25	.03

Non-Parents (2014)

	CED	BW	WW	YW	Milk	TM	ME	HPG	CEM	ST	MARB	YG	CW	REA	FAT
Min.	-12	-11.2	-1	-6	-5	21	-22	0	-10	2	-.51	-.52	-46	-.58	-.10
Avg.	4	-1.0	56	83	20	48	1	10	5	11	.43	-.01	19	.15	.00
Max.	22	10.0	107	177	38	73	20	20	17	21	1.68	.47	80	1.21	.16
1%	13	-5.9	80	124	30	62	-11	15	11	17	.90	-.25	47	.61	-.06
2%	12	-5.3	78	119	29	60	-10	14	11	17	.84	-.22	44	.55	-.05
3%	11	-5.0	76	116	28	59	-9	14	10	16	.81	-.20	42	.52	-.05
4%	11	-4.7	74	114	28	59	-8	14	10	16	.78	-.19	40	.49	-.04
5%	10	-4.5	73	112	27	58	-8	13	10	16	.76	-.18	39	.47	-.04
10%	9	-3.7	69	106	26	56	-6	13	9	15	.69	-.14	35	.40	-.03
15%	8	-3.2	67	101	25	54	-5	12	8	14	.64	-.12	32	.35	-.03
20%	7	-2.8	65	98	24	53	-4	12	7	13	.60	-.10	29	.31	-.02
25%	7	-2.4	63	95	23	52	-3	11	7	13	.57	-.08	27	.28	-.02
30%	6	-2.1	61	92	22	51	-2	11	6	12	.53	-.06	25	.25	-.01
35%	6	-1.8	60	90	22	50	-1	11	6	12	.51	-.05	24	.22	-.01
40%	5	-1.5	59	87	21	50	0	11	6	12	.48	-.04	22	.20	-.01
45%	4	-1.3	57	85	21	49	0	10	5	11	.45	-.02	21	.17	.00
50%	4	-1.0	56	83	20	48	1	10	5	11	.43	-.01	19	.15	.00
55%	4	-0.7	55	81	19	47	2	10	5	11	.40	.00	17	.12	.00
60%	3	-0.5	53	79	19	46	2	9	4	10	.38	.02	16	.10	.01
65%	2	-0.2	52	76	18	46	3	9	4	10	.35	.03	14	.07	.01
70%	2	0.1	51	74	18	45	4	9	4	10	.32	.04	13	.05	.01
75%	1	0.4	49	71	17	44	5	9	3	9	.29	.06	11	.02	.02
80%	1	0.8	47	68	16	43	6	8	3	9	.26	.08	9	-.02	.02
85%	0	1.2	45	65	15	42	7	8	2	8	.22	.10	6	-.05	.02
90%	-1	1.7	43	60	14	40	8	7	1	7	.17	.12	3	-.10	.03
95%	-2	2.5	39	54	13	38	10	7	0	6	.10	.16	-1	-.17	.04

EPD Accuracies and Possible Change

EPDs are predictions, not true values, and we can therefore expect that EPDs will change from sire evaluation, as more information (i.e. progeny data) is included. A possible change value is an estimate of the amount of change (in trait units) that can be expected for a given EPD.

Technically, there is a 68% chance that the real genetic value (an EPD with a accuracy of 1.0) for any trait lies between its EPD plus its possible change value and its EPD minus its possible change value. For example, if a sire has a weaning EPD of +25 lb. and a possible change value of 10 lb., we can expect the true genetic value to be between +15 lb. (25 - 10) and +35 lb. (25 + 10) 68% of the time. We should not be surprised if his EPD in next year's evaluation is as high as +35 or as low as +15. If next year's EPD should happen to be slightly outside of this

range, keep in mind there is nearly a one-in-three chance of that happening; however, significantly larger deviations can occur.

Possible change is simply another way of expressing accuracy of an EPD. High accuracy sires will have small possible changes and vice versa. Many breeders feel that possible change values complement accuracies and help them determine just how thoroughly an animal has been evaluated. The accuracy/possible change chart lists possible changes in EPDs that can be expected with different levels of accuracy for the various traits.

For more information on possible change values, please see the article by Dr. Bob Hough titled "Understanding EPD Accuracies and Possible Change". This article can be downloaded from the Red Angus Association of America website at www.redangus.org.

Accuracy	CED	BW	WW	YW	MILK	ME	HPG	CEM	ST	MARB	YG	CW	REA	FAT
0.0	9	3.0	16	26	12	3	11	9	7	.26	.20	19	.43	.04
0.1	8	2.7	15	23	11	2	10	8	6	.23	.18	17	.39	.04
0.2	7	2.4	13	21	10	2	9	7	5	.21	.16	15	.34	.03
0.3	6	2.1	11	18	8	2	8	6	5	.18	.14	14	.30	.03
0.4	5	1.8	10	15	7	2	7	5	4	.16	.12	12	.26	.02
0.5	4	1.5	8	13	6	1	6	4	3	.13	.10	10	.22	.02
0.6	3	1.2	7	10	5	1	4	4	3	.10	.08	8	.17	.02
0.7	3	0.9	5	8	4	1	3	3	2	.08	.06	6	.13	.01
0.8	2	0.6	3	5	2	1	2	2	1	.05	.04	4	.09	.01
0.9	1	0.3	2	3	1	0	1	1	1	.03	.02	2	.04	.00
1.0	0	0.0	0	0	0	0	0	0	0	.00	.00	0	.00	.00

Sire Bloodline Charts

Name Family

- Accent A
- Action A
- Champ H
- Clifftop C
- Clipper A
- Cobalt A
- Cody A
- Colt A
- Copper C
- Dominor D
- Emcee E
- Emperor E
- Epic E
- Exeter E
- Hasten H
- Herald H
- Heritage H
- Hustler H
- Javelin L
- Jet J
- Jules J
- Julian J
- Julio J
- Juniper J
- Juno J
- Jupiter J
- Justice J
- Lancer L
- Lariat L
- Legend L
- Likable L
- Loki L
- Nebula N
- Neptune N
- Neva V
- New Era N
- Nomad V
- Ranger R
- Roman O
- Scamp S
- Varo R
- Vega V
- Vegas V
- Warhawk W
- Warrior W

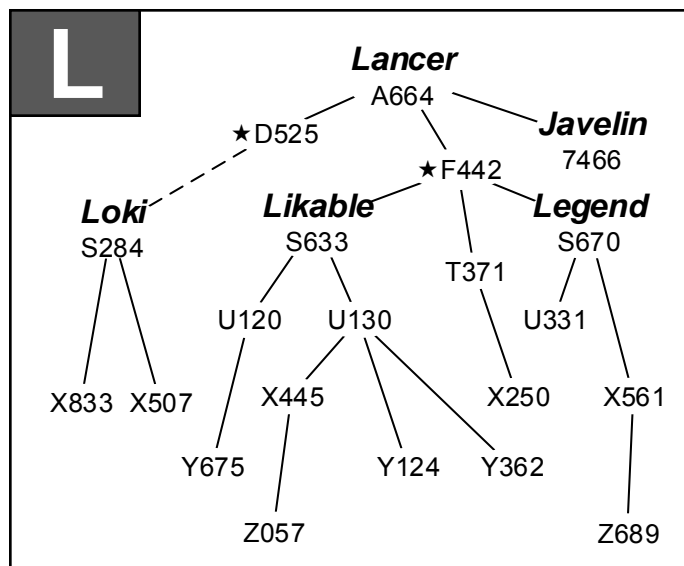
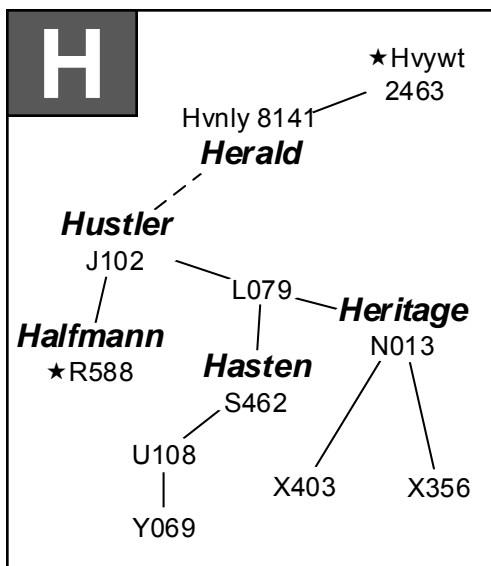
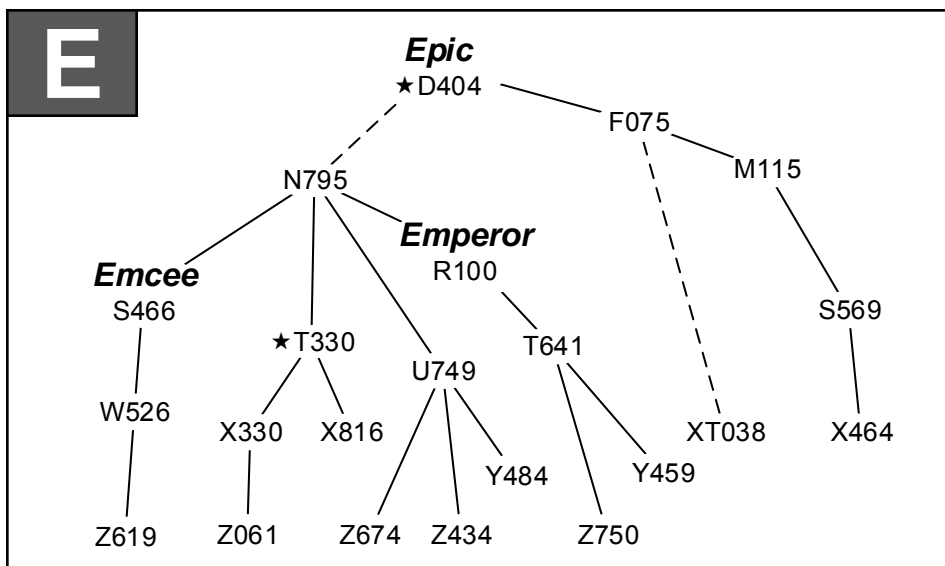
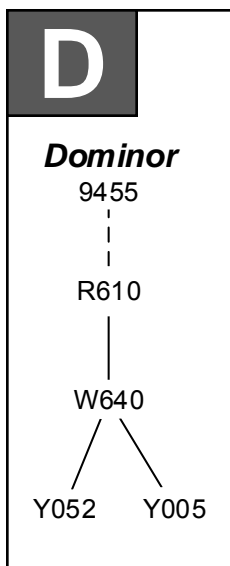
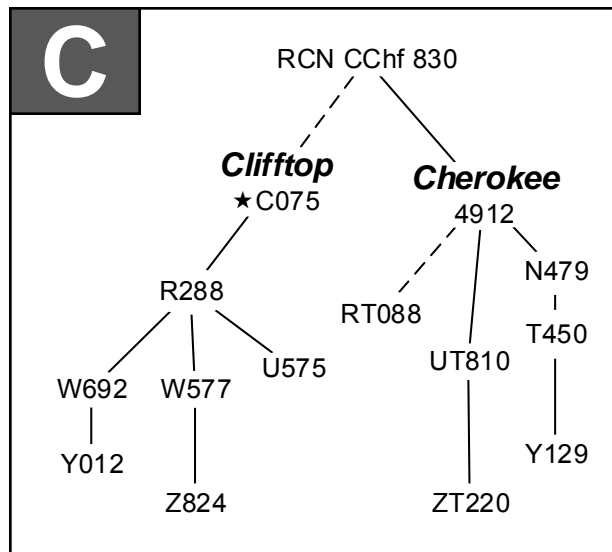
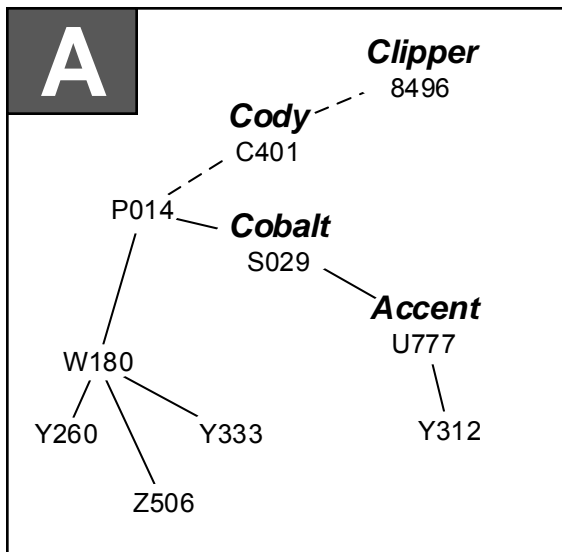

★ Red Angus Trait Leader

J

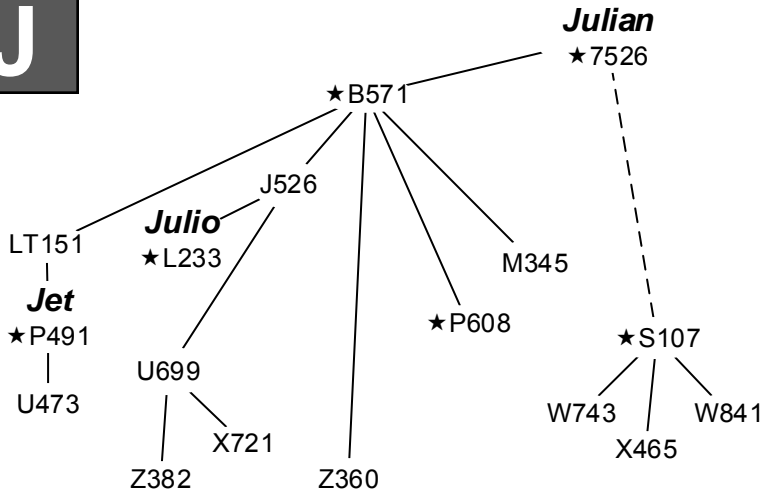

O

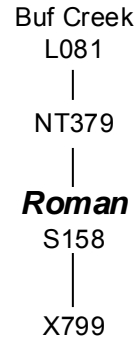

Name	Tag	Family
Javelin	7466	L
Nomad	9A14	V
Scamp	A825	S
Julian	B571	J-1
Nebula	M045	N
Warhawk	N560	W
Nebula	P084	N
Julian	P608	J
Nebula	P707	N-1
Nebula	R233	N
Julian	S107	J
Nebula	S237	N
Legend	S670	L
Nebula	T269	N-2
Epic	T330	E
Lancer	T371	L-3
Nebula	T398	N
Ranger	T603	R-2
Emperor	T641	E-3
Nebula	U060	N
Likable	U120	L
Nebula	U206	N-3
Legend	U331	L
Epic	U749	E-4
Accent	U777	A-1
Accent	W180	A-2
Nebula	W486	N
Emcee	W526	E-5
Warrior	W534	W-3
Dominor	W640	D-1
Clifftop	W692	C-2
Julian	W743	J-4
Nebula	W778	N
Nebula	X096	N-8
Nebula	X267	N-9
Epic	X330	E-6
Heritage	X356	H-1
Heritage	X403	H
Scamp	X458	S-1
Epic	X464	E-7
Julian	X465	J-5
Scamp	X494	S-2
Nebula	X603	N-11
Julian	X721	J-6
Janus	X799	O-1
Epic	X816	E-8
Loki	X833	L-8
Nebula	Y002	N
Dominor	Y005	D
Clifftop	Y012	C
Nebula	Y036	N
Dominor	Y052	D
Hasten	Y069	H
Warrior	Y108	W
Likable	Y124	L
Cherokee	Y129	C
New Era	Y194	N
Accent	Y260	A
Accent	Y312	A
Likable	Y362	L
Emperor	Y459	E
Epic	Y484	E
Likable	Y675	L

N

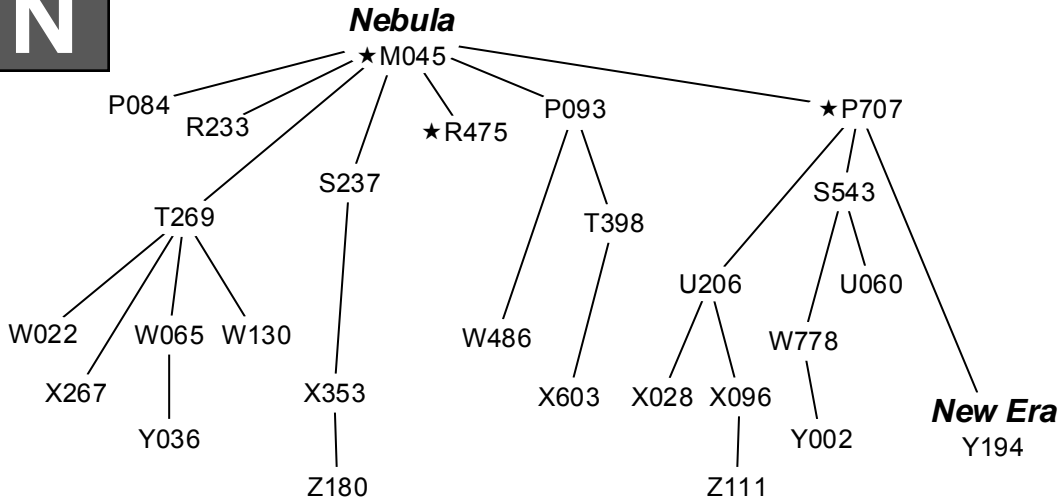

R

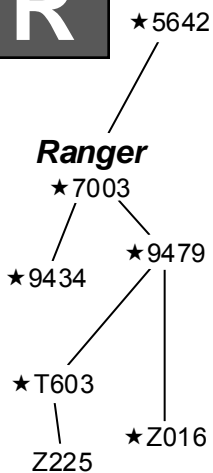

S



V

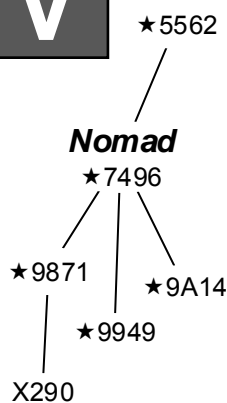

W

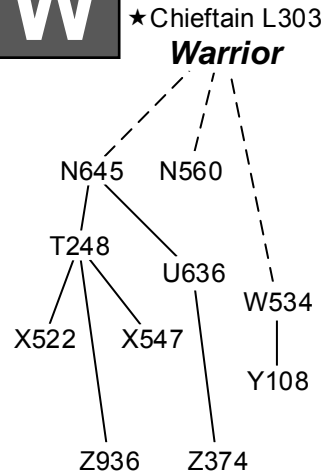

Sale Terms and Conditions

Except for those stated in the terms and conditions below, there are no warranties, either expressed or implied, as to the merchantability or fitness for a particular purpose with respect to the cattle being sold at this auction. The warranties and guarantees set forth in the "Terms and Conditions" are in lieu of all other warranties, either expressed or implied, and the remedies provided therein shall be the sole and exclusive remedy for the Buyer, or any party claiming through Buyer, for any breach of warranty or guarantee therein provided, and all other obligations or liabilities.

The information in the catalog is believed to be accurate, and the information seller believes to be most representative. It is the nature of seller's business that the seller engages in a continual process of collecting new data and information. Therefore, any information presented at the time of sale is always subject to revision, correction or update.

I. BIDDING

The Auctioneer in charge will settle any disputes as to bids, and his decision on such matters shall be final.

II. TERMS

Terms of sale are cash or personal check unless satisfactory credit arrangements have been made with vendor prior to sale.

III. PURCHASER'S RISK

Each animal becomes the risk of the purchaser as soon as sold, but it shall be the obligation of the Seller to see that animals are fed and cared for free of charge to purchaser, until loaded for shipment or until the expiration of 48 hours after the sale, whichever occurs sooner.

IV. DELIVERY

For any animals for which seller's arrange delivery, the following terms shall apply. Each animal becomes the risk of the purchaser as soon as sold, and through the time of delivery. The seller will arrange transportation and delivery schedules, and may combine animals from one or more purchasers for convenience and to reduce costs. If delivery is arranged, seller assumes no other liability. Once the purchaser has been notified of the date and approximate time of delivery (morning, afternoon, evening, etc.), it is the responsibility of the purchaser to arrange adequate and agreeable location and facilities for unloading each animal. When unloaded at the agreed upon location, all care and management of the animal is the responsibility of the purchaser.

V. CERTIFICATE OF REGISTRY

A transferred certificate of registry will be furnished to the purchaser for each animal for which a Registration number is listed.

VI. HEALTH

All animals are eligible for interstate shipment, except as otherwise announced. Interstate health papers will be furnished for each animal requiring T.B, Bang's, and trich tests in accordance with federal and state regulations.

VII. DIVISIBILITY

The percentage of ownership interest received by the buyer, whether it is 100% or 2/3 or otherwise as defined in the catalog or by the auctioneer, may not be subsequently divided without the express written consent of the seller.

VIII. ANNOUNCEMENTS

Any changes from information of any kind in this catalog will be announced from the auction box and such announcements shall take precedence.

IX. BREEDING GUARANTEE

Any female that has had a calf prior to the date of sale shall be considered a breeder without further guarantee. All females sold as 'bred' or 'pregnant' have been pregnancy checked by a licensed veterinarian and are guaranteed bred on the day of sale. The purchaser may elect to have any female so listed rechecked at their cost within 30 days of delivery by a licensed veterinarian of their choice. Any such female determined open by this recheck may be returned to the seller for a full

refund. Due to conditions out of seller's control, once a female leaves seller's possession, this is the only guarantee offered.

All bulls are sold as guaranteed breeders. Each bull has been officially fertility tested as "Satisfactory Breeder" prior to the sale. However, seller cannot guarantee against physical injury or illness following the sale. But if within 8 months following the sale, the buyer has evidence that the animal is not a breeder, the buyer may obtain a statement signed by a licensed veterinarian to that effect, such statement also indicating that there has been no injury or illness to the animal following the sale, and return the bull to the farm of the seller for adjustment. If the seller cannot then prove the animal to be a breeder, an adjustment will be made by the seller, either by substituting an animal of equal value, or by the refund of the full purchase price. Such adjustment shall be considered full settlement and satisfaction of all claims. No guarantees apply to animals which are shown following the sale.

X. GENETIC DEFECT AND PARENTAGE GUARANTEE

For complete rules and regulations in regard to genetic defects or parentage guarantee contact the RAAA. Ask for Section C Registration Requirements.

Osteopetrosis: The Red Angus Association along with animal scientists have developed a DNA marker test for osteopetrosis (OS), a genetic disorder which in rare instances can cause the loss of a calf at birth. Since the test was developed, Beckton has tested every sire being used in our breeding program. Only one sire, from outside our program, tested positive as a carrier of the gene. Every sire bred and raised at Beckton has tested 'Free'. All of our major semen sires have also been tested 'Free'. We guarantee every sale animal to be OS Free, and if you have a concern, we will have any sale animal tested on request. If an animal were to test positive, we would replace the animal or refund the purchase price. The testing we have done shows no incidence of occurrence in any Beckton bloodlines for the past 30 years, and so we believe there is no safer herd than ours.

XI. RETAINED INTEREST AND SEMEN RIGHTS:

Buyer receives full possession and salvage value of all bulls in the sale, unless stated otherwise in the catalog or during the auction. Buyer also has the sole privilege to determine if or when the bull is to have semen collected at any time in the future. Seller retains a 1/3 semen interest only on all sale bulls. On such bulls which are collected in the future, seller will have the privilege of receiving semen for in house use, sharing pro rata in the costs of collection of such semen. On such bulls from which semen is advertised or marketed commercially, seller is entitled to 1/3 royalty interest on gross semen sales, with buyer receiving 2/3 of gross sales. However, as stated any decision to collect or sell semen is solely the right of the buyer.

XII. RIGHTS AND OBLIGATIONS

A. The above terms and conditions of sale shall constitute a contract between the Buyer and Seller of each animal and shall be equally binding upon both. Each sale or resale of an animal constitutes a separate transaction.

B. Neither the sale manager, the owner, nor any other person connected with the management of the sale, assumes any liability, legal or otherwise.

Lot-Tag Cross Reference

ID	Lot	ID	Lot	ID	Lot	ID	Lot	ID	Lot	ID	Lot		
<i>Reference Sires</i>		<i>Bulls</i>		A184	.145	A353	.11	A526	.129	A685	.149	<i>Heifers</i>	
9A14	V-1	A004	.44	A185	.66	A354	.127	A527	.244	A688	.211	A030	.330
B571	J-1	A014	.247	A187	.120	A355	.84	A528	.153	A689	.160	A068	.303
M045	N-1	A018	.88	A192	.7	A357	.100	A529	.242	A695	.180	A071	.305
N560	W-1	A019	.208	A195	.164	A358	.114	A531	.79	A696	.187	A093	.301
P707	N-2	A025	.85	A203	.10	A362	.89	A533	.62	A697	.169	A095	.323
S107	J-2	A026	.222	A204	.212	A369	.83	A537	.113	A708	.245	A101	.327
S670	L-1	A031	.69	A205	.48	A372	.241	A538	.8	A709	.252	A106	.304
T269	N-3	A032	.220	A206	.123	A373	.40	A541	.214	A716	.188	A107	.329
T330	E-1	A033	.234	A212	.9	A374	.225	A542	.181	A717	.42	A136	.317
T371	L-2	A038	.151	A218	.177	A375	.82	A545	.171	A718	.92	A141	.322
T398	N-4	A039	.229	A226	.15	A376	.26	A549	.130	A719	.86	A143	.302
U120	L-3	A041	.136	A233	.54	A380	.43	A550	.38	A727	.58	A181	.315
U331	L-4	A044	.170	A237	.163	A388	.75	A551	.206	A731	.205	A235	.307
U749	E-2	A045	.14	A243	.52	A389	.218	A564	.87	A735	.240	A262	.333
U777	A-1	A052	.172	A247	.81	A391	.64	A567	.156	A736	.117	A311	.326
W180	A-2	A053	.61	A252	.70	A398	.36	A575	.107	A739	.97	A312	.310
W486	N-5	A060	.116	A253	.57	A409	.2	A577	.74	A752	.210	A346	.336
W534	W-2	A061	.183	A254	.37	A418	.109	A579	.219	A753	.204	A351	.314
W640	D-1	A063	.251	A260	.32	A419	.203	A580	.197	A754	.243	A359	.321
W692	C-1	A066	.147	A263	.159	A420	.115	A588	.60	A762	.51	A366	.316
W743	J-3	A067	.67	A266	.126	A421	.253	A592	.73	A777	.191	A367	.309
W778	N-6	A072	.24	A267	.233	A423	.71	A594	.90	A778	.238	A392	.340
X330	E-3	A073	.106	A268	.65	A424	.103	A596	.30	A779	.236	A399	.325
X356	H-1	A075	.56	A274	.41	A429	.29	A599	.173	A782	.96	A440	.311
X465	J-4	A076	.162	A275	.200	A431	.118	A602	.124	A786	.135	A447	.331
X494	S-1	A080	.144	A276	.190	A434	.1	A606	.143	A788	.226	A450	.338
X799	O-1	A084	.101	A279	.202	A436	.80	A608	.207	A792	.59	A474	.332
Y002	N-7	A086	.213	A281	.21	A445	.133	A609	.235	A797	.196	A493	.313
Y005	D-2	A088	.27	A282	.248	A454	.91	A611	.193	A799	.134	A495	.319
Y012	C-2	A089	.46	A290	.72	A458	.158	A614	.185	A801	.186	A503	.334
Y036	N-8	A098	.3	A292	.53	A460	.182	A617	.223	A805	.152	A552	.335
Y052	D-3	A100	.94	A293	.5	A461	.108	A620	.215	A810	.93	A647	.320
Y069	H-2	A103	.78	A296	.121	A463	.217	A621	.198	A815	.166	A658	.312
Y108	W-3	A113	.50	A299	.184	A464	.49	A622	.19	A817	.63	A721	.337
Y124	L-5	A114	.76	A303	.232	A465	.45	A628	.141	A820	.122	A725	.308
Y129	C-3	A115	.55	A308	.224	A466	.17	A634	.227	A821	.104	A755	.324
Y194	N-9	A118	.35	A310	.28	A476	.146	A639	.179	A832	.137	A791	.306
Y260	A-3	A122	.77	A314	.192	A478	.216	A640	.230	A847	.157	A794	.339
Y312	A-4	A125	.98	A315	.138	A481	.174	A643	.201	A853	.140	A803	.318
Y362	L-6	A127	.13	A325	.221	A482	.99	A648	.194	A865	.239	A825	.328
Y459	E-4	A132	.39	A327	.139	A483	.34	A649	.23	A870	.132		
Y484	E-5	A134	.18	A328	.161	A486	.111	A652	.209	A883	.199		
Y675	L-7	A135	.33	A332	.131	A500	.142	A657	.231	A896	.175		
		A146	.165	A333	.119	A502	.154	A659	.102	A905	.47		
		A152	.20	A334	.228	A504	.155	A663	.95	A931	.178		
		A159	.12	A335	.31	A505	.237	A665	.167				
		A164	.189	A340	.110	A506	.112	A674	.68				
		A170	.105	A344	.4	A508	.22	A677	.168				
		A173	.176	A345	.246	A510	.249	A678	.6				
		A178	.150	A349	.148	A512	.250	A679	.195				
		A180	.16	A352	.125	A516	.128	A682	.25				

Notes



Semen Available

Bull Name	Calv. Ease	BW	WW	YW	Milk	HPG	Stay	ME	Marb	REA	Bfat	Price
	Acc.	Acc.	Acc.	Acc.	Acc.	Acc.	Acc.	Acc.	Acc.	Acc.	Acc.	
Beckton Lancer T A664	15	-3.0	28	59	6	-1	14	7	.25	.01	-.01	\$20
Reg. 358389	.89	.92	.90	.90	.89	.80	.77	.62	.74	.72	.60	
Beckton Cody KH M390	13	-4.5	26	57	13	9	12	-4	.01	-.07	.02	\$20
Reg. 854892	.47	.76	.67	.62	.45	.01	.01	.34	.44	.41	.27	
Beckton Cherokee N N479	14	-5.6	31	50	25	11	13	-5	.08	.27	.02	\$20
Reg. 916601	.63	.76	.72	.70	.63	.36	.30	.42	.50	.47	.32	
Beckton Warrior N645 T1	5	-0.2	40	78	8	9	10	-1	-.01	.01	.01	\$20
Reg. 916767	.31	.66	.54	.45	.27	.15	.01	.16	.36	.34	.23	
Beckton Epic K4 N795	8	-0.5	38	90	18	-8	10	6	.51	.05	.09	\$20
Reg. 916917	.77	.82	.80	.81	.75	.64	.29	.57	.67	.66	.72	
Beckton Nebula L P093	11	-3.8	61	93	4	10	14	2	.49	.11	.01	\$20
Reg. 978419	.79	.84	.82	.82	.77	.57	.21	.67	.45	.41	.48	
Beckton Jet L P491	19	-8.1	14	34	19	11	15	2	.19	.15	.00	\$20
Reg. 978816	.57	.76	.69	.67	.58	.10	.25	.43	.44	.40	.24	
Beckton Epic R350 K	11	-3.7	25	54	17	11	11	1	.14	.09	.01	\$20
Reg. 1042088	.23	.26	.25	.25	.25	.19	.17	.18	.01	.01	.01	
Beckton Nebula PJ S543	16	-6.4	64	100	20	-1	13	4	.56	-.02	.01	\$20
Reg. 1119006	.60	.74	.70	.71	.56	.37	.01	.65	.30	.26	.39	
Beckton Justice T124 C1	14	-3.7	31	67	13	10	12	-6	.17	.16	.00	\$20
Reg. 1178635	.13	.34	.24	.24	.14	.01	.01	.01	.25	.24	.20	
Beckton Juniper T826	10	0.4	35	70	9	10	16	-4	.03	.21	.00	\$20
Reg. 1179117	.17	.34	.21	.27	.19	.01	.01	.10	.01	.01	.01	

Special – Semen Packages on Rare Sires

BECKTON JULIAN B571 and BECKTON NEBULA P707

BECKTON JULIAN GG B571

1-A 100% # 387580 Tattoo: WF2 B571

Birth: 3-27-92

Beckton Julian 6592
 Beckton Trojan 5253
 Lchmn Christy 2339
BECKTON JULIAN 7526G
 Ref. J
 Bkt Belga 6746 GS
 Beckton Gisa 4454
 Beckton Lalaxigu -2
 Beckton Julian 7526G
 Beckton Julian 6592
 Bkt Belga 6746 GS
BKT MARTA 9A13 JL
 Beckton Xime 4736
 Bkt Marta 6498 XM
 Beckton Marwa -K



Calv.Ease	BW	WW	YW	Milk	HPG	Stay	Maint.En.
24	-6.2	28	55	15	13	21	-6.2
(.92)	(.93)	(.92)	(.92)	(.91)	(.88)	(.82)	(.64)
Marb +.20 (.89)		REA +.30 (.89)		Bfat +.02 (.90)			
BWt	WWt	WR	ADG	YWt	YR	Scr.	Fr.
65	627	113	3	1140	112	NA	5.0

DAM	
Age	3
Wt	1015
Wean Pct.	56%
Cow Eff.	118

★★★★★ for Low Maintenance, Marbling, Rib-eye area, High Cow Efficiency, Calving Ease, Stayability.

Beckton Julian B571 and **Beckton Nebula P707** have been premier sires of the breed over the past decade. We are offering semen packages of 10 straws each for these two sires – one package for B571 and five packages for P707 – as follows:

The purchaser of any bull in this sale has the option to exchange the bull bought in the ring, for the same price, for the buyer's choice of one of these packages. The buyer must notify the auctioneer before the next bull is sold that the buyer wants to take a semen package option, and on which sire. The auctioneer will then re-auction the bull in the ring.

BECKTON NEBULA P P707

1-A 100% # 979031 Tattoo: BKT4 P707

Birth: 4-1-04

Beckton Neptune R2 K065
 Beckton Neptune RR B284
 Beckton Lana C735 TP
BECKTON NEBULA M045
 Ref. N-1
 Beckton Belga K285 JL
 Beckton Julian GG B571
 Beckton Belga G493 HR
 Beckton Epic K1 K863
 Beckton Epic KN H110
BECKTON LANA M809 EP
 Beckton Rose H019 SC
 Beckton Dominor ZJ H657
 Beckton Lana HA34 DM



Calv.Ease	BW	WW	YW	Milk	HPG	Stay	Maint.En.
17	-6.4	60	108	20	10	14	-4.4
(.81)	(.87)	(.85)	(.86)	(.80)	(.54)	(.47)	(.67)
Marb +.94 (.57)		REA -.25 (.53)		Bfat +.04 (.55)			
BWt	WWt	WR	ADG	YWt	YR	Scr.	Fr.
68	728	127	4	1265	122	37	5.0

DAM	
Age	2
Wt	890
Wean Pct.	71%
Cow Eff.	150

★★★★★ for Low Maintenance, Growth, Marbling, High Cow Efficiency, Calving Ease, Stayability.

Beckton Stock Farm

Cam Forbes

37 Beckton Drive

Sheridan, WY 82801

Tel.: 307.674.6095, 674.8162 (evening)

Fax: 307.672.7281

Email: becktonwyo@gmail.com

Web: www.BecktonRedAngus.com

FIRST CLASS

#1 HERD IN THE BREED FOR STAYABILITY, LOW MAINTENANCE and CALVING EASE

Of 1574 total sires on the 2014 RAAA Sire Summary, 74 of the highest 100 sires for STAYABILITY EPD are either Beckton sires or descended from Beckton sires. As are 15 of the highest 20.

THESE ARE THE CATTLE THAT STAY IN YOUR HERD.



Plus 69 years of selection for functionality – good dispositions, high cowherd fertility, good udders and milk. Our cattle rotate between Wyoming range and high elevations in the Bighorn Mountains, so they offer excellent altitude adaptation, strong feet and legs, and overall structural soundness.

Free Delivery
anywhere in the Continental US