

# 71st Anniversary Production Sale

Tuesday April 12th, 2016

Industry Leader for  
Low Maintenance, Maternal Traits



**1** **Beckton**  
**Red Angus**

*Foundation Herd of the Red Angus Breed*

71  
YEARS



# 1 Beckton Red Angus

37 Beckton Drive • Sheridan, WY 82801 • [becktonwyo@gmail.com](mailto:becktonwyo@gmail.com)  
Office: 307.674.6095 • Evenings: 674.8162 • Fax: 672.7281

Dear Friends and Cattlemen,

On behalf of everyone here at Beckton, we welcome you to join us for our 71st Anniversary Production Sale. The Red Angus breed is becoming the breed of choice for commercial beef producers, and we believe Beckton has the right kind of Red Angus cattle for profitability into the future.

The Red Angus Association's Herd Builder Index is now being used across the breed as a statistical predictor of profitability. This Index takes the multiple traits of economic importance – fertility, calving ease, low maintenance, stayability, growth, carcass traits, etc. – which we now measure with individual EPD's, and weights each trait according to its relative economic importance. Every animal receives an Index number, which is a straightforward measure of dollar profitability for each mating of that animal.

To explain this simply with actual numbers, the average Herd Builder Index for all animals in the Red Angus breed under 2 years of age is 104. The average Index for Beckton's 251 yearling bulls in this sale is just over 150. The difference between these Index numbers (150-104) equals 46, so statistically the Index predicts that the average Beckton bull in this sale mated to random females will generate just over \$46 more profit per mating. Mated to 150 females over his service lifetime, the average Beckton bull in this sale should produce about \$7,000 more profit than the average bull in the breed.

The traits now being measured breed-wide by the Herd Builder Index are the same traits for which Beckton has been selecting over the past seven decades. Beckton's herd sires rank at the top of the breed, and this carries forward in our new young bulls. You will see looking through the sale bulls that most rank in the top breed percentiles. (The sale bull average of 150 is in the top 7 % of the breed.) And this advantage continues as you retain replacement heifers from these bulls and use these genetics to build your cowherd into the future.

When you see them we think you will agree this is an outstanding offering of young bulls. The heifers are likewise really nice – selected from the top end of our heifer replacements. They are feminine and functional and ready to breed. We offer two straws of semen with each heifer from any of our herd sires for which we have an adequate quantity, including Nebula P707.

Again we welcome you to join us for our 71th Anniversary Sale, with a dinner served at the Holiday Inn immediately after. We have a new air service, Key Lime Air, with really nice jet aircraft and two daily flights to and from Denver. See the contact info on page 2 or on the last page.

Lastly, if you are unable to attend, this year we are offering bidding through Superior Productions on the internet (see the last page of this catalog). We will continue to offer our Conference call for bidding, or you may call me in the days ahead of the sale to visit about the bulls and place a Sight-Unseen order. Over a quarter of our bulls sell sight unseen, mostly to long-time customers.

We put a lot of work into selecting the bulls and heifers for the sale, and as always, your satisfaction with every animal is guaranteed. We look forward to seeing you on Tuesday the 12th.

Sincerely,

*Cam Forbes*



*Cam and Trish Forbes*

**Beckton Red Angus • Since 1945**  
**The Foundation Herd of the Red Angus Breed**

# Sale Information

## Beckton Ranch

9½ miles West of Sheridan

Phone: 307.674.6095

**Tuesday, April 12th, 2016**

1 o'clock pm (Lunch at noon)

## 251 Bulls • 31 Heifers

Selling in catalog order, heifers sell following the bulls

Please join us for a complimentary dinner after the sale at the Holiday Inn.



## Some Facts about the Beckton Herd

**HERD BUILDER INDEX:** The new HERDBUILDER INDEX developed by the RAAA, and now used throughout the breed (see pages 8-9), weights EPD's according to their effect on overall herd profitability. **42 of the 50 highest ranking sires in the Red Angus breed for profitability are Beckton sires or descended from Beckton sires.**

The 251 Beckton sale bulls inside this catalog have an average Herd Builder Index of 150, which is in the top 7% of the entire breed. Statistically the Beckton bulls will produce \$46 more profit per mating compared to other Red Angus bulls. **Mated to 150 randomly selected females over his service lifetime, the average Beckton bull in this sale should produce about \$7,000 more profit from your cow herd. And the dividend continues as replacement females are retained into the future.**

► **HERD STAYABILITY:** Beckton is the #1 Herd in the breed for Stayability, and has been for many years. **44 of the top 50 sires in the breed for Stayability EPD are Beckton sires or descended from Beckton sires**, including 17 of the top 20. These are the bulls and heifers that will produce, breed back, and stay in your herd for many years.

► **LOW MAINTENANCE ENERGY:** Beckton has also been the #1 Herd for Low Maintenance Energy requirements for many years. 5 of the top 10 sires in the entire breed for lowest Maintenance Energy EPD are Beckton sires. **No other set of bulls will do a better job cutting your cowherd feed requirements.**

► **EASY CALVING:** The #1 Herd in the breed for easy calving, with the best average Calving Ease EPD of any major herd. 6 of the top 10 sires in the breed for low Birth Weight EPD are Beckton sires. **The average Calving Ease EPD of all 251 sale bulls is +13, which is the top 2 % of the Red Angus breed.**

► **GROWTH RATE from Birth to Market:** No other set of sale bulls offer this volume of bulls which combine low birth weight and easy calving, with high growth rate to market weight, together with fertility and stayability. **And no other set of sale bulls will combine all of these traits and rank so high on overall herd profitability measured by the Herd Builder Index.**

## Sale Details

### Internet Bidding via Superior Productions

Internet bidding and phone bidding are now available with Superior Productions. See more information on page 2 and complete details on the last page of the catalog.

### Conference Call Buying

For those who cannot attend the sale and would like to listen and bid over the phone, two Conference call lines will be available. Call the ranch number above well ahead of the sale and we will register you for the conference call and give you call-in instructions and a buyer number.

### Site-Unseen Purchase

If you are unable to attend the sale, we can help you select the bulls or females to fit your needs. Give us a phone call, letter, fax or e-mail (please refer to the back cover), and we can make arrangements to handle bidding according to your directions. Bulls are bought at the lowest price, and satisfaction is guar-

anteed on bulls purchased sight unseen. Many of our repeat customers buy their bulls this way. To provide us adequate time to assist you, please contact us before noon of the day prior to the sale.

### Free Delivery

We provide free delivery for all bulls throughout the continental U.S. If you bring a trailer to haul your own, \$200 will be deducted from the price of each bull. Heifers will be delivered free within 400 miles, and at cost for additional miles. Most of the sale cattle will be delivered from 1 to 3 weeks after the sale, although we will try to accommodate if you need your bulls right away. Although there occasionally are limitations, in most cases we can deliver the cattle directly to your ranch.

### Payments

Payments can be made with cash, check payable to Beckton Stock Farm, Inc. or Visa/Mastercard on sale day.

**Accommodations**

**Holiday Inn**

307.672.8931, I-90, Exit 25  
Ask for special Beckton Sale rate of \$71

**Best Western Sheridan Center**

307.674.7421, 612 N. Main Street

**Days Inn**

307.672.2888, 1104 Brundage Lane

**Super 8 Motel**

307.672.9725, 2435 N. Main Street

**Transportation**

**Avis Car Rental**

307.672.2226, Sheridan Airport

**Key Lime Air**

Two flights to/from Denver each weekday  
www.flysheridan.com  
866.373.8513



**Auctioneer Roger Jacobs**  
406.698.7686



**Curt Cox**  
Wyoming Livestock  
Roundup  
307.630.4604



**Pete Crow**  
Western Livestock  
Journal  
303.722.7600



**Bob Hough**  
817.296.0976



**Dennis Ginkens**  
Western Ag  
Reporter  
406.670.9839



**Alan Sears**  
Western Livestock  
Reporter  
970.454.3986



**Del Tinsley**  
Wyoming Livestock  
Roundup  
307.234.2700

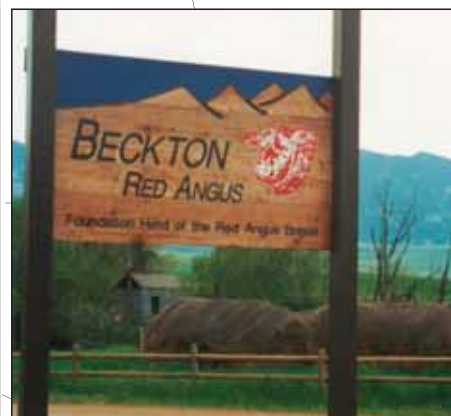

**1 Beckton Red Angus**  
Foundation Herd of the Red Angus Breed

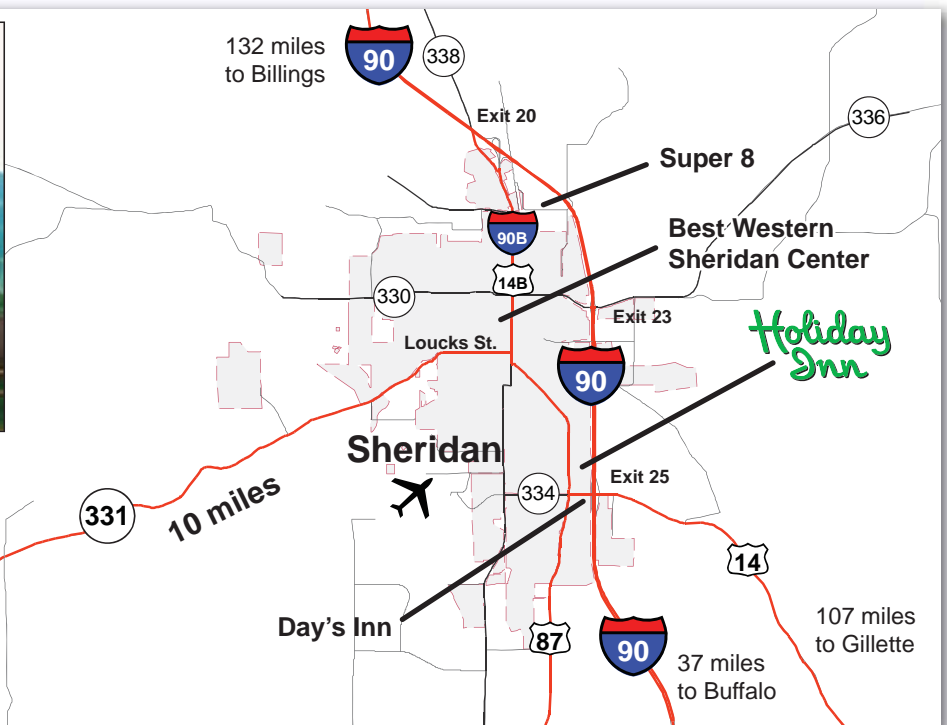

**Serving our customers for 71 years with industry leading genetics and the highest quality cattle.**





## Additional Sale Information

- ▶ The animals sell in catalog order. We will have a conference call available for telephone bidding. You must register in advance, and conference number and instructions will be available then.
- ▶ All bulls have passed a rigorous fertility exam that included live semen evaluation, scrotal measurements, and reproductive tract examinations.
- ▶ Beckton has a comprehensive herd-wide health program which includes vaccinations for 7-Way, IBR, BVD, PI3, BRSV, Lepto, and ivermectin. The heifers are also vaccinated for bangs and vibrio.
- ▶ When a genetic test was developed by RAAA for osteopetrosis (OS), Beckton tested every sire in use in our program, as well as our major AI sires. Every Beckton bred sire (nearly 80 in total) tested OS Free.
- ▶ We plan to have semen collected on some of the bulls before the sale. We will also work with the buyer to collect bulls after the sale.
- ▶ Buyer receives full possession and one half semen interest in all the bulls in the catalog. Seller is retaining one half interest in all bulls in the catalog. This is done so we can use some of the bulls in herd and reserve the right to collect and market semen on these bulls. Any collection on our behalf would be at our expense and could be done during the off-season and at the convenience of the buyer. The buyer would have the option to share in the collection and retain semen for the buyer's use also. If semen is marketed by either party, Seller receives one half royalty interest on gross semen sales, and buyer receives one half interest. Regardless of semen collection and marketing, the buyer retains full possession, full pasture use rights, and full salvage value in these bulls.
- ▶ Payments can be made with cash, check payable to Beckton Stock Farm, Inc. or Visa/Mastercard on sale day.

### Table of Contents

The Beckton Program . . . . .	4
The Bulls . . . . .	12
The Yearling Heifers . . . . .	62
Reference Sires. . . . .	70
RAAA Herd EPD Tables . . . . .	80
Sire Bloodline Charts. . . . .	82
Ref. Sire Cross Reference. . . . .	85
Lot-Tag Cross Reference. . . . .	86
Sale Terms & Conditions . . . . .	87

### All Bulls "Trich" Tested

In all the years we have been selling and delivering bulls, Beckton has never had a bull test positive for "trich". But because an increasing number of states require testing of yearling bulls, and to avoid any delay in delivery time, we will have all the sale bulls tested negative for "trich" prior to the sale. Customers from any state may also come to the sale with their trailer and load out directly after the sale.

### BECKTON BULL AND HEIFER WARRANTY

Optional protection against injury or death, plus Pregnancy coverage for heifers

**BULLS:** Injury or loss protection coverage - If your bull is permanently injured or dies any time up to 5 months after purchase, you will receive a credit toward purchase of another bull in the amount of the original purchase price minus salvage. The cost is 5% of the purchase price paid at settlement (eg. \$150 for a \$3,000 bull).

**HEIFERS:** Injury or loss protection plus Pregnancy Guarantee – likewise good for 5 months after purchase. If your heifer fails to become pregnant when exposed to a bull who settles 75% of the other heifers in the same pasture; or in the event your heifer is permanently injured or dies, you will receive a credit toward purchase of another heifer in the amount of the original purchase price minus any salvage. The cost is 10% of the purchase price paid at settlement (eg. \$200 for a \$2,000 heifer).



### Video of sale animals is available on our website, [www.BecktonRedAngus.com](http://www.BecktonRedAngus.com)

Lots with small square "QR code" barcodes similar to the one at left have video available to view on your iPhone, Android, Blackberry, or Windows Phone. Simply Scan the code with a free downloadable barcode reader app and you can view video footage of the animal right on your phone screen.

**Don't have the app? Don't worry!** Simply visit your phone's App Store and search for a "QR Code" app. There are lots of free apps available; "i-nigma" is one that works well on all platforms. If you can't get your phone to work you can still watch all of the videos online using a computer.

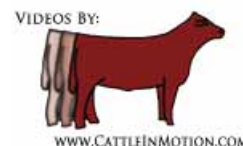

# The Beckton Program

## Cow Size

The goal for Beckton's program has always been to develop breeding seedstock which offer increased levels of performance for the commercial cattleman. Increased performance does not mean maximizing weight and size, which have already reached the upper limit of economic value for the packer and consumer. It does, however, mean increasing performance related to calving percentage and weaning percentage; and increasing performance related to cow maintenance requirements and "pounds of calf per acre" efficiency.

### Size Matters

Beckton cattle are already big enough for the consumer and the packer. Using yearling weight EPD as the best available indicator of market size, the average for our sale bulls is +80, about the same as the Red Angus breed average, so for market size our cattle are directly comparable.

The big difference with Beckton's program is that we select for additional weaning and yearling weight, but with the restriction that we have maintained the same cow size over time. In contrast, the industry has allowed cow size to increase at the same rate as calf size. Cow size is the largest factor determining maintenance requirements. Our goal has been to increase efficiency, not size. No other seedstock breeding program has had such a goal and maintained it for so long.

### Beckton Cow Weight Average (lb.)

Year	1978	1982	1986	1990	1994	1998	2002	2006	2010	2015
Wt.	1,126	1,126	1,064	1,115	1,067	1,125	1,104	1,093	1,068	1,126

(mature lactating cows taken at weaning)

Cow weights vary from year to year depending on grass, weather or other short term factors. But overall our cow size has stayed fairly constant over time.

### The Industry Problem

As shown on the graph on the next page, industry-wide cow size has increased substantially, 32% over this same time period...hay use per cow has increased by more than 36% from 1978 to 2013, from 1.43 tons per animal unit to 1.95 tons. Cow size has increased by about 32% since the 1970's and production per cow is up about 30%, but hay use per cow is up more than 36%.

Industry-wide, production per cow is up about 25% since the 1970s, but hay consumption per cow is up more than 40%.

Why does hay use increase at a faster rate than cow size or production per cow? Hay and grain are supplements to the cow's main diet, which is grass, and grass supply is relatively fixed by environment. Each increase in cow feed requirement must be met entirely by supplements, or by a combination of supplement and reduced stocking rate. A small increase in cow feed requirement leads to a reduction in stocking rate or a large increase in higher-cost, supplemental feed needs.

Any gains achieved in the feedlot sector due to increased animal growth, have been overwhelmed by increased cost of production in the cow-calf sector.

## The Beckton Crew...



Randy Zier



Alan Sanders



Roger Zier



Shelby Whitman

# Efficiency

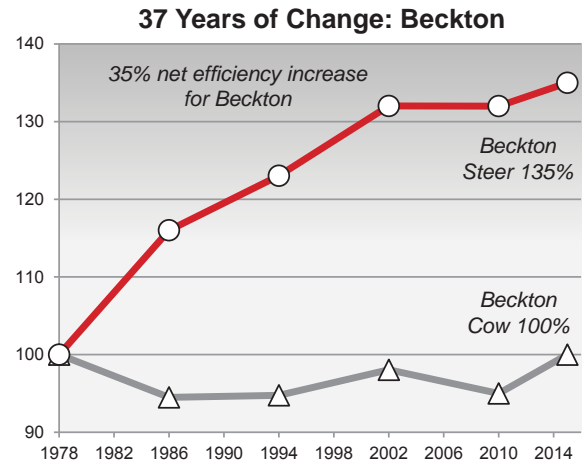
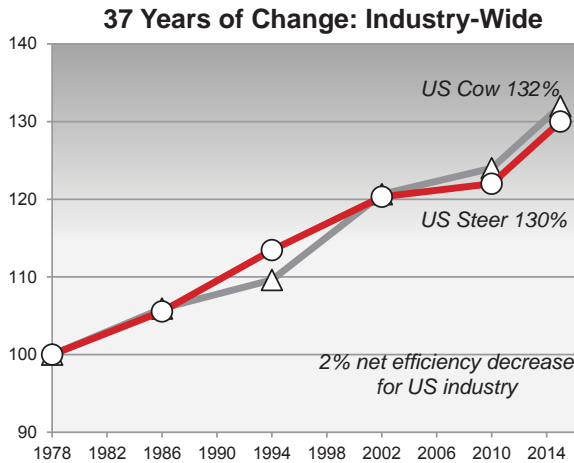

The graph at left shows how, for the U.S. cattle industry overall, the increase in average calf weights, as measured by steer slaughter weights, has been directly matched by an increase in average cow weights. (Percentages are based on USDA slaughter weight data for steers and cows respectively, using 1978 as a base year. Data for heifers slaughtered shows an identical trend.) Over nearly 40 years, there has been minimal change in overall cowherd efficiency.

This graph shows the failure of cross-breeding and composite breeding to do little more than simply increase general cattle size. In the promotion of composites, the impact of retained heterosis on mature weight is too often ignored. Crossbreeding and composites are sold as a free lunch, but they aren't free.

We have accomplished this by selecting for growth, restricting birth weight and cow size creep, and multiplying each incremental change rapidly throughout our entire cowherd and all of our bloodlines. Usually this has meant working within our own bloodlines rather than introducing out-crosses, because the outside genetics for the direction we wanted to go haven't been available. The overall key to success is simply that we have been making small progress in multiple traits, but doing it consistently over a very long period of time.

The graph at right shows Beckton cowherd data over the same time period.

1. Beckton cow size has shown no significant change over the past nearly 40 years, while the industry has experienced a substantial increase in cow size.
2. Even without increasing cow size, we have raised the rate of early growth in Beckton cattle, using intense genetic selection and generation turnover, and by more than the rest of the industry.
3. The net change in efficiency as measured simply by "calf weight divided by cow weight" is significantly higher with Beckton's genetic program, compared to mainstream cross-breeding based on retained heterosis.

## ... making the Beckton Program work!



Morgan Armstrong



Matt Zier



Tyler Miller



Pam Leeper



## Management

### One Bull – the Simple Solution is the Best Solution

Many cattlemen use Beckton bulls for their heifers because of their low birth weights and high calving ease. Our bulls are even better when used on cows, because replacement heifers tend to be selected from calves out of older cows. **Keeping replacement heifers sired by Beckton bulls is the quickest way to limit cow size creep and to moderate cow size for the future.** In our own program we use the same bulls on both heifers and cows. Every bull is used his first year with heifers to evaluate calving ease, and used in future years with older cows. We get calving ease, growth, and moderate-sized replacements, all with the same bull.

### Quietness and Ease of Handling

The necessity of record keeping means that our cattle will be handled much more than commercial cows. **This benefits our seedstock customers because our cattle will be quieter and easier to handle.** Good disposition is one of our most valued traits.

### Selection for Industry Requirements

In order to make selection decisions appropriate to the commercial beef industry, seedstock cattle need to be managed and measured under conditions which will approximate the commercial industry. **Our cows are run entirely on grass, with hay only if weather conditions require it, because that is how the commercial industry runs cows.** However, almost all commercial calves go into feedlots before slaughter, so feedlot performance and efficiency is an important trait for calves. **Simply put, a producer needs to know how his cows perform on grass, and how his calves perform with feed.**

Our bulls are run on a performance test designed to provide the fairest basis of comparison among them, and

this requires a compromise. Our bulls receive a “growing” ration high in roughage and protein and not as high in energy as a steer would receive. **We want to get a good measure of gainability with which to compare bulls, but we don’t want the bulls fat.**



*Craig Uden, Darr Feeders Manager*  
Photo courtesy of the Lexington Clipper-Herald



*Mitch Ziebell, Darr Feeders*

### Mitch Ziebell, Craig Uden of Darr, NE

Since 1979 all of our bulls have been performance tested at a facility owned and managed by the Kugler family near Cozad, Nebraska. In the fall of 2005, Lane Kugler retired and the operation was bought by a neighboring operation – Darr Feeders. The overall operation is managed by Craig Uden, with the bulls under the daily management of Mitch Ziebell. **We have been very impressed with the conscientious care with which Mitch oversees all aspects of the bull management.**

## Contributing to the success of the Beckton Program...



*Sarah Schreiber*  
*Our vet*



*Janet Drake*  
*Health Permit Expert ++*



*Cody Cunningham*  
*Brand Inspector*



*Dr. Robert Bohlander*  
*Fertility tests the bulls*



*Bob Milner*  
*Our AI tech*



## Additional Facts about the Beckton Program

### Birth weight

- ▶ Every sire entering our own program is used first on our own heifers, then on our cows.
- ▶ We have never used high birth weight sires in any part of our program, so big birth weights are rare.
- ▶ We get the pay weight, but with lower birth weights and greater calving ease.
- ▶ Full production from heifers. We use the same bulls on heifers and cows.

### Growth

- ▶ Weaning efficiency, and rate of gain to slaughter weight second to none.
- ▶ Growth traits must be consistent with maintaining maternal qualities.
- ▶ Beckton cattle are ideally sized for today's packer demand.

### Hardiness

- ▶ Every cow in the herd has spent part of her life in the Big Horn Mountain summer range, at elevations from 7000 to 10,500 feet.
- ▶ In 2001 we PAP tested all of our herd sires. The herd average PAP score was 32.5 at 4000', equivalent to a herd average PAP of 39 at 8000' (excellent scores).
- ▶ By the time she is 5, our average cow will have been trailed over 80 miles, above and beyond normal pasture rotation.

### Efficiency

- ▶ The typical dam of our bulls weans over 50% of her body weight in 205 days, under range conditions, with no creep-feeding.
- ▶ The average dam produces over 100% of her own body weight in a year.
- ▶ The average mature cow (age 5+) weighs about 1100-1125 pounds.

### Fertility

- ▶ Every bull in our program is used in natural service, with 30-50 heifers/cows.
- ▶ Every cow in our program must cycle naturally and breed early under range conditions.

### Value

- ▶ Beckton Red Angus produce more growth without high birth weights.
- ▶ They are the one-bull solution that can be used on both heifers and cows.
- ▶ Carcass quality is an extra benefit.

### Reliability

- ▶ Beckton has been genetically improving Red Angus since 1945, a 30-60 year lead time over other producers.
- ▶ It is a complete, genetically sound breeding program, which demands whole-herd performance.



Chuck Overturf  
Friend and neighbor - helps us every year

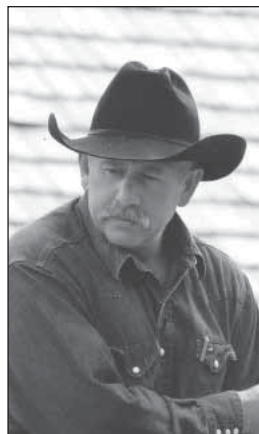

Dave Nelson, long-time  
friend, neighbor, and  
helping hand



Cody and Chad Halfmann, Halfmann Red Angus  
Special thanks for helping to create the bull videos

# Separating science from politics & marketing

## Red Angus unveils reliable, unbiased indices

by Larry Keenan, Director of Breed Improvement

The Red Angus Association of America (RAAA) implements a unique approach when developing genetic selection tools. In order to deliver the most reliable and unbiased data to Red Angus stakeholders, RAAA separates sound science from subjective politics and marketing.

RAAA achieves this through implementation of a non-political Technical Committee, which is populated by non-Board members and actually has decision-making powers regarding genetic predictions.

Once the technical committee is provided an assignment – such as developing economic selection indices – it is tasked with overseeing development and ultimately deciding if the tool – or index in this case – is dependable enough to release to stakeholders. While this process may slow the release of a new EPD or index, commercial producers can have confidence that once the tool is released, it is reliable.

Red Angus' work on economic selection indices provides an excellent example of the importance of such committee structure. RAAA previously had the ability to release an index; however, Technical Committee review revealed flaws in the proposed index that essentially caused it to be a marketing tool as opposed to a selection tool.

After multiple refinements to the index development software, RAAA is excited to announce that the Technical Committee has approved the release of the HerdBuilder and GridMaster indices.

### What are Indices?

The purpose of an index (plural – indices) is to estimate differences in an operation's overall profitability resulting from a particular selection decision. In developing an index to evaluate differences in profitability within an operation, assumptions must be made regarding the genetics of the cowherd (ex: average weaning weight) as well as economic values (ex: sale price of cull cows).

RAAA utilized the Red Angus database to determine the required cowherd assumptions. The economic assumptions were derived from input obtained from CattleFax and economic data from Texas A&M and North Dakota State University. Additionally, certain basic

production assumptions are made, such as: Will the bulls be used on heifers and/or cows? Are replacement heifers retained? When and how are calves marketed?

Once these assumptions were determined, the data was fed into a simulation model that accounted for the segments of the beef industry based on the assumptions. Finally, EPDs of the service sires were included in the simulation model to determine the overall impact the sires would have on the operation's profitability.

The EPDs included in the index calculation are independently changed one unit (ex: Stayability EPD of 10 vs. 11), and the resulting change in overall profitability determines the weightings placed on each EPD. It is important to understand that these EPD weightings are not determined, or adjusted, using human perceptions. Thus, the weightings, and ultimately the indices, are completely based on science.

While the process of calculating an index is very complex, the resulting selection tool is very simple to implement. RAAA's indices will be expressed to stakeholders as differences in profitability per exposure. For example, Bull A has an index value of 100 and Bull B has an index value of 150, and the selected bull would be mated to 120 cows over the bull's productive lifespan. Selecting Bull B would add an additional \$6,000  $[(150 - 100) \times 120]$  in profitability to the operation as compared to selecting Bull A.

While Red Angus bulls are selected by stakeholders to fit into various production scenarios, selection pressure is typically placed on herd-building traits or traits that increase the value of marketed product. Many producers have even developed their own selection index to assist them in identifying bulls that meet these goals. Typically these include thresholds for certain EPDs, but as most would admit, these thresholds are not strictly followed. Red Angus' selection indices will provide producers with a consistent selection tool built on a scientific, unbiased foundation.



## HerdBuilder Index

As the name indicates, implementation of the HerdBuilder Index will assist producers in building profitable herds. The HerdBuilder Index is built using the following production scenario:

- ▶ Red Angus bulls mated to cows and heifers (resulting progeny  $\frac{3}{4}$  Red Angus,  $\frac{1}{4}$  Simmental)
- ▶ Replacement heifers retained from within the herd
- ▶ All remaining progeny sold on a quality-based carcass grid.

Given that replacement heifers are retained, significant influence is placed on the obvious maternal EPDs of Stayability, Heifer Pregnancy and Calving Ease. Additionally, with all remaining progeny sold on a quality-based carcass grid, Marbling, Yield Grade and growth EPDs impact the HerdBuilder index.

## GridMaster Index

While Red Angus has traditionally been known as a superior maternal breed, those who have retained ownership in Red Angus calves know of their potential to excel in the feedyard and ultimately hang a premium carcass.

Red Angus stakeholders will quickly recognize the term “GridMaster,” as the Marketing Department annually recognizes load lots of harvested cattle with superior carcass observations as “Grid Master” Award winners.

Producers who place emphasis on the GridMaster Index in their selection decisions will not only experience an increase in their operation’s profitability; but as well can expect to see an increased number of calves recognized as Grid Master Award winners.

The GridMaster Index is built using the following production scenario:

- ▶ Red Angus bulls mated to cows (resulting progeny  $\frac{3}{4}$  Red Angus,  $\frac{1}{4}$  Simmental)
- ▶ All progeny sold on a quality-based carcass grid.

Thus, Marbling, Yield Grade and growth EPDs are the traits of primary importance in the GridMaster Index.

## What if my Production Scenario is Different?

While your operation may differ from the above index scenarios, our research shows that the two above situations will serve as reliable selection tools for the vast majority of ranches.

Use the GridMaster Index if your operation’s primary goal is maximizing profitability of feeders in the feedyard and on the rail.

For example, if your operation matches the HerdBuilder Index, except you would be using the selected bull on cows only, this small difference would not cause a significant change in the ranking of animals.

During committee discussions, the Technical Committee explored creating an additional HerdBuilder-Cow Index, which would use the same scenario as the above HerdBuilder except the bulls would only be used on cows. In comparing the HerdBuilder vs. HerdBuilder-Cow indices, we found that bulls ranked essentially the same between the two indices.

To be exact, the rank correlation was 0.97, which can be interpreted as only 3 in 100 bulls changed rank between the HerdBuilder and HerdBuilder-Cow. Thus demonstrating the robustness of the HerdBuilder Index, in that your production scenario can slightly deviate from the exact scenario in which the HerdBuilder Index was built, and the HerdBuilder Index can still serve as a reliable selection tool.

A quick study of the HerdBuilder and GridMaster Indices reveals that the main difference between these two indices is the source of replacement heifers. If the selected sire will be used to produce replacement females, the HerdBuilder Index should be used. However, if the selected sire will not be used to generate replacements, the GridMaster Index should be used.

Red Angus’ unwavering implementation of science has provided the foundation for the delivery of genetic selection tools with unmatched reliability. This precedence was strictly followed in the development and delivery of Red Angus’ HerdBuilder and GridMaster indices. Thus, stakeholders can have confidence that these new tools are truly genetic selection tools, and not just a marketing tool.

# Beckton History



*Sal keeping records.*



*Waldo Forbes - 1st President of the Red Angus Association.*



*Beckton house/office before being moved in 1905 to its current location. This house was built in the 1880s by George Beck, the original homesteader. The antlers are still on the porch, and it is one of the oldest buildings in Sheridan County.*



*The Waldo Forbes family in 1959: Ellen, Julia, Sal, Sarah, Cherry, Spike, and Cam & Elfie in front.*



*Inspection Committee at Beckton (1954), including George and Vernice Chiga, Sal and Waldo Forbes and Spike.*



*Beckton Larkabeau O "220" in 1959 - the 1st Red Angus Bull at ABS*



*Mrs. Waldo (Sal) Forbes was honored as the first woman inducted into the Saddle and Sirloin Club's portrait gallery in Louisville, KY.*



## Using New Selection Tools

### HerdBuilder and GridMaster Indices

The new Red Angus Association HERDBuilder and GRIDMaster Indices are given for each sale animal, in the box just above the EPDs. The Index number is followed by the “Percentile” showing how that animal ranks compared to all other Red Angus bulls or heifers. A higher Index number results in a lower “Percentile” number, which means a higher ranking within the breed, and is therefore better. The development of these Indices by the RAAA is described in the article written by Larry Keenan and reprinted.

The familiar Birth Weight or Yearling Weight EPDs, for example, are measured in pounds of increase in weight, whereas these Indices are measured in ‘dollars of increase in profitability’ - the expected increase in profit that each animal is expected to generate per mating of that animal. A bull with a HerdBuilder Index of 160, compared to a second bull with an index of 110, should produce  $160 - 110 = 50$  dollars of expected increased profit for each cow to which he is mated, compared to the second bull (note that this is ‘per mating’, not ‘per calf produced’). The Index considers and weights all economic factors – fertility, calving ease, maintenance costs, growth rate, stayability, carcass quality, etc. - according to best available science,

You will find Beckton bulls individually and as a group ranking in the top of the breed for profitability, as measured by these new Indices.

### Maintenance EPD

This EPD predicts the relative feed energy requirement for maintenance, for cows produced by a sire or female. A bull with an ME of -3 (minus 3) is expected to sire replacement daughters which will need 10 fewer mcals of energy per month than a bull with an ME of +7.

We believe this is an important EPD because feed costs, both direct and indirect through ranch overhead, make up by far the largest proportion of operating costs. It can have much more direct impact on ranch profitability than Marbling or Ribeye EPD for example.

The Beckton herd has been one of the breed’s top herd for low maintenance energy requirements for many years.

### Calving Ease

The Red Angus Calving Ease EPD was introduced in 2003, and is a more direct measure of calving ease than birth weight alone. Calving Ease is defined as follows: “The expected differences of calving ease measured as the probability difference (between sires) of unassisted calvings among offspring.” For Calving Ease EPD, the higher number is better.

There are two Calving Ease EPD’s - “Direct”, a predictor of an animal’s own offspring; and “Maternal”, a predictor of a daughters calving ease. Unless stated otherwise, we publish the Calving Ease Direct because most of our customers’ primary concern is selecting bulls for use on first calf heifers.

Beckton’s average Calving Ease EPD is +12, a full eight points higher than the the Red Angus breed average of 4, due to our long history of selection for moderate birth weights. **The average Beckton bull is in the top 4% of the entire breed for highest Calving Ease.**

### Cow Efficiency

We present two indicators of efficiency. The first is Weaning Percent, a simple percentage of calf 205 day weight divided by the dam’s actual weight at weaning. The second is PRI Cow Efficiency. This also measures calf weaning weight, but relative to the cow’s metabolic weight, and is expressed as an index above or below 100.

These efficiency measures are best used as indicators of where an animal is relative to others, rather than directly for selection. For example, if we see an animal with a low efficiency, we would look at the actual calf and cow weights to decide if the calf is too small, or the cow too big for the environment. That in turn will suggest corrective actions. In general, select for the traits you need to change to make cattle more efficient, and efficiency will be the result.

**Beckton has been performance tested selection since 1945, and we believe our cattle today are the most efficient in the industry.**

### Dam Information

A major difference with our catalog is the greater amount of information about the dams we provide. Weaning percent and Cow Efficiency are explained above. In addition, with each sale animal we give the dam’s age when this calf was born, and the dam’s actual weight when the calf was weaned the previous fall. We also provide her progeny averages – the average birth weight, weaning ratio, and yearling ratio – of her calves.

# The Bulls

Our bulls are managed in a manner to gain important performance data and information, and equally importantly, to develop and provide our customers with many years of productive service. We have been testing breeding bulls over 50 years, longer than almost any other producer. Our own breeding is based primarily on natural service, not AI, so we see how our bulls work in the pasture. We use bulls raised and managed just this way, with our own cows and heifers, on every kind of terrain, and high in the Bighorn Mountains.

For the first twenty years our bulls were tested at home here in Wyoming. They received some grain, but otherwise grass pasture and dry hay. In 1979 we moved our test to a facility managed by the Kugler family in Cozad, Nebraska, where the bulls got a ration including silage, corn and protein. When we brought our first bulls home from Kuglers' and used them with our own cowherd, we discovered a dramatic increase in libido and breeding performance. The effect of proper

nutrition was apparent, and the bulls would maintain condition and hold up better through the entire breeding season. We have continued managing our bulls at the same facility ever since (now managed by Craig Uden), and we continue to see the same benefits.

We have since used over 500 of these bulls natural service in our own breeding program, on dry range and in the mountains, and have never had a bull fall out of our program early due to his feeding or testing management. Beckton Julian B571, Lancer F442, Nebula M045, Nebula P707, and all of our other great sires were fed and managed in Cozad. While it is possible to feed bulls improperly under any structure, we would strongly question those who promote the notion of any advantage to "forage-raised" bulls. Every year we see the results and success of our bull management program, and we serve many satisfied customers.



Lot 62



• Bulls •

**1** **BECKTON NEW ERA C307 N2**   
 1-A 100% # 3487327 Tat.: BKT5 C307  
 Birth: 3-20-15  
 Beckton Nebula P P707 < Beckton Nebula M045  
 Beckton Lana M809 EP  
**BECKTON NEW ERA Y194**  
 Ref. N-4 < BKT Larkeisa T310 JC < Beckton Justice C1 R483  
 < BKT Larkeisa R775 JC  
 Beckton Nebula EN S347 < Beckton Nebula E P084  
**BECKTON LARKABA W272 N**  
 Beckton Eola P530 NB  
 Beckton Herald FJ J776  
 Beckton Larkaba N643 HR < Beckton Larkaba J765 CH

BWT	64
WR	105
ADG	4.43
YWt	1242
YR	110
Scr.	36
Fr.	5.0

**DAM**  
 Age 6  
 Wt 990  
 Prog. BW 61  
 WR 104  
 YR 104  
 Wean Pct. 65%  
 Cow Eff. 137

RAAA HerdBuilder index: **180** (Top 1% of all RA bulls)  
 RAAA GridMaster index: **52** (Top 5% of all RA bulls)  
 Calv. Ease BW WW YW Milk HPG Stay Maint. En.  
 EPDs **16.7 -6.8 57.3 92.2 29 14.4 15.2 -7.7**  
 Marb **+0.61** REA **+0.00** Bfat **+0.03**

★★★★★ for Low Maintenance, Growth, Gainability, Marbling, Superior Cow, High Cow Efficiency, Calving Ease, Stayability.



Lot 2

**3** **BECKTON JULIAN C253 J4**   
 1-A 100% # 3487410 Tat.: BKT5 C253  
 Birth: 3-18-15  
 Beckton Julian 7526G < Beckton Julian 6592  
 Bkt Belga 6746 GS  
**BECKTON JULIAN GG B571**  
 Ref. J-1 < Beckton Julian 7526G  
 < Bkt Marta 9A13 JL < Bkt Marta 6498 XM  
 Beckton Justice CH M056 < Beckton Justice C K449  
**BECKTON TAMARA R834 JC**  
 Beckton Ruth K802 HD  
 Beckton Neptune RR B284  
 Beckton Tamara J229 NP < Beckton Tamara C931 CL

BWT	57
WR	111
ADG	4.14
YWt	1277
YR	114
Scr.	32
Fr.	5.5

**DAM**  
 Age 10  
 Wt 1170  
 Prog. BW 73  
 WR 99  
 YR 103  
 Wean Pct. 56%  
 Cow Eff. 118

RAAA HerdBuilder index: **167** (Top 3% of all RA bulls)  
 RAAA GridMaster index: **53** (Top 2% of all RA bulls)  
 Calv. Ease BW WW YW Milk HPG Stay Maint. En.  
 EPDs **16.4 -5.4 60.4 99.5 18 13.2 13.2 -3.8**  
 Marb **+0.70** REA **+0.29** Bfat **+0.03**

★★★★★ for Low Maintenance, Growth, Gainability, Marbling, Rib-eye area, High Cow Efficiency, Calving Ease, Stayability.

**4** **BECKTON JULIAN C395 N8**   
 1-A 100% # 3487310 Tat.: BKT5 C395  
 Birth: 3-24-15  
 Beckton Julian X721 E6 < Beckton Julian U699 L5  
 Beckton Lana U329 EP  
**BECKTON JULIAN Z382 J7**  
 Ref. J-4 < Beckton Julian U699 L5  
 Beckton Larkaba X064 J < Beckton Larkaba U475 CT  
 Beckton Nebula PJ S543 < Beckton Nebula P P707  
**BECKTON SERENA W738 N**  
 Beckton Lana P685 JO  
 Beckton Serena S649 LO < Beckton Loki C M740  
 Beckton Serena F248 CZ

BWT	77
WR	115
ADG	3.45
YWt	1210
YR	108
Scr.	36
Fr.	5.0

**DAM**  
 Age 6  
 Wt 1340  
 Prog. BW 74  
 WR 114  
 YR 114  
 Wean Pct. 51%  
 Cow Eff. 107

RAAA HerdBuilder index: **165** (Top 3% of all RA bulls)  
 RAAA GridMaster index: **51** (Top 19% of all RA bulls)  
 Calv. Ease BW WW YW Milk HPG Stay Maint. En.  
 EPDs **13.5 -5.3 68.7 99.8 18 11.5 15.5 -1.2**  
 Marb **+0.39** REA **+0.12** Bfat **+0.02**

★★★★★ for Low Maintenance, Growth, Marbling, Superior Cow, Calving Ease, Stayability.

**2** **BECKTON NEW ERA C249 J2**   
 1-A 100% # 3487672 Tat.: BSF5 C249  
 Birth: 3-18-15  
 Beckton Nebula P P707 < Beckton Nebula M045  
 Beckton Lana M809 EP  
**BECKTON NEW ERA Y194**  
 Ref. N-4 < BKT Larkeisa T310 JC < Beckton Justice C1 R483  
 < BKT Larkeisa R775 JC  
 Beckton Jules L429 < Beckton Julian G1 J526  
**BECKTON INDIGO W419 J**  
 Beckton Barona J591 EP  
 Beckton Herald F1 L151  
 Beckton Indigo N754 HR < Beckton Indigo LC22 LO

BWT	73
WR	111
ADG	3.62
YWt	1223
YR	109
Scr.	40
Fr.	5.0

**DAM**  
 Age 6  
 Wt 1220  
 Prog. BW 65  
 WR 106  
 YR 105  
 Wean Pct. 54%  
 Cow Eff. 113

RAAA HerdBuilder index: **146** (Top 9% of all RA bulls)  
 RAAA GridMaster index: **51** (Top 13% of all RA bulls)  
 Calv. Ease BW WW YW Milk HPG Stay Maint. En.  
 EPDs **13.4 -4.3 63.7 101.5 23 14.1 12.6 -2.3**  
 Marb **+0.65** REA **-0.17** Bfat **+0.07**

★★★★★ for Low Maintenance, Growth, Marbling, Superior Cow, Calving Ease.

**5** **BECKTON ACCENT C537 N3**   
 1-A 100% # 3487542 Tat.: BKT5 C537  
 Birth: 3-30-15  
 Beckton Cody K1 P014 < Beckton Cody KH M390  
 Beckton Rose M126 WR  
**BECKTON ACCENT W180 C2**  
 Ref. A-1 < Beckton Cherokee N N479  
 Beckton Christy R046 CQ < Beckton Christy N740 HR  
 Beckton Nebula X353 E3 < Beckton Nebula G S237  
**BECKTON ROSE Z048 N**  
 Beckton Lana R058 EP  
 Beckton Cherokee T450 L3  
 Beckton Rose X662 C < Beckton Rose M126 WR

BWT	55
WR	109
ADG	4.08
YWt	1214
YR	110
Scr.	35
Fr.	6.0

**DAM**  
 Age 3  
 Wt 1125  
 Prog. BW 53  
 WR 105  
 YR 105  
 Wean Pct. 52%  
 Cow Eff. 109

RAAA HerdBuilder index: **161** (Top 4% of all RA bulls)  
 RAAA GridMaster index: **53** (Top 2% of all RA bulls)  
 Calv. Ease BW WW YW Milk HPG Stay Maint. En.  
 EPDs **14.4 -6.6 58.2 97.1 26 13.1 13.8 0.4**  
 Marb **+0.67** REA **+0.26** Bfat **+0.02**

★★★★★ for Low Maintenance, Growth, Gainability, Marbling, Rib-eye area, Superior Cow, Calving Ease, Stayability.

• Bulls •

**6** **BECKTON ACCENT C216 D4**  1-A 100% # 3487412 Tat.: BKT5 C216

Birth: 3-15-15

Beckton Accent U777 C2  
**BECKTON ACCENT Y312 N3**  
 Ref. A-3 BKT Larkeisa S055 NB

Beckton Cody K1 P014  
 Beckton Susan R022 CQ  
 Beckton Nebula P F707  
 Beckton Larkeisa P688 CH  
 Beckton Dominor Z E401  
 Beckton Barmaid J012 CO  
 Beckton Julian GG B571  
 Beckton Belga G493 HR

BWT **66**  
 WR **100**  
 ADG **4.02**  
 YWt. **1157**  
 YR **102**  
 Scr. **35**  
 Fr. **5.0**

**BECKTON BELGA R716 DM**  
 Beckton Dominor ZC M919  
 Beckton Belga K285 JL

**DAM**  
 Age 10  
 Wt 1215  
 Prog.BW 69  
 WR 105  
 YR 104  
 Wean Pct. 51%  
 Cow Eff. 107

RAAA HerdBuilder index: **176** (Top 1% of all RA bulls)  
 RAAA GridMaster index: **51** (Top 14% of all RA bulls)  
 Calv.Ease BW WW YW Milk HPG Stay Maint.En.  
 EPDs **16.5 -6.7 45.3 76.8 25 11.1 15.9 -4.3**  
 Marb **+5.4** REA **+0.0** Bfat **+0.6**

★★★★★ for Low Maintenance, Gainability, Marbling, Superior Cow, Calving Ease, Stayability.

**8** **BECKTON EPIC C488 W7**  1-A 100% # 3487835 Tat.: BSF5 C488

Birth: 3-28-15

Beckton Epic U749 D5  
**BECKTON EPIC Y484 N6**  
 Ref. E-4 Beckton Lydia S069 NB

Beckton Epic K4 N795  
 Beckton Denise R308 DM  
 Beckton Nebula P F707  
 Beckton Lydia P583 WR  
 Beckton Warrior T1 H281  
 Beckton Rose H074 EP  
 Beckton Epic KJ J722  
 Beckton Belga K476 JL

BWT **83**  
 WR **104**  
 ADG **3.97**  
 YWt. **1243**  
 YR **111**  
 Scr. **38**  
 Fr. **5.0**

**BECKTON BELGA U492 WR**  
 Beckton Warrior N645 T1  
 Beckton Belga P119 EP

**DAM**  
 Age 7  
 Wt 1310  
 Prog.BW 66  
 WR 94  
 YR 106  
 Wean Pct. 47%  
 Cow Eff. 99

RAAA HerdBuilder index: **138** (Top 13% of all RA bulls)  
 RAAA GridMaster index: **51** (Top 12% of all RA bulls)  
 Calv.Ease BW WW YW Milk HPG Stay Maint.En.  
 EPDs **8.8 -1.2 66.8 113.8 15 13.5 12.5 1.7**  
 Marb **+3.2** REA **+4.5** Bfat **-0.1**

★★★★★ for Low Maintenance, Growth, Marbling, Rib-eye area, Calving Ease.



**9** **BECKTON EPIC C199 D6**  1-A 100% # 3487402 Tat.: BKT5 C199

Birth: 3-13-15

Beckton Epic K6 S569  
**BECKTON EPIC X464 L5**  
 Ref. E-2 Beckton Lana M393 LN

Beckton Epic KM M115  
 Beckton Sierra N703 LM  
 Beckton Lancer T3 J396  
 Beckton Lana F081 LN  
 Beckton Dominor Z E401  
 Beckton Barmaid J012 CO  
 Beckton Lancer F442 T  
 Beckton Lana H143 JL

BWT **70**  
 WR **94**  
 ADG **4.48**  
 YWt. **1211**  
 YR **108**  
 Scr. **36**  
 Fr. **5.0**

**BECKTON LANA S371 DM**  
 Beckton Dominor ZC M919  
 Beckton Lana L367 LN

**DAM**  
 Age 9  
 Wt 1225  
 Prog.BW 73  
 WR 99  
 YR 101  
 Wean Pct. 46%  
 Cow Eff. 96

RAAA HerdBuilder index: **152** (Top 6% of all RA bulls)  
 RAAA GridMaster index: **52** (Top 7% of all RA bulls)  
 Calv.Ease BW WW YW Milk HPG Stay Maint.En.  
 EPDs **11.5 -3.1 56.6 102.6 25 9.7 14.2 -4.3**  
 Marb **+4.9** REA **+0.7** Bfat **+0.1**

★★★★★ for Low Maintenance, Growth, Gainability, Marbling, Calving Ease, Stayability.

**7** **BECKTON ACCENT C367 J3**  1-A 100% # 3487319 Tat.: BKT5 C367

Birth: 3-23-15

Beckton Cody K1 P014  
**BECKTON ACCENT W180 C2**  
 Ref. A-1 Beckton Christy R046 CQ

Beckton Cody KH M390  
 Beckton Rose M126 WR  
 Beckton Cherokee N N479  
 Beckton Christy N740 HR  
 TR Julian LT151  
 Beckton Minerva L278 LN  
 Beckton Nebula M045  
 Andras Scarlett 2029

BWT **69**  
 WR **102**  
 ADG **3.56**  
 YWt. **1146**  
 YR **102**  
 Scr. **37**  
 Fr. **5.5**

**BECKTON SCARLETT W497 J**  
 Beckton Jet L P491  
 Beckton Scarlett R808 NB

**DAM**  
 Age 6  
 Wt 1100  
 Prog.BW 70  
 WR 102  
 YR 107  
 Wean Pct. 55%  
 Cow Eff. 116

RAAA HerdBuilder index: **155** (Top 5% of all RA bulls)  
 RAAA GridMaster index: **52** (Top 5% of all RA bulls)  
 Calv.Ease BW WW YW Milk HPG Stay Maint.En.  
 EPDs **14 -5.8 49.7 81.6 26 12.7 13.3 -7.2**  
 Marb **+7.9** REA **+1.5** Bfat **+0.5**

★★★★★ for Low Maintenance, Marbling, Rib-eye area, High Cow Efficiency, Calving Ease, Stayability.

**10** **BECKTON HERITAGE C321 L4**  1-A 100% # 3487712 Tat.: BSF5 C321

Birth: 3-21-15

Beckton Heritage T270 J2  
**BECKTON HERITAGE X403 L3**  
 Ref. H-1 Beckton Indigo H150 LN

Beckton Heritage N013  
 Beckton Coca P602 JL  
 Beckton Lancer TE F363  
 Beckton Indigo F376 CT  
 Beckton Likable S633  
 Beckton Lana S157 JT  
 Beckton Nebula L P093  
 Beckton Encino H115 HD

BWT **64**  
 WR **108**  
 ADG **4.31**  
 YWt. **1236**  
 YR **112**  
 Scr. **34**  
 Fr. **6.0**

**BECKTON ENCINO Z278 L**  
 Beckton Likable U091 J2  
 Beckton Encino U181 NB

**DAM**  
 Age 3  
 Wt 1085  
 Prog.BW 59  
 WR 104  
 YR 109  
 Wean Pct. 54%  
 Cow Eff. 113

RAAA HerdBuilder index: **146** (Top 9% of all RA bulls)  
 RAAA GridMaster index: **50** (Top 22% of all RA bulls)  
 Calv.Ease BW WW YW Milk HPG Stay Maint.En.  
 EPDs **12.2 -4.8 58.7 88.8 22 12.1 13.4 -2.5**  
 Marb **+7.3** REA **+0.0** Bfat **+1.1**

★★★★★ for Low Maintenance, Growth, Gainability, Marbling, Superior Cow, Calving Ease, Stayability.



• Bulls •

**11 BECKTON HERITAGE C335 N4**   
 1-A 100% # 3487655 Tat.: BSF5 C335  
 Birth: 3-22-15  
 Beckton Heritage T270 J2 < Beckton Heritage N013  
 Beckton Coca P602 JL  
**BECKTON HERITAGE X403 L3** < Beckton Lancer TE F363  
 Ref. H-1 < Beckton Indigo H150 LN < Beckton Indigo F376 CT  
 Beckton Nebula EN S347 < Beckton Nebula E P084  
**BECKTON LANA W518 N** < Beckton Eola P530 NB  
 Beckton Lana P073 EP < Beckton Epic KM M115  
 Beckton Lana M393 LN

BWt	65
WR	109
ADG	3.85
YWt	1197
YR	107
Scr.	37
Fr.	5.0

**DAM**  
 Age 6  
 Wt 1230  
 Prog.BW 66  
 WR 111  
 YR 111  
 Wean Pct. 53%  
 Cow Eff. 111

RAAA HerdBuilder index: **150** (Top 7% of all RA bulls)  
 RAAA GridMaster index: **50** (Top 27% of all RA bulls)  
 Calv.Ease BW WW YW Milk HPG Stay Maint.En.  
 EPDs **14.7 -6.4 55.5 75.8 30 13.1 13.2 -1.6**  
 Marb **+.77** REA **-.34** Bfat **+.07**

★★★★★ for Low Maintenance, Growth, Marbling, Superior Cow, Calving Ease, Stayability.

**13 BECKTON NEBULA C453 J5**   
 1-A 100% # 3487800 Tat.: BSF5 C453  
 Birth: 3-27-15  
 Beckton Nebula U206 V3 < Beckton Nebula P P707  
 Beckton Minerva J615 VG  
**BECKTON NEBULA X096 N4** < Beckton Nebula P F707  
 Ref. N-3 < Beckton Tamara U185 NB < Beckton Tamara P813 CH  
 Beckton Justice CH M056  
**BECKTON CHRISTY W827 J** < Beckton Tamara J124 HR  
 Beckton Justice C1 R483 < Beckton Cody KH M390  
 Beckton Christy R434 CD < Beckton Christy M362 WR

BWt	68
WR	103
ADG	3.97
YWt	1201
YR	106
Scr.	35
Fr.	5.0

**DAM**  
 Age 6  
 Wt 1095  
 Prog.BW 62  
 WR 103  
 YR 98  
 Wean Pct. 58%  
 Cow Eff. 122

RAAA HerdBuilder index: **172** (Top 2% of all RA bulls)  
 RAAA GridMaster index: **52** (Top 8% of all RA bulls)  
 Calv.Ease BW WW YW Milk HPG Stay Maint.En.  
 EPDs **13.9 -5.3 58.3 93.6 23 14.2 15.5 0.8**  
 Marb **+.59** REA **-.04** Bfat **+.01**

★★★★★ for Low Maintenance, Growth, Marbling, High Cow Efficiency, Calving Ease, Stayability.

**12 BECKTON NEW ERA C449 W2**   
 1-A 100% # 3487320 Tat.: BKT5 C449  
 Birth: 3-27-15  
 Beckton Nebula P P707 < Beckton Nebula M045  
 Beckton Lana M809 EP  
**BECKTON NEW ERA Y194** < Beckton Justice C1 R483  
 Ref. N-4 < BKT Larkeisa T310 JC < BKT Larkeisa R775 JC  
 Beckton Warrior T248 L5 < Beckton Warrior N645 T1  
**BECKTON SUFFEINA W489 W** < Beckton Kit R503 LN  
 BKT Suffeina T500 EP < Beckton Epic K3 M606  
 Beckton Suffeina N844 LN

BWt	75
WR	108
ADG	4.08
YWt	1211
YR	108
Scr.	36
Fr.	5.0

**DAM**  
 Age 6  
 Wt 1065  
 Prog.BW 63  
 WR 110  
 YR 110  
 Wean Pct. 60%  
 Cow Eff. 127

RAAA HerdBuilder index: **137** (Top 14% of all RA bulls)  
 RAAA GridMaster index: **51** (Top 14% of all RA bulls)  
 Calv.Ease BW WW YW Milk HPG Stay Maint.En.  
 EPDs **12 -4.1 60.2 101.3 21 11.2 12.2 -5.3**  
 Marb **+.42** REA **-.04** Bfat **+.02**

★★★★★ for Low Maintenance, Growth, Gainability, Marbling, Superior Cow, High Cow Efficiency, Calving Ease.

**14 BECKTON ACCENT C487 L3**   
 1-A 100% # 3487414 Tat.: BKT5 C487  
 Birth: 3-28-15  
 Beckton Cody K1 P014 < Beckton Cody KH M390  
 Beckton Rose M126 WR  
**BECKTON ACCENT W180 C2** < Beckton Cherokee N N479  
 Ref. A-1 < Beckton Christy R046 CQ < Beckton Christy N740 HR  
 Beckton Lancer T A664  
**BECKTON KIT R441 LN** < Bkt Suffeina A828 DM  
 Beckton Julian GG B571  
 Beckton Kit F468 JL < Beckton Kit A517 NP

BWt	76
WR	107
ADG	4.02
YWt	1202
YR	107
Scr.	36
Fr.	5.0

**DAM**  
 Age 10  
 Wt 1125  
 Prog.BW 68  
 WR 102  
 YR 97  
 Wean Pct. 56%  
 Cow Eff. 119

RAAA HerdBuilder index: **136** (Top 15% of all RA bulls)  
 RAAA GridMaster index: **50** (Top 23% of all RA bulls)  
 Calv.Ease BW WW YW Milk HPG Stay Maint.En.  
 EPDs **10.5 -3.8 59.8 92.3 19 12.4 12.7 -4.8**  
 Marb **+.33** REA **+.41** Bfat **+.01**

★★★★★ for Low Maintenance, Growth, Gainability, Marbling, Rib-eye area, High Cow Efficiency, Calving Ease.

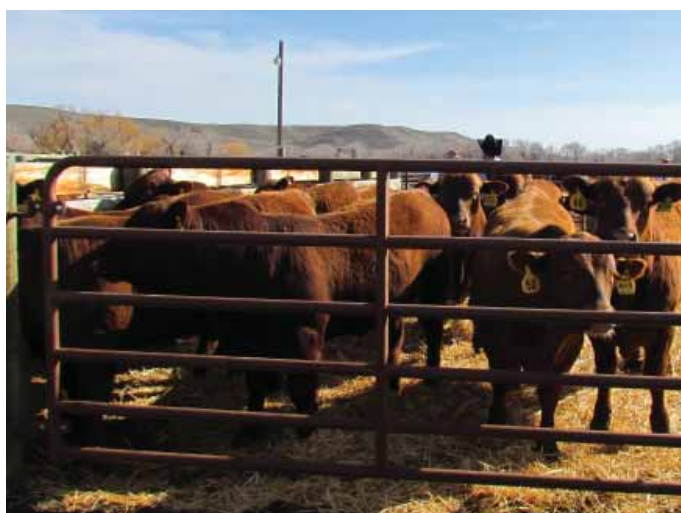

**15 BECKTON ACCENT C210 J4**   
 1-A 100% # 3487201 Tat.: BKT5 C210  
 Birth: 3-15-15  
 Beckton Accent U777 C2 < Beckton Cody K1 P014  
 Beckton Susan R022 CQ  
**BECKTON ACCENT A485 C3** < Beckton Cherokee N N479  
 Ref. A-7 < Beckton Tamara R175 CQ < Beckton Tamara N765 CO  
 Beckton Julian G5 S107  
**BECKTON LANA A401 J** < Beckton Kit L399 HR  
 Beckton Lana U025 LO < Beckton Loki CL S284  
 Beckton Lana S482 CT

BWt	71
WR	122
ADG	4.14
YWt	1188
YR	115
Scr.	37
Fr.	6.0

**DAM**  
 Age 2  
 Wt 885  
 Prog.BW 71  
 WR 122  
 YR 115  
 Wean Pct. 65%  
 Cow Eff. 137

RAAA HerdBuilder index: **159** (Top 4% of all RA bulls)  
 RAAA GridMaster index: **51** (Top 18% of all RA bulls)  
 Calv.Ease BW WW YW Milk HPG Stay Maint.En.  
 EPDs **10.2 -3.3 57.9 88.2 25 13.2 15.8 -2.2**  
 Marb **+.74** REA **+.12** Bfat **+.05**

★★★★★ for Low Maintenance, Growth, Gainability, Marbling, Superior Cow, High Cow Efficiency, Calving Ease, Stayability.

• Bulls •

**16 BECKTON ACCENT C392 N3**  
1-A 100% # 3487562 Tat.: BKT5 C392 

Birth: 3-24-15

Beckton Cody K1 P014  
Beckton Rose M126 WR  
Beckton Cherokee N N479  
Beckton Christy N740 HR  
Beckton Nebula P P707  
Beckton Minerva J615 VG  
Beckton Epic K4 N795  
Beckton Christy L654 JL

**BECKTON ACCENT W180 C2**  
Ref. A-1  
Beckton Christy R046 CQ

**BECKTON CHRISTY Y413 N**  
Beckton Nebula U206 V3  
Beckton Christy S475 EP

**DAM**  
Age 4  
Wt 1190  
Prog.BW 60  
WR 97  
YR 99  
Wean Pct. 48%  
Cow Eff. 100

RAAA HerdBuilder index: **151** (Top 7% of all RA bulls)  
RAAA GridMaster index: **52** (Top 7% of all RA bulls)  
Calv.Ease BW WW YW Milk HPG Stay Maint.En.  
EPDs **14.6 -6.4 53.8 87.9 24 12.9 13.2 1.1**  
Marb **+5.1** REA **+2.2** Bfat **+0.2**

BWt **62**  
WR **99**  
ADG **3.28**  
YWt **1134**  
YR **101**  
Scr. **35**  
Fr. **5.5**

★★★★★ for Low Maintenance, Marbling, Rib-eye area, Calving Ease, Stayability.



**17 BECKTON LIKABLE C550 N4**  
1-A 100% # 3487371 Tat.: BKT5 C550 

Birth: 3-31-15

Beckton Likable U130 L2  
Beckton Kit S478 LN  
Beckton Lancer TA K644  
Beckton Tamara K322 LN  
Beckton Nebula E P084  
Beckton Eola P530 NB  
Beckton Loki C M740  
Beckton Eola J454 JL

**BECKTON LIKABLE Y362 L3**  
Ref. L-3  
Beckton Tamara M515 LN

**BECKTON EOLA U027 NB**  
Beckton Nebula EN S347  
Beckton Eola S317 LO

**DAM**  
Age 7  
Wt 1105  
Prog.BW 66  
WR 112  
YR 107  
Wean Pct. 56%  
Cow Eff. 118

RAAA HerdBuilder index: **143** (Top 11% of all RA bulls)  
RAAA GridMaster index: **52** (Top 5% of all RA bulls)  
Calv.Ease BW WW YW Milk HPG Stay Maint.En.  
EPDs **13.5 -6.2 48.6 78.7 25 11.3 12.6 -2.5**  
Marb **+8.9** REA **+0.0** Bfat **+0.6**

BWt **67**  
WR **104**  
ADG **4.02**  
YWt **1205**  
YR **108**  
Scr. **36**  
Fr. **5.5**

★★★★★ for Low Maintenance, Growth, Gainability, Marbling, Superior Cow, High Cow Efficiency, Calving Ease.

**19 BECKTON WARHAWK C423 J2**  
2 100% # 3487289 Tat.: BKT5 C423 

Birth: 3-25-15

Beckton Warrior T1 H281  
Beckton Warrior TC E801  
Beckton Minerva B609 RN  
Beckton Hadrian A100  
Beckton Firefly H195 HD  
Beckton Firefly C999 CB  
Beckton Julian GJ P535  
Beckton Minola P826 DM  
Beckton Scamp T A825  
Beckton Larkaba D388 SC  
Beckton Larkaba A833 JL

**BECKTON WARHAWK N560**  
Ref. W-1

**BECKTON LARKABA X247 J**

**DAM**  
Age 5  
Wt 1320  
Prog.BW 73  
WR 108  
YR 112  
Wean Pct. 50%  
Cow Eff. 106

RAAA HerdBuilder index: **140** (Top 12% of all RA bulls)  
RAAA GridMaster index: **51** (Top 18% of all RA bulls)  
Calv.Ease BW WW YW Milk HPG Stay Maint.En.  
EPDs **14.8 -6.0 43.5 72.4 17 19.1 10.2 -5.4**  
Marb **+5.2** REA **-0.1** Bfat **+0.2**

BWt **71**  
WR **112**  
ADG **3.68**  
YWt **1213**  
YR **108**  
Scr. **37**  
Fr. **5.0**

★★★★★ for Low Maintenance, Growth, Marbling, Superior Cow, Calving Ease.

**18 BECKTON CLIFFTOP C654 L4**  
1-A 100% # 3487416 Tat.: BKT5 C654 

Birth: 4-7-15

BKT Clifftop TP R288  
Beckton Clifftop T C075  
Beckton Christy K209 CO  
Beckton Epic KM M115  
Beckton Lydia M607 LO  
Beckton Lancer F442 T  
Beckton Tamara G141 HE  
Beckton Cody V E023  
Beckton Vernice C047 JL

**BECKTON CLIFFTOP W692 E3**  
Ref. C-1  
Beckton Lydia S274 EP

**BECKTON VERNICE R374 LN**  
Beckton Lancer T7 M089  
Beckton Vernice K798 CD

**DAM**  
Age 10  
Wt 1230  
Prog.BW 83  
WR 107  
YR 108  
Wean Pct. 61%  
Cow Eff. 128

RAAA HerdBuilder index: **129** (Top 21% of all RA bulls)  
RAAA GridMaster index: **49** (Top 39% of all RA bulls)  
Calv.Ease BW WW YW Milk HPG Stay Maint.En.  
EPDs **6.5 -0.5 65.2 100.3 20 12.1 13.3 -0.2**  
Marb **+5.9** REA **-2.2** Bfat **+0.2**

BWt **83**  
WR **127**  
ADG **3.56**  
YWt **1227**  
YR **109**  
Scr. **39**  
Fr. **5.5**

★★★★★ for Low Maintenance, Growth, Marbling, Superior Cow, High Cow Efficiency, Stayability.

**20 BECKTON WARRIOR C575 J6**  
1-A 100% # 3487190 Tat.: BKT5 C575 

Birth: 4-1-15

Beckton Warrior W534 N4  
Beckton Warrior C1 S337  
BKT Larkeisa S055 NB  
Beckton Epic T330 L5  
Beckton Susan T048 NB  
Beckton Julian G1 J526  
Beckton Rose J725 EP  
Beckton Justice V N656  
Beckton Lana N432 HR

**BECKTON WARRIOR Y108 E5**  
Ref. W-3  
Beckton Susan W058 E

**BECKTON LANA W479 J**  
Beckton Julio L233  
Beckton Lana R121 JC

**DAM**  
Age 6  
Wt 1100  
Prog.BW 65  
WR 101  
YR 104  
Wean Pct. 56%  
Cow Eff. 119

RAAA HerdBuilder index: **163** (Top 3% of all RA bulls)  
RAAA GridMaster index: **52** (Top 8% of all RA bulls)  
Calv.Ease BW WW YW Milk HPG Stay Maint.En.  
EPDs **16.4 -7.3 42.8 73.1 27 14.9 13.6 -5.1**  
Marb **+5.9** REA **-0.6** Bfat **+0.2**

BWt **63**  
WR **100**  
ADG **3.62**  
YWt **1170**  
YR **103**  
Scr. **36**  
Fr. **5.5**

★★★★★ for Low Maintenance, Marbling, High Cow Efficiency, Calving Ease, Stayability.

• Bulls •

**21** **BECKTON JULIAN C669 C6**  
1-A 100% # 3487192 Tat.: BKT5 C669 

Birth: 4-9-15

Beckton Julian G5 S107  
Beckton Julian GJ P535  
Beckton Minola P826 DM  
Beckton Julian GG B571  
Beckton Sufaina P643 JL  
Bkt Sufaina A828 DM

**BECKTON JULIAN X465 J5**  
Ref. J-2

Beckton Cherokee N N479  
BFCK Cherokee Cnyn 4912  
Beckton Dinah C440 NM  
Beckton Copper JT G095  
Beckton Tamara N765 CO  
Beckton Tamara HA54 LN

**BECKTON TAMARA R175 CQ**

DAM	
Age	10
Wt	1115
Prog.BW	72
WR	109
YR	107
Wean Pct.	60%
Cow Eff.	125

RAAA HerdBuilder index: **137**(Top **14%** of all RA bulls)  
RAAA GridMaster index: **50**(Top **21%** of all RA bulls)  
Calv.Ease BW WW YW Milk HPG Stay Maint.En.  
EPDs **8.6 -1.8 58.6 93.1 22 14.6 13.5 -5.4**  
Marb **+0.73** REA **+0.06** Bfat **+0.04**

BWt **85**  
WR **112**  
ADG **3.68**  
YWt **1258**  
YR **112**  
Scr. **39**  
Fr. **5.5**

★★★★★ for Low Maintenance, Growth, Marbling, Superior Cow, High Cow Efficiency, Calving Ease, Stayability.



**22** **BECKTON NEBULA C282 N3**  
1-A 100% # 3487300 Tat.: BKT5 C282 

Birth: 3-19-15

Beckton Nebula M045  
Beckton Neptune R2 K065  
Beckton Belga K285 JL  
Beckton Epic K F075  
BKT Pine Marie M119 EP  
Bkt Pine Marie D126 JL

**BECKTON NEBULA E P084**  
Ref. N

Beckton Nebula U206 V3  
Beckton Nebula P P707  
Beckton Minerva J615 VG  
Beckton Nebula P P707  
Beckton Minerva F495 CH

**BECKTON MINERVA X047 N**

DAM	
Age	5
Wt	1190
Prog.BW	65
WR	101
YR	98
Wean Pct.	53%
Cow Eff.	111

RAAA HerdBuilder index: **177** (Top **1%** of all RA bulls)  
RAAA GridMaster index: **52** (Top **8%** of all RA bulls)  
Calv.Ease BW WW YW Milk HPG Stay Maint.En.  
EPDs **14.8 -6.9 51.3 77.2 20 11.8 16.1 -5.7**  
Marb **+0.83** REA **-0.11** Bfat **+0.04**

BWt **68**  
WR **105**  
ADG **3.51**  
YWt **1148**  
YR **102**  
Scr. **36**  
Fr. **5.0**

★★★★★ for Low Maintenance, Marbling, Calving Ease, Stayability.

**24** **BECKTON SCAMP C457 W4**  
1-A 100% # 3487422 Tat.: BKT5 C457 

Birth: 3-24-15

Beckton Scamp T A825  
Beckton Scamp 8954  
Bkt Encino 8459 TJ  
Beckton Hustler C2 L079  
BKT Pine Marie R401 HU  
Bkt Pine Marie LC30 CD

**BECKTON SCAMP X458 H3**  
Ref. S-1

Beckton Warhawk N560  
Beckton Warrior T1 H281  
Beckton Firefly H195 HD  
Beckton Herald FJ J776  
Beckton Larkaba N394 HR  
Beckton Larkaba F136 LN

**BECKTON LARKABA R011 WA**

DAM	
Age	10
Wt	1185
Prog.BW	64
WR	106
YR	105
Wean Pct.	50%
Cow Eff.	105

RAAA HerdBuilder index: **140**(Top **13%** of all RA bulls)  
RAAA GridMaster index: **51**(Top **14%** of all RA bulls)  
Calv.Ease BW WW YW Milk HPG Stay Maint.En.  
EPDs **16 -7.4 52.1 87.1 18 15.2 9.9 -4.4**  
Marb **+0.25** REA **+0.02** Bfat **+0.01**

BWt **61**  
WR **100**  
ADG **4.25**  
YWt **1223**  
YR **109**  
Scr. **33**  
Fr. **6.0**

★★★★★ for Low Maintenance, Growth, Gainability, Marbling, Superior Cow, Calving Ease.

**23** **BECKTON SCAMP C637 E4**  
1-A 100% # 3487277 Tat.: BKT5 C637 

Birth: 4-6-15

Beckton Scamp T A825  
Beckton Scamp 8954  
Bkt Encino 8459 TJ  
Beckton Epic KH P678  
Beckton Lana S074 EP  
Beckton Lana P317 JL

**BECKTON SCAMP X494 E3**  
Ref. S-2

Beckton Epic T330 L5  
Beckton Epic K4 N795  
Beckton Belga K202 LN  
Beckton Justice G302  
Beckton Coca R490 JC  
Beckton Coca M637 LO

**BECKTON COCA X517 E**

DAM	
Age	5
Wt	1010
Prog.BW	74
WR	109
YR	111
Wean Pct.	60%
Cow Eff.	127

RAAA HerdBuilder index: **116**(Top **35%** of all RA bulls)  
RAAA GridMaster index: **50**(Top **32%** of all RA bulls)  
Calv.Ease BW WW YW Milk HPG Stay Maint.En.  
EPDs **12.7 -4.9 45.3 78.6 24 12 9.6 -4.7**  
Marb **+0.26** REA **+0.00** Bfat **+0.01**

BWt **85**  
WR **102**  
ADG **4.25**  
YWt **1189**  
YR **106**  
Scr. **35**  
Fr. **5.5**

★★★★★ for Low Maintenance, Growth, Gainability, Marbling, Superior Cow, High Cow Efficiency, Calving Ease.

**25** **BECKTON SCAMP C541 C4**  
1-A 100% # 3487883 Tat.: BSF5 C541 

Birth: 3-30-15

Beckton Scamp T A825  
Beckton Scamp 8954  
Bkt Encino 8459 TJ  
Beckton Epic KH P678  
Beckton Lana S074 EP  
Beckton Lana P317 JL

**BECKTON SCAMP X494 E3**  
Ref. S-2

Beckton Cherokee N N479  
BFCK Cherokee Cnyn 4912  
Beckton Dinah C440 NM  
Beckton Hustler C2 L079  
Beckton Mona N342 HU  
Beckton Mona L890 CO

**BECKTON MONA R166 CQ**

DAM	
Age	10
Wt	1250
Prog.BW	72
WR	101
YR	102
Wean Pct.	46%
Cow Eff.	97

RAAA HerdBuilder index: **114**(Top **36%** of all RA bulls)  
RAAA GridMaster index: **49**(Top **43%** of all RA bulls)  
Calv.Ease BW WW YW Milk HPG Stay Maint.En.  
EPDs **9.6 -3.7 49.9 77 22 12.6 10.8 -5.3**  
Marb **+0.32** REA **+0.02** Bfat **-0.02**

BWt **83**  
WR **98**  
ADG **3.97**  
YWt **1155**  
YR **103**  
Scr. **36**  
Fr. **6.0**

★★★★★ for Low Maintenance, Marbling, Calving Ease.



• Bulls •



**26 BECKTON ACCENT C497 J3**  
1-A 100% # 3487301 Tat.: BKT5 C497

Birth: 3-28-15

Beckton Cody K1 P014  
Beckton Rose M126 WR  
Beckton Cherokee N N479  
Beckton Christy N740 HR  
Beckton Jet L P491  
Beckton Lydia N047 LM  
Beckton Jet L P491  
Beckton Ruth P591 LN

**BECKTON ACCENT W180 C2**  
Ref. A-1  
Beckton Christy R046 CQ

**BECKTON RUTH X041 J**  
Beckton Jet U473 L2  
Beckton Ruth U557 JT

**DAM**  
Age 5  
Wt 1225  
Prog.BW 75  
WR 105  
YR 103  
Wean Pct. 49%  
Cow Eff. 103

RAAA HerdBuilder index: **151** (Top 7% of all RA bulls)  
RAAA GridMaster index: **51** (Top 15% of all RA bulls)  
Calv.Ease BW WW YW Milk HPG Stay Maint.En.  
EPDs **9.9 -2.4 57.4 91.2 27 12.5 14.6 -1.1**  
Marb **+0.63** REA **+1.17** Bfat **+0.00**

BWt **81**  
WR **101**  
ADG **3.33**  
YWt. **1186**  
YR **106**  
Scr. **39**  
Fr. **6.5**

★★★★★ for Low Maintenance, Growth, Marbling, Rib-eye area, Calving Ease, Stayability.

**27 BECKTON NEW ERA C718 C2**  
1-A 100% # 3487838 Tat.: BSF5 C718

Birth: 4-15-15

Beckton Nebula P P707  
Beckton Nebula M045  
Beckton Lana M809 EP  
Beckton Justice C1 R483  
BKT Larkeisa T310 JC  
BKT Larkeisa R775 JC  
Bkt Clifftop TV G672  
Beckton Lana J384 CD  
Beckton Justice C K449  
Beckton Lana G032 HD

**BECKTON NEW ERA Y194**  
Ref. N-4

**BECKTON LANA U456 CT**  
Beckton Clifftop T3 N800  
Beckton Lana R254 JC

**DAM**  
Age 7  
Wt 1010  
Prog.BW 73  
WR 107  
YR 107  
Wean Pct. 63%  
Cow Eff. 132

RAAA HerdBuilder index: **133** (Top 17% of all RA bulls)  
RAAA GridMaster index: **51** (Top 14% of all RA bulls)  
Calv.Ease BW WW YW Milk HPG Stay Maint.En.  
EPDs **10.8 -2.1 62.1 104.2 23 10.6 12.4 -4.6**  
Marb **+0.59** REA **-0.13** Bfat **+0.02**

BWt **84**  
WR **103**  
ADG **4.15**  
YWt. **1222**  
YR **108**  
Scr. **38**  
Fr. **5.5**

★★★★★ for Low Maintenance, Growth, Gainability, Marbling, Superior Cow, High Cow Efficiency, Calving Ease.

**29 BECKTON JULIAN C802 N6**  
1-A 100% # 3487564 Tat.: BKT5 C802

Birth: 4-28-15

Beckton Julian G5 S107  
Beckton Julian GJ P535  
Beckton Minola P826 DM  
Beckton Julian GG B571  
Beckton Suffeina P643 JL  
Bkt Suffeina A828 DM  
Beckton Nebula T054 H3  
BKT Suffeina T110 EM  
Beckton Julio L233  
Beckton Larkeisa N897 HR

**BECKTON JULIAN X465 J5**  
Ref. J-2

**BECKTON LARKEISA Y389 N**  
Beckton Nebula W040 E4  
Beckton Larkeisa W770 J

**DAM**  
Age 4  
Wt 975  
Prog.BW 69  
WR 114  
YR 109  
Wean Pct. 70%  
Cow Eff. 147

RAAA HerdBuilder index: **142** (Top 11% of all RA bulls)  
RAAA GridMaster index: **52** (Top 6% of all RA bulls)  
Calv.Ease BW WW YW Milk HPG Stay Maint.En.  
EPDs **10.9 -2.9 61.8 104.5 18 14.3 12.1 -6.2**  
Marb **+0.69** REA **-0.04** Bfat **+0.02**

BWt **77**  
WR **119**  
ADG **3.92**  
YWt. **1303**  
YR **116**  
Scr. **38**  
Fr. **6.5**

★★★★★ for Low Maintenance, Growth, Marbling, Superior Cow, High Cow Efficiency, Calving Ease.

**28 BECKTON HERITAGE C701 C4**  
1-A 100% # 3487993 Tat.: BSF5 C701

Birth: 4-14-15

Beckton Heritage T270 J2  
Beckton Heritage N013  
Beckton Coca P602 JL  
Beckton Lancer TE F363  
Beckton Indigo H150 LN  
Beckton Indigo F376 CT  
BKT Clifftop TP R288  
BKT Pine Marie R213 EP  
Beckton Herald FV J537  
Beckton Barmaid J012 CO

**BECKTON HERITAGE X403 L3**  
Ref. H-1

**BECKTON BARMAID Z227 C**  
Beckton Clifftop W577 E3  
Beckton Barmaid P323 HR

**DAM**  
Age 3  
Wt 1025  
Prog.BW 64  
WR 115  
YR 107  
Wean Pct. 66%  
Cow Eff. 139

RAAA HerdBuilder index: **148** (Top 8% of all RA bulls)  
RAAA GridMaster index: **51** (Top 19% of all RA bulls)  
Calv.Ease BW WW YW Milk HPG Stay Maint.En.  
EPDs **10.9 -3.5 64.4 96.4 24 11.9 13.9 -3.8**  
Marb **+0.74** REA **-0.08** Bfat **+0.06**

BWt **71**  
WR **125**  
ADG **3.64**  
YWt. **1255**  
YR **114**  
Scr. **36**  
Fr. **5.5**

★★★★★ for Low Maintenance, Growth, Marbling, Superior Cow, High Cow Efficiency, Calving Ease, Stayability.

**30 BECKTON EPIC C151 D8**  
1-A 100% # 3487953 Tat.: BSF5 C151

Birth: 3-7-15

Beckton Epic X330 L6  
Beckton Epic T330 L5  
Beckton Kit R503 LN  
Beckton Nebula T252 L3  
Beckton Lana T226 NB  
Beckton Dominor Z1 R610  
Beckton Mona R166 CQ  
Beckton Nebula PJ S543  
Beckton Minerva S839 HW

**BECKTON EPIC A587 N7**  
Ref. E-7

**BECKTON MINERVA A560 D**  
Beckton Dominor W640 C5  
Beckton Minerva U313 NB

**DAM**  
Age 2  
Wt 960  
Prog.BW 67  
WR 109  
YR 113  
Wean Pct. 53%  
Cow Eff. 111

RAAA HerdBuilder index: **161** (Top 4% of all RA bulls)  
RAAA GridMaster index: **51** (Top 13% of all RA bulls)  
Calv.Ease BW WW YW Milk HPG Stay Maint.En.  
EPDs **10.2 -2.9 62 101.9 15 11.7 15.4 -1.8**  
Marb **+0.53** REA **+0.01** Bfat **+0.01**

BWt **67**  
WR **109**  
ADG **4.08**  
YWt. **1161**  
YR **113**  
Scr. **36**  
Fr. **6.0**

★★★★★ for Low Maintenance, Growth, Gainability, Marbling, Superior Cow, Calving Ease, Stayability.

• Bulls •

**31 BECKTON EMPEROR C532 N5**  
1-A 100% # 3487982 Tat.: BSF5 C532 

Birth: 3-30-15

Beckton Emperor Y459 J3	Beckton Emperor T641 E2	BWT <b>70</b>
Beckton Minola Y634 W	Beckton Indigo S354 JT	
Beckton Nebula W486 D3	Beckton Warrior U636 J5	ADG <b>3.97</b>
Beckton Coca U616 EP	Beckton Minola S103 JL	YWT <b>1151</b>
	Beckton Nebula L P093	YR <b>112</b>
	Beckton Belga R716 DM	Scr. <b>36</b>
	Beckton Epic K4 N795	Fr. <b>5.5</b>
	Beckton Coca P713 NP	

**BECKTON EMPEROR A165 W4**  
Ref. E-5

**BECKTON COCA A341 N**

**DAM**  
Age 2  
Wt 1000  
Prog.BW 88  
WR 109  
YR 112  
Wean Pct. 53%  
Cow Eff. 111

RAAA HerdBuilder index: **156** (Top 5% of all RA bulls)  
RAAA GridMaster index: **52** (Top 5% of all RA bulls)

Calv.Ease	BW	WW	YW	Milk	HPG	Stay	Maint.En.
EPDs <b>11.8</b>	<b>-3.5</b>	<b>61</b>	<b>100.5</b>	<b>15</b>	<b>9.6</b>	<b>14.2</b>	<b>-2.1</b>
Marb <b>+0.72</b>	REA <b>-0.01</b>	Bfat <b>+0.00</b>					

★★★★★ for Low Maintenance, Growth, Marbling, Superior Cow, Calving Ease, Stayability.



**32 BECKTON ACCENT C592 C3**  
1-A 100% # 3487235 Tat.: BKT5 C592 

Birth: 4-2-15

Beckton Cody K1 P014	Beckton Cody KH M390	BWT <b>66</b>
Beckton Cherokee N N479	Beckton Rose M126 WR	
Beckton Christy R046 CQ	Beckton Christy N740 HR	ADG <b>4.08</b>
Beckton Clifftop W692 E3	BKT Clifftop TP R288	YWT <b>1172</b>
Beckton Lydia S274 EP	Beckton Epic K4 N795	YR <b>110</b>
Beckton Christy S475 EP	Beckton Christy L654 JL	Scr. <b>35</b>
		Fr. <b>5.5</b>

**BECKTON ACCENT W180 C2**  
Ref. A-1

**BECKTON CHRISTY Z587 C**

**DAM**  
Age 3  
Wt NA  
Prog.BW 66  
WR 109  
YR 110  
Wean Pct. NA%  
Cow Eff. NA

RAAA HerdBuilder index: **150** (Top 7% of all RA bulls)  
RAAA GridMaster index: **52** (Top 6% of all RA bulls)

Calv.Ease	BW	WW	YW	Milk	HPG	Stay	Maint.En.
EPDs <b>13.3</b>	<b>-5.1</b>	<b>59.8</b>	<b>99.9</b>	<b>25</b>	<b>13.4</b>	<b>12.9</b>	<b>0.9</b>
Marb <b>+0.57</b>	REA <b>+0.17</b>	Bfat <b>+0.05</b>					

★★★★★ for Low Maintenance, Growth, Gainability, Marbling, Rib-eye area, Superior Cow, Calving Ease.

**34 BSF HERITAGE C377 L4**  
1-B 99% # 3487890 Tat.: BSF5 C377 

Birth: 3-24-15

Beckton Heritage T270 J2	Beckton Heritage N013	BWT <b>82</b>
Beckton Indigo H150 LN	Beckton Coca P602 JL	
Beckton Lancer T1 H080	Beckton Lancer TE F363	ADG <b>4.83</b>
BSF Regus B368	Beckton Indigo F376 CT	YWT <b>1373</b>
	Beckton Lancer TN F726	YR <b>123</b>
	Beckton Belga F657 TP	Scr. <b>37</b>
	Beckton Nomad V 9871	Fr. <b>6.0</b>
	BSF Red 8101	

**BECKTON HERITAGE X403 L3**  
Ref. H-1

**BSF LANETTE P497**

**DAM**  
Age 11  
Wt 1230  
Prog.BW 80  
WR 120  
YR 115  
Wean Pct. 54%  
Cow Eff. 113

RAAA HerdBuilder index: **101** (Top 55% of all RA bulls)  
RAAA GridMaster index: **50** (Top 35% of all RA bulls)

Calv.Ease	BW	WW	YW	Milk	HPG	Stay	Maint.En.
EPDs <b>8</b>	<b>-1.4</b>	<b>65</b>	<b>98</b>	<b>26</b>	<b>10.3</b>	<b>9.8</b>	<b>0.3</b>
Marb <b>+0.56</b>	REA <b>+0.03</b>	Bfat <b>+0.03</b>					

★★★★★ for Low Maintenance, Growth, Gainability, Marbling, Superior Cow, Calving Ease.

**33 BECKTON NEBULA C129 N5**  
1-A 100% # 3487474 Tat.: BKT5 C129 

Birth: 3-4-15

Beckton Nebula T398 V3	Beckton Nebula L P093	BWT <b>66</b>
Beckton Mona X022 L	Beckton Minerva J615 VG	
Beckton Nebula T398 V3	Beckton Likable U130 L2	ADG <b>4.02</b>
Beckton Freyja T147 HI	Beckton Mona U584 CD	YWT <b>1116</b>
	Beckton Nebula L P093	YR <b>108</b>
	Beckton Minerva J615 VG	Scr. <b>38</b>
	Beckton Hilltop R157	Fr. <b>5.5</b>
	Beckton Freyja R417 HU	

**BECKTON NEBULA A773 L4**  
Ref. N-6

**BECKTON FREYJA A681 N**

**DAM**  
Age 2  
Wt 870  
Prog.BW 66  
WR 100  
YR 108  
Wean Pct. 53%  
Cow Eff. 112

RAAA HerdBuilder index: **159** (Top 4% of all RA bulls)  
RAAA GridMaster index: **51** (Top 17% of all RA bulls)

Calv.Ease	BW	WW	YW	Milk	HPG	Stay	Maint.En.
EPDs <b>10.1</b>	<b>-3.6</b>	<b>59.4</b>	<b>94.8</b>	<b>19</b>	<b>10.5</b>	<b>15.7</b>	<b>-4.7</b>
Marb <b>+0.47</b>	REA <b>+0.04</b>	Bfat <b>+0.00</b>					

★★★★★ for Low Maintenance, Growth, Gainability, Marbling, Calving Ease, Stayability.

**35 BSF ACCENT C228 L3**  
1-B 99% # 3487852 Tat.: BSF5 C228 

Birth: 3-16-15

Beckton Cody K1 P014	Beckton Cody KH M390	BWT <b>71</b>
Beckton Christy R046 CQ	Beckton Rose M126 WR	
Beckton Loki CL S284	Beckton Cherokee N N479	ADG <b>3.91</b>
BSF Hustelle S375 HU	Beckton Christy N740 HR	YWT <b>1291</b>
	Beckton Loki C M740	YR <b>115</b>
	Beckton Lakme J460 LT	Scr. <b>37</b>
	Beckton Hustler C2 L079	Fr. <b>6.0</b>
	BSF Regus M508 LN	

**BECKTON ACCENT W180 C2**  
Ref. A-1

**BSF HUSTELLE U113 LO**

**DAM**  
Age 7  
Wt 1160  
Prog.BW 62  
WR 104  
YR 107  
Wean Pct. 58%  
Cow Eff. 123

RAAA HerdBuilder index: **154** (Top 6% of all RA bulls)  
RAAA GridMaster index: **53** (Top 4% of all RA bulls)

Calv.Ease	BW	WW	YW	Milk	HPG	Stay	Maint.En.
EPDs <b>13.5</b>	<b>-5.0</b>	<b>67.3</b>	<b>111.2</b>	<b>21</b>	<b>12.1</b>	<b>13.2</b>	<b>-0.5</b>
Marb <b>+0.48</b>	REA <b>+0.28</b>	Bfat <b>+0.03</b>					

★★★★★ for Low Maintenance, Growth, Marbling, Rib-eye area, Superior Cow, High Cow Efficiency, Calving Ease, Stayability.

• Bulls •

**36** **BSF SCAMP C348 J4** 

1-B 99% # 3487868 Tat.: BSF5 C348

Birth: 3-22-15

Beckton Scamp T A825  
**BECKTON SCAMP X494 E3**  
 Ref. S-2 Beckton Lana S074 EP

Beckton Justice G302  
**BSF BUFFIE S394 JC**  
 BSF Buffie N856 CO

Beckton Scamp 8954  
 Bkt Encino 8459 TJ  
 Beckton Epic KH P678  
 Beckton Lana P317 JL  
 Beckton Julian GG B571  
 Bkt Vernice 9733 PC  
 Beckton Copper JT G095  
 BSF Regus F207

BWt **87**  
 WR **113**  
 ADG **5.00**  
 YWt **1340**  
 YR **120**  
 Scr. **38**  
 Fr. **6.0**

**DAM**  
 Age 9  
 Wt 1260  
 Prog.BW 80  
 WR 104  
 YR 107  
 Wean Pct. 53%  
 Cow Eff. 112

RAAA HerdBuilder index: **122**(Top **28%** of all RA bulls)  
 RAAA GridMaster index: **49**(Top **41%** of all RA bulls)  
 Calv.Ease BW WW YW Milk HPG Stay Maint.En.  
 EPDs **8.8 -1.8 63.5 100.5 19 12.7 11.1 -5.4**  
 Marb **+0.26** REA **+0.23** Bfat **+0.02**

★★★★★ for Low Maintenance, Growth, Gainability, Marbling, Rib-eye area, Superior Cow, Calving Ease.

**39** **BECKTON EMPEROR C435 J4** 

1-B 99% # 3487859 Tat.: BSF5 C435

Birth: 3-26-15

Beckton Emperor T641 E2  
**BECKTON EMPEROR Y459 J3**  
 Ref. E-3 Beckton Indigo S354 JT

Beckton Julio L233  
**BSF JULIA T623 JO**  
 BSF Regus M006 NP

Beckton Emperor R100  
 Beckton Vernice R416 EP  
 Beckton Jet L P491  
 Beckton Indigo P676 LN  
 Beckton Julian G1 J526  
 Beckton Rose J725 EP  
 Beckton Neptune R2 K065  
 BSF Regus K326 WH

BWt **87**  
 WR **117**  
 ADG **3.68**  
 YWt **1255**  
 YR **112**  
 Scr. **38**  
 Fr. **5.5**

**DAM**  
 Age 8  
 Wt 1230  
 Prog.BW 73  
 WR 112  
 YR 111  
 Wean Pct. 56%  
 Cow Eff. 118

RAAA HerdBuilder index: **132**(Top **18%** of all RA bulls)  
 RAAA GridMaster index: **51**(Top **12%** of all RA bulls)  
 Calv.Ease BW WW YW Milk HPG Stay Maint.En.  
 EPDs **11.6 -3.7 57.1 91.9 19 11.3 11.6 -6.6**  
 Marb **+0.59** REA **+0.12** Bfat **+0.01**

★★★★★ for Low Maintenance, Growth, Marbling, Superior Cow, High Cow Efficiency, Calving Ease.

**37** **BSF ACCENT C667 L3** 

1-B 99% # 3487176 Tat.: BKB5 C667

Birth: 4-9-15

Beckton Cody K1 P014  
**BECKTON ACCENT W180 C2**  
 Ref. A-1 Beckton Christy R046 CQ

Beckton Laser N602  
**BSF JULIA X752 L**  
 BSF Julia T175 JO

Beckton Cody KH M390  
 Beckton Rose M126 WR  
 Beckton Cherokee N N479  
 Beckton Christy N740 HR  
 Beckton Lancer F442 T  
 Beckton Minola E589 TO  
 Beckton Julio L233  
 BSF Regus M604 LN

BWt **70**  
 WR **114**  
 ADG **4.08**  
 YWt **1314**  
 YR **117**  
 Scr. **37**  
 Fr. **5.5**

**DAM**  
 Age 5  
 Wt 1145  
 Prog.BW 68  
 WR 108  
 YR 106  
 Wean Pct. 59%  
 Cow Eff. 124

RAAA HerdBuilder index: **149** (Top **8%** of all RA bulls)  
 RAAA GridMaster index: **52** (Top **4%** of all RA bulls)  
 Calv.Ease BW WW YW Milk HPG Stay Maint.En.  
 EPDs **12.6 -4.7 63.9 106 25 12.7 13 -2.2**  
 Marb **+0.50** REA **+0.39** Bfat **+0.02**

★★★★★ for Low Maintenance, Growth, Gainability, Marbling, Rib-eye area, Superior Cow, High Cow Efficiency, Calving Ease, Stayability.

**40** **BSF SCAMP C316 L4** 

1-B 99% # 3487875 Tat.: BSF5 C316

Birth: 3-21-15

Beckton Scamp T A825  
**BECKTON SCAMP X458 H3**  
 Ref. S-1 BKT Pine Marie R401 HU

Beckton Lancer T7 M089  
**BSF LANETTE R748 LN**  
 BSF Red Roan L823 LN

Beckton Scamp 8954  
 Bkt Encino 8459 TJ  
 Beckton Hustler C2 L079  
 Bkt Pine Marie LC30 CD  
 Beckton Lancer F442 T  
 Beckton Tamara G141 HE  
 Beckton Lancer TL G626  
 BSF Regus F207

BWt **81**  
 WR **104**  
 ADG **4.14**  
 YWt **1234**  
 YR **110**  
 Scr. **32**  
 Fr. **6.0**

**DAM**  
 Age 10  
 Wt 1240  
 Prog.BW 72  
 WR 107  
 YR 108  
 Wean Pct. 50%  
 Cow Eff. 104

RAAA HerdBuilder index: **116**(Top **35%** of all RA bulls)  
 RAAA GridMaster index: **50**(Top **33%** of all RA bulls)  
 Calv.Ease BW WW YW Milk HPG Stay Maint.En.  
 EPDs **9.7 -2.8 58.2 94.8 18 10.4 10.5 -3.5**  
 Marb **+0.20** REA **+0.14** Bfat **-0.02**

★★★★★ for Low Maintenance, Growth, Gainability, Marbling, Rib-eye area, Superior Cow, Calving Ease.

**38** **BSF JANUS C304 C3** 

1-B 99% # 3487179 Tat.: BKB5 C304

Birth: 3-20-15

Beckton Roman J S158  
**BECKTON JANUS X799 L2**  
 Ref. J-3 Beckton Sierra K557 LO

Beckton Cherokee N N479  
**BSF HUSTELLE T531 CQ**  
 BSF Hustle P246

TR Romeo NT379  
 Beckton Belga K285 JL  
 Beckton Loki F251  
 Beckton Sierra C157 CL  
 BFCK Cherokee Cnyn 4912  
 Beckton Dinah C440 NM  
 Beckton Hustler C2 L079  
 BSF Regus E323

BWt **77**  
 WR **108**  
 ADG **3.97**  
 YWt **1245**  
 YR **111**  
 Scr. **35**  
 Fr. **6.0**

**DAM**  
 Age 8  
 Wt 1135  
 Prog.BW 68  
 WR 107  
 YR 105  
 Wean Pct. 57%  
 Cow Eff. 119

RAAA HerdBuilder index: **118**(Top **31%** of all RA bulls)  
 RAAA GridMaster index: **50**(Top **33%** of all RA bulls)  
 Calv.Ease BW WW YW Milk HPG Stay Maint.En.  
 EPDs **11.5 -3.5 57.2 89 28 10.9 11 1.3**  
 Marb **+0.29** REA **+0.24** Bfat **+0.00**

★★★★★ for Low Maintenance, Growth, Marbling, Rib-eye area, Superior Cow, High Cow Efficiency, Calving Ease.

**41** **BSF JANUS C610 L3** 

1-B 99% # 3487770 Tat.: BSF5 C610

Birth: 4-4-15

Beckton Roman J S158  
**BECKTON JANUS X799 L2**  
 Ref. J-3 Beckton Sierra K557 LO

Beckton Legend S670  
**BSF JULIANNE X510 L**  
 BSF Julianne R707 JL

TR Romeo NT379  
 Beckton Belga K285 JL  
 Beckton Loki F251  
 Beckton Sierra C157 CL  
 Beckton Lancer F442 T  
 Beckton Kit F468 JL  
 Beckton Julian G1 J526  
 BSF Regus L568 LN

BWt **77**  
 WR **113**  
 ADG **3.85**  
 YWt **1250**  
 YR **112**  
 Scr. **36**  
 Fr. **6.5**

**DAM**  
 Age 5  
 Wt 1145  
 Prog.BW 64  
 WR 109  
 YR 107  
 Wean Pct. 58%  
 Cow Eff. 123

RAAA HerdBuilder index: **126**(Top **23%** of all RA bulls)  
 RAAA GridMaster index: **52** (Top **8%** of all RA bulls)  
 Calv.Ease BW WW YW Milk HPG Stay Maint.En.  
 EPDs **12.1 -4.2 60 92.7 24 9.4 11.1 -0.6**  
 Marb **+0.57** REA **+0.39** Bfat **-0.01**

★★★★★ for Low Maintenance, Growth, Marbling, Rib-eye area, Superior Cow, High Cow Efficiency, Calving Ease.



• Bulls •



Lot 42

**44** **BSF EPIC C624 W6** 

1-B 99% # 3487736 Tat.: BSF5 C624

Birth: 4-5-15

Beckton Epic U749 D5  
**BECKTON EPIC Y484 N6**  
 Ref. E-4  
 Beckton Lydia S069 NB

Beckton Epic K4 N795  
 Beckton Denise R308 DM  
 Beckton Nebula P P707  
 Beckton Lydia P583 WR  
 Beckton Warrior N645 T1  
 Beckton Lydia H159 JL  
 Beckton Cody K1 P014  
 BSF Regus H501

**BSF CODETTE Y525 W**  
 BSF Codette U826 CD

**DAM**  
 Age 4  
 Wt 1015  
 Prog. BW 60  
 WR 103  
 YR 105  
 Wean Pct. 62%  
 Cow Eff. 131

RAAA HerdBuilder index: **152** (Top 6% of all RA bulls)  
 RAAA GridMaster index: **52** (Top 6% of all RA bulls)

Calv. Ease	BW	WW	YW	Milk	HPG	Stay	Maint. En.
EPDs <b>13.4</b>	<b>-4.6</b>	<b>57.6</b>	<b>94.9</b>	<b>19</b>	<b>13.1</b>	<b>12.8</b>	<b>-3.4</b>

Marb **+0.55** REA **+0.34** Bfat **+0.01**

BWT **70**  
 WR **110**  
 ADG **4.02**  
 YWt. **1208**  
 YR **108**  
 Scr. **37**  
 Fr. **6.0**

★★★★★ for Low Maintenance, Growth, Gainability, Marbling, Rib-eye area, High Cow Efficiency, Calving Ease.

**42** **BSF EMPEROR C051 W5** 

99% # un-reg Tat.: BSF5 C051

Birth: 2-23-15

Beckton Emperor Y459 J3  
**BECKTON EMPEROR A165 W4**  
 Ref. E-5  
 Beckton Minola Y634 W

Beckton Emperor T641 E2  
 Beckton Indigo S354 JT  
 Beckton Warrior U636 J5  
 Beckton Minola S103 JL  
 Beckton Warrior W534 N4  
 Beckton Susan W058 E  
 Beckton Clifftop U575 H3  
 BSF Nebulann P046

**BSF NEBULANN A707 W**  
 BSF Nebulann Y213 C

**DAM**  
 Age 2  
 Wt 760  
 Prog. BW 69  
 WR 116  
 YR 113  
 Wean Pct. 72%  
 Cow Eff. 151

RAAA HerdBuilder index: (Top 2% of all RA bulls)  
 RAAA GridMaster index: (Top 2% of all RA bulls)

Calv. Ease	BW	WW	YW	Milk	HPG	Stay	Maint. En.
EPDs <b>14.4</b>	<b>-5.4</b>	<b>43.9</b>	<b>75.2</b>	<b>17.9</b>	<b>11.2</b>	<b>14</b>	<b>-2.0</b>

Marb **+0.68** REA **+0.12** Bfat **+0.02**

BWT **69**  
 WR **116**  
 ADG **3.51**  
 YWt. **1169**  
 YR **113**  
 Scr. **37**  
 Fr. **5.5**

★★★★★ for Low Maintenance, Growth, Marbling, Superior Cow, High Cow Efficiency, Calving Ease, Stayability.

**45** **BECKTON NEBULA C416 E5** 

1-A 100% # 3487650 Tat.: BSF5 C416

Birth: 3-25-15

Beckton Nebula U206 V3  
**BECKTON NEBULA X096 N4**  
 Ref. N-3  
 Beckton Tamara U185 NB

Beckton Nebula P P707  
 Beckton Minerva J615 VG  
 Beckton Nebula P P707  
 Beckton Tamara P813 CH  
 Beckton Epic K F075  
 Beckton Minerva F495 CH  
 Beckton Lancer TS D390  
 Beckton Minola D494 SC

**BECKTON MINOLA S464 EP**  
 Beckton Minola J409 LN

**DAM**  
 Age 9  
 Wt 1230  
 Prog. BW 75  
 WR 107  
 YR 105  
 Wean Pct. 51%  
 Cow Eff. 107

RAAA HerdBuilder index: **154** (Top 6% of all RA bulls)  
 RAAA GridMaster index: **50** (Top 29% of all RA bulls)

Calv. Ease	BW	WW	YW	Milk	HPG	Stay	Maint. En.
EPDs <b>8.8</b>	<b>-1.5</b>	<b>66.6</b>	<b>101.6</b>	<b>23</b>	<b>11.5</b>	<b>15.7</b>	<b>1.4</b>

Marb **+0.49** REA **-0.02** Bfat **+0.00**

BWT **79**  
 WR **106**  
 ADG **4.14**  
 YWt. **1203**  
 YR **107**  
 Scr. **39**  
 Fr. **5.0**

★★★★★ for Low Maintenance, Growth, Gainability, Marbling, Superior Cow, Calving Ease, Stayability.

**43** **BSF NEBULA C384 W5** 

1-B 99% # 3487834 Tat.: BSF5 C384

Birth: 3-24-15

Beckton Nebula U206 V3  
**BECKTON NEBULA X096 N4**  
 Ref. N-3  
 Beckton Tamara U185 NB

Beckton Nebula P P707  
 Beckton Minerva J615 VG  
 Beckton Nebula P P707  
 Beckton Tamara P813 CH  
 Beckton Warrior T1 H281  
 Beckton Rose H074 EP  
 Beckton Julian G1 J526  
 BSF Regus KA43 TZ

**BSF JULIANNE U532 WR**  
 BSF Julianne R692 JL

**DAM**  
 Age 7  
 Wt 1210  
 Prog. BW 62  
 WR 102  
 YR 102  
 Wean Pct. 53%  
 Cow Eff. 111

RAAA HerdBuilder index: **155** (Top 5% of all RA bulls)  
 RAAA GridMaster index: **51** (Top 19% of all RA bulls)

Calv. Ease	BW	WW	YW	Milk	HPG	Stay	Maint. En.
EPDs <b>11.5</b>	<b>-4.0</b>	<b>68.3</b>	<b>108.1</b>	<b>16</b>	<b>13.5</b>	<b>14.2</b>	<b>-0.8</b>

Marb **+0.30** REA **-0.08** Bfat **+0.00**

BWT **68**  
 WR **108**  
 ADG **3.51**  
 YWt. **1192**  
 YR **106**  
 Scr. **36**  
 Fr. **5.5**

★★★★★ for Low Maintenance, Growth, Marbling, Calving Ease, Stayability.

**46** **BECKTON SCAMP C660 E4** 

1-A 100% # 3487360 Tat.: BKT5 C660

Birth: 4-8-15

Beckton Scamp T A825  
**BECKTON SCAMP X458 H3**  
 Ref. S-1  
 BKT Pine Marie R401 HU

Beckton Scamp 8954  
 Bkt Encino 8459 TJ  
 Beckton Hustler C2 L079  
 Bkt Pine Marie LC30 CD  
 Beckton Epic K F075  
 Beckton Larkaba E042 CD  
 Beckton Colt K M609  
 Beckton Larkaba J649 CR

**BECKTON LARKABA U498 EP**  
 Beckton Larkaba R336 CK

**DAM**  
 Age 7  
 Wt 1230  
 Prog. BW 74  
 WR 111  
 YR 112  
 Wean Pct. 52%  
 Cow Eff. 109

RAAA HerdBuilder index: **109** (Top 44% of all RA bulls)  
 RAAA GridMaster index: **49** (Top 53% of all RA bulls)

Calv. Ease	BW	WW	YW	Milk	HPG	Stay	Maint. En.
EPDs <b>9.1</b>	<b>-2.4</b>	<b>57.7</b>	<b>94.1</b>	<b>19</b>	<b>11.9</b>	<b>10.1</b>	<b>-1.3</b>

Marb **+0.20** REA **-0.12** Bfat **+0.02**

BWT **76**  
 WR **107**  
 ADG **4.08**  
 YWt. **1247**  
 YR **111**  
 Scr. **36**  
 Fr. **5.5**

★★★★★ for Low Maintenance, Growth, Gainability, Marbling, Superior Cow, Calving Ease.

• Bulls •

**47** **BECKTON NEBULA C571 E5**   
 1-A 100% # 3487764 Tat.: BSF5 C571  
 Birth: 4-1-15

Beckton Nebula U206 V3  
**BECKTON NEBULA X096 N4** Ref. N-3  
 Beckton Tamara U185 NB

Beckton Epic K6 S569  
**BECKTON MINOLA X585 E**  
 Beckton Minola J409 LN

Beckton Nebula P P707  
 Beckton Minerva J615 VG  
 Beckton Nebula P P707  
 Beckton Tamara P813 CH  
 Beckton Epic KM M115  
 Beckton Sierra N703 LM  
 Beckton Lancer TS D390  
 Beckton Minola D494 SC

BWt **75**  
 WR **112**  
 ADG **3.79**  
 YWt **1201**  
 YR **107**  
 Scr. **36**  
 Fr. **5.5**

**DAM**  
 Age 5  
 Wt 1100  
 Prog.BW 68  
 WR 105  
 YR 102  
 Wean Pct. 60%  
 Cow Eff. 126

RAAA HerdBuilder index: **154** (Top 6% of all RA bulls)  
 RAAA GridMaster index: **51** (Top 16% of all RA bulls)  
 Calv.Ease BW WW YW Milk HPG Stay Maint.En.  
 EPDs **11.7 -3.7 57.8 88.9 26 10.1 15.1 1.0**  
 Marb **+0.70** REA **-0.06** Bfat **+0.02**

**50** **BECKTON JULIAN C698 N6**   
 1-A 100% # 3487590 Tat.: BKT5 C698  
 Birth: 4-13-15

Beckton Julian G5 S107  
**BECKTON JULIAN X465 J5** Ref. J-2  
 Beckton Suffeina P643 JL

Beckton Nebula W486 D3  
**BECKTON LANA Y022 N**  
 Beckton Lana W164 R

Beckton Julian GJ P535  
 Beckton Minola P826 DM  
 Beckton Julian GG B571  
 Bkt Suffeina A828 DM  
 Beckton Nebula L P093  
 Beckton Belga R716 DM  
 Beckton Ranger T603 H3  
 Beckton Lana T448 JR

BWt **74**  
 WR **111**  
 ADG **4.08**  
 YWt **1243**  
 YR **111**  
 Scr. **38**  
 Fr. **5.5**

**DAM**  
 Age 4  
 Wt NA  
 Prog.BW 73  
 WR 109  
 YR 107  
 Wean Pct. NA%  
 Cow Eff. NA

RAAA HerdBuilder index: **152** (Top 6% of all RA bulls)  
 RAAA GridMaster index: **51** (Top 12% of all RA bulls)  
 Calv.Ease BW WW YW Milk HPG Stay Maint.En.  
 EPDs **9.6 -1.9 64.5 107.7 15 14.1 14 -4.9**  
 Marb **+0.57** REA **-0.02** Bfat **+0.01**

★★★★★ for Low Maintenance, Growth, Marbling, High Cow Efficiency, Calving Ease, Stayability.

★★★★★ for Low Maintenance, Growth, Gainability, Marbling, Superior Cow, Calving Ease, Stayability.

**48** **BECKTON SCAMP C513 W4**   
 1-A 100% # 3487197 Tat.: BKT5 C513  
 Birth: 3-29-15

Beckton Scamp T A825  
**BECKTON SCAMP X458 H3** Ref. S-1  
 BKT Pine Marie R401 HU

Beckton Warrior T248 L5  
**BECKTON BELGA Y383 W**  
 Beckton Belga S166 HW

Beckton Scamp 8954  
 Bkt Encino 8459 TJ  
 Beckton Hustler C2 L079  
 Bkt Pine Marie LC30 CD  
 Beckton Warrior N645 T1  
 Beckton Kit R503 LN  
 Beckton Hawk P248  
 Beckton Belga P443 JO

BWt **72**  
 WR **102**  
 ADG **4.08**  
 YWt **1204**  
 YR **107**  
 Scr. **39**  
 Fr. **5.5**

**DAM**  
 Age 4  
 Wt 1155  
 Prog.BW 75  
 WR 100  
 YR 97  
 Wean Pct. 50%  
 Cow Eff. 106

RAAA HerdBuilder index: **123** (Top 26% of all RA bulls)  
 RAAA GridMaster index: **50** (Top 25% of all RA bulls)  
 Calv.Ease BW WW YW Milk HPG Stay Maint.En.  
 EPDs **10.1 -3.9 54.2 88.9 15 12.6 10.7 -6.3**  
 Marb **+0.34** REA **-0.14** Bfat **-0.03**

★★★★★ for Low Maintenance, Growth, Gainability, Marbling, Calving Ease.



**49** **BECKTON EPIC C523 D7**   
 1-A 100% # 3487307 Tat.: BKT5 C523  
 Birth: 3-29-15

Beckton Epic T330 L5  
**BECKTON EPIC X330 L6** Ref. E-1  
 Beckton Kit R503 LN

Beckton Dominor Z1 R610  
**BECKTON VERNICE W780 D**  
 Beckton Vernice R374 LN

Beckton Epic K4 N795  
 Beckton Belga K202 LN  
 Beckton Lancer F442 T  
 Beckton Kit F468 JL  
 Beckton Dominor ZC M919  
 Beckton Sierra K557 LO  
 Beckton Lancer T7 M089  
 Beckton Vernice K798 CD

BWt **83**  
 WR **118**  
 ADG **3.10**  
 YWt **1188**  
 YR **106**  
 Scr. **36**  
 Fr. **5.0**

**DAM**  
 Age 6  
 Wt 1310  
 Prog.BW 72  
 WR 103  
 YR 98  
 Wean Pct. 53%  
 Cow Eff. 112

RAAA HerdBuilder index: **128** (Top 22% of all RA bulls)  
 RAAA GridMaster index: **50** (Top 22% of all RA bulls)  
 Calv.Ease BW WW YW Milk HPG Stay Maint.En.  
 EPDs **7.5 -1.4 66.5 99.7 16 12.2 12.4 -1.2**  
 Marb **+0.63** REA **+0.10** Bfat **+0.00**

★★★★★ for Low Maintenance, Growth, Marbling, Calving Ease.

**51** **BECKTON EPIC C412 C6**   
 1-A 100% # 3487788 Tat.: BSF5 C412  
 Birth: 3-25-15

Beckton Epic K6 S569  
**BECKTON EPIC X464 L5** Ref. E-2  
 Beckton Lana M393 LN

Beckton Clifftop U575 H3  
**BECKTON ENCINO X075 C**  
 Beckton Encino U186 NB

Beckton Epic KM M115  
 Beckton Sierra N703 LM  
 Beckton Lancer T3 J396  
 Beckton Lana F081 LN  
 BKT Clifftop TP R288  
 Beckton Larkabel N769 HR  
 Beckton Nebula N R573  
 Beckton Encino P871 HR

BWt **60**  
 WR **104**  
 ADG **3.68**  
 YWt **1161**  
 YR **104**  
 Scr. **36**  
 Fr. **5.0**

**DAM**  
 Age 5  
 Wt 1000  
 Prog.BW 60  
 WR 110  
 YR 105  
 Wean Pct. 62%  
 Cow Eff. 129

RAAA HerdBuilder index: **152** (Top 6% of all RA bulls)  
 RAAA GridMaster index: **50** (Top 22% of all RA bulls)  
 Calv.Ease BW WW YW Milk HPG Stay Maint.En.  
 EPDs **13.9 -6.3 47.7 77.4 36 12 14 -2.2**  
 Marb **+0.30** REA **-0.02** Bfat **-0.02**

★★★★★ for Low Maintenance, Marbling, Superior Cow, High Cow Efficiency, Calving Ease, Stayability.



• Bulls •

**52** **BECKTON JULIAN C578 N6**   
 1-A 100% # 3487747 Tat.: BSF5 C578  
 Birth: 4-1-15  
 Beckton Julian G5 S107 < Beckton Julian GJ P535  
 Beckton Minola P826 DM  
**BECKTON JULIAN X465 J5** < Beckton Julian GG B571  
 Ref. J-2 < Beckton Suffeina P643 JL < Bkt Suffeina A828 DM  
 YWt. **1176**  
 Beckton Nebula T398 V3 < Beckton Nebula L P093  
 Beckton Minerva J615 VG  
**BECKTON LARKABA Y156 N** < Beckton Julian G3 P608  
 Beckton Larkaba U274 JL < Beckton Larkaba N708 HR  
 Scr. **37**  
 Fr. **6.0**  
**DAM**  
 Age 4  
 Wt 1210  
 Prog.BW 65  
 WR 103  
 YR 106  
 Wean Pct. 52%  
 Cow Eff. 109  
 RAAA HerdBuilder index: **157** (Top 5% of all RA bulls)  
 RAAA GridMaster index: **51** (Top 10% of all RA bulls)  
 Calv.Ease BW WW YW Milk HPG Stay Maint.En.  
 EPDs **10.6 -2.8 56.7 96.1 17 13.9 14.6 -3.8**  
 Marb **+0.69** REA **-1.15** Bfat **+0.00**

★★★★★ for Low Maintenance, Marbling, Superior Cow, Calving Ease, Stayability.

**55** **BECKTON LIKABLE C629 L3**   
 1-A 100% # 3487247 Tat.: BKT5 C629  
 Birth: 4-5-15  
 Beckton Likable S633 < Beckton Lancer F442 T  
 Beckton Kit F468 JL  
**BECKTON LIKABLE U130 L2** < Beckton Lancer F442 T  
 Ref. L-1 < Beckton Kit S478 LN < Beckton Kit F468 JL  
 YWt. **1196**  
 Beckton Lancer T371 H4 < Beckton Lancer F442 T  
 Beckton Coca F276 HV  
**BECKTON TAMARA Z476 L** < Beckton Justice C1 R483  
 Beckton Tamara W174 J < Beckton Tamara P460 LN  
 Scr. **35**  
 Fr. **5.5**  
**DAM**  
 Age 3  
 Wt 1110  
 Prog.BW 80  
 WR 108  
 YR 102  
 Wean Pct. 56%  
 Cow Eff. 119  
 RAAA HerdBuilder index: **128** (Top 21% of all RA bulls)  
 RAAA GridMaster index: **50** (Top 29% of all RA bulls)  
 Calv.Ease BW WW YW Milk HPG Stay Maint.En.  
 EPDs **8.7 -2.4 66.4 98.7 13 10 12.7 .0**  
 Marb **+0.44** REA **+0.37** Bfat **+0.03**

★★★★★ for Low Maintenance, Growth, Marbling, Rib-eye area, High Cow Efficiency, Calving Ease.

**53** **BECKTON EPIC C538 J7**   
 1-A 100% # 3487387 Tat.: BKT5 C538  
 Birth: 3-30-15  
 Beckton Epic U749 D5 < Beckton Epic K4 N795  
 Beckton Denise R308 DM  
**BECKTON EPIC Y484 N6** < Beckton Nebula P P707  
 Ref. E-4 < Beckton Lydia S069 NB < Beckton Lydia P583 WR  
 YWt. **1146**  
 Beckton Julian G2 M345 < Beckton Julian GG B571  
 Beckton Lana H544 WR  
**BECKTON LANA T211 JL** < Beckton Lancer TZ D525  
 Beckton Lana G592 LN < Beckton Lana C332 KR  
 Scr. **38**  
 Fr. **5.5**  
**DAM**  
 Age 8  
 Wt 1165  
 Prog.BW 63  
 WR 103  
 YR 98  
 Wean Pct. 53%  
 Cow Eff. 112  
 RAAA HerdBuilder index: **140** (Top 12% of all RA bulls)  
 RAAA GridMaster index: **52** (Top 9% of all RA bulls)  
 Calv.Ease BW WW YW Milk HPG Stay Maint.En.  
 EPDs **14.4 -5.0 53.4 88.7 19 11.8 11.6 -3.8**  
 Marb **+0.49** REA **+0.30** Bfat **+0.01**

★★★★★ for Low Maintenance, Marbling, Rib-eye area, Calving Ease.



**54** **BECKTON NEW ERA C054 N3**   
 1-A 100% # 3487978 Tat.: BSF5 C054  
 Birth: 2-24-15  
 Beckton New Era Y194 < Beckton Nebula P P707  
 BKT Larkeisa T310 JC  
**BECKTON NEW ERA A395 L2** < Beckton Legend U331 E2  
 Ref. N-5 < Beckton Minerva U313 NB  
 YWt. **1107**  
 Beckton New Era Y194 < Beckton Nebula P P707  
 BKT Larkeisa T310 JC  
**BECKTON LARKABEL A361 N** < Beckton Nebula T269 E2  
 Beckton Larkabel X676 N < BKT Larkabel R038 WA  
 Scr. **34**  
 Fr. **5.5**  
**DAM**  
 Age 2  
 Wt 890  
 Prog.BW 58  
 WR 107  
 YR 107  
 Wean Pct. 56%  
 Cow Eff. 118  
 RAAA HerdBuilder index: **198** (Top 1% of all RA bulls)  
 RAAA GridMaster index: **51** (Top 12% of all RA bulls)  
 Calv.Ease BW WW YW Milk HPG Stay Maint.En.  
 EPDs **13.8 -5.4 56.2 89.8 23 7.5 13 -0.6**  
 Marb **+0.47** REA **+0.21** Bfat **+0.02**

★★★★★ for Low Maintenance, Growth, Marbling, Rib-eye area, Superior Cow, High Cow Efficiency, Calving Ease, Stayability.

**56** **BECKTON ROOSEVELT C364 L2**   
 1-A 100% # 3487532 Tat.: BKT5 C364  
 Birth: 3-23-15  
 Bieber Rough Rider 10712 < Basin Trend Setter 6074  
 Bieber Adelle 8958  
**BIEBER ROOSEVELT W384** < C A Future Direction 5321  
 Ref. B-1 < Bieber Sheba 9602 < Bieber Sheba 5537  
 YWt. **1145**  
 Beckton Likable X445 J3 < Beckton Likable U130 L2  
 Beckton Indigo U658 JL  
**BKT PINE MARIE Z194 L** < Beckton Nebula T269 E2  
 BKT Pine Marie X339 N < BKT Pine Marie S467 JE  
 Scr. **35**  
 Fr. **6.0**  
**DAM**  
 Age 3  
 Wt 955  
 Prog.BW 80  
 WR 113  
 YR 104  
 Wean Pct. 64%  
 Cow Eff. 134  
 RAAA HerdBuilder index: **136** (Top 15% of all RA bulls)  
 RAAA GridMaster index: **49** (Top 52% of all RA bulls)  
 Calv.Ease BW WW YW Milk HPG Stay Maint.En.  
 EPDs **6.2 -1.4 55.5 79 25 14.8 13.4 -8.0**  
 Marb **+0.64** REA **+0.10** Bfat **+0.03**

★★★★★ for Low Maintenance, Marbling, Superior Cow, High Cow Efficiency, Calving Ease, Stayability.

• Bulls •

**57** **BECKTON NEBULA C445 E3**   
 1-A 100% # 3487773 Tat.: BSF5 C445  
 Birth: 3-27-15  
**BECKTON NEBULA E P084** (Ref. N) ← Beckton Nebula M045  
 ← Beckton Neptune R2 K065  
 ← Beckton Belga K285 JL  
**BECKTON KIT X425 E** ← Beckton Epic K F075  
 ← Beckton Epic K4 N795  
 ← Beckton Rose L083 LN  
 ← Beckton Nebula E P084  
 ← Beckton Kit R441 LN  
**DAM**  
 Age 5  
 Wt 1015  
 Prog.BW 70  
 WR 103  
 YR 103  
 Wean Pct. 60%  
 Cow Eff. 126  
 RAAA HerdBuilder index: **150** (Top 7% of all RA bulls)  
 RAAA GridMaster index: **50** (Top 30% of all RA bulls)  
 Calv.Ease BW WW YW Milk HPG Stay Maint.En.  
 EPDs **12.4 -5.8 43.4 64.6 20 11.3 14.1 -8.5**  
 Marb **+0.70** REA **+0.02** Bfat **+0.07**

★★★★★ for Low Maintenance, Marbling, High Cow Efficiency, Calving Ease, Stayability.

**60** **BECKTON SCAMP C512 D4**   
 2 100% # 3487866 Tat.: BSF5 C512  
 Birth: 3-29-15  
**BECKTON SCAMP X458 H3** (Ref. S-1) ← Beckton Scamp T A825  
 ← Beckton Scamp 8954  
 ← Bkt Encino 8459 TJ  
**BECKTON MINOLA S674 DM** ← Beckton Hustler C2 L079  
 ← Beckton Barmaid J012 CO  
 ← Beckton Dominor Z E401  
 ← Beckton Hustler CN J102  
 ← Beckton Minola K527 CO  
**DAM**  
 Age 9  
 Wt 1250  
 Prog.BW 75  
 WR 102  
 YR 106  
 Wean Pct. 48%  
 Cow Eff. 101  
 RAAA HerdBuilder index: **135** (Top 16% of all RA bulls)  
 RAAA GridMaster index: **50** (Top 21% of all RA bulls)  
 Calv.Ease BW WW YW Milk HPG Stay Maint.En.  
 EPDs **11.9 -4.5 51.5 84.3 19 12.9 11.5 -5.4**  
 Marb **+0.40** REA **-0.09** Bfat **-0.02**

★★★★★ for Low Maintenance, Marbling, Calving Ease.

**58** **BECKTON EPIC C697 L6**   
 1-A 100% # 3487408 Tat.: BKT5 C697  
 Birth: 4-13-15  
**BECKTON EPIC X464 L5** (Ref. E-2) ← Beckton Epic K6 S569  
 ← Beckton Epic KM M115  
 ← Beckton Sierra N703 LM  
**BECKTON LANA S049 LO** ← Beckton Lana M393 LN  
 ← Beckton Lancer T3 J396  
 ← Beckton Lana F081 LN  
 ← Beckton Lancer T1 H080  
 ← Beckton Ruth G534 NP  
 ← Beckton Julio L233  
 ← Beckton Lana J131 CT  
**DAM**  
 Age 9  
 Wt 1250  
 Prog.BW 63  
 WR 107  
 YR 103  
 Wean Pct. 51%  
 Cow Eff. 107  
 RAAA HerdBuilder index: **126** (Top 23% of all RA bulls)  
 RAAA GridMaster index: **51** (Top 17% of all RA bulls)  
 Calv.Ease BW WW YW Milk HPG Stay Maint.En.  
 EPDs **14.2 -6.1 46.9 80.7 34 9.6 11.1 -2.6**  
 Marb **+0.33** REA **+0.02** Bfat **+0.01**

★★★★★ for Low Maintenance, Growth, Marbling, Superior Cow, Calving Ease.

**61** **BECKTON LUNESTA C208 W2**   
 1-A 100% # 3487202 Tat.: BKT5 C208  
 Birth: 3-14-15  
**MUSHRUSH LUNESTA A007** (Ref. A-4) ← Mushrush Lunesta MD Y097  
 ← Mushrush Lunesta W033  
 ← Mushrush Madam OS U109  
**BECKTON COCA A907 W** ← Padg Julian 674  
 ← Padg Candy 196  
 ← Beckton Warrior W534 N4  
 ← Beckton Warrior C1 S337  
 ← BKT Larkeisa S055 NB  
 ← Beckton Clifftop T3 N800  
 ← Beckton Coca P328 EP  
**DAM**  
 Age 2  
 Wt 885  
 Prog.BW 53  
 WR 108  
 YR 109  
 Wean Pct. 62%  
 Cow Eff. 131  
 RAAA HerdBuilder index: **135** (Top 15% of all RA bulls)  
 RAAA GridMaster index: **52** (Top 6% of all RA bulls)  
 Calv.Ease BW WW YW Milk HPG Stay Maint.En.  
 EPDs **13.5 -5.9 46.5 77.2 24 9.4 12.4 -4.1**  
 Marb **+0.82** REA **+0.06** Bfat **+0.05**

★★★★★ for Low Maintenance, Growth, Marbling, Superior Cow, High Cow Efficiency, Calving Ease.

**59** **BECKTON NOMAD C352 L3**   
 1-A 100% # 3487576 Tat.: BKT5 C352  
 Birth: 3-22-15  
**BECKTON NOMAD V 9871** (Ref. V-1) ← Beckton Nomad 7496  
 ← Beckton Neva 5562  
 ← Bkt Bolt Tamrck 3913  
**BKT PINE MARIE Y230 L** ← Bkt Barmaid 6986 VR  
 ← Beckton Varo 5642  
 ← Bkt Lahrogno-3  
 ← Beckton Likable U120 L2  
 ← Beckton Likable S633  
 ← Beckton Lana S718 LN  
 ← BKT Pine Marie R056 CQ  
 ← Beckton Cherokee N N479  
 ← BKT Pine Marie N783 CO  
**DAM**  
 Age 4  
 Wt 1085  
 Prog.BW 56  
 WR 98  
 YR 101  
 Wean Pct. 53%  
 Cow Eff. 112  
 RAAA HerdBuilder index: **122** (Top 27% of all RA bulls)  
 RAAA GridMaster index: **48** (Top 58% of all RA bulls)  
 Calv.Ease BW WW YW Milk HPG Stay Maint.En.  
 EPDs **14.8 -7.4 36.4 47 28 9.5 11.2 -14.9**  
 Marb **+0.38** REA **-0.15** Bfat **+0.00**

★★★★★ for Low Maintenance, Marbling, Calving Ease.



Lot 59

• Bulls •

**62 BECKTON LIKABLE C643 L3**  
1-A 100% # 3487786 Tat.: BSF5 C643 

Birth: 4-7-15

Beckton Likable S633  
**BECKTON LIKABLE U130 L2**  
Ref. L-1 Beckton Kit S478 LN

Beckton Lancer F442 T  
Beckton Kit F468 JL  
Beckton Lancer F442 T  
Beckton Kit F468 JL

Beckton Likable S633  
Beckton Lana S718 LN  
Beckton Nebula P P707  
Beckton Minola N729 JL

BWT **65**  
WR **106**  
ADG **3.51**  
YWT **1184**  
YR **106**  
Scr. **36**  
Fr. **5.0**

Beckton Likable U120 L2  
**BECKTON MINOLA X107 L**  
Beckton Minola U188 NB

**DAM**  
Age 5  
Wt 950  
Prog.BW 62  
WR 102  
YR 103  
Wean Pct. 66%  
Cow Eff. 139

RAAA HerdBuilder index: **159** (Top 4% of all RA bulls)  
RAAA GridMaster index: **52** (Top 5% of all RA bulls)  
Calv.Ease BW WW YW Milk HPG Stay Maint.En.  
EPDs **11.8 -6.3 50.9 83.3 19 10.9 14.6 -10.2**  
Marb **+0.63** REA **+0.54** Bfat **+0.05**

★★★★★ for Low Maintenance, Growth, Marbling, Rib-eye area, High Cow Efficiency, Calving Ease, Stayability.

**64 BECKTON LIKABLE C474 J3**  
1-A 100% # 3487657 Tat.: BSF5 C474 

Birth: 3-28-15

Beckton Likable S633  
**BECKTON LIKABLE U130 L2**  
Ref. L-1 Beckton Kit S478 LN

Beckton Lancer F442 T  
Beckton Kit F468 JL  
Beckton Lancer F442 T  
Beckton Kit F468 JL

Beckton Likable S633  
Beckton Lana S718 LN  
Beckton Nebula P P707  
Beckton Minola N729 JL

BWT **75**  
WR **104**  
ADG **3.56**  
YWT **1144**  
YR **102**  
Scr. **35**  
Fr. **5.0**

Beckton Jet L P491  
**BKT PINE MARIE X204 J**  
BKT Pine Marie S802 LO

TR Julian LT151  
Beckton Minerva L278 LN  
Beckton Lasso P741  
BKT Pine Marie P475 LN

**DAM**  
Age 5  
Wt 1180  
Prog.BW 64  
WR 103  
YR 102  
Wean Pct. 52%  
Cow Eff. 110

RAAA HerdBuilder index: **135** (Top 15% of all RA bulls)  
RAAA GridMaster index: **51** (Top 11% of all RA bulls)  
Calv.Ease BW WW YW Milk HPG Stay Maint.En.  
EPDs **10.9 -4.7 48.6 77.8 20 10.2 12.7 -1.3**  
Marb **+0.64** REA **+0.36** Bfat **+0.02**

★★★★★ for Low Maintenance, Marbling, Rib-eye area, Calving Ease.



Lot 63

**65 BECKTON CLIFFTOP C257 A4**  
1-A 100% # 3487558 Tat.: BKT5 C257 

Birth: 3-18-15

BKT Clifftop TP R288  
**BECKTON CLIFFTOP W692 E3**  
Ref. C-1 Beckton Lydia S274 EP

Beckton Clifftop T C075  
Beckton Christy K209 CO  
Beckton Epic KM M115  
Beckton Lydia M607 LO

Beckton Accent U777 C2  
**BECKTON LARKABA Y454 A**  
Beckton Larkaba U498 EP

Beckton Cody K1 P014  
Beckton Susan R022 CQ  
Beckton Epic R350 K  
Beckton Larkaba R336 CK

BWT **64**  
WR **103**  
ADG **2.93**  
YWT **1124**  
YR **100**  
Scr. **38**  
Fr. **5.0**

**DAM**  
Age 4  
Wt 1105  
Prog.BW 67  
WR 104  
YR 103  
Wean Pct. 54%  
Cow Eff. 113

RAAA HerdBuilder index: **158** (Top 5% of all RA bulls)  
RAAA GridMaster index: **50** (Top 22% of all RA bulls)  
Calv.Ease BW WW YW Milk HPG Stay Maint.En.  
EPDs **11.9 -5.2 49.1 77.4 27 12.4 15.3 -2.6**  
Marb **+0.66** REA **-0.19** Bfat **+0.05**

★★★★★ for Low Maintenance, Marbling, Calving Ease, Stayability.

**63 BECKTON ACCENT C405 C4**  
1-A 100% # 3487347 Tat.: BKT5 C405 

Birth: 3-24-15

Beckton Accent W180 C2  
**BECKTON ACCENT Y260 L3**  
Ref. A-2 Beckton Lana W463 L

Beckton Cody K1 P014  
Beckton Christy R046 CQ  
Beckton Loki CL S284  
Beckton Lana R327 EP

Beckton Clifftop T3 N800  
**BECKTON ROSE U726 CT**  
Beckton Rose R545 DM

Bkt Clifftop TV G672  
Beckton Lana J384 CD  
Beckton Dominor ZC M919  
Beckton Rose G688 CD

BWT **66**  
WR **100**  
ADG **3.56**  
YWT **1132**  
YR **101**  
Scr. **37**  
Fr. **5.0**

**DAM**  
Age 7  
Wt 1080  
Prog.BW 57  
WR 93  
YR 95  
Wean Pct. 55%  
Cow Eff. 116

RAAA HerdBuilder index: **165** (Top 3% of all RA bulls)  
RAAA GridMaster index: **52** (Top 7% of all RA bulls)  
Calv.Ease BW WW YW Milk HPG Stay Maint.En.  
EPDs **14.1 -5.9 45.3 74 23 10.5 15.5 -6.9**  
Marb **+0.84** REA **-0.01** Bfat **+0.03**

★★★★★ for Low Maintenance, Marbling, Calving Ease, Stayability.

**66 BECKTON HERITAGE C400 A4**  
1-A 100% # 3487582 Tat.: BKT5 C400 

Birth: 3-24-15

Beckton Heritage T270 J2  
**BECKTON HERITAGE X403 L3**  
Ref. H-1 Beckton Indigo H150 LN

Beckton Heritage N013  
Beckton Coca P602 JL  
Beckton Lancer TE F363  
Beckton Indigo F376 CT

Beckton Accent U777 C2  
**BECKTON ROSE Y101 A**  
Beckton Rose R353 LN

Beckton Cody K1 P014  
Beckton Susan R022 CQ  
Beckton Lancer T7 M089  
Beckton Rose L083 LN

BWT **57**  
WR **101**  
ADG **2.93**  
YWT **1131**  
YR **101**  
Scr. **38**  
Fr. **5.5**

**DAM**  
Age 4  
Wt 1175  
Prog.BW 56  
WR 100  
YR 102  
Wean Pct. 49%  
Cow Eff. 104

RAAA HerdBuilder index: **146** (Top 9% of all RA bulls)  
RAAA GridMaster index: **50** (Top 25% of all RA bulls)  
Calv.Ease BW WW YW Milk HPG Stay Maint.En.  
EPDs **13.7 -6.3 50.8 72.7 23 11.2 13.6 -1.0**  
Marb **+0.62** REA **-0.01** Bfat **+0.05**

★★★★★ for Low Maintenance, Marbling, Calving Ease, Stayability.



• Bulls •

**67** **BECKTON ACCENT C009 A5**  1-A 100% # 3487612 Tat.: BKT5 C009

Birth: 2-17-15

Beckton Accent Y260 L3  
**BECKTON ACCENT A110 E4**  
 Ref. A-5 Beckton Ruth Y015 E

Beckton Accent W180 C2  
 Beckton Lana W463 L  
 Beckton Emcoe W271 L2  
 Beckton Ruth W488 J

Beckton Accent Y260 L3  
**BECKTON SUFFEINA A190 A**  
 Beckton Suffeina Y242 N

Beckton Accent W180 C2  
 Beckton Lana W463 L  
 Beckton Nebula P P707  
 BKT Suffeina T110 EM

BWt	63
WR	105
ADG	3.79
YWt	1081
YR	105
Scr.	36
Fr.	5.0

**DAM**

Age	2
Wt	985
Prog.BW	63
WR	105
YR	105
Wean Pct.	50%
Cow Eff.	104

RAAA HerdBuilder index: **176** (Top 1% of all RA bulls)  
 RAAA GridMaster index: **51** (Top 9% of all RA bulls)

Calv.Ease	BW	WW	YW	Milk	HPG	Stay	Maint.En.	
EPDs	12.7	-4.6	59.9	91.2	22	8.8	15.8	-3.3
Marb	+.68		REA	+.05		Bfat		+0.1

★★★★★ for Low Maintenance, Marbling, Superior Cow, Calving Ease, Stayability.



**68** **BECKTON WARRIOR C623 E5**  1-A 100% # 3487283 Tat.: BKT5 C623

Birth: 4-5-15

Beckton Warrior C1 S337  
**BECKTON WARRIOR W534 N4**  
 Ref. W-2 BKT Larkeisa S055 NB

Beckton Warrior CL M686  
 Beckton Christy K101 CD  
 Beckton Nebula P P707  
 Beckton Larkeisa P688 CH

Beckton Epic K6 S569  
**BECKTON ROSE X389 E**  
 Beckton Rose P015 LN

Beckton Epic KM M115  
 Beckton Sierra N703 LM  
 Beckton Lancer T7 M089  
 Beckton Rose M131 HR

BWt	80
WR	107
ADG	3.79
YWt	1135
YR	101
Scr.	37
Fr.	5.5

**DAM**

Age	5
Wt	1145
Prog.BW	72
WR	114
YR	108
Wean Pct.	55%
Cow Eff.	116

RAAA HerdBuilder index: **146** (Top 9% of all RA bulls)  
 RAAA GridMaster index: **49** (Top 51% of all RA bulls)

Calv.Ease	BW	WW	YW	Milk	HPG	Stay	Maint.En.	
EPDs	13.1	-4.2	44.8	64.9	27	12.2	13.7	-6.4
Marb	+.50		REA	-.02		Bfat		+0.02

★★★★★ for Low Maintenance, Marbling, Superior Cow, High Cow Efficiency, Calving Ease, Stayability.

**70** **BECKTON LUNESTA C057 N2**  1-A 100% # 3487523 Tat.: BKT5 C057

Birth: 2-24-15

Mushrush Lunesta MD Y097  
**MUSHRUSH LUNESTA A007**  
 Ref. A-4 Mushrush Candice JL X212

Mushrush Lunesta W033  
 Mushrush Madam OS U109  
 Padg Julian 674  
 Padg Candy 196

Beckton Nebula P P707  
**BECKTON COCA A271 N**  
 Beckton Coca X675 N

Beckton Nebula M045  
 Beckton Lana M809 EP  
 Beckton Nebula PJ S543  
 Beckton Coca T363 JL

BWt	67
WR	109
ADG	3.45
YWt	1106
YR	107
Scr.	31
Fr.	5.0

**DAM**

Age	2
Wt	1010
Prog.BW	67
WR	109
YR	107
Wean Pct.	50%
Cow Eff.	106

RAAA HerdBuilder index: **150** (Top 7% of all RA bulls)  
 RAAA GridMaster index: **53** (Top 2% of all RA bulls)

Calv.Ease	BW	WW	YW	Milk	HPG	Stay	Maint.En.	
EPDs	12.7	-4.8	57.5	91.6	20	10.5	13.6	-2.1
Marb	+.11		REA	-.22		Bfat		+0.03

★★★★★ for Low Maintenance, Growth, Marbling, Superior Cow, Calving Ease, Stayability.

**69** **BECKTON EPIC C326 C6**  1-A 100% # 3487419 Tat.: BKT5 C326

Birth: 3-22-15

Beckton Epic K6 S569  
**BECKTON EPIC X464 L5**  
 Ref. E-2 Beckton Lana M393 LN

Beckton Epic KM M115  
 Beckton Sierra N703 LM  
 Beckton Lancer T3 J396  
 Beckton Lana F081 LN

Beckton Cherokee N N479  
**BKT PINE MARIE R056 CQ**  
 BKT Pine Marie N783 CO

BFCk Cherokee Cnyn 4912  
 Beckton Dinah C440 NM  
 Beckton Copper JT G095  
 Bkt Pine Marie D319 VG

BWt	64
WR	94
ADG	3.68
YWt	1081
YR	95
Scr.	33
Fr.	5.0

**DAM**

Age	10
Wt	1175
Prog.BW	65
WR	100
YR	100
Wean Pct.	49%
Cow Eff.	104

RAAA HerdBuilder index: **141** (Top 12% of all RA bulls)  
 RAAA GridMaster index: **50** (Top 21% of all RA bulls)

Calv.Ease	BW	WW	YW	Milk	HPG	Stay	Maint.En.	
EPDs	12.3	-5.0	44.8	71.5	34	10.7	14	-1.5
Marb	+.54		REA	+.12		Bfat		+0.01

★★★★★ for Low Maintenance, Marbling, Calving Ease, Stayability.

**71** **BSF CLIFFTOP C186 J5**  1-B 99% # 3487748 Tat.: BSF5 C186

Birth: 3-11-15

Beckton Clifftop W692 E3  
**BECKTON CLIFFTOP Y012 C4**  
 Ref. C-2 Beckton Lana W240 C

BKT Clifftop TP R288  
 Beckton Lydia S274 EP  
 BKT Clifftop TP R288  
 Beckton Lana L923 CD

Beckton Julian W841 J5  
**BSF ERICA Y140 J**  
 BSF Erica W053 R

Beckton Julian G5 S107  
 Beckton Christy J743 JL  
 Beckton Ranger T603 H3  
 BSF Erica T609 EP

BWt	65
WR	102
ADG	3.56
YWt	1177
YR	105
Scr.	36
Fr.	5.0

**DAM**

Age	4
Wt	1070
Prog.BW	66
WR	108
YR	109
Wean Pct.	55%
Cow Eff.	115

RAAA HerdBuilder index: **185** (Top 1% of all RA bulls)  
 RAAA GridMaster index: **51** (Top 19% of all RA bulls)

Calv.Ease	BW	WW	YW	Milk	HPG	Stay	Maint.En.	
EPDs	14.4	-5.8	47.1	78.1	29	12	17.3	-3.1
Marb	+.58		REA	-.18		Bfat		+0.04

★★★★★ for Low Maintenance, Growth, Marbling, Superior Cow, Calving Ease, Stayability.

• Bulls •

**72** **BSF HERITAGE C417 N4**  1-B 99% # 3487660 Tat.: BSF5 C417

Birth: 3-25-15

Beckton Heritage T270 J2 < Beckton Heritage N013  
Beckton Coca P602 JL

**BECKTON HERITAGE X403 L3** Ref. H-1 < Beckton Lancer TE F363  
Beckton Indigo H150 LN < Beckton Indigo F376 CT

Beckton Nebula T269 E2 < Beckton Nebula M045  
Beckton Ruth M967 EP

**BSF JUSTICIA Y672 N** < Beckton Justice C K449  
BSF Justicia R553 JC < BSF Regus L104 LN

<b>DAM</b>	
Age	4
Wt	1170
Prog.BW	68
WR	106
YR	100
Wean Pct.	56%
Cow Eff.	117

RAAA HerdBuilder index: **142** (Top 11% of all RA bulls)  
RAAA GridMaster index: **49** (Top 40% of all RA bulls)

Calv.Ease	BW	WW	YW	Milk	HPG	Stay	Maint.En.	
EPDs	10.2	-2.9	65.3	91.5	19	11.9	13.7	-2.7

Marb **+0.58** REA **+0.00** Bfat **+0.04**

★★★★★ for Low Maintenance, Growth, Marbling, High Cow Efficiency, Calving Ease, Stayability.

**75** **BSF ACCENT C076 S4**  1-B 99% # 3487955 Tat.: BSF5 C076

Birth: 2-25-15

Beckton Accent W180 C2 < Beckton Cody K1 P014  
Beckton Christy R046 CQ

**BECKTON ACCENT A175 O3** Ref. A-6 < TR Romeo NT379  
Beckton Lana R214 RA < Beckton Lana N664 JL

Beckton Scamp X494 E3 < Beckton Scamp T A825  
Beckton Lana S074 EP

**BSF WARHANNA A555 S** < Beckton Warhawk N560  
BSF Warhanna U471 WA < BSF Regus L616 LN

<b>DAM</b>	
Age	2
Wt	930
Prog.BW	62
WR	115
YR	112
Wean Pct.	58%
Cow Eff.	122

RAAA HerdBuilder index: **144** (Top 10% of all RA bulls)  
RAAA GridMaster index: **51** (Top 12% of all RA bulls)

Calv.Ease	BW	WW	YW	Milk	HPG	Stay	Maint.En.	
EPDs	12.8	-4.4	64.2	99.6	22	11.5	12.2	-3.8

Marb **+0.49** REA **+0.22** Bfat **+0.02**

★★★★★ for Low Maintenance, Growth, Marbling, Rib-eye area, Superior Cow, High Cow Efficiency, Calving Ease.

**73** **BSF ACCENT C287 L4**  1-B 99% # 3487769 Tat.: BSF5 C287

Birth: 3-20-15

Beckton Accent W180 C2 < Beckton Cody K1 P014  
Beckton Christy R046 CQ

**BECKTON ACCENT Y260 L3** Ref. A-2 < Beckton Loki CL S284  
Beckton Lana W463 L < Beckton Lana R327 EP

Beckton Legend S670 < Beckton Lancer F442 T  
Beckton Kit F468 JL

**BSF VIOLET X528 L** < Beckton Vegas S1 K316  
BSF Violet N382 VG < BSF Red H119

<b>DAM</b>	
Age	5
Wt	1170
Prog.BW	62
WR	101
YR	97
Wean Pct.	53%
Cow Eff.	112

RAAA HerdBuilder index: **156** (Top 5% of all RA bulls)  
RAAA GridMaster index: **51** (Top 19% of all RA bulls)

Calv.Ease	BW	WW	YW	Milk	HPG	Stay	Maint.En.	
EPDs	11.1	-3.7	58.5	87.5	19	12.5	14.9	-5.9

Marb **+0.61** REA **+0.02** Bfat **+0.00**

★★★★★ for Low Maintenance, Marbling, Calving Ease, Stayability.

**76** **BSF NEBULA C264 N5**  1-B 99% # 3487178 Tat.: BKB5 C264

Birth: 3-18-15

Beckton Nebula PJ S543 < Beckton Nebula P P707  
Beckton Lana P685 JO

**BECKTON NEBULA W778 J4** Ref. N < Beckton Jet L P491  
Beckton Lana S197 JT < Beckton Lana P828 LN

Beckton Nebula T398 V3 < Beckton Nebula L P093  
Beckton Minerva J615 VG

**BSF JULIA W039 N** < Beckton Julio L233  
BSF Julia T175 JO < BSF Regus M604 LN

<b>DAM</b>	
Age	6
Wt	1140
Prog.BW	59
WR	104
YR	104
Wean Pct.	53%
Cow Eff.	111

RAAA HerdBuilder index: **171** (Top 2% of all RA bulls)  
RAAA GridMaster index: **52** (Top 6% of all RA bulls)

Calv.Ease	BW	WW	YW	Milk	HPG	Stay	Maint.En.	
EPDs	17.7	-8.3	49.2	74.9	16	12.1	14.5	-4.9

Marb **+0.76** REA **-0.07** Bfat **+0.04**

★★★★★ for Low Maintenance, Marbling, Superior Cow, Calving Ease, Stayability.

**74** **BSF LIKABLE C374 J4**  1-B 99% # 3487643 Tat.: BSF5 C374

Birth: 3-24-15

Beckton Likable U130 L2 < Beckton Likable S633  
Beckton Kit S478 LN

**BECKTON LIKABLE Y124 L3** Ref. L-2 < Beckton Lasso P741  
BKT Pine Marie S802 LO < BKT Pine Marie P475 LN

Beckton Julian U699 L5 < Beckton Julian G1 J526  
Beckton Rose L311 LN

**BSF LAUREL Z268 J** < Beckton Cherokee N N479  
BSF Laurel U202 CQ < BSF Laurel N839 LN

<b>DAM</b>	
Age	3
Wt	965
Prog.BW	65
WR	106
YR	111
Wean Pct.	59%
Cow Eff.	124

RAAA HerdBuilder index: **154** (Top 6% of all RA bulls)  
RAAA GridMaster index: **51** (Top 13% of all RA bulls)

Calv.Ease	BW	WW	YW	Milk	HPG	Stay	Maint.En.	
EPDs	12.1	-5.2	53.1	89.8	22	11.8	14.6	-6.2

Marb **+0.52** REA **+0.11** Bfat **+0.06**

★★★★★ for Low Maintenance, Growth, Gainability, Marbling, Superior Cow, High Cow Efficiency, Calving Ease, Stayability.



• Bulls •

**77** **BSF JANUS C458 H3** 

1-B 99% # 3487782 Tat.: BSF5 C458

Birth: 3-24-15

Beckton Roman J S158  
 Beckton Belga K285 JL  
 Beckton Loki F251  
 Beckton Sierra C157 CL  
 Beckton Heritage T270 J2  
 Beckton Coca P602 JL  
 Beckton Loki C M740  
 BSF Regus F700

**BECKTON JANUS X799 L2**  
Ref. J-3  
Beckton Sierra K557 LO

**BSF LOKETTA X132 H**  
Beckton Heritage T270 J2  
BSF Loketta R368 LO

<b>DAM</b>
Age 5
Wt 1195
Prog.BW 70
WR 105
YR 105
Wean Pct. 50%
Cow Eff. 106

BWt 64
WR 101
ADG 3.51
Ywt. 1156
YR 103
Scr. 38
Fr. 5.0

RAAA HerdBuilder index: **133**(Top 17% of all RA bulls)  
 RAAA GridMaster index: **51** (Top 9% of all RA bulls)

Calv.Ease	BW	WW	YW	Milk	HPG	Stay	Maint.En.
EPDs 13.2	-4.9	51.9	78.4	28	9.7	12	2.4

Marb **+0.80** REA **+1.12** Bfat **+0.1**

★★★★★ for Low Maintenance, Marbling, Superior Cow, Calving Ease.

**80** **BECKTON JANUS C430 W3** 

1-A 100% # 3487884 Tat.: BSF5 C430

Birth: 3-26-15

Beckton Roman J S158  
 Beckton Belga K285 JL  
 Beckton Loki F251  
 Beckton Sierra C157 CL  
 Beckton Warrior T1 H281  
 Beckton Firefly H195 HD  
 Beckton Herald FJ J776  
 Bkt Larkabel F246 CT

**BECKTON JANUS X799 L2**  
Ref. J-3  
Beckton Sierra K557 LO

**BKT LARKABEL R038 WA**  
Beckton Warhawk N560  
Beckton Larkabel N769 HR

<b>DAM</b>
Age 10
Wt 1240
Prog.BW 74
WR 98
YR 100
Wean Pct. 45%
Cow Eff. 94

BWt 66
WR 93
ADG 3.56
Ywt. 1056
YR 94
Scr. 34
Fr. 5.5

RAAA HerdBuilder index: **125**(Top 24% of all RA bulls)  
 RAAA GridMaster index: **50**(Top 36% of all RA bulls)

Calv.Ease	BW	WW	YW	Milk	HPG	Stay	Maint.En.
EPDs 13.3	-4.6	39.4	63.6	27	15.5	10.3	2.8

Marb **+0.50** REA **-1.11** Bfat **-0.1**

★★★★★ for Low Maintenance, Marbling, Calving Ease.

**78** **BSF NEBULA C011 N6** 

1-B 99% # 3487939 Tat.: BSF5 C011

Birth: 2-18-15

Beckton Nebula W778 J4  
 Beckton Nebula PJ S543  
 Beckton Lana S197 JT  
 BKT Clifftop TP R288  
 Beckton Lana R128 LS  
 Beckton Nebula PJ S543  
 Beckton Lana S197 JT  
 Beckton Justice C1 R483  
 BSF Regus M638 WR

**BECKTON NEBULA A394 C5**  
Ref. N  
Beckton Lana T104 CT

**BSF JUSTICIA A684 N**  
Beckton Nebula W778 J4  
BSF Justicia U855 JC

<b>DAM</b>
Age 2
Wt NA
Prog.BW 62
WR 110
YR 111
Wean Pct. NA%
Cow Eff. NA

BWt 62
WR 110
ADG 3.79
Ywt. 1143
YR 111
Scr. 32
Fr. 5.0

RAAA HerdBuilder index: **174** (Top 2% of all RA bulls)  
 RAAA GridMaster index: **51**(Top 19% of all RA bulls)

Calv.Ease	BW	WW	YW	Milk	HPG	Stay	Maint.En.
EPDs 14.6	-5.4	60.7	92.9	13	9	16.2	-0.8

Marb **+0.45** REA **-0.01** Bfat **+0.03**

★★★★★ for Low Maintenance, Growth, Marbling, Superior Cow, Calving Ease, Stayability.

**81** **BECKTON SCAMP C644 A4** 

1-A 100% # 3487223 Tat.: BKT5 C644

Birth: 4-7-15

Beckton Scamp T A825  
 Beckton Scamp 8954  
 Bkt Encino 8459 TJ  
 Beckton Hustler C2 L079  
 Bkt Pine Marie LC30 CD  
 Beckton Cody K1 P014  
 Beckton Susan R022 CQ  
 Beckton Epic T330 L5  
 Beckton Susan T048 NB

**BECKTON SCAMP X458 H3**  
Ref. S-1  
BKT Pine Marie R401 HU

**BECKTON SUSAN Z770 A**  
Beckton Accent U777 C2  
Beckton Susan W058 E

<b>DAM</b>
Age 3
Wt 965
Prog.BW 61
WR 110
YR 108
Wean Pct. 61%
Cow Eff. 128

BWt 58
WR 110
ADG 3.74
Ywt. 1192
YR 108
Scr. 37
Fr. 6.0

RAAA HerdBuilder index: **141**(Top 12% of all RA bulls)  
 RAAA GridMaster index: **52** (Top 8% of all RA bulls)

Calv.Ease	BW	WW	YW	Milk	HPG	Stay	Maint.En.
EPDs 13.9	-6.9	49.3	79.1	25	12.3	11.8	-4.9

Marb **+0.50** REA **+0.15** Bfat **-0.01**

★★★★★ for Low Maintenance, Growth, Marbling, Rib-eye area, Superior Cow, High Cow Efficiency, Calving Ease.

**79** **BECKTON ACCENT C577 N3** 

1-B 99% # 3487175 Tat.: BKB5 C577

Birth: 4-1-15

Beckton Cody K1 P014  
 Beckton Cody KH M390  
 Beckton Rose M126 WR  
 Beckton Cherokee N N479  
 Beckton Christy N740 HR  
 Beckton Nebula L P093  
 Beckton Minerva J615 VG  
 Beckton Julian G3 P608  
 BSF Lanette P754

**BECKTON ACCENT W180 C2**  
Ref. A-1  
Beckton Christy R046 CQ

**BSF LANETTE X808 N**  
Beckton Nebula T398 V3  
BSF Lanette T717 JL

<b>DAM</b>
Age 5
Wt 1030
Prog.BW 62
WR 108
YR 100
Wean Pct. 61%
Cow Eff. 129

BWt 65
WR 107
ADG 3.39
Ywt. 1116
YR 100
Scr. 36
Fr. 5.5

RAAA HerdBuilder index: **158** (Top 5% of all RA bulls)  
 RAAA GridMaster index: **51**(Top 11% of all RA bulls)

Calv.Ease	BW	WW	YW	Milk	HPG	Stay	Maint.En.
EPDs 15.2	-7.0	50.7	78	28	13.6	13.8	-3.8

Marb **+0.44** REA **+0.17** Bfat **-0.01**

★★★★★ for Low Maintenance, Marbling, Rib-eye area, High Cow Efficiency, Calving Ease, Stayability.

**82** **BECKTON LIKABLE C344 E3** 

1-A 100% # 3487418 Tat.: BKT5 C344

Birth: 3-22-15

Beckton Likable S633  
 Beckton Lancer F442 T  
 Beckton Kit F468 JL  
 Beckton Lancer F442 T  
 Beckton Kit F468 JL  
 Beckton Epic K F075  
 Beckton Minerva F495 CH  
 Beckton Lancer TS D390  
 Beckton Lana F891 JL

**BECKTON LIKABLE U130 L2**  
Ref. L-1  
Beckton Kit S478 LN

**BECKTON LANA R327 EP**  
Beckton Epic KM M115  
Beckton Lana K840 LN

<b>DAM</b>
Age 10
Wt 1290
Prog.BW 67
WR 111
YR 106
Wean Pct. 54%
Cow Eff. 114

BWt 73
WR 118
ADG 2.99
Ywt. 1183
YR 106
Scr. 39
Fr. 4.5

RAAA HerdBuilder index: **90**(Top 68% of all RA bulls)  
 RAAA GridMaster index: **47**(Top 80% of all RA bulls)

Calv.Ease	BW	WW	YW	Milk	HPG	Stay	Maint.En.
EPDs 7.6	-0.2	51.3	72	28	9.8	9.2	-5.7

Marb **+0.29** REA **-0.22** Bfat **+0.00**

★★★★★ for Low Maintenance, Growth, Marbling, Superior Cow, Calving Ease.



• Bulls •

**83** **BECKTON NEBULA C490 J5**   
 1-A 100% # 3487384 Tat.: BKT5 C490

Birth: 3-28-15

Beckton Nebula U206 V3  
**BECKTON NEBULA X096 N4**  
 Ref. N-3 Beckton Tamara U185 NB

Beckton Nebula P P707  
 Beckton Minerva J615 VG  
 Beckton Nebula P P707  
 Beckton Tamara P813 CH

Beckton Julio L233  
**BECKTON CHRISTY T410 JO**  
 Beckton Christy K101 CD

Beckton Julian G1 J526  
 Beckton Rose J725 EP  
 Beckton Cody V E023  
 Beckton Christy C306 JL

**DAM**  
 Age 8  
 Wt 1135  
 Prog.BW 71  
 WR 105  
 YR 103  
 Wean Pct. 52%  
 Cow Eff. 109

RAAA HerdBuilder index: **147** (Top 9% of all RA bulls)  
 RAAA GridMaster index: **51** (Top 14% of all RA bulls)  
 Calv.Ease BW WW YW Milk HPG Stay Maint.En.  
 EPDs **11.8 -4.5 52 83.1 23 13.6 13.6 -3.1**  
 Marb **+0.67** REA **-0.01** Bfat **+0.02**

BWt **64**  
 WR **99**  
 ADG **3.74**  
 YWt. **1150**  
 YR **103**  
 Scr. **36**  
 Fr. **4.5**

★★★★★ for Low Maintenance, Marbling, Superior Cow, Calving Ease, Stayability.

**85** **BECKTON EPIC C598 C6**   
 1-A 100% # 3487575 Tat.: BKT5 C598

Birth: 4-2-15

Beckton Epic K6 S569  
**BECKTON EPIC X464 L5**  
 Ref. E-2 Beckton Lana M393 LN

Beckton Epic KM M115  
 Beckton Sierra N703 LM  
 Beckton Lancer T3 J396  
 Beckton Lana F081 LN  
 BKT Clifftop TP R288  
 Beckton Larkabel N769 HR  
 Beckton Loki F251  
 Beckton Lydia J801 CD

Beckton Clifftop U575 H3  
**BECKTON LYDIA Y233 C**  
 Beckton Lydia M607 LO

**DAM**  
 Age 4  
 Wt 1045  
 Prog.BW 60  
 WR 103  
 YR 101  
 Wean Pct. 57%  
 Cow Eff. 121

RAAA HerdBuilder index: **148** (Top 8% of all RA bulls)  
 RAAA GridMaster index: **51** (Top 13% of all RA bulls)  
 Calv.Ease BW WW YW Milk HPG Stay Maint.En.  
 EPDs **12.7 -4.7 49.1 82.7 32 10.2 13.7 -4.8**  
 Marb **+0.58** REA **-0.05** Bfat **+0.01**

BWt **62**  
 WR **104**  
 ADG **3.39**  
 YWt. **1152**  
 YR **103**  
 Scr. **35**  
 Fr. **5.0**

★★★★★ for Low Maintenance, Marbling, High Cow Efficiency, Calving Ease, Stayability.

**84** **BECKTON NEW ERA C511 D2**   
 1-A 100% # 3487895 Tat.: BSF5 C511

Birth: 3-29-15

Beckton Nebula P P707  
**BECKTON NEW ERA Y194**  
 Ref. N-4 BKT Larkeisa T310 JC

Beckton Nebula M045  
 Beckton Lana M809 EP  
 Beckton Justice C1 R483  
 BKT Larkeisa R775 JC

Beckton Dominor ZC M919  
**BECKTON LANA P026 DM**  
 Beckton Lana M552 WR

Beckton Dominor Z E401  
 Beckton Barmaid J012 CO  
 Beckton Warrior T C371  
 Beckton Lana J235 JL

**DAM**  
 Age 11  
 Wt 1105  
 Prog.BW 67  
 WR 105  
 YR 104  
 Wean Pct. 60%  
 Cow Eff. 127

RAAA HerdBuilder index: **159** (Top 4% of all RA bulls)  
 RAAA GridMaster index: **51** (Top 18% of all RA bulls)  
 Calv.Ease BW WW YW Milk HPG Stay Maint.En.  
 EPDs **14.6 -4.7 58.7 90.5 22 13.1 13.9 -4.2**  
 Marb **+0.61** REA **-0.41** Bfat **+0.00**

BWt **65**  
 WR **116**  
 ADG **3.33**  
 YWt. **1147**  
 YR **102**  
 Scr. **34**  
 Fr. **4.5**

★★★★★ for Low Maintenance, Marbling, Superior Cow, High Cow Efficiency, Calving Ease, Stayability.

**86** **BECKTON LEGEND C359 L2**   
 1-A 100% # 3487888 Tat.: BSF5 C359

Birth: 3-23-15

Beckton Lancer F442 T  
**BECKTON LEGEND S670**  
 Ref. L Beckton Kit F468 JL

Beckton Lancer T A664  
 Bkt Suffeina A828 DM  
 Beckton Julian GG B571  
 Beckton Kit A517 NP  
 Beckton Lancer 9380  
 Beckton Coca 9119 TJ  
 Beckton Dominor 9455  
 Bkt Suffeina 9493 TT

Beckton Lancer T A664  
**BECKTON SUFFEINA P671 LN**  
 Bkt Suffeina A828 DM

**DAM**  
 Age 11  
 Wt 1260  
 Prog.BW 69  
 WR 106  
 YR 110  
 Wean Pct. 46%  
 Cow Eff. 98

RAAA HerdBuilder index: **136** (Top 15% of all RA bulls)  
 RAAA GridMaster index: **50** (Top 32% of all RA bulls)  
 Calv.Ease BW WW YW Milk HPG Stay Maint.En.  
 EPDs **9.5 -2.8 47 68.3 15 10.7 14 -7.2**  
 Marb **+0.60** REA **+0.32** Bfat **-0.02**

BWt **80**  
 WR **102**  
 ADG **3.10**  
 YWt. **1107**  
 YR **99**  
 Scr. **37**  
 Fr. **5.0**

★★★★★ for Low Maintenance, Marbling, Rib-eye area, Superior Cow, Calving Ease, Stayability.



Lot 84

**87** **BECKTON WARRIOR C314 L5**   
 1-A 100% # 3487275 Tat.: BKT5 C314

Birth: 3-21-15

Beckton Warrior C1 S337  
**BECKTON WARRIOR W534 N4**  
 Ref. W-2 BKT Larkeisa S055 NB

Beckton Warrior CL M686  
 Beckton Christy K101 CD  
 Beckton Nebula P P707  
 Beckton Larkeisa P688 CH  
 Beckton Loki C M740  
 Beckton Lakme J460 LT  
 Beckton Jules L429  
 Beckton Larkaba M715 WR

Beckton Loki CL S284  
**BECKTON LARKABA X549 L**  
 Beckton Larkaba R615 JE

**DAM**  
 Age 5  
 Wt 1215  
 Prog.BW 63  
 WR 97  
 YR 102  
 Wean Pct. 47%  
 Cow Eff. 99

RAAA HerdBuilder index: **155** (Top 5% of all RA bulls)  
 RAAA GridMaster index: **50** (Top 21% of all RA bulls)  
 Calv.Ease BW WW YW Milk HPG Stay Maint.En.  
 EPDs **16.6 -7.0 35.1 55.4 23 13.1 13.6 -5.4**  
 Marb **+0.72** REA **-0.15** Bfat **+0.04**

BWt **67**  
 WR **97**  
 ADG **3.74**  
 YWt. **1083**  
 YR **97**  
 Scr. **33**  
 Fr. **5.0**

★★★★★ for Low Maintenance, Marbling, Calving Ease, Stayability.

• Bulls •

**88 BECKTON CLIFFTOP C215 N5**  1-A 100% # 3488000 Tat.: BSF5 C215

Birth: 3-15-15

Beckton Clifftop W692 E3 < BKT Clifftop TP R288  
 Beckton Lydia S274 EP  
**BECKTON CLIFFTOP Y012 C4** Ref. C-2 < Beckton Lana W240 C < BKT Clifftop TP R288  
 Beckton Lana L923 CD  
 Beckton Nebula X353 E3 < Beckton Nebula G S237  
 Beckton Lana R058 EP  
**BECKTON LANA Z165 N** < Beckton Epic K4 N795  
 Beckton Lana L827 WR

**DAM**  
 Age 3  
 Wt 1065  
 Prog.BW 53  
 WR 96  
 YR 101  
 Wean Pct. 51%  
 Cow Eff. 106

RAAA HerdBuilder index: **165** (Top 3% of all RA bulls)  
 RAAA GridMaster index: **52** (Top 9% of all RA bulls)  
 Calv.Ease BW WW YW Milk HPG Stay Maint.En.  
 EPDs **15.3 -7.8 40.2 67.9 27 8 15 -1.4**  
 Marb **+.58** REA **+.03** Bfat **+.02**

BWt **55**  
 WR **101**  
 ADG **3.28**  
 YWt **1107**  
 YR **101**  
 Scr. **35**  
 Fr. **5.0**

★★★★★ for Low Maintenance, Marbling, Calving Ease, Stayability.

**91 BECKTON JULIAN C473 L6**  1-A 100% # 3487898 Tat.: BSF5 C473

Birth: 3-27-15

Beckton Julian G5 S107 < Beckton Julian GJ P535  
 Beckton Minola P826 DM  
**BECKTON JULIAN X465 J5** Ref. J-2 < Beckton Julian GG B571  
 Bkt Suffeina A828 DM  
 Beckton Lancer T A664 < Beckton Lancer 9380  
 Beckton Coca 9119 TJ  
**BECKTON CHRISTY N626 LN** < Beckton Copper JT G095  
 Beckton Christy K209 CO < Beckton Christy A111 VQ

**DAM**  
 Age 12  
 Wt 1200  
 Prog.BW 64  
 WR 102  
 YR 100  
 Wean Pct. 49%  
 Cow Eff. 103

RAAA HerdBuilder index: **149** (Top 8% of all RA bulls)  
 RAAA GridMaster index: **51** (Top 12% of all RA bulls)  
 Calv.Ease BW WW YW Milk HPG Stay Maint.En.  
 EPDs **12 -3.6 46 77 19 14.7 13.5 -3.2**  
 Marb **+.80** REA **-.03** Bfat **+.02**

BWt **77**  
 WR **98**  
 ADG **3.68**  
 YWt **1113**  
 YR **98**  
 Scr. **38**  
 Fr. **5.0**

★★★★★ for Low Maintenance, Marbling, Calving Ease, Stayability.

**89 BECKTON ACCENT C658 L4**  1-A 100% # 3487423 Tat.: BKT5 C658

Birth: 4-8-15

Beckton Accent U777 C2 < Beckton Cody K1 P014  
 Beckton Susan R022 CQ  
**BECKTON ACCENT Y312 N3** Ref. A-3 < Beckton Nebula P P707  
 BKT Larkeisa S055 NB < Beckton Larkeisa P688 CH  
 Beckton Lancer T5 L095 < Beckton Lancer F442 T  
 Beckton Belga J293 HR  
**BECKTON RUTH P591 LN** < RDD B Topper 1675  
 Beckton Ruth E549 TP < Beckton Ruth B634 MB

**DAM**  
 Age 11  
 Wt 1250  
 Prog.BW 72  
 WR 109  
 YR 105  
 Wean Pct. 50%  
 Cow Eff. 106

RAAA HerdBuilder index: **144** (Top 10% of all RA bulls)  
 RAAA GridMaster index: **48** (Top 68% of all RA bulls)  
 Calv.Ease BW WW YW Milk HPG Stay Maint.En.  
 EPDs **10.6 -3.5 49.2 73.5 23 11.4 15.2 -2.7**  
 Marb **+.31** REA **-.18** Bfat **+.02**

BWt **75**  
 WR **105**  
 ADG **3.91**  
 YWt **1159**  
 YR **102**  
 Scr. **33**  
 Fr. **5.0**

★★★★★ for Low Maintenance, Marbling, Superior Cow, Calving Ease, Stayability.



Lot 92

**90 BECKTON HERITAGE C655 D4**  1-A 100% # 3487761 Tat.: BSF5 C655

Birth: 4-8-15

Beckton Heritage T270 J2 < Beckton Heritage N013  
 Beckton Coca P602 JL  
**BECKTON HERITAGE X403 L3** Ref. H-1 < Beckton Lancer TE F363  
 Beckton Indigo H150 LN < Beckton Indigo F376 CT  
 Beckton Dominor Z1 R610 < Beckton Dominor ZC M919  
 Beckton Sierra K557 LO  
**BECKTON CHRISTY X648 D** < Beckton Julian GG B571  
 Beckton Christy J743 JL < Beckton Christy A111 VQ

**DAM**  
 Age 5  
 Wt 1140  
 Prog.BW 64  
 WR 104  
 YR 104  
 Wean Pct. 53%  
 Cow Eff. 111

RAAA HerdBuilder index: **149** (Top 8% of all RA bulls)  
 RAAA GridMaster index: **49** (Top 38% of all RA bulls)  
 Calv.Ease BW WW YW Milk HPG Stay Maint.En.  
 EPDs **14 -4.5 53.9 77.9 22 15.2 12.9 -2.5**  
 Marb **+.62** REA **+.06** Bfat **+.08**

BWt **71**  
 WR **102**  
 ADG **3.51**  
 YWt **1137**  
 YR **101**  
 Scr. **35**  
 Fr. **4.5**

★★★★★ for Low Maintenance, Marbling, Superior Cow, Calving Ease.

**92 BECKTON NOMAD C373 D3**  1-A 100% # 3487891 Tat.: BSF5 C373

Birth: 3-24-15

Beckton Nomad 7496 < Beckton Neva 5562  
 Bkt Bolt Tamrck 3913  
**BECKTON NOMAD V 9871** Ref. V-1 < Beckton Varo 5642  
 Bkt Lahrogno-3  
 Beckton Dominor Z E401 < Beckton Dominor 9455  
 Beckton Belga B061 ZN  
**BECKTON MARTA P484 DM** < Beckton Lancer T A664  
 Beckton Marta K254 LN < Beckton Marta G512 LN

**DAM**  
 Age 11  
 Wt 1310  
 Prog.BW 73  
 WR 108  
 YR 106  
 Wean Pct. 45%  
 Cow Eff. 95

RAAA HerdBuilder index: **115** (Top 36% of all RA bulls)  
 RAAA GridMaster index: **48** (Top 67% of all RA bulls)  
 Calv.Ease BW WW YW Milk HPG Stay Maint.En.  
 EPDs **14.3 -5.2 43.7 58.7 20 11 9.8 -11.7**  
 Marb **+.34** REA **-.19** Bfat **-.02**

BWt **77**  
 WR **103**  
 ADG **3.22**  
 YWt **1128**  
 YR **101**  
 Scr. **37**  
 Fr. **5.0**

★★★★★ for Low Maintenance, Marbling, Superior Cow, Calving Ease.

• Bulls •

**93** **BSF LEGEND C469 L2** 

1-B 99% # 3487789 Tat.: BSF5 C469

Birth: 3-27-15

Beckton Lancer F442 T  
**BECKTON LEGEND S670**  
 Ref. L Beckton Kit F468 JL

Beckton Lancer T A664  
 Bkt Suffeina A828 DM  
 Beckton Julian GG B571  
 Beckton Kit A517 NP  
 Beckton Likable S633  
 Beckton Lana S718 LN  
 Beckton Nebula EN S347  
 BSF Crusita S081 EP

BWt **67**  
 WR **114**  
 ADG **2.64**  
 YWt. **1127**  
 YR **101**  
 Scr. **38**  
 Fr. **5.0**

Beckton Likable U120 L2  
**BSF CRUSITA X071 L**  
 BSF Crusita U036 NB

**DAM**  
 Age 5  
 Wt 1050  
 Prog.BW 61  
 WR 112  
 YR 107  
 Wean Pct. 65%  
 Cow Eff. 136

RAAA HerdBuilder index: **164** (Top 3% of all RA bulls)  
 RAAA GridMaster index: **52** (Top 8% of all RA bulls)  
 Calv.Ease BW WW YW Milk HPG Stay Maint.En.  
 EPDs **11.3 -5.8 48.4 63.6 21 10.9 15.9 -13.3**  
 Marb **+1.09** REA **+2.1** Bfat **+0.3**

★★★★★ for Low Maintenance, Marbling, Rib-eye area, Superior Cow, High Cow Efficiency, Calving Ease, Stayability.

**96** **BSF HERITAGE C283 N4** 

1-B 99% # 3487824 Tat.: BSF5 C283

Birth: 3-19-15

Beckton Heritage T270 J2  
**BECKTON HERITAGE X403 L3**  
 Ref. H-1 Beckton Indigo H150 LN

Beckton Heritage N013  
 Beckton Coca P602 JL  
 Beckton Lancer TE F363  
 Beckton Indigo F376 CT  
 Beckton Nebula L P093  
 Beckton Minerva J615 VG  
 Beckton Julian 7526G

BWt **84**  
 WR **98**  
 ADG **3.91**  
 YWt. **1098**  
 YR **97**  
 Scr. **35**  
 Fr. **5.0**

Beckton Nebula T398 V3  
**BSF NEBULANN W084 N**  
 BSF Regina T673

**DAM**  
 Age 6  
 Wt 1260  
 Prog.BW 71  
 WR 103  
 YR 102  
 Wean Pct. 48%  
 Cow Eff. 101

RAAA HerdBuilder index: **121** (Top 28% of all RA bulls)  
 RAAA GridMaster index: **48** (Top 67% of all RA bulls)  
 Calv.Ease BW WW YW Milk HPG Stay Maint.En.  
 EPDs **8.8 -2.8 52 73.2 21 11.6 12.3 -3.1**  
 Marb **+5.0** REA **-1.1** Bfat **+0.4**

★★★★★ for Low Maintenance, Marbling, Calving Ease.

**94** **BSF NEBULA C542 J6** 

1-B 99% # 3487717 Tat.: BSF5 C542

Birth: 3-30-15

Beckton Nebula W778 J4  
**BECKTON NEBULA Y002 C5**  
 Ref. N BKT Pine Marie W102 C

Beckton Nebula PJ S543  
 Beckton Lana S197 JT  
 BKT Clifftop TP R288  
 BKT Pine Marie M119 EP  
 Beckton Julian U699 L5  
 Beckton Lana U329 EP  
 Beckton Jet U473 L2  
 BSF Justicia U855 JC

BWt **76**  
 WR **113**  
 ADG **3.85**  
 YWt. **1206**  
 YR **109**  
 Scr. **36**  
 Fr. **5.5**

Beckton Julian X721 E6  
**BSF JUSTICIA Z119 J**  
 BSF Justicia X113 J

**DAM**  
 Age 3  
 Wt 1060  
 Prog.BW 65  
 WR 113  
 YR 109  
 Wean Pct. 57%  
 Cow Eff. 120

RAAA HerdBuilder index: **184** (Top 1% of all RA bulls)  
 RAAA GridMaster index: **50** (Top 28% of all RA bulls)  
 Calv.Ease BW WW YW Milk HPG Stay Maint.En.  
 EPDs **13.7 -5.7 56.9 83 20 10.5 17.7 -2.7**  
 Marb **+4.5** REA **+0.2** Bfat **+0.3**

★★★★★ for Low Maintenance, Growth, Marbling, Superior Cow, High Cow Efficiency, Calving Ease, Stayability.

**97** **BSF SCAMP C616 E4** 

1-B 99% # 3487649 Tat.: BSF5 C616

Birth: 4-4-15

Beckton Scamp T A825  
**BECKTON SCAMP X494 E3**  
 Ref. S-2 Beckton Lana S074 EP

Beckton Scamp 8954  
 Bkt Encino 8459 TJ  
 Beckton Epic KH P678  
 Beckton Lana P317 JL  
 Beckton Epic KJ J722  
 Beckton Sierra J789 EP  
 Beckton Epic D404  
 BSF Regus K132 CO

BWt **74**  
 WR **95**  
 ADG **4.25**  
 YWt. **1135**  
 YR **101**  
 Scr. **36**  
 Fr. **5.5**

Beckton Epic K4 N795  
**BSF ERICA R006 EP**  
 BSF Erica N231 EP

**DAM**  
 Age 10  
 Wt 1210  
 Prog.BW 68  
 WR 105  
 YR 106  
 Wean Pct. 47%  
 Cow Eff. 98

RAAA HerdBuilder index: **104** (Top 51% of all RA bulls)  
 RAAA GridMaster index: **50** (Top 24% of all RA bulls)  
 Calv.Ease BW WW YW Milk HPG Stay Maint.En.  
 EPDs **10.8 -4.5 44.6 77.8 22 10.5 8.9 -5.4**  
 Marb **+3.7** REA **+0.0** Bfat **+0.0**

★★★★★ for Low Maintenance, Gainability, Marbling, Superior Cow, Calving Ease.

**95** **BSF LIKABLE C504 E4** 

1-B 99% # 3487829 Tat.: BSF5 C504

Birth: 3-29-15

Beckton Likable U130 L2  
**BECKTON LIKABLE Y362 L3**  
 Ref. L-3 Beckton Tamara M515 LN

Beckton Likable S633  
 Beckton Kit S478 LN  
 Beckton Lancer TA K644  
 Beckton Tamara K322 LN  
 Beckton Epic K4 N795  
 Beckton Tara M635 JL  
 Beckton Cody KH M390  
 BSF Red K467 CD

BWt **76**  
 WR **106**  
 ADG **3.33**  
 YWt. **1148**  
 YR **102**  
 Scr. **35**  
 Fr. **5.0**

Beckton Epitomy S250  
**BSF CODETTE U667 EY**  
 BSF Codette S177 CD

**DAM**  
 Age 7  
 Wt 1110  
 Prog.BW 71  
 WR 104  
 YR 103  
 Wean Pct. 57%  
 Cow Eff. 119

RAAA HerdBuilder index: **126** (Top 24% of all RA bulls)  
 RAAA GridMaster index: **50** (Top 24% of all RA bulls)  
 Calv.Ease BW WW YW Milk HPG Stay Maint.En.  
 EPDs **11.2 -3.8 46.1 77.3 20 10.3 11.9 -4.4**  
 Marb **+6.4** REA **-0.9** Bfat **+0.4**

★★★★★ for Low Maintenance, Marbling, High Cow Efficiency, Calving Ease.

**98** **BSF WARRIOR C363 J6** 

1-B 99% # 3487880 Tat.: BSF5 C363

Birth: 3-23-15

Beckton Warrior W534 N4  
**BECKTON WARRIOR Y108 E5**  
 Ref. W-3 Beckton Susan W058 E

Beckton Warrior C1 S337  
 BKT Larkeisa S055 NB  
 Beckton Epic T330 L5  
 Beckton Susan T048 NB  
 Beckton Justice G302  
 Bkt Larkabel C742 CF  
 Beckton Lancer F442 T  
 BSF Regus J155

BWt **62**  
 WR **98**  
 ADG **3.68**  
 YWt. **1102**  
 YR **98**  
 Scr. **36**  
 Fr. **5.0**

Beckton Justice C K449  
**BSF JUSTICIA R553 JC**  
 BSF Regus L104 LN

**DAM**  
 Age 10  
 Wt 1200  
 Prog.BW 74  
 WR 105  
 YR 103  
 Wean Pct. 48%  
 Cow Eff. 102

RAAA HerdBuilder index: **149** (Top 7% of all RA bulls)  
 RAAA GridMaster index: **51** (Top 14% of all RA bulls)  
 Calv.Ease BW WW YW Milk HPG Stay Maint.En.  
 EPDs **14.7 -6.3 52.8 81.5 23 12 13 -3.5**  
 Marb **+4.8** REA **+0.8** Bfat **+0.0**

★★★★★ for Low Maintenance, Marbling, Calving Ease, Stayability.



• Bulls •



**101** **BSF NEBULA C527 R5** 

1-B 99% # 3487855 Tat.: BSF5 C527

Birth: 3-30-15

Beckton Nebula U206 V3  
Beckton Minerva J615 VG  
Beckton Nebula P P707  
Beckton Tamara P813 CH

**BECKTON NEBULA X096 N4**  
Ref. N-3  
Beckton Roman J S158  
TR Romeo NT379  
Beckton Belga K285 JL

**BSF LANETTE U009 RA**  
BSF Lanette S490 HW  
Beckton Hawk P248  
BSF Lanette P804

BWT	62
WR	102
ADG	3.68
YWt.	1107
YR	99
Scr.	36
Fr.	5.5

RAAA HerdBuilder index: **147** (Top 9% of all RA bulls)  
RAAA GridMaster index: **50** (Top 21% of all RA bulls)

Calv.Ease	BW	WW	YW	Milk	HPG	Stay	Maint.En.	
EPDs	12.4	-4.7	53.6	79.6	28	9.5	14.5	3.8

Marb **+0.55** REA **+0.09** Bfat **+0.00**

★★★★★ for Low Maintenance, Marbling, Superior Cow, Calving Ease, Stayability.

**99** **BSF EPIC C648 S6** 

1-B 99% # 3487718 Tat.: BSF5 C648

Birth: 4-7-15

Beckton Epic K6 S569  
Beckton Sierra N703 LM  
Beckton Epic KM M115  
Beckton Sierra N703 LM

**BECKTON EPIC X464 L5**  
Ref. E-2  
Beckton Lana M393 LN  
Beckton Lancer T3 J396  
Beckton Lana F081 LN

**BSF JULIA Z100 S**  
Beckton Scamp X494 E3  
Beckton Scamp T A825  
Beckton Lana S074 EP  
Beckton Loki CL S284  
BSF Julia X294 L  
BSF Julia S423 JO

BWT	76
WR	119
ADG	3.62
YWt.	1190
YR	108
Scr.	36
Fr.	5.5

RAAA HerdBuilder index: **139** (Top 13% of all RA bulls)  
RAAA GridMaster index: **49** (Top 43% of all RA bulls)

Calv.Ease	BW	WW	YW	Milk	HPG	Stay	Maint.En.	
EPDs	11.3	-3.5	57.8	88.3	29	10.3	13.5	-2.8

Marb **+0.34** REA **-0.10** Bfat **+0.01**

★★★★★ for Low Maintenance, Growth, Marbling, High Cow Efficiency, Calving Ease, Stayability.

**102** **BECKTON JANUS C341 C3** 

1-A 100% # 3487713 Tat.: BSF5 C341

Birth: 3-22-15

Beckton Roman J S158  
TR Romeo NT379  
Beckton Belga K285 JL

**BECKTON JANUS X799 L2**  
Ref. J-3  
Beckton Sierra K557 LO  
Beckton Loki F251  
Beckton Sierra C157 CL

**BECKTON MONA Z270 C**  
Beckton Clifftop W577 E3  
BKT Clifftop TP R288  
Beckton Cody K2 R168  
Beckton Mona U584 CD  
Beckton Mona P539 CH

BWT	59
WR	100
ADG	4.08
YWt.	1169
YR	106
Scr.	32
Fr.	5.0

RAAA HerdBuilder index: **154** (Top 6% of all RA bulls)  
RAAA GridMaster index: **51** (Top 12% of all RA bulls)

Calv.Ease	BW	WW	YW	Milk	HPG	Stay	Maint.En.	
EPDs	15.4	-6.2	45.9	81.3	27	10.3	13.7	1.7

Marb **+0.43** REA **+0.25** Bfat **+0.06**

★★★★★ for Low Maintenance, Growth, Gainability, Marbling, Rib-eye area, Superior Cow, Calving Ease, Stayability.

**100** **BSF EMPEROR C336 N4** 

1-B 99% # 3487991 Tat.: BSF5 C336

Birth: 3-22-15

Beckton Emperor T641 E2  
Beckton Vernice R416 EP  
Beckton Jet L P491  
Beckton Indigo P676 LN

**BECKTON EMPEROR Y459 J3**  
Ref. E-3  
Beckton Indigo S354 JT  
Beckton Nomad V 9871  
Beckton Birdie S110 NB

**BSF LAUREL Z262 N**  
Beckton Nomad X290 N3  
Beckton Birdie S110 NB  
Beckton Epic U126 J5  
BSF Laurel U629 WR

BWT	65
WR	109
ADG	3.22
YWt.	1138
YR	103
Scr.	37
Fr.	5.5

RAAA HerdBuilder index: **135** (Top 15% of all RA bulls)  
RAAA GridMaster index: **51** (Top 18% of all RA bulls)

Calv.Ease	BW	WW	YW	Milk	HPG	Stay	Maint.En.	
EPDs	13.7	-6.4	52	73.1	19	9.9	11.7	-7.8

Marb **+0.53** REA **+0.13** Bfat **-0.02**

★★★★★ for Low Maintenance, Marbling, Rib-eye area, Superior Cow, Calving Ease.

**103** **BSF ACCENT C100 E4** 

1-B 99% # 3487949 Tat.: BSF5 C100

Birth: 2-28-15

Beckton Accent U777 C2  
Beckton Cody K1 P014  
Beckton Susan R022 CQ

**BECKTON ACCENT A485 C3**  
Ref. A-7  
Beckton Tamara R175 CQ  
Beckton Cherokee N N479  
Beckton Tamara N765 CO

**BSF ERICA A582 E**  
Beckton Epic Y484 N6  
Beckton Lydia S069 NB  
Beckton Julian W841 J5  
BSF Erica W053 R

BWT	62
WR	103
ADG	3.97
YWt.	1095
YR	106
Scr.	35
Fr.	5.5

RAAA HerdBuilder index: **165** (Top 3% of all RA bulls)  
RAAA GridMaster index: **50** (Top 20% of all RA bulls)

Calv.Ease	BW	WW	YW	Milk	HPG	Stay	Maint.En.	
EPDs	12.2	-4.7	51.8	82	27	13.6	16.1	-2.9

Marb **+0.43** REA **+0.33** Bfat **+0.02**

★★★★★ for Low Maintenance, Growth, Marbling, Rib-eye area, High Cow Efficiency, Calving Ease, Stayability.

• Bulls •



**104** **BSF JANUS C745 W3** 

1-B 99% # 3487833 Tat.: BSF5 C745

Birth: 4-19-15

Beckton Roman J S158  
**BECKTON JANUS X799 L2**  
 Ref. J-3 Beckton Sierra K557 LO

Beckton Warrior N645 T1  
**BSF WENDIE U579 WR**  
 BSF Regus L009 JL

TR Romeo NT379  
 Beckton Belga K285 JL  
 Beckton Loki F251  
 Beckton Sierra C157 CL  
 Beckton Warrior T1 H281  
 Beckton Rose H074 EP  
 Beckton Julian G1 J526  
 BSF Regus J082

BWt **76**  
 WR **109**  
 ADG **4.32**  
 YWt **1245**  
 YR **111**  
 Scr. **37**  
 Fr. **6.0**

**DAM**  
 Age 7  
 Wt 1270  
 Prog.BW 78  
 WR 109  
 YR 110  
 Wean Pct. 51%  
 Cow Eff. 107

RAAA HerdBuilder index: **118**(Top 32% of all RA bulls)  
 RAAA GridMaster index: **51**(Top 17% of all RA bulls)  
 Calv.Ease BW WW YW Milk HPG Stay Maint.En.  
 EPDs **10.9 -2.9 66.5 108.8 25 11.4 10.1 3.6**  
 Marb **+0.34** REA **+0.02** Bfat **+0.00**

★★★★★ for Low Maintenance, Growth, Gainability, Marbling, Superior Cow, Calving Ease.

**105** **BSF EPIC C717 E6** 

1-B 99% # 3488001 Tat.: BSF5 C717

Birth: 4-15-15

Beckton Epic K6 S569  
**BECKTON EPIC X464 L5**  
 Ref. E-2 Beckton Lana M393 LN

Beckton Epic X330 L6  
**BSF JEWEL Z159 E**  
 BSF Jewel X572 L

Beckton Epic KM M115  
 Beckton Sierra N703 LM  
 Beckton Lancer T3 J396  
 Beckton Lana F081 LN  
 Beckton Epic T330 L5  
 Beckton Kit R503 LN  
 Beckton Loki CL S284  
 BSF Jewel T380 JL

BWt **70**  
 WR **114**  
 ADG **4.43**  
 YWt **1246**  
 YR **113**  
 Scr. **36**  
 Fr. **6.0**

**DAM**  
 Age 3  
 Wt 960  
 Prog.BW 69  
 WR 108  
 YR 108  
 Wean Pct. 64%  
 Cow Eff. 135

RAAA HerdBuilder index: **144**(Top 10% of all RA bulls)  
 RAAA GridMaster index: **52** (Top 4% of all RA bulls)  
 Calv.Ease BW WW YW Milk HPG Stay Maint.En.  
 EPDs **11.9 -4.1 64.6 110.6 28 9.3 13 -3.2**  
 Marb **+0.54** REA **+0.12** Bfat **+0.01**

★★★★★ for Low Maintenance, Growth, Gainability, Marbling, Superior Cow, High Cow Efficiency, Calving Ease, Stayability.

**107** **BECKTON EPIC C751 D6** 

1-A 100% # 3487821 Tat.: BSF5 C751

Birth: 4-19-15

Beckton Epic K6 S569  
**BECKTON EPIC X464 L5**  
 Ref. E-2 Beckton Lana M393 LN

Beckton Dominor Z1 R610  
**BECKTON MINOLA W150 D**  
 Beckton Minola P611 JL

Beckton Epic KM M115  
 Beckton Sierra N703 LM  
 Beckton Lancer T3 J396  
 Beckton Lana F081 LN  
 Beckton Dominor ZC M919  
 Beckton Sierra K557 LO  
 Beckton Julian G1 J526  
 Beckton Minola K428 HD

BWt **71**  
 WR **103**  
 ADG **3.30**  
 YWt **1132**  
 YR **101**  
 Scr. **40**  
 Fr. **6.0**

**DAM**  
 Age 6  
 Wt 1235  
 Prog.BW 68  
 WR 106  
 YR 103  
 Wean Pct. 49%  
 Cow Eff. 104

RAAA HerdBuilder index: **155** (Top 5% of all RA bulls)  
 RAAA GridMaster index: **51**(Top 17% of all RA bulls)  
 Calv.Ease BW WW YW Milk HPG Stay Maint.En.  
 EPDs **14.2 -5.0 54.6 90.5 31 12.4 13.7 -0.9**  
 Marb **+0.40** REA **+0.00** Bfat **+0.01**

★★★★★ for Low Maintenance, Marbling, Calving Ease, Stayability.

**106** **BECKTON JANUS C757 H3** 

1-A 100% # 3487342 Tat.: BKT5 C757

Birth: 4-20-15

Beckton Roman J S158  
**BECKTON JANUS X799 L2**  
 Ref. J-3 Beckton Sierra K557 LO

Beckton Heritage T270 J2  
**BECKTON FIREFLY W021 H**  
 Beckton Firefly T028 JR

TR Romeo NT379  
 Beckton Belga K285 JL  
 Beckton Loki F251  
 Beckton Sierra C157 CL  
 Beckton Heritage N013  
 Beckton Coca P602 JL  
 Beckton Jupiter R478  
 Beckton Firefly R151 LS

BWt **83**  
 WR **110**  
 ADG **3.24**  
 YWt **1141**  
 YR **102**  
 Scr. **34**  
 Fr. **6.0**

**DAM**  
 Age 6  
 Wt 1105  
 Prog.BW 78  
 WR 113  
 YR 106  
 Wean Pct. 59%  
 Cow Eff. 124

RAAA HerdBuilder index: **111**(Top 41% of all RA bulls)  
 RAAA GridMaster index: **49**(Top 56% of all RA bulls)  
 Calv.Ease BW WW YW Milk HPG Stay Maint.En.  
 EPDs **9.2 -2.0 60.1 87.2 28 9.4 11.1 2.1**  
 Marb **+0.38** REA **+0.03** Bfat **+0.01**

★★★★★ for Low Maintenance, Marbling, Superior Cow, High Cow Efficiency, Calving Ease.

**108** **BSF JULIAN C788 R6** 

1-B 99% # 3487671 Tat.: BSF5 C788

Birth: 4-25-15

Beckton Julian G5 S107  
**BECKTON JULIAN X465 J5**  
 Ref. J-2 Beckton Suffeina P643 JL

Beckton Ranger T603 H3  
**BSF ERICA W053 R**  
 BSF Erica T609 EP

Beckton Julian GJ P535  
 Beckton Minola P826 DM  
 Beckton Julian GG B571  
 Bkt Suffeina A828 DM  
 Beckton Ranger 9479R  
 Beckton Rose N044 HU  
 Beckton Epic KM M115  
 BSF Red G329

BWt **71**  
 WR **108**  
 ADG **4.15**  
 YWt **1139**  
 YR **111**  
 Scr. **35**  
 Fr. **6.0**

**DAM**  
 Age 6  
 Wt 1270  
 Prog.BW 65  
 WR 103  
 YR 103  
 Wean Pct. 40%  
 Cow Eff. 83

RAAA HerdBuilder index: **135**(Top 16% of all RA bulls)  
 RAAA GridMaster index: **51**(Top 11% of all RA bulls)  
 Calv.Ease BW WW YW Milk HPG Stay Maint.En.  
 EPDs **11.6 -3.6 52 88 19 13.8 11.6 -4.9**  
 Marb **+0.76** REA **-0.19** Bfat **+0.02**

★★★★★ for Low Maintenance, Growth, Gainability, Marbling, Calving Ease.

• Bulls •

**109** BECKTON NEBULA C715 W5  
1-A 100% # 3487746 Tat.: BSF5 C715 

Birth: 4-15-15

Beckton Nebula U206 V3  
**BECKTON NEBULA X096 N4**  
Ref. N-3  
Beckton Tamara U185 NB

Beckton Nebula P P707  
Beckton Minerva J615 VG  
Beckton Nebula P P707  
Beckton Tamara P813 CH

BWt **89**  
WR **104**  
ADG **3.86**  
YWt. **1188**  
YR **105**  
Scr. **37**  
Fr. **5.5**

Beckton Warrior U636 J5  
**BECKTON DINAH Y170 W**  
Beckton Dinah K287 HU  
Beckton Lydia H159 JL  
Beckton Hustler C G407  
Beckton Dinah G334 CT

**DAM**  
Age 4  
Wt 1175  
Prog.BW 76  
WR 106  
YR 105  
Wean Pct. 53%  
Cow Eff. 111

RAAA HerdBuilder index: **143** (Top 10% of all RA bulls)  
RAAA GridMaster index: **52** (Top 8% of all RA bulls)  
Calv.Ease BW WW YW Milk HPG Stay Maint.En.  
EPDs **10.5 -2.5 64.8 106.9 19 13.4 12.7 1.1**  
Marb **+0.56** REA **+0.09** Bfat **-0.01**

**112** BECKTON EPIC C030 N8  
1-A 100% # 3487611 Tat.: BKT5 C030 

Birth: 2-21-15

Beckton Epic X330 L6  
**BECKTON EPIC A587 N7**  
Ref. E-7  
Beckton Lana W113 N

Beckton Epic T330 L5  
Beckton Kit R503 LN  
Beckton Nebula T252 L3  
Beckton Lana T226 NB  
Beckton Nebula M045  
Beckton Lana M809 EP  
Beckton Warrior T248 L5  
Beckton Lana T369 JL

BWt **58**  
WR **98**  
ADG **3.56**  
YWt. **1055**  
YR **102**  
Scr. **33**  
Fr. **5.0**

Beckton Nebula P P707  
**BECKTON LANA A200 N**  
Beckton Lana W123 W

**DAM**  
Age 2  
Wt 835  
Prog.BW 59  
WR 93  
YR 100  
Wean Pct. 54%  
Cow Eff. 114

RAAA HerdBuilder index: **176** (Top 1% of all RA bulls)  
RAAA GridMaster index: **51** (Top 12% of all RA bulls)  
Calv.Ease BW WW YW Milk HPG Stay Maint.En.  
EPDs **13 -5.3 47.5 83.7 18 12.9 16.6 -4.4**  
Marb **+0.48** REA **+0.05** Bfat **+0.02**

★★★★★ for Low Maintenance, Marbling, Superior Cow, Calving Ease.

★★★★★ for Low Maintenance, Marbling, Calving Ease, Stayability.

**110** BSF EPIC C561 C7  
1-B 99% # 3487710 Tat.: BSF5 C561 

Birth: 3-31-15

Beckton Epic U749 D5  
**BECKTON EPIC Y484 N6**  
Ref. E-4  
Beckton Lydia S069 NB

Beckton Epic K4 N795  
Beckton Denise R308 DM  
Beckton Nebula P P707  
Beckton Lydia P583 WR  
BKT Clifftop TP R288  
Beckton Lydia S274 EP  
Beckton Warrior N645 T1  
BSF Laurel R107 JJ

BWt **67**  
WR **106**  
ADG **3.39**  
YWt. **1150**  
YR **104**  
Scr. **36**  
Fr. **5.5**

Beckton Clifftop W692 E3  
**BSF LAUREL Z303 C**  
BSF Laurel U629 WR

**DAM**  
Age 3  
Wt 1120  
Prog.BW 66  
WR 104  
YR 101  
Wean Pct. 51%  
Cow Eff. 107

RAAA HerdBuilder index: **155** (Top 5% of all RA bulls)  
RAAA GridMaster index: **51** (Top 18% of all RA bulls)  
Calv.Ease BW WW YW Milk HPG Stay Maint.En.  
EPDs **12.7 -4.2 61.2 97.6 20 12 14.1 0.6**  
Marb **+0.35** REA **+0.39** Bfat **+0.04**

★★★★★ for Low Maintenance, Marbling, Rib-eye area, Calving Ease, Stayability.

**113** BECKTON EPIC C574 N7  
1-A 100% # 3487823 Tat.: BSF5 C574 

Birth: 4-1-15

Beckton Epic T330 L5  
**BECKTON EPIC X330 L6**  
Ref. E-1  
Beckton Kit R503 LN

Beckton Epic K4 N795  
Beckton Belga K202 LN  
Beckton Lancer F442 T  
Beckton Kit F468 JL  
Beckton Nebula L P093  
Beckton Vernice L382 LN  
Beckton Nebula E P084  
Beckton Lana P026 DM

BWt **67**  
WR **97**  
ADG **4.02**  
YWt. **1130**  
YR **101**  
Scr. **36**  
Fr. **5.0**

Beckton Nebula T252 L3  
**BECKTON LANA W113 N**  
Beckton Lana T226 NB

**DAM**  
Age 6  
Wt 1135  
Prog.BW 73  
WR 97  
YR 103  
Wean Pct. 51%  
Cow Eff. 106

RAAA HerdBuilder index: **156** (Top 5% of all RA bulls)  
RAAA GridMaster index: **52** (Top 8% of all RA bulls)  
Calv.Ease BW WW YW Milk HPG Stay Maint.En.  
EPDs **12.2 -5.9 49.1 85.6 18 11.3 14.2 -5.8**  
Marb **+0.52** REA **+0.31** Bfat **+0.05**

★★★★★ for Low Maintenance, Gainability, Marbling, Rib-eye area, Calving Ease, Stayability.

**111** BSF ACCENT C263 4  
3 75% # 3487894 Tat.: BSF5 C263 

Birth: 3-18-15

Beckton Accent U777 C2  
**BECKTON ACCENT Y312 N3**  
Ref. A-3  
BKT Larkeisa S055 NB

Beckton Cody K1 P014  
Beckton Susan R022 CQ  
Beckton Nebula P P707  
Beckton Larkeisa P688 CH

BWt **72**  
WR **97**  
ADG **3.45**  
YWt. **1093**  
YR **98**  
Scr. **36**  
Fr. **5.0**

Pinzgauer sire  
**BKT PINZGAUER P217**  
Beckton Firefly E020 WR  
Beckton Warrior C C355  
Beckton Firefly C394 RN

**DAM**  
Age 11  
Wt 1440  
Prog.BW 81  
WR 110  
YR 104  
Wean Pct. 39%  
Cow Eff. 81

RAAA HerdBuilder index: **111** (Top 41% of all RA bulls)  
RAAA GridMaster index: **48** (Top 63% of all RA bulls)  
Calv.Ease BW WW YW Milk HPG Stay Maint.En.  
EPDs **12.2 -3.3 44.3 65.9 23 12.3 10.3 -7.1**  
Marb **+0.43** REA **-0.08** Bfat **+0.02**

★★★★★ for Low Maintenance, Marbling, Superior Cow, Calving Ease.





• Bulls •

**114** **BECKTON SCAMP C105 E5** 

1-A 100% # 3487646 Tat.: BSF5 C105

Birth: 3-1-15

Beckton Scamp X494 E3  
**BECKTON SCAMP A627 J4**  
 Ref. S-4 Beckton Serena R023 JC

Beckton Epic X330 L6  
**BECKTON LANA A642 E**  
 Beckton Lana X410 R

Beckton Scamp T A825  
 Beckton Lana S074 EP  
 Beckton Justice Cc N265  
 Beckton Serena N469 JC  
 Beckton Epic T330 L5  
 Beckton Kit R503 LN  
 Beckton Ranger T603 H3  
 Beckton Lana S866 CH

BWt **61**  
 WR **98**  
 ADG **3.97**  
 YWt **1098**  
 YR **102**  
 Scr. **36**  
 Fr. **5.0**

**DAM**  
 Age 2  
 Wt 865  
 Prog.BW 61  
 WR 98  
 YR 102  
 Wean Pct. 57%  
 Cow Eff. 121

RAAA HerdBuilder index: **128**(Top **22%** of all RA bulls)  
 RAAA GridMaster index: **50**(Top **26%** of all RA bulls)  
 Calv.Ease BW WW YW Milk HPG Stay Maint.En.  
 EPDs **13.9 -6.1 41 70.3 19 12.1 10.7 -7.4**  
 Marb **+0.31** REA **+0.25** Bfat **+0.03**

**117** **BECKTON LIKABLE C672 E3** 

1-A 100% # 3487241 Tat.: BKT5 C672

Birth: 4-10-15

Beckton Likable S633  
**BECKTON LIKABLE U130 L2**  
 Ref. L-1 Beckton Kit S478 LN

Beckton Emcee S466  
**BECKTON LANA Z555 E**  
 Beckton Lana W335 L

Beckton Lancer F442 T  
 Beckton Kit F468 JL  
 Beckton Lancer F442 T  
 Beckton Kit F468 JL  
 Beckton Epic K4 N795  
 Beckton Larkaba H798 WR  
 Beckton Loki CL S284  
 Beckton Lana M372 WR

BWt **80**  
 WR **104**  
 ADG **3.45**  
 YWt **1150**  
 YR **104**  
 Scr. **36**  
 Fr. **5.5**

**DAM**  
 Age 3  
 Wt 1170  
 Prog.BW 72  
 WR 102  
 YR 101  
 Wean Pct. 48%  
 Cow Eff. 100

RAAA HerdBuilder index: **117**(Top **33%** of all RA bulls)  
 RAAA GridMaster index: **50**(Top **31%** of all RA bulls)  
 Calv.Ease BW WW YW Milk HPG Stay Maint.En.  
 EPDs **8.2 -2.3 58.1 88.6 15 10.2 11.6 -3.0**  
 Marb **+0.51** REA **+0.35** Bfat **+0.03**

★★★★★ for Low Maintenance, Marbling, Rib-eye area, High Cow Efficiency, Calving Ease.

★★★★★ for Low Maintenance, Marbling, Rib-eye area, Calving Ease.

**115** **BECKTON CLIFFTOP C621 N4** 

1-A 100% # 3487583 Tat.: BKT5 C621

Birth: 4-5-15

BKT Clifftop TP R288  
**BECKTON CLIFFTOP W692 E3**  
 Ref. C-1 Beckton Lydia S274 EP

Beckton Nebula W130 D3  
**BECKTON LARKABA Y083 N**  
 Beckton Larkaba W264 W

Beckton Clifftop T C075  
 Beckton Christy K209 CO  
 Beckton Epic KM M115  
 Beckton Lydia M607 LO  
 Beckton Nebula T269 E2  
 Beckton Firefly T006 DM  
 Beckton Warrior T248 L5  
 Beckton Larkaba T418 WA

BWt **73**  
 WR **97**  
 ADG **4.02**  
 YWt **1146**  
 YR **102**  
 Scr. **36**  
 Fr. **5.0**

**DAM**  
 Age 4  
 Wt 1190  
 Prog.BW 68  
 WR 102  
 YR 98  
 Wean Pct. 46%  
 Cow Eff. 98

RAAA HerdBuilder index: **161** (Top **4%** of all RA bulls)  
 RAAA GridMaster index: **50**(Top **28%** of all RA bulls)  
 Calv.Ease BW WW YW Milk HPG Stay Maint.En.  
 EPDs **11.3 -4.0 50.4 86.3 22 14 15.4 -0.8**  
 Marb **+0.44** REA **-0.19** Bfat **+0.03**

★★★★★ for Low Maintenance, Gainability, Marbling, Calving Ease, Stayability.

**118** **BECKTON SCAMP C590 L4** 

1-A 100% # 3487785 Tat.: BSF5 C590

Birth: 4-2-15

Beckton Scamp T A825  
**BECKTON SCAMP X458 H3**  
 Ref. S-1 BKT Pine Marie R401 HU

Beckton Likable U120 L2  
**BECKTON LARKABEL X110 L**  
 BKT Larkabel U613 NB

Beckton Scamp 8954  
 Bkt Encino 8459 TJ  
 Beckton Hustler C2 L079  
 Bkt Pine Marie LC30 CD  
 Beckton Likable S633  
 Beckton Lana S718 LN  
 Beckton Nebula L P093  
 BKT Larkabel R038 WA

BWt **74**  
 WR **95**  
 ADG **3.05**  
 YWt **1080**  
 YR **96**  
 Scr. **37**  
 Fr. **5.5**

**DAM**  
 Age 5  
 Wt 1085  
 Prog.BW 69  
 WR 102  
 YR 104  
 Wean Pct. 52%  
 Cow Eff. 109

RAAA HerdBuilder index: **135**(Top **15%** of all RA bulls)  
 RAAA GridMaster index: **49**(Top **41%** of all RA bulls)  
 Calv.Ease BW WW YW Milk HPG Stay Maint.En.  
 EPDs **10.7 -4.4 44.3 70.7 20 13.5 12.5 -6.1**  
 Marb **+0.27** REA **+0.15** Bfat **-0.01**

★★★★★ for Low Maintenance, Marbling, Rib-eye area, Calving Ease.

**116** **BECKTON SCAMP C570 E4** 

1-A 100% # 3487745 Tat.: BSF5 C570

Birth: 4-1-15

Beckton Scamp T A825  
**BECKTON SCAMP X494 E3**  
 Ref. S-2 Beckton Lana S074 EP

Beckton Epic T330 L5  
**BECKTON LANA Y183 E**  
 Beckton Lana M393 LN

Beckton Scamp 8954  
 Bkt Encino 8459 TJ  
 Beckton Epic KH P678  
 Beckton Lana P317 JL  
 Beckton Epic K4 N795  
 Beckton Belga K202 LN  
 Beckton Lancer T3 J396  
 Beckton Lana F081 LN

BWt **60**  
 WR **99**  
 ADG **3.91**  
 YWt **1112**  
 YR **99**  
 Scr. **36**  
 Fr. **5.0**

**DAM**  
 Age 4  
 Wt 1115  
 Prog.BW 65  
 WR 104  
 YR 103  
 Wean Pct. 51%  
 Cow Eff. 107

RAAA HerdBuilder index: **121**(Top **29%** of all RA bulls)  
 RAAA GridMaster index: **50**(Top **24%** of all RA bulls)  
 Calv.Ease BW WW YW Milk HPG Stay Maint.En.  
 EPDs **16 -8.2 33.2 58 30 11.1 9.8 -2.3**  
 Marb **+0.30** REA **+0.04** Bfat **+0.01**

★★★★★ for Low Maintenance, Marbling, Calving Ease.

**119** **BSF EPIC C668 N7** 

1-B 99% # 3487902 Tat.: BSF5 C668

Birth: 4-9-15

Beckton Epic U749 D5  
**BECKTON EPIC Y484 N6**  
 Ref. E-4 Beckton Lydia S069 NB

Beckton Neptune R2 K065  
**BSF NEENA N333 NP**  
 BSF Brockle G498

Beckton Epic K4 N795  
 Beckton Denise R308 DM  
 Beckton Nebula P P707  
 Beckton Lydia P583 WR  
 Beckton Neptune RR B284  
 Beckton Lana C735 TP  
 Red Angus multiple sire  
 BSF Regus B655

BWt **76**  
 WR **102**  
 ADG **3.16**  
 YWt **1122**  
 YR **100**  
 Scr. **38**  
 Fr. **5.5**

**DAM**  
 Age 12  
 Wt 1190  
 Prog.BW 72  
 WR 109  
 YR 106  
 Wean Pct. 49%  
 Cow Eff. 104

RAAA HerdBuilder index: **122**(Top **28%** of all RA bulls)  
 RAAA GridMaster index: **49**(Top **40%** of all RA bulls)  
 Calv.Ease BW WW YW Milk HPG Stay Maint.En.  
 EPDs **10.1 -2.7 53.8 82.1 25 13.4 11.4 -1.9**  
 Marb **+0.37** REA **+0.27** Bfat **+0.00**

★★★★★ for Low Maintenance, Marbling, Rib-eye area, Superior Cow, Calving Ease.

• Bulls •



**120** **BSF EPIC C056 E8** 

1-B 99% # 3487954 Tat.: BSF5 C056

Birth: 2-24-15

Beckton Epic X330 L6  
**BECKTON EPIC A587 N7**  
 Ref. E-7  
 Beckton Lana W113 N

Beckton Epic T330 L5  
 Beckton Kit R503 LN  
 Beckton Nebula T252 L3  
 Beckton Lana T226 NB  
 Beckton Epic T330 L5  
 Beckton Kit R503 LN  
 Beckton Cody K2 R168  
 BSF Nebulann P046

BWt **63**  
 WR **106**  
 ADG **3.62**  
 YWt **1041**  
 YR **101**  
 Scr. **35**  
 Fr. **5.5**

**BSF NEBULANN A558 E**  
 Beckton Epic X330 L6  
 BSF Nebulann U227 CD

**DAM**  
 Age 2  
 Wt 970  
 Prog.BW 63  
 WR 106  
 YR 101  
 Wean Pct. 51%  
 Cow Eff. 107

RAAA HerdBuilder index: **161** (Top 4% of all RA bulls)  
 RAAA GridMaster index: **51** (Top 20% of all RA bulls)  
 Calv.Ease BW WW YW Milk HPG Stay Maint.En.  
 EPDs **10.9 -4.0 57.1 90.2 17 7.5 15.5 -3.6**  
 Marb **+4.1** REA **+1.5** Bfat **+0.0**

★★★★★ for Low Maintenance, Marbling, Rib-eye area, Calving Ease, Stayability.

**121** **BECKTON ACCENT C223 A4** 

1-A 100% # 3487495 Tat.: BKT5 C223

Birth: 3-15-15

Beckton Accent W180 C2  
**BECKTON ACCENT A175 O3**  
 Ref. A-6  
 Beckton Lana R214 RA

Beckton Cody K1 P014  
 Beckton Christy R046 CQ  
 TR Romeo NT379  
 Beckton Lana N664 JL  
 Beckton Cody K1 P014  
 Beckton Christy R046 CQ  
 Beckton Nexus L016  
 Beckton Coca P597 CD

BWt **61**  
 WR **106**  
 ADG **3.62**  
 YWt **1091**  
 YR **106**  
 Scr. **30**  
 Fr. **5.5**

**BECKTON COCA A517 A**  
 Beckton Accent W180 C2  
 Beckton Coca T454 NX

**DAM**  
 Age 2  
 Wt 1055  
 Prog.BW 73  
 WR 104  
 YR 103  
 Wean Pct. 47%  
 Cow Eff. 98

RAAA HerdBuilder index: **151** (Top 7% of all RA bulls)  
 RAAA GridMaster index: **51** (Top 11% of all RA bulls)  
 Calv.Ease BW WW YW Milk HPG Stay Maint.En.  
 EPDs **14.1 -5.5 61.4 93.6 24 10.5 13.1 -1.7**  
 Marb **+4.1** REA **+4.3** Bfat **+0.1**

★★★★★ for Low Maintenance, Growth, Marbling, Rib-eye area, Calving Ease, Stayability.

**123** **BECKTON NEBULA C322 N3** 

1-A 100% # 3487570 Tat.: BKT5 C322

Birth: 3-21-15

Beckton Nebula M045  
**BECKTON NEBULA E P084**  
 Ref. N  
 BKT Pine Marie M119 EP

Beckton Neptune R2 K065  
 Beckton Belga K285 JL  
 Beckton Epic K F075  
 Bkt Pine Marie D126 JL  
 Beckton Nebula PJ S543  
 Beckton Lana S197 JT  
 Beckton Justice C1 R483  
 Beckton Christy K101 CD

BWt **63**  
 WR **97**  
 ADG **4.02**  
 YWt **1142**  
 YR **102**  
 Scr. **35**  
 Fr. **5.0**

**BECKTON CHRISTY Y305 N**  
 Beckton Nebula W778 J4  
 Beckton Christy W280 J

**DAM**  
 Age 4  
 Wt 1190  
 Prog.BW 60  
 WR 77  
 YR 102  
 Wean Pct. 47%  
 Cow Eff. 98

RAAA HerdBuilder index: **170** (Top 2% of all RA bulls)  
 RAAA GridMaster index: **53** (Top 4% of all RA bulls)  
 Calv.Ease BW WW YW Milk HPG Stay Maint.En.  
 EPDs **16.8 -8.0 47.8 78.2 13 13.6 13.8 -6.0**  
 Marb **+8.9** REA **-.09** Bfat **+0.08**

★★★★★ for Low Maintenance, Gainability, Marbling, Calving Ease, Stayability.

**122** **BECKTON JULIAN C365 L4** 

1-A 100% # 3487725 Tat.: BSF5 C365

Birth: 3-23-15

Beckton Julian 7526G  
**BECKTON JULIAN GG B571**  
 Ref. J-1  
 Bkt Marta 9A13 JL

Beckton Julian 6592  
 Bkt Belga 6746 GS  
 Beckton Julian 7526G  
 Bkt Marta 6498 XM  
 Beckton Likable U130 L2  
 Beckton Indigo U658 JL  
 Beckton Clifftop U575 H3  
 Beckton Sierra U462 CT

BWt **67**  
 WR **109**  
 ADG **3.33**  
 YWt **1113**  
 YR **101**  
 Scr. **35**  
 Fr. **5.0**

**BECKTON SIERRA Z069 L**  
 Beckton Likable X445 J3  
 Beckton Sierra X018 C

**DAM**  
 Age 3  
 Wt 1040  
 Prog.BW 59  
 WR 109  
 YR 101  
 Wean Pct. 57%  
 Cow Eff. 119

RAAA HerdBuilder index: **177** (Top 1% of all RA bulls)  
 RAAA GridMaster index: **52** (Top 5% of all RA bulls)  
 Calv.Ease BW WW YW Milk HPG Stay Maint.En.  
 EPDs **15.6 -6.4 48.9 73.2 18 12.7 15.3 -5.2**  
 Marb **+7.3** REA **+3.6** Bfat **+0.0**

★★★★★ for Low Maintenance, Marbling, Rib-eye area, High Cow Efficiency, Calving Ease, Stayability.

**124** **BECKTON HERITAGE C245 C4** 

1-A 100% # 3487355 Tat.: BKT5 C245

Birth: 3-18-15

Beckton Heritage T270 J2  
**BECKTON HERITAGE X403 L3**  
 Ref. H-1  
 Beckton Indigo H150 LN

Beckton Heritage N013  
 Beckton Coca P602 JL  
 Beckton Lancer TE F363  
 Beckton Indigo F376 CT  
 BFCK Cherokee Cnyn 4912  
 Beckton Dinah C440 NM  
 Beckton Warhawk N560  
 Beckton Larkaba N394 HR

BWt **75**  
 WR **103**  
 ADG **3.28**  
 YWt **1076**  
 YR **96**  
 Scr. **36**  
 Fr. **4.5**

**BECKTON LARKABA U551 CQ**  
 Beckton Cherokee N N479  
 Beckton Larkaba R011 WA

**DAM**  
 Age 7  
 Wt 970  
 Prog.BW 61  
 WR 95  
 YR 93  
 Wean Pct. 63%  
 Cow Eff. 132

RAAA HerdBuilder index: **139** (Top 13% of all RA bulls)  
 RAAA GridMaster index: **49** (Top 54% of all RA bulls)  
 Calv.Ease BW WW YW Milk HPG Stay Maint.En.  
 EPDs **13.9 -5.9 50.3 65 20 14.1 12.5 -8.2**  
 Marb **+4.4** REA **-.02** Bfat **+0.02**

★★★★★ for Low Maintenance, Marbling, High Cow Efficiency, Calving Ease.

• Bulls •

**125** **BECKTON EPIC C525 L7** 

1-A 100% # 3487550 Tat.: BKT5 C525

Birth: 3-30-15

Beckton Epic U749 D5  
**BECKTON EPIC Y484 N6**  
 Ref. E-4  
 Beckton Lydia S069 NB

Beckton Epic K4 N795  
 Beckton Denise R308 DM  
 Beckton Nebula P P707  
 Beckton Lydia P583 WR  
 Beckton Likable S633  
 Beckton Kit S478 LN  
 Beckton Clifftop T3 N800  
 Beckton Tamara L214 LN

BWt **63**  
 WR **103**  
 ADG **3.33**  
 YWt **1137**  
 YR **101**  
 Scr. **36**  
 Fr. **5.0**

**BECKTON TAMARA Y612 L**  
 Beckton Likable U130 L2  
 Beckton Tamara T201 CT

**DAM**  
 Age 4  
 Wt 1175  
 Prog.BW 61  
 WR 109  
 YR 107  
 Wean Pct. 50%  
 Cow Eff. 106

RAAA HerdBuilder index: **138** (Top 14% of all RA bulls)  
 RAAA GridMaster index: **51** (Top 15% of all RA bulls)  
 Calv.Ease BW WW YW Milk HPG Stay Maint.En.  
 EPDs **10.5 -3.6 58.1 93.8 19 8.7 13.4 0.7**  
 Marb **+0.35** REA **+0.56** Bfat **+0.1**



★★★★★ for Low Maintenance, Marbling, Rib-eye area, Superior Cow, Calving Ease, Stayability.

**126** **BECKTON ACCENT C501 J3** 

1-A 100% # 3487669 Tat.: BSF5 C501

Birth: 3-29-15

Beckton Cody K1 P014  
**BECKTON ACCENT W180 C2**  
 Ref. A-1  
 Beckton Christy R046 CQ

Beckton Cody KH M390  
 Beckton Rose M126 WR  
 Beckton Cherokee N N479  
 Beckton Christy N740 HR  
 Beckton Justice CH M056  
 Beckton Tamara J124 HR  
 Beckton Justice C K449  
 BKT Larkeisa L149 CK

BWt **72**  
 WR **105**  
 ADG **3.45**  
 YWt **1112**  
 YR **98**  
 Scr. **38**  
 Fr. **5.0**

**BKT LARKEISA T310 JC**  
 Beckton Justice C1 R483  
 BKT Larkeisa R775 JC

**DAM**  
 Age 8  
 Wt 1150  
 Prog.BW 64  
 WR 107  
 YR 106  
 Wean Pct. 56%  
 Cow Eff. 119

RAAA HerdBuilder index: **151** (Top 7% of all RA bulls)  
 RAAA GridMaster index: **51** (Top 19% of all RA bulls)  
 Calv.Ease BW WW YW Milk HPG Stay Maint.En.  
 EPDs **13.5 -5.1 53.7 81 28 16.2 13.1 -0.6**  
 Marb **+0.58** REA **+0.18** Bfat **+0.04**

★★★★★ for Low Maintenance, Marbling, Rib-eye area, Superior Cow, High Cow Efficiency, Calving Ease, Stayability.

**128** **BECKTON CLIFFTOP C688 N5** 

1-A 100% # 3487658 Tat.: BSF5 C688

Birth: 4-11-15

Beckton Clifftop W692 E3  
**BECKTON CLIFFTOP Y012 C4**  
 Ref. C-2  
 Beckton Lana W240 C

BKT Clifftop TP R288  
 Beckton Lydia S274 EP  
 BKT Clifftop TP R288  
 Beckton Lana L923 CD  
 Beckton Nebula M045  
 Beckton Ruth M967 EP  
 Beckton Warhawk N560  
 Beckton Larkabel N769 HR

BWt **67**  
 WR **108**  
 ADG **3.39**  
 YWt **1131**  
 YR **101**  
 Scr. **36**  
 Fr. **5.0**

**BECKTON LARKABEL X676 N**  
 Beckton Nebula T269 E2  
 BKT Larkabel R038 WA

**DAM**  
 Age 5  
 Wt 1250  
 Prog.BW 65  
 WR 106  
 YR 102  
 Wean Pct. 51%  
 Cow Eff. 108

RAAA HerdBuilder index: **178** (Top 1% of all RA bulls)  
 RAAA GridMaster index: **50** (Top 33% of all RA bulls)  
 Calv.Ease BW WW YW Milk HPG Stay Maint.En.  
 EPDs **12.8 -5.0 44.6 69.5 28 17.2 16.8 -1.3**  
 Marb **+0.43** REA **+0.04** Bfat **+0.00**

★★★★★ for Low Maintenance, Marbling, Calving Ease, Stayability.

**127** **BECKTON SCAMP C429 J4** 

1-A 100% # 3487298 Tat.: BKT5 C429

Birth: 3-26-15

Beckton Scamp T A825  
**BECKTON SCAMP X494 E3**  
 Ref. S-2  
 Beckton Lana S074 EP

Beckton Scamp 8954  
 Bkt Encino 8459 TJ  
 Beckton Epic KH P678  
 Beckton Lana P317 JL  
 Beckton Julian G1 J526  
 Beckton Rose L311 LN  
 BKT Clifftop TP R288  
 Beckton Larkaba R809 NB

BWt **51**  
 WR **89**  
 ADG **3.83**  
 YWt **1079**  
 YR **96**  
 Scr. **35**  
 Fr. **4.5**

**BECKTON LARKABA X064 J**  
 Beckton Julian U699 L5  
 Beckton Larkaba U475 CT

**DAM**  
 Age 5  
 Wt 1055  
 Prog.BW 51  
 WR 104  
 YR 103  
 Wean Pct. 50%  
 Cow Eff. 106

RAAA HerdBuilder index: **164** (Top 3% of all RA bulls)  
 RAAA GridMaster index: **51** (Top 13% of all RA bulls)  
 Calv.Ease BW WW YW Milk HPG Stay Maint.En.  
 EPDs **17.9 -10.2 32.2 51.9 27 13.3 13.7 -11.2**  
 Marb **+0.52** REA **-0.07** Bfat **+0.03**

★★★★★ for Low Maintenance, Marbling, Calving Ease, Stayability.

**129** **BECKTON NEBULA C358 J4** 

1-A 100% # 3487294 Tat.: BKT5 C358

Birth: 3-23-15

Beckton Nebula E P084  
**BECKTON NEBULA EN S347**  
 Ref. N-2  
 Beckton Eola P530 NB

Beckton Nebula M045  
 BKT Pine Marie M119 EP  
 Beckton Nebula M045  
 Beckton Eola M663 EP  
 Beckton Jet L P491  
 Beckton Lydia N047 LM  
 Beckton Jet L P491  
 Beckton Rose R507 CT

BWt **70**  
 WR **107**  
 ADG **2.53**  
 YWt **1065**  
 YR **95**  
 Scr. **34**  
 Fr. **5.0**

**BECKTON ROSE X155 J**  
 Beckton Jet U473 L2  
 Beckton Rose U685 JT

**DAM**  
 Age 5  
 Wt 1430  
 Prog.BW 68  
 WR 109  
 YR 103  
 Wean Pct. 44%  
 Cow Eff. 93

RAAA HerdBuilder index: **163** (Top 3% of all RA bulls)  
 RAAA GridMaster index: **50** (Top 22% of all RA bulls)  
 Calv.Ease BW WW YW Milk HPG Stay Maint.En.  
 EPDs **14.6 -6.4 43.4 56.4 31 13 14.8 -2.9**  
 Marb **+0.97** REA **-0.28** Bfat **+0.03**

★★★★★ for Low Maintenance, Marbling, Superior Cow, Calving Ease, Stayability.



• Bulls •

**130** **BECKTON NEBULA C406 J5**   
 1-A 100% # 3487897 Tat.: BSF5 C406  
 Birth: 3-24-15  
 Beckton Nebula U206 V3 < Beckton Nebula P P707  
**BECKTON NEBULA X096 N4** < Beckton Minerva J615 VG  
 Ref. N-3 < Beckton Nebula P P707  
 Beckton Tamara U185 NB < Beckton Tamara P813 CH  
 Beckton Julian G1 J526 < Beckton Julian GG B571  
**BECKTON MINOLA N751 JL** < Beckton Annie F743 LN  
 Beckton Minola J091 JL < Beckton Julian GG B571  
 Beckton Minola D330 JL < Beckton Minola D330 JL

BWt	92
WR	121
ADG	1.61
YWt	1089
YR	97
Scr.	33
Fr.	5.0

**DAM**  
 Age 12  
 Wt 1290  
 Prog.BW 65  
 WR 103  
 YR 101  
 Wean Pct. 54%  
 Cow Eff. 113

RAAA HerdBuilder index: **153** (Top 6% of all RA bulls)  
 RAAA GridMaster index: **50** (Top 36% of all RA bulls)  
 Calv.Ease BW WW YW Milk HPG Stay Maint.En.  
 EPDs **11.5 -3.3 64.8 88.4 17 12 15.1 -0.3**  
 Marb **+0.55** REA **-0.03** Bfat **-0.01**

**133** **BECKTON EPIC C446 E7**   
 1-A 100% # 3487563 Tat.: BKT5 C446  
 Birth: 3-27-15  
 Beckton Epic U749 D5 < Beckton Epic K4 N795  
**BECKTON EPIC Y484 N6** < Beckton Denise R308 DM  
 Ref. E-4 < Beckton Nebula P P707  
 Beckton Lydia S069 NB < Beckton Lydia P583 WR  
 Beckton Epic U749 D5 < Beckton Epic K4 N795  
**BECKTON EOALA Y412 E** < Beckton Denise R308 DM  
 Beckton Eola T435 NB < Beckton Nebula L P093  
 Beckton Eola P336 CE < Beckton Eola P336 CE

BWt	62
WR	102
ADG	2.87
YWt	1061
YR	95
Scr.	34
Fr.	4.5

**DAM**  
 Age 4  
 Wt 1105  
 Prog.BW 62  
 WR 103  
 YR 98  
 Wean Pct. 53%  
 Cow Eff. 111

RAAA HerdBuilder index: **148** (Top 8% of all RA bulls)  
 RAAA GridMaster index: **51** (Top 13% of all RA bulls)  
 Calv.Ease BW WW YW Milk HPG Stay Maint.En.  
 EPDs **12.7 -4.7 50.2 82.8 18 10.3 13.5 0.1**  
 Marb **+0.42** REA **+0.37** Bfat **-0.01**

★★★★★ for Low Maintenance, Marbling, Calving Ease, Stayability.

★★★★★ for Low Maintenance, Marbling, Rib-eye area, Calving Ease, Stayability.

**131** **BECKTON EPIC C625 N6**   
 1-A 100% # 3487812 Tat.: BSF5 C625  
 Birth: 4-5-15  
 Beckton Epic K6 S569 < Beckton Epic KM M115  
**BECKTON EPIC X464 L5** < Beckton Sierra N703 LM  
 Ref. E-2 < Beckton Lancer T3 J396  
 Beckton Lana M393 LN < Beckton Lana F081 LN  
 Beckton Nebula M045 < Beckton Neptune R2 K065  
**BECKTON COCA W438 N** < Beckton Belga K285 JL  
 Beckton Coca T080 NB < Beckton Nebula N R573  
 Beckton Coca R375 WR < Beckton Coca R375 WR

BWt	65
WR	100
ADG	3.18
YWt	1097
YR	98
Scr.	37
Fr.	5.5

**DAM**  
 Age 6  
 Wt 980  
 Prog.BW 56  
 WR 100  
 YR 97  
 Wean Pct. 61%  
 Cow Eff. 128

RAAA HerdBuilder index: **166** (Top 3% of all RA bulls)  
 RAAA GridMaster index: **52** (Top 8% of all RA bulls)  
 Calv.Ease BW WW YW Milk HPG Stay Maint.En.  
 EPDs **15.6 -7.1 48.1 84.9 28 12.1 14.2 -8.5**  
 Marb **+0.48** REA **-0.05** Bfat **+0.05**

★★★★★ for Low Maintenance, Marbling, High Cow Efficiency, Calving Ease, Stayability.

**134** **BECKTON NEBULA C108 C5**   
 1-A 100% # 3487628 Tat.: BKT5 C108  
 Birth: 3-1-15  
 Beckton Nebula T398 V3 < Beckton Nebula L P093  
**BECKTON NEBULA A773 L4** < Beckton Minerva J615 VG  
 Ref. N-6 < Beckton Likable U130 L2  
 Beckton Mona X022 L < Beckton Mona U584 CD  
 Beckton Cherokee Y129 E4 < Beckton Cherokee T450 L3  
**BECKTON FIREFLY A085 C** < Beckton Lana M809 EP  
 Beckton Firefly Y588 W < Beckton Warrior T248 L5  
 Beckton Firefly U606 JL < Beckton Firefly U606 JL

BWt	59
WR	112
ADG	3.22
YWt	1024
YR	99
Scr.	35
Fr.	5.5

**DAM**  
 Age 2  
 Wt 800  
 Prog.BW 59  
 WR 112  
 YR 99  
 Wean Pct. 66%  
 Cow Eff. 138

RAAA HerdBuilder index: **167** (Top 3% of all RA bulls)  
 RAAA GridMaster index: **50** (Top 22% of all RA bulls)  
 Calv.Ease BW WW YW Milk HPG Stay Maint.En.  
 EPDs **13.5 -5.9 51.3 75.8 19 12.2 16.1 -7.0**  
 Marb **+0.53** REA **-0.03** Bfat **+0.01**

★★★★★ for Low Maintenance, Marbling, High Cow Efficiency, Calving Ease, Stayability.

**132** **BECKTON ACCENT C347 E3**   
 1-A 100% # 3487296 Tat.: BKT5 C347  
 Birth: 3-22-15  
 Beckton Cody K1 P014 < Beckton Cody KH M390  
**BECKTON ACCENT W180 C2** < Beckton Rose M126 WR  
 Ref. A-1 < Beckton Cherokee N N479  
 Beckton Christy R046 CQ < Beckton Christy N740 HR  
 Beckton Epic U126 J5 < Beckton Epic K7 S583  
**BECKTON EMERA X106 E** < Beckton Ruth S076 JT  
 Beckton Emera U675 CQ < Beckton Cherokee N N479  
 Beckton Emera P378 LN < Beckton Emera P378 LN

BWt	71
WR	94
ADG	3.10
YWt	1045
YR	93
Scr.	35
Fr.	5.0

**DAM**  
 Age 5  
 Wt 980  
 Prog.BW 67  
 WR 97  
 YR 98  
 Wean Pct. 57%  
 Cow Eff. 119

RAAA HerdBuilder index: **155** (Top 6% of all RA bulls)  
 RAAA GridMaster index: **51** (Top 18% of all RA bulls)  
 Calv.Ease BW WW YW Milk HPG Stay Maint.En.  
 EPDs **13.6 -6.5 44.1 67.6 23 13.8 14.1 -6.7**  
 Marb **+0.53** REA **+0.22** Bfat **+0.02**

★★★★★ for Low Maintenance, Marbling, Rib-eye area, High Cow Efficiency, Calving Ease, Stayability.

**135** **BECKTON ACCENT C058 N4**   
 1-A 100% # 3487439 Tat.: BKT5 C058  
 Birth: 2-24-15  
 Beckton Accent W180 C2 < Beckton Cody K1 P014  
**BECKTON ACCENT A175 O3** < Beckton Christy R046 CQ  
 Ref. A-6 < TR Romeo NT379  
 Beckton Lana R214 RA < Beckton Lana N664 JL  
 Beckton Nebula T269 E2 < Beckton Nebula M045  
**BECKTON SHEBA A921 N** < Beckton Ruth M967 EP  
 Beckton Sheba W289 E < Beckton Epic R350 K  
 Beckton Sheba P631 JC < Beckton Sheba P631 JC

BWt	54
WR	107
ADG	3.16
YWt	1040
YR	101
Scr.	32
Fr.	5.5

**DAM**  
 Age 2  
 Wt 840  
 Prog.BW 54  
 WR 107  
 YR 101  
 Wean Pct. 59%  
 Cow Eff. 125

RAAA HerdBuilder index: **156** (Top 5% of all RA bulls)  
 RAAA GridMaster index: **51** (Top 19% of all RA bulls)  
 Calv.Ease BW WW YW Milk HPG Stay Maint.En.  
 EPDs **13.5 -5.4 56 82 23 12.8 14.1 -2.0**  
 Marb **+0.56** REA **+0.04** Bfat **+0.01**

★★★★★ for Low Maintenance, Marbling, High Cow Efficiency, Calving Ease, Stayability.

• Bulls •

**136** **BSF WARRIOR C390 L5** 

1-B 99% # 3487900 Tat.: BSF5 C390

Birth: 3-24-15

Beckton Warrior C1 S337  
**BECKTON WARRIOR W534 N4**  
 Ref. W-2 BKT Larkeisa S055 NB

Beckton Loki F251  
**BSF LAUREL N411 LO**  
 BSF Regus G195

Beckton Warrior CL M686  
 Beckton Christy K101 CD  
 Beckton Nebula P P707  
 Beckton Larkeisa P688 CH  
 Beckton Lancer TZ D525  
 Bkt Pine Marie D126 JL  
 Beckton Emperor C369  
 BSF Regus 8099

BWt	62
WR	107
ADG	4.02
YWt	1139
YR	102
Scr.	36
Fr.	4.5

Age	12
Wt	1200
Prog.BW	72
WR	101
YR	100
Wean Pct.	51%
Cow Eff.	108

RAAA HerdBuilder index: **145** (Top 9% of all RA bulls)  
 RAAA GridMaster index: **50** (Top 31% of all RA bulls)

Calv.Ease	BW	WW	YW	Milk	HPG	Stay	Maint.En.	
EPDs	15.4	-6.2	40	57.9	25	10.9	13.3	-8.5

Marb **+0.84** REA **-0.07** Bfat **+1.0**

★★★★★ for Low Maintenance, Gainability, Marbling, Calving Ease, Stayability.



Lot 136

**138** **BECKTON NEW ERA C600 J2** 

1-A 100% # 3487819 Tat.: BSF5 C600

Birth: 4-2-15

Beckton Nebula P P707  
**BECKTON NEW ERA Y194**  
 Ref. N-4 BKT Larkeisa T310 JC

Beckton Julian GG B571  
**BECKTON BELGA W213 J**  
 Beckton Belga S587 DM

Beckton Nebula M045  
 Beckton Lana M809 EP  
 Beckton Justice C1 R483  
 BKT Larkeisa R775 JC  
 Beckton Julian 7526G  
 Bkt Marta 9A13 JL  
 Beckton Dominor ZC M919  
 Beckton Belga M883 DM

BWt	67
WR	94
ADG	3.74
YWt	1120
YR	100
Scr.	35
Fr.	4.5

Age	6
Wt	1100
Prog.BW	65
WR	92
YR	96
Wean Pct.	51%
Cow Eff.	107

RAAA HerdBuilder index: **167** (Top 3% of all RA bulls)  
 RAAA GridMaster index: **51** (Top 14% of all RA bulls)

Calv.Ease	BW	WW	YW	Milk	HPG	Stay	Maint.En.	
EPDs	15.7	-5.1	51.3	84.9	23	12.4	14.8	-4.4

Marb **+0.62** REA **-0.09** Bfat **+0.05**

★★★★★ for Low Maintenance, Marbling, Calving Ease, Stayability.

**139** **BECKTON JULIAN C016 J5** 

1-A 100% # 3487970 Tat.: BSF5 C016

Birth: 2-18-15

Beckton Julian GG B571  
**BECKTON JULIAN A565 J4**  
 Ref. J-6 Beckton Belga X379 L

Beckton Julian GG B571  
**BECKTON BARMAID A410 J**  
 Beckton Barmaid U114 CQ

Beckton Julian 7526G  
 Bkt Marta 9A13 JL  
 Bkt Javelin 7466 R  
 Beckton Belga S587 DM  
 Beckton Julian 7526G  
 Bkt Marta 9A13 JL  
 Beckton Cherokee N N479  
 Beckton Barmaid P323 HR

BWt	65
WR	102
ADG	3.45
YWt	1051
YR	102
Scr.	35
Fr.	4.5

Age	2
Wt	870
Prog.BW	65
WR	102
YR	102
Wean Pct.	54%
Cow Eff.	114

RAAA HerdBuilder index: **156** (Top 5% of all RA bulls)  
 RAAA GridMaster index: **49** (Top 45% of all RA bulls)

Calv.Ease	BW	WW	YW	Milk	HPG	Stay	Maint.En.	
EPDs	14.5	-4.6	46.3	69.3	23	12.3	14.3	-7.2

Marb **+0.50** REA **+0.09** Bfat **+0.06**

★★★★★ for Low Maintenance, Marbling, Calving Ease, Stayability.



Lot 137

**137** **BSF JANUS C665 J3** 

1-B 99% # 3487858 Tat.: BSF5 C665

Birth: 4-9-15

Beckton Roman J S158  
**BECKTON JANUS X799 L2**  
 Ref. J-3 Beckton Sierra K557 LO

Beckton Justice C1 R483  
**BSF NEBULANN T658 JC**  
 BSF Nebulann R163 NB

TR Romeo NT379  
 Beckton Belga K285 JL  
 Beckton Loki F251  
 Beckton Sierra C157 CL  
 Beckton Justice CH M056  
 Beckton Tamara J124 HR  
 Beckton Nebula M045  
 BSF Regus F175

BWt	69
WR	104
ADG	3.22
YWt	1153
YR	103
Scr.	37
Fr.	4.5

Age	8
Wt	1250
Prog.BW	65
WR	107
YR	103
Wean Pct.	49%
Cow Eff.	104

RAAA HerdBuilder index: **134** (Top 16% of all RA bulls)  
 RAAA GridMaster index: **51** (Top 20% of all RA bulls)

Calv.Ease	BW	WW	YW	Milk	HPG	Stay	Maint.En.	
EPDs	14.9	-6.1	44.4	72.7	31	11.7	11.4	2.8

Marb **+0.46** REA **-0.15** Bfat **+0.00**

★★★★★ for Low Maintenance, Marbling, Calving Ease.

• Bulls •

**140** **BECKTON EPIC C593 N7**  1-A 100% # 3487744 Tat.: BSF5 C593

Birth: 4-2-15

Beckton Epic U749 D5  
**BECKTON EPIC Y484 N6**  
Ref. E-4  
Beckton Lydia S069 NB

Beckton Epic K4 N795  
Beckton Denise R308 DM  
Beckton Nebula P P707  
Beckton Lydia P583 WR  
Beckton Nebula L P093  
Beckton Minerva J615 VG  
Beckton Lancer TE F363  
Beckton Indigo F376 CT

BWt **68**  
WR **93**  
ADG **3.62**  
YWt. **1125**  
YR **100**  
Scr. **36**  
Fr. **5.0**

Beckton Nebula T398 V3  
**BECKTON INDIGO Y343 N**  
Beckton Indigo H150 LN

**DAM**  
Age 4  
Wt 1210  
Prog.BW 66  
WR 102  
YR 103  
Wean Pct. 44%  
Cow Eff. 93

RAAA HerdBuilder index: **153** (Top 6% of all RA bulls)  
RAAA GridMaster index: **51** (Top 10% of all RA bulls)  
Calv.Ease BW WW YW Milk HPG Stay Maint.En.  
EPDs **12.8 -4.8 48.9 84.4 22 11.1 14.4 -1.0**  
Marb **+4.4** REA **+3.6** Bfat **+0.0**

★★★★★ for Low Maintenance, Marbling, Rib-eye area, Calving Ease, Stayability.

**143** **BECKTON SCAMP C641 E4**  1-A 100% # 3487547 Tat.: BKT5 C641

Birth: 4-7-15

Beckton Scamp T A825  
**BECKTON SCAMP X494 E3**  
Ref. S-2  
Beckton Lana S074 EP

Beckton Scamp 8954  
Bkt Encino 8459 TJ  
Beckton Epic KH P678  
Beckton Lana P317 JL  
Beckton Epic KJ J722  
Beckton Sierra J789 EP  
Beckton Epic K4 N795  
**BECKTON TAMARA Y685 E**  
Beckton Tamara U358 CT

BWt **73**  
WR **99**  
ADG **3.56**  
YWt. **1131**  
YR **101**  
Scr. **36**  
Fr. **5.0**

Beckton Clifftop TP R288  
Beckton Tamara L801 CL

**DAM**  
Age 4  
Wt 1135  
Prog.BW 75  
WR 107  
YR 105  
Wean Pct. 50%  
Cow Eff. 105

RAAA HerdBuilder index: **113** (Top 38% of all RA bulls)  
RAAA GridMaster index: **50** (Top 31% of all RA bulls)  
Calv.Ease BW WW YW Milk HPG Stay Maint.En.  
EPDs **10 -3.9 43.5 73.2 23 10.7 10.7 -3.4**  
Marb **+4.2** REA **+0.9** Bfat **+0.0**

★★★★★ for Low Maintenance, Marbling, Superior Cow, Calving Ease.

**141** **BSF SCAMP C662 C4**  1-B 99% # 3487850 Tat.: BSF5 C662

Birth: 4-8-15

Beckton Scamp T A825  
**BECKTON SCAMP X494 E3**  
Ref. S-2  
Beckton Lana S074 EP

Beckton Scamp 8954  
Bkt Encino 8459 TJ  
Beckton Epic KH P678  
Beckton Lana P317 JL  
Beckton Clifftop T C075  
Beckton Clifftop TP R288  
**BSF NEBULANN U145 CT**  
BSF Nebulann R163 NB

Beckton Scamp M126 WR  
Beckton Cherokee N N479  
Beckton Christy N740 HR  
Beckton Legend S670  
Beckton Lana T279 JO  
Beckton Roman J S158  
BSF Regus F175

BWt **67**  
WR **94**  
ADG **3.91**  
YWt. **1125**  
YR **100**  
Scr. **39**  
Fr. **4.5**

**DAM**  
Age 7  
Wt 1135  
Prog.BW 69  
WR 106  
YR 106  
Wean Pct. 49%  
Cow Eff. 104

RAAA HerdBuilder index: **139** (Top 13% of all RA bulls)  
RAAA GridMaster index: **49** (Top 43% of all RA bulls)  
Calv.Ease BW WW YW Milk HPG Stay Maint.En.  
EPDs **13.3 -6.0 36.9 62.1 28 14.1 12.6 -5.6**  
Marb **+3.2** REA **-0.3** Bfat **+0.3**

★★★★★ for Low Maintenance, Marbling, Superior Cow, Calving Ease.

**144** **BSF ACCENT C627 L3**  1-B 99% # 3487709 Tat.: BSF5 C627

Birth: 4-5-15

Beckton Cody K1 P014  
**BECKTON ACCENT W180 C2**  
Ref. A-1  
Beckton Christy R046 CQ

Beckton Cody KH M390  
Beckton Rose M126 WR  
Beckton Cherokee N N479  
Beckton Christy N740 HR  
Beckton Legend S670  
Beckton Lana T279 JO  
Beckton Roman J S158  
BSF Red F608

BWt **67**  
WR **104**  
ADG **4.08**  
YWt. **1145**  
YR **104**  
Scr. **35**  
Fr. **5.5**

**DAM**  
Age 3  
Wt 935  
Prog.BW 72  
WR 102  
YR 105  
Wean Pct. 59%  
Cow Eff. 125

RAAA HerdBuilder index: **146** (Top 9% of all RA bulls)  
RAAA GridMaster index: **51** (Top 14% of all RA bulls)  
Calv.Ease BW WW YW Milk HPG Stay Maint.En.  
EPDs **12.1 -4.2 56.6 87.6 22 13.3 13.2 -3.4**  
Marb **+5.3** REA **+3.4** Bfat **+0.1**

★★★★★ for Low Maintenance, Gainability, Marbling, Rib-eye area, High Cow Efficiency, Calving Ease, Stayability.

**142** **BECKTON EPIC C085 J8**  1-A 100% # 3487500 Tat.: BKT5 C085

Birth: 2-25-15

Beckton Epic Y484 N6  
**BECKTON EPIC A286 E7**  
Ref. E-6  
Beckton Larkaba Y648 E

Beckton Epic U749 D5  
Beckton Lydia S069 NB  
Beckton Epic U749 D5  
Beckton Larkaba U475 CT  
Beckton Julian GJ P535  
Beckton Minola P826 DM  
Beckton Epic K3 M606  
Beckton Lana K840 LN

BWt **50**  
WR **97**  
ADG **3.74**  
YWt. **1074**  
YR **104**  
Scr. **37**  
Fr. **5.0**

Beckton Julian G5 S107  
**BECKTON LANA A477 J**  
Beckton Lana S212 EP

**DAM**  
Age 2  
Wt 1035  
Prog.BW 50  
WR 97  
YR 104  
Wean Pct. 43%  
Cow Eff. 91

RAAA HerdBuilder index: **156** (Top 5% of all RA bulls)  
RAAA GridMaster index: **52** (Top 6% of all RA bulls)  
Calv.Ease BW WW YW Milk HPG Stay Maint.En.  
EPDs **14.3 -6.5 48.7 83.8 19 13.5 13.7 -3.6**  
Marb **+6.3** REA **+1.1** Bfat **+0.6**

★★★★★ for Low Maintenance, Marbling, Calving Ease, Stayability.



Lot 142



• Bulls •

**145** **BSF NEBULA C104 L5** 

99% # un-reg Tat.: BSF5 C104

Birth: 2-28-15

Beckton Nebula T398 V3  
**BECKTON NEBULA A773 L4**  
 Ref. N-6 Beckton Mona X022 L

Beckton Nebula L P093  
 Beckton Minerva J615 V6  
 Beckton Likable U130 L2  
 Beckton Mona U584 CD

Beckton Likable Y362 L3  
**BSF LANETTE A151 L**  
 BSF Lanette Y198 L

Beckton Likable U130 L2  
 Beckton Tamara M515 LN  
 Beckton Likable U130 L2  
 BSF Lanette R748 LN

BWt **59**  
 WR **104**  
 ADG **3.28**  
 YWt **1068**  
 YR **104**  
 Scr. **35**  
 Fr. **5.0**

**DAM**  
 Age 2  
 Wt 945  
 Prog.BW 59  
 WR 104  
 YR 104  
 Wean Pct. 51%  
 Cow Eff. 107

RAAA HerdBuilder index: (Top 1% of all RA bulls)  
 RAAA GridMaster index: (Top 15% of all RA bulls)  
 Calv.Ease BW WW YW Milk HPG Stay Maint.En.  
 EPDs **10.3 -3.4 52.7 85.7 15.7 9.5 16.5 -2.8**  
 Marb **+0.31** REA **+0.36** Bfat **+0.03**

★★★★★ for Low Maintenance, Marbling, Rib-eye area, Superior Cow, Calving Ease, Stayability.



Lot 146

**147** **BECKTON HERITAGE C633 J4** 

1-A 100% # 3487382 Tat.: BKT5 C633

Birth: 4-6-15

Beckton Heritage T270 J2  
**BECKTON HERITAGE X403 L3**  
 Ref. H-1 Beckton Indigo H150 LN

Beckton Heritage N013  
 Beckton Coca P602 JL  
 Beckton Lancer TE F363  
 Beckton Indigo F376 CT

Beckton Julian G2 M345  
**BECKTON CHRISTY T444 JL**  
 Beckton Christy L654 JL

Beckton Julian GG B571  
 Beckton Lana H544 WR  
 Beckton Julian GG B571  
 Beckton Christy H207 HD

BWt **80**  
 WR **96**  
 ADG **3.68**  
 YWt **1106**  
 YR **99**  
 Scr. **35**  
 Fr. **5.0**

**DAM**  
 Age 8  
 Wt 1160  
 Prog.BW 71  
 WR 97  
 YR 98  
 Wean Pct. 49%  
 Cow Eff. 103

RAAA HerdBuilder index: **129** (Top 21% of all RA bulls)  
 RAAA GridMaster index: **50** (Top 29% of all RA bulls)  
 Calv.Ease BW WW YW Milk HPG Stay Maint.En.  
 EPDs **13 -3.5 49.4 73.4 19 12.9 10.8 -5.5**  
 Marb **+0.78** REA **+0.00** Bfat **+0.04**

★★★★★ for Low Maintenance, Marbling, Calving Ease.

**148** **BECKTON NEBULA C174 J6** 

1-A 100% # 3487519 Tat.: BKT5 C174

Birth: 3-10-15

Beckton Nebula W778 J4  
**BECKTON NEBULA A394 C5**  
 Ref. N Beckton Lana T104 CT

Beckton Nebula PJ S543  
 Beckton Lana S197 JT  
 BKT Clifftop TP R288  
 Beckton Lana R128 LS

Beckton Julian GG B571  
**BECKTON LARKABA A313 J**  
 Beckton Larkaba U571 LN

Beckton Julian 7526G  
 Bkt Marta 9A13 JL  
 Beckton Lancer T A664  
 Beckton Larkaba R394 JE

BWt **51**  
 WR **104**  
 ADG **3.45**  
 YWt **1092**  
 YR **106**  
 Scr. **33**  
 Fr. **5.0**

**DAM**  
 Age 2  
 Wt 835  
 Prog.BW 51  
 WR 104  
 YR 106  
 Wean Pct. 58%  
 Cow Eff. 121

RAAA HerdBuilder index: **177** (Top 1% of all RA bulls)  
 RAAA GridMaster index: **51** (Top 10% of all RA bulls)  
 Calv.Ease BW WW YW Milk HPG Stay Maint.En.  
 EPDs **17.8 -8.1 49.1 78.2 16 11.1 15.5 -3.5**  
 Marb **+0.32** REA **+0.24** Bfat **-0.01**

★★★★★ for Low Maintenance, Growth, Marbling, Rib-eye area, Superior Cow, High Cow Efficiency, Calving Ease, Stayability.

**146** **BECKTON NEW ERA C029 D3** 

1-A 100% # 3487635 Tat.: BKT5 C029

Birth: 2-21-15

Beckton New Era Y194  
**BECKTON NEW ERA A395 L2**  
 Ref. N-5 Beckton Minerva X612 L

Beckton Nebula P P707  
 BKT Larkeisa T310 JC  
 Beckton Legend U331 E2  
 Beckton Minerva U313 NB

Beckton Dominor W640 C5  
**BECKTON FIREFLY A022 D**  
 Beckton Firefly U801 NB

Beckton Dominor Z1 R610  
 Beckton Mona R166 CQ  
 Beckton Nebula N R573  
 Beckton Firefly K180 CH

BWt **58**  
 WR **98**  
 ADG **3.51**  
 YWt **1049**  
 YR **102**  
 Scr. **35**  
 Fr. **5.0**

**DAM**  
 Age 2  
 Wt 890  
 Prog.BW 58  
 WR 98  
 YR 102  
 Wean Pct. 51%  
 Cow Eff. 107

RAAA HerdBuilder index: **179** (Top 1% of all RA bulls)  
 RAAA GridMaster index: **51** (Top 11% of all RA bulls)  
 Calv.Ease BW WW YW Milk HPG Stay Maint.En.  
 EPDs **15.4 -6.8 47 76.4 20 8 16.5 -1.0**  
 Marb **+0.62** REA **-0.05** Bfat **+0.03**

★★★★★ for Low Maintenance, Marbling, Calving Ease, Stayability.

**149** **BECKTON WARRIOR C454 N6** 

1-A 100% # 3487675 Tat.: BSF5 C454

Birth: 3-27-15

Beckton Warrior W534 N4  
**BECKTON WARRIOR Y108 E5**  
 Ref. W-3 Beckton Susan W058 E

Beckton Warrior C1 S337  
 BKT Larkeisa S055 NB  
 Beckton Epic T330 L5  
 Beckton Susan T048 NB

Beckton Nebula W022 D3  
**BECKTON LANA Y130 N**  
 Beckton Lana W525 D

Beckton Nebula T269 E2  
 Beckton Eola T070 DM  
 Beckton Dominor Z1 R610  
 Beckton Lana S520 JO

BWt **61**  
 WR **93**  
 ADG **3.85**  
 YWt **1089**  
 YR **97**  
 Scr. **38**  
 Fr. **5.0**

**DAM**  
 Age 4  
 Wt 1065  
 Prog.BW 62  
 WR 100  
 YR 104  
 Wean Pct. 50%  
 Cow Eff. 105

RAAA HerdBuilder index: **187** (Top 1% of all RA bulls)  
 RAAA GridMaster index: **51** (Top 10% of all RA bulls)  
 Calv.Ease BW WW YW Milk HPG Stay Maint.En.  
 EPDs **16.6 -7.7 35.8 65.4 28 11.5 16.6 -5.0**  
 Marb **+0.50** REA **+0.05** Bfat **+0.02**

★★★★★ for Low Maintenance, Marbling, Calving Ease, Stayability.

• Bulls •

**150** **BSF MAXIMUS C673 W** 

3 99% # 3487840 Tat.: BSF5 C673

Birth: 4-10-15

**RED ANGUS MULTIPLE SIRE**  
Ref. Red Angus multiple sire  
Red Angus dam

**BSF EPIQUETTE U398 WR**  
Beckton Warrior C1 S337  
BSF Epiquette S632 EP

Beckton Heritage N013  
Beckton Coca P602 JL  
Beckton Lancer TE F363  
Beckton Indigo F376 CT  
Beckton Warrior CL M686  
Beckton Christy K101 CD  
Beckton Epic K3 M606  
BSF Regus M057 JC

BWt **80**  
WR **108**  
ADG **3.10**  
Ywt. **1129**  
YR **101**  
Scr. **35**  
Fr. **5.0**

**DAM**  
Age 7  
Wt 1290  
Prog.BW 74  
WR 113  
YR 108  
Wean Pct. 50%  
Cow Eff. 104

RAAA HerdBuilder index: **67** (Top **89%** of all RA bulls)  
RAAA GridMaster index: **47** (Top **78%** of all RA bulls)  
Calv.Ease BW WW YW Milk HPG Stay Maint.En.  
EPDs **8.5 -1.0 47.5 66.6 19 6 5.9 -7.9**  
Marb **+1.7** REA **+0.2** Bfat **+0.1**

★★★★★ for Low Maintenance, Marbling, Superior Cow, Calving Ease.

**153** **BSF HERITAGE C293 W4** 

1-B 99% # 3487809 Tat.: BSF5 C293

Birth: 3-20-15

**BECKTON HERITAGE X403 L3**  
Ref. H-1

**BSF CRUSITA W538 W**  
Beckton Warrior C1 S337  
BSF Crusita S081 EP

Beckton Heritage T270 J2  
Beckton Coca P602 JL  
Beckton Lancer TE F363  
Beckton Indigo H150 LN  
Beckton Indigo F376 CT  
Beckton Warrior CL M686  
Beckton Christy K101 CD  
Beckton Epic K5 P071  
BSF Crusita P716

BWt **73**  
WR **80**  
ADG **4.26**  
Ywt. **1085**  
YR **97**  
Scr. **34**  
Fr. **5.0**

**DAM**  
Age 6  
Wt 1270  
Prog.BW 69  
WR 87  
YR 101  
Wean Pct. 37%  
Cow Eff. 78

RAAA HerdBuilder index: **127** (Top **22%** of all RA bulls)  
RAAA GridMaster index: **50** (Top **24%** of all RA bulls)  
Calv.Ease BW WW YW Milk HPG Stay Maint.En.  
EPDs **13.4 -4.8 46.7 78.5 19 12.2 10.8 -3.7**  
Marb **+4.3** REA **+0.7** Bfat **+0.2**

★★★★★ for Low Maintenance, Gainability, Marbling, Calving Ease.

**151** **BECKTON HERITAGE C622 E4** 

1-A 100% # 3487248 Tat.: BKT5 C622

Birth: 4-5-15

**BECKTON HERITAGE X403 L3**  
Ref. H-1

**BECKTON MINOLA Z459 E**  
Beckton Emcee S466  
Beckton Minola W044 N

Beckton Heritage T270 J2  
Beckton Heritage N013  
Beckton Coca P602 JL  
Beckton Lancer TE F363  
Beckton Indigo H150 LN  
Beckton Indigo F376 CT  
Beckton Epic K4 N795  
Beckton Larkaba H798 WR  
Beckton Nebula T398 V3  
Beckton Minola T220 JL

BWt **55**  
WR **98**  
ADG **3.98**  
Ywt. **1156**  
YR **105**  
Scr. **34**  
Fr. **5.5**

**DAM**  
Age 3  
Wt 945  
Prog.BW 55  
WR 98  
YR 105  
Wean Pct. 55%  
Cow Eff. 116

RAAA HerdBuilder index: **139** (Top **13%** of all RA bulls)  
RAAA GridMaster index: **51** (Top **11%** of all RA bulls)  
Calv.Ease BW WW YW Milk HPG Stay Maint.En.  
EPDs **15.5 -7.5 48.9 78.6 25 10.8 11.6 -2.8**  
Marb **+4.7** REA **+2.2** Bfat **+0.4**

★★★★★ for Low Maintenance, Growth, Marbling, Rib-eye area, High Cow Efficiency, Calving Ease.

**154** **BECKTON EPIC C563 W7** 

1-A 100% # 3487549 Tat.: BKT5 C563

Birth: 3-31-15

**BECKTON EPIC Y484 N6**  
Ref. E-4

**BECKTON LANA Y636 W**  
Beckton Warrior T248 L5  
Beckton Lana T279 JO

Beckton Epic U749 D5  
Beckton Epic K4 N795  
Beckton Denise R308 DM  
Beckton Nebula P P707  
Beckton Lydia P583 WR  
Beckton Warrior N645 T1  
Beckton Kit R503 LN  
Beckton Julio L233  
Beckton Lana L923 CD

BWt **68**  
WR **90**  
ADG **4.38**  
Ywt. **1103**  
YR **98**  
Scr. **36**  
Fr. **5.0**

**DAM**  
Age 4  
Wt 1034  
Prog.BW 61  
WR 98  
YR 99  
Wean Pct. 50%  
Cow Eff. 105

RAAA HerdBuilder index: **155** (Top **5%** of all RA bulls)  
RAAA GridMaster index: **52** (Top **4%** of all RA bulls)  
Calv.Ease BW WW YW Milk HPG Stay Maint.En.  
EPDs **11 -3.6 56.7 101.1 17 11.2 13.8 -3.3**  
Marb **+5.0** REA **+4.8** Bfat **+0.1**

★★★★★ for Low Maintenance, Gainability, Marbling, Rib-eye area, Calving Ease, Stayability.

**152** **BSF DOMINOR C145 L8** 

1-B 99% # 3488002 Tat.: BSF5 C145

Birth: 3-6-15

**BECKTON DOMINOR A378 W7**  
Ref. D-1

**BSF HUSTELLE A289 L**  
Beckton Legend U331 E2  
BSF Hustelle U447 HH

Beckton Dominor Y005 V6  
Beckton Dominor W640 C5  
Beckton Belga W108 V  
Beckton Warrior T248 L5  
Beckton Lana S074 EP  
Beckton Legend S670  
Beckton Lana S669 EP  
Beckton HalfmannHustler R588  
BSF Regus G191

BWt **50**  
WR **98**  
ADG **3.75**  
Ywt. **1095**  
YR **106**  
Scr. **36**  
Fr. **5.0**

**DAM**  
Age 2  
Wt 890  
Prog.BW 50  
WR 98  
YR 106  
Wean Pct. 51%  
Cow Eff. 107

RAAA HerdBuilder index: **165** (Top **3%** of all RA bulls)  
RAAA GridMaster index: **53** (Top **3%** of all RA bulls)  
Calv.Ease BW WW YW Milk HPG Stay Maint.En.  
EPDs **14.5 -6.9 49.7 89.3 19 10.8 14.4 -3.8**  
Marb **+5.0** REA **+3.7** Bfat **+0.2**

★★★★★ for Low Maintenance, Growth, Marbling, Rib-eye area, Calving Ease, Stayability.

**155** **BECKTON LIKABLE C664 N3** 

1-A 100% # 3487571 Tat.: BKT5 C664

Birth: 4-9-15

**BECKTON LIKABLE U130 L2**  
Ref. L-1

**BECKTON SUFFEINA Y273 N**  
Beckton Nebula W778 J4  
Beckton Suffeina W489 W

Beckton Likable S633  
Beckton Lancer F442 T  
Beckton Kit F468 JL  
Beckton Lancer F442 T  
Beckton Kit F468 JL  
Beckton Nebula PJ S543  
Beckton Lana S197 JT  
Beckton Warrior T248 L5  
BKT Suffeina T500 EP

BWt **61**  
WR **87**  
ADG **4.21**  
Ywt. **1117**  
YR **100**  
Scr. **35**  
Fr. **5.0**

**DAM**  
Age 4  
Wt 1065  
Prog.BW 65  
WR 100  
YR 105  
Wean Pct. 46%  
Cow Eff. 98

RAAA HerdBuilder index: **148** (Top **8%** of all RA bulls)  
RAAA GridMaster index: **53** (Top **3%** of all RA bulls)  
Calv.Ease BW WW YW Milk HPG Stay Maint.En.  
EPDs **12.3 -6.2 53.9 94 14 9.9 13.2 -5.4**  
Marb **+4.9** REA **+4.8** Bfat **+0.3**

★★★★★ for Low Maintenance, Gainability, Marbling, Rib-eye area, Calving Ease, Stayability.

• Bulls •



**158** BECKTON WARRIOR C540 L5 

2 100% # 3487889 Tat.: BSF5 C540

Birth: 3-30-15

Beckton Warrior C1 S337  
Beckton Warrior CL M686  
Beckton Christy K101 CD

**BECKTON WARRIOR W534 N4**  
Ref. W-2 BKT Larkeisa S055 NB  
Beckton Nebula P P707  
Beckton Larkeisa P688 CH

Beckton Lancer T5 L095  
Beckton Lancer F442 T  
Beckton Belga J293 HR

**BECKTON LANA P520 LN**  
Beckton Lana L827 WR  
Beckton Warrior T C371  
Beckton Lana F028 VG

BWT	72
WR	86
ADG	3.75
YWT	1085
YR	97
Scr.	36
Fr.	5.0

RAAA HerdBuilder index: 127 (Top 22% of all RA bulls)  
RAAA GridMaster index: 51 (Top 12% of all RA bulls)

Calv.Ease	BW	WW	YW	Milk	HPG	Stay	Maint.En.	
EPDs	11.8	-3.9	38.5	65.4	27	11.9	11.5	-7.5
Marb	+0.86	REA	+0.18	Bfat	+0.02			

★★★★★ for Low Maintenance, Marbling, Rib-eye area, Calving Ease.

**156** BSF ACCENT C247 C4 

1-B 99% # 3487885 Tat.: BSF5 C247

Birth: 3-18-15

Beckton Accent U777 C2  
Beckton Cody K1 P014  
Beckton Susan R022 CQ

**BECKTON ACCENT Y312 N3**  
Ref. A-3 BKT Larkeisa S055 NB  
Beckton Nebula P P707  
Beckton Larkeisa P688 CH

Beckton Cherokee N N479  
BFCK Cherokee Cryn 4912

**BSF HELENA R016 CQ**  
Beckton Herald FJ J776  
Beckton Dinah C440 NM  
BSF Helena N186 HR  
BSF Regus C791

BWT	53
WR	82
ADG	4.09
YWT	1074
YR	96
Scr.	36
Fr.	5.0

RAAA HerdBuilder index: 159 (Top 4% of all RA bulls)  
RAAA GridMaster index: 52 (Top 4% of all RA bulls)

Calv.Ease	BW	WW	YW	Milk	HPG	Stay	Maint.En.	
EPDs	16.2	-7.6	41.3	70	26	14.1	13.8	-3.6
Marb	+0.76	REA	+0.19	Bfat	+0.04			

★★★★★ for Low Maintenance, Gainability, Marbling, Rib-eye area, Calving Ease, Stayability.

**159** BSF LUNESTA C190 H2 

99% # un-reg Tat.: BSF5 C190

Birth: 3-11-15

Mushrush Lunesta MD Y097  
Mushrush Lunesta W033  
Mushrush Madam OS U109

**MUSHRUSH LUNESTA A007**  
Ref. A-4 Mushrush Candice JL X212  
Padg Julian 674  
Padg Candy 196

Beckton Hasten Y069 D4  
Beckton Hasten U108 J3  
Beckton Marta P484 DM

**BSF JULIANNE A116 H**  
BSF Julianne Y404 N  
BSF Julianne T011 NB

BWT	62
WR	102
ADG	3.75
YWT	1106
YR	107
Scr.	36
Fr.	5.0

RAAA HerdBuilder index: (Top 23% of all RA bulls)  
RAAA GridMaster index: (Top 5% of all RA bulls)

Calv.Ease	BW	WW	YW	Milk	HPG	Stay	Maint.En.	
EPDs	12	-5.3	38.8	73.7	20.5	9.5	12.8	-1.0
Marb	+0.53	REA	+0.00	Bfat	+0.04			

★★★★★ for Low Maintenance, Growth, Marbling, Calving Ease.

**157** BECKTON DOMINOR C146 J8 

1-A 100% # 3487472 Tat.: BKT5 C146

Birth: 3-6-15

Beckton Dominor Y005 V6  
Beckton Dominor W640 C5  
Beckton Belga W108 V

**BECKTON DOMINOR A378 W7**  
Ref. D-1 Beckton Lana Y541 W  
Beckton Warrior T248 L5  
Beckton Lana S074 EP

Beckton Janus X799 L2  
Beckton Roman J S158  
Beckton Sierra K557 LO

**BECKTON LYDIA A687 O**  
Beckton Lydia X562 R  
Beckton Ranger T603 H3  
Beckton Lydia S069 NB

BWT	55
WR	94
ADG	3.69
YWT	1073
YR	104
Scr.	36
Fr.	5.0

RAAA HerdBuilder index: 164 (Top 3% of all RA bulls)  
RAAA GridMaster index: 51 (Top 10% of all RA bulls)

Calv.Ease	BW	WW	YW	Milk	HPG	Stay	Maint.En.	
EPDs	13.3	-5.9	45	81.1	21	10.5	14.5	-4.0
Marb	+0.50	REA	+0.11	Bfat	+0.04			

★★★★★ for Low Maintenance, Marbling, Calving Ease, Stayability.

**160** BECKTON JANUS C628 E3 

1-A 100% # 3487758 Tat.: BSF5 C628

Birth: 4-5-15

Beckton Roman J S158  
TR Romeo NT379  
Beckton Belga K285 JL

**BECKTON JANUS X799 L2**  
Ref. J-3 Beckton Sierra K557 LO  
Beckton Loki F251  
Beckton Sierra C157 CL

Beckton Emperor T641 E2  
Beckton Emperor R100  
Beckton Vernice R416 EP

**BECKTON BELGA X736 E**  
Beckton Belga M050 EP  
Beckton Epic K1 K863  
Beckton Belga K588 HD

BWT	67
WR	86
ADG	3.75
YWT	1083
YR	97
Scr.	34
Fr.	5.5

RAAA HerdBuilder index: 121 (Top 28% of all RA bulls)  
RAAA GridMaster index: 50 (Top 21% of all RA bulls)

Calv.Ease	BW	WW	YW	Milk	HPG	Stay	Maint.En.	
EPDs	15.4	-6.1	37	65	30	8.9	10	-2.5
Marb	+0.37	REA	+0.21	Bfat	+0.00			

★★★★★ for Low Maintenance, Marbling, Rib-eye area, Calving Ease.



• Bulls •

**161 BECKTON NEW ERA C074 N3**  
1-A 100% # 3487665 Tat.: BSF5 C074 

Birth: 2-25-15

Beckton New Era Y194  
**BECKTON NEW ERA A395 L2**  
Ref. N-5  
Beckton Minerva X612 L

Beckton Nebula P P707  
BKT Larkeisa T310 JC  
Beckton Legend U331 E2  
Beckton Minerva U313 NB

Beckton New Era Y194  
**BECKTON BAYBERRY A384 N**  
BKT Bayberry R322 HU  
Beckton Nebula P P707  
BKT Larkeisa T310 JC  
Beckton Hustler C2 L079  
Bkt Bayberry LC31 SC

**DAM**  
Age 2  
Wt 1055  
Prog.BW 57  
WR 92  
YR 99  
Wean Pct. 40%  
Cow Eff. 84

RAAA HerdBuilder index: **171** (Top 2% of all RA bulls)  
RAAA GridMaster index: **50** (Top 21% of all RA bulls)  
Calv.Ease BW WW YW Milk HPG Stay Maint.En.  
EPDs **12.7 -4.3 56.8 91.6 22 13.1 12 -1.7**  
Marb **+4.5** REA **-0.1** Bfat **+0.3**

BWt **57**  
WR **92**  
ADG **3.81**  
YWt **1016**  
YR **99**  
Scr. **32**  
Fr. **5.5**

★★★★★ for Low Maintenance, Marbling, Calving Ease.

**163 BECKTON NEW ERA C539 E2**  
1-A 100% # 3487873 Tat.: BSF5 C539 

Birth: 3-30-15

Beckton Nebula P P707  
**BECKTON NEW ERA Y194**  
Ref. N-4  
BKT Larkeisa T310 JC

Beckton Nebula M045  
Beckton Lana M809 EP  
Beckton Justice C1 R483  
BKT Larkeisa R775 JC  
Beckton Epic KJ J722  
Beckton Lana F268 CT  
Beckton Julian 7526G  
Beckton Marta 8955KR

Beckton Epic K3 M606  
**BECKTON MARTA R790 EP**  
Beckton Marta C314 JL

**DAM**  
Age 10  
Wt 1220  
Prog.BW 68  
WR 96  
YR 100  
Wean Pct. 40%  
Cow Eff. 85

RAAA HerdBuilder index: **131** (Top 19% of all RA bulls)  
RAAA GridMaster index: **51** (Top 10% of all RA bulls)  
Calv.Ease BW WW YW Milk HPG Stay Maint.En.  
EPDs **14.2 -5.5 47.4 84.4 25 10.9 11.3 -4.1**  
Marb **+5.1** REA **-0.7** Bfat **+0.1**

BWt **55**  
WR **83**  
ADG **3.58**  
YWt **1064**  
YR **95**  
Scr. **36**  
Fr. **5.0**

★★★★★ for Low Maintenance, Marbling, Calving Ease.

**162 BECKTON ACCENT C113 N4**  
1-A 100% # 3487639 Tat.: BKT5 C113 

Birth: 3-2-15

Beckton Accent U777 C2  
**BECKTON ACCENT A485 C3**  
Ref. A-7  
Beckton Tamara R175 CQ

Beckton Cody K1 P014  
Beckton Susan R022 CQ  
Beckton Cherokee N N479  
Beckton Tamara N765 CO  
Beckton Nebula W065 C3  
Beckton Rose W402 N  
Beckton Nebula W065 C3  
Beckton Lana W277 A

Beckton Nebula Y036 N4  
**BECKTON LANA A003 N**  
Beckton Lana Y024 N

**DAM**  
Age 2  
Wt 754  
Prog.BW 62  
WR 94  
YR 101  
Wean Pct. 57%  
Cow Eff. 120

RAAA HerdBuilder index: **182** (Top 1% of all RA bulls)  
RAAA GridMaster index: **51** (Top 17% of all RA bulls)  
Calv.Ease BW WW YW Milk HPG Stay Maint.En.  
EPDs **11.6 -4.9 46.1 75.3 28 13.2 18.7 -3.2**  
Marb **+5.1** REA **+2.7** Bfat **+0.1**

BWt **62**  
WR **94**  
ADG **3.64**  
YWt **1037**  
YR **101**  
Scr. **34**  
Fr. **5.5**

★★★★★ for Low Maintenance, Marbling, Rib-eye area, High Cow Efficiency, Calving Ease, Stayability.

**164 BECKTON NEBULA C188 N5**  
1-A 100% # 3487481 Tat.: BKT5 C188 

Birth: 3-11-15

Beckton Nebula T398 V3  
**BECKTON NEBULA A773 L4**  
Ref. N-6  
Beckton Mona X022 L

Beckton Nebula L P093  
Beckton Minerva J615 VG  
Beckton Likable U130 L2  
Beckton Mona U584 CD  
Beckton Nebula M045  
Beckton Lana M809 EP  
Bkt Javelin 7466 R  
Beckton Kit S545 LN

Beckton Nebula P P707  
**BECKTON KIT A595 N**  
Beckton Kit X237 L

**DAM**  
Age 2  
Wt 745  
Prog.BW 69  
WR 99  
YR 107  
Wean Pct. 63%  
Cow Eff. 132

RAAA HerdBuilder index: **172** (Top 2% of all RA bulls)  
RAAA GridMaster index: **51** (Top 9% of all RA bulls)  
Calv.Ease BW WW YW Milk HPG Stay Maint.En.  
EPDs **12.1 -4.7 55.7 89 20 12.3 16.3 -6.2**  
Marb **+5.9** REA **+0.7** Bfat **+0.0**

BWt **65**  
WR **101**  
ADG **3.41**  
YWt **1021**  
YR **99**  
Scr. **32**  
Fr. **6.0**

★★★★★ for Low Maintenance, Marbling, High Cow Efficiency, Calving Ease, Stayability.



**165 BECKTON WARHAWK C472 L2**  
1-A 100% # 3487433 Tat.: BKT5 C472 

Birth: 3-27-15

Beckton Warrior T1 H281  
**BECKTON WARHAWK N560**  
Ref. W-1  
Beckton Firefly H195 HD

Beckton Warrior TC E801  
Beckton Minerva B609 RN  
Beckton Hadrian A100  
Beckton Firefly C999 CB  
Beckton Lancer T A664  
Beckton Cherova Z157 ZN  
Beckton Warrior T C371  
Beckton Vernice D066 NM

Beckton Lancer TZ D525  
**BECKTON VERNICE L382 LN**  
Beckton Vernice G373 WR

**DAM**  
Age 14  
Wt 1195  
Prog.BW 68  
WR 103  
YR 104  
Wean Pct. 44%  
Cow Eff. 92

RAAA HerdBuilder index: **148** (Top 8% of all RA bulls)  
RAAA GridMaster index: **51** (Top 18% of all RA bulls)  
Calv.Ease BW WW YW Milk HPG Stay Maint.En.  
EPDs **17.7 -8.5 29.4 48.9 17 15.5 11.3 -5.6**  
Marb **+6.0** REA **-1.8** Bfat **+0.1**

BWt **57**  
WR **92**  
ADG **3.33**  
YWt **1067**  
YR **95**  
Scr. **35**  
Fr. **5.0**

★★★★★ for Low Maintenance, Marbling, Calving Ease.

• Bulls •

**166** **BECKTON SCAMP C683 N4**   
 1-A 100% # 3487779 Tat.: BSF5 C682  
 Birth: 4-11-15  
 Beckton Scamp T A825 < Beckton Scamp 8954  
 Bkt Encino 8459 TJ  
**BECKTON SCAMP X458 H3** < Beckton Hustler C2 L079  
 Ref. S-1 < BKT Pine Marie R401 HU < Bkt Pine Marie LC30 CD  
 Beckton Nebula T269 E2 < Beckton Nebula M045  
 Beckton Ruth M967 EP  
**BECKTON BARMAID X231 N** < Beckton Lancer T A664  
 Beckton Barmaid G565 LN < Bkt Barmaid 9517 RN  
 BWT **71**  
 WR **99**  
 ADG **3.33**  
 YWt. **1092**  
 YR **98**  
 Scr. **40**  
 Fr. **5.0**

**DAM**  
 Age 5  
 Wt 1075  
 Prog.BW 66  
 WR 111  
 YR 103  
 Wean Pct. 55%  
 Cow Eff. 115

RAAA HerdBuilder index: **136** (Top 15% of all RA bulls)  
 RAAA GridMaster index: **50** (Top 28% of all RA bulls)  
 Calv.Ease BW WW YW Milk HPG Stay Maint.En.  
 EPDs **14 -6.4 35 55.9 24 12.5 11.7 -8.0**  
 Marb **+4.8** REA **+0.6** Bfat **+0.0**

**169** **BSF NEBULA C315 C5**   
 1-B 99% # 3487696 Tat.: BSF5 C315  
 Birth: 3-21-15  
 Beckton Nebula PJ S543 < Beckton Nebula P P707  
 Beckton Lana P685 JO  
**BECKTON NEBULA U060 N4** < Beckton Nebula P P707  
 Ref. N < Beckton Birdie S110 NB < Beckton Birdie P086 WR  
 Beckton Clifftop W577 E3 < BKT Clifftop TP R288  
 BKT Pine Marie R213 EP  
**BSF NEBULANN Z664 C** < Beckton Cody K2 R168  
 BSF Nebulann U227 CD < BSF Nebulann P046  
 BWT **62**  
 WR **100**  
 ADG **3.33**  
 YWt. **1082**  
 YR **98**  
 Scr. **35**  
 Fr. **5.0**

**DAM**  
 Age 3  
 Wt 1050  
 Prog.BW 62  
 WR 100  
 YR 98  
 Wean Pct. 51%  
 Cow Eff. 107

RAAA HerdBuilder index: **172** (Top 2% of all RA bulls)  
 RAAA GridMaster index: **52** (Top 8% of all RA bulls)  
 Calv.Ease BW WW YW Milk HPG Stay Maint.En.  
 EPDs **16.9 -7.6 42.6 64 19 12.9 15.1 -3.9**  
 Marb **+8.1** REA **-0.7** Bfat **+0.2**

★★★★★ for Low Maintenance, Marbling, Superior Cow, Calving Ease.

★★★★★ for Low Maintenance, Marbling, Calving Ease, Stayability.

**167** **BECKTON SCAMP C191 A5**   
 1-A 100% # 3487490 Tat.: BKT5 C191  
 Birth: 3-12-15  
 Beckton Scamp X494 E3 < Beckton Scamp T A825  
 Beckton Lana S074 EP  
**BECKTON SCAMP A633 C4** < Beckton Clifftop T3 N800  
 Ref. S-5 < Beckton Rose R507 CT < Beckton Rose N125 LN  
 Beckton Cody K1 P014  
**BECKTON TAMARA A547 A** < Beckton Susan R022 CQ  
 Beckton Epic T524 L5  
 Beckton Tamara T783 NW  
 BWT **51**  
 WR **110**  
 ADG **3.51**  
 YWt. **1063**  
 YR **103**  
 Scr. **34**  
 Fr. **5.0**

**DAM**  
 Age 2  
 Wt 840  
 Prog.BW 51  
 WR 110  
 YR 103  
 Wean Pct. 61%  
 Cow Eff. 128

RAAA HerdBuilder index: **146** (Top 9% of all RA bulls)  
 RAAA GridMaster index: **50** (Top 25% of all RA bulls)  
 Calv.Ease BW WW YW Milk HPG Stay Maint.En.  
 EPDs **14.8 -7.4 42.6 62.2 26 8.5 13.6 -2.7**  
 Marb **+5.2** REA **-0.9** Bfat **+0.1**

★★★★★ for Low Maintenance, Marbling, Superior Cow, High Cow Efficiency, Calving Ease, Stayability.



**168** **BECKTON LIKABLE C645 L3**   
 1-A 100% # 3487656 Tat.: BSF5 C645  
 Birth: 4-7-15  
 Beckton Likable S633 < Beckton Lancer F442 T  
 Beckton Kit F468 JL  
**BECKTON LIKABLE U130 L2** < Beckton Lancer F442 T  
 Ref. L-1 < Beckton Kit S478 LN < Beckton Kit F468 JL  
 Beckton Legend U331 E2 < Beckton Legend S670  
 Beckton Lana S669 EP  
**BECKTON CHRISTY X005 L** < Beckton Julian GJ P535  
 Beckton Christy U415 JL < Beckton Christy P333 CH  
 BWT **70**  
 WR **99**  
 ADG **2.99**  
 YWt. **1097**  
 YR **98**  
 Scr. **36**  
 Fr. **5.0**

**DAM**  
 Age 5  
 Wt 1075  
 Prog.BW 63  
 WR 98  
 YR 98  
 Wean Pct. 55%  
 Cow Eff. 115

RAAA HerdBuilder index: **147** (Top 9% of all RA bulls)  
 RAAA GridMaster index: **52** (Top 5% of all RA bulls)  
 Calv.Ease BW WW YW Milk HPG Stay Maint.En.  
 EPDs **11.8 -6.2 44.8 70.2 16 11.2 13.4 -7.1**  
 Marb **+8.1** REA **+4.5** Bfat **+0.3**

★★★★★ for Low Maintenance, Marbling, Rib-eye area, Calving Ease, Stayability.

**170** **BECKTON DOMINOR C137 J8**   
 1-A 100% # 3487447 Tat.: BKT5 C137  
 Birth: 3-5-15  
 Beckton Dominor Y005 V6 < Beckton Dominor W640 C5  
 Beckton Belga W108 V  
**BECKTON DOMINOR A378 W7** < Beckton Warrior T248 L5  
 Ref. D-1 < Beckton Lana S074 EP  
 Beckton Roman J S158  
 Beckton Sierra K557 LO  
**BECKTON LANA A872 O** < Beckton Likable U120 L2  
 Beckton Lana X157 L < Beckton Lana U775 NB  
 BWT **67**  
 WR **103**  
 ADG **3.91**  
 YWt. **1073**  
 YR **104**  
 Scr. **31**  
 Fr. **5.0**

**DAM**  
 Age 2  
 Wt 900  
 Prog.BW 67  
 WR 103  
 YR 104  
 Wean Pct. 53%  
 Cow Eff. 111

RAAA HerdBuilder index: **163** (Top 3% of all RA bulls)  
 RAAA GridMaster index: **51** (Top 19% of all RA bulls)  
 Calv.Ease BW WW YW Milk HPG Stay Maint.En.  
 EPDs **11.3 -4.7 45.4 73.1 24 8.5 16.2 -1.9**  
 Marb **+5.5** REA **+1.6** Bfat **+0.0**

★★★★★ for Low Maintenance, Marbling, Rib-eye area, Calving Ease, Stayability.

• Bulls •

**171** **BECKTON JULIAN C450 A6**   
 1-A 100% # 3487244 Tat.: BKT5 C450  
 Birth: 3-27-15

Beckton Julian G5 S107	Beckton Julian GJ P535	BWt	<b>70</b>
Beckton Julian X465 J5	Beckton Minola P826 DM	WR	<b>97</b>
Ref. J-2	Beckton Julian GG B571	ADG	<b>3.51</b>
Beckton Suffeina P643 JL	Bkt Suffeina A828 DM	YWt	<b>1089</b>
Beckton Accent W180 C2	Beckton Cody K1 P014	YR	<b>99</b>
<b>BECKTON COCA Z529 A</b>	Beckton Christy R046 CQ	Scr.	<b>37</b>
Beckton Coca T168 NB	Beckton Nebula M045	Fr.	<b>5.0</b>
	Beckton Coca H256 JL		

**DAM**  
 Age 3  
 Wt 1035  
 Prog.BW 70  
 WR 97  
 YR 99  
 Wean Pct. 50%  
 Cow Eff. 105

RAAA HerdBuilder index: **161** (Top 4% of all RA bulls)  
 RAAA GridMaster index: **52** (Top 6% of all RA bulls)  
 Calv.Ease BW WW YW Milk HPG Stay Maint.En.  
 EPDs **12.5 -3.9 49.2 83.1 16 15.3 14.2 -4.8**  
 Marb **+0.87** REA **-1.12** Bfat **+0.1**

★★★★★ for Low Maintenance, Marbling, Calving Ease, Stayability.



**172** **BECKTON JULIAN C144 L7**   
 1-A 100% # 3487464 Tat.: BKT5 C144  
 Birth: 3-6-15

Beckton Julian X465 J5	Beckton Julian G5 S107	BWt	<b>68</b>
<b>BECKTON JULIAN A479 L6</b>	Beckton Suffeina P643 JL	WR	<b>107</b>
Ref. J-5	Beckton Likable U120 L2	ADG	<b>3.22</b>
Beckton Eola X216 L	Beckton Eola U027 NB	YWt	<b>1052</b>
Beckton Julian X465 J5	Beckton Julian G5 S107	YR	<b>102</b>
<b>BECKTON INDIGO A745 J</b>	Beckton Suffeina P643 JL	Scr.	<b>34</b>
Beckton Indigo W477 E	Beckton Emcee S466	Fr.	<b>5.0</b>
	Beckton Indigo P043 LO		

**DAM**  
 Age 2  
 Wt 925  
 Prog.BW 68  
 WR 107  
 YR 102  
 Wean Pct. 54%  
 Cow Eff. 114

RAAA HerdBuilder index: **153** (Top 6% of all RA bulls)  
 RAAA GridMaster index: **51** (Top 19% of all RA bulls)  
 Calv.Ease BW WW YW Milk HPG Stay Maint.En.  
 EPDs **9.9 -2.8 52.8 84.6 20 10 14.9 -6.4**  
 Marb **+0.73** REA **-1.11** Bfat **+0.02**

★★★★★ for Low Maintenance, Marbling, Calving Ease, Stayability.

**174** **BSF SCAMP C117 N5**   
 1-B 99% # 3487920 Tat.: BSF5 C117  
 Birth: 3-3-15

Beckton Scamp X494 E3	Beckton Scamp T A825	BWt	<b>56</b>
<b>BECKTON SCAMP A627 J4</b>	Beckton Lana S074 EP	WR	<b>114</b>
Ref. S-4	Beckton Justice Cc N265	ADG	<b>3.68</b>
Beckton Serena R023 JC	Beckton Serena N469 JC	YWt	<b>1045</b>
Beckton Nebula T269 E2	Beckton Nebula M045	YR	<b>101</b>
<b>BSF EPIQUETTE A910 N</b>	Beckton Ruth M967 EP	Scr.	<b>34</b>
BSF Epiquette U076 EP	Beckton Epic K7 S583	Fr.	<b>5.0</b>
	BSF Epiquette S364 EP		

**DAM**  
 Age 2  
 Wt 840  
 Prog.BW 56  
 WR 114  
 YR 101  
 Wean Pct. 64%  
 Cow Eff. 134

RAAA HerdBuilder index: **137** (Top 14% of all RA bulls)  
 RAAA GridMaster index: **49** (Top 53% of all RA bulls)  
 Calv.Ease BW WW YW Milk HPG Stay Maint.En.  
 EPDs **13.7 -5.9 41.8 62.6 23 13.6 12.1 -4.2**  
 Marb **+0.26** REA **+1.10** Bfat **+0.02**

★★★★★ for Low Maintenance, Marbling, High Cow Efficiency, Calving Ease.

**173** **BECKTON JANUS C568 N3**   
 1-A 100% # 3487853 Tat.: BSF5 C568  
 Birth: 4-1-15

Beckton Roman J S158	TR Romeo NT379	BWt	<b>50</b>
<b>BECKTON JANUS X799 L2</b>	Beckton Belga K285 JL	WR	<b>98</b>
Ref. J-3	Beckton Loki F251	ADG	<b>3.16</b>
Beckton Sierra K557 LO	Beckton Sierra C157 CL	YWt	<b>1074</b>
Beckton Nebula G S237	Beckton Nebula M045	YR	<b>96</b>
<b>BECKTON ENCINO U063 NB</b>	Beckton Lakme LA06 JL	Scr.	<b>32</b>
Beckton Encino S090 JT	Beckton Jet L P491	Fr.	<b>4.5</b>
	Beckton Encino P300 LN		

**DAM**  
 Age 7  
 Wt 1230  
 Prog.BW 57  
 WR 103  
 YR 101  
 Wean Pct. 47%  
 Cow Eff. 99

RAAA HerdBuilder index: **158** (Top 5% of all RA bulls)  
 RAAA GridMaster index: **52** (Top 4% of all RA bulls)  
 Calv.Ease BW WW YW Milk HPG Stay Maint.En.  
 EPDs **17.9 -8.8 32.7 54.4 31 10.8 13.1 1.0**  
 Marb **+0.85** REA **+0.00** Bfat **+0.1**

★★★★★ for Low Maintenance, Marbling, Calving Ease, Stayability.

**175** **BECKTON EMPEROR C084 E5**   
 1-A 100% # 3488028 Tat.: BSF5 C084  
 Birth: 2-25-15

Beckton Emperor Y459 J3	Beckton Emperor T641 E2	BWt	<b>65</b>
<b>BECKTON EMPEROR A165 W4</b>	Beckton Indigo S354 JT	WR	<b>105</b>
Ref. E-5	Beckton Warrior U636 JS	ADG	<b>3.10</b>
Beckton Minola Y634 W	Beckton Minola S103 JL	YWt	<b>1021</b>
Beckton Emperor Y459 J3	Beckton Emperor T641 E2	YR	<b>99</b>
<b>BECKTON COCA A056 E</b>	Beckton Indigo S354 JT	Scr.	<b>35</b>
Beckton Coca Y399 L	Beckton Likable U120 L2	Fr.	<b>5.0</b>
	Beckton Coca H051 CH		

**DAM**  
 Age 2  
 Wt 965  
 Prog.BW 65  
 WR 105  
 YR 99  
 Wean Pct. 50%  
 Cow Eff. 106

RAAA HerdBuilder index: **153** (Top 6% of all RA bulls)  
 RAAA GridMaster index: **51** (Top 10% of all RA bulls)  
 Calv.Ease BW WW YW Milk HPG Stay Maint.En.  
 EPDs **13.6 -5.1 48.7 74.3 16 9 13.5 -5.6**  
 Marb **+0.74** REA **+0.01** Bfat **-0.03**

★★★★★ for Low Maintenance, Marbling, Calving Ease, Stayability.



• Bulls •

**176 BECKTON NEW ERA C025 S3**  
1-A 100% # 3487521 Tat.: BKT5 C025



Birth: 2-20-15

Beckton New Era Y194  
**BECKTON NEW ERA A395 L2**  
 Ref. N-5 Beckton Minerva X612 L

Beckton Nebula P P707  
 BKT Larkeisa T310 JC  
 Beckton Legend U331 E2  
 Beckton Minerva U313 NB

Beckton Scamp X494 E3  
**BECKTON LARKEISA A283 S**  
 Beckton Larkeisa M138 JC

Beckton Scamp T A825  
 Beckton Lana S074 EP  
 Beckton Justice G302  
 Bkt Larkeisa G448 CT

BWt	59
WR	97
ADG	3.16
YWt	1019
YR	99
Scr.	32
Fr.	4.5

Age	2
Wt	NA
Prog.BW	59
WR	97
YR	99
Wean Pct. NA%	
Cow Eff.	NA

RAAA HerdBuilder index: **161** (Top 4% of all RA bulls)  
 RAAA GridMaster index: **51** (Top 11% of all RA bulls)

Calv.Ease	BW	WW	YW	Milk	HPG	Stay	Maint.En.	
EPDs	14.8	-6.2	40.4	66.6	22	13.1	14.6	-5.5

Marb **+0.71** REA **-0.03** Bfat **+0.01**

★★★★★ for Low Maintenance, Marbling, Calving Ease, Stayability.

**179 BECKTON NEW ERA C045 J3**  
1-A 100% # 3487627 Tat.: BKT5 C045



Birth: 2-23-15

Beckton New Era Y194  
**BECKTON NEW ERA A395 L2**  
 Ref. N-5 Beckton Minerva X612 L

Beckton Nebula P P707  
 BKT Larkeisa T310 JC  
 Beckton Legend U331 E2  
 Beckton Minerva U313 NB

Beckton Janus X799 L2  
**BECKTON KIT A102 O**  
 Beckton Kit S545 LN

Beckton Roman J S158  
 Beckton Sierra K557 LO  
 Beckton Lancer F442 T  
 Beckton Kit F468 JL

BWt	56
WR	98
ADG	3.62
YWt	1030
YR	100
Scr.	32
Fr.	5.0

Age	2
Wt	985
Prog.BW	56
WR	98
YR	100
Wean Pct. 46%	
Cow Eff.	96

RAAA HerdBuilder index: **165** (Top 3% of all RA bulls)  
 RAAA GridMaster index: **53** (Top 3% of all RA bulls)

Calv.Ease	BW	WW	YW	Milk	HPG	Stay	Maint.En.	
EPDs	14.2	-6.2	45.4	72	24	6	15.3	0.4

Marb **+1.00** REA **+0.10** Bfat **+0.03**

★★★★★ for Low Maintenance, Marbling, Calving Ease, Stayability.

**177 BECKTON SCAMP C046 E4**  
1-A 100% # 3487640 Tat.: BSF5 C046



Birth: 2-23-15

Beckton Scamp T A825  
**BECKTON SCAMP A626 H3**  
 Ref. S-3 Beckton Rose T770 HI

Beckton Scamp 8954  
 BKT Encino 8459 TJ  
 Beckton Hilltop R157  
 Beckton Rose R507 CT

Beckton Emperor Y459 J3  
**BECKTON DINAH A013 E**  
 Beckton Dinah Y170 W

Beckton Emperor T641 E2  
 Beckton Indigo S354 JT  
 Beckton Warrior U636 J5  
 Beckton Dinah K287 HU

BWt	59
WR	100
ADG	2.93
YWt	1002
YR	97
Scr.	37
Fr.	5.0

Age	2
Wt	840
Prog.BW	59
WR	100
YR	97
Wean Pct. 55%	
Cow Eff.	116

RAAA HerdBuilder index: **128** (Top 21% of all RA bulls)  
 RAAA GridMaster index: **50** (Top 32% of all RA bulls)

Calv.Ease	BW	WW	YW	Milk	HPG	Stay	Maint.En.	
EPDs	14.3	-6.3	44.5	67.2	21	10.1	11.4	-4.8

Marb **+0.36** REA **+0.08** Bfat **+0.00**

★★★★★ for Low Maintenance, Marbling, High Cow Efficiency, Calving Ease.



Lot 177

**178 BECKTON EMPEROR C164 N5**  
1-A 100% # 3487444 Tat.: BKT5 C164



Birth: 3-8-15

Beckton Emperor Y459 J3  
**BECKTON EMPEROR A165 W4**  
 Ref. E-5 Beckton Minola Y634 W

Beckton Emperor T641 E2  
 Beckton Indigo S354 JT  
 Beckton Warrior U636 J5  
 Beckton Minola S103 JL

Beckton Nebula W778 J4  
**BECKTON LANA A886 N**  
 Beckton Lana W712 N

Beckton Nebula PJ S543  
 Beckton Lana S197 JT  
 Beckton Nebula T269 E2  
 Beckton Lana T817 CT

BWt	63
WR	105
ADG	3.28
YWt	1029
YR	100
Scr.	33
Fr.	5.0

Age	2
Wt	830
Prog.BW	63
WR	105
YR	100
Wean Pct. 59%	
Cow Eff.	124

RAAA HerdBuilder index: **166** (Top 3% of all RA bulls)  
 RAAA GridMaster index: **53** (Top 3% of all RA bulls)

Calv.Ease	BW	WW	YW	Milk	HPG	Stay	Maint.En.	
EPDs	14.6	-5.8	49.3	76.4	14	8.5	15	-2.5

Marb **+0.96** REA **-0.02** Bfat **-0.01**

★★★★★ for Low Maintenance, Marbling, High Cow Efficiency, Calving Ease, Stayability.

**180 BECKTON NEBULA C251 D3**  
1-A 100% # 3487236 Tat.: BKT5 C251



Birth: 3-18-15

Beckton Nebula M045  
**BECKTON NEBULA P P707**  
 Ref. N-1 Beckton Lana M809 EP

Beckton Neptune R2 K065  
 Beckton Belga K285 JL  
 Beckton Epic K1 K863  
 Beckton Lana K253 DM

Beckton Dominor W640 C5  
**BECKTON COCA Z585 D**  
 Beckton Coca T419 NB

Beckton Dominor Z1 R610  
 Beckton Mona R166 CQ  
 Beckton Nebula M045  
 Beckton Coca P459 LN

BWt	82
WR	87
ADG	3.86
YWt	1086
YR	99
Scr.	39
Fr.	5.0

Age	3
Wt	1270
Prog.BW	77
WR	87
YR	99
Wean Pct. 36%	
Cow Eff.	76

RAAA HerdBuilder index: **172** (Top 2% of all RA bulls)  
 RAAA GridMaster index: **53** (Top 3% of all RA bulls)

Calv.Ease	BW	WW	YW	Milk	HPG	Stay	Maint.En.	
EPDs	12.3	-3.8	52.2	93.9	19	14.2	15.7	-3.1

Marb **+0.96** REA **-0.29** Bfat **+0.02**

★★★★★ for Low Maintenance, Marbling, Calving Ease, Stayability.

• Bulls •

**181 BECKTON LIKABLE C651 W3**   
 1-A 100% # 3487557 Tat.: BKT5 C651

Birth: 4-7-15

Beckton Likable S633  
**BECKTON LIKABLE U130 L2**  
 Ref. L-1 Beckton Kit S478 LN

Beckton Lancer F442 T  
 Beckton Kit F468 JL  
 Beckton Lancer F442 T  
 Beckton Kit F468 JL  
 Beckton Warrior N645 T1  
 Beckton Kit R503 LN  
 Beckton Epic KJ J722  
 Beckton Kit F468 JL

BWt **63**  
 WR **93**  
 ADG **3.86**  
 YWt **1107**  
 YR **99**  
 Scr. **36**  
 Fr. **5.0**

**BECKTON KIT Y460 W**  
 Beckton Warrior T248 L5  
 Beckton Kit S424 EP

**DAM**  
 Age 4  
 Wt 1105  
 Prog.BW 64  
 WR 98  
 YR 98  
 Wean Pct. 48%  
 Cow Eff. 101

RAAA HerdBuilder index: **130**(Top 19% of all RA bulls)  
 RAAA GridMaster index: **51**(Top 12% of all RA bulls)  
 Calv.Ease BW WW YW Milk HPG Stay Maint.En.  
 EPDs **9 -4.5 52.9 89.8 14 11.6 11.9 -8.6**  
 Marb **+0.28** REA **+0.62** Bfat **+0.1**



★★★★★ for Low Maintenance, Marbling, Rib-eye area, Calving Ease.

**182 BSF ACCENT C037 W5**   
 1-B 99% # 3487963 Tat.: BSF5 C037

Birth: 2-22-15

Beckton Accent Y260 L3  
**BECKTON ACCENT A110 E4**  
 Ref. A-5 Beckton Ruth Y015 E

Beckton Accent W180 C2  
 Beckton Lana W463 L  
 Beckton Emcee W271 L2  
 Beckton Ruth W488 J  
 Beckton Warrior C1 S337  
 BKT Larkeisa S055 NB  
 Beckton Clifftop T3 N800  
 BSF Nebulann P046

BWt **63**  
 WR **96**  
 ADG **3.52**  
 YWt **1020**  
 YR **99**  
 Scr. **34**  
 Fr. **4.5**

**BSF NEBULANN A471 W**  
 Beckton Warrior W534 N4  
 BSF Nebulann T682 CT

**DAM**  
 Age 2  
 Wt 850  
 Prog.BW 72  
 WR 93  
 YR 93  
 Wean Pct. 52%  
 Cow Eff. 109

RAAA HerdBuilder index: **164** (Top 3% of all RA bulls)  
 RAAA GridMaster index: **51**(Top 17% of all RA bulls)  
 Calv.Ease BW WW YW Milk HPG Stay Maint.En.  
 EPDs **12.2 -4.2 49 81.9 22 8.8 16 -6.0**  
 Marb **+0.51** REA **+0.20** Bfat **+0.02**

★★★★★ for Low Maintenance, Marbling, Rib-eye area, Calving Ease, Stayability.

**184 BECKTON HERITAGE C403 J4**   
 1-A 100% # 3487520 Tat.: BKT5 C403

Birth: 3-24-15

Beckton Heritage X356 E2  
**BECKTON HERITAGE A767 C3**  
 Ref. H-2 Beckton Rose W816 C

Beckton Heritage N013  
 Beckton Lana S489 EP  
 BKT Clifftop TP R288  
 Beckton Rose S487 LN  
 Beckton Julian G5 S107  
 Beckton Suffeina P643 JL  
 Beckton Epic KM M115  
 Beckton Sheba N497 CE

BWt **66**  
 WR **95**  
 ADG **3.69**  
 YWt **1053**  
 YR **102**  
 Scr. **33**  
 Fr. **5.5**

**BECKTON SHEBA A284 J**  
 Beckton Julian X465 J5  
 Beckton Sheba S428 EP

**DAM**  
 Age 2  
 Wt 1155  
 Prog.BW 66  
 WR 95  
 YR 102  
 Wean Pct. 38%  
 Cow Eff. 80

RAAA HerdBuilder index: **153** (Top 6% of all RA bulls)  
 RAAA GridMaster index: **51**(Top 15% of all RA bulls)  
 Calv.Ease BW WW YW Milk HPG Stay Maint.En.  
 EPDs **11.5 -3.6 51 89 22 12.6 14.4 -3.1**  
 Marb **+0.67** REA **-0.19** Bfat **+0.05**

★★★★★ for Low Maintenance, Marbling, Calving Ease, Stayability.

**183 BECKTON SCAMP C227 N5**   
 1-A 100% # 3487985 Tat.: BSF5 C227

Birth: 3-16-15

Beckton Scamp X494 E3  
**BECKTON SCAMP A633 C4**  
 Ref. S-5 Beckton Rose R507 CT

Beckton Scamp T A825  
 Beckton Lana S074 EP  
 Beckton Clifftop T3 N800  
 Beckton Rose N125 LN  
 Beckton Nebula L P093  
 Beckton Minerva J615 V3  
 Beckton Lancer T A664  
 Bkt Suffeina A828 DM

BWt **58**  
 WR **96**  
 ADG **3.35**  
 YWt **1054**  
 YR **102**  
 Scr. **33**  
 Fr. **5.5**

**BECKTON SUFFEINA A326 N**  
 Beckton Nebula T398 V3  
 Beckton Suffeina P671 LN

**DAM**  
 Age 2  
 Wt 1020  
 Prog.BW 58  
 WR 96  
 YR 102  
 Wean Pct. 43%  
 Cow Eff. 91

RAAA HerdBuilder index: **139**(Top 13% of all RA bulls)  
 RAAA GridMaster index: **51**(Top 10% of all RA bulls)  
 Calv.Ease BW WW YW Milk HPG Stay Maint.En.  
 EPDs **11.7 -4.7 48.8 82 23 10.1 13.4 .0**  
 Marb **+0.60** REA **+0.12** Bfat **+0.00**

★★★★★ for Low Maintenance, Marbling, Calving Ease, Stayability.

**185 BECKTON ROOSEVELT C529 D2**   
 1-A 100% # 3487261 Tat.: BKT5 C529

Birth: 3-30-15

Bieber Rough Rider 10712  
**BIEBER ROOSEVELT W384**  
 Ref. B-1 Bieber Sheba 9602

Basin Trend Setter 6074  
 Bieber Adelle 8958  
 C A Future Direction 5321  
 Bieber Sheba 5537  
 Beckton Dominor Z1 R610  
 Beckton Mona R166 CQ  
 BKT Clifftop TP R288  
 Beckton Minola R720 JJ

BWt **81**  
 WR **89**  
 ADG **3.75**  
 YWt **1045**  
 YR **95**  
 Scr. **33**  
 Fr. **5.0**

**BECKTON MINOLA Z310 D**  
 Beckton Dominor W640 C5  
 Beckton Minola U839 CT

**DAM**  
 Age 3  
 Wt 1100  
 Prog.BW 81  
 WR 89  
 YR 95  
 Wean Pct. 43%  
 Cow Eff. 90

RAAA HerdBuilder index: **135**(Top 16% of all RA bulls)  
 RAAA GridMaster index: **49**(Top 43% of all RA bulls)  
 Calv.Ease BW WW YW Milk HPG Stay Maint.En.  
 EPDs **7.6 -1.4 46.6 72.8 23 15 13 -8.8**  
 Marb **+0.73** REA **+0.21** Bfat **+0.07**

★★★★★ for Low Maintenance, Marbling, Rib-eye area, Calving Ease, Stayability.

• Bulls •

**186** **BECKTON ACCENT C456 C5** 

1-A 100% # 3487629 Tat.: BKT5 C456

Birth: 3-27-15

Beckton Accent Y260 L3  
**BECKTON ACCENT A110 E4**  
 Ref. A-5  
 Beckton Ruth Y015 E

Beckton Clifftop W692 E3  
**BECKTON PINE MARIE A074 C**  
 BKT Pine Marie X596 N

Beckton Accent W180 C2  
 Beckton Lana W463 L  
 Beckton Emcee W271 L2  
 Beckton Ruth W488 J  
 BKT Clifftop TP R288  
 Beckton Lydia S274 EP  
 Beckton Nebula PJ S543  
 BKT Pine Marie T408 JD

BWt **67**  
 WR **109**  
 ADG **3.41**  
 YWt **1083**  
 YR **105**  
 Scr. **34**  
 Fr. **5.5**

**DAM**  
 Age 2  
 Wt 1045  
 Prog.BW 67  
 WR 109  
 YR 105  
 Wean Pct. 49%  
 Cow Eff. 103

RAAA HerdBuilder index: **163** (Top 3% of all RA bulls)  
 RAAA GridMaster index: **50** (Top 21% of all RA bulls)  
 Calv.Ease BW WW YW Milk HPG Stay Maint.En.  
 EPDs **10.8 -3.2 64.4 102.3 20 8.3 15.3 -1.1**  
 Marb **+0.37** REA **+0.02** Bfat **+0.00**

**189** **BSF LIKABLE C498 D4** 

1-B 99% # 3487177 Tat.: BKB5 C498

Birth: 3-29-15

Beckton Likable U130 L2  
**BECKTON LIKABLE Y362 L3**  
 Ref. L-3  
 Beckton Tamara M515 LN

Beckton Dominor Z1 R610  
**BSF DOMINIQUE X492 D**  
 BSF Regus G195

Beckton Likable S633  
 Beckton Kit S478 LN  
 Beckton Lancer TA K644  
 Beckton Tamara K322 LN  
 Beckton Dominor ZC M919  
 Beckton Sierra K557 LO  
 Beckton Emperor C369  
 BSF Regus 8099

BWt **69**  
 WR **75**  
 ADG **4.15**  
 YWt **986**  
 YR **88**  
 Scr. **33**  
 Fr. **5.0**

**DAM**  
 Age 5  
 Wt 1210  
 Prog.BW 76  
 WR 104  
 YR 104  
 Wean Pct. 37%  
 Cow Eff. 77

RAAA HerdBuilder index: **131** (Top 19% of all RA bulls)  
 RAAA GridMaster index: **50** (Top 32% of all RA bulls)  
 Calv.Ease BW WW YW Milk HPG Stay Maint.En.  
 EPDs **11 -3.9 37.5 66.2 23 12.4 12.7 -3.2**  
 Marb **+0.53** REA **+0.11** Bfat **+0.04**

★★★★★ for Low Maintenance, Growth, Marbling, Superior Cow, Calving Ease, Stayability.

★★★★★ for Low Maintenance, Gainability, Marbling, Superior Cow, Calving Ease.

**187** **BSF SCAMP C110 S4** 

1-B 99% # 3487973 Tat.: BSF5 C110

Birth: 3-2-15

Beckton Scamp T A825  
**BECKTON SCAMP A626 H3**  
 Ref. S-3  
 Beckton Rose T770 HI

Beckton Scamp T A825  
**BSF NEBULANN A385 S**  
 BSF Nebulann W700 N

Beckton Scamp 8954  
 BKT Encino 8459 TJ  
 Beckton Hilltop R157  
 Beckton Rose R507 CT  
 Beckton Scamp 8954  
 BKT Encino 8459 TJ  
 Beckton Nebula T054 H3  
 BSF Nebulann T046 JC

BWt **49**  
 WR **97**  
 ADG **3.13**  
 YWt **1004**  
 YR **97**  
 Scr. **35**  
 Fr. **5.0**

**DAM**  
 Age 2  
 Wt 840  
 Prog.BW 53  
 WR 102  
 YR 101  
 Wean Pct. 53%  
 Cow Eff. 112

RAAA HerdBuilder index: **143** (Top 10% of all RA bulls)  
 RAAA GridMaster index: **52** (Top 9% of all RA bulls)  
 Calv.Ease BW WW YW Milk HPG Stay Maint.En.  
 EPDs **17.3 -8.8 40.1 65.7 24 11.2 11.2 -10.0**  
 Marb **+0.52** REA **+0.03** Bfat **+0.02**

★★★★★ for Low Maintenance, Marbling, Calving Ease.

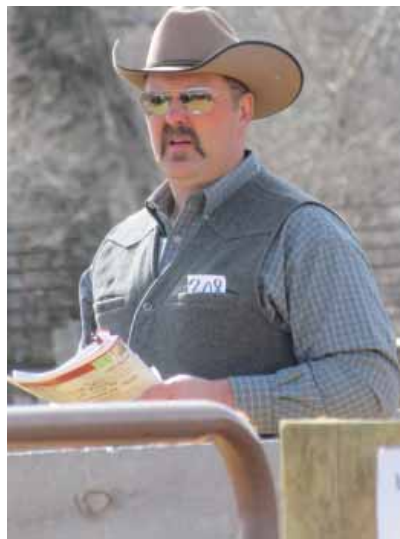

**188** **BSF ACCENT C596 L4** 

1-B 99% # 3487704 Tat.: BSF5 C596

Birth: 4-2-15

Beckton Accent W180 C2  
**BECKTON ACCENT Y260 L3**  
 Ref. A-2  
 Beckton Lana W463 L

Beckton Lancer T371 H4  
**BSF CODETTE Z490 L**  
 BSF Codette U667 EY

Beckton Cody K1 P014  
 Beckton Christy R046 CQ  
 Beckton Loki CL S284  
 Beckton Lana R327 EP  
 Beckton Lancer F442 T  
 Beckton Coca F276 HV  
 Beckton Epitomy S250  
 BSF Codette S177 CD

BWt **51**  
 WR **89**  
 ADG **3.75**  
 YWt **1045**  
 YR **97**  
 Scr. **35**  
 Fr. **5.5**

**DAM**  
 Age 3  
 Wt NA  
 Prog.BW 55  
 WR 92  
 YR 99  
 Wean Pct. NA  
 Cow Eff. NA

RAAA HerdBuilder index: **147** (Top 8% of all RA bulls)  
 RAAA GridMaster index: **50** (Top 27% of all RA bulls)  
 Calv.Ease BW WW YW Milk HPG Stay Maint.En.  
 EPDs **11.6 -3.3 58.6 90.1 19 10.2 14.5 1.1**  
 Marb **+0.47** REA **-0.01** Bfat **-0.01**

★★★★★ for Low Maintenance, Marbling, Calving Ease, Stayability.

**190** **BECKTON NEW ERA C214 J3** 

1-A 100% # 3487470 Tat.: BKT5 C214

Birth: 3-15-15

Beckton New Era Y194  
**BECKTON NEW ERA A395 L2**  
 Ref. N-5  
 Beckton Minerva X612 L

Beckton Julian X465 J5  
**BECKTON TAMARA A701 J**  
 Beckton Tamara X587 J

Beckton Nebula P P707  
 BKT Larkeisa T310 JC  
 Beckton Legend U331 E2  
 Beckton Minerva U313 NB  
 Beckton Julian G5 S107  
 Beckton Suffeina P643 JL  
 Beckton Julian U699 L5  
 Beckton Tamara S432 DM

BWt **56**  
 WR **98**  
 ADG **3.75**  
 YWt **1003**  
 YR **97**  
 Scr. **33**  
 Fr. **5.5**

**DAM**  
 Age 2  
 Wt 905  
 Prog.BW 58  
 WR 99  
 YR 101  
 Wean Pct. 50%  
 Cow Eff. 105

RAAA HerdBuilder index: **181** (Top 1% of all RA bulls)  
 RAAA GridMaster index: **53** (Top 1% of all RA bulls)  
 Calv.Ease BW WW YW Milk HPG Stay Maint.En.  
 EPDs **13.3 -4.9 54 89.9 19 9.5 14.5 -4.4**  
 Marb **+1.04** REA **+0.04** Bfat **+0.02**

★★★★★ for Low Maintenance, Marbling, Calving Ease, Stayability.



• Bulls •

**191 BECKTON WARRIOR C396 H6**   
 1-A 100% # 3487356 Tat.: BKT5 C396  
 Birth: 3-24-15

Beckton Warrior W534 N4	Beckton Warrior C1 S337	BWt	<b>55</b>
Beckton Susan W058 E	BKT Larkeisa S055 NB	WR	<b>81</b>
	Beckton Epic T330 L5	ADG	<b>4.03</b>
	Beckton Susan T048 NB	YWt.	<b>1009</b>
Beckton Hasten H S462	Beckton Hasten P292	YR	<b>90</b>
BKT Larkeisa U535 HS	Beckton Lakme G128 HD	Scr.	<b>35</b>
	Beckton Hasten P292	Fr.	<b>5.0</b>
	BKT Larkeisa J800 LN		

**DAM**  
 Age 7  
 Wt 1280  
 Prog.BW 68  
 WR 102  
 YR 101  
 Wean Pct. 37%  
 Cow Eff. 79

RAAA HerdBuilder index: **155** (Top 6% of all RA bulls)  
 RAAA GridMaster index: **52** (Top 6% of all RA bulls)  
 Calv.Ease BW WW YW Milk HPG Stay Maint.En.  
 EPDs **17.4 -8.4 36.1 65.1 29 10.8 13 -5.2**  
 Marb **+.55** REA **+.14** Bfat **+.02**



★★★★★ for Low Maintenance, Gainability, Marbling, Rib-eye area, Calving Ease, Stayability.

**192 BECKTON JULIAN C608 N6**   
 1-A 100% # 3487715 Tat.: BSF5 C608  
 Birth: 4-4-15

Beckton Julian G5 S107	Beckton Julian GJ P535	BWt	<b>64</b>
Beckton Minola P826 DM	Beckton Minola P826 DM	WR	<b>100</b>
Beckton Julian GG B571	Beckton Julian GG B571	ADG	<b>2.56</b>
Bkt Suffeina A828 DM	Bkt Suffeina A828 DM	YWt.	<b>1030</b>
Beckton Nebula G S237	Beckton Nebula G S237	YR	<b>94</b>
Beckton Lana R058 EP	Beckton Lana R058 EP	Scr.	<b>33</b>
Beckton Lancer T371 H4	Beckton Lancer T371 H4	Fr.	<b>5.5</b>
Beckton Minola X223 L	Beckton Minola R678 JE		

**DAM**  
 Age 3  
 Wt 955  
 Prog.BW 60  
 WR 94  
 YR 88  
 Wean Pct. 56%  
 Cow Eff. 117

RAAA HerdBuilder index: **147** (Top 9% of all RA bulls)  
 RAAA GridMaster index: **52** (Top 4% of all RA bulls)  
 Calv.Ease BW WW YW Milk HPG Stay Maint.En.  
 EPDs **12.8 -5.0 48.3 80.9 15 12.5 12.7 -5.0**  
 Marb **+.88** REA **-.07** Bfat **+.01**

★★★★★ for Low Maintenance, Marbling, High Cow Efficiency, Calving Ease.

**194 BECKTON WARRIOR C656 N6**   
 1-A 100% # 3487573 Tat.: BKT5 C656  
 Birth: 4-8-15

Beckton Warrior W534 N4	Beckton Warrior C1 S337	BWt	<b>57</b>
BKT Larkeisa S055 NB	BKT Larkeisa S055 NB	WR	<b>94</b>
Beckton Epic T330 L5	Beckton Epic T330 L5	ADG	<b>3.35</b>
Beckton Susan T048 NB	Beckton Susan T048 NB	YWt.	<b>1085</b>
Beckton Nebula M045	Beckton Nebula M045	YR	<b>97</b>
Beckton Lana M809 EP	Beckton Lana M809 EP	Scr.	<b>35</b>
Beckton Epic K3 M606	Beckton Epic K3 M606	Fr.	<b>5.0</b>
Beckton Belga K202 LN	Beckton Belga K202 LN		

**DAM**  
 Age 4  
 Wt 1050  
 Prog.BW 60  
 WR 99  
 YR 97  
 Wean Pct. 51%  
 Cow Eff. 108

RAAA HerdBuilder index: **175** (Top 1% of all RA bulls)  
 RAAA GridMaster index: **53** (Top 2% of all RA bulls)  
 Calv.Ease BW WW YW Milk HPG Stay Maint.En.  
 EPDs **17.8 -8.8 41.1 77.5 27 13 14.9 -2.6**  
 Marb **+.65** REA **+.01** Bfat **+.05**

★★★★★ for Low Maintenance, Marbling, Calving Ease, Stayability.

**193 BECKTON JULIAN C175 L7**   
 1-A 100% # 3487450 Tat.: BKT5 C175  
 Birth: 3-10-15

Beckton Julian X465 J5	Beckton Julian G5 S107	BWt	<b>57</b>
Beckton Suffeina P643 JL	Beckton Suffeina P643 JL	WR	<b>96</b>
Beckton Eola X216 L	Beckton Likable U120 L2	ADG	<b>3.18</b>
	Beckton Eola U027 NB	YWt.	<b>947</b>
Beckton Likable U120 L2	Beckton Likable S633	YR	<b>92</b>
Beckton Lana S718 LN	Beckton Lana S718 LN	Scr.	<b>34</b>
Beckton Jules L429	Beckton Jules L429	Fr.	<b>5.5</b>
Beckton Susan L258 LR	Beckton Susan L258 LR		

**DAM**  
 Age 2  
 Wt 775  
 Prog.BW 57  
 WR 96  
 YR 92  
 Wean Pct. 57%  
 Cow Eff. 120

RAAA HerdBuilder index: **158** (Top 4% of all RA bulls)  
 RAAA GridMaster index: **51** (Top 18% of all RA bulls)  
 Calv.Ease BW WW YW Milk HPG Stay Maint.En.  
 EPDs **12.7 -6.2 37.2 60.2 28 11.4 15.4 -7.6**  
 Marb **+.63** REA **+.17** Bfat **+.02**

★★★★★ for Low Maintenance, Marbling, Rib-eye area, High Cow Efficiency, Calving Ease, Stayability.

**195 BSF ACCENT C632 N4**   
 1-B 99% # 3487708 Tat.: BSF5 C632  
 Birth: 4-5-15

Beckton Accent U777 C2	Beckton Cody K1 P014	BWt	<b>62</b>
Beckton Susan R022 CQ	Beckton Susan R022 CQ	WR	<b>94</b>
BKT Larkeisa S055 NB	Beckton Nebula P P707	ADG	<b>3.47</b>
	Beckton Larkeisa P688 CH	YWt.	<b>1090</b>
Beckton Nebula W130 D3	Beckton Nebula T269 E2	YR	<b>99</b>
Beckton Firefly T006 DM	Beckton Firefly T006 DM	Scr.	<b>34</b>
Beckton Warrior C1 S337	Beckton Warrior C1 S337	Fr.	<b>5.0</b>
BSF Epiquette U398 WR	BSF Epiquette S632 EP		

**DAM**  
 Age 3  
 Wt 940  
 Prog.BW 66  
 WR 101  
 YR 104  
 Wean Pct. 53%  
 Cow Eff. 112

RAAA HerdBuilder index: **145** (Top 10% of all RA bulls)  
 RAAA GridMaster index: **51** (Top 14% of all RA bulls)  
 Calv.Ease BW WW YW Milk HPG Stay Maint.En.  
 EPDs **12.5 -4.8 51.1 90.1 19 11.7 13.1 -1.1**  
 Marb **+.44** REA **+.41** Bfat **+.08**

★★★★★ for Low Maintenance, Marbling, Rib-eye area, Calving Ease, Stayability.

• Bulls •

**196** **BECKTON EPIC C122 W8** 

1-A 100% # 3487923 Tat.: BSF5 C122

Birth: 3-4-15

Beckton Epic U749 D5  
Beckton Lydia S069 NB  
Beckton Epic U749 D5  
Beckton Larkaba U475 CT  
Beckton Warrior C1 S337  
BKT Larkeisa S055 NB  
Beckton Loki CL S284  
Beckton Tara R609 JC

**BECKTON EPIC A286 E7**  
Ref. E-6  
Beckton Epic Y484 N6  
Beckton Larkaba Y648 E

**BECKTON TARA A845 W**  
Beckton Warrior W534 N4  
Beckton Tara W482 L

DAM	
Age	2
Wt	850
Prog.BW	53
WR	90
YR	100
Wean Pct.	48%
Cow Eff.	101

RAAA HerdBuilder index: **182** (Top 1% of all RA bulls)  
RAAA GridMaster index: **53** (Top 1% of all RA bulls)

Calv.Ease	BW	WW	YW	Milk	HPG	Stay	Maint.En.	
EPDs	16.8	-7.6	43.4	80.9	23	9	15.9	-4.5
Marb	+0.74		REA	+0.18		Bfat		+0.04

**198** **BECKTON ACCENT C232 E3** 

1-A 100% # 3487390 Tat.: BKT5 C232

Birth: 3-16-15

Beckton Cody K1 P014  
Beckton Rose M126 WR  
Beckton Cherokee N N479  
Beckton Christy N740 HR  
Beckton Epic KM M115  
Beckton Minerva F495 CH  
Beckton Justice C K449  
Beckton Barmaid G565 LN

**BECKTON ACCENT W180 C2**  
Ref. A-1  
Beckton Christy R046 CQ

**BECKTON BARMAID T193 EP**  
Beckton Barmaid N258 JC

DAM	
Age	8
Wt	1310
Prog.BW	69
WR	101
YR	103
Wean Pct.	34%
Cow Eff.	72

RAAA HerdBuilder index: **145** (Top 9% of all RA bulls)  
RAAA GridMaster index: **52** (Top 6% of all RA bulls)

Calv.Ease	BW	WW	YW	Milk	HPG	Stay	Maint.En.	
EPDs	14.5	-6.0	59.3	96.7	25	13.1	11.9	0.9
Marb	+0.55		REA	+0.02		Bfat		+0.02

★★★★★ for Low Maintenance, Marbling, Rib-eye area, Calving Ease, Stayability.

★★★★★ for Low Maintenance, Marbling, Calving Ease.

**197** **BECKTON HERITAGE C091 J4** 

1-A 100% # 3487484 Tat.: BKT5 C091

Birth: 2-27-15

Beckton Heritage X356 E2  
Beckton Heritage N013  
Beckton Lana S489 EP  
BKT Clifftop TP R288  
Beckton Rose W816 C  
Beckton Rose S487 LN  
Beckton Julian GJ P535  
Beckton Minola P826 DM  
Beckton Julian G3 P608  
Beckton Ruth S871 WR

**BECKTON HERITAGE A767 C3**  
Ref. H-2  
Beckton Rose W816 C

**BECKTON RUTH A586 J**  
Beckton Julian G5 S107  
Beckton Ruth W488 J

DAM	
Age	2
Wt	880
Prog.BW	60
WR	97
YR	98
Wean Pct.	51%
Cow Eff.	106

RAAA HerdBuilder index: **148** (Top 8% of all RA bulls)  
RAAA GridMaster index: **51** (Top 11% of all RA bulls)

Calv.Ease	BW	WW	YW	Milk	HPG	Stay	Maint.En.	
EPDs	13	-4.9	42.9	75.7	20	14.8	12.8	-4.6
Marb	+0.82		REA	-0.02		Bfat		+0.08

★★★★★ for Low Maintenance, Marbling, Calving Ease.

**199** **BECKTON NEW ERA C433 N2** 

1-A 100% # 3487862 Tat.: BSF5 C433

Birth: 3-26-15

Beckton Nebula P P707  
Beckton Nebula M045  
Beckton Lana M809 EP  
Beckton Justice C1 R483  
BKT Larkeisa T310 JC  
BKT Larkeisa R775 JC  
Beckton Nebula M045  
Beckton Lana M621 LN  
Beckton Warrior CL M686  
Beckton Coca K480 CO

**BECKTON NEW ERA Y194**  
Ref. N-4  
BKT Larkeisa T310 JC

**BECKTON COCA T080 NB**  
Beckton Nebula N R573  
Beckton Coca R375 WR

DAM	
Age	8
Wt	1115
Prog.BW	58
WR	92
YR	96
Wean Pct.	41%
Cow Eff.	86

RAAA HerdBuilder index: **170** (Top 2% of all RA bulls)  
RAAA GridMaster index: **51** (Top 15% of all RA bulls)

Calv.Ease	BW	WW	YW	Milk	HPG	Stay	Maint.En.	
EPDs	16.5	-7.0	41.8	70.5	23	13.6	15.1	-6.3
Marb	+0.61		REA	-0.39		Bfat		+0.02

★★★★★ for Low Maintenance, Marbling, Calving Ease, Stayability.



**200** **BECKTON JANUS C618 N3** 

1-A 100% # 3487996 Tat.: BSF5 C618

Birth: 4-4-15

Beckton Roman J S158  
TR Romeo NT379  
Beckton Belga K285 JL  
Beckton Loki F251  
Beckton Sierra C157 CL  
Beckton Nebula T269 E2  
Beckton Ruth M967 EP  
Beckton Lancer T A664  
Beckton Christy N626 LN  
Beckton Christy K209 CO

**BECKTON JANUS X799 L2**  
Ref. J-3  
Beckton Sierra K557 LO

**BECKTON CHRISTY Z191 N**

DAM	
Age	3
Wt	970
Prog.BW	60
WR	98
YR	95
Wean Pct.	51%
Cow Eff.	108

RAAA HerdBuilder index: **156** (Top 5% of all RA bulls)  
RAAA GridMaster index: **50** (Top 24% of all RA bulls)

Calv.Ease	BW	WW	YW	Milk	HPG	Stay	Maint.En.	
EPDs	15.7	-7.0	37.1	64.2	29	10.8	14.4	1.9
Marb	+0.33		REA	+0.02		Bfat		+0.00

★★★★★ for Low Maintenance, Marbling, Calving Ease, Stayability.

• Bulls •

**201** **BSF HERITAGE C670 N4** 

1-B 99% # 3488038 Tat.: BSF5 C670

Birth: 4-9-15

Beckton Heritage X356 E2 < Beckton Heritage N013  
Beckton Lana S489 EP  
BKT Clifftop TP R288  
Beckton Rose W816 C < Beckton Rose S487 LN  
Beckton Nebula W065 C3  
Beckton Rose W402 N  
Beckton Epic U749 D5  
BSF Dominique Y289 E < BSF Dominique R653 DM

**BECKTON HERITAGE A767 C3**  
Ref. H-2

**BSF DOMINIQUE A005 N**

DAM	
Age	2
Wt	900
Prog.BW	65
WR	109
YR	105
Wean Pct.	59%
Cow Eff.	124

BWt	53
WR	113
ADG	3.30
YWt	1088
YR	105
Scr.	34
Fr.	5.0

RAAA HerdBuilder index: **178** (Top 1% of all RA bulls)  
RAAA GridMaster index: **53** (Top 2% of all RA bulls)

Calv.Ease	BW	WW	YW	Milk	HPG	Stay	Maint.En.	
EPDs	13.7	-5.9	54	88.2	21	8	15	-0.7

Marb **+0.98** REA **+0.09** Bfat **+0.06**

★★★★★ for Low Maintenance, Growth, Marbling, Superior Cow, High Cow Efficiency, Calving Ease, Stayability.

**204** **BECKTON SCAMP C022 J4** 

1-A 100% # 3487959 Tat.: BSF5 C022

Birth: 2-19-15

Beckton Scamp T A825 < Beckton Scamp 8954  
BKT Encino 8459 TJ  
Beckton Hilltop R157  
Beckton Rose R507 CT  
Beckton Julian GJ P535  
Beckton Minola P826 DM  
Beckton Julian G3 P608  
Beckton Larkaba U274 JL < Beckton Larkaba N708 HR

**BECKTON SCAMP A626 H3**  
Ref. S-3

**BECKTON LARKABA A491 J**

DAM	
Age	2
Wt	860
Prog.BW	55
WR	94
YR	95
Wean Pct.	50%
Cow Eff.	104

BWt	49
WR	93
ADG	3.07
YWt	954
YR	92
Scr.	35
Fr.	5.0

RAAA HerdBuilder index: **151** (Top 7% of all RA bulls)  
RAAA GridMaster index: **50** (Top 24% of all RA bulls)

Calv.Ease	BW	WW	YW	Milk	HPG	Stay	Maint.En.	
EPDs	16.1	-7.5	39.7	65.1	22	13	13	-5.6

Marb **+0.41** REA **-0.15** Bfat **+0.02**

★★★★★ for Low Maintenance, Marbling, Calving Ease, Stayability.

**202** **BECKTON SCAMP C519 N3** 

1-A 100% # 3487224 Tat.: BKT5 C519

Birth: 3-29-15

Beckton Scamp 8954 < Beckton Julian 7526G  
Bkt Kusi Annie 5462  
Beckton Trojan 7061P  
BCH Kit 7132-784  
Beckton Nebula P P707  
Beckton Minerva J615 VG  
Beckton Cherokee N N479  
Beckton Ruth T325 CQ < Beckton Ruth H105 LO

**BECKTON SCAMP T A825**  
Ref. S

**BECKTON RUTH Z762 N**

DAM	
Age	3
Wt	1185
Prog.BW	60
WR	89
YR	93
Wean Pct.	40%
Cow Eff.	83

BWt	65
WR	89
ADG	3.47
YWt	1025
YR	93
Scr.	35
Fr.	5.0

RAAA HerdBuilder index: **136** (Top 15% of all RA bulls)  
RAAA GridMaster index: **49** (Top 37% of all RA bulls)

Calv.Ease	BW	WW	YW	Milk	HPG	Stay	Maint.En.	
EPDs	14.8	-6.9	34.3	52.3	24	11.7	12.2	-12.0

Marb **+0.42** REA **+0.03** Bfat **+0.01**

★★★★★ for Low Maintenance, Marbling, Calving Ease.

**205** **BECKTON NEBULA C461 L4** 

1-A 100% # 3487909 Tat.: BSF5 C461

Birth: 3-24-15

Beckton Nebula E P084 < Beckton Nebula M045  
BKT Pine Marie M119 EP  
Beckton Nebula M045  
Beckton Eola M663 EP  
Beckton Lancer TL G626  
Beckton Angel G356 HR  
Beckton Lancer TS D390  
Beckton Lana F081 LN < Beckton Lana D550 CB

**BECKTON NEBULA EN S347**  
Ref. N-2

**BECKTON LANA M393 LN**

DAM	
Age	13
Wt	1175
Prog.BW	60
WR	105
YR	104
Wean Pct.	42%
Cow Eff.	88

BWt	50
WR	86
ADG	2.67
YWt	981
YR	88
Scr.	36
Fr.	5.0

RAAA HerdBuilder index: **149** (Top 7% of all RA bulls)  
RAAA GridMaster index: **50** (Top 22% of all RA bulls)

Calv.Ease	BW	WW	YW	Milk	HPG	Stay	Maint.En.	
EPDs	18.9	-9.4	27	43.3	37	13.4	12.1	-7.7

Marb **+0.60** REA **-0.34** Bfat **+0.01**

★★★★★ for Low Maintenance, Marbling, Superior Cow, Calving Ease.

**203** **BECKTON EMPEROR C601 A5** 

1-A 100% # 3487615 Tat.: BKT5 C601

Birth: 4-3-15

Beckton Emperor Y459 J3 < Beckton Emperor T641 E2  
Beckton Indigo S354 JT  
Beckton Warrior U636 J5  
Beckton Minola S103 JL  
Beckton Cody K1 P014  
Beckton Susan R022 CQ  
Beckton Lancer TZ D525  
Beckton Vernice G373 WR

**BECKTON EMPEROR A165 W4**  
Ref. E-5

**BECKTON VERNICE A176 A**

DAM	
Age	2
Wt	950
Prog.BW	49
WR	113
YR	103
Wean Pct.	56%
Cow Eff.	118

BWt	49
WR	113
ADG	3.18
YWt	1062
YR	103
Scr.	35
Fr.	5.5

RAAA HerdBuilder index: **163** (Top 3% of all RA bulls)  
RAAA GridMaster index: **52** (Top 5% of all RA bulls)

Calv.Ease	BW	WW	YW	Milk	HPG	Stay	Maint.En.	
EPDs	16.4	-7.6	50.8	81.3	20	11.1	14.1	-4.8

Marb **+0.57** REA **+0.12** Bfat **+0.00**

★★★★★ for Low Maintenance, Marbling, High Cow Efficiency, Calving Ease, Stayability.

**206** **BECKTON JULIAN C300 C7** 

1-A 100% # 3487442 Tat.: BKT5 C300

Birth: 3-20-15

Beckton Julian X465 J5 < Beckton Julian G5 S107  
Beckton Suffeina P643 JL  
Beckton Likable U120 L2  
Beckton Eola U027 NB  
BKT Clifftop TP R288  
Beckton Lydia S274 EP  
Beckton Hasten H S462  
Beckton Barmaid P864 JC

**BECKTON JULIAN A479 L6**  
Ref. J-5

**BECKTON BARMAID A904 C**

DAM	
Age	2
Wt	760
Prog.BW	64
WR	105
YR	99
Wean Pct.	64%
Cow Eff.	135

BWt	64
WR	105
ADG	2.61
YWt	1026
YR	99
Scr.	35
Fr.	5.0

RAAA HerdBuilder index: **165** (Top 3% of all RA bulls)  
RAAA GridMaster index: **51** (Top 19% of all RA bulls)

Calv.Ease	BW	WW	YW	Milk	HPG	Stay	Maint.En.	
EPDs	12.4	-5.0	48.1	78.9	24	10.5	15.8	-6.1

Marb **+0.50** REA **+0.22** Bfat **+0.04**

★★★★★ for Low Maintenance, Marbling, Rib-eye area, High Cow Efficiency, Calving Ease, Stayability.



• Bulls •



**209** **BECKTON SCAMP C750 C4** 

1-A 100% # Pending Tat.: BKT5 C750

Birth: 4-19-15

Beckton Scamp T A825  
 Beckton Scamp 8954  
 Bkt Encino 8459 TJ

**BECKTON SCAMP X494 E3**  
 Ref. S-2 Beckton Lana S074 EP  
 Beckton Epic KH P678  
 Beckton Lana P317 JL

BKT Clifftop TP R288  
 Beckton Clifftop T C075  
 Beckton Christy K209 CO

**BECKTON LARKABA U475 CT**  
 Beckton Larkaba R809 NB  
 Beckton Nebula M045  
 Beckton Larkaba M116 CE

BWT	58
WR	94
ADG	4.03
YWT	1126
YR	100
Scr.	38
Fr.	4.5

**DAM**

Age	7
Wt	1000
Prog. BW	54
WR	99
YR	100
Wean Pct.	56%
Cow Eff.	118

RAAA HerdBuilder index: (Top 8% of all RA bulls)  
 RAAA GridMaster index: (Top 28% of all RA bulls)

Calv. Ease	BW	WW	YW	Milk	HPG	Stay	Maint. En.	
EPDs	15	-7.9	38.5	63.5	27	12	14	-13.0
Marb	+0.44		REA	+0.06		Bfat		+0.02

★★★★★ for Low Maintenance, Gainability, Marbling, High Cow Efficiency, Calving Ease, Stayability.

**207** **BECKTON EPIC C205 E8** 

1-A 100% # 3487485 Tat.: BKT5 C205

Birth: 3-14-15

Beckton Epic X330 L6  
 Beckton Epic T330 L5  
 Beckton Kit R503 LN

**BECKTON EPIC A587 N7**  
 Ref. E-7 Beckton Lana W113 N  
 Beckton Nebula T252 L3  
 Beckton Lana T226 NB

Beckton Epic X330 L6  
 Beckton Epic T330 L5  
 Beckton Kit R503 LN

**BECKTON COCA A583 E**  
 Beckton Coca W823 N  
 Beckton Nebula G S237  
 Beckton Coca S043 EP

BWT	64
WR	90
ADG	3.86
YWT	1010
YR	98
Scr.	33
Fr.	5.0

**DAM**

Age	2
Wt	900
Prog. BW	64
WR	90
YR	98
Wean Pct.	46%
Cow Eff.	96

RAAA HerdBuilder index: 158 (Top 4% of all RA bulls)  
 RAAA GridMaster index: 51 (Top 11% of all RA bulls)

Calv. Ease	BW	WW	YW	Milk	HPG	Stay	Maint. En.	
EPDs	9.5	-3.3	52.3	91.4	18	8.5	15.4	-4.3
Marb	+0.55		REA	+0.20		Bfat		+0.02

★★★★★ for Low Maintenance, Marbling, Rib-eye area, Calving Ease, Stayability.

**210** **BECKTON WARRIOR C781 C6** 

1-A 100% # 3487882 Tat.: BSF5 C781

Birth: 4-24-15

Beckton Warrior W534 N4  
 Beckton Warrior C1 S337  
 BKT Larkeisa S055 NB

**BECKTON WARRIOR Y108 E5**  
 Ref. W-3 Beckton Susan W058 E  
 Beckton Epic T330 L5  
 Beckton Susan T048 NB

Beckton Cherokee N N479  
 BFCK Cherokee Cnyn 4912  
 Beckton Dinah C440 NM

**BECKTON MONA R198 CQ**  
 Beckton Mona N009 JE  
 Beckton Jules L429  
 Beckton Mona L618 LR

BWT	58
WR	97
ADG	3.86
YWT	1149
YR	103
Scr.	38
Fr.	5.0

**DAM**

Age	10
Wt	1160
Prog. BW	65
WR	104
YR	105
Wean Pct.	49%
Cow Eff.	104

RAAA HerdBuilder index: 159 (Top 4% of all RA bulls)  
 RAAA GridMaster index: 53 (Top 2% of all RA bulls)

Calv. Ease	BW	WW	YW	Milk	HPG	Stay	Maint. En.	
EPDs	17.3	-8.8	43.5	78.8	31	14	13.1	-2.3
Marb	+0.65		REA	+0.12		Bfat		+0.04

★★★★★ for Low Maintenance, Marbling, Superior Cow, Calving Ease, Stayability.

**208** **BECKTON ACCENT C708 N4** 

1-A 100% # 3487338 Tat.: BKT5 C708

Birth: 4-14-15

Beckton Accent U777 C2  
 Beckton Cody K1 P014  
 Beckton Susan R022 CQ

**BECKTON ACCENT Y312 N3**  
 Ref. A-3 BKT Larkeisa S055 NB  
 Beckton Nebula P P707  
 Beckton Larkeisa P688 CH

Beckton Nebula T269 E2  
 Beckton Nebula M045  
 Beckton Ruth M967 EP

**BECKTON COCA W061 N**  
 Beckton Coca T168 NB  
 Beckton Nebula M045  
 Beckton Coca H256 JL

BWT	68
WR	103
ADG	3.86
YWT	1136
YR	101
Scr.	34
Fr.	4.5

**DAM**

Age	6
Wt	1065
Prog. BW	67
WR	101
YR	103
Wean Pct.	57%
Cow Eff.	120

RAAA HerdBuilder index: 190 (Top 1% of all RA bulls)  
 RAAA GridMaster index: 51 (Top 9% of all RA bulls)

Calv. Ease	BW	WW	YW	Milk	HPG	Stay	Maint. En.	
EPDs	15.4	-6.5	47.6	82.3	22	14.2	17.1	-7.9
Marb	+0.62		REA	-0.05		Bfat		+0.06

★★★★★ for Low Maintenance, Marbling, High Cow Efficiency, Calving Ease, Stayability.

**211** **BECKTON JANUS C724 N3** 

1-A 100% # 3487253 Tat.: BKT5 C724

Birth: 4-17-15

Beckton Roman J S158  
 TR Romeo NT379  
 Beckton Belga K285 JL

**BECKTON JANUS X799 L2**  
 Ref. J-3 Beckton Sierra K557 LO  
 Beckton Loki F251  
 Beckton Sierra C157 CL

Beckton Nebula T269 E2  
 Beckton Nebula M045  
 Beckton Ruth M967 EP

**BECKTON LAKME Z405 N**  
 Beckton Lakme T692 EP  
 Beckton Epic KM M115  
 Beckton Lakme P513 EP

BWT	58
WR	99
ADG	3.75
YWT	1126
YR	102
Scr.	35
Fr.	5.5

**DAM**

Age	3
Wt	1100
Prog. BW	70
WR	106
YR	105
Wean Pct.	48%
Cow Eff.	101

RAAA HerdBuilder index: 157 (Top 5% of all RA bulls)  
 RAAA GridMaster index: 51 (Top 20% of all RA bulls)

Calv. Ease	BW	WW	YW	Milk	HPG	Stay	Maint. En.	
EPDs	14.1	-6.1	45.8	79.4	30	10.2	14.7	2.8
Marb	+0.33		REA	+0.03		Bfat		+0.02

★★★★★ for Low Maintenance, Marbling, Superior Cow, Calving Ease, Stayability.

• Bulls •



**214** **BSF EPIC C738 N8** 

1-A 99% # 3487979 Tat.: BSF5 C738

Birth: 4-18-15

Beckton Epic X330 L6  
Beckton Epic T330 L5  
Beckton Kit R503 LN

**BECKTON EPIC A587 N7**  
Ref. E-7  
Beckton Lana W113 N  
Beckton Nebula T252 L3  
Beckton Lana T226 NB

Beckton Nebula U060 N4  
Beckton Nebula PJ S543  
Beckton Birdie S110 NB

**BSF EPIQUETTE A356 N**  
BSF Epiquette W547 N  
Beckton Nebula PJ S543  
BSF Epiquette S433 EP

BWT	62
WR	106
ADG	3.69
YWT	1123
YR	109
Scr.	34
Fr.	6.0

RAAA HerdBuilder index: **165** (Top 3% of all RA bulls)  
RAAA GridMaster index: **52** (Top 5% of all RA bulls)

Calv.Ease	BW	WW	YW	Milk	HPG	Stay	Maint.En.	
EPDs	11.6	-3.8	61.6	104.5	14	7.5	15.4	-2.9
Marb	+0.57	REA	+0.13	Bfat	+0.01			

DAM  
Age 2  
Wt 835  
Prog.BW 62  
WR 106  
YR 109  
Wean Pct. 59%  
Cow Eff. 125

★★★★★ for Low Maintenance, Growth, Marbling, Rib-eye area, Superior Cow, High Cow Efficiency, Calving Ease, Stayability.

**212** **BSF ACCENT C765 C4** 

1-B 99% # 3487837 Tat.: BSF5 C765

Birth: 4-21-15

Beckton Accent U777 C2  
Beckton Cody K1 P014  
Beckton Susan R022 CQ

**BECKTON ACCENT Y312 N3**  
Ref. A-3  
BKT Larkeisa S055 NB  
Beckton Nebula P P707  
Beckton Larkeisa P688 CH

Beckton Cherokee N N479  
BFCK Cherokee Cnyn 4912

**BSF LANETTE U463 CQ**  
BSF Lanette R748 LN  
Beckton Dinah C440 NM  
Beckton Lancer T7 M089  
BSF Red Roan L823 LN

BWT	77
WR	108
ADG	2.56
YWT	1105
YR	99
Scr.	38
Fr.	5.5

RAAA HerdBuilder index: **152** (Top 6% of all RA bulls)  
RAAA GridMaster index: **50** (Top 26% of all RA bulls)

Calv.Ease	BW	WW	YW	Milk	HPG	Stay	Maint.En.	
EPDs	13	-5.1	50	76	26	13.9	14.6	-2.1
Marb	+0.56	REA	+0.18	Bfat	+0.05			

DAM  
Age 7  
Wt 1160  
Prog.BW 68  
WR 112  
YR 106  
Wean Pct. 55%  
Cow Eff. 116

★★★★★ for Low Maintenance, Marbling, Rib-eye area, Superior Cow, High Cow Efficiency, Calving Ease, Stayability.

**215** **BECKTON EPIC C786 W7** 

1-A 100% # 3487537 Tat.: BKT5 C786

Birth: 4-25-15

Beckton Epic U749 D5  
Beckton Epic K4 N795  
Beckton Denise R308 DM

**BECKTON EPIC Y484 N6**  
Ref. E-4  
Beckton Lydia S069 NB  
Beckton Nebula P P707  
Beckton Lydia P583 WR

Beckton Warrior X522 E6  
Beckton Warrior T248 L5  
Beckton Lana R205 EP

**BECKTON EOLA Z145 W**  
Beckton Eola X216 L  
Beckton Likable U120 L2  
Beckton Eola U027 NB

BWT	61
WR	100
ADG	3.52
YWT	1102
YR	100
Scr.	35
Fr.	5.0

RAAA HerdBuilder index: **152** (Top 7% of all RA bulls)  
RAAA GridMaster index: **52** (Top 4% of all RA bulls)

Calv.Ease	BW	WW	YW	Milk	HPG	Stay	Maint.En.	
EPDs	12.1	-5.6	48.9	85.4	19	13	13.4	-7.6
Marb	+0.73	REA	+0.00	Bfat	+0.03			

DAM  
Age 3  
Wt 900  
Prog.BW 59  
WR 102  
YR 105  
Wean Pct. 59%  
Cow Eff. 125

★★★★★ for Low Maintenance, Marbling, High Cow Efficiency, Calving Ease, Stayability.

**213** **BECKTON ACCENT C727 L4** 

1-A 100% # 3487594 Tat.: BKT5 C727

Birth: 4-17-15

Beckton Accent W180 C2  
Beckton Cody K1 P014  
Beckton Christy R046 CQ

**BECKTON ACCENT Y260 L3**  
Ref. A-2  
Beckton Lana W463 L  
Beckton Loki CL S284  
Beckton Lana R327 EP

Beckton Legend S670  
Beckton Lancer F442 T  
Beckton Kit F468 JL

**BECKTON ROSE X802 L**  
Beckton Rose R353 LN  
Beckton Lancer T7 M089  
Beckton Rose L083 LN

BWT	74
WR	94
ADG	3.18
YWT	1052
YR	93
Scr.	37
Fr.	5.0

RAAA HerdBuilder index: **159** (Top 4% of all RA bulls)  
RAAA GridMaster index: **51** (Top 20% of all RA bulls)

Calv.Ease	BW	WW	YW	Milk	HPG	Stay	Maint.En.	
EPDs	11.6	-4.5	50.5	73.9	21	11.5	15.6	-5.2
Marb	+0.63	REA	+0.19	Bfat	-0.01			

DAM  
Age 5  
Wt 1140  
Prog.BW 63  
WR 100  
YR 98  
Wean Pct. 51%  
Cow Eff. 107

★★★★★ for Low Maintenance, Marbling, Rib-eye area, Calving Ease, Stayability.

**216** **BECKTON WARRIOR C700 C6** 

1-A 100% # 3487393 Tat.: BKT5 C700

Birth: 4-14-15

Beckton Warrior W534 N4  
Beckton Warrior C1 S337  
BKT Larkeisa S055 NB

**BECKTON WARRIOR Y108 E5**  
Ref. W-3  
Beckton Susan W058 E  
Beckton Epic T330 L5  
Beckton Susan T048 NB

BKT Clifftop TP R288  
Beckton Clifftop T C075  
Beckton Christy K209 CO

**BECKTON LANA T104 CT**  
Beckton Lana R128 LS  
Beckton Laser N602  
Beckton Lana N378 LN

BWT	63
WR	104
ADG	2.61
YWT	1050
YR	94
Scr.	34
Fr.	5.0

RAAA HerdBuilder index: **164** (Top 3% of all RA bulls)  
RAAA GridMaster index: **51** (Top 17% of all RA bulls)

Calv.Ease	BW	WW	YW	Milk	HPG	Stay	Maint.En.	
EPDs	15.2	-7.2	44.1	70.8	27	12.6	15.1	-4.0
Marb	+0.40	REA	+0.19	Bfat	+0.02			

DAM  
Age 8  
Wt 1195  
Prog.BW 62  
WR 101  
YR 98  
Wean Pct. 52%  
Cow Eff. 109

★★★★★ for Low Maintenance, Marbling, Rib-eye area, Calving Ease, Stayability.

• Bulls •

**217** BECKTON ACCENT C783 N3  
1-A 100% # 3487729 Tat.: BSF5 C783 

Birth: 4-24-15

Beckton Cody K1 P014  
Beckton Rose M126 WR  
Beckton Cherokee N N479  
Beckton Christy R046 CQ  
Beckton Christy N740 HR  
Beckton Nebula T398 V3  
Beckton Firefly T003 JC  
Beckton Hasten H S462  
Beckton Dinah R328 JE

**BECKTON ACCENT W180 C2**  
Ref. A-1

**BECKTON DINAH Z016 N**

**DAM**  
Age 3  
Wt 965  
Prog.BW 60  
WR 96  
YR 99  
Wean Pct. 50%  
Cow Eff. 105

RAAA HerdBuilder index: **164** (Top 3% of all RA bulls)  
RAAA GridMaster index: **53** (Top 3% of all RA bulls)  
Calv.Ease BW WW YW Milk HPG Stay Maint.En.  
EPDs **16.2 -8.1 44.9 79.5 25 13.8 13.7 -2.8**  
Marb **+.54** REA **+.29** Bfat **+.03**

BWt **59**  
WR **91**  
ADG **3.98**  
YWt **1091**  
YR **99**  
Scr. **37**  
Fr. **6.0**

★★★★★ for Low Maintenance, Marbling, Rib-eye area, Calving Ease, Stayability.

**219** BECKTON ACCENT C734 L4  
1-A 100% # 3487539 Tat.: BKT5 C734 

Birth: 4-18-15

Beckton Accent U777 C2  
Beckton Susan R022 CQ  
Beckton Nebula P F707  
Beckton Larkeisa P688 CH  
Beckton Lancer T371 H4  
Beckton Minerva L324 LN  
Beckton Dominor Z1 R610  
Beckton Firefly T284 WA

**BECKTON ACCENT Y312 N3**  
Ref. A-3

**BECKTON FIREFLY Z112 L**

**DAM**  
Age 3  
Wt 970  
Prog.BW 63  
WR 111  
YR 102  
Wean Pct. 53%  
Cow Eff. 111

RAAA HerdBuilder index: **166** (Top 3% of all RA bulls)  
RAAA GridMaster index: **52** (Top 9% of all RA bulls)  
Calv.Ease BW WW YW Milk HPG Stay Maint.En.  
EPDs **16.5 -8.0 40.9 70.4 28 12 14.2 -2.5**  
Marb **+.50** REA **+.10** Bfat **+.03**

BWt **65**  
WR **96**  
ADG **3.41**  
YWt **1067**  
YR **97**  
Scr. **33**  
Fr. **5.5**

★★★★★ for Low Maintenance, Marbling, Calving Ease, Stayability.

**218** BECKTON EPIC C749 L8  
1-A 100% # 3487449 Tat.: BKT5 C749 

Birth: 4-19-15

Beckton Epic X330 L6  
Beckton Kit R503 LN  
Beckton Nebula T252 L3  
Beckton Lana T226 NB  
Beckton Likable S633  
Beckton Lana S718 LN  
Beckton Dominor Z1 R610  
Beckton Vernice R374 LN

**BECKTON EPIC A587 N7**  
Ref. E-7

**BECKTON VERNICE A848 L**

**DAM**  
Age 2  
Wt 855  
Prog.BW 61  
WR 99  
YR 102  
Wean Pct. 59%  
Cow Eff. 123

RAAA HerdBuilder index: **135** (Top 16% of all RA bulls)  
RAAA GridMaster index: **51** (Top 13% of all RA bulls)  
Calv.Ease BW WW YW Milk HPG Stay Maint.En.  
EPDs **10 -3.7 50.2 83.4 22 9.2 13.5 -2.8**  
Marb **+.70** REA **+.09** Bfat **+.03**

BWt **61**  
WR **99**  
ADG **4.15**  
YWt **1104**  
YR **102**  
Scr. **32**  
Fr. **5.5**

★★★★★ for Low Maintenance, Gainability, Marbling, High Cow Efficiency, Calving Ease, Stayability.

**220** BECKTON CLIFFTOP C716 R5  
1-A 100% # 3487653 Tat.: BSF5 C716 

Birth: 4-15-15

Beckton Clifftop W692 E3  
BKT Clifftop TP R288  
Beckton Lydia S274 EP  
Beckton Clifftop TP R288  
Beckton Lana L923 CD  
TR Romeo NT379  
Beckton Belga K285 JL  
Beckton Julian G2 M345  
Beckton Christy C306 JL

**BECKTON CLIFFTOP Y012 C4**  
Ref. C-2

**BECKTON CHRISTY U702 RA**

**DAM**  
Age 7  
Wt 1270  
Prog.BW 72  
WR 105  
YR 103  
Wean Pct. 43%  
Cow Eff. 90

RAAA HerdBuilder index: **161** (Top 4% of all RA bulls)  
RAAA GridMaster index: **50** (Top 33% of all RA bulls)  
Calv.Ease BW WW YW Milk HPG Stay Maint.En.  
EPDs **13.8 -5.2 40.6 66.2 29 12.4 15.4 -1.3**  
Marb **+.35** REA **+.19** Bfat **+.00**

BWt **67**  
WR **92**  
ADG **3.01**  
YWt **1020**  
YR **91**  
Scr. **NA**  
Fr. **5.5**

★★★★★ for Low Maintenance, Marbling, Rib-eye area, Superior Cow, Calving Ease, Stayability.



**221** BECKTON JET C725 J2  
1-A 100% # 3487530 Tat.: BKT5 C725 

Birth: 4-17-15

TR Julian Lt151  
Beckton Julian GG B571  
MS GEOMETRIC 917  
Beckton Lancer TS D390  
Beckton Minerva F495 CH  
Beckton Julian 7526G  
Bkt Marta 9A13 JL  
Beckton Dominor ZC M919  
BKT Larkeisa M816 EP

**BECKTON JET L P491**  
Ref. J

**BECKTON LARKEISA Z238 J**

**DAM**  
Age 3  
Wt 1045  
Prog.BW 58  
WR 97  
YR 97  
Wean Pct. 47%  
Cow Eff. 99

RAAA HerdBuilder index: **165** (Top 3% of all RA bulls)  
RAAA GridMaster index: **52** (Top 4% of all RA bulls)  
Calv.Ease BW WW YW Milk HPG Stay Maint.En.  
EPDs **18.8 -7.7 37.1 60.9 25 8.9 13.7 -5.1**  
Marb **+.83** REA **+.13** Bfat **+.01**

BWt **58**  
WR **97**  
ADG **3.35**  
YWt **1035**  
YR **97**  
Scr. **35**  
Fr. **5.5**

★★★★★ for Low Maintenance, Marbling, Rib-eye area, Calving Ease, Stayability.



• Bulls •



Lot 222

<b>224</b>	<b>BECKTON JANUS C534 E3</b>							
	1-A 100% # 3487431 Tat.: BKT5 C534							
Birth: 3-30-15								
Beckton Roman J S158		TR Romeo NT379						
<b>BECKTON JANUS X799 L2</b>		Beckton Belga K285 JL						
Ref. J-3		Beckton Loki F251						
Beckton Sierra K557 LO		Beckton Sierra C157 CL						
Beckton Epic K1 K863		Beckton Epic KN H110						
<b>BECKTON LANA M809 EP</b>		Beckton Rose H019 SC						
Beckton Lana K253 DM		Beckton Dominor ZJ H657						
Beckton Lana HA34 DM		Beckton Lana HA34 DM						
<b>DAM</b>								
Age	13							
Wt	1030							
Prog. BW	73							
WR	105							
YR	104							
Wean Pct.	52%							
Cow Eff.	110							
RAAA HerdBuilder index: <b>124</b> (Top 25% of all RA bulls)								
RAAA GridMaster index: <b>49</b> (Top 47% of all RA bulls)								
Calv. Ease BW WW YW Milk HPG Stay Maint. En.								
EPDs	15.9	-6.2	27.5	40	35	9.2	11.5	2.1
Marb <b>+0.53</b> REA <b>-0.21</b> Bfat <b>-0.03</b>								

★★★★★ for Low Maintenance, Marbling, Superior Cow, Calving Ease.

<b>222</b>	<b>BECKTON WARRIOR C241 J5</b>							
	1-A 100% # 3487871 Tat.: BSF5 C241							
Birth: 3-17-15								
Beckton Warrior C1 S337		Beckton Warrior CL M686						
<b>BECKTON WARRIOR W534 N4</b>		Beckton Christy K101 CD						
Ref. W-2		Beckton Nebula P P707						
BKT Larkeisa S055 NB		Beckton Larkeisa P688 CH						
Beckton Jet L P491		TR Julian LT151						
<b>BECKTON ENCINO S059 JT</b>		Beckton Minerva L278 LN						
Beckton Encino P871 HR		Beckton Herald FV J537						
Beckton Encino G341 NP		Beckton Encino G341 NP						
<b>DAM</b>								
Age	9							
Wt	1175							
Prog. BW	65							
WR	102							
YR	95							
Wean Pct.	45%							
Cow Eff.	95							
RAAA HerdBuilder index: <b>152</b> (Top 7% of all RA bulls)								
RAAA GridMaster index: <b>50</b> (Top 21% of all RA bulls)								
Calv. Ease BW WW YW Milk HPG Stay Maint. En.								
EPDs	19	-9.0	24.9	31.5	29	12.7	12.7	-5.7
Marb <b>+0.84</b> REA <b>+0.00</b> Bfat <b>+0.02</b>								

★★★★★ for Low Maintenance, Marbling, Calving Ease.

<b>225</b>	<b>BSF NEW ERA C690 D2</b>							
	1-B 98% # 3487878 Tat.: BSF5 C690							
Birth: 4-12-15								
Beckton Nebula P P707		Beckton Nebula M045						
<b>BECKTON NEW ERA Y194</b>		Beckton Lana M809 EP						
Ref. N-4		Beckton Justice C1 R483						
BKT Larkeisa T310 JC		BKT Larkeisa R775 JC						
Beckton Dominor ZC M919		Beckton Dominor Z E401						
<b>BSF DOMINIQUE R653 DM</b>		Beckton Barmaid J012 CO						
BSF Regus L683 CT		Beckton Clifftop T C075						
BSF Regus F712		BSF Regus F712						
<b>DAM</b>								
Age	10							
Wt	1340							
Prog. BW	66							
WR	107							
YR	104							
Wean Pct.	44%							
Cow Eff.	93							
RAAA HerdBuilder index: <b>166</b> (Top 3% of all RA bulls)								
RAAA GridMaster index: <b>50</b> (Top 26% of all RA bulls)								
Calv. Ease BW WW YW Milk HPG Stay Maint. En.								
EPDs	14.4	-4.9	50	78.5	24	12.9	15.7	0.6
Marb <b>+0.54</b> REA <b>-0.30</b> Bfat <b>+0.00</b>								

★★★★★ for Low Maintenance, Marbling, Superior Cow, Calving Ease, Stayability.

<b>223</b>	<b>BECKTON JULIAN C354 E7</b>							
	1-A 100% # 3488017 Tat.: BSF5 C354							
Birth: 3-23-15								
Beckton Julian X465 J5		Beckton Julian G5 S107						
<b>BECKTON JULIAN A479 L6</b>		Beckton Suffeina P643 JL						
Ref. J-5		Beckton Likable U120 L2						
Beckton Eola X216 L		Beckton Eola U027 NB						
Beckton Epic Y484 N6		Beckton Epic U749 D5						
<b>BECKTON CHRISTY A163 E</b>		Beckton Lydia S069 NB						
Beckton Christy Y364 N		Beckton Nebula T269 E2						
Beckton Christy S151 NB		Beckton Christy S151 NB						
<b>DAM</b>								
Age	2							
Wt	810							
Prog. BW	57							
WR	109							
YR	102							
Wean Pct.	63%							
Cow Eff.	132							
RAAA HerdBuilder index: <b>182</b> (Top 1% of all RA bulls)								
RAAA GridMaster index: <b>51</b> (Top 15% of all RA bulls)								
Calv. Ease BW WW YW Milk HPG Stay Maint. En.								
EPDs	13.5	-5.9	49	77.9	23	9.5	17.6	-6.6
Marb <b>+0.55</b> REA <b>+0.13</b> Bfat <b>+0.03</b>								

★★★★★ for Low Maintenance, Marbling, Rib-eye area, High Cow Efficiency, Calving Ease, Stayability.

<b>226</b>	<b>BECKTON SCAMP C095 N4</b>							
	1-A 100% # 3487964 Tat.: BSF5 C095							
Birth: 2-27-15								
Beckton Scamp T A825		Beckton Scamp 8954						
<b>BECKTON SCAMP A626 H3</b>		BKT Encino 8459 TJ						
Ref. S-3		Beckton Hilltop R157						
Beckton Rose T770 HI		Beckton Rose R507 CT						
Beckton Nebula Y036 N4		Beckton Nebula W065 C3						
<b>BECKTON MINERVA A470 N</b>		Beckton Rose W402 N						
Beckton Minerva Y520 J		Beckton Julian U742 W5						
Beckton Minerva U586 CT		Beckton Minerva U586 CT						
<b>DAM</b>								
Age	2							
Wt	800							
Prog. BW	59							
WR	100							
YR	96							
Wean Pct.	58%							
Cow Eff.	122							
RAAA HerdBuilder index: <b>158</b> (Top 5% of all RA bulls)								
RAAA GridMaster index: <b>50</b> (Top 31% of all RA bulls)								
Calv. Ease BW WW YW Milk HPG Stay Maint. En.								
EPDs	12.6	-5.4	41	61.8	22	10.9	15.8	-5.2
Marb <b>+0.42</b> REA <b>+0.18</b> Bfat <b>-0.02</b>								

★★★★★ for Low Maintenance, Marbling, Rib-eye area, High Cow Efficiency, Calving Ease, Stayability.

• Bulls •

**227** **BECKTON JULIAN C116 W5**   
 1-A 100% # 3488015 Tat.: BSF5 C116  
 Birth: 3-3-15

Beckton Julian GG B571  
**BECKTON JULIAN A565 J4** Ref. J-6  
 Beckton Belga X379 L

Beckton Julian 7526G  
 Bkt Marta 9A13 JL  
 Bkt Javelin 7466 R  
 Beckton Belga S587 DM  
 Beckton Warrior C1 S337  
 BKT Larkeisa S055 NB  
 Beckton Nebula L P093  
 Beckton Encino H115 HD

BWt **53**  
 WR **100**  
 ADG **3.05**  
 YWt. **992**  
 YR **96**  
 Scr. **34**  
 Fr. **4.5**

**BECKTON ENCINO A199 W**  
 Beckton Warrior W534 N4  
 Beckton Encino U181 NB

**DAM**  
 Age 2  
 Wt 930  
 Prog.BW 53  
 WR 100  
 YR 96  
 Wean Pct. 50%  
 Cow Eff. 105

RAAA HerdBuilder index: **174** (Top 2% of all RA bulls)  
 RAAA GridMaster index: **51** (Top 12% of all RA bulls)  
 Calv.Ease BW WW YW Milk HPG Stay Maint.En.  
 EPDs **17.5 -7.6 36.9 55.3 23 13.5 15 -4.7**  
 Marb **+0.81** REA **+0.04** Bfat **+0.03**

★★★★★ for Low Maintenance, Marbling, Calving Ease, Stayability.

**230** **BECKTON NEW ERA C132 N3**   
 1-A 100% # 3487508 Tat.: BKT5 C132  
 Birth: 3-5-15

Beckton New Era Y194  
**BECKTON NEW ERA A395 L2** Ref. N-5  
 Beckton Minerva X612 L

Beckton Nebula P P707  
 BKT Larkeisa T310 JC  
 Beckton Legend U331 E2  
 Beckton Minerva U313 NB  
 Beckton Nebula P P707  
 BKT Larkeisa T310 JC  
 BKT Clifftop T2 J059  
 Beckton Tamara J201 CH

BWt **60**  
 WR **102**  
 ADG **3.28**  
 YWt. **984**  
 YR **95**  
 Scr. **32**  
 Fr. **5.0**

**BECKTON TAMARA A428 N**  
 Beckton New Era Y194  
 Beckton Tamara L132 CT

**DAM**  
 Age 2  
 Wt 850  
 Prog.BW 67  
 WR 100  
 YR 98  
 Wean Pct. 56%  
 Cow Eff. 118

RAAA HerdBuilder index: **169** (Top 2% of all RA bulls)  
 RAAA GridMaster index: **50** (Top 31% of all RA bulls)  
 Calv.Ease BW WW YW Milk HPG Stay Maint.En.  
 EPDs **13.4 -4.9 48.1 71.9 24 13.1 16.6 -2.5**  
 Marb **+0.55** REA **-1.10** Bfat **+0.01**

★★★★★ for Low Maintenance, Marbling, High Cow Efficiency, Calving Ease, Stayability.

**228** **BECKTON SCAMP C327 N5**   
 1-A 100% # 3487989 Tat.: BSF5 C327  
 Birth: 3-22-15

Beckton Scamp X494 E3  
**BECKTON SCAMP A627 J4** Ref. S-4  
 Beckton Serena R023 JC

Beckton Scamp T A825  
 Beckton Lana S074 EP  
 Beckton Justice Cc N265  
 Beckton Serena N469 JC  
 Beckton Nebula M045  
 Beckton Lana M809 EP  
 Beckton Accent U777 C2  
 Beckton Angel U746 CD

BWt **58**  
 WR **101**  
 ADG **3.51**  
 YWt. **1031**  
 YR **95**  
 Scr. **34**  
 Fr. **5.5**

**BECKTON ANGEL A295 N**  
 Beckton Nebula P P707  
 Beckton Angel X011 A

**DAM**  
 Age 2  
 Wt 855  
 Prog.BW 58  
 WR 101  
 YR 95  
 Wean Pct. 60%  
 Cow Eff. 126

RAAA HerdBuilder index: **156** (Top 5% of all RA bulls)  
 RAAA GridMaster index: **51** (Top 10% of all RA bulls)  
 Calv.Ease BW WW YW Milk HPG Stay Maint.En.  
 EPDs **15.8 -7.1 38.5 61.5 23 13.3 13.4 -4.0**  
 Marb **+0.81** REA **-1.18** Bfat **+0.01**

★★★★★ for Low Maintenance, Marbling, High Cow Efficiency, Calving Ease, Stayability.

**231** **BECKTON CLIFFTOP C427 E4**   
 1-A 100% # 3487195 Tat.: BKT5 C427  
 Birth: 3-26-15

BKT Clifftop TP R288  
**BECKTON CLIFFTOP W692 E3** Ref. C-1  
 Beckton Lydia S274 EP

Beckton Clifftop T C075  
 Beckton Christy K209 CO  
 Beckton Epic KM M115  
 Beckton Lydia M607 LO  
 Beckton Epic K4 N795  
 Beckton Belga K202 LN  
 Beckton Justice CH M056  
 Beckton Minerva K370 CO

BWt **55**  
 WR **90**  
 ADG **2.99**  
 YWt. **978**  
 YR **87**  
 Scr. **33**  
 Fr. **4.5**

**BECKTON MINERVA W662 E**  
 Beckton Epic T330 L5  
 Beckton Minerva T318 JC

**DAM**  
 Age 6  
 Wt 1145  
 Prog.BW 66  
 WR 104  
 YR 102  
 Wean Pct. 47%  
 Cow Eff. 98

RAAA HerdBuilder index: **143** (Top 11% of all RA bulls)  
 RAAA GridMaster index: **51** (Top 15% of all RA bulls)  
 Calv.Ease BW WW YW Milk HPG Stay Maint.En.  
 EPDs **15.7 -8.0 30.9 53.1 32 11.7 12.7 -1.2**  
 Marb **+0.72** REA **-0.43** Bfat **+0.01**

★★★★★ for Low Maintenance, Marbling, Calving Ease.

**229** **BECKTON HERITAGE C691 N4**   
 1-A 100% # 3487808 Tat.: BSF5 C691  
 Birth: 4-12-15

Beckton Heritage T270 J2  
**BECKTON HERITAGE X403 L3** Ref. H-1  
 Beckton Indigo H150 LN

Beckton Heritage N013  
 Beckton Coca P602 JL  
 Beckton Lancer TE F363  
 Beckton Indigo F376 CT  
 Beckton Nebula M045  
 Beckton Marta M021 LN  
 Beckton Heritage N013  
 Beckton Indigo D780 JL

BWt **82**  
 WR **94**  
 ADG **3.10**  
 YWt. **1025**  
 YR **91**  
 Scr. **34**  
 Fr. **4.5**

**BECKTON INDIGO W626 N**  
 Beckton Nebula L P093  
 Beckton Indigo T832 HT

**DAM**  
 Age 6  
 Wt 1250  
 Prog.BW 82  
 WR 103  
 YR 99  
 Wean Pct. 45%  
 Cow Eff. 94

RAAA HerdBuilder index: **122** (Top 27% of all RA bulls)  
 RAAA GridMaster index: **47** (Top 79% of all RA bulls)  
 Calv.Ease BW WW YW Milk HPG Stay Maint.En.  
 EPDs **9.2 -2.3 50.4 67.2 18 13.6 12.2 .0**  
 Marb **+0.52** REA **-1.19** Bfat **+0.03**

★★★★★ for Low Maintenance, Marbling, Calving Ease.



Lot 229

• Bulls •

**232** **BECKTON EPIC C661 C7** 

1-A 100% # 3487436 Tat.: BKT5 C661

Birth: 4-8-15

Beckton Epic T330 L5  
**BECKTON EPIC X330 L6**  
 Ref. E-1 Beckton Kit R503 LN

Beckton Epic K4 N795  
 Beckton Belga K202 LN  
 Beckton Lancer F442 T  
 Beckton Kit F468 JL

BWt **63**  
 WR **115**  
 ADG **2.87**  
 YWt. **1044**  
 YR **102**  
 Scr. **34**  
 Fr. **5.0**

Beckton Copper JT G095  
**BECKTON COCA K480 CO**  
 Beckton Coca C178 VG

Beckton Copper J E616  
 Beckton Ruth E549 TP  
 Beckton Vegas 9433  
 Beckton Coca 8372 TJ

**DAM**  
 Age 15  
 Wt 1220  
 Prog.BW 64  
 WR 100  
 YR 99  
 Wean Pct. 42%  
 Cow Eff. 89

RAAA HerdBuilder index: **169** (Top 2% of all RA bulls)  
 RAAA GridMaster index: **50** (Top 25% of all RA bulls)  
 Calv.Ease BW WW YW Milk HPG Stay Maint.En.  
 EPDs **16.1 -8.0 35.3 56 27 12.6 15.8 -6.8**  
 Marb **+0.59** REA **-0.17** Bfat **+0.05**

★★★★★ for Low Maintenance, Marbling, Calving Ease, Stayability.

**235** **BSF JULIAN C161 J7** 

1-B 99% # 3487956 Tat.: BSF5 C161

Birth: 3-8-15

Beckton Julian X465 J5  
**BECKTON JULIAN A479 L6**  
 Ref. J-5 Beckton Eola X216 L

Beckton Julian G5 S107  
 Beckton Suffeina P643 JL  
 Beckton Likable U120 L2  
 Beckton Eola U027 NB

BWt **66**  
 WR **130**  
 ADG **3.56**  
 YWt. **1005**  
 YR **114**  
 Scr. **34**  
 Fr. **5.5**

Beckton Julian X465 J5  
**BSF LAUREL A524 J**  
 BSF Laurel X073 E

Beckton Julian G5 S107  
 Beckton Suffeina P643 JL  
 Beckton Epic U126 J5  
 BSF Laurel U629 WR

**DAM**  
 Age 2  
 Wt 950  
 Prog.BW 66  
 WR 130  
 YR 114  
 Wean Pct. 44%  
 Cow Eff. 93

RAAA HerdBuilder index: **156** (Top 5% of all RA bulls)  
 RAAA GridMaster index: **51** (Top 11% of all RA bulls)  
 Calv.Ease BW WW YW Milk HPG Stay Maint.En.  
 EPDs **10.2 -3.4 54.7 91.6 20 12 14.7 -6.0**  
 Marb **+0.70** REA **-0.03** Bfat **+0.03**

★★★★★ for Low Maintenance, Growth, Marbling, Superior Cow, Calving Ease, Stayability.

**233** **BECKTON DOMINOR C134 W8** 

1-A 100% # 3487446 Tat.: BKT5 C134

Birth: 3-5-15

Beckton Dominor Y005 V6  
**BECKTON DOMINOR A378 W7**  
 Ref. D-1 Beckton Lana Y541 W

Beckton Dominor W640 C5  
 Beckton Belga W108 V  
 Beckton Warrior T248 L5  
 Beckton Lana S074 EP

BWt **51**  
 WR **120**  
 ADG **2.82**  
 YWt. **995**  
 YR **105**  
 Scr. **32**  
 Fr. **5.5**

Beckton Warrior Y108 E5  
**BECKTON MINOLA A873 W**  
 Beckton Minola Y687 N

Beckton Warrior W534 N4  
 Beckton Susan W058 E  
 Beckton Nebula U206 V3  
 Beckton Minola R720 JJ

**DAM**  
 Age 2  
 Wt 996  
 Prog.BW 51  
 WR 120  
 YR 105  
 Wean Pct. 47%  
 Cow Eff. 99

RAAA HerdBuilder index: **181** (Top 1% of all RA bulls)  
 RAAA GridMaster index: **52** (Top 7% of all RA bulls)  
 Calv.Ease BW WW YW Milk HPG Stay Maint.En.  
 EPDs **15.6 -8.3 41.6 69.8 25 11.5 15.5 -3.5**  
 Marb **+0.50** REA **+0.16** Bfat **+0.01**

★★★★★ for Low Maintenance, Marbling, Rib-eye area, Superior Cow, Calving Ease, Stayability.



**234** **BECKTON LIKABLE C297 J3** 

1-A 100% # 3487844 Tat.: BSF5 C297

Birth: 3-20-15

Beckton Likable S633  
**BECKTON LIKABLE U130 L2**  
 Ref. L-1 Beckton Kit S478 LN

Beckton Lancer F442 T  
 Beckton Kit F468 JL  
 Beckton Lancer F442 T  
 Beckton Kit F468 JL

BWt **59**  
 WR **89**  
 ADG **2.64**  
 YWt. **934**  
 YR **83**  
 Scr. **36**  
 Fr. **5.0**

Beckton Julian G3 P608  
**BECKTON LARKABA U274 JL**  
 Beckton Larkaba N708 HR

Beckton Julian GG B571  
 Bkt Suffeina A828 DM  
 Beckton Herald FJ J776  
 Beckton Larkaba G311 CT

**DAM**  
 Age 7  
 Wt 1160  
 Prog.BW 60  
 WR 95  
 YR 93  
 Wean Pct. 46%  
 Cow Eff. 96

RAAA HerdBuilder index: **149** (Top 8% of all RA bulls)  
 RAAA GridMaster index: **51** (Top 14% of all RA bulls)  
 Calv.Ease BW WW YW Milk HPG Stay Maint.En.  
 EPDs **14.5 -7.2 37.2 56 19 12.1 13.3 -6.5**  
 Marb **+0.64** REA **+0.28** Bfat **+0.01**

★★★★★ for Low Maintenance, Marbling, Rib-eye area, Calving Ease, Stayability.

**236** **BECKTON SCAMP C192 W4** 

1-A 100% # 3488016 Tat.: BSF5 C192

Birth: 3-12-15

Beckton Scamp T A825  
**BECKTON SCAMP A626 H3**  
 Ref. S-3 Beckton Rose T770 HI

Beckton Scamp 8954  
 BKT Encino 8459 TJ  
 Beckton Hilltop R157  
 Beckton Rose R507 CT

BWt **52**  
 WR **104**  
 ADG **3.05**  
 YWt. **979**  
 YR **95**  
 Scr. **32**  
 Fr. **5.0**

Beckton Warrior Y108 E5  
**BECKTON LANA A191 W**  
 Beckton Lana Y033 W

Beckton Warrior W534 N4  
 Beckton Susan W058 E  
 Beckton Warrior W534 N4  
 Beckton Lana W370 E

**DAM**  
 Age 2  
 Wt 855  
 Prog.BW 52  
 WR 104  
 YR 95  
 Wean Pct. 56%  
 Cow Eff. 118

RAAA HerdBuilder index: **144** (Top 10% of all RA bulls)  
 RAAA GridMaster index: **50** (Top 34% of all RA bulls)  
 Calv.Ease BW WW YW Milk HPG Stay Maint.En.  
 EPDs **14.7 -7.0 40.2 59 25 10.4 13.7 -3.6**  
 Marb **+0.44** REA **-0.02** Bfat **+0.01**

★★★★★ for Low Maintenance, Marbling, High Cow Efficiency, Calving Ease, Stayability.



• Bulls •

**237** **BSF ACCENT C595 L4**  1-B 99% # 3487705 Tat.: BSF5 C595

Birth: 4-2-15

Beckton Accent W180 C2 < Beckton Cody K1 P014  
 Beckton Christy R046 CQ  
**BECKTON ACCENT Y260 L3** Ref. A-2 < Beckton Lana W463 L < Beckton Loki CL S284  
 < Beckton Lana R327 EP  
 < Beckton Lancer F442 T  
 < Beckton Coca F276 HV  
**BSF CODETTE Z490 L** < Beckton Lancer T371 H4  
 < Beckton Epitomy S250  
 < BSF Codette U667 EY < BSF Codette S177 CD

DAM	
Age	3
Wt	1155
Prog.BW	55
WR	92
YR	99
Wean Pct.	36%
Cow Eff.	76

RAAA HerdBuilder index: **147** (Top 8% of all RA bulls)  
 RAAA GridMaster index: **50** (Top 27% of all RA bulls)  
 Calv.Ease BW WW YW Milk HPG Stay Maint.En.  
 EPDs **11.6 -3.3 58.6 90.1 19 10.2 14.5 1.1**  
 Marb **+4.7** REA **-0.1** Bfat **-0.1**

BWt	48
WR	89
ADG	3.52
YWt	1003
YR	93
Scr.	35
Fr.	5.5

★★★★★ for Low Maintenance, Marbling, Calving Ease, Stayability.

**240** **BECKTON ACCENT C649 A5**  1-A 100% # 3487638 Tat.: BKT5 C649

Birth: 4-7-15

Beckton Accent Y260 L3 < Beckton Accent W180 C2  
 Beckton Lana W463 L  
**BECKTON ACCENT A110 E4** Ref. A-5 < Beckton Emcee W271 L2  
 < Beckton Ruth W488 J  
 < Beckton Accent W180 C2  
 < Beckton Lana W463 L  
**BECKTON TAMARA A008 A** < Beckton Accent W180 C2  
 < Beckton Tamara Y001 A < Beckton Tamara W550 A

DAM	
Age	2
Wt	NA
Prog.BW	69
WR	106
YR	103
Wean Pct.	NA%
Cow Eff.	NA

RAAA HerdBuilder index: **169** (Top 2% of all RA bulls)  
 RAAA GridMaster index: **50** (Top 22% of all RA bulls)  
 Calv.Ease BW WW YW Milk HPG Stay Maint.En.  
 EPDs **10.8 -3.2 62.5 95.1 23 9.8 16 -3.3**  
 Marb **+4.9** REA **+0.3** Bfat **+0.0**

BWt	69
WR	106
ADG	3.75
YWt	1061
YR	103
Scr.	34
Fr.	5.0

★★★★★ for Low Maintenance, Marbling, Calving Ease, Stayability.

**238** **BECKTON NOMAD C452 J4**  1-A 100% # 3487879 Tat.: BSF5 C452

Birth: 3-27-15

Beckton Nomad 7496 < Beckton Neva 5562  
 Bkt Bolt Tamrck 3913  
**BECKTON NOMAD T 9A14** Ref. V-2 < Beckton Trojan 5253  
 < Bkt Signal Lana 5599  
 < Beckton Justice C K449  
 < Beckton Ruth K802 HD  
**BECKTON TARA R609 JC** < Beckton Julian GG B571  
 < Beckton Tara J266 HR

DAM	
Age	10
Wt	1320
Prog.BW	63
WR	93
YR	104
Wean Pct.	37%
Cow Eff.	77

RAAA HerdBuilder index: **136** (Top 15% of all RA bulls)  
 RAAA GridMaster index: **50** (Top 26% of all RA bulls)  
 Calv.Ease BW WW YW Milk HPG Stay Maint.En.  
 EPDs **18 -7.7 25.9 42 20 14.2 10.2 -8.4**  
 Marb **+6.0** REA **-2.6** Bfat **-0.2**

BWt	63
WR	81
ADG	3.52
YWt	988
YR	88
Scr.	34
Fr.	4.0

★★★★★ for Low Maintenance, Marbling, Calving Ease.

**241** **BSF EMPEROR C334 D5**  1-B 99% # 3487184 Tat.: BKB5 C334

Birth: 3-22-15

Beckton Emperor Y459 J3 < Beckton Emperor T641 E2  
 Beckton Indigo S354 JT  
**BECKTON EMPEROR A165 W4** Ref. E-5 < Beckton Warrior U636 J5  
 < Beckton Minola S103 JL  
 < Beckton Dominor Z1 R610  
 < Beckton Mona R166 CQ  
**BSF CLIFFTANA A301 D** < Beckton Nebula T269 E2  
 < BSF Cliftana W104 N < BSF Cliftana T257 CT

DAM	
Age	2
Wt	1035
Prog.BW	66
WR	97
YR	99
Wean Pct.	43%
Cow Eff.	90

RAAA HerdBuilder index: **166** (Top 3% of all RA bulls)  
 RAAA GridMaster index: **52** (Top 7% of all RA bulls)  
 Calv.Ease BW WW YW Milk HPG Stay Maint.En.  
 EPDs **14.3 -5.3 48 78.7 19 9.5 15.1 -0.6**  
 Marb **+7.6** REA **-0.6** Bfat **+0.0**

BWt	66
WR	97
ADG	3.47
YWt	1022
YR	99
Scr.	33
Fr.	5.0

★★★★★ for Low Maintenance, Marbling, Calving Ease, Stayability.

**239** **BSF WARRIOR C635 A5**  1-B 99% # Pending Tat.: BKB5 C635

Birth: 4-6-15

Beckton Warrior C1 S337 < Beckton Warrior CL M686  
 Beckton Christy K101 CD  
**BECKTON WARRIOR W534 N4** Ref. W-2 < Beckton Nebula P P707  
 < Beckton Larkeisa P688 CH  
 < Beckton Cody K1 P014  
 < Beckton Christy R046 CQ  
**BSF HUSTELLE Z692 A** < Beckton Cherokee N N479  
 < BSF Hustle P246

DAM	
Age	3
Wt	1005
Prog.BW	60
WR	99
YR	103
Wean Pct.	50%
Cow Eff.	105

RAAA HerdBuilder index: (Top 2% of all RA bulls)  
 RAAA GridMaster index: (Top 6% of all RA bulls)  
 Calv.Ease BW WW YW Milk HPG Stay Maint.En.  
 EPDs **13.3 -5.0 42.3 69 23.8 12.8 14.8 -5.5**  
 Marb **+5.0** REA **+2.7** Bfat **+0.5**

BWt	65
WR	98
ADG	3.07
YWt	1013
YR	95
Scr.	36
Fr.	5.5

★★★★★ for Low Maintenance, Marbling, Rib-eye area, Calving Ease, Stayability.



• Bulls •

**242** **BSF ACCENT C548 C5**  99% # un-reg Tat.: BSF5 C548

Birth: 3-30-15

Beckton Accent Y260 L3 < Beckton Accent W180 C2  
Beckton Lana W463 L

**BECKTON ACCENT A110 E4** < Beckton Emcoe W271 L2  
Ref. A-5 < Beckton Ruth W488 J

Beckton Clifftop Y012 C4 < Beckton Clifftop W692 E3  
Beckton Lana W240 C

**BSF CLIFFTANA A171 C** < Beckton Cherokee T450 L3  
BSF Cliffana Y477 C < BSF Cliffana S379 CT

DAM	
Age	2
Wt	845
Prog.BW	64
WR	99
YR	98
Wean Pct.	54%
Cow Eff.	113

RAAA HerdBuilder index: (Top 3% of all RA bulls)  
RAAA GridMaster index: (Top 6% of all RA bulls)

Calv.Ease	BW	WW	YW	Milk	HPG	Stay	Maint.En.	
EPDs	9.9	-3.3	54.7	89.7	20.4	10.4	15.7	-1.8
Marb	+0.38	REA	+1.19	Bfat	+0.03			

BWt **64**  
WR **99**  
ADG **3.41**  
Ywt. **1012**  
YR **98**  
Scr. **35**  
Fr. **5.0**

★★★★★ for Low Maintenance, Marbling, Rib-eye area, Calving Ease, Stayability.

**245** **BSF ACCENT C642 J4**  1-B 99% # 3487752 Tat.: BSF5 C642

Birth: 4-7-15

Beckton Accent U777 C2 < Beckton Cody K1 P014  
Beckton Susan R022 CQ

**BECKTON ACCENT Y312 N3** < Beckton Nebula P P707  
Ref. A-3 < BKT Larkeisa S055 NB < Beckton Larkeisa P688 CH

Beckton Julian W743 H5 < Beckton Julian G5 S107  
Beckton Kit L399 HR

**BSF LANETTE Y054 J** < Beckton Nebula H R233  
BSF Lanette W106 N < BSF Lanette P615

DAM	
Age	4
Wt	1100
Prog.BW	58
WR	97
YR	95
Wean Pct.	37%
Cow Eff.	77

RAAA HerdBuilder index: **179** (Top 1% of all RA bulls)  
RAAA GridMaster index: **51** (Top 10% of all RA bulls)

Calv.Ease	BW	WW	YW	Milk	HPG	Stay	Maint.En.	
EPDs	16.3	-6.9	41.7	67.2	24	14.6	15.8	-3.7
Marb	+0.79	REA	-0.08	Bfat	+0.05			

BWt **66**  
WR **91**  
ADG **3.13**  
Ywt. **992**  
YR **97**  
Scr. **32**  
Fr. **5.0**

★★★★★ for Low Maintenance, Marbling, Calving Ease, Stayability.

**243** **BECKTON CLIFFTOP C566 A5**  1-A 100% # 3487700 Tat.: BSF5 C566

Birth: 3-31-15

Beckton Clifftop W692 E3 < BKT Clifftop TP R288  
Beckton Lydia S274 EP

**BECKTON CLIFFTOP Y012 C4** < BKT Clifftop TP R288  
Ref. C-2 < Beckton Lana W240 C

Beckton Lana L923 CD

Beckton Accent U777 C2 < Beckton Cody K1 P014  
Beckton Susan R022 CQ

**BECKTON LANA Z605 A** < Beckton Jet L P491  
Beckton Lana W314 J < Beckton Lana S866 CH

DAM	
Age	3
Wt	1085
Prog.BW	61
WR	94
YR	90
Wean Pct.	45%
Cow Eff.	94

RAAA HerdBuilder index: **184** (Top 1% of all RA bulls)  
RAAA GridMaster index: **50** (Top 30% of all RA bulls)

Calv.Ease	BW	WW	YW	Milk	HPG	Stay	Maint.En.	
EPDs	15.2	-7.1	33.1	55.7	30	11.7	17.8	-5.7
Marb	+0.38	REA	+1.12	Bfat	+0.02			

BWt **60**  
WR **92**  
ADG **2.67**  
Ywt. **993**  
YR **90**  
Scr. **33**  
Fr. **5.0**

★★★★★ for Low Maintenance, Marbling, Calving Ease, Stayability.

**246** **BECKTON LIKABLE C202 N4**  1-A 100% # 3487988 Tat.: BSF5 C202

Birth: 3-14-15

Beckton Likable U120 L2 < Beckton Likable S633  
Beckton Lana S718 LN

**BECKTON LIKABLE A306 L3** < Beckton Loki F251  
Ref. L-4 < Beckton Lana D232 HV

Beckton Nebula J R475 < Beckton Nebula M045

**BECKTON BELGA A304 N** < Beckton Larkeisa M138 JC  
Beckton Belga W213 J < Beckton Julian GG B571  
Beckton Belga S587 DM

DAM	
Age	2
Wt	805
Prog.BW	58
WR	92
YR	92
Wean Pct.	58%
Cow Eff.	123

RAAA HerdBuilder index: **164** (Top 3% of all RA bulls)  
RAAA GridMaster index: **51** (Top 12% of all RA bulls)

Calv.Ease	BW	WW	YW	Milk	HPG	Stay	Maint.En.	
EPDs	14.6	-6.0	38.9	67.2	24	10	15.1	-8.5
Marb	+0.61	REA	+0.24	Bfat	+0.03			

BWt **57**  
WR **102**  
ADG **3.07**  
Ywt. **968**  
YR **94**  
Scr. **35**  
Fr. **5.0**

★★★★★ for Low Maintenance, Marbling, Rib-eye area, High Cow Efficiency, Calving Ease, Stayability.

**244** **BECKTON ACCENT C143 W5**  1-A 100% # 3487926 Tat.: BSF5 C143

Birth: 3-6-15

Beckton Accent Y260 L3 < Beckton Accent W180 C2  
Beckton Lana W463 L

**BECKTON ACCENT A110 E4** < Beckton Emcoe W271 L2  
Ref. A-5 < Beckton Ruth W488 J

Beckton Warrior W534 N4 < Beckton Warrior C1 S337  
BKT Larkeisa S055 NB

**BECKTON BARMAID A828 W** < Beckton Nebula G S237  
Beckton Barmaid X232 N < Beckton Barmaid P323 HR

DAM	
Age	2
Wt	NA
Prog.BW	78
WR	106
YR	104
Wean Pct.	NA%
Cow Eff.	NA

RAAA HerdBuilder index: **166** (Top 3% of all RA bulls)  
RAAA GridMaster index: **51** (Top 14% of all RA bulls)

Calv.Ease	BW	WW	YW	Milk	HPG	Stay	Maint.En.	
EPDs	13.7	-5.5	49.2	77.1	24	10.8	15.4	-5.5
Marb	+0.67	REA	-0.03	Bfat	+0.02			

BWt **57**  
WR **105**  
ADG **3.30**  
Ywt. **997**  
YR **105**  
Scr. **35**  
Fr. **5.0**

★★★★★ for Low Maintenance, Growth, Marbling, Superior Cow, Calving Ease, Stayability.

**247** **BECKTON ACCENT C522 C4**  1-A 100% # 3487698 Tat.: BSF5 C522

Birth: 3-29-15

Beckton Accent U777 C2 < Beckton Cody K1 P014  
Beckton Susan R022 CQ

**BECKTON ACCENT Y312 N3** < Beckton Nebula P P707  
Ref. A-3 < BKT Larkeisa S055 NB < Beckton Larkeisa P688 CH

Beckton Clifftop W577 E3 < BKT Clifftop TP R288  
BKT Pine Marie R213 EP

**BECKTON DINAH Z659 C** < Beckton Hustler C G407  
Beckton Dinah K287 HU < Beckton Dinah G334 CT

DAM	
Age	3
Wt	1100
Prog.BW	54
WR	92
YR	99
Wean Pct.	39%
Cow Eff.	82

RAAA HerdBuilder index: **171** (Top 2% of all RA bulls)  
RAAA GridMaster index: **53** (Top 3% of all RA bulls)

Calv.Ease	BW	WW	YW	Milk	HPG	Stay	Maint.En.	
EPDs	17.4	-8.4	31.6	60.5	28	13.4	14.7	-4.2
Marb	+0.84	REA	-0.04	Bfat	+0.05			

BWt **53**  
WR **82**  
ADG **3.64**  
Ywt. **1022**  
YR **93**  
Scr. **35**  
Fr. **4.5**

★★★★★ for Low Maintenance, Marbling, Calving Ease, Stayability.

• Bulls •

**248** **BECKTON EPIC C589 E8** 

1-A 100% # 3487528 Tat.: BKT5 C589

Birth: 4-2-15

Beckton Epic Y484 N6  
**BECKTON EPIC A286 E7**  
 Ref. E-6 Beckton Larkaba Y648 E

Beckton Epic U749 D5  
 Beckton Lydia S069 NB  
 Beckton Epic U749 D5  
 Beckton Larkaba U475 CT

Beckton Epic Y484 N6  
**BECKTON MINERVA A244 E**  
 Beckton Minerva Y385 N

Beckton Epic U749 D5  
 Beckton Lydia S069 NB  
 Beckton Nebula T398 V3  
 Beckton Minerva U310 LO

BWT **51**  
 WR **101**  
 ADG **3.13**  
 YWt. **1011**  
 YR **98**  
 Scr. **36**  
 Fr. **5.5**

**DAM**  
 Age 2  
 Wt 925  
 Prog.BW 51  
 WR 101  
 YR 98  
 Wean Pct. 51%  
 Cow Eff. 106

RAAA HerdBuilder index: **184** (Top 1% of all RA bulls)  
 RAAA GridMaster index: **53** (Top 4% of all RA bulls)  
 Calv.Ease BW WW YW Milk HPG Stay Maint.En.  
 EPDs **15.8 -7.8 49.6 83.8 22 8.5 16 -3.2**  
 Marb **+0.54** REA **+0.32** Bfat **+0.04**

★★★★★ for Low Maintenance, Marbling, Rib-eye area, Calving Ease, Stayability.



Lot 249

**250** **BKT LIKABLE C436 4** 

1-B 99% # 3487258 Tat.: BKT5 C436

Birth: 3-26-15

Beckton Likable U130 L2  
**BECKTON LIKABLE Y362 L3**  
 Ref. L-3 Beckton Tamara M515 LN

Beckton Likable S633  
 Beckton Kit S478 LN  
 Beckton Lancer TA K644  
 Beckton Tamara K322 LN

Red Angus multiple sire  
**BECKTON REGINA Z350 M**  
 Beckton Mona W045 H

Red Angus multiple sire  
 Red Angus dam  
 Beckton Heritage T270 J2  
 Beckton Mona T150 JC

BWT **61**  
 WR **83**  
 ADG **3.69**  
 YWt. **960**  
 YR **87**  
 Scr. **37**  
 Fr. **5.0**

**DAM**  
 Age 3  
 Wt 915  
 Prog.BW 61  
 WR 95  
 YR 94  
 Wean Pct. 48%  
 Cow Eff. 101

RAAA HerdBuilder index: **116** (Top 34% of all RA bulls)  
 RAAA GridMaster index: **51** (Top 12% of all RA bulls)  
 Calv.Ease BW WW YW Milk HPG Stay Maint.En.  
 EPDs **13.4 -5.4 36.1 59.7 21 10.7 9.8 -6.1**  
 Marb **+0.65** REA **+0.24** Bfat **-0.03**

★★★★★ for Low Maintenance, Marbling, Rib-eye area, Calving Ease.



Lot 250

**249** **BECKTON HERITAGE C177 L4** 

1-A 100% # 3487509 Tat.: BKT5 C177

Birth: 3-11-15

Beckton Heritage X356 E2  
**BECKTON HERITAGE A767 C3**  
 Ref. H-2 Beckton Rose W816 C

Beckton Heritage N013  
 Beckton Lana S489 EP  
 BKT Clifftop TP R288  
 Beckton Rose S487 LN

Beckton Legend S670  
**BECKTON FREYJA A425 L**  
 Beckton Freyja U464 JC

Beckton Lancer F442 T  
 Beckton Kit F468 JL  
 Beckton Justice C1 R483  
 Beckton Freyja M659 WR

BWT **56**  
 WR **88**  
 ADG **3.35**  
 YWt. **982**  
 YR **95**  
 Scr. **31**  
 Fr. **5.0**

**DAM**  
 Age 2  
 Wt 920  
 Prog.BW 57  
 WR 97  
 YR 96  
 Wean Pct. 43%  
 Cow Eff. 91

RAAA HerdBuilder index: **151** (Top 7% of all RA bulls)  
 RAAA GridMaster index: **51** (Top 10% of all RA bulls)  
 Calv.Ease BW WW YW Milk HPG Stay Maint.En.  
 EPDs **11.7 -4.9 44.2 73 19 13.1 13.8 -7.3**  
 Marb **+0.78** REA **+0.24** Bfat **+0.04**

★★★★★ for Low Maintenance, Marbling, Rib-eye area, Calving Ease, Stayability.

**251** **BECKTON HERITAGE C685 C4** 

1-A 100% # 3487234 Tat.: BKT5 C685

Birth: 4-11-15

Beckton Heritage T270 J2  
**BECKTON HERITAGE X403 L3**  
 Ref. H-1 Beckton Indigo H150 LN

Beckton Heritage N013  
 Beckton Coca P602 JL  
 Beckton Lancer TE F363  
 Beckton Indigo F376 CT

Beckton Clifftop W577 E3  
**BECKTON INDIGO Z628 C**  
 Beckton Indigo W477 E

BKT Clifftop TP R288  
 BKT Pine Marie R213 EP  
 Beckton Emcee S466  
 Beckton Indigo P043 LO

BWT **60**  
 WR **104**  
 ADG **3.01**  
 YWt. **1037**  
 YR **94**  
 Scr. **34**  
 Fr. **5.5**

**DAM**  
 Age 3  
 Wt 1055  
 Prog.BW 64  
 WR 103  
 YR 95  
 Wean Pct. 53%  
 Cow Eff. 111

RAAA HerdBuilder index: **150** (Top 7% of all RA bulls)  
 RAAA GridMaster index: **50** (Top 31% of all RA bulls)  
 Calv.Ease BW WW YW Milk HPG Stay Maint.En.  
 EPDs **13.8 -6.0 47.3 66.7 24 11.3 14.2 -3.5**  
 Marb **+0.79** REA **-0.15** Bfat **+0.08**

★★★★★ for Low Maintenance, Marbling, Calving Ease, Stayability.



# The Yearling Heifers

Heifer pregnancy  
and loss warranty

**OPTIONAL  
WARRANTY**

See page 2 for  
more details.

## Special Offer

Beckton is offering two straws of P707 semen or any other sire (for which we have adequate supply) to go with every heifer purchased. The buyer will only be responsible for shipping from Billings, MT and semen may be used on any animal the buyer would like.



Beckton females are nearly ideal for today's industry – moderately sized, efficient producers. They combine calving ease, growth, and desirable carcass traits. They are feminine, maternal and quiet, with nice udders and sound feet. All of our heifer calves trailed up with their mothers into the Bighorn Mountains to spend their first summer. They have learned the meaning of mothering ability. And they have the productive capacity to produce the bulls that you see in our sale. The sale heifers are a select group from the top of our replacements.

If you wish, we can also keep any sale heifers through the summer and breed them in natural service to the same herd sires we use with our own replacements. There will be a charge of \$250 per heifer plus delivery at cost in the fall. Visit with Cam about this program.



Sammy Hamilton and her Champion FFA Futurity Heifer donated by Beckton

• Heifers •

**301** **BKT BAYBERRY C404 J**  
1-A 100% # 3487881 Tattoo: BSF5 C404

Birth: 3-24-15	Beckton Julian 7526G	Beckton Julian 6592	
	Bkt Marta 9A13 JL	Bkt Belga 6746 GS	BWt <b>67</b>
<b>BECKTON JULIAN GG B571</b>		Beckton Julian 7526G	WR <b>103</b>
Ref. J-1	Bkt Marta 9A13 JL	Bkt Marta 6498 XM	YR <b>109</b>
	Beckton Hustler C2 L079	Beckton Hustler CN J102	Fr. <b>4.5</b>
<b>BKT BAYBERRY R322 HU</b>		Beckton Barmaid J012 CO	
	Bkt Bayberry LC31 SC	Beckton Scamp TR FB22	
		Bkt Bayberry D736 GL	

<b>DAM</b>	RAAA HerdBuilder index: <b>135</b> (Top 15% of all RA bulls)									
Age <b>10</b>	RAAA GridMaster index: <b>50</b> (Top 30% of all RA bulls)									
Wt <b>1172</b>	Calv.Ease	BW	WW	YW	Milk	HPG	Stay	Maint.En.		
Prog.BW <b>70</b>	EPDs <b>15</b>	<b>-4.5</b>	<b>55</b>	<b>85</b>	<b>21</b>	<b>10</b>	<b>11</b>	<b>-4.1</b>		
WR <b>107</b>	Marb <b>+0.45</b>		REA <b>+0.10</b>		Bfat <b>-0.01</b>					
YR <b>110</b>										
Cow Eff. <b>90</b>										

★★★★★ for Low Maintenance, Growth, Marbling, Superior Cow, Calving Ease.

**303** **BKT PINE MARIE C277 N**  
1-A 100% # 3487864 Tattoo: BSF5 C277

Birth: 3-19-15	Beckton Nebula M045	Beckton Neptune R2 K065	
	Beckton Lana M809 EP	Beckton Belga K285 JL	BWt <b>62</b>
<b>BECKTON NEBULA P P707</b>		Beckton Epic K1 K863	WR <b>102</b>
Ref. N-1	Beckton Lana M809 EP	Beckton Lana K253 DM	YR <b>105</b>
	Beckton Lasso P741	Beckton Lancer T1 H080	Fr. <b>5.0</b>
<b>BKT PINE MARIE S802 LO</b>		Beckton Ruth G534 NP	
	BKT Pine Marie P475 LN	Beckton Lancer T4 J536	
		Bkt Pine Marie LC30 CD	

<b>DAM</b>	RAAA HerdBuilder index: <b>170</b> (Top 2% of all RA bulls)									
Age <b>9</b>	RAAA GridMaster index: <b>53</b> (Top 1% of all RA bulls)									
Wt <b>1184</b>	Calv.Ease	BW	WW	YW	Milk	HPG	Stay	Maint.En.		
Prog.BW <b>68</b>	EPDs <b>15</b>	<b>-6.7</b>	<b>46</b>	<b>86</b>	<b>26</b>	<b>14</b>	<b>13</b>	<b>-0.7</b>		
WR <b>104</b>	Marb <b>+0.84</b>		REA <b>-0.32</b>		Bfat <b>+0.00</b>					
YR <b>106</b>										
Cow Eff. <b>88</b>										

★★★★★ for Low Maintenance, Growth, Marbling, Superior Cow, Calving Ease.



**304** **BECKTON RUTH C285 H**  
1-A 100% # 3487364 Tattoo: BKT5 C285

Birth: 3-19-15	Beckton Heritage T270 J2	Beckton Heritage N013	
	Beckton Indigo H150 LN	Beckton Coca P602 JL	BWt <b>71</b>
<b>BECKTON HERITAGE X403 L3</b>		Beckton Lancer TE F363	WR <b>120</b>
Ref. H-1	Beckton Indigo H150 LN	Beckton Indigo F376 CT	YR <b>110</b>
	Beckton Warrior N645 T1	Beckton Rose H074 EP	Fr. <b>4.0</b>
<b>BECKTON RUTH U325 WR</b>		Beckton Neptune R2 K065	
	Beckton Ruth M047 NP	Beckton Ruth K464 JL	

<b>DAM</b>	RAAA HerdBuilder index: <b>136</b> (Top 14% of all RA bulls)									
Age <b>7</b>	RAAA GridMaster index: <b>49</b> (Top 38% of all RA bulls)									
Wt <b>1156</b>	Calv.Ease	BW	WW	YW	Milk	HPG	Stay	Maint.En.		
Prog.BW <b>72</b>	EPDs <b>10</b>	<b>-3.0</b>	<b>64</b>	<b>86</b>	<b>19</b>	<b>16</b>	<b>10</b>	<b>.0</b>		
WR <b>111</b>	Marb <b>+0.66</b>		REA <b>-0.08</b>		Bfat <b>+0.04</b>					
YR <b>104</b>										
Cow Eff. <b>99</b>										

★★★★★ for Low Maintenance, Growth, Marbling, Superior Cow, Calving Ease.

**302** **BECKTON COCA C368 N**  
1-A 100% # 3487305 Tattoo: BKT5 C368

Birth: 3-23-15	Beckton Nebula P P707	Beckton Nebula M045	
	BKT Larkeisa T310 JC	Beckton Lana M809 EP	BWt <b>63</b>
<b>BECKTON NEW ERA Y194</b>		Beckton Justice C1 R483	WR <b>110</b>
Ref. N-4	BKT Larkeisa T310 JC	BKT Larkeisa R775 JC	YR <b>106</b>
	Beckton Nebula G S237	Beckton Nebula M045	Fr. <b>5.0</b>
<b>BECKTON COCA W823 N</b>		Beckton Lakme LA06 JL	
	Beckton Coca S043 EP	Beckton Epic KH P678	
		Beckton Coca P328 EP	

<b>DAM</b>	RAAA HerdBuilder index: <b>198</b> (Top 1% of all RA bulls)									
Age <b>6</b>	RAAA GridMaster index: <b>52</b> (Top 4% of all RA bulls)									
Wt <b>1270</b>	Calv.Ease	BW	WW	YW	Milk	HPG	Stay	Maint.En.		
Prog.BW <b>64</b>	EPDs <b>14</b>	<b>-5.4</b>	<b>60</b>	<b>98</b>	<b>21</b>	<b>14</b>	<b>13</b>	<b>-2.1</b>		
WR <b>98</b>	Marb <b>+0.66</b>		REA <b>-0.24</b>		Bfat <b>+0.02</b>					
YR <b>105</b>										
Cow Eff. <b>89</b>										

★★★★★ for Low Maintenance, Growth, Marbling, Calving Ease, Stayability.

**305** **BECKTON RUTH C502 H**  
1-A 100% # 3487354 Tattoo: BKT5 C502

Birth: 3-29-15	Beckton Heritage T270 J2	Beckton Heritage N013	
	Beckton Indigo H150 LN	Beckton Coca P602 JL	BWt <b>85</b>
<b>BECKTON HERITAGE X403 L3</b>		Beckton Lancer TE F363	WR <b>116</b>
Ref. H-1	Beckton Indigo H150 LN	Beckton Indigo F376 CT	YR <b>116</b>
	Beckton Jet L P491	TR Julian LT151	Fr. <b>5.5</b>
<b>BECKTON RUTH U557 JT</b>		Beckton Minerva L278 LN	
	Beckton Ruth P591 LN	Beckton Lancer T5 L095	
		Beckton Ruth E549 TP	

<b>DAM</b>	RAAA HerdBuilder index: <b>149</b> (Top 7% of all RA bulls)									
Age <b>7</b>	RAAA GridMaster index: <b>49</b> (Top 47% of all RA bulls)									
Wt <b>1088</b>	Calv.Ease	BW	WW	YW	Milk	HPG	Stay	Maint.En.		
Prog.BW <b>77</b>	EPDs <b>8</b>	<b>-1.1</b>	<b>65</b>	<b>93</b>	<b>22</b>	<b>11</b>	<b>14</b>	<b>-4.8</b>		
WR <b>110</b>	Marb <b>+0.64</b>		REA <b>-0.08</b>		Bfat <b>+0.03</b>					
YR <b>111</b>										
Cow Eff. <b>110</b>										

★★★★★ for Low Maintenance, Growth, Marbling, Superior Cow, Calving Ease, Stayability.



• Heifers •

**306** **BECKTON SIERRA C254 W**  
1-A 100% # 3487870 Tattoo: BSF5 C254

Birth: 3-18-15  
 Beckton Warrior W534 N4 < Beckton Warrior C1 S337  
 BKT Larkeisa S055 NB  
**BECKTON WARRIOR Y108 E5** BWT **77**  
 Ref. W-3 < Beckton Epic T330 L5  
 Beckton Susan W058 E < Beckton Susan T048 NB WR **114**  
 Beckton Lasso P741 < Beckton Lancer T1 H080 YR **112**  
**BECKTON SIERRA S065 LO** Fr. **5.5**  
 Beckton Ruth G534 NP  
 Beckton Lancer T6 M467  
 Beckton Sierra P027 LN < Beckton Sierra M258 LN

DAM		RAAA HerdBuilder index: <b>128</b> (Top <b>21%</b> of all RA bulls)
Age	9	RAAA GridMaster index: <b>50</b> (Top <b>20%</b> of all RA bulls)
Wt	1220	Calv.Ease BW WW YW Milk HPG Stay Maint.En.
Prog.BW	77	EPDs <b>11 -2.9 57 92 30 11 12 2.8</b>
WR	111	Marb <b>+0.51</b> REA <b>-0.03</b> Bfat <b>+0.03</b>
YR	112	
Cow Eff.	96	

★★★★★ for Low Maintenance, Growth, Marbling, Superior Cow, Calving Ease.

**308** **BECKTON MINERVA C371 S**  
1-A 100% # 3487373 Tattoo: BKT5 C371

Birth: 3-24-15  
 Beckton Scamp T A825 < Beckton Scamp 8954  
 Bkt Encino 8459 TJ  
**BECKTON SCAMP X458 H3** BWT **75**  
 Ref. S-1 < BKT Pine Marie R401 HU < Beckton Hustler C2 L079  
 Bkt Pine Marie LC30 CD WR **98**  
 Beckton Colt K M609 < Beckton Colt G552 YR **100**  
**BECKTON MINERVA T864 CK** Fr. **5.5**  
 Beckton Angel H164 LO  
 Beckton Lancer T3 J396  
 Beckton Minerva M179 LN < Beckton Minerva E932 JL

DAM		RAAA HerdBuilder index: <b>136</b> (Top <b>14%</b> of all RA bulls)
Age	8	RAAA GridMaster index: <b>49</b> (Top <b>43%</b> of all RA bulls)
Wt	1114	Calv.Ease BW WW YW Milk HPG Stay Maint.En.
Prog.BW	69	EPDs <b>12 -3.8 46 74 22 12 11 -4.1</b>
WR	103	Marb <b>+0.32</b> REA <b>-0.13</b> Bfat <b>+0.00</b>
YR	101	
Cow Eff.	91	

★★★★★ for Low Maintenance, Marbling, Calving Ease.



**309** **BSF HELEN C301 N**  
2 99% # 3487886 Tattoo: BSF5 C301

Birth: 3-20-15  
 Beckton New Era Y194 < Beckton Nebula P P707  
 BKT Larkeisa T310 JC BWT **75**  
**BECKTON NEW ERA A409 N2** Ref. N < Beckton Nebula L P093 WR **109**  
 Beckton Eola W796 N < Beckton Eola S023 JT  
 Beckton Warhawk N560 < Beckton Warrior T1 H281 YR **107**  
**BSF HELENA R003 WA** Fr. **5.0**  
 Beckton Firefly H195 HD  
 BSF Helena N151 HU < Beckton Hustler CN J102  
 BSF Regus F175

DAM		RAAA HerdBuilder index: <b>62</b> (Top <b>91%</b> of all RA bulls)
Age	10	RAAA GridMaster index: <b>48</b> (Top <b>61%</b> of all RA bulls)
Wt	1238	Calv.Ease BW WW YW Milk HPG Stay Maint.En.
Prog.BW	70	EPDs <b>12 -3.2 65 105 20 17 13 4.1</b>
WR	109	Marb <b>+0.62</b> REA <b>-0.07</b> Bfat <b>+0.03</b>
YR	106	
Cow Eff.	91	

★★★★★ for Growth, Marbling, Superior Cow, Calving Ease.

**307** **BSF DOMINIQUE C465 E**  
1-B 99% # 3487749 Tattoo: BSF5 C465

Birth: 3-26-15  
 Beckton Epic K4 N795 < Beckton Epic KJ J722  
 Beckton Sierra J789 EP BWT **80**  
**BECKTON EPIC T330 L5** Ref. E < Beckton Lancer T A664 WR **113**  
 Beckton Belga K202 LN < Beckton Belga D460 KR  
 Beckton Accent W180 C2 < Beckton Cody K1 P014 YR **113**  
**BSF DOMINIQUE Y109 A** Fr. **6.0**  
 Beckton Christy R046 CQ  
 BSF Dominique W352 J < Beckton Juno N493  
 BSF Dominique R653 DM

DAM		RAAA HerdBuilder index: <b>131</b> (Top <b>18%</b> of all RA bulls)
Age	4	RAAA GridMaster index: <b>52</b> (Top <b>6%</b> of all RA bulls)
Wt	1210	Calv.Ease BW WW YW Milk HPG Stay Maint.En.
Prog.BW	67	EPDs <b>12 -4.5 60 101 24 12 12 3.9</b>
WR	109	Marb <b>+0.58</b> REA <b>+0.04</b> Bfat <b>+0.02</b>
YR	109	
Cow Eff.	93	

★★★★★ for Low Maintenance, Growth, Marbling, Superior Cow, Calving Ease.

**310** **BECKTON LARKABA C462 N**  
1-A 100% # 3487340 Tattoo: BKT5 C462

Birth: 3-25-15  
 Beckton Nebula U206 V3 < Beckton Nebula P P707  
 Beckton Minerva J615 VG BWT **90**  
**BECKTON NEBULA X096 N4** Ref. N-3 < Beckton Nebula P P707 WR **113**  
 Beckton Tamara U185 NB < Beckton Tamara P813 CH  
 Beckton Epic T330 L5 < Beckton Epic K4 N795 YR **110**  
**BECKTON LARKABA W050 E** Fr. **5.0**  
 Beckton Belga K202 LN  
 Beckton Nebula H R233  
 Beckton Larkaba T184 NB < Beckton Larkaba R809 NB

DAM		RAAA HerdBuilder index: <b>160</b> (Top <b>4%</b> of all RA bulls)
Age	6	RAAA GridMaster index: <b>52</b> (Top <b>6%</b> of all RA bulls)
Wt	1052	Calv.Ease BW WW YW Milk HPG Stay Maint.En.
Prog.BW	67	EPDs <b>12 -4.0 62 103 22 12 14 2.6</b>
WR	104	Marb <b>+0.61</b> REA <b>+0.01</b> Bfat <b>+0.01</b>
YR	103	
Cow Eff.	110	

★★★★★ for Low Maintenance, Growth, Marbling, Superior Cow, Calving Ease, Stayability.



• Heifers •



**313 BECKTON INDIGO C507 W**  
 1-A 100% # 3487743 Tattoo: BSF5 C507

Birth: 3-29-15  
 Beckton Warrior T1 H281 < Beckton Warrior TC E801  
 Beckton Minerva B609 RN

**BECKTON WARHAWK N560**  
 Ref. W-1 Beckton Firefly H195 HD < Beckton Hadrian A100  
 Beckton Firefly C999 CB

Beckton Likable U120 L2 < Beckton Likable S633  
 Beckton Lana S718 LN

**BECKTON INDIGO Y388 L**  
 Beckton Indigo R567 WA < Beckton Warhawk N560  
 Beckton Indigo N754 HR

BWt	53
WR	99
YR	108
Fr.	5.0

DAM	Age	RAAA HerdBuilder index: <b>135</b> (Top <b>15%</b> of all RA bulls)								
	Wt	RAAA GridMaster index: <b>51</b> (Top <b>11%</b> of all RA bulls)								
	Prog.BW	Calv.Ease	BW	WW	YW	Milk	HPG	Stay	Maint.En.	
	WR	EPDs	<b>17</b>	<b>-8.2</b>	<b>45</b>	<b>76</b>	<b>15</b>	<b>17</b>	<b>10</b>	<b>-4.4</b>
	YR									
	Cow Eff.	Marb	<b>+0.54</b>	REA	<b>+0.01</b>	Bfat	<b>+0.01</b>			

★★★★★ for Low Maintenance, Growth, Marbling, Calving Ease.

**311 BECKTON INDIGO C342 J**  
 1-A 100% # 3487404 Tattoo: BKT5 C342

Birth: 3-22-15  
 Beckton Roman J S158 < TR Romeo NT379  
 Beckton Belga K285 JL

**BECKTON JANUS X799 L2**  
 Ref. J-3 Beckton Sierra K557 LO < Beckton Loki F251  
 Beckton Sierra C157 CL

Beckton Justice CH M056 < Beckton Justice C K449  
 Beckton Ruth K802 HD

**BECKTON INDIGO S262 JC**  
 Beckton Indigo L588 LN < Beckton Lancer TL G626  
 Bkt Indigo 9235 GL

BWt	74
WR	109
YR	102
Fr.	5.0

DAM	Age	RAAA HerdBuilder index: <b>141</b> (Top <b>11%</b> of all RA bulls)								
	Wt	RAAA GridMaster index: <b>50</b> (Top <b>20%</b> of all RA bulls)								
	Prog.BW	Calv.Ease	BW	WW	YW	Milk	HPG	Stay	Maint.En.	
	WR	EPDs	<b>11</b>	<b>-2.7</b>	<b>52</b>	<b>82</b>	<b>28</b>	<b>10</b>	<b>11</b>	<b>4.9</b>
	YR									
	Cow Eff.	Marb	<b>+0.51</b>	REA	<b>+0.06</b>	Bfat	<b>-0.01</b>			

★★★★★ for Marbling, Superior Cow, Calving Ease.



**312 BECKTON TAMARA C494 J**  
 1-A 100% # 3487845 Tattoo: BSF5 C494

Birth: 3-28-15  
 Beckton Roman J S158 < TR Romeo NT379  
 Beckton Belga K285 JL

**BECKTON JANUS X799 L2**  
 Ref. J-3 Beckton Sierra K557 LO < Beckton Loki F251  
 Beckton Sierra C157 CL

Beckton Justice C1 R483 < Beckton Justice CH M056  
 Beckton Tamara J124 HR

**BECKTON TAMARA U249 JC**  
 Beckton Tamara M823 LN < Beckton Lancer TL G626  
 Beckton Tamara F269 CH

BWt	70
WR	107
YR	110
Fr.	5.0

DAM	Age	RAAA HerdBuilder index: <b>145</b> (Top <b>9%</b> of all RA bulls)								
	Wt	RAAA GridMaster index: <b>50</b> (Top <b>31%</b> of all RA bulls)								
	Prog.BW	Calv.Ease	BW	WW	YW	Milk	HPG	Stay	Maint.En.	
	WR	EPDs	<b>13</b>	<b>-3.7</b>	<b>55</b>	<b>86</b>	<b>30</b>	<b>11</b>	<b>11</b>	<b>6.9</b>
	YR									
	Cow Eff.	Marb	<b>+0.36</b>	REA	<b>+0.10</b>	Bfat	<b>+0.01</b>			

★★★★★ for Growth, Marbling, Superior Cow, Calving Ease.

**314 BECKTON BARMAID C478 E**  
 1-A 100% # 3487851 Tattoo: BSF5 C478

Birth: 3-28-15  
 Beckton Epic K6 S569 < Beckton Epic KM M115  
 Beckton Sierra N703 LM

**BECKTON EPIC X464 L5**  
 Ref. E-2 Beckton Lana M393 LN < Beckton Lancer T3 J396  
 Beckton Lana F081 LN

Beckton Cherokee N N479 < BFCK Cherokee Cnyn 4912  
 Beckton Dinah C440 NM

**BECKTON BARMAID U114 CQ**  
 Beckton Barmaid P323 HR < Beckton Herald FV J537  
 Beckton Barmaid J012 CO

BWt	79
WR	111
YR	104
Fr.	5.0

DAM	Age	RAAA HerdBuilder index: <b>146</b> (Top <b>9%</b> of all RA bulls)								
	Wt	RAAA GridMaster index: <b>50</b> (Top <b>30%</b> of all RA bulls)								
	Prog.BW	Calv.Ease	BW	WW	YW	Milk	HPG	Stay	Maint.En.	
	WR	EPDs	<b>9</b>	<b>-2.0</b>	<b>57</b>	<b>87</b>	<b>32</b>	<b>11</b>	<b>13</b>	<b>-5.4</b>
	YR									
	Cow Eff.	Marb	<b>+0.50</b>	REA	<b>+0.06</b>	Bfat	<b>+0.02</b>			

★★★★★ for Low Maintenance, Marbling, Calving Ease.

• Heifers •

**315** **BECKTON SIERRA C489 N**  
1-A 100% # 3487282 Tattoo: BKT5 C489

Birth: 3-28-15	Beckton Nebula E P084	Beckton Nebula M045	
	Beckton Nebula EN S347	BKT Pine Marie M119 EP	BWt <b>71</b>
Ref. N-2	Beckton Eola P530 NB	Beckton Nebula M045	WR <b>110</b>
		Beckton Eola M663 EP	YR <b>107</b>
	Beckton Hasten H S462	Beckton Hasten P292	Fr. <b>5.0</b>
<b>BECKTON SIERRA X398 H</b>	Beckton Sierra N403 LN	Beckton Lakme G128 HD	
		Beckton Lancer TH K417	
		Beckton Sierra J659 DM	

<b>DAM</b>	RAAA HerdBuilder index: <b>174</b> (Top 2% of all RA bulls)									
Age	RAAA GridMaster index: <b>50</b> (Top 27% of all RA bulls)									
Wt	1026	Calv.Ease	BW	WW	YW	Milk	HPG	Stay	Maint.En.	
Prog.BW	60	EPDs	16	-6.4	47	68	30	14	14	-5.4
WR	106	Marb	+.62		REA	-.33		Bfat		+0.02
YR	102									
Cow Eff.	102									

★★★★★ for Low Maintenance, Growth, Marbling, Calving Ease, Stayability.

**317** **BECKTON SIERRA C710 E**  
1-A 100% # 3487593 Tattoo: BKT5 C710

Birth: 4-14-15	Beckton Epic K6 S569	Beckton Epic KM M115	
	<b>BECKTON EPIC X464 L5</b>	Beckton Sierra N703 LM	BWt <b>89</b>
Ref. E-2	Beckton Lana M393 LN	Beckton Lancer T3 J396	WR <b>101</b>
		Beckton Lana F081 LN	YR <b>107</b>
	Beckton Cherokee T450 L3	Beckton Cherokee N N479	Fr. <b>5.5</b>
<b>BECKTON SIERRA X818 C</b>	Beckton Sierra G615 WR	Beckton Annie M337 LN	
		Beckton Warrior C C355	
		Beckton Sierra D804 JL	

<b>DAM</b>	RAAA HerdBuilder index: <b>126</b> (Top 22% of all RA bulls)									
Age	RAAA GridMaster index: <b>49</b> (Top 49% of all RA bulls)									
Wt	1076	Calv.Ease	BW	WW	YW	Milk	HPG	Stay	Maint.En.	
Prog.BW	82	EPDs	6	1.3	59	100	27	11	12	-1.9
WR	99	Marb	+.38		REA	+.10		Bfat		+0.00
YR	111									
Cow Eff.	96									

★★★★★ for Low Maintenance, Growth, Marbling.

**316** **BECKTON LANA C402 E**  
2 100% # 3487831 Tattoo: BSF5 C402

Birth: 3-24-15	Beckton Epic T330 L5	Beckton Epic K4 N795	
	<b>BECKTON EPIC X330 L6</b>	Beckton Belga K202 LN	BWt <b>69</b>
Ref. E-1	Beckton Kit R503 LN	Beckton Lancer F442 T	WR <b>100</b>
		Beckton Kit F468 JL	YR <b>101</b>
	Beckton Vega P079	Beckton Vegas S1 K316	Fr. <b>4.5</b>
<b>BECKTON LANA U640 VA</b>	Beckton Lana R810 HU	Beckton Lydia H159 JL	
		Beckton Hustler C2 L079	
		Beckton Lana H544 WR	

<b>DAM</b>	RAAA HerdBuilder index: <b>128</b> (Top 20% of all RA bulls)									
Age	RAAA GridMaster index: <b>51</b> (Top 9% of all RA bulls)									
Wt	1136	Calv.Ease	BW	WW	YW	Milk	HPG	Stay	Maint.En.	
Prog.BW	79	EPDs	10	-3.5	54	87	19	11	10	3.5
WR	107	Marb	+.70		REA	+.17		Bfat		+0.00
YR	107									
Cow Eff.	91									

★★★★★ for Low Maintenance, Marbling, Rib-eye area, Superior Cow, Calving Ease.

**318** **BKT LARKABEL C295 S**  
2 100% # 3487832 Tattoo: BSF5 C295

Birth: 3-20-15	Beckton Scamp T A825	Beckton Scamp 8954	
	<b>BECKTON SCAMP X458 H3</b>	Bkt Encino 8459 TJ	BWt <b>69</b>
Ref. S-1	BKT Pine Marie R401 HU	Beckton Hustler C2 L079	WR <b>100</b>
		Bkt Pine Marie LC30 CD	YR <b>105</b>
	Beckton Nebula L P093	Beckton Nebula M045	Fr. <b>5.0</b>
<b>BKT LARKABEL U613 NB</b>	BKT Larkabel R038 WA	Beckton Marta M021 LN	
		Beckton Warhawk N560	
		Beckton Larkabel N769 HR	

<b>DAM</b>	RAAA HerdBuilder index: <b>157</b> (Top 5% of all RA bulls)									
Age	RAAA GridMaster index: <b>50</b> (Top 26% of all RA bulls)									
Wt	1075	Calv.Ease	BW	WW	YW	Milk	HPG	Stay	Maint.En.	
Prog.BW	68	EPDs	11	-4.2	55	89	17	17	11	-1.9
WR	103	Marb	+.43		REA	-.08		Bfat		-0.01
YR	105									
Cow Eff.	95									

★★★★★ for Low Maintenance, Growth, Marbling, Superior Cow, Calving Ease.



**319** **BECKTON LANA C218 S**  
1-A 100% # 3487867 Tattoo: BSF5 C218

Birth: 3-15-15	Beckton Scamp T A825	Beckton Scamp 8954	
	<b>BECKTON SCAMP X494 E3</b>	Bkt Encino 8459 TJ	BWt <b>65</b>
Ref. S-2	Beckton Lana S074 EP	Beckton Epic KH P678	WR <b>98</b>
		Beckton Lana P317 JL	YR <b>96</b>
	Beckton Lancer T7 M089	Beckton Lancer F442 T	Fr. <b>5.0</b>
<b>BECKTON LANA S417 LN</b>	Beckton Lana C954 CB	Beckton Tamara G141 HE	
		Beckton Cobalt K Z100	
		Beckton Lana 9077 DT	

<b>DAM</b>	RAAA HerdBuilder index: <b>131</b> (Top 18% of all RA bulls)									
Age	RAAA GridMaster index: <b>49</b> (Top 48% of all RA bulls)									
Wt	1198	Calv.Ease	BW	WW	YW	Milk	HPG	Stay	Maint.En.	
Prog.BW	73	EPDs	12	-4.7	44	66	23	12	10	-3.9
WR	104	Marb	+.26		REA	+.03		Bfat		-0.03
YR	101									
Cow Eff.	84									

★★★★★ for Low Maintenance, Marbling, Calving Ease.

• Heifers •

**320** **BECKTON SIERRA C762 N**  
1-A 100% # 3487797 Tattoo: BSF5 C762

Birth: 4-21-15	Beckton Nebula E P084	Beckton Nebula M045	
	Beckton Eola P530 NB	BKT Pine Marie M119 EP	BWt <b>77</b>
<b>BECKTON NEBULA EN S347</b>		Beckton Nebula M045	WR <b>110</b>
Ref. N-2		Beckton Eola M663 EP	YR <b>105</b>
	Beckton Epic K6 S569	Beckton Epic KM M115	Fr. <b>5.5</b>
<b>BECKTON SIERRA W887 E</b>		Beckton Sierra N703 LM	
	Beckton Sierra T663 LN	Beckton Lancer T9 N586	
		Beckton Sierra L887 LN	

<b>DAM</b>	RAAA HerdBuilder index: <b>166</b> (Top 3% of all RA bulls)
Age <b>6</b>	RAAA GridMaster index: <b>49</b> (Top 39% of all RA bulls)
Wt <b>1096</b>	
Prog.BW <b>72</b>	Calv.Ease BW WW YW Milk HPG Stay Maint.En.
WR <b>109</b>	EPDs <b>12 -4.4 48 66 32 14 14 -6.8</b>
YR <b>102</b>	Marb <b>+.70</b> REA <b>-.31</b> Bfat <b>+.02</b>
Cow Eff. <b>103</b>	

★★★★★ for Low Maintenance, Marbling, Calving Ease, Stayability.

**322** **BECKTON BELGA C486 N**  
1-A 100% # 3487910 Tattoo: BSF5 C486

Birth: 3-28-15	Beckton Nomad 7496	Beckton Neva 5562	
	Beckton Lana 7152 TJ	Bkt Bolt Tamrck 3913	BWt <b>51</b>
<b>BECKTON NOMAD T 9A14</b>		Beckton Trojan 5253	WR <b>95</b>
Ref. V-2		Bkt Signal Lana 5599	YR <b>97</b>
	Beckton Epic K1 K863	Beckton Epic KN H110	Fr. <b>4.5</b>
<b>BECKTON BELGA M050 EP</b>		Beckton Rose H019 SC	
	Beckton Belga K588 HD	Beckton Hadrian F C486	
		Beckton Belga C506 HB	

<b>DAM</b>	RAAA HerdBuilder index: <b>141</b> (Top 11% of all RA bulls)
Age <b>13</b>	RAAA GridMaster index: <b>49</b> (Top 51% of all RA bulls)
Wt <b>980</b>	
Prog.BW <b>60</b>	Calv.Ease BW WW YW Milk HPG Stay Maint.En.
WR <b>108</b>	EPDs <b>20 -9.6 28 33 24 14 10 -10.8</b>
YR <b>103</b>	Marb <b>+.46</b> REA <b>-.19</b> Bfat <b>-.01</b>
Cow Eff. <b>95</b>	

★★★★★ for Low Maintenance, Marbling, Calving Ease.

**321** **BECKTON VERNICE C479 J**  
1-A 100% # 3487429 Tattoo: BKT5 C479

Birth: 3-28-15	Beckton Julian GG B571	Beckton Julian 7526G	
	Bkt Suffeina A828 DM	Bkt Marta 9A13 JL	BWt <b>63</b>
<b>BECKTON JULIAN G3 P608</b>		Beckton Dominor 9455	WR <b>99</b>
Ref. J		Bkt Suffeina 9493 TT	YR <b>99</b>
	Beckton Hustler CN J102	Beckton Hustler C G407	Fr. <b>4.5</b>
<b>BECKTON VERNICE N598 HU</b>		Beckton Belga G355 NP	
	Beckton Vernice C047 JL	Beckton Julian SJ A470	
		Beckton Vernice A140 JU	

<b>DAM</b>	RAAA HerdBuilder index: <b>131</b> (Top 18% of all RA bulls)
Age <b>12</b>	RAAA GridMaster index: <b>51</b> (Top 14% of all RA bulls)
Wt <b>1198</b>	
Prog.BW <b>78</b>	Calv.Ease BW WW YW Milk HPG Stay Maint.En.
WR <b>110</b>	EPDs <b>15 -5.2 43 71 21 13 10 -3.4</b>
YR <b>107</b>	Marb <b>+.53</b> REA <b>-.08</b> Bfat <b>-.03</b>
Cow Eff. <b>82</b>	

★★★★★ for Low Maintenance, Marbling, Superior Cow, Calving Ease.

**323** **BECKTON INDIGO C843 J**  
1-A 100% # 3487830 Tattoo: BSF5 C843

Birth: 5-12-15	Beckton Roman J S158	TR Romeo NT379	
	Beckton Sierra K557 LO	Beckton Belga K285 JL	BWt <b>82</b>
<b>BECKTON JANUS X799 L2</b>		Beckton Loki F251	WR <b>98</b>
Ref. J-3		Beckton Sierra C157 CL	YR <b>106</b>
	Beckton Julian GJ P535	Beckton Julian 7526G	Fr. <b>4.5</b>
<b>BECKTON INDIGO U658 JL</b>		Beckton Mona D086 JL	
	Beckton Indigo R567 WA	Beckton Warhawk N560	
		Beckton Indigo N754 HR	

<b>DAM</b>	RAAA HerdBuilder index: <b>132</b> (Top 17% of all RA bulls)
Age <b>7</b>	RAAA GridMaster index: <b>49</b> (Top 39% of all RA bulls)
Wt <b>NA</b>	
Prog.BW <b>72</b>	Calv.Ease BW WW YW Milk HPG Stay Maint.En.
WR <b>97</b>	EPDs <b>13 -3.9 46 80 23 14 10 -0.6</b>
YR <b>100</b>	Marb <b>+.44</b> REA <b>-.04</b> Bfat <b>+.00</b>
Cow Eff. <b>NA</b>	

★★★★★ #N/A



**324** **BECKTON LARKABA C733 J**  
1-A 100% # 3487707 Tattoo: BSF5 C733

Birth: 4-18-15	Beckton Roman J S158	TR Romeo NT379	
	Beckton Sierra K557 LO	Beckton Belga K285 JL	BWt <b>65</b>
<b>BECKTON JANUS X799 L2</b>		Beckton Loki F251	WR <b>100</b>
Ref. J-3		Beckton Sierra C157 CL	YR <b>98</b>
	Beckton Nebula U206 V3	Beckton Nebula P P707	Fr. <b>5.5</b>
<b>BECKTON LARKABA Z446 N</b>		Beckton Minerva J615 VG	
	Beckton Larkaba R357 LO	Beckton Loki C M740	
		Beckton Larkaba F394 VG	

<b>DAM</b>	RAAA HerdBuilder index: <b>153</b> (Top 6% of all RA bulls)
Age <b>3</b>	RAAA GridMaster index: <b>49</b> (Top 37% of all RA bulls)
Wt <b>1162</b>	
Prog.BW <b>65</b>	Calv.Ease BW WW YW Milk HPG Stay Maint.En.
WR <b>94</b>	EPDs <b>11 -3.3 53 84 23 8 13 4.1</b>
YR <b>95</b>	Marb <b>+.34</b> REA <b>+.00</b> Bfat <b>-.01</b>
Cow Eff. <b>78</b>	

★★★★★ for Marbling, Calving Ease, Stayability.



• Heifers •

**325** **BECKTON LANA C355 N**  
1-A 100% # 3487237 Tattoo: BKT5 C355

Birth: 3-23-15  
Beckton Nomad 7496 < Beckton Neva 5562  
Bkt Bolt Tamrck 3913

**BECKTON NOMAD V 9871**  
Ref. V-1 < Beckton Varo 5642  
Bkt Lahrogno-3

**BECKTON LANA Z577 E**  
Beckton Epic U749 D5 < Beckton Epic K4 N795  
Beckton Denise R308 DM  
Beckton Lana W479 J < Beckton Julio L233  
Beckton Lana R121 JC

BWt	68
WR	107
YR	100
Fr.	5.5

DAM	
Age	3
Wt	1108
Prog.BW	68
WR	107
YR	100
Cow Eff.	84

RAAA HerdBuilder index: **107**(Top 45% of all RA bulls)  
RAAA GridMaster index: **48**(Top 60% of all RA bulls)

Calv.Ease	BW	WW	YW	Milk	HPG	Stay	Maint.En.	
EPDs	13	-4.7	49	69	23	11	9	-11.9
Marb	+.52		REA	-.13		Bfat		+.02

★★★★★ for Low Maintenance, Marbling, Calving Ease.

**327** **BECKTON COCA C278 N**  
1-A 100% # 3487559 Tattoo: BKT5 C278

Birth: 3-19-15  
Beckton Nomad 7496 < Beckton Neva 5562  
Bkt Bolt Tamrck 3913

**BECKTON NOMAD T 9A14**  
Ref. V-2 < Beckton Trojan 5253  
Bkt Signal Lana 5599

**BECKTON COCA Y450 E**  
Beckton Epic U749 D5 < Beckton Epic K4 N795  
Beckton Denise R308 DM  
Beckton Coca S218 EP < Beckton Epic K3 M606  
Beckton Coca K480 CO

BWt	57
WR	90
YR	95
Fr.	5.0

DAM	
Age	4
Wt	1154
Prog.BW	60
WR	98
YR	98
Cow Eff.	77

RAAA HerdBuilder index: **108**(Top 44% of all RA bulls)  
RAAA GridMaster index: **49**(Top 51% of all RA bulls)

Calv.Ease	BW	WW	YW	Milk	HPG	Stay	Maint.En.	
EPDs	15	-7.1	30	49	18	11	8	-6.5
Marb	+.33		REA	-.06		Bfat		+.00

★★★★★ for Low Maintenance, Marbling, Calving Ease.



**326** **BECKTON MONA C162 S**  
1-A 100% # 3488008 Tattoo: BSF5 C162

Birth: 3-8-15  
Beckton Scamp X494 E3 < Beckton Scamp T A825  
Beckton Lana S074 EP

**BECKTON SCAMP A633 C4**  
Ref. S-5 < Beckton Clifftop T3 N800  
Beckton Rose R507 CT < Beckton Rose N125 LN

**BECKTON MONA A236 A**  
Beckton Accent U777 C2 < Beckton Cody K1 P014  
Beckton Susan R022 CQ  
Beckton Warrior C1 S337  
Beckton Mona W856 W < Beckton Mona J463 CD

BWt	55
WR	95
YR	94
Fr.	4.5

DAM	
Age	2
Wt	835
Prog.BW	64
WR	80
YR	94
Cow Eff.	87

RAAA HerdBuilder index: **154** (Top 6% of all RA bulls)  
RAAA GridMaster index: **50**(Top 29% of all RA bulls)

Calv.Ease	BW	WW	YW	Milk	HPG	Stay	Maint.En.	
EPDs	11	-4.3	49	73	21	10	13	-0.5
Marb	+.43		REA	+.09		Bfat		-.01

★★★★★ for Low Maintenance, Marbling, Calving Ease, Stayability.

**328** **BSF JUSTICIA C666 S**  
1-B 99% # 3487836 Tattoo: BSF5 C666

Birth: 4-9-15  
Beckton Scamp T A825 < Beckton Scamp 8954  
Bkt Encino 8459 TJ

**BECKTON SCAMP X458 H3**  
Ref. S-1 < BKT Pine Marie R401 HU  
Beckton Hustler C2 L079  
Bkt Pine Marie LC30 CD

**BSF JUSTICIA U488 EP**  
Beckton Epic K4 N795 < Beckton Epic KJ J722  
Beckton Sierra J789 EP  
Beckton Justice CH M056  
BSF Justicia R888 JC < BSF Regus M177 EP

BWt	70
WR	101
YR	104
Fr.	5.0

DAM	
Age	7
Wt	1160
Prog.BW	72
WR	104
YR	106
Cow Eff.	89

RAAA HerdBuilder index: **109**(Top 43% of all RA bulls)  
RAAA GridMaster index: **50**(Top 21% of all RA bulls)

Calv.Ease	BW	WW	YW	Milk	HPG	Stay	Maint.En.	
EPDs	9	-2.8	56	93	17	11	8	-3.6
Marb	+.55		REA	-.03		Bfat		+.02

★★★★★ for Low Maintenance, Marbling, Superior Cow, Calving Ease.

• Heifers •



**330** **BSF EPIQUETTE C711 W**  
1-B 99% # 3487820 Tattoo: BSF5 C711

Birth: 4-14-15  
 Beckton Warrior W534 N4 < Beckton Warrior C1 S337  
 Beckton WARRIOR Y108 E5 < BKT Larkeisa S055 NB  
 Ref. W-3 Beckton Susan W058 E < Beckton Epic T330 L5  
 Beckton Epic K4 N795 < Beckton Susan T048 NB  
 Beckton Epic KJ J722  
**BSF EPIQUETTE W206 E** < Beckton Sierra J789 EP  
 BSF Regus K155 CH < Beckton Champ R2 H293  
 BSF Red Roan H766

<b>DAM</b>	RAAA HerdBuilder index: <b>126</b> (Top <b>22%</b> of all RA bulls)									
Age	RAAA GridMaster index: <b>51</b> (Top <b>10%</b> of all RA bulls)									
Wt	6	Calv.Ease	BW	WW	YW	Milk	HPG	Stay	Maint.En.	
Prog.BW	1248	EPDs	<b>12</b>	<b>-3.5</b>	<b>54</b>	<b>96</b>	<b>26</b>	<b>10</b>	<b>11</b>	<b>7.0</b>
WR	78									
YR	104	Marb	<b>+0.57</b>	REA	<b>+0.08</b>	Bfat	<b>+0.04</b>			
Fr.	111									
Cow Eff.	80									

★★★★★ for Growth, Marbling, Superior Cow, Calving Ease.

**329** **BSF LANETTE C425 J**  
1-B 99% # 3487774 Tattoo: BSF5 C425

Birth: 3-26-15  
 Beckton Roman J S158 < TR Romeo NT379  
 Beckton JANUS X799 L2 < Beckton Belga K285 JL  
 Ref. J-3 Beckton Sierra K557 LO < Beckton Loki F251  
 Beckton Julian G5 S107 < Beckton Sierra C157 CL  
 Beckton Julian GJ P535  
**BSF LANETTE X408 J** < Beckton Minola P826 DM  
 BSF Lanette P177 < Beckton Lancer T6 M467  
 BSF Regus M383 CH

<b>DAM</b>	RAAA HerdBuilder index: <b>141</b> (Top <b>11%</b> of all RA bulls)									
Age	RAAA GridMaster index: <b>49</b> (Top <b>52%</b> of all RA bulls)									
Wt	5	Calv.Ease	BW	WW	YW	Milk	HPG	Stay	Maint.En.	
Prog.BW	1065	EPDs	<b>10</b>	<b>-2.0</b>	<b>49</b>	<b>76</b>	<b>27</b>	<b>11</b>	<b>12</b>	<b>-0.2</b>
WR	75									
YR	105	Marb	<b>+0.36</b>	REA	<b>-0.02</b>	Bfat	<b>+0.01</b>			
Fr.	100									
Cow Eff.	93									

★★★★★ for Low Maintenance, Marbling, Calving Ease.

**331** **BSF HUSTELLE C747 N**  
1-B 99% # 3487860 Tattoo: BSF5 C747

Birth: 4-19-15  
 Beckton Nomad 7496 < Beckton Neva 5562  
 Beckton NOMAD V 9871 < Bkt Bolt Tamrck 3913  
 Ref. V-1 Bkt Barnmaid 6986 VR < Beckton Varo 5642  
 Beckton Exeter R090 < Bkt Lahrogno-3  
 Beckton Epic K4 N795  
**BSF HUSTELLE T546 EX** < Beckton Lana N310 EP  
 BSF Hustelle R505 HU < Beckton Hustler CN J102  
 BSF Regus L330 VG

<b>DAM</b>	RAAA HerdBuilder index: <b>86</b> (Top <b>72%</b> of all RA bulls)									
Age	RAAA GridMaster index: <b>48</b> (Top <b>68%</b> of all RA bulls)									
Wt	8	Calv.Ease	BW	WW	YW	Milk	HPG	Stay	Maint.En.	
Prog.BW	1190	EPDs	<b>14</b>	<b>-5.4</b>	<b>46</b>	<b>64</b>	<b>24</b>	<b>10</b>	<b>7</b>	<b>-12.3</b>
WR	68									
YR	107	Marb	<b>+0.50</b>	REA	<b>-0.32</b>	Bfat	<b>+0.03</b>			
Fr.	108									
Cow Eff.	91									

★★★★★ for Low Maintenance, Growth, Marbling, Superior Cow, Calving Ease.



Boofy the Cow



# Reference Sires

---

The goal for Beckton's program has always been to develop breeding seedstock which offer increased levels of performance for the commercial cattleman. Increased performance does not mean maximizing weight and size, which have already reached the upper limit of economic

value for the packer and consumer. It does, however, mean increasing performance related to calving percentage and weaning percentage; and increasing performance related to cow maintenance requirements and "pounds of calf per acre" efficiency.



***Beckton Julian B571 (Ref. Sire J-1)***



• Reference Sires •

**A-1 BECKTON ACCENT W180 C2**  
1-A 100% # 1331776 Tattoo: BSF9 W180

Birth: 3-12-09	Beckton Cody KH M390	Beckton Cody K G701	BWt <b>77</b>
	Beckton Rose M126 WR	Beckton Tamara J124 HR	WR <b>116</b>
<b>BECKTON CODY K1 P014</b>	Beckton Warrior T C371	Beckton Rose D741 LN	ADG <b>4.23</b>
Ref. A	Beckton Cherokee N N479	BFCK Cherokee Cnyn 4912	YR <b>114</b>
	Beckton Christy R046 CQ	Beckton Dinah C440 NM	Scr. <b>39</b>
	Beckton Christy N740 HR	Beckton Herald FJ J776	Fr. <b>5.5</b>
		Beckton Christy K141 VG	

RAAA HerdBuilder index: **151** (Top 7% of all RA bulls)

RAAA GridMaster index: **52** (Top 12% of all RA bulls)

<b>DAM</b>	Calv.Ease	BW	WW	YW	Milk	HPG	Stay	Maint.En.
Age <b>4</b>	EPDs <b>11</b>	<b>-4.5</b>	<b>70</b>	<b>112</b>	<b>23</b>	<b>12</b>	<b>14</b>	<b>-1.3</b>
Wt <b>1140</b>	Acc. (.57)	(.72)	(.67)	(.67)	(.55)	(.17)	(.19)	(.64)
Wean Pct. <b>57%</b>	Marb <b>+.56</b>	(.25)	REA <b>+.41</b>	(.22)	Bfat <b>+.05</b>	(.37)		
Cow Eff. <b>121</b>								

★★★★★ for Low Maintenance, Growth, Gainability, Marbling, Rib-eye area, High Cow Efficiency, Calving Ease, Stayability.

**A-4 MUSHRUSH LUNESTA A007**  
1-A 100% # 1615709 Tattoo: BKT3 A007

Birth: 2-25-13	Mushrush Lunesta W033	Beckton Cody T085 K2	BWt <b>67</b>
	Mushrush Madam OS U109	Mushrush Sierra LN S022	WR <b>101</b>
<b>MUSHRUSH LUNESTA MD Y097</b>	Mushrush Osage LN P017	Mushrush Madam JL R088	ADG <b>NA</b>
Ref.	Padg Julian 674	Padg Julian 178	YR <b>108</b>
	<b>MUSHRUSH CANDICE JL X212</b>	KCCAHA B807	Scr. <b>33</b>
	Padg Candy 196	Buf Crk Chf 824 1658	Fr. <b>NA</b>
		Mushrush Hera 9169	

RAAA HerdBuilder index: **119** (Top 22% of all RA bulls)

RAAA GridMaster index: **51** (Top 10% of all RA bulls)

<b>DAM</b>	Calv.Ease	BW	WW	YW	Milk	HPG	Stay	Maint.En.
Age <b>3</b>	EPDs <b>10</b>	<b>-6.0</b>	<b>36</b>	<b>70</b>	<b>28</b>	<b>9</b>	<b>10</b>	<b>.0</b>
Wt <b>NA</b>	Acc. (.12)	(.35)	(.30)	(.35)	(.12)	(.03)	(.02)	(.14)
Wean Pct. <b>NA%</b>	Marb <b>+.77</b>	(.17)	REA <b>-.01</b>	(.16)	Bfat <b>+.05</b>	(.15)		
Cow Eff. <b>NA</b>								

★★★★★ #N/A

**A-2 BECKTON ACCENT Y260 L3**  
1-A 100% # 1451513 Tattoo: BKT1 Y260

Birth: 3-24-11	Beckton Cody K1 P014	Beckton Cody KH M390	BWt <b>68</b>
	Beckton Christy R046 CQ	Beckton Rose M126 WR	WR <b>111</b>
<b>BECKTON ACCENT W180 C2</b>	Beckton Cherokee N N479	Beckton Christy N740 HR	ADG <b>2.95</b>
Ref. A-1	Beckton Loki CL S284	Beckton Loki C M740	YR <b>108</b>
	<b>BECKTON LANA W463 L</b>	Beckton Lakme J460 LT	Scr. <b>34</b>
	Beckton Lana R327 EP	Beckton Epic KM M115	Fr. <b>5.5</b>
		Beckton Lana K840 LN	

RAAA HerdBuilder index: **180** (Top 1% of all RA bulls)

RAAA GridMaster index: **51** (Top 22% of all RA bulls)

<b>DAM</b>	Calv.Ease	BW	WW	YW	Milk	HPG	Stay	Maint.En.
Age <b>2</b>	EPDs <b>9</b>	<b>-2.6</b>	<b>72</b>	<b>110</b>	<b>22</b>	<b>9</b>	<b>18</b>	<b>-2.0</b>
Wt <b>815</b>	Acc. (.28)	(.55)	(.48)	(.47)	(.24)	(.01)	(.01)	(.04)
Wean Pct. <b>70%</b>	Marb <b>+.50</b>	(.16)	REA <b>+.10</b>	(.14)	Bfat <b>+.01</b>	(.29)		
Cow Eff. <b>146</b>								

★★★★★ for Low Maintenance, Growth, Marbling, High Cow Efficiency, Calving Ease, Stayability.

**A-5 BECKTON ACCENT A110 E4**  
1-A 100% # 1626567 Tattoo: BKT3 A110

Birth: 3-15-13	Beckton Accent W180 C2	Beckton Cody K1 P014	BWt <b>73</b>
	Beckton Lana W463 L	Beckton Christy R046 CQ	WR <b>122</b>
<b>BECKTON ACCENT Y260 L3</b>	Beckton Emcee W271 L2	Beckton Loki CL S284	ADG <b>3.37</b>
Ref. A-2	Beckton Ruth W488 J	Beckton Lana R327 EP	YR <b>115</b>
	<b>BECKTON RUTH Y015 E</b>	Beckton Emcee S466	Scr. <b>36</b>
		Beckton Lana M621 LN	Fr. <b>5.0</b>
		Beckton Julian G3 P608	
		Beckton Ruth S871 WR	

RAAA HerdBuilder index: **161** (Top 2% of all RA bulls)

RAAA GridMaster index: **51** (Top 14% of all RA bulls)

<b>DAM</b>	Calv.Ease	BW	WW	YW	Milk	HPG	Stay	Maint.En.
Age <b>2</b>	EPDs <b>8</b>	<b>-2.4</b>	<b>71</b>	<b>112</b>	<b>21</b>	<b>10</b>	<b>16</b>	<b>-2.6</b>
Wt <b>785</b>	Acc. (.12)	(.32)	(.28)	(.29)	(.17)	(.01)	(.01)	(.19)
Wean Pct. <b>69%</b>	Marb <b>+.48</b>	(.06)	REA <b>+.09</b>	(.05)	Bfat <b>+.01</b>	(.09)		
Cow Eff. <b>146</b>								

★★★★★ for Low Maintenance, Growth, Marbling, High Cow Efficiency, Calving Ease, Stayability.

**A-3 BECKTON ACCENT Y312 N3**  
1-A 100% # 1451236 Tattoo: BKT1 Y312

Birth: 3-25-11	Beckton Cody K1 P014	Beckton Cody KH M390	BWt <b>69</b>
	Beckton Susan R022 CQ	Beckton Rose M126 WR	WR <b>109</b>
<b>BECKTON ACCENT U777 C2</b>	Beckton Nebula P P707	Beckton Cherokee N N479	ADG <b>4.20</b>
Ref. A	Beckton Larkeisa P688 CH	Beckton Susan N023 JE	YR <b>112</b>
	<b>BKT LARKEISA S055 NB</b>	Beckton Nebula M045	Scr. <b>38</b>
		Beckton Lana M809 EP	Fr. <b>5.0</b>
		Beckton Champ R3 H338	
		BKT Larkeisa J564 HR	

RAAA HerdBuilder index: **211** (Top 2% of all RA bulls)

RAAA GridMaster index: **55** (Top 4% of all RA bulls)

<b>DAM</b>	Calv.Ease	BW	WW	YW	Milk	HPG	Stay	Maint.En.
Age <b>5</b>	EPDs <b>15</b>	<b>-6.4</b>	<b>51</b>	<b>81</b>	<b>26</b>	<b>10</b>	<b>18</b>	<b>-6.6</b>
Wt <b>995</b>	Acc. (.31)	(.60)	(.50)	(.48)	(.27)	(.13)	(.08)	(.19)
Wean Pct. <b>63%</b>	Marb <b>+.70</b>	(.18)	REA <b>+.03</b>	(.16)	Bfat <b>+.08</b>	(.29)		
Cow Eff. <b>132</b>								

★★★★★ for Low Maintenance, Growth, Gainability, Marbling, High Cow Efficiency, Calving Ease, Stayability.



Beckton Accent A110 (A-5)

• Reference Sires •

**A-6 BECKTON ACCENT A175 O3**  
1-A 100% # 1626198 Tattoo: BKT3 A175

Birth: 3-18-13	Beckton Cody K1 P014	Beckton Cody KH M390	BWt <b>71</b>
		Beckton Rose M126 WR	WR <b>120</b>
<b>BECKTON ACCENT W180 C2</b>	Beckton Christy R046 CQ	Beckton Cherokee N N479	ADG <b>4.10</b>
Ref. A-1		Beckton Christy N740 HR	YR <b>116</b>
	TR Romeo NT379	Buffalo Creek Romeo L081	Scr. <b>37</b>
<b>BECKTON LANA R214 RA</b>	Beckton Lana N664 JL	Buf Crk Lass L420	Fr. <b>5.5</b>
		Beckton Julian G1 J526	
		Beckton Lana H533 LN	

RAAA HerdBuilder index: **148** (Top 5% of all RA bulls)  
 RAAA GridMaster index: **52** (Top 6% of all RA bulls)

Calv.Ease	BW	WW	YW	Milk	HPG	Stay	Maint.En.
EPDs <b>10</b>	<b>-3.0</b>	<b>74</b>	<b>113</b>	<b>24</b>	<b>9</b>	<b>13</b>	<b>-3.9</b>
Acc. (.20)	(.34)	(.31)	(.33)	(.24)	(.08)	(.07)	(.19)
Marb <b>+.47</b>	(.17)	REA <b>+.32</b>	(.15)	Bfat <b>+.02</b>	(.29)		

**DAM**

Age	8
Wt	1045
Wean Pct.	61%
Cow Eff.	128

★★★★★ for Low Maintenance, Growth, Gainability, Marbling, Rib-eye area, High Cow Efficiency, Calving Ease, Stayability.

**C-1 BECKTON CLIFFTOP W692 E3**  
1-A 100% # 1332252 Tattoo: BKT9 W692

Birth: 4-12-09	Beckton Clifftop T C075	BJR Topper 5241	BWt <b>72</b>
		Beckton Barmaid A761 TR	WR <b>116</b>
<b>BKT CLIFFTOP TP R288</b>	Beckton Christy K209 CO	Beckton Copper JT G095	ADG <b>4.10</b>
Ref. C		Beckton Christy A111 VQ	YR <b>115</b>
	Beckton Epic KM M115	Beckton Epic K F075	Scr. <b>40</b>
<b>BECKTON LYDIA S274 EP</b>	Beckton Lydia M607 LO	Beckton Minerva F495 CH	Fr. <b>5.0</b>
		Beckton Loki F251	
		Beckton Lydia J801 CD	

RAAA HerdBuilder index: **162** (Top 4% of all RA bulls)  
 RAAA GridMaster index: **50** (Top 31% of all RA bulls)

Calv.Ease	BW	WW	YW	Milk	HPG	Stay	Maint.En.
EPDs <b>11</b>	<b>-5.1</b>	<b>43</b>	<b>82</b>	<b>28</b>	<b>10</b>	<b>16</b>	<b>-3.1</b>
Acc. (.59)	(.73)	(.69)	(.68)	(.56)	(.10)	(.13)	(.62)
Marb <b>+.65</b>	(.27)	REA <b>-.24</b>	(.24)	Bfat <b>+.08</b>	(.38)		

**DAM**

Age	3
Wt	980
Wean Pct.	63%
Cow Eff.	132

★★★★★ for Low Maintenance, Growth, Gainability, Marbling, High Cow Efficiency, Calving Ease, Stayability.

**A-7 BECKTON ACCENT A485 C3**  
1-A 100% # 1626195 Tattoo: BKT3 A485

Birth: 3-29-13	Beckton Cody K1 P014	Beckton Cody KH M390	BWt <b>76</b>
		Beckton Rose M126 WR	WR <b>115</b>
<b>BECKTON ACCENT U777 C2</b>	Beckton Susan R022 CQ	Beckton Cherokee N N479	ADG <b>2.92</b>
Ref. A		Beckton Susan N023 JE	YR <b>103</b>
	Beckton Cherokee N N479	BFCK Cherokee Cryn 4912	Scr. <b>37</b>
<b>BECKTON TAMARA R175 CQ</b>	Beckton Tamara N765 CO	Beckton Dinah C440 NM	Fr. <b>5.5</b>
		Beckton Copper JT G095	
		Beckton Tamara HA54 LN	

RAAA HerdBuilder index: **160** (Top 2% of all RA bulls)  
 RAAA GridMaster index: **50** (Top 21% of all RA bulls)

Calv.Ease	BW	WW	YW	Milk	HPG	Stay	Maint.En.
EPDs <b>9</b>	<b>-4.4</b>	<b>50</b>	<b>71</b>	<b>29</b>	<b>11</b>	<b>18</b>	<b>-6.3</b>
Acc. (.21)	(.35)	(.32)	(.33)	(.25)	(.13)	(.06)	(.19)
Marb <b>+.57</b>	(.17)	REA <b>+.34</b>	(.15)	Bfat <b>+.04</b>	(.28)		

**DAM**

Age	8
Wt	1070
Wean Pct.	57%
Cow Eff.	121

★★★★★ for Low Maintenance, Marbling, Rib-eye area, High Cow Efficiency, Calving Ease, Stayability.

**C-2 BECKTON CLIFFTOP Y012 C4**  
1-A 100% # 1451482 Tattoo: BKT1 Y012

Birth: 2-20-11	BKT Clifftop TP R288	Beckton Clifftop T C075	BWt <b>53</b>
		Beckton Christy K209 CO	WR <b>108</b>
<b>BECKTON CLIFFTOP W692 E3</b>	Beckton Lydia S274 EP	Beckton Epic KM M115	ADG <b>3.25</b>
Ref. C-1		Beckton Lydia M607 LO	YR <b>112</b>
	BKT Clifftop TP R288	Beckton Clifftop T C075	Scr. <b>34</b>
<b>BECKTON LANA W240 C</b>	Beckton Lana L923 CD	Beckton Christy K209 CO	Fr. <b>5.0</b>
		Beckton Cody K G701	
		Beckton Lana D232 HV	

RAAA HerdBuilder index: **195** (Top 1% of all RA bulls)  
 RAAA GridMaster index: **50** (Top 34% of all RA bulls)

Calv.Ease	BW	WW	YW	Milk	HPG	Stay	Maint.En.
EPDs <b>12</b>	<b>-5.2</b>	<b>45</b>	<b>81</b>	<b>26</b>	<b>12</b>	<b>17</b>	<b>-6.4</b>
Acc. (.28)	(.55)	(.47)	(.45)	(.23)	(.01)	(.01)	(.04)
Marb <b>+.46</b>	(.16)	REA <b>+.03</b>	(.14)	Bfat <b>+.03</b>	(.27)		

**DAM**

Age	2
Wt	780
Wean Pct.	64%
Cow Eff.	134

★★★★★ for Low Maintenance, Growth, Marbling, High Cow Efficiency, Calving Ease, Stayability.

**B-1 BIEBER ROOSEVELT W384**  
1-A 100% # 1311829 Tattoo: RAB9 W384

Birth: 3-1-09	Basin Trend Setter 6074	Red Brylor New Trend 22	BWt <b>NA</b>
		Basin Rose F521	WR <b>NA</b>
<b>BIEBER ROUGH RIDER 10712</b>	Bieber Adelle 8958	Bieber Titan 6894	ADG <b>NA</b>
Ref.		Bieber Adelle 7226	YR <b>NA</b>
	C A Future Direction 5321	G A R Precision 1680	Scr. <b>NA</b>
<b>BIEBER SHEBA 9602</b>	Bieber Sheba 5537	C A Miss Power Fix 308	Fr. <b>NA</b>
		JHE Canyon Hawk 1062	
		Bieber Sheba 4404	

RAAA HerdBuilder index: **130** (Top 31% of all RA bulls)  
 RAAA GridMaster index: **52** (Top 30% of all RA bulls)

Calv.Ease	BW	WW	YW	Milk	HPG	Stay	Maint.En.
EPDs <b>5</b>	<b>0.5</b>	<b>54</b>	<b>77</b>	<b>29</b>	<b>13</b>	<b>9</b>	<b>-10.0</b>
Acc. (.74)	(.85)	(.82)	(.83)	(.71)	(.25)	(.41)	(.68)
Marb <b>+.84</b>	(.43)	REA <b>+.29</b>	(.37)	Bfat <b>+.06</b>	(.47)		

**DAM**

Age	NA
Wt	NA
Wean Pct.	NA%
Cow Eff.	NA

★★★★★ #N/A

**D-1 BECKTON DOMINOR A378 W7**  
1-A 100% # 1626650 Tattoo: BKT3 A378

Birth: 3-26-13	Beckton Dominor W640 C5	Beckton Dominor Z1 R610	BWt <b>64</b>
		Beckton Mona R166 CQ	WR <b>100</b>
<b>BECKTON DOMINOR Y005 V6</b>	Beckton Belga W108 V	Beckton Vega P079	ADG <b>3.43</b>
Ref. D		Beckton Belga K476 JL	YR <b>104</b>
	Beckton Warrior T248 L5	Beckton Warrior N645 T1	Scr. <b>34</b>
<b>BECKTON LANA Y541 W</b>	Beckton Lana S074 EP	Beckton Kit R503 LN	Fr. <b>5.5</b>
		Beckton Epic KH P678	
		Beckton Lana P317 JL	

RAAA HerdBuilder index: **175** (Top 1% of all RA bulls)  
 RAAA GridMaster index: **51** (Top 13% of all RA bulls)

Calv.Ease	BW	WW	YW	Milk	HPG	Stay	Maint.En.
EPDs <b>9</b>	<b>-3.0</b>	<b>58</b>	<b>96</b>	<b>20</b>	<b>12</b>	<b>16</b>	<b>-2.8</b>
Acc. (.13)	(.31)	(.27)	(.28)	(.17)	(.02)	(.01)	(.20)
Marb <b>+.44</b>	(.15)	REA <b>+.32</b>	(.13)	Bfat <b>+.02</b>	(.28)		

**DAM**

Age	2
Wt	885
Wean Pct.	50%
Cow Eff.	106

★★★★★ for Low Maintenance, Marbling, Rib-eye area, Calving Ease, Stayability.

• Reference Sires •

**E-1 BECKTON EPIC X330 L6**  
1-A 100% # 1382765 Tattoo: BSF0 X330

Birth: 3-20-10	Beckton Epic K4 N795	Beckton Epic KJ J722	BWt	<b>71</b>
		Beckton Sierra J789 EP	WR	<b>103</b>
<b>BECKTON EPIC T330 L5</b>	Beckton Belga K202 LN	Beckton Lancer T A664	ADG	<b>3.71</b>
Ref. E		Beckton Belga D460 KR	YR	<b>108</b>
	Beckton Lancer F442 T	Beckton Lancer T A664	Scr.	<b>37</b>
<b>BECKTON KIT R503 LN</b>	Beckton Kit F468 JL	Bkt Suffeina A828 DM	Fr.	<b>5.5</b>
		Beckton Julian GG B571		
		Beckton Kit A517 NP		

RAAA HerdBuilder index: **124** (Top 19% of all RA bulls)

RAAA GridMaster index: **53** (Top 8% of all RA bulls)

<b>DAM</b>	Age	5	Calv.Ease	BW	WW	YW	Milk	HPG	Stay	Maint.En.	
	Wt	<b>940</b>	EPDs	<b>9</b>	<b>-3.8</b>	<b>59</b>	<b>98</b>	<b>19</b>	<b>6</b>	<b>13</b>	<b>-3.8</b>
	Wean Pct.	<b>65%</b>	Acc.	(.41)	(.67)	(.60)	(.59)	(.38)	(.16)	(.10)	(.55)
	Cow Eff.	<b>137</b>	Marb	<b>+0.66</b>	(.26)	REA	<b>+0.35</b>	(.23)	Bfat	<b>+0.02</b>	(.36)

★★★★★ for Low Maintenance, Growth, Marbling, Rib-eye area, High Cow Efficiency, Calving Ease, Stayability.

**E-3 BECKTON EMPEROR Y459 J3**  
1-A 100% # 1451554 Tattoo: BKB1 Y459

Birth: 4-5-11	Beckton Emperor R100	Beckton Epic K4 N795	BWt	<b>72</b>
		Beckton Tamara N180 JO	WR	<b>102</b>
<b>BECKTON EMPEROR T641 E2</b>	Beckton Vernice R416 EP	Beckton Epic K3 M606	ADG	<b>3.35</b>
Ref. E		Beckton Vernice K482 HD	YR	<b>103</b>
	Beckton Jet L P491	TR Julian LT151	Scr.	<b>36</b>
<b>BECKTON INDIGO S354 JT</b>	Beckton Indigo P676 LN	Beckton Minerva L278 LN	Fr.	<b>5.5</b>
		Beckton Lancer T5 L095		
		Beckton Indigo L588 LN		

RAAA HerdBuilder index: **129** (Top 14% of all RA bulls)

RAAA GridMaster index: **52** (Top 5% of all RA bulls)

<b>DAM</b>	Age	5	Calv.Ease	BW	WW	YW	Milk	HPG	Stay	Maint.En.	
	Wt	<b>1050</b>	EPDs	<b>14</b>	<b>-6.5</b>	<b>41</b>	<b>68</b>	<b>17</b>	<b>7</b>	<b>12</b>	<b>-7.7</b>
	Wean Pct.	<b>58%</b>	Acc.	(.31)	(.48)	(.41)	(.41)	(.25)	(.07)	(.10)	(.19)
	Cow Eff.	<b>122</b>	Marb	<b>+0.78</b>	(.17)	REA	<b>+0.15</b>	(.15)	Bfat	<b>-0.01</b>	(.29)

★★★★★ for Low Maintenance, Marbling, Rib-eye area, High Cow Efficiency, Calving Ease.

**E-2 BECKTON EPIC X464 L5**  
1-A 100% # 1382853 Tattoo: BSF0 X464

Birth: 3-27-10	Beckton Epic KM M115	Beckton Epic K F075	BWt	<b>73</b>
		Beckton Minerva F495 CH	WR	<b>117</b>
<b>BECKTON EPIC K6 S569</b>	Beckton Sierra N703 LM	Beckton Laramie L044	ADG	<b>4.14</b>
Ref. E		Beckton Sierra L887 LN	YR	<b>115</b>
	Beckton Lancer T3 J396	Beckton Lancer TL G626	Scr.	<b>39</b>
<b>BECKTON LANA M393 LN</b>	Beckton Lana F081 LN	Beckton Angel G356 HR	Fr.	<b>5.5</b>
		Beckton Lancer TS D390		
		Beckton Lana D550 CB		

RAAA HerdBuilder index: **130** (Top 16% of all RA bulls)

RAAA GridMaster index: **51** (Top 24% of all RA bulls)

<b>DAM</b>	Age	8	Calv.Ease	BW	WW	YW	Milk	HPG	Stay	Maint.En.	
	Wt	<b>1145</b>	EPDs	<b>10</b>	<b>-2.9</b>	<b>53</b>	<b>95</b>	<b>37</b>	<b>6</b>	<b>12</b>	<b>-2.4</b>
	Wean Pct.	<b>61%</b>	Acc.	(.39)	(.61)	(.53)	(.51)	(.35)	(.17)	(.15)	(.51)
	Cow Eff.	<b>128</b>	Marb	<b>+0.42</b>	(.21)	REA	<b>+0.25</b>	(.19)	Bfat	<b>-0.01</b>	(.32)

★★★★★ for Low Maintenance, Growth, Gainability, Marbling, Rib-eye area, High Cow Efficiency, Calving Ease.

**E-4 BECKTON EPIC Y484 N6**  
1-A 100% # 1451237 Tattoo: BKT1 Y484

Birth: 4-8-11	Beckton Epic K4 N795	Beckton Epic KJ J722	BWt	<b>77</b>
		Beckton Sierra J789 EP	WR	<b>116</b>
<b>BECKTON EPIC U749 D5</b>	Beckton Denise R308 DM	Beckton Dominor ZC M919	ADG	<b>3.60</b>
Ref. E		Beckton Denise L639 JL	YR	<b>116</b>
	Beckton Nebula P P707	Beckton Nebula M045	Scr.	<b>38</b>
<b>BECKTON LYDIA S069 NB</b>	Beckton Lydia P583 WR	Beckton Lana M809 EP	Fr.	<b>5.5</b>
		Beckton Warrior CL M686		
		Beckton Lydia M121 WR		

RAAA HerdBuilder index: **152** (Top 7% of all RA bulls)

RAAA GridMaster index: **53** (Top 11% of all RA bulls)

<b>DAM</b>	Age	5	Calv.Ease	BW	WW	YW	Milk	HPG	Stay	Maint.En.	
	Wt	<b>980</b>	EPDs	<b>10</b>	<b>-1.9</b>	<b>66</b>	<b>116</b>	<b>16</b>	<b>9</b>	<b>16</b>	<b>-1.4</b>
	Wean Pct.	<b>71%</b>	Acc.	(.31)	(.58)	(.48)	(.46)	(.26)	(.07)	(.06)	(.19)
	Cow Eff.	<b>149</b>	Marb	<b>+0.56</b>	(.18)	REA	<b>+0.45</b>	(.16)	Bfat	<b>+0.00</b>	(.30)

★★★★★ for Low Maintenance, Growth, Marbling, Rib-eye area, High Cow Efficiency, Calving Ease, Stayability.



Beckton Dominor A378 (D-1)

**E-5 BECKTON EMPEROR A165 W4**  
1-A 100% # 1626661 Tattoo: BKT3 A165

Birth: 3-17-13	Beckton Emperor T641 E2	Beckton Emperor R100	BWt	<b>62</b>
		Beckton Vernice R416 EP	WR	<b>115</b>
<b>BECKTON EMPEROR Y459 J3</b>	Beckton Indigo S354 JT	Beckton Jet L P491	ADG	<b>3.54</b>
Ref. E-3		Beckton Indigo P676 LN	YR	<b>112</b>
	Beckton Warrior U636 J5	Beckton Warrior N645 T1	Scr.	<b>34</b>
<b>BECKTON MINOLA Y634 W</b>	Beckton Minola S103 JL	Beckton Lydia H159 JL	Fr.	<b>6.0</b>
		Beckton Julian G3 P608		
		Beckton Minola P205 JC		

RAAA HerdBuilder index: **166** (Top 2% of all RA bulls)

RAAA GridMaster index: **54** (Top 1% of all RA bulls)

<b>DAM</b>	Age	2	Calv.Ease	BW	WW	YW	Milk	HPG	Stay	Maint.En.	
	Wt	<b>900</b>	EPDs	<b>14</b>	<b>-5.7</b>	<b>49</b>	<b>83</b>	<b>16</b>	<b>11</b>	<b>13</b>	<b>-1.6</b>
	Wean Pct.	<b>59%</b>	Acc.	(.14)	(.31)	(.27)	(.28)	(.17)	(.05)	(.02)	(.19)
	Cow Eff.	<b>123</b>	Marb	<b>+0.98</b>	(.15)	REA	<b>+0.05</b>	(.13)	Bfat	<b>-0.02</b>	(.26)

★★★★★ for Low Maintenance, Growth, Marbling, High Cow Efficiency, Calving Ease, Stayability.



• Reference Sires •

**E-6 BECKTON EPIC A286 E7**  
1-A 100% # 1626664 Tattoo: BKT3 A286

Birth: 3-22-13	Beckton Epic U749 D5	Beckton Epic K4 N795	BWt <b>60</b>
		Beckton Denise R308 DM	WR <b>98</b>
<b>BECKTON EPIC Y484 N6</b>	Beckton Lydia S069 NB	Beckton Nebula P P707	ADG <b>3.82</b>
Ref. E-4		Beckton Lydia P583 WR	YR <b>101</b>
	Beckton Epic U749 D5	Beckton Epic K4 N795	Scr. <b>35</b>
<b>BECKTON LARKABA Y648 E</b>	Beckton Larkaba U475 CT	Beckton Denise R308 DM	Fr. <b>5.0</b>
		BKT Clifftop TP R288	
		Beckton Larkaba R809 NB	

RAAA HerdBuilder index: **185** (Top 1% of all RA bulls)  
RAAA GridMaster index: **54** (Top 1% of all RA bulls)

Calv.Ease	BW	WW	YW	Milk	HPG	Stay	Maint.En.
EPDs <b>12</b>	<b>-5.1</b>	<b>51</b>	<b>94</b>	<b>20</b>	<b>8</b>	<b>16</b>	<b>-2.0</b>
Acc. (.13)	(.32)	(.28)	(.29)	(.17)	(.05)	(.02)	(.20)
Marb <b>+0.71</b>	(.15)	REA <b>+0.30</b>	(.13)	Bfat <b>+0.05</b>	(.27)		

**DAM**

Age	2
Wt	790
Wean Pct.	55%
Cow Eff.	116

★★★★★ for Low Maintenance, Marbling, Rib-eye area, High Cow Efficiency, Calving Ease, Stayability.

**H-2 BECKTON HERITAGE A767 C3**  
1-A 100% # 1626467 Tattoo: BKT3 A767

Birth: 4-13-13	Beckton Heritage N013	Beckton Hustler C2 L079	BWt <b>73</b>
		Beckton Lana L007 JL	WR <b>111</b>
<b>BECKTON HERITAGE X356 E2</b>	Beckton Lana S489 EP	Beckton Epic K4 N795	ADG <b>3.93</b>
Ref. H		Beckton Lana E136 TP	YR <b>111</b>
	BKT Clifftop TP R288	Beckton Clifftop T C075	Scr. <b>34</b>
<b>BECKTON ROSE W816 C</b>	Beckton Rose S487 LN	Beckton Christy K209 CO	Fr. <b>5.0</b>
		Beckton Lancer T9 N586	
		Beckton Rose L083 LN	

RAAA HerdBuilder index: **152** (Top 4% of all RA bulls)  
RAAA GridMaster index: **52** (Top 5% of all RA bulls)

Calv.Ease	BW	WW	YW	Milk	HPG	Stay	Maint.En.
EPDs <b>8</b>	<b>-2.7</b>	<b>57</b>	<b>92</b>	<b>19</b>	<b>7</b>	<b>13</b>	<b>-5.0</b>
Acc. (.15)	(.33)	(.29)	(.31)	(.20)	(.05)	(.06)	(.17)
Marb <b>+1.00</b>	(.17)	REA <b>+0.05</b>	(.15)	Bfat <b>+0.06</b>	(.29)		

**DAM**

Age	4
Wt	915
Wean Pct.	66%
Cow Eff.	138

★★★★★ for Low Maintenance, Growth, Marbling, High Cow Efficiency, Calving Ease, Stayability.

**E-7 BECKTON EPIC A587 N7**  
1-A 100% # 1625908 Tattoo: BSF3 A587

Birth: 4-2-13	Beckton Epic T330 L5	Beckton Epic K4 N795	BWt <b>90</b>
		Beckton Belga K202 LN	WR <b>102</b>
<b>BECKTON EPIC X330 L6</b>	Beckton Kit R503 LN	Beckton Lancer F442 T	ADG <b>3.93</b>
Ref. E-1		Beckton Kit F468 JL	YR <b>109</b>
	Beckton Nebula T252 L3	Beckton Nebula L P093	Scr. <b>34</b>
<b>BECKTON LANA W113 N</b>	Beckton Lana T226 NB	Beckton Vernice L382 LN	Fr. <b>5.5</b>
		Beckton Nebula E P084	
		Beckton Lana P026 DM	

RAAA HerdBuilder index: **170** (Top 1% of all RA bulls)  
RAAA GridMaster index: **52** (Top 9% of all RA bulls)

Calv.Ease	BW	WW	YW	Milk	HPG	Stay	Maint.En.
EPDs <b>6</b>	<b>-1.7</b>	<b>61</b>	<b>104</b>	<b>15</b>	<b>10</b>	<b>16</b>	<b>-7.1</b>
Acc. (.16)	(.33)	(.30)	(.31)	(.21)	(.09)	(.03)	(.18)
Marb <b>+0.46</b>	(.16)	REA <b>+0.34</b>	(.14)	Bfat <b>+0.00</b>	(.29)		

**DAM**

Age	4
Wt	955
Wean Pct.	55%
Cow Eff.	116

★★★★★ for Low Maintenance, Growth, Marbling, Rib-eye area, Calving Ease, Stayability.



Beckton Julian B571 (J-1)

**H-1 BECKTON HERITAGE X403 L3**  
1-A 100% # 1382810 Tattoo: BSF0 X403

Birth: 3-24-10	Beckton Heritage N013	Beckton Hustler C2 L079	BWt <b>68</b>
		Beckton Lana L007 JL	WR <b>106</b>
<b>BECKTON HERITAGE T270 J2</b>	Beckton Coca P602 JL	Beckton Julian GG B571	ADG <b>3.57</b>
Ref. H		Beckton Coca J270 CD	YR <b>105</b>
	Beckton Lancer TE F363	Beckton Lancer TA664	Scr. <b>37</b>
<b>BECKTON INDIGO H150 LN</b>	Beckton Indigo F376 CT	Beckton Lana Z275 ZN	Fr. <b>5.5</b>
		Beckton Clifftop T C075	
		Beckton Indigo A735 LN	

RAAA HerdBuilder index: **125** (Top 18% of all RA bulls)  
RAAA GridMaster index: **50** (Top 45% of all RA bulls)

Calv.Ease	BW	WW	YW	Milk	HPG	Stay	Maint.En.
EPDs <b>12</b>	<b>-4.8</b>	<b>66</b>	<b>100</b>	<b>18</b>	<b>9</b>	<b>13</b>	<b>-4.1</b>
Acc. (.42)	(.61)	(.54)	(.51)	(.35)	(.16)	(.15)	(.50)
Marb <b>+0.66</b>	(.20)	REA <b>-0.01</b>	(.18)	Bfat <b>+0.07</b>	(.31)		

**DAM**

Age	12
Wt	1045
Wean Pct.	59%
Cow Eff.	123

★★★★★ for Low Maintenance, Marbling, High Cow Efficiency, Calving Ease, Stayability.

**J-1 BECKTON JULIAN GG B571**  
1-A 100% # 387580 Tattoo: WF2 B571

Birth: 3-27-92	Beckton Julian 6592	Beckton Trojan 5253	BWt <b>65</b>
		Lchmn Christy 2339	WR <b>113</b>
<b>BECKTON JULIAN 7526G</b>	Bkt Belga 6746 GS	Beckton Gisa 4454	ADG <b>3.18</b>
Ref.		Beckton Lalaxigu -2	YR <b>112</b>
	Beckton Julian 7526G	Beckton Julian 6592	Scr. <b>NA</b>
<b>BKT MARTA 9A13 JL</b>	Bkt Marta 6498 XM	Bkt Belga 6746 GS	Fr. <b>5.0</b>
		Beckton Xime 4736	
		Beckton Marwa -K	

RAAA HerdBuilder index: **228** (Top 1% of all RA bulls)  
RAAA GridMaster index: **54** (Top 11% of all RA bulls)

Calv.Ease	BW	WW	YW	Milk	HPG	Stay	Maint.En.
EPDs <b>24</b>	<b>-6.2</b>	<b>28</b>	<b>55</b>	<b>15</b>	<b>13</b>	<b>21</b>	<b>-6.2</b>
Acc. (.92)	(.93)	(.92)	(.92)	(.91)	(.88)	(.82)	(.64)
Marb <b>+0.20</b>	(.89)	REA <b>+0.30</b>	(.89)	Bfat <b>+0.02</b>	(.90)		

**DAM**

Age	3
Wt	1015
Wean Pct.	56%
Cow Eff.	118

★★★★★ for Low Maintenance, Marbling, Rib-eye area, High Cow Efficiency, Calving Ease, Stayability.

• Reference Sires •

**J-2 BECKTON JULIAN X465 J5**  
1-A 100% # 1382724 Tattoo: BKT0 X465

Birth: 3-27-10	Beckton Julian GJ P535	Beckton Julian 7526G	BWt	<b>84</b>
	Beckton Minola P826 DM	Beckton Mona D086 JL	WR	<b>113</b>
<b>BECKTON JULIAN G5 S107</b>	Beckton Dominor ZC M919	Beckton Julian 7526G	ADG	<b>4.48</b>
Ref. J	Beckton Minola M641 WR	Bkt Marta 9A13 JL	YR	<b>114</b>
	Beckton Julian GG B571	Beckton Dominor 9455	Scr.	<b>39</b>
<b>BECKTON SUFFEINA P643 JL</b>	Bkt Suffeina A828 DM	Bkt Suffeina 9493 TT	Fr.	<b>5.5</b>

RAAA HerdBuilder index: **139**(Top 11% of all RA bulls)

RAAA GridMaster index: **52**(Top 13% of all RA bulls)

<b>DAM</b>	Calv.Ease	BW	WW	YW	Milk	HPG	Stay	Maint.En.
Age <b>6</b>	EPDs <b>8</b>	<b>0.4</b>	<b>69</b>	<b>115</b>	<b>16</b>	<b>14</b>	<b>16</b>	<b>-5.2</b>
Wt <b>1085</b>	Acc. (.42)	(.67)	(.60)	(.59)	(.38)	(.18)	(.10)	(.53)
Wean Pct. <b>62%</b>	Marb <b>+.95</b>	(.24)	REA <b>-.14</b>	(.21)	Bfat <b>+.03</b>	(.35)		
Cow Eff. <b>131</b>								

★★★★★ for Low Maintenance, Growth, Gainability, Marbling, High Cow Efficiency, Calving Ease, Stayability.

**J-5 BECKTON JULIAN A479 L6**  
1-A 100% # 1626506 Tattoo: BKT3 A479

Birth: 3-29-13	Beckton Julian G5 S107	Beckton Julian GJ P535	BWt	<b>74</b>
	Beckton Suffeina P643 JL	Beckton Minola P826 DM	WR	<b>118</b>
<b>BECKTON JULIAN X465 J5</b>	Beckton Julian GG B571	Beckton Julian 7526G	ADG	<b>3.32</b>
Ref. J-2	Bkt Suffeina A828 DM	Beckton Likable U120 L2	YR	<b>112</b>
	Beckton Likable S633	Beckton Eola U027 NB	Scr.	<b>38</b>
<b>BECKTON EOLA X216 L</b>	Beckton Lana S718 LN	Beckton Nebula EN S347	Fr.	<b>6.0</b>
	Beckton Eola S317 LO			

RAAA HerdBuilder index: **170** (Top 1% of all RA bulls)

RAAA GridMaster index: **52** (Top 8% of all RA bulls)

<b>DAM</b>	Calv.Ease	BW	WW	YW	Milk	HPG	Stay	Maint.En.
Age <b>3</b>	EPDs <b>8</b>	<b>-1.3</b>	<b>66</b>	<b>107</b>	<b>22</b>	<b>11</b>	<b>17</b>	<b>-7.6</b>
Wt <b>845</b>	Acc. (.17)	(.33)	(.30)	(.31)	(.21)	(.04)	(.17)	
Wean Pct. <b>69%</b>	Marb <b>+.76</b>	(.15)	REA <b>-.01</b>	(.13)	Bfat <b>+.06</b>	(.26)		
Cow Eff. <b>144</b>								

★★★★★ for Low Maintenance, Growth, Marbling, High Cow Efficiency, Calving Ease, Stayability.

**J-3 BECKTON JANUS X799 L2**  
1-A 100% # 1382654 Tattoo: BKT0 X799

Birth: 4-29-10	TR Romeo NT379	Buffalo Creek Romeo L081	BWt	<b>84</b>
	Beckton Belga K285 JL	Buf Crk Lass L420	WR	<b>109</b>
<b>BECKTON ROMAN J S158</b>	Beckton Julian GG B571	Beckton Belga G493 HR	ADG	<b>4.24</b>
Ref. O	Beckton Lancer TZ D525	Bkt Pine Marie D126 JL	YR	<b>110</b>
	Beckton Loki F251	Beckton Clipper JL A095	Scr.	<b>36</b>
<b>BECKTON SIERRA K557 LO</b>	Bkt Suffeina A828 DM	Beckton Sierra A086 CL	Fr.	<b>6.0</b>

RAAA HerdBuilder index: **111**(Top 29% of all RA bulls)

RAAA GridMaster index: **50**(Top 42% of all RA bulls)

<b>DAM</b>	Calv.Ease	BW	WW	YW	Milk	HPG	Stay	Maint.En.
Age <b>10</b>	EPDs <b>12</b>	<b>-3.3</b>	<b>46</b>	<b>79</b>	<b>33</b>	<b>3</b>	<b>11</b>	<b>6.7</b>
Wt <b>1120</b>	Acc. (.44)	(.64)	(.57)	(.57)	(.40)	(.18)	(.16)	(.53)
Wean Pct. <b>58%</b>	Marb <b>+.39</b>	(.23)	REA <b>+.12</b>	(.20)	Bfat <b>+.00</b>	(.35)		
Cow Eff. <b>122</b>								

★★★★★ for Growth, Gainability, Marbling, High Cow Efficiency, Calving Ease.

**J-6 BECKTON JULIAN A565 J4**  
1-A 100% # 1626028 Tattoo: BSF3 A565

Birth: 4-1-13	Beckton Julian 7526G	Beckton Julian 6592	BWt	<b>72</b>
	Bkt Marta 9A13 JL	Bkt Belga 6746 GS	WR	<b>110</b>
<b>BECKTON JULIAN GG B571</b>	Beckton Julian 7526G	Beckton Julian GG B571	ADG	<b>3.93</b>
Ref. J-1	Bkt Marta 6498 XM	Beckton Javelin 6587	YR	<b>110</b>
	Bkt Javelin 7466 R	Beckton Rose 6807 RZ	Scr.	<b>38</b>
<b>BECKTON BELGA X379 L</b>	Beckton Dominor ZC M919	Beckton Belga M883 DM	Fr.	<b>5.0</b>

RAAA HerdBuilder index: **169** (Top 1% of all RA bulls)

RAAA GridMaster index: **50**(Top 27% of all RA bulls)

<b>DAM</b>	Calv.Ease	BW	WW	YW	Milk	HPG	Stay	Maint.En.
Age <b>3</b>	EPDs <b>14</b>	<b>-4.1</b>	<b>50</b>	<b>79</b>	<b>22</b>	<b>12</b>	<b>17</b>	<b>-7.7</b>
Wt <b>910</b>	Acc. (.21)	(.34)	(.30)	(.32)	(.23)	(.13)	(.20)	(.04)
Wean Pct. <b>59%</b>	Marb <b>+.52</b>	(.26)	REA <b>+.06</b>	(.24)	Bfat <b>+.07</b>	(.34)		
Cow Eff. <b>124</b>								

★★★★★ for Low Maintenance, Growth, Marbling, High Cow Efficiency, Calving Ease, Stayability.

**J-4 BECKTON JULIAN Z382 J7**  
1-A 100% # 1544962 Tattoo: BKT2 Z382

Birth: 3-20-12	Beckton Julian U699 L5	Beckton Julian G1 J526	BWt	<b>47</b>
	Beckton Lana U329 EP	Beckton Rose L311 LN	WR	<b>125</b>
<b>BECKTON JULIAN X721 E6</b>	Beckton Epic K6 S569	Beckton Lana S477 LN	ADG	<b>2.99</b>
Ref. J	Beckton Julian U699 L5	Beckton Julian G1 J526	YR	<b>113</b>
	Beckton Larkaba X064 J	Beckton Rose L311 LN	Scr.	<b>33</b>
<b>BECKTON LARKABA X064 J</b>	Beckton Larkaba U475 CT	BKT Clifftop TP R288	Fr.	<b>5.0</b>
		Beckton Larkaba R809 NB		

RAAA HerdBuilder index: **202** (Top 1% of all RA bulls)

RAAA GridMaster index: **52**(Top 10% of all RA bulls)

<b>DAM</b>	Calv.Ease	BW	WW	YW	Milk	HPG	Stay	Maint.En.
Age <b>2</b>	EPDs <b>15</b>	<b>-8.5</b>	<b>53</b>	<b>84</b>	<b>29</b>	<b>13</b>	<b>16</b>	<b>-9.9</b>
Wt <b>755</b>	Acc. (.17)	(.34)	(.30)	(.34)	(.16)	(.06)	(.02)	(.21)
Wean Pct. <b>80%</b>	Marb <b>+.37</b>	(.15)	REA <b>+.33</b>	(.14)	Bfat <b>+.03</b>	(.12)		
Cow Eff. <b>168</b>								

★★★★★ for Low Maintenance, Growth, Marbling, Rib-eye area, High Cow Efficiency, Calving Ease, Stayability.

**L-1 BECKTON LIKABLE U130 L2**  
1-A 100% # 1258774 Tattoo: BKT8 U130

Birth: 3-6-08	Beckton Lancer F442 T	Beckton Lancer T A664	BWt	<b>68</b>
	Beckton Kit F468 JL	Bkt Suffeina A828 DM	WR	<b>100</b>
<b>BECKTON LIKABLE S633</b>	Beckton Lancer F442 T	Beckton Julian GG B571	ADG	<b>3.93</b>
Ref. L	Bkt Suffeina A828 DM	Beckton Kit A517 NP	YR	<b>104</b>
	Beckton Larkaba X064 J	Beckton Lancer T A664	Scr.	<b>35</b>
<b>BECKTON KIT S478 LN</b>	Beckton Kit F468 JL	Bkt Suffeina A828 DM	Fr.	<b>5.0</b>
		Beckton Julian GG B571		
		Beckton Kit A517 NP		

RAAA HerdBuilder index: **124**(Top 19% of all RA bulls)

RAAA GridMaster index: **51**(Top 26% of all RA bulls)

<b>DAM</b>	Calv.Ease	BW	WW	YW	Milk	HPG	Stay	Maint.En.
Age <b>2</b>	EPDs <b>8</b>	<b>-3.4</b>	<b>59</b>	<b>89</b>	<b>13</b>	<b>8</b>	<b>15</b>	<b>-4.7</b>
Wt <b>875</b>	Acc. (.61)	(.68)	(.65)	(.65)	(.53)	(.08)	(.13)	(.65)
Wean Pct. <b>54%</b>	Marb <b>+.43</b>	(.28)	REA <b>+.78</b>	(.25)	Bfat <b>+.05</b>	(.38)		
Cow Eff. <b>115</b>								

★★★★★ for Low Maintenance, Marbling, Rib-eye area, Calving Ease, Stayability.

• Reference Sires •

**L-2 BECKTON LIKABLE Y124 L3**  
1-A 100% # 1451666 Tattoo: BSF1 Y124

Birth: 3-15-11	Beckton Likable S633	Beckton Lancer F442 T	BWt <b>72</b>
		Beckton Kit F468 JL	WR <b>109</b>
<b>BECKTON LIKABLE U130 L2</b>	Beckton Lancer F442 T	Beckton Kit F468 JL	ADG <b>3.50</b>
Ref. L-1	Beckton Kit S478 LN	Beckton Lancer T1 H080	YR <b>112</b>
		Beckton Ruth G534 NP	Scr. <b>38</b>
	Beckton Lasso P741	Beckton Lancer T4 J536	Fr. <b>5.5</b>
<b>BKT PINE MARIE S802 LO</b>	Bkt Pine Marie P475 LN	Bkt Pine Marie LC30 CD	

RAAA HerdBuilder index: **142** (Top 9% of all RA bulls)  
RAAA GridMaster index: **53** (Top 11% of all RA bulls)

Calv.Ease	BW	WW	YW	Milk	HPG	Stay	Maint.En.
EPDs <b>11</b>	<b>-5.9</b>	<b>47</b>	<b>80</b>	<b>21</b>	<b>11</b>	<b>14</b>	<b>-1.8</b>
Acc. (.34)	(.56)	(.47)	(.46)	(.25)	(.06)	(.19)	
Marb <b>+.73</b>	(.17)	REA <b>+.21</b>	(.15)	Bfat <b>+.06</b>	(.29)		

**DAM**

Age	<b>5</b>
Wt	<b>1080</b>
Wean Pct.	<b>58%</b>
Cow Eff.	<b>121</b>

★★★★★ for Low Maintenance, Growth, Marbling, Rib-eye area, High Cow Efficiency, Calving Ease, Stayability.

**N-1 BECKTON NEBULA P P707**  
1-A 100% # 979031 Tattoo: BKT4 P707

Birth: 4-1-04	Beckton Neptune R2 K065	Beckton Neptune RR B284	BWt <b>68</b>
		Beckton Lana C735 TP	WR <b>127</b>
<b>BECKTON NEBULA M045</b>	Beckton Julian GG B571	Beckton Belga G493 HR	ADG <b>3.85</b>
Ref. N	Beckton Belga K285 JL	Beckton Epic KN H110	YR <b>122</b>
		Beckton Rose H019 SC	Scr. <b>37</b>
	Beckton Epic K1 K863	Beckton Dominor ZJ H657	Fr. <b>5.0</b>
<b>BECKTON LANA M809 EP</b>	Beckton Lana K253 DM	Beckton Lana HA34 DM	

RAAA HerdBuilder index: **212** (Top 2% of all RA bulls)  
RAAA GridMaster index: **57** (Top 1% of all RA bulls)

Calv.Ease	BW	WW	YW	Milk	HPG	Stay	Maint.En.
EPDs <b>17</b>	<b>-6.3</b>	<b>60</b>	<b>105</b>	<b>19</b>	<b>10</b>	<b>16</b>	<b>-3.0</b>
Acc. (.89)	(.90)	(.90)	(.90)	(.88)	(.66)	(.51)	(.70)
Marb <b>+.97</b>	(.61)	REA <b>-.34</b>	(.58)	Bfat <b>+.02</b>	(.60)		

**DAM**

Age	<b>2</b>
Wt	<b>890</b>
Wean Pct.	<b>71%</b>
Cow Eff.	<b>150</b>

★★★★★ for Low Maintenance, Growth, Marbling, High Cow Efficiency, Calving Ease, Stayability.

**L-3 BECKTON LIKABLE Y362 L3**  
1-A 100% # 1451148 Tattoo: BKT1 Y362

Birth: 3-28-11	Beckton Likable S633	Beckton Lancer F442 T	BWt <b>79</b>
		Beckton Kit F468 JL	WR <b>108</b>
<b>BECKTON LIKABLE U130 L2</b>	Beckton Lancer F442 T	Beckton Kit F468 JL	ADG <b>4.00</b>
Ref. L-1	Beckton Kit S478 LN	Beckton Lancer TA A664	YR <b>113</b>
		Beckton Tamara B570 JL	Scr. <b>35</b>
	Beckton Lancer TA K644	Beckton Lancer T A664	Fr. <b>5.5</b>
<b>BECKTON TAMARA M515 LN</b>	Beckton Tamara K322 LN	Beckton Tamara G124 CH	

RAAA HerdBuilder index: **130** (Top 13% of all RA bulls)  
RAAA GridMaster index: **52** (Top 5% of all RA bulls)

Calv.Ease	BW	WW	YW	Milk	HPG	Stay	Maint.En.
EPDs <b>9</b>	<b>-3.3</b>	<b>56</b>	<b>97</b>	<b>16</b>	<b>9</b>	<b>14</b>	<b>-0.6</b>
Acc. (.35)	(.44)	(.37)	(.38)	(.24)	(.07)	(.08)	(.19)
Marb <b>+.82</b>	(.19)	REA <b>+.31</b>	(.17)	Bfat <b>+.08</b>	(.31)		

**DAM**

Age	<b>9</b>
Wt	<b>1200</b>
Wean Pct.	<b>55%</b>
Cow Eff.	<b>115</b>

★★★★★ for Low Maintenance, Growth, Gainability, Marbling, Rib-eye area, Calving Ease, Stayability.



Beckton Nebula P707

**L-4 BECKTON LIKABLE A306 L3**  
1-A 100% # 1626174 Tattoo: BKT3 A306

Birth: 3-23-13	Beckton Likable S633	Beckton Lancer F442 T	BWt <b>75</b>
		Beckton Kit F468 JL	WR <b>105</b>
<b>BECKTON LIKABLE U120 L2</b>	Beckton Lancer F442 T	Beckton Lana F891 JL	ADG <b>4.10</b>
Ref. L	Beckton Lana S718 LN	Beckton Lancer TZ D525	YR <b>111</b>
		Bkt Pine Marie D126 JL	Scr. <b>37</b>
	Beckton Loki F251	Beckton Herald D B437	Fr. <b>5.0</b>
<b>BECKTON LANA N869 LO</b>	Beckton Lana D232 HV	Beckton Lana B354 KR	

RAAA HerdBuilder index: **148** (Top 5% of all RA bulls)  
RAAA GridMaster index: **52** (Top 9% of all RA bulls)

Calv.Ease	BW	WW	YW	Milk	HPG	Stay	Maint.En.
EPDs <b>9</b>	<b>-3.1</b>	<b>49</b>	<b>83</b>	<b>28</b>	<b>4</b>	<b>15</b>	<b>-8.8</b>
Acc. (.22)	(.34)	(.32)	(.33)	(.25)	(.14)	(.14)	(.19)
Marb <b>+.67</b>	(.19)	REA <b>+.28</b>	(.17)	Bfat <b>+.03</b>	(.30)		

**DAM**

Age	<b>10</b>
Wt	<b>1100</b>
Wean Pct.	<b>53%</b>
Cow Eff.	<b>112</b>

★★★★★ for Low Maintenance, Growth, Gainability, Marbling, Rib-eye area, Calving Ease, Stayability.

**N-2 BECKTON NEBULA EN S347**  
1-A 100% # 1118810 Tattoo: WF6 S347

Birth: 3-13-06	Beckton Nebula M045	Beckton Neptune R2 K065	BWt <b>55</b>
		Beckton Belga K285 JL	WR <b>97</b>
<b>BECKTON NEBULA E P084</b>	Beckton Epic K F075	Bkt Pine Marie D126 JL	ADG <b>4.13</b>
Ref. N	Bkt Pine Marie M119 EP	Beckton Neptune R2 K065	YR <b>97</b>
		Beckton Belga K285 JL	Scr. <b>NA</b>
	Beckton Nebula M045	Beckton Epic K1 K863	Fr. <b>4.5</b>
<b>BECKTON EOLA P530 NB</b>	Beckton Eola M663 EP	Beckton Eola K178 EP	

RAAA HerdBuilder index: **176** (Top 2% of all RA bulls)  
RAAA GridMaster index: **51** (Top 28% of all RA bulls)

Calv.Ease	BW	WW	YW	Milk	HPG	Stay	Maint.En.
EPDs <b>20</b>	<b>-9.0</b>	<b>42</b>	<b>58</b>	<b>28</b>	<b>17</b>	<b>15</b>	<b>-8.1</b>
Acc. (.60)	(.67)	(.64)	(.65)	(.56)	(.37)	(.01)	(.63)
Marb <b>+.95</b>	(.27)	REA <b>-.45</b>	(.24)	Bfat <b>+.05</b>	(.37)		

**DAM**

Age	<b>2</b>
Wt	<b>750</b>
Wean Pct.	<b>60%</b>
Cow Eff.	<b>127</b>

★★★★★ for Low Maintenance, Gainability, Marbling, High Cow Efficiency, Calving Ease, Stayability.



• Reference Sires •

**N-3 BECKTON NEBULA X096 N4**  
1-A 100% # 1383327 Tattoo: BKT0 X096

Birth: 2-28-10	Beckton Nebula P P707	Beckton Nebula M045	BWt	<b>67</b>
		Beckton Lana M809 EP	WR	<b>121</b>
<b>BECKTON NEBULA U206 V3</b>	Beckton Minerva J615 VG	Beckton Vegas PK F485	ADG	<b>3.76</b>
Ref. N		Beckton Minerva F433 VG	YR	<b>116</b>
	Beckton Nebula P P707	Beckton Nebula M045	Scr.	<b>34</b>
<b>BECKTON TAMARA U185 NB</b>	Beckton Lana M809 EP	Beckton Lana M809 EP	Fr.	<b>5.5</b>
	Beckton Tamara P813 CH	Beckton Champ R3 H338		
		Beckton Tamara H625 CH		

RAAA HerdBuilder index: **172** (Top 2% of all RA bulls)  
RAAA GridMaster index: **52** (Top 13% of all RA bulls)

	Calv.Ease	BW	WW	YW	Milk	HPG	Stay	Maint.En.
EPDs	<b>9</b>	<b>-2.4</b>	<b>63</b>	<b>104</b>	<b>21</b>	<b>10</b>	<b>19</b>	<b>2.3</b>
Acc.	(.43)	(.56)	(.52)	(.52)	(.39)	(.07)	(.04)	(.55)
	Marb <b>+.54</b>	(.23)	REA <b>+.10</b>	(.20)	Bfat <b>-.01</b>	(.33)		

**DAM**

Age	<b>2</b>
Wt	<b>818</b>
Wean Pct.	<b>71%</b>
Cow Eff.	<b>150</b>



Beckton Nebula X096 (N-3)

★★★★★ for Low Maintenance, Growth, Marbling, High Cow Efficiency, Calving Ease, Stayability.

**N-4 BECKTON NEW ERA Y194**  
1-A 100% # 1451309 Tattoo: BSF1 Y194

Birth: 3-20-11	Beckton Nebula M045	Beckton Neptune R2 K065	BWt	<b>67</b>
		Beckton Belga K285 JL	WR	<b>132</b>
<b>BECKTON NEBULA P P707</b>	Beckton Lana M809 EP	Beckton Epic K1 K863	ADG	<b>3.50</b>
Ref. N-1		Beckton Lana K253 DM	YR	<b>121</b>
	Beckton Justice C1 R483	Beckton Justice CH M056	Scr.	<b>36</b>
<b>BKT LARKEISA T310 JC</b>	Beckton Tamara J124 HR	Beckton Justice C K449	Fr.	<b>5.5</b>
	BKT Larkeisa R775 JC	BKT Larkeisa L149 CK		

RAAA HerdBuilder index: **163** (Top 4% of all RA bulls)  
RAAA GridMaster index: **52** (Top 13% of all RA bulls)

	Calv.Ease	BW	WW	YW	Milk	HPG	Stay	Maint.En.
EPDs	<b>12</b>	<b>-4.2</b>	<b>71</b>	<b>120</b>	<b>21</b>	<b>10</b>	<b>15</b>	<b>-3.1</b>
Acc.	(.42)	(.75)	(.67)	(.63)	(.31)	(.31)	(.42)	(.19)
	Marb <b>+.70</b>	(.38)	REA <b>-.21</b>	(.32)	Bfat <b>+.04</b>	(.41)		

**DAM**

Age	<b>4</b>
Wt	<b>950</b>
Wean Pct.	<b>82%</b>
Cow Eff.	<b>174</b>

★★★★★ for Low Maintenance, Growth, Marbling, High Cow Efficiency, Calving Ease, Stayability.

**N-6 BECKTON NEBULA A773 L4**  
1-A 100% # 1625980 Tattoo: BSF3 A773

Birth: 4-13-13	Beckton Nebula L P093	Beckton Nebula M045	BWt	<b>66</b>
		Beckton Marta M021 LN	WR	<b>118</b>
<b>BECKTON NEBULA T398 V3</b>	Beckton Minerva J615 VG	Beckton Vegas PK F485	ADG	<b>3.54</b>
Ref. N		Beckton Minerva F433 VG	YR	<b>109</b>
	Beckton Likable U130 L2	Beckton Likable S633	Scr.	<b>36</b>
<b>BECKTON MONA X022 L</b>	Beckton Kit S478 LN	Beckton Cody K2 R168	Fr.	<b>5.5</b>
	Beckton Mona U584 CD	Beckton Mona P539 CH		

RAAA HerdBuilder index: **175** (Top 1% of all RA bulls)  
RAAA GridMaster index: **51** (Top 11% of all RA bulls)

	Calv.Ease	BW	WW	YW	Milk	HPG	Stay	Maint.En.
EPDs	<b>10</b>	<b>-4.0</b>	<b>62</b>	<b>97</b>	<b>18</b>	<b>11</b>	<b>17</b>	<b>-2.7</b>
Acc.	(.20)	(.33)	(.30)	(.31)	(.23)	(.08)	(.06)	(.04)
	Marb <b>+.30</b>	(.18)	REA <b>+.26</b>	(.15)	Bfat <b>+.01</b>	(.28)		

**DAM**

Age	<b>3</b>
Wt	<b>955</b>
Wean Pct.	<b>61%</b>
Cow Eff.	<b>128</b>

★★★★★ for Low Maintenance, Growth, Marbling, Rib-eye area, High Cow Efficiency, Calving Ease, Stayability.

**N-5 BECKTON NEW ERA A395 L2**  
1-A 100% # 1626055 Tattoo: BSF3 A395

Birth: 3-26-13	Beckton Nebula P P707	Beckton Nebula M045	BWt	<b>72</b>
		Beckton Lana M809 EP	WR	<b>113</b>
<b>BECKTON NEW ERA Y194</b>	Beckton Justice C1 R483	Beckton Justice C1 R483	ADG	<b>3.99</b>
Ref. N-4	BKT Larkeisa T310 JC	BKT Larkeisa R775 JC	YR	<b>109</b>
	Beckton Legend U331 E2	Beckton Legend S670	Scr.	<b>35</b>
<b>BECKTON MINERVA X612 L</b>	Beckton Lana S669 EP	Beckton Nebula PJ S543	Fr.	<b>5.0</b>
	Beckton Minerva U313 NB	Beckton Minerva S839 HW		

RAAA HerdBuilder index: **188** (Top 1% of all RA bulls)  
RAAA GridMaster index: **52** (Top 5% of all RA bulls)

	Calv.Ease	BW	WW	YW	Milk	HPG	Stay	Maint.En.
EPDs	<b>11</b>	<b>-4.4</b>	<b>64</b>	<b>105</b>	<b>17</b>	<b>6</b>	<b>13</b>	<b>-0.7</b>
Acc.	(.14)	(.33)	(.29)	(.30)	(.18)	(.12)	(.09)	(.21)
	Marb <b>+.67</b>	(.17)	REA <b>+.16</b>	(.15)	Bfat <b>+.03</b>	(.27)		

**DAM**

Age	<b>3</b>
Wt	<b>925</b>
Wean Pct.	<b>59%</b>
Cow Eff.	<b>123</b>

★★★★★ for Low Maintenance, Growth, Marbling, Rib-eye area, High Cow Efficiency, Calving Ease, Stayability.

**S-1 BECKTON SCAMP X458 H3**  
1-A 100% # 1382759 Tattoo: BKT0 X458

Birth: 3-26-10	Beckton Scamp 8954	Beckton Julian 7526G	BWt	<b>80</b>
		Bkt Kusi Annie 5462	WR	<b>105</b>
<b>BECKTON SCAMP T A825</b>	Bkt Encino 8459 TJ	Beckton Trojan 7061P	ADG	<b>4.19</b>
Ref. S		BCH Kit 7132-784	YR	<b>111</b>
	Beckton Hustler C2 L079	Beckton Hustler CN J102	Scr.	<b>38</b>
<b>BKT PINE MARIE R401 HU</b>	Bkt Pine Marie LC30 CD	Beckton Barmaid J012 CO	Fr.	<b>6.0</b>
		Beckton Cody V E023		
		Bkt Pine Marie D764 HD		

RAAA HerdBuilder index: **131** (Top 29% of all RA bulls)  
RAAA GridMaster index: **50** (Top 56% of all RA bulls)

	Calv.Ease	BW	WW	YW	Milk	HPG	Stay	Maint.En.
EPDs	<b>10</b>	<b>-4.2</b>	<b>48</b>	<b>80</b>	<b>21</b>	<b>12</b>	<b>10</b>	<b>-8.6</b>
Acc.	(.50)	(.59)	(.56)	(.55)	(.46)	(.19)	(.20)	(.57)
	Marb <b>+.38</b>	(.25)	REA <b>+.05</b>	(.23)	Bfat <b>-.01</b>	(.33)		

**DAM**

Age	<b>5</b>
Wt	<b>1270</b>
Wean Pct.	<b>49%</b>
Cow Eff.	<b>104</b>

★★★★★ for Low Maintenance, Growth, Gainability, Marbling, Calving Ease.

• Reference Sires •

**S-2 BECKTON SCAMP X494 E3**  
1-A 100% # 1382791 Tattoo: BKT0 X494

Birth: 3-28-10	Beckton Scamp 8954	Beckton Julian 7526G	Bwt	<b>78</b>
	Beckton Scamp T A825	Bkt Kusi Annie 5462	WR	<b>116</b>
	Ref. S	Beckton Trojan 7061P	ADG	<b>3.67</b>
	Bkt Encino 8459 TJ	BCH Kit 7132-784	YR	<b>110</b>
	Beckton Epic KH P678	Beckton Epic K F075	Scr.	<b>40</b>
<b>BECKTON LANA S074 EP</b>	Beckton Lana P317 JL	BKT Larkeisa L274 HU	Fr.	<b>5.5</b>
		Beckton Julian G2 M345		
		Beckton Lana M078 LN		

RAAA HerdBuilder index: **123**(Top 19% of all RA bulls)

RAAA GridMaster index: **49**(Top 48% of all RA bulls)

<b>DAM</b>	Calv.Ease	BW	WW	YW	Milk	HPG	Stay	Maint.En.
Age 4	EPDs <b>12</b>	<b>-5.1</b>	<b>50</b>	<b>78</b>	<b>27</b>	<b>11</b>	<b>12</b>	<b>-9.9</b>
Wt <b>1060</b>	Acc. (.47)	(.70)	(.63)	(.62)	(.43)	(.10)	(.18)	(.57)
Wean Pct. <b>63%</b>	Marb <b>+.25</b>	(.28)	REA <b>+.04</b>	(.25)	Bfat <b>+.00</b>	(.38)		
Cow Eff. <b>133</b>								

★★★★★ for Low Maintenance, Growth, Marbling, High Cow Efficiency, Calving Ease.

**S-5 BECKTON SCAMP A633 C4**  
1-A 100% # 1626208 Tattoo: BKT3 A633

Birth: 4-4-13	Beckton Scamp T A825	Beckton Scamp 8954	Bwt	<b>86</b>
	<b>BECKTON SCAMP X494 E3</b>	Bkt Encino 8459 TJ	WR	<b>112</b>
	Ref. S-2	Beckton Epic KH P678	ADG	<b>3.15</b>
	Beckton Lana S074 EP	Beckton Lana P317 JL	YR	<b>105</b>
	Beckton Clifftop T3 N800	Bkt Clifftop TV G672	Scr.	<b>36</b>
<b>BECKTON ROSE R507 CT</b>	Beckton Lana J384 CD	Beckton Lancer T5 L095	Fr.	<b>6.0</b>
	Beckton Rose N125 LN	Beckton Rose L311 LN		

RAAA HerdBuilder index: **135**(Top 10% of all RA bulls)

RAAA GridMaster index: **50**(Top 21% of all RA bulls)

<b>DAM</b>	Calv.Ease	BW	WW	YW	Milk	HPG	Stay	Maint.En.
Age 8	EPDs <b>6</b>	<b>-1.4</b>	<b>58</b>	<b>89</b>	<b>21</b>	<b>8</b>	<b>13</b>	<b>-1.3</b>
Wt <b>1310</b>	Acc. (.19)	(.34)	(.31)	(.32)	(.23)	(.08)	(.10)	(.18)
Wean Pct. <b>46%</b>	Marb <b>+.40</b>	(.17)	REA <b>+.14</b>	(.15)	Bfat <b>-.02</b>	(.29)		
Cow Eff. <b>96</b>								

★★★★★ for Low Maintenance, Marbling, Rib-eye area, Calving Ease, Stayability.

**S-3 BECKTON SCAMP A626 H3**  
1-A 100% # 1626307 Tattoo: BKT3 A626

Birth: 4-4-13	Beckton Scamp 8954	Beckton Julian 7526G	Bwt	<b>80</b>
	<b>BECKTON SCAMP T A825</b>	BKT Kusi Annie 5462	WR	<b>121</b>
	Ref. S	Beckton Trojan 7061P	ADG	<b>3.15</b>
	BKT Encino 8459 TJ	BCH Kit 7132-784	YR	<b>108</b>
	Beckton Hilltop R157	Beckton Clifftop T3 N800	Scr.	<b>38</b>
<b>BECKTON ROSE T770 HI</b>	Beckton Lana N869 LO	Beckton Clifftop T3 N800	Fr.	<b>5.5</b>
	Beckton Rose R507 CT	Beckton Rose N125 LN		

RAAA HerdBuilder index: **131**(Top 13% of all RA bulls)

RAAA GridMaster index: **50**(Top 24% of all RA bulls)

<b>DAM</b>	Calv.Ease	BW	WW	YW	Milk	HPG	Stay	Maint.En.
Age 6	EPDs <b>9</b>	<b>-3.7</b>	<b>49</b>	<b>76</b>	<b>23</b>	<b>6</b>	<b>12</b>	<b>-6.2</b>
Wt <b>1185</b>	Acc. (.20)	(.34)	(.31)	(.32)	(.24)	(.10)	(.17)	(.19)
Wean Pct. <b>54%</b>	Marb <b>+.37</b>	(.22)	REA <b>+.04</b>	(.20)	Bfat <b>+.00</b>	(.32)		
Cow Eff. <b>114</b>								

★★★★★ for Low Maintenance, Growth, Marbling, Calving Ease.

**V-1 BECKTON NOMAD V 9871**  
1-A 100% # 314536 Tattoo: WF9 9871

Birth: 3-16-89	Beckton Neva 5562	Beckton Pine 2778-8	Bwt	<b>60</b>
	<b>BECKTON NOMAD 7496</b>	Bkt Mona 1634-1549	WR	<b>103</b>
	Ref. V	Thunderbolt	ADG	<b>3.05</b>
	Bkt Bolt Tamrck 3913	MD 373 RC 523	YR	<b>99</b>
	Beckton Varo 5642	Beckton Neva 3901	Scr.	<b>NA</b>
<b>BKT BARMAID 6986 VR</b>	Bkt Lahrogno-3	Bkt Bolt Tamrck 3913	Fr.	<b>NA</b>
		Bkt Brmn1375-RM		

RAAA HerdBuilder index: **132**(Top 29% of all RA bulls)

RAAA GridMaster index: **52**(Top 27% of all RA bulls)

<b>DAM</b>	Calv.Ease	BW	WW	YW	Milk	HPG	Stay	Maint.En.
Age 6	EPDs <b>15</b>	<b>-6.4</b>	<b>11</b>	<b>5</b>	<b>12</b>	<b>4</b>	<b>4</b>	<b>-18.0</b>
Wt <b>1020</b>	Acc. (.73)	(.80)	(.77)	(.76)	(.73)	(.47)	(.59)	(.52)
Wean Pct. <b>53%</b>	Marb <b>+.11</b>	(.56)	REA <b>-.23</b>	(.53)	Bfat <b>+.02</b>	(.42)		
Cow Eff. <b>110</b>								

★★★★★ for Low Maintenance, Marbling, Calving Ease.

**S-4 BECKTON SCAMP A627 J4**  
1-A 100% # 1626192 Tattoo: BKT3 A627

Birth: 4-4-13	Beckton Scamp T A825	Beckton Scamp 8954	Bwt	<b>64</b>
	<b>BECKTON SCAMP X494 E3</b>	Bkt Encino 8459 TJ	WR	<b>105</b>
	Ref. S-2	Beckton Epic KH P678	ADG	<b>4.10</b>
	Beckton Lana S074 EP	Beckton Lana P317 JL	YR	<b>111</b>
	Beckton Justice Cc N265	Beckton Justice C K449	Scr.	<b>33</b>
<b>BECKTON SERENA R023 JC</b>	Beckton Rose H303 CL	Beckton Justice G302	Fr.	<b>5.0</b>
	Beckton Serena N469 JC	Beckton Serena D128 NP		

RAAA HerdBuilder index: **130**(Top 13% of all RA bulls)

RAAA GridMaster index: **51**(Top 13% of all RA bulls)

<b>DAM</b>	Calv.Ease	BW	WW	YW	Milk	HPG	Stay	Maint.En.
Age 8	EPDs <b>12</b>	<b>-4.4</b>	<b>56</b>	<b>90</b>	<b>17</b>	<b>11</b>	<b>12</b>	<b>-7.1</b>
Wt <b>1160</b>	Acc. (.18)	(.34)	(.31)	(.32)	(.23)	(.06)	(.02)	(.18)
Wean Pct. <b>49%</b>	Marb <b>+.38</b>	(.17)	REA <b>+.16</b>	(.16)	Bfat <b>+.03</b>	(.29)		
Cow Eff. <b>102</b>								

★★★★★ for Low Maintenance, Growth, Gainability, Marbling, Rib-eye area, Calving Ease.

**V-2 BECKTON NOMAD T 9A14**  
1-A 100% # 314614 Tattoo: WF9 9A14

Birth: 3-28-89	Beckton Neva 5562	Beckton Pine 2778-8	Bwt	<b>67</b>
	<b>BECKTON NOMAD 7496</b>	Bkt Mona 1634-1549	WR	<b>100</b>
	Ref. V	Thunderbolt	ADG	<b>2.81</b>
	Bkt Bolt Tamrck 3913	MD 373 RC 523	YR	<b>97</b>
	Beckton Trojan 5253	Beckton Dito 4374	Scr.	<b>NA</b>
<b>BECKTON LANA 7152 TJ</b>	Bkt Signal Lana 5599	Bkt Mana Anexa 4473	Fr.	<b>NA</b>
		Beckton Kusi 4879		
		Bkt Xima Lana 4770		

RAAA HerdBuilder index: **131**(Top 30% of all RA bulls)

RAAA GridMaster index: **49**(Top 71% of all RA bulls)

<b>DAM</b>	Calv.Ease	BW	WW	YW	Milk	HPG	Stay	Maint.En.
Age 6	EPDs <b>16</b>	<b>-7.3</b>	<b>4</b>	<b>9</b>	<b>-2</b>	<b>8</b>	<b>5</b>	<b>-7.0</b>
Wt <b>1125</b>	Acc. (.70)	(.81)	(.75)	(.74)	(.70)	(.49)	(.61)	(.52)
Wean Pct. <b>46%</b>	Marb <b>-.05</b>	(.57)	REA <b>-.17</b>	(.54)	Bfat <b>-.01</b>	(.42)		
Cow Eff. <b>97</b>								

★★★★★ for Low Maintenance, Calving Ease.

• Reference Sires •

**W-1 BECKTON WARHAWK N560**  
1-A 100% # 916682 Tattoo: BKT3 N560

Birth: 3-27-03	Beckton Warrior TC E801	Beckton Warrior T C371	BWt	<b>61</b>
		Beckton Minola C251 NM	WR	<b>100</b>
<b>BECKTON WARRIOR T1 H281</b>	Beckton Minerva B609 RN	Beckton Ranger H Z095	ADG	<b>3.21</b>
Ref.		Beckton Minerva Z936 RN	YR	<b>97</b>
	Beckton Hadrian A100	Beckton Julian GN 9A45	Scr.	<b>33</b>
<b>BECKTON FIREFLY H195 HD</b>	Beckton Firefly C999 CB	Bkt Marta 9A13 JL	Fr.	<b>5.0</b>
		Beckton Cobalt K Z100		
		Bkt Firefly 7252 GS		

RAAA HerdBuilder index: **175** (Top 8% of all RA bulls)

RAAA GridMaster index: **53** (Top 17% of all RA bulls)

DAM	
Age	5
Wt	1070
Wean Pct.	54%
Cow Eff.	115

Calv.Ease	BW	WW	YW	Milk	HPG	Stay	Maint.En.
EPDs	<b>18</b>	<b>-7.5</b>	<b>19</b>	<b>42</b>	<b>14</b>	<b>20</b>	<b>9</b>
Acc.	(.62)	(.75)	(.71)	(.69)	(.63)	(.34)	(.17)
Marb	<b>+.04</b>	(.46)	REA	<b>-.03</b>	(.42)	Bfat	<b>-.01</b>
							(.27)

★★★★★ for Low Maintenance, Calving Ease.



Beckton Warrior Y108 (W-3)

**W-2 BECKTON WARRIOR W534 N4**  
1-A 100% # 1332228 Tattoo: BKT9 W534

Birth: 3-31-09	Beckton Warrior CL M686	Beckton Warrior C C355	BWt	<b>56</b>
		Beckton Christy J223 LN	WR	<b>103</b>
<b>BECKTON WARRIOR C1 S337</b>	Beckton Christy K101 CD	Beckton Cody V E023	ADG	<b>3.65</b>
Ref. W		Beckton Christy C306 JL	YR	<b>102</b>
	Beckton Nebula P P707	Beckton Nebula M045	Scr.	<b>35</b>
<b>BKT LARKEISA S055 NB</b>	Beckton Larkeisa P688 CH	Beckton Lana M809 EP	Fr.	<b>4.5</b>
		Beckton Champ R3 H338		
		BKT Larkeisa J564 HR		

RAAA HerdBuilder index: **157** (Top 5% of all RA bulls)

RAAA GridMaster index: **51** (Top 23% of all RA bulls)

DAM	
Age	3
Wt	880
Wean Pct.	61%
Cow Eff.	129

Calv.Ease	BW	WW	YW	Milk	HPG	Stay	Maint.En.
EPDs	<b>16</b>	<b>-7.0</b>	<b>35</b>	<b>56</b>	<b>25</b>	<b>12</b>	<b>15</b>
Acc.	(.57)	(.70)	(.66)	(.65)	(.55)	(.16)	(.11)
Marb	<b>+.79</b>	(.25)	REA	<b>+.14</b>	(.22)	Bfat	<b>+.07</b>
							(.36)

★★★★★ for Low Maintenance, Marbling, Rib-eye area, High Cow Efficiency, Calving Ease, Stayability.

**W-3 BECKTON WARRIOR Y108 E5**  
1-A 100% # 1451453 Tattoo: BKT1 Y108

Birth: 3-13-11	Beckton Warrior C1 S337	Beckton Warrior CL M686	BWt	<b>52</b>
		Beckton Christy K101 CD	WR	<b>109</b>
<b>BECKTON WARRIOR W534 N4</b>	BKT Larkeisa S055 NB	Beckton Nebula P P707	ADG	<b>3.65</b>
Ref. W-2		Beckton Larkeisa P688 CH	YR	<b>110</b>
	Beckton Epic T330 L5	Beckton Epic K4 N795	Scr.	<b>36</b>
<b>BECKTON SUSAN W058 E</b>	Beckton Susan T048 NB	Beckton Belga K202 LN	Fr.	<b>5.5</b>
		Beckton Nebula H R233		
		Beckton Susan R022 CQ		

RAAA HerdBuilder index: **173** (Top 2% of all RA bulls)

RAAA GridMaster index: **52** (Top 13% of all RA bulls)

DAM	
Age	2
Wt	785
Wean Pct.	71%
Cow Eff.	149

Calv.Ease	BW	WW	YW	Milk	HPG	Stay	Maint.En.
EPDs	<b>14</b>	<b>-5.8</b>	<b>50</b>	<b>87</b>	<b>27</b>	<b>12</b>	<b>17</b>
Acc.	(.28)	(.46)	(.41)	(.42)	(.24)	(.01)	(.01)
Marb	<b>+.52</b>	(.17)	REA	<b>+.17</b>	(.14)	Bfat	<b>+.05</b>
							(.29)

★★★★★ for Low Maintenance, Growth, Marbling, Rib-eye area, High Cow Efficiency, Calving Ease, Stayability.



# RAAA Herd EPD Tables

## Proven and Genetic Opportunity Sires (2016)

	HB	GM	CED	BW	WW	YW	MILK	ME	HPG	CEM	ST	MARB	YG	CW	REA	FAT
Min.	-24	58	-16	-13.8	-10	-22	-12	-25	-3	-17	-2	-.29	-.33	-51	-.75	-.09
<b>Avg.</b>	<b>98</b>	<b>50</b>	<b>6</b>	<b>-1.6</b>	<b>58</b>	<b>90</b>	<b>20</b>	<b>1</b>	<b>10</b>	<b>4</b>	<b>10</b>	<b>.49</b>	<b>.03</b>	<b>21</b>	<b>.11</b>	<b>.00</b>
Max.	212	58	27	6.5	112	178	46	22	25	24	20	1.56	.54	78	1.10	.11
1%	186	55	19	-8.1	93	147	37	-14	17	14	17	1.00	-.21	56	.65	-.06
2%	175	55	17	-7.4	89	140	35	-12	17	13	17	.94	-.19	52	.59	-.05
3%	169	54	16	-6.9	86	136	33	-11	16	12	16	.90	-.17	49	.55	-.05
4%	164	54	16	-6.5	84	133	33	-10	16	12	16	.88	-.15	47	.52	-.04
5%	160	54	15	-6.2	83	130	32	-9	15	11	15	.85	-.14	46	.49	-.04
<b>10%</b>	<b>146</b>	<b>53</b>	<b>13</b>	<b>-5.2</b>	<b>77</b>	<b>121</b>	<b>29</b>	<b>-7</b>	<b>14</b>	<b>10</b>	<b>14</b>	<b>.77</b>	<b>-.11</b>	<b>40</b>	<b>.41</b>	<b>-.03</b>
15%	137	52	12	-4.5	74	115	27	-5	13	9	13	.72	-.08	37	.35	-.02
20%	130	52	11	-4.0	71	111	26	-4	13	8	13	.67	-.06	34	.31	-.02
25%	123	52	10	-3.5	68	107	25	-3	12	7	12	.64	-.04	31	.27	-.02
30%	118	51	9	-3.1	66	103	24	-2	12	6	12	.60	-.03	29	.23	-.01
35%	113	51	8	-2.7	64	99	23	-1	11	6	11	.57	-.01	27	.20	-.01
40%	108	51	7	-2.3	62	96	22	-1	11	5	11	.54	.00	25	.17	.00
45%	103	50	7	-2.0	60	93	21	0	10	5	10	.51	.01	23	.14	.00
<b>45%</b>	<b>98</b>	<b>50</b>	<b>6</b>	<b>-1.6</b>	<b>58</b>	<b>90</b>	<b>20</b>	<b>1</b>	<b>10</b>	<b>4</b>	<b>10</b>	<b>.49</b>	<b>.03</b>	<b>21</b>	<b>.11</b>	<b>.00</b>
55%	93	50	5	-1.2	56	87	19	2	10	3	10	.46	.04	19	.08	.01
60%	88	49	5	-0.9	54	84	18	3	9	3	9	.43	.05	17	.05	.01
65%	83	49	4	-0.5	52	81	17	3	9	2	9	.40	.07	15	.02	.01
70%	78	49	3	-0.1	50	77	16	4	8	2	8	.37	.08	13	-.01	.02
75%	73	48	2	0.3	48	73	15	5	8	1	8	.34	.10	11	-.04	.02
80%	66	48	1	0.8	45	69	14	6	7	0	7	.30	.11	8	-.08	.02
85%	59	48	0	1.3	42	65	13	7	7	-1	7	.26	.13	5	-.13	.03
<b>90%</b>	<b>50</b>	<b>47</b>	<b>-1</b>	<b>2.0</b>	<b>39</b>	<b>59</b>	<b>11</b>	<b>9</b>	<b>6</b>	<b>-2</b>	<b>6</b>	<b>.20</b>	<b>.13</b>	<b>2</b>	<b>-.19</b>	<b>.03</b>
95%	36	46	-3	3.0	33	50	8	11	5	-3	5	.12	.20	-4	-.27	.04

## Active Cows (2016)

	HB	GM	CED	BW	WW	YW	MILK	ME	HPG	CEM	ST	MARB	YG	CW	REA	FAT
Min.	-26	41	-11	-11.3	-5	-13	-10	-21	-5	-15	-5	-.33	-.74	-43	-.82	-.19
<b>Avg.</b>	<b>92</b>	<b>49</b>	<b>5</b>	<b>-1.0</b>	<b>56</b>	<b>84</b>	<b>19</b>	<b>1</b>	<b>10</b>	<b>3</b>	<b>10</b>	<b>.42</b>	<b>.01</b>	<b>18</b>	<b>.08</b>	<b>-.01</b>
Max.	211	57	21	10.4	105	177	49	30	24	18	22	1.60	.48	78	1.14	.14
1%	162	53	14	-6.2	82	129	32	-11	15	11	17	.86	-.23	49	.54	-.06
2%	154	52	13	-5.6	79	123	31	-9	15	10	16	.81	-.20	45	.49	-.06
3%	149	52	13	-5.2	77	120	30	-9	14	9	16	.78	-.18	43	.45	-.05
4%	145	52	12	-4.9	76	118	29	-8	14	9	15	.75	-.17	41	.43	-.05
5%	142	52	12	-4.7	75	116	28	-7	14	8	15	.73	-.16	40	.40	-.05
<b>10%</b>	<b>131</b>	<b>51</b>	<b>10</b>	<b>-3.9</b>	<b>71</b>	<b>109</b>	<b>26</b>	<b>-6</b>	<b>13</b>	<b>7</b>	<b>14</b>	<b>.66</b>	<b>-.12</b>	<b>35</b>	<b>.33</b>	<b>-.04</b>
15%	123	51	9	-3.3	68	104	25	-4	12	6	13	.62	-.10	32	.28	-.03
20%	117	50	8	-2.9	66	100	24	-3	12	6	12	.58	-.08	29	.24	-.03
25%	112	50	8	-2.5	64	97	23	-2	12	5	12	.55	-.06	27	.21	-.02
30%	108	50	7	-2.2	62	94	22	-2	11	5	12	.52	-.05	25	.18	-.02
35%	104	50	7	-1.9	60	91	21	-1	11	4	11	.50	-.03	23	.15	-.02
40%	100	49	6	-1.6	59	89	20	0	11	4	11	.47	-.02	21	.13	-.01
45%	96	49	6	-1.3	57	86	20	0	10	3	10	.45	-.01	20	.10	-.01
<b>50%</b>	<b>92</b>	<b>49</b>	<b>5</b>	<b>-1.0</b>	<b>56</b>	<b>84</b>	<b>19</b>	<b>1</b>	<b>10</b>	<b>3</b>	<b>10</b>	<b>.42</b>	<b>.01</b>	<b>18</b>	<b>.08</b>	<b>-.01</b>
55%	88	49	4	-0.7	55	82	18	2	10	3	10	.40	.02	16	.05	.00
60%	84	49	4	-0.4	53	79	18	2	9	2	9	.38	.03	15	.02	.00
65%	80	48	3	-0.1	52	77	17	3	9	2	9	.35	.04	13	.00	.00
70%	76	48	3	0.2	50	74	16	4	9	1	8	.33	.06	11	-.03	.01
75%	72	48	2	0.5	48	71	15	4	8	1	8	.30	.07	9	-.06	.01
80%	67	48	2	0.9	46	68	14	5	8	0	8	.27	.09	7	-.09	.01
85%	61	47	1	1.3	44	64	13	6	8	0	7	.23	.11	4	-.13	.02
<b>90%</b>	<b>53</b>	<b>47</b>	<b>0</b>	<b>1.9</b>	<b>41</b>	<b>59</b>	<b>12</b>	<b>8</b>	<b>7</b>	<b>-1</b>	<b>6</b>	<b>.18</b>	<b>.14</b>	<b>1</b>	<b>-.18</b>	<b>.03</b>
95%	42	46	-2	2.7	37	52	10	9	6	-2	5	.12	.17	-4	-.25	.03

## Non-Parents (2016)

	HB	GM	CED	BW	WW	YW	MILK	ME	HPG	CEM	ST	MARB	YG	CW	REA	FAT
Min.	-34	42	-10	-11.6	4	5	-4	-17	0	-9	-3	-.37	-.74	-39	-.69	-.20
<b>Avg.</b>	<b>104</b>	<b>49</b>	<b>5</b>	<b>-1.5</b>	<b>58</b>	<b>89</b>	<b>20</b>	<b>0</b>	<b>10</b>	<b>4</b>	<b>12</b>	<b>.47</b>	<b>.00</b>	<b>21</b>	<b>.13</b>	<b>.00</b>
Max.	227	59	22	9.4	107	169	38	19	21	16	22	1.52	.53	76	1.21	.17
1%	178	53	14	-6.6	83	132	30	-11	15	10	19	.95	-.27	50	.60	-.07
2%	169	53	13	-6.0	80	127	29	-9	14	9	18	.89	-.24	47	.54	-.06
3%	163	52	12	-5.6	78	124	28	-9	14	9	18	.85	-.22	45	.51	-.06
4%	159	52	12	-5.4	77	121	28	-8	14	9	18	.83	-.20	43	.48	-.05
5%	156	52	12	-5.1	76	119	27	-8	13	8	17	.81	-.19	42	.46	-.05
<b>10%</b>	<b>145</b>	<b>51</b>	<b>10</b>	<b>-4.3</b>	<b>72</b>	<b>113</b>	<b>26</b>	<b>-6</b>	<b>13</b>	<b>7</b>	<b>16</b>	<b>.73</b>	<b>-.15</b>	<b>37</b>	<b>.39</b>	<b>-.04</b>
15%	137	51	9	-3.8	69	108	25	-5	12	7	15	.68	-.12	34	.34	-.03
20%	131	51	8	-3.4	67	104	24	-4	12	6	15	.64	-.10	32	.30	-.03
25%	125	50	8	-3.0	65	101	23	-3	11	6	14	.61	-.08	29	.27	-.02
30%	121	50	7	-2.7	64	99	22	-2	11	5	14	.58	-.06	28	.24	-.02
35%	116	50	7	2.4	62	96	22	-2	11	5	13	.55	-.04	26	.21	-.01
40%	112	49	6	-2.1	61	94	21	-1	11	5	13	.52	-.03	24	.18	-.01
45%	108	49	6	-1.8	59	91	21	-1	10	4	12	.50	-.01	23	.16	-.01
<b>50%</b>	<b>104</b>	<b>49</b>	<b>5</b>	<b>-1.5</b>	<b>58</b>	<b>89</b>	<b>20</b>	<b>0</b>	<b>10</b>	<b>4</b>	<b>12</b>	<b>.47</b>	<b>.00</b>	<b>21</b>	<b>.13</b>	<b>.00</b>
55%	100	49	4	-1.2	57	87	19	1	10	4	12	.45	.02	19	.11	.00
60%	96	49	4	-0.9	55	84	19	1	9	3	11	.42	.03	18	.08	.00
65%	92	48	3	-0.6	54	82	18	2	9	3	11	.39	.05	16	.05	.01
70%	87	48	3	-0.3	52	79	18	2	9	3	10	.37	.07	14	.03	.01
75%	83	48	2	0.0	51	77	17	3	9	2	10	.33	.08	13	.00	.02
80%	77	47	2	0.4	49	74	16	4	8	2	9	.30	.10	10	-.04	.02
85%	71	47	1	0.8	47	70	15	5	8	1	9	.26	.13	8	-.08	.03
<b>90%</b>	<b>63</b>	<b>47</b>	<b>0</b>	<b>1.3</b>	<b>44</b>	<b>65</b>	<b>14</b>	<b>6</b>	<b>7</b>	<b>1</b>	<b>8</b>	<b>.21</b>	<b>.16</b>	<b>5</b>	<b>-.12</b>	<b>.03</b>
95%	52	46	-2	2.1	40	59	13	8	7	0	7	.14	.20	0	-.20	.05

## EPD Accuracies and Possible Change

EPDs are predictions, not true values, and we can therefore expect that EPDs will change from sire evaluation, as more information (i.e. progeny data) is included. A possible change value is an estimate of the amount of change (in trait units) that can be expected for a given EPD.

Technically, there is a 68% chance that the real genetic value (an EPD with a accuracy of 1.0) for any trait lies between its EPD plus its possible change value and its EPD minus its possible change value. For example, if a sire has a weaning EPD of +25 lb. and a possible change value of 10 lb., we can expect the true genetic value to be between +15 lb. (25 - 10) and +35 lb. (25 + 10) 68% of the time. We should not be surprised if his EPD in next year's evaluation is as high as +35 or as low as +15. If next year's EPD should happen to be slightly outside of this

range, keep in mind there is nearly a one-in-three chance of that happening; however, significantly larger deviations can occur.

Possible change is simply another way of expressing accuracy of an EPD. High accuracy sires will have small possible changes and vice versa. Many breeders feel that possible change values complement accuracies and help them determine just how thoroughly an animal has been evaluated. The accuracy/possible change chart lists possible changes in EPDs that can be expected with different levels of accuracy for the various traits.

For more information on possible change values, please see the article by Dr. Bob Hough titled "Understanding EPD Accuracies and Possible Change". This article can be downloaded from the Red Angus Association of America website at [www.redangus.org](http://www.redangus.org).

Accuracy	CED	BW	WW	YW	MILK	ME	HPG	CEM	ST	MARB	YG	CW	REA	FAT
<b>0.0</b>	9	3.0	16	26	12	3	11	9	7	.26	.20	19	.43	.04
<b>0.1</b>	8	2.7	15	23	11	2	10	8	6	.23	.18	17	.39	.04
<b>0.2</b>	7	2.4	13	21	10	2	9	7	5	.21	.16	15	.34	.03
<b>0.3</b>	6	2.1	11	18	8	2	8	6	5	.18	.14	14	.30	.03
<b>0.4</b>	5	1.8	10	15	7	2	7	5	4	.16	.12	12	.26	.02
<b>0.5</b>	4	1.5	8	13	6	1	6	4	3	.13	.10	10	.22	.02
<b>0.6</b>	3	1.2	7	10	5	1	4	4	3	.10	.08	8	.17	.02
<b>0.7</b>	3	0.9	5	8	4	1	3	3	2	.08	.06	6	.13	.01
<b>0.8</b>	2	0.6	3	5	2	1	2	2	1	.05	.04	4	.09	.01
<b>0.9</b>	1	0.3	2	3	1	0	1	1	1	.03	.02	2	.04	.00
<b>1.0</b>	0	0.0	0	0	0	0	0	0	0	.00	.00	0	.00	.00

# Sire Bloodline Charts

Name Family

- Accent A
- Cardinal C
- Cherokee C
- Clifftop C
- Clipper A
- Cody A
- Dominor D
- Emperor E
- Epic E
- Hasten H
- Herald H
- Heritage H
- Hughes B
- Hustler H
- Janus O
- Jet J
- Julian J
- Julio J
- Lancer L
- Legend L
- Likable L
- Loki L
- Lunesta A
- Nebula N
- New Era N
- Nomad V
- Ranger R
- Roman O
- Roosevelt B
- Scamp S
- Warhawk W
- Warrior W

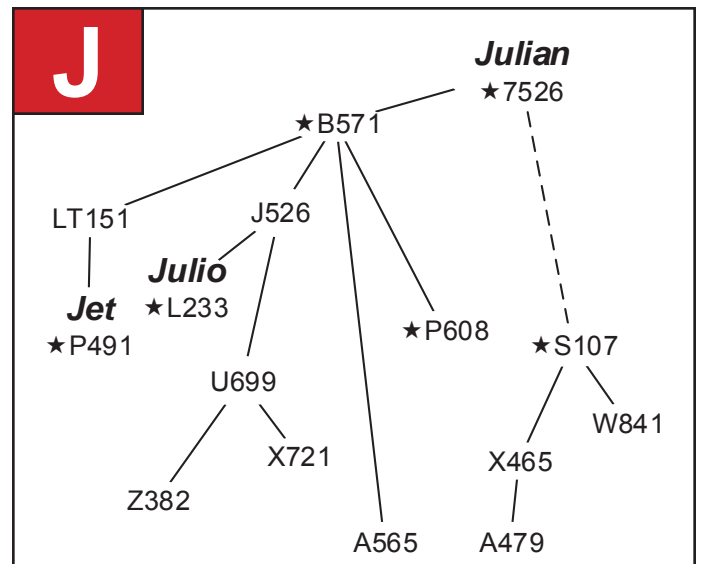
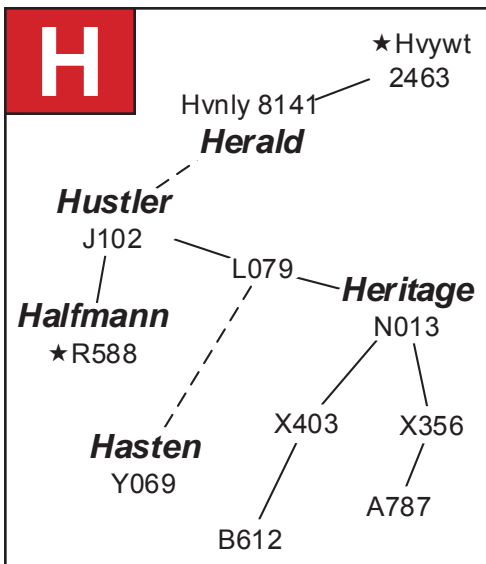
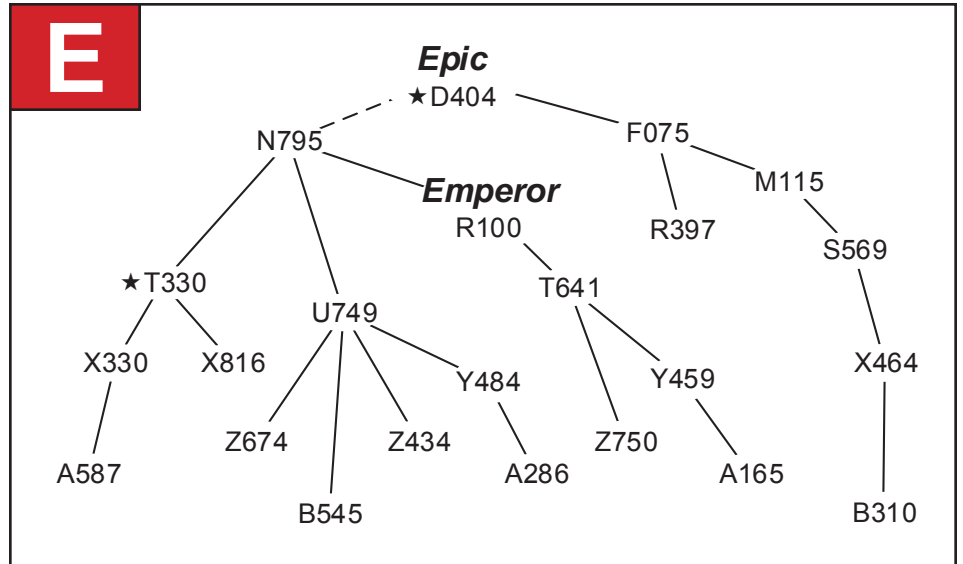
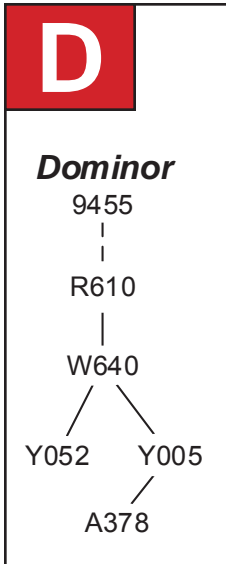
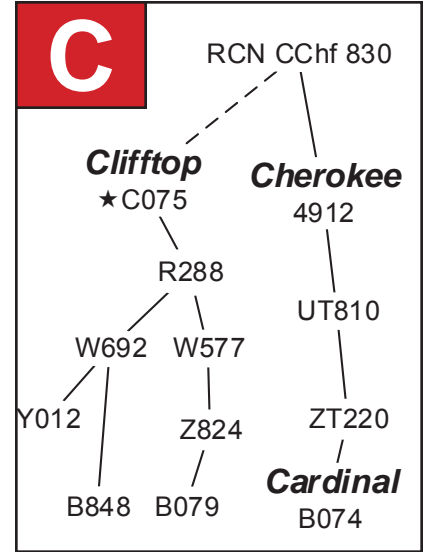
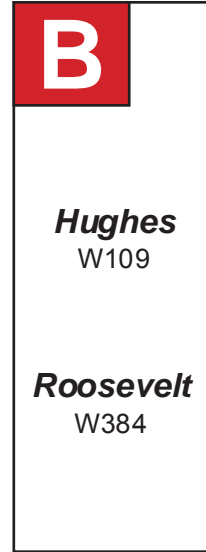
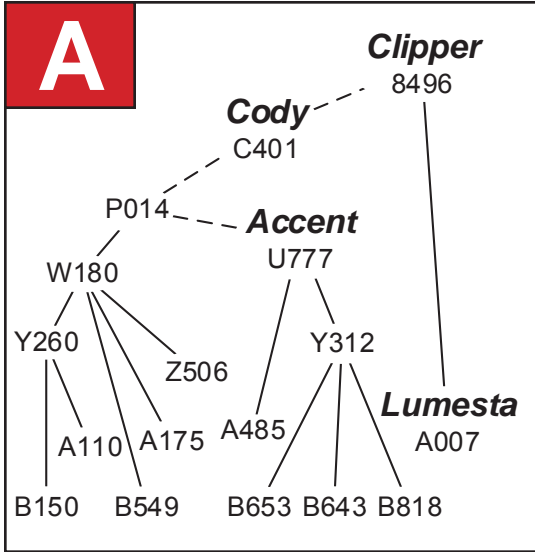

★ Red Angus Trait Leader



# L

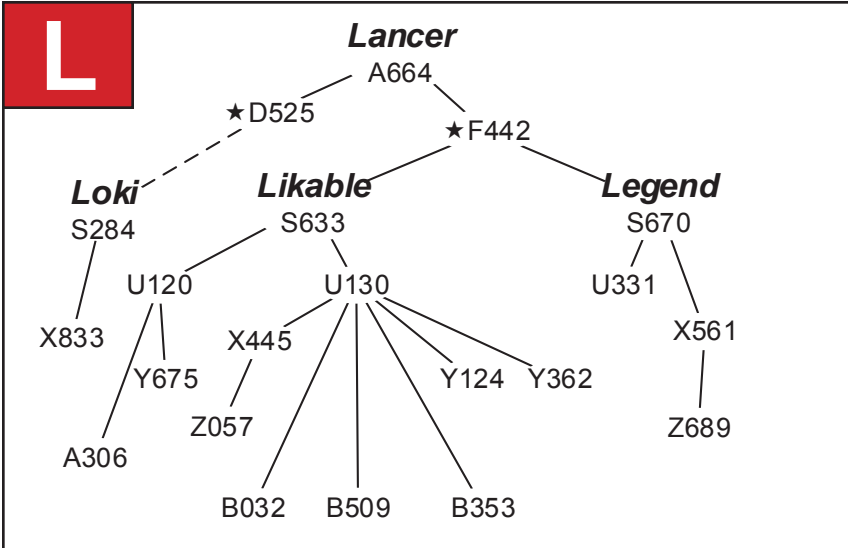

# O

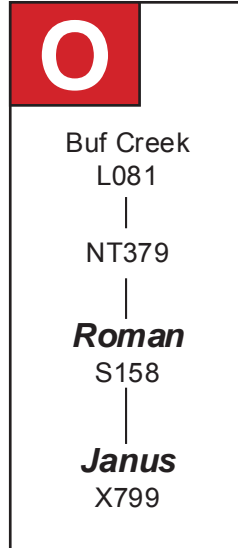

# N

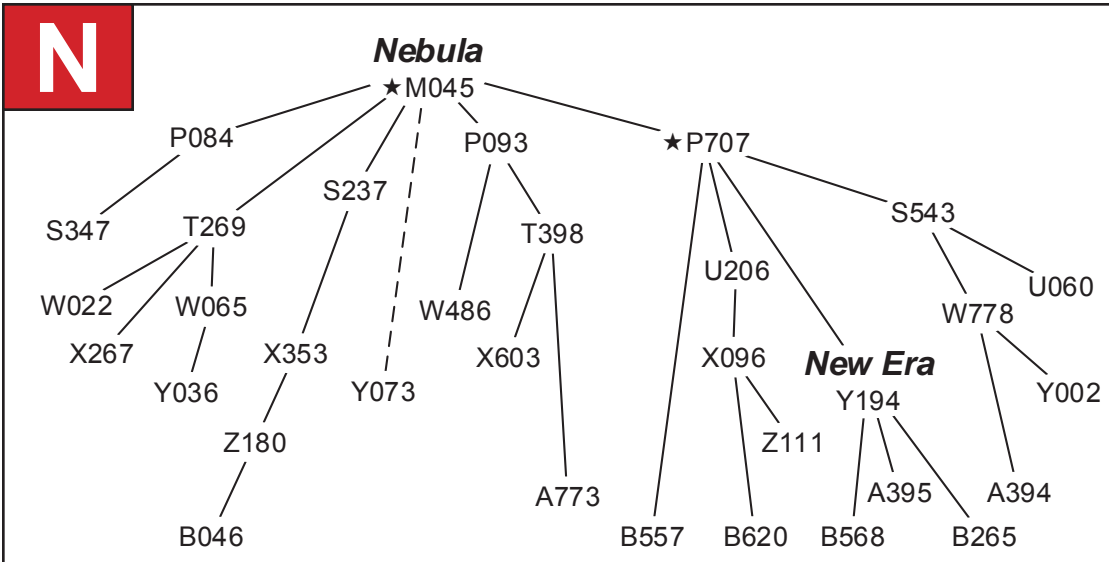

# R

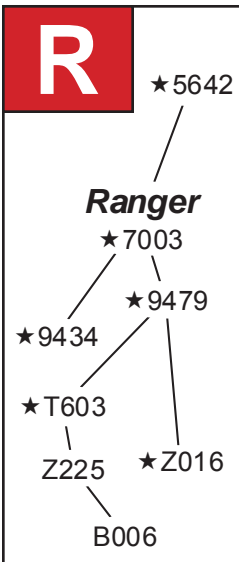

# S

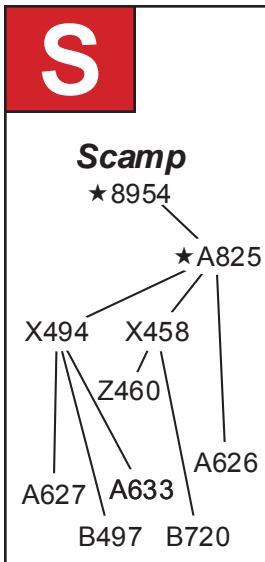

# V

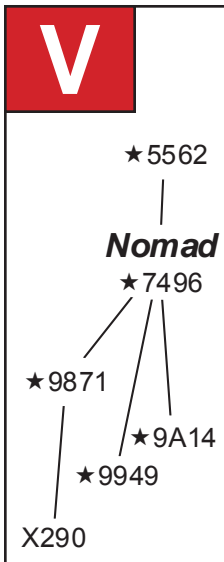

# W

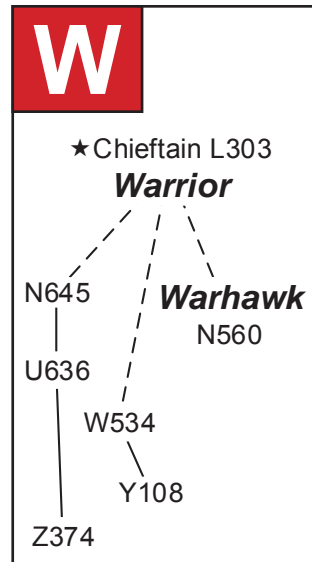

Name	Tag	Family
Nomad	9871	V-1
Accent	A110	A-5
Accent	A175	A-6
Accent	A485	A-7
Accent	U777	A
Accent	W180	A-1
Accent	Y260	A-2
Accent	Y312	A-3
Bieber	W109	B
Bieber	W384	B-1
Clifftop	W692	C-1
Clifftop	Y012	C-2
Dominor	A378	D-1
Dominor	W640	D
Emperor	A165	E-5
Emperor	Y459	E-3
Epic	A286	E-6
Epic	A587	E-7
Epic	X330	E-1
Epic	X464	E-2
Epic	Y484	E-4
Epic	Z674	E
Hasten	Y069	H
Heritage	A767	H-2
Heritage	X403	H-1
Janus	X799	O-1
Jet	P491	J
Julian	A479	J-5
Julian	A565	J-6
Julian	B571	J-1
Julian	X465	J-2
Julian	Z382	J-4
Legend	S670	L
Likable	A306	L-4
Likable	U130	L-1
Likable	Y124	L-2
Likable	Y362	L-3
Likable	Z057	L
Loki	X833	L
Lunesta	A007	A-4
Nebula	A394	N
Nebula	A773	N-6
Nebula	P084	N
Nebula	P707	N-1
Nebula	S347	N-2
Nebula	U060	N
Nebula	U206	N
Nebula	W778	N
Nebula	X096	N-3
Nebula	X603	N
Nebula	Y002	N
Nebula	Y073	N
New Era	A395	N-5
New Era	Y194	N-4
Nomad	9A14	V-2
Scamp	A626	S-3
Scamp	A627	S-4
Scamp	A633	S-5
Scamp	A825	S
Scamp	X458	S-1
Scamp	X494	S-2
Warhawk	N560	W-1
Warrior	W534	W-2
Warrior	Y108	W-3



# Reference Sire Lot Index

Lot	ID	Lot	ID	Lot	ID	Lot	ID	Lot	ID	Lot	ID
<u>Accent W180 (A-1)</u>		<u>Clifftop W692 (C-1)</u>		<u>Emperor A165 (E-5)</u>		<u>Julian X465 (J-2)</u>		<u>Likable Y362 (L-3)</u>		<u>New Era A395 (N-5)</u>	
5	C537	18	C654	31	C532	21	C669	17	C550	54	C054
7	C367	65	C257	42	C051	29	C802	95	C504	146	C029
14	C487	115	C621	175	C084	50	C698	189	C498	161	C074
16	C392	231	C427	178	C164	52	C578	250	C436	176	C025
26	C497	<u>Clifftop Y012 (C-2)</u>		203	C601	91	C473	<u>Likable A306 (L-4)</u>		179	C045
32	C592	71	C186	241	C334	108	C788	246	C202	190	C214
35	C228	88	C215	<u>Epic A286 (E-6)</u>		171	C450	<u>Nebula A394 (N)</u>		230	C132
37	C667	128	C688	142	C085	192	C608	78	C011	<u>Nebula A773 (N-6)</u>	
79	C577	220	C716	196	C122	<u>Janus X799 (J-3)</u>		148	C174	33	C129
126	C501	243	C566	248	C589	38	C304	<u>New Era A409 (N)</u>		134	C108
132	C347	<u>Dominor A378 (D-1)</u>		<u>Epic A587 (E-7)</u>		41	C610	309	C301 (H)	145	C104
144	C627	152	C145	30	C151	77	C458	<u>Nebula P084 (N)</u>		164	C188
198	C232	157	C146	112	C030	80	C430	22	C282	<u>Scamp A825 (S)</u>	
217	C783	170	C137	120	C056	102	C341	57	C445	202	C519
<u>Accent Y260 (A-2)</u>		233	C134	207	C205	104	C745	123	C322	<u>Scamp X458 (S-1)</u>	
63	C405	<u>Epic T330 (E)</u>		214	C738	106	C757	<u>Nebula U060 (N)</u>		24	C457
73	C287	307	C465 (H)	218	C749	137	C665	169	C315	40	C316
188	C596	<u>Epic X330 (E-1)</u>		<u>Heritage X403 (H-1)</u>		160	C628	<u>Nebula W778 (N)</u>		46	C660
213	C727	49	C523	10	C321	173	C568	76	C264	48	C513
237	C595	113	C574	11	C335	200	C618	<u>Nebula Y002 (N)</u>		60	C512
<u>Accent Y312 (A-3)</u>		232	C661	28	C701	211	C724	94	C542	81	C644
6	C216	316	C402 (H)	34	C377	224	C534	<u>Nebula P707 (N-1)</u>		118	C590
89	C658	<u>Epic X464 (E-2)</u>		66	C400	311	C342 (H)	180	C251	166	C682
111	C263	9	C199	72	C417	312	C494 (H)	303	C277 (H)	308	C371 (H)
156	C247	51	C412	90	C655	323	C843 (H)	<u>Nebula S347 (N-2)</u>		318	C295 (H)
195	C632	58	C697	96	C283	324	C733 (H)	129	C358	319	C218 (H)
208	C708	69	C326	124	C245	329	C425 (H)	205	C461	328	C666 (H)
212	C765	85	C598	147	C633	<u>Julian Z382 (J-4)</u>		315	C489 (H)	<u>Scamp X494 (S-2)</u>	
219	C734	99	C648	151	C622	4	C395	320	C762 (H)	23	C637
245	C642	105	C717	153	C293	<u>Julian A479 (J-5)</u>		<u>Nebula X096 (N-3)</u>		25	C541
247	C522	107	C751	229	C691	172	C144	13	C453	36	C348
<u>Lunesta A007 (A-4)</u>		131	C625	251	C685	193	C175	43	C384	97	C616
61	C208	314	C478 (H)	304	C285 (H)	206	C300	45	C416	116	C570
70	C057	317	C710 (H)	305	C502 (H)	223	C354	47	C571	127	C429
159	C190	<u>Emperor Y459 (E-3)</u>		<u>Heritage A767 (H-2)</u>		235	C161	83	C490	141	C662
<u>Accent A110 (A-5)</u>		39	C435	184	C403	<u>Julian A565 (J-6)</u>		101	C527	143	C641
67	C009	100	C336	197	C091	139	C016	109	C715	209	C750
182	C037	<u>Epic Y484 (E-4)</u>		201	C670	227	C116	130	C406	<u>Scamp A626 (S-3)</u>	
186	C456	8	C488	249	C177	<u>Legend S670 (L)</u>		310	C462 (H)	177	C046
240	C649	44	C624	<u>Jet P491 (J)</u>		86	C359	<u>New Era Y194 (N-4)</u>		187	C110
242	C548	53	C538	221	C725	93	C469	1	C307	204	C022
244	C143	110	C561	<u>Julian P608 (J)</u>		<u>Likable U130 (L-1)</u>		2	C249	226	C095
<u>Accent A175 (A-6)</u>		119	C668	321	C479 (H)	55	C629	12	C449	236	C192
75	C076	125	C525	<u>Julian B571 (J-1)</u>		62	C643	27	C718	<u>Scamp A627 (S-4)</u>	
121	C223	133	C446	3	C253	64	C474	84	C511	114	C105
135	C058	140	C593	122	C365	82	C344	<u>Scamp A633 (S-5)</u>		174	C117
<u>Accent A485 (A-7)</u>		154	C563	301	C404 (H)	117	C672	167	C191	228	C327
15	C210	215	C786	<u>Roosevelt W384 (B-1)</u>		155	C664	183	C227	326	C162 (H)
103	C100	<u>Jet P491 (J)</u>		56	C364	168	C645	<u>Likable Y124 (L-2)</u>			
162	C113	<u>Julian P608 (J)</u>		185	C529	181	C651	74	C374		



# Lot-Tag Cross Reference

ID	Lot	ID	Lot	ID	Lot	ID	Lot	ID	Lot	ID	Lot	ID	Lot
<i>Bulls</i>		C202	246	C374	74	C529	185	C648	99	<i>Heifers</i>		<i>Reference Sires</i>	
C009	67	C205	207	C377	34	C532	31	C649	240	C162	326	9871	V-1
C011	78	C208	61	C384	43	C534	224	C651	181	C218	319	9A14	V-2
C016	139	C210	15	C390	136	C537	5	C654	18	C254	306	A007	A-4
C022	204	C214	190	C392	16	C538	53	C655	90	C277	303	A110	A-5
C025	176	C215	88	C395	4	C539	163	C656	194	C278	327	A165	E-5
C029	146	C216	6	C396	191	C540	158	C658	89	C285	304	A175	A-6
C030	112	C223	121	C400	66	C541	25	C660	46	C295	318	A286	E-6
C037	182	C227	183	C403	184	C542	94	C661	232	C301	309	A306	L-4
C045	179	C228	35	C405	63	C548	242	C662	141	C342	311	A378	D-1
C046	177	C232	198	C406	130	C550	17	C664	155	C355	325	A395	N-5
C051	42	C241	222	C412	51	C561	110	C665	137	C368	302	A479	J-5
C054	54	C245	124	C416	45	C563	154	C667	37	C371	308	A485	A-7
C056	120	C247	156	C417	72	C566	243	C668	119	C402	316	A565	J-6
C057	70	C249	2	C423	19	C568	173	C669	21	C404	301	A587	E-7
C058	135	C251	180	C427	231	C570	116	C670	201	C425	329	A626	S-3
C074	161	C253	3	C429	127	C571	47	C672	117	C462	310	A627	S-4
C076	75	C257	65	C430	80	C574	113	C673	150	C465	307	A633	S-5
C084	175	C263	111	C433	199	C575	20	C682	166	C478	314	A767	H-2
C085	142	C264	76	C435	39	C577	79	C685	251	C479	321	A773	N-6
C091	197	C282	22	C436	250	C578	52	C688	128	C486	322	B571	J-1
C095	226	C283	96	C445	57	C589	248	C690	225	C489	315	N560	W-1
C100	103	C287	73	C446	133	C590	118	C691	229	C494	312	P707	N-1
C104	145	C293	153	C449	12	C592	32	C697	58	C502	305	S347	N-2
C105	114	C297	234	C450	171	C593	140	C698	50	C507	313	U130	L-1
C108	134	C300	206	C452	238	C595	237	C700	216	C666	328	W180	A-1
C110	187	C304	38	C453	13	C596	188	C701	28	C710	317	W384	B-1
C113	162	C307	1	C454	149	C598	85	C708	208	C711	330	W534	W-2
C116	227	C314	87	C456	186	C600	138	C715	109	C733	324	W692	C-1
C117	174	C315	169	C457	24	C601	203	C716	220	C747	331	X096	N-3
C122	196	C316	40	C458	77	C608	192	C717	105	C762	320	X330	E-1
C129	33	C321	10	C461	205	C610	41	C718	27	C843	323	X403	H-1
C132	230	C322	123	C469	93	C616	97	C724	211			X458	S-1
C134	233	C326	69	C472	165	C618	200	C725	221			X464	E-2
C137	170	C327	228	C473	91	C621	115	C727	213			X465	J-2
C143	244	C334	241	C474	64	C622	151	C734	219			X494	S-2
C144	172	C335	11	C487	14	C623	68	C738	214			X799	J-3
C145	152	C336	100	C488	8	C624	44	C745	104			Y012	C-2
C146	157	C341	102	C490	83	C625	131	C749	218			Y108	W-3
C151	30	C344	82	C497	26	C627	144	C750	209			Y124	L-2
C161	235	C347	132	C498	189	C628	160	C751	107			Y194	N-4
C164	178	C348	36	C501	126	C629	55	C757	106			Y260	A-2
C174	148	C352	59	C504	95	C632	195	C765	212			Y312	A-3
C175	193	C354	223	C511	84	C633	147	C781	210			Y362	L-3
C177	249	C358	129	C512	60	C635	239	C783	217			Y459	E-3
C186	71	C359	86	C513	48	C637	23	C786	215			Y484	E-4
C188	164	C363	98	C519	202	C641	143	C788	108			Z382	J-4
C190	159	C364	56	C522	247	C642	245	C802	29				
C191	167	C365	122	C523	49	C643	62						
C192	236	C367	7	C525	125	C644	81						
C199	9	C373	92	C527	101	C645	168						

# Sale Terms and Conditions

Except for those stated in the terms and conditions below, there are no warranties, either expressed or implied, as to the merchantability or fitness for a particular purpose with respect to the cattle being sold at this auction. The warranties and guarantees set forth in the "Terms and Conditions" are in lieu of all other warranties, either expressed or implied, and the remedies provided therein shall be the sole and exclusive remedy for the Buyer, or any party claiming through Buyer, for any breach of warranty or guarantee therein provided, and all other obligations or liabilities.

The information in the catalog is believed to be accurate, and the information seller believes to be most representative. It is the nature of seller's business that the seller engages in a continual process of collecting new data and information. Therefore, any information presented at the time of sale is always subject to revision, correction or update.

## I. BIDDING

The Auctioneer in charge will settle any disputes as to bids, and his decision on such matters shall be final.

## II. TERMS

Terms of sale are cash or personal check unless satisfactory credit arrangements have been made with vendor prior to sale.

## III. PURCHASER'S RISK

Each animal becomes the risk of the purchaser as soon as sold, but it shall be the obligation of the Seller to see that animals are fed and cared for free of charge to purchaser, until loaded for shipment or until the expiration of 48 hours after the sale, whichever occurs sooner.

## IV. DELIVERY

For any animals for which seller's arrange delivery, the following terms shall apply. Each animal becomes the risk of the purchaser as soon as sold, and through the time of delivery. The seller will arrange transportation and delivery schedules, and may combine animals from one or more purchasers for convenience and to reduce costs. If delivery is arranged, seller assumes no other liability. Once the purchaser has been notified of the date and approximate time of delivery (morning, afternoon, evening, etc.), it is the responsibility of the purchaser to arrange adequate and agreeable location and facilities for unloading each animal. When unloaded at the agreed upon location, all care and management of the animal is the responsibility of the purchaser.

## V. CERTIFICATE OF REGISTRY

A transferred certificate of registry will be furnished to the purchaser for each animal for which a Registration number is listed.

## VI. HEALTH

All animals are eligible for interstate shipment, except as otherwise announced. Interstate health papers will be furnished for each animal requiring T.B, Bang's, and trich tests in accordance with federal and state regulations.

## VII. DIVISIBILITY

The percentage of ownership interest received by the buyer, whether it is 100% or 2/3 or otherwise as defined in the catalog or by the auctioneer, may not be subsequently divided without the express written consent of the seller.

## VIII. ANNOUNCEMENTS

Any changes from information of any kind in this catalog will be announced from the auction box and such announcements shall take precedence.

## IX. BREEDING GUARANTEE

Any female that has had a calf prior to the date of sale shall be considered a breeder without further guarantee. All females sold as 'bred' or 'pregnant' have been pregnancy checked by a licensed veterinarian and are guaranteed bred on the day of sale. The purchaser may elect to have any female so listed rechecked at their cost within 30 days of delivery by a licensed veterinarian of their choice. Any such female determined open by this recheck may be returned to the seller for a full

refund. Due to conditions out of seller's control, once a female leaves seller's possession, this is the only guarantee offered.

All bulls are sold as guaranteed breeders. Each bull has been officially fertility tested as "Satisfactory Breeder" prior to the sale. However, seller cannot guarantee against physical injury or illness following the sale. But if within 8 months following the sale, the buyer has evidence that the animal is not a breeder, the buyer may obtain a statement signed by a licensed veterinarian to that effect, such statement also indicating that there has been no injury or illness to the animal following the sale, and return the bull to the farm of the seller for adjustment. If the seller cannot then prove the animal to be a breeder, an adjustment will be made by the seller, either by substituting an animal of equal value, or by the refund of the full purchase price. Such adjustment shall be considered full settlement and satisfaction of all claims. No guarantees apply to animals which are shown following the sale.

## X. GENETIC DEFECT AND PARENTAGE GUARANTEE

For complete rules and regulations in regard to genetic defects or parentage guarantee contact the RAAA. Ask for Section C Registration Requirements.

Osteopetrosis: The Red Angus Association along with animal scientists have developed a DNA marker test for osteopetrosis (OS), a genetic disorder which in rare instances can cause the loss of a calf at birth. Since the test was developed, Beckton has tested every sire being used in our breeding program. Only one sire, from outside our program, tested positive as a carrier of the gene. Every sire bred and raised at Beckton has tested 'Free'. All of our major semen sires have also been tested 'Free'. We guarantee every sale animal to be OS Free, and if you have a concern, we will have any sale animal tested on request. If an animal were to test positive, we would replace the animal or refund the purchase price. The testing we have done shows no incidence of occurrence in any Beckton bloodlines for the past 30 years, and so we believe there is no safer herd than ours.

## XI. RETAINED INTEREST AND SEMEN RIGHTS:

Beckton is selling full possession and one half semen interest in all the bulls in the catalog. Seller is retaining one half interest in all bulls in the catalog. This is done so we can use some of the bulls in herd and reserve the right to collect and market semen on these bulls. Any collection on our behalf would be at our expense and could be done during the off-season and at the convenience of the buyer. The buyer would have the option to share in the collection and retain semen for the buyer's use also. If semen is marketed by either party, Seller receives one half royalty interest on gross semen sales, and buyer receives one half interest. Regardless of semen collection and marketing, the buyer retains full possession, full pasture use rights, and full salvage value in these bulls.

## XII. RIGHTS AND OBLIGATIONS

A. The above terms and conditions of sale shall constitute a contract between the Buyer and Seller of each animal and shall be equally binding upon both. Each sale or resale of an animal constitutes a separate transaction.

B. Neither the sale manager, the owner, nor any other person connected with the management of the sale, assumes any liability, legal or otherwise.

# Internet Bidding via Superior Productions

## HOW TO PARTICIPATE AS AN ABSENTEE BUYER

We have made preparations to bid and buy livestock through Superior Productions' "Call or Click-To-Bid" service for those unable to attend in person on sale day. Please note that all of the lots in the sale will also be available for viewing online prior to sale day at [www.superiorlivestock.com](http://www.superiorlivestock.com).

### HERE'S HOW IT WORKS

**Turn in Bids Over the Phone.** This is our traditional method of buying livestock. To get started simply go online to [www.superiorlivestock.com](http://www.superiorlivestock.com) and click on the tab titled "Register for a Buyer Number". Select the registration form for Superior Productions and print the registration form, fill it out and fax it in to Superior Productions at (817) 378-3380 with a signature on it, or scan and email the form to [info@superiorauction.com](mailto:info@superiorauction.com). You can also mail it in to the address provided on the form. Upon receipt of this information Superior will call you with a buyer's number and the bid line phone number that you will use on sale day to place bids over the phone.

**Click-To-Bid.** This is Superior's online bidding platform for cattle buying. Please note that high speed internet is required – this is not for dial-up or satellite internet. Registration is free, but you must become a member of [www.superiorclicktobid.com](http://www.superiorclicktobid.com) to sign up. Becoming a member is easy - just go to the homepage of [www.superiorclicktobid.com](http://www.superiorclicktobid.com) and follow the out-lined steps to get started. Input your information and select a username and password. You will receive an e-mail confirming you are a member. From that point forward you just have to sign in and select the sale you would like to register for and once approved you will receive an e-mail confirming which sale you are now registered for.

\*If you plan to bid by phone through Superior Livestock or 'Click-to-Bid', you must register at [www.superiorlivestock.com](http://www.superiorlivestock.com) prior to bidding.

**Viewing the Auction.** There are 2 places to view the sale broadcast live on the internet: [www.superiorlivestock.com](http://www.superiorlivestock.com) or [www.superiorclicktobid.com](http://www.superiorclicktobid.com). Just go to the home page of either website and select the auction. If you just want to watch the auction on your computer, smartphone or tablet go to [www.superiorlivestock.com](http://www.superiorlivestock.com), but if you want to bid over the computer you must go to [www.superiorclicktobid.com](http://www.superiorclicktobid.com). Remember you can call in to bid on the internet, but you must be a member of [www.superiorclicktobid.com](http://www.superiorclicktobid.com) to "click-to-bid". Your computer must have Flash Media Player installed for this website to view the auction. If you have any questions, please call the Superior Productions office at 800-431-4452.



### FLY TO SHERIDAN

We are pleased to have Key Lime Air providing two scheduled non-stop flights each weekday from Denver via regional jet service. Rental cars are available from Avis at the Sheridan Airport.

**Key Lime Air**  
[www.flysheridan.com](http://www.flysheridan.com)  
866.373.8513

**Avis Car Rental**  
[www.avis.com](http://www.avis.com)  
307.672.2226



# Family who help us in many ways over the course of the year



*Doug and Sheila Bingham*



*Stephen Forbes and Morgan Baldwin*



*Tallie Forbes and Justin Lee*



*Julia Forbes and Ed Waddington (with Tazmin and Flinder)*



*Doug Foster and Sarah Forbes*



*Elfie Forbes and Ruth Sylvester*



*Jason Brown and Shelley Forbes*



*Spike, Jo, and Keenan Forbes; Jeff, Katie, Julia, Ellen, and Sarah Durkin*



*Kate Bingham and Alison Brody*



*Don Bingham, Alison Brody, and Kate Bingham*



*The extended Forbes family attending the wedding of Cam & Trish's daughter Shelley Forbes to Jason Brown*



# Beckton Stock Farm

Cam Forbes

37 Beckton Drive

Sheridan, WY 82801

Tel.: 307.674.6095, 674.8162 (evening)

Fax: 307.672.7281

Email: [becktonwyo@gmail.com](mailto:becktonwyo@gmail.com)

Web: [www.BecktonRedAngus.com](http://www.BecktonRedAngus.com)

Video of Sale Bulls available on our Website

## FIRST CLASS

### HERD BUILDER INDEX

The **HERDBUILDER INDEX** developed by the RAAA, and now used throughout the breed, (see pages 8-9) weights EPD's according to their effect on overall herd profitability. The Index scores and ranks all Red Angus sires according to their comparative expected profitability when mated to an average set of cows.

**42 of the 50 highest ranking sires in the Red Angus breed for profitability are Beckton sires or descended from Beckton sires, including 17 of the top 20.**

The 251 Beckton sale bulls inside this catalog have an average Herd Builder Index of 150. The average Index for the Red Angus breed is 104. **Statistically the average Beckton bull produces \$46.00 more profit per mating (150-104) compared to other Red Angus bulls.**

**Mated to 150 females over his service lifetime, the average Beckton bull in this sale should produce about \$7,000 more profit from your cow herd.** Beckton genetics will further increase the value of your replacement females, and your cowherd going into the future.

### HERD STAYABILITY

Beckton is the #1 Herd in the breed for Stayability, and has been for many years. **44 of the top 50 sires in the Red Angus breed for Stayability EPD are Beckton sires or descended from Beckton sires, including 17 of the top 20. These are the bulls and heifers that will produce, breed back, and stay in your herd for many years.**

### INTERNET BIDDING

This year Superior Productions will provide internet and representative bidding services for buyers who can't make it to the sale. Please see page 88 for more information.



**Free Delivery**  
anywhere in the Continental US