

# 74th Anniversary Production Sale

Tuesday April 9th, 2019

Industry Leader for  
Low Maintenance, Maternal Traits



**YEARS**

**1 Beckton  
Red Angus**

*Foundation Herd of the Red Angus Breed*



# 1 Beckton Red Angus

37 Beckton Drive • Sheridan, WY 82801 • [becktonwyo@gmail.com](mailto:becktonwyo@gmail.com)  
Office: 307.674.6095 • Evenings: 674.8162 • Fax: 672.7281

Dear Friends and Cattlemen,

This is now our 74th Anniversary sale, and we welcome all of you to join us. We think we have a set of bulls that truly meet the needs of the commercial cattle industry. Especially for those who are aiming to build the best possible cow herd on your ranch. Beckton's herd has long been known for its strong reputation females, females that build a base for many possible breeding programs. Replacement females produced by Beckton bulls see strong commercial demand throughout the United States.

The Red Angus Association changed their methodologies for generating some of the EPD's late last summer. Seven other breeds were included with Red Angus data for the calculations, and it is now an "inter-breed" EPD. Also, the EPD's are now calculated on a nearly continuous basis rather than just twice a year. There has been some shifting in the values, especially the Stayability EPD and HerdBuilder Index, and we don't see as many extremes in these numbers. However Beckton genetics still show up at the upper end of the spectrum. For building a herd with strong maternal traits, we don't think you can do better.

Our bull pictures have a new look this year --- white background. I took the pictures of the bull calves in mid-February, when all we had was snow on the ground and temperatures well below freezing. The bulls, and the heifers, came through the weather just fine. They will be able to go out and work for you in any weather conditions!!

We frequently get asked if we can sell commercial heifers. We do have a portion of our herd which is high percentage 1-B's, but we don't have the numbers to meet this demand. However, this year we are including three pens of commercial yearling heifers.

If you are unable to attend, we continue to offer bidding through Superior Productions on the internet (see the last page of this catalog). We will continue to offer our Conference call for bidding on the phone, or you may call me in the days ahead of the sale to visit about the bulls and place a Sight-Unseen order. Over a quarter of our bulls sell sight unseen, mostly to long-time customers. As always, your satisfaction with every Sight-Unseen animal is guaranteed.

If you can attend, please join us for a complimentary prime rib dinner at the Holiday Inn right after the sale. Lastly, our Sheridan airline service from Denver is in the process of establishing a mutual business relation with United Airlines, and we expect they will be showing up on flight searches in the near future.

On behalf of everyone here at Beckton, we welcome you to join us for our 74th Anniversary Production Sale. The Red Angus breed has become the breed of choice for commercial beef producers, and we believe Beckton has the right kind of Red Angus cattle for commercial profitability into the future. We look forward to seeing you on Tuesday the 9th.

Sincerely,

*Cam Forbes*



**Cam and Trish Forbes**

**Beckton Red Angus • Since 1945  
The Foundation Herd of the Red Angus Breed**

# Sale Information

## Beckton Ranch

9½ miles West of Sheridan

Phone: 307.674.6095

Please join us for a complimentary dinner after the sale at the Holiday Inn.

**Tuesday, April 9th, 2019**

1 o'clock pm (Lunch at noon)

**235 Bulls • 66 Heifers**

Selling in catalog order, heifers sell following the bulls



## Some Facts about the Beckton Herd

The Registered 1-A sale bulls in this catalog have an average HERD BUILDER Index of **212**, compared to the breed average of 177!!! 14 of the top 20 highest ranking sires in the Red Angus breed for HerdBuilder are Beckton sires or descended from Beckton sires.

► **HERD STAYABILITY:** Beckton is the #1 Herd in the breed for Stayability, and has been for many years. **11 of the top 20 sires in the breed for Stayability EPD are Beckton sires or descended from Beckton sires.** These are the bulls and heifers that will produce, breed back, and stay in your herd for many years.

► **LOW MAINTENANCE ENERGY:** Beckton has also been the #1 Herd for Low Maintenance Energy requirements for many years. **13 of the top 20 sires in the entire breed for lowest Maintenance Energy EPD are Beckton sires or descended from Beckton sires.** No other set of bulls will do a better job cutting your cowherd feed requirements.

► **EASY CALVING:** The #1 Herd in the breed for easy calving, with the best average Calving Ease EPD of any major herd. **18 of the top 20 sires in the breed for best Calving Ease EPD are Beckton sires or descended from Beckton sires.** The average Calving Ease EPD of all 235 sale bulls is +16, which is the top 10% of the Red Angus breed.

► **GROWTH RATE from Birth to Market:** No other offering of sale bulls offer this volume of bulls which combine this much calving ease with high growth rate to market weight, together with fertility and Stayability. **And no other offering of sale bulls will combine all of these traits and rank so high on overall herd profitability measured by the Herd Builder Index.**

## Sale Details

### Site-Unseen Purchase

If you are unable to attend the sale, we can help you select the bulls or heifers to fit your needs. Give us a call, letter, fax or email, and we can handle bidding for you according to your directions. Satisfaction is guaranteed on all animals purchased "sight-unseen". Over a quarter of our bulls sell this way, mostly to long-time and repeat customers. To provide adequate time to assist you, please contact us before actual sale day.

### Internet Bidding via Superior Productions

Internet bidding and phone bidding are now available with Superior Productions. See more information on page 3.

### Conference Call Bidding

Conference call bidding will be available with Bill Pelton, Pelton Livestock. See more information on page 3.

### Payments

Payments can be made with cash, check payable to Beckton Stock Farm, Inc. or Visa/Mastercard on sale day.

### All Bulls "Trich" Tested

In all the years we have been selling and delivering bulls, Beckton has never had a bull test positive for "trich". But because an increasing number of states require testing of yearling bulls, and to avoid any delay in delivery time, we will have all the sale bulls tested negative for "trich" prior to the sale. Customers from any state may also come to the sale with their trailer and load out directly after the sale.

### Free Delivery

We provide free delivery for all bulls throughout the continental U.S. If you bring a trailer to haul your own, \$200 will be deducted from the price of each bull. Heifers will be delivered free within 400 miles, and at cost for additional miles. Most of the sale cattle will be delivered from 1 to 3 weeks after the sale, although we will try to accommodate if you need your bulls right away. Although there occasionally are limitations, in most cases we can deliver the cattle directly to your ranch.

## Accommodations

### Holiday Inn

307.672.8931, I-90, Exit 25  
Ask for special Beckton Sale rate of \$79

### Best Western Sheridan Center

307.674.7421, 612 N. Main Street

### Days Inn

307.672.2888, 1104 Brundage Lane

### Super 8 Motel

307.672.9725, 2435 N. Main Street

## Transportation

### Avis Car Rental

307.672.2226, Sheridan Airport

### www.FlySheridan.com

Two jet flights to/from Denver each weekday  
866.373.8513 or flysheridan.com



**Auctioneer Roger Jacobs**  
406.698.7686



**Curt Cox**  
Wyoming Livestock  
Roundup  
307.630.4604



**Pete Crow**  
Western Livestock  
Journal  
303.722.7600



**Bob Hough**  
817.296.0976



**Matt Wznick**  
Tri-State Livestock  
406.89.414



**Alan Sears**  
Western Ag Reporter  
970.454.3986



**Del Tinsley**  
Wyoming Livestock  
Roundup  
307.234.2700

## Additional Sale Information

- ▶ The animals sell in catalog order. We will have a conference call available for telephone bidding. You must register in advance, and conference number and instructions will be available then.
- ▶ All bulls have passed a rigorous fertility exam that included live semen evaluation, scrotal measurements, and reproductive tract examinations.
- ▶ Beckton has a comprehensive herd-wide health program which includes vaccinations for 7-Way, IBR, BVD, PI3, BRSV, Lepto, and ivermectin. The heifers are also vaccinated for bangs and vibrio.
- ▶ When a genetic test was developed by RAAA for osteopetrosis (OS), Beckton tested every sire in use in our program, as well as our major AI sires. Every Beckton bred sire (nearly 80 in total) tested OS Free.
- ▶ We plan to have semen collected on some of the bulls before the sale. We will also work with the buyer to collect bulls after the sale.
- ▶ Buyer receives full possession and one half semen interest in all the bulls in the catalog. Seller is retaining one half interest in all bulls in the catalog. This is done so we can use some of the bulls in herd and reserve the right to collect and market semen on these bulls. Any collection on our behalf would be at our expense and could be done during the off-season and at the convenience of the buyer. The buyer would have the option to share in the collection and retain semen for the buyer's use also. If semen is marketed by either party, Seller receives one half royalty interest on gross semen sales, and buyer receives one half interest. Regardless of semen collection and marketing, the buyer retains full possession, full pasture use rights, and full salvage value in these bulls.
- ▶ Payments can be made with cash, check payable to Beckton Stock Farm, Inc. or Visa/Mastercard on sale day.

### Table of Contents

The Beckton Program . . . . .	4
The Bulls . . . . .	10
The Yearling Heifers . . . . .	57
Ref. Sire Cross Reference. . .	64
Reference Sires. . . . .	65
Sale Terms & Conditions . . .	75
RAAA Herd EPD Tables . . . .	76
Sire Bloodline Charts. . . . .	78
Lot-Tag Cross Reference. . . .	80



**Serving our customers for 74 years with industry leading genetics and the highest quality cattle.**





## BECKTON BULL AND HEIFER WARRANTY

Optional protection against injury or death, plus Pregnancy coverage for heifers

**BULLS:** Injury or loss protection coverage - If your bull is permanently injured or dies any time up to 5 months after purchase, you will receive a credit toward purchase of another bull in the amount of the original purchase price minus salvage. The cost is 5% of the purchase price paid at settlement (eg. \$150 for a \$3,000 bull).

**HEIFERS:** Injury or loss protection plus Pregnancy Guarantee – likewise good for 5 months after purchase. If your heifer fails to become pregnant when exposed to a bull who settles 75% of the other heifers in the same pasture; or in the event your heifer is permanently injured or dies, you will receive a credit toward purchase of another heifer in the amount of the original purchase price minus any salvage. The cost is 10% of the purchase price paid at settlement (eg. \$200 for a \$2,000 heifer).

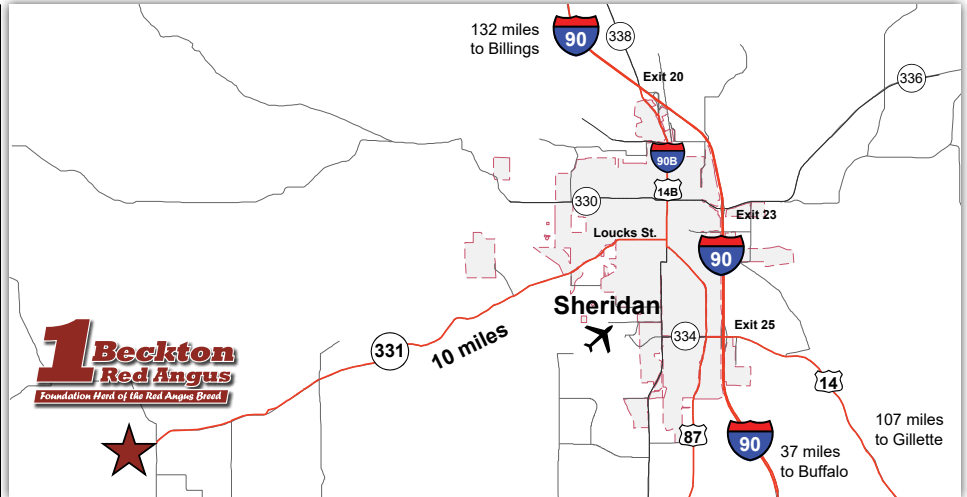

## How to Participate as an Absentee Bidder: 1, 2, or 3

### 1. Site-Unseen Purchase

If you are unable to attend the sale, we can help you select the bulls or heifers to fit your needs. Give us a call, letter, fax or email, and we can handle bidding for you according to your directions. Satisfaction is guaranteed on all animals purchased "sight-unseen". Over a quarter of our bulls sell this way, mostly to long-time and repeat customers. To provide adequate time to assist you, please contact us before actual sale day.

### 2. Superior Livestock Productions

**Turn in Bids Over the Phone.** To get started simply go online to [www.superiorlivestock.com](http://www.superiorlivestock.com) and click on the tab titled "Register for a Buyer Number". Select the registration form for Superior Productions and print the registration form, fill it out and fax it in to Superior Productions at (817) 378-3380 with a signature on it, or scan and email the form to [info@superiorauction.com](mailto:info@superiorauction.com). You can also mail it in to the address provided on the form. Upon receipt of this information Superior will call you with a buyer's number and the bid line phone number that you will use on sale day to place bids over the phone. **Important: If you plan to bid by phone through Superior Livestock or 'Click-to-Bid', you must register at [www.superiorlivestock.com](http://www.superiorlivestock.com) prior to bidding.**

**Click-To-Bid.** This is Superior's online bidding platform for cattle buying. Please note that high speed internet is required – this is not for dial-up or satellite internet. Registration is free, but you must become a member of [www.superiorclicktobid.com](http://www.superiorclicktobid.com) to sign up. Becoming a member is easy - just go to the homepage of [www.superiorclicktobid.com](http://www.superiorclicktobid.com) and follow the out-lined steps to get started. Input your information and select a username and password. You will receive an e-mail confirming you are a member. From that point forward you just have to sign in and select the sale you would like to register for and once approved you will receive an e-mail confirming which sale you are now registered for.

### 3. Sale Day Conference Call

Our goal is to have you in the seats but if you can't make it on sale day, we're fixin' to get you "on the line!"

Easy as 1~2~3  
Call BILL PELTON in Advance to...

1. Pre-Register for your buyer number
2. Receive the toll-free Call in Number & Pin
3. Get last minute instructions for the call

**Pelton Livestock**  
Marketing & Consulting  
www.billpelton.com | 406-671-5100



Buyers purchasing via Superior or Pelton Livestock can mail a check after the sale with brief delivery instructions and an approximate date you would like delivery by. If you would like to pay with a credit card, please call the office the day after the sale

# The Beckton Program

## Cow Size

The goal for Beckton's program has always been to develop breeding seedstock which offer increased levels of performance for the commercial cattleman. Increased performance does not mean maximizing weight and size, which have already reached the upper limit of economic value for the packer and consumer. It does, however, mean increasing performance related to calving percentage and weaning percentage; and increasing performance related to cow maintenance requirements and "pounds of calf per acre" efficiency.

### Size Matters

Beckton cattle are already big enough for the consumer and the packer. Using yearling weight EPD as the best available indicator of market size, the average for our sale bulls is +80, about the same as the Red Angus breed average, so for market size our cattle are directly comparable.

The big difference with Beckton's program is that we select for additional weaning and yearling weight, but with the restriction that we have maintained the same cow size over time. In contrast, the industry has allowed cow size to increase at the same rate as calf size. Cow size is the largest factor determining maintenance requirements. Our goal has been to increase efficiency, not size. No other seedstock breeding program has had such a goal and maintained it for so long.

### Beckton Cow Weight Average (lb.)

Year	1978	1982	1986	1990	1994	1998	2002	2006	2010	2018
Wt.	1,126	1,126	1,064	1,115	1,067	1,125	1,104	1,093	1,068	1,066

(mature lactating cows taken at weaning)

Cow weights vary from year to year depending on grass, weather or other short term factors. But overall our cow size has stayed fairly constant over time.

### The Industry Problem

As shown on the graph on the next page, industry-wide cow size has increased substantially, 34% since 1978. Hay use per cow has increased even more, from 1.43 tons per animal to 1.91 tons.

Why does hay use increase at a faster rate than cow size or production per cow? Hay and grain are supplements to the cow's main diet, which is grass, and grass supply is relatively fixed by environment. Each increase in cow feed requirement must be met entirely by supplements, or by a combination of supplement and reduced stocking rate. A small increase in cow feed requirement leads to a reduction in stocking rate or a large increase in higher-cost, supplemental feed needs.

Any gains achieved in the feedlot sector due to increased animal growth, have been overwhelmed by increased cost of production in the cow-calf sector.



## The Beckton Crew...



Randy Zier



Alan Sanders



Roger Zier



Shelby Whitman

## Efficiency

The graphic at right shows how, for the U.S. cattle industry overall, the increase in average calf weights, as measured by steer slaughter weights, has been directly matched by an increase in average cow weights. (Percentages are based on USDA slaughter weight data for steers and cows respectively, using 1978 as a base year. Data for heifers slaughtered shows an identical trend.) Over 40 years, there has been minimal change in overall cowherd efficiency.

This graph shows the failure of cross-breeding and composite breeding to do little more than simply increase general cattle size. In the promotion of composites, the impact of retained heterosis on mature weight is too often ignored. Crossbreeding and composites are sold as a free lunch, but they aren't free.

The graphic shows Beckton cowherd data over the same time period.

1. Beckton cow size has shown no significant change over the past 40 years, while the industry has experienced a substantial increase in cow size.

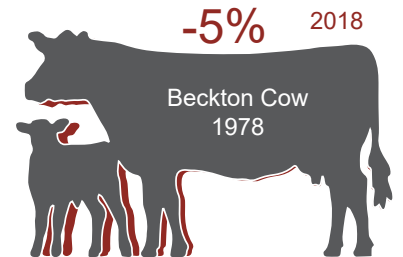
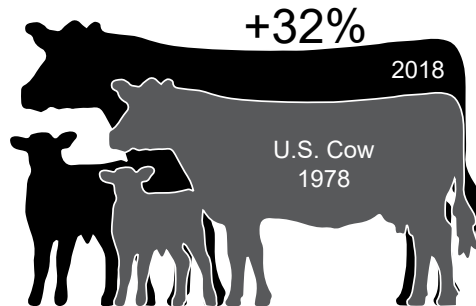
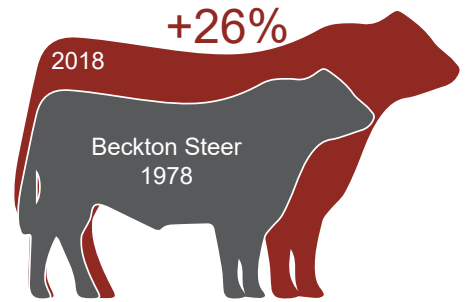
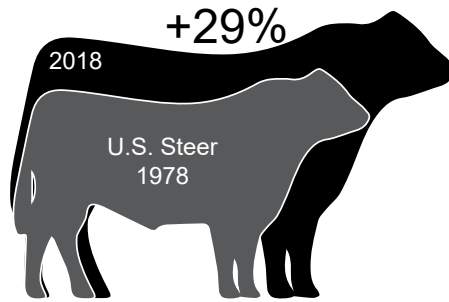

2. Even without increasing cow size, we have raised the rate of early growth in Beckton cattle, using intense genetic selection and generation turnover.
3. The net change in efficiency as measured simply by "calf weight divided by cow weight" is significantly higher with Beckton's genetic program, compared to mainstream cross-breeding based on retained heterosis.

We have accomplished this by selecting for growth, restricting birth weight and cow size creep, and multiplying each incremental change rapidly throughout our entire cowherd and all of our bloodlines. Usually this has meant working within our own bloodlines rather than introducing out-crosses, because the outside genetics for the direction we wanted to go haven't been available. The overall key to success is simply that we have been making small progress in multiple traits, but doing it consistently over a very long period of time.

## ... making the Beckton Program work!



Morgan Armstrong



Matt Zier



Pam Leeper



Kevin Dickerson



## Management

### One Bull – the Simple Solution is the Best Solution

Many cattlemen use Beckton bulls for their heifers because of their low birth weights and high calving ease. Our bulls are even better when used on cows, because replacement heifers tend to be selected from calves out of older cows. **Keeping replacement heifers sired by Beckton bulls is the quickest way to limit cow size creep and to moderate cow size for the future.** In our own program we use the same bulls on both heifers and cows. Every bull is used his first year with heifers to evaluate calving ease, and used in future years with older cows. We get calving ease, growth, and moderate-sized replacements, all with the same bull.

### Quietness and Ease of Handling

The necessity of record keeping means that our cattle will be handled much more than commercial cows. **This benefits our seedstock customers because our cattle will be quieter and easier to handle.** Good disposition is one of our most valued traits.

### Selection for Industry Requirements

In order to make selection decisions appropriate to the commercial beef industry, seedstock cattle need to be managed and measured under conditions which will approximate the commercial industry. **Our cows are run entirely on grass, with hay only if weather conditions require it, because that is how the commercial industry runs cows.** However, almost all commercial calves go into feedlots before slaughter, so feedlot performance and efficiency is an important trait for calves. **Simply put, a producer needs to know how his cows perform on grass, and how his calves perform with feed.**

Our bulls are run on a performance test designed to provide the fairest basis of comparison among them, and

this requires a compromise. Our bulls receive a “growing” ration high in roughage and protein and not as high in energy as a steer would receive. **We want to get a good measure of gainability with which to compare bulls, but we don’t want the bulls fat.**



*Craig Uden, Darr Feeders Manager*  
Photo courtesy of the Lexington Clipper-Herald



*Mitch Ziebell, Darr Feeders*

### Mitch Ziebell, Craig Uden of Darr, NE

Since 1979 all of our bulls have been performance tested at a facility owned and managed by the Kugler family near Cozad, Nebraska. In the fall of 2005, Lane Kugler retired and the operation was bought by a neighboring operation – Darr Feeders. The overall operation is managed by Craig Uden, president of the NCBA, with the bulls under the daily management of Mitch Ziebell. **We have been very impressed with the conscientious care with which Mitch oversees all aspects of the bull management.**

## Contributing to the success of the Beckton Program...



*Sarah Schreiber*  
*Our vet*



*Janet Drake*  
*Health Permit Expert*



*Cody Cunningham*  
*Brand Inspector*



*Dr. Robert Bohlander*  
*Fertility tests the bulls*



*Bob Milner*  
*Our AI tech*



## Additional Facts about the Beckton Program

### Birth weight

- ▶ Every sire entering our own program is used first on our own heifers, then on our cows.
- ▶ We have never used high birth weight sires in any part of our program, so big birth weights are rare.
- ▶ We get the pay weight, but with lower birth weights and greater calving ease.
- ▶ Full production from heifers. We use the same bulls on heifers and cows.

### Growth

- ▶ Weaning efficiency, and rate of gain to slaughter weight second to none.
- ▶ Growth traits must be consistent with maintaining maternal qualities.
- ▶ Beckton cattle are ideally sized for today's packer demand.

### Hardiness

- ▶ Every cow in the herd has spent part of her life in the Big Horn Mountain summer range, at elevations from 7000 to 10,500 feet.
- ▶ In 2001 we PAP tested all of our herd sires. The herd average PAP score was 32.5 at 4000', equivalent to a herd average PAP of 39 at 8000' (excellent scores).
- ▶ By the time she is 5, our average cow will have been trailed over 80 miles, above and beyond normal pasture rotation.

### Efficiency

- ▶ The typical dam of our bulls weans over 50% of her body weight in 205 days, under range conditions, with no creep-feeding.
- ▶ The average dam produces over 100% of her own body weight in a year.
- ▶ The average mature cow (age 5+) weighs about 1100-1125 pounds.

### Fertility

- ▶ Every bull in our program is used in natural service, with 30-50 heifers/cows.
- ▶ Every cow in our program must cycle naturally and breed early under range conditions.

### Value

- ▶ Beckton Red Angus produce more growth without high birth weights.
- ▶ They are the one-bull solution that can be used on both heifers and cows.
- ▶ Carcass quality is an extra benefit.

### Reliability

- ▶ Beckton has been genetically improving Red Angus since 1945, a 30-60 year lead time over other producers.
- ▶ It is a complete, genetically sound breeding program, which demands whole-herd performance.



Lorna Tucker  
Helping out in many ways  
throughout the year



Chuck Overturf  
Friend and neighbor - helps us  
every year



Sherry Kobielus  
Always here to help even after  
retirement



Cody and Chad Halfmann, Halfmann Red Angus

# Beckton History



*Young Sal Forbes up on the mountain.*



*Waldo Forbes - 1st President of the Red Angus Association.*



*Beckton house/office before being moved in 1905 to its current location. This house was built in the 1880s by George Beck, the original homesteader. The antlers are still on the porch, and it is one of the oldest buildings in Sheridan County.*



*The Waldo Forbes family in 1959:  
Ellen, Julia, Sal, Sarah, Cherry, Spike, and Cam & Elfie in front.*



*1960s Beckton Sale with Berdon's broadcast van.*



*Beckton Larkabeau O "220" in 1959 -  
the 1st Red Angus Bull at ABS*



*Mrs. Waldo (Sal) Forbes was honored as the first woman inducted into the Saddle and Sirloin Club's portrait gallery in Louisville, KY.*



---

## Using New Selection Tools

### HerdBuilder and GridMaster Indices

The new Red Angus Association HERDBuilder and GRIDMaster Indices are given for each sale animal, in the box just above the EPDs. The Index number is followed by the “Percentile” showing how that animal ranks compared to all other Red Angus bulls or heifers. A higher Index number results in a lower “Percentile” number, which means a higher ranking within the breed, and is therefore better. The development of these Indices by the RAAA is described in the article written by Larry Keenan and reprinted.

The familiar Birth Weight or Yearling Weight EPDs, for example, are measured in pounds of increase in weight, whereas these Indices are measured in ‘dollars of increase in profitability’ - the expected increase in profit that each animal is expected to generate per mating of that animal. A bull with a HerdBuilder Index of 160, compared to a second bull with an index of 110, should produce  $160 - 110 = 50$  dollars of expected increased profit for each cow to which he is mated, compared to the second bull (note that this is ‘per mating’, not ‘per calf produced’). The Index considers and weights all economic factors – fertility, calving ease, maintenance costs, growth rate, stayability, carcass quality, etc. - according to best available science,

You will find Beckton bulls individually and as a group ranking in the top of the breed for profitability, as measured by these new Indices.

### Maintenance EPD

This EPD predicts the relative feed energy requirement for maintenance, for cows produced by a sire or female. A bull with an ME of -3 (minus 3) is expected to sire replacement daughters which will need 10 fewer mcals of energy per month than a bull with an ME of +7.

We believe this is an important EPD because feed costs, both direct and indirect through ranch overhead, make up by far the largest proportion of operating costs. It can have much more direct impact on ranch profitability than Marbling or Ribeye EPD for example.

The Beckton herd has been one of the breed’s top herd for low maintenance energy requirements for many years.

### Calving Ease

The Red Angus Calving Ease EPD was introduced in 2003, and is a more direct measure of calving ease than birth weight alone. Calving Ease is defined as follows: “The expected differences of calving ease measured as the probability difference (between sires) of unassisted calvings among offspring.” For Calving Ease EPD, the higher number is better.

There are two Calving Ease EPD’s - “Direct”, a predictor of an animal’s own offspring; and “Maternal”, a predictor of a daughters calving ease. Unless stated otherwise, we publish the Calving Ease Direct because most of our customers’ primary concern is selecting bulls for use on first calf heifers.

Beckton’s average Calving Ease EPD is +12, a full eight points higher than the the Red Angus breed average of 4, due to our long history of selection for moderate birth weights. **The average Beckton bull is in the top 4% of the entire breed for highest Calving Ease.**

### Cow Efficiency

We present two indicators of efficiency. The first is Weaning Percent, a simple percentage of calf 205 day weight divided by the dam’s actual weight at weaning. The second is PRI Cow Efficiency. This also measures calf weaning weight, but relative to the cow’s metabolic weight, and is expressed as an index above or below 100.

These efficiency measures are best used as indicators of where an animal is relative to others, rather than directly for selection. For example, if we see an animal with a low efficiency, we would look at the actual calf and cow weights to decide if the calf is too small, or the cow too big for the environment. That in turn will suggest corrective actions. In general, select for the traits you need to change to make cattle more efficient, and efficiency will be the result.

**Beckton has been performance tested selection since 1945, and we believe our cattle today are the most efficient in the industry.**

### Dam Information

A major difference with our catalog is the greater amount of information about the dams we provide. Weaning percent and Cow Efficiency are explained above. In addition, with each sale animal we give the dam’s age when this calf was born, and the dam’s actual weight when the calf was weaned the previous fall. We also provide her progeny averages – the average birth weight, weaning ratio, and yearling ratio – of her calves.

# The Bulls

Our bulls are managed in a manner to gain important performance data and information, and equally importantly, to develop and provide our customers with many years of productive service. We have been testing breeding bulls over 50 years, longer than almost any other producer. Our own breeding is based primarily on natural service, not AI, so we see how our bulls work in the pasture. We use bulls raised and managed just this way, with our own cows and heifers, on every kind of terrain, and high in the Bighorn Mountains.

For the first twenty years our bulls were tested at home here in Wyoming. They received some grain, but otherwise grass pasture and dry hay. In 1979 we moved our test to a facility managed by the Kugler family in Cozad, Nebraska, where the bulls got a ration including silage, corn and protein. When we brought our first bulls home from Kuglers' and used them with

our own cowherd, we discovered a dramatic increase in libido and breeding performance. The effect of proper nutrition was apparent, and the bulls would maintain condition and hold up better through the entire breeding season. We have continued managing our bulls at the same facility ever since (now managed by Craig Uden), and we continue to see the same benefits.

We have since used over 500 of these bulls natural service in our own breeding program, on dry range and in the mountains, and have never had a bull fall out of our program early due to his feeding or testing management. Beckton Julian B571, Lancer F442, Nebula M045, Nebula P707, and all of our other great sires were fed and managed in Cozad. Every year we see the results and success of our bull management program, and we serve many satisfied customers.



Lot 72



• Bulls •

**1** **BECKTON NEBULA F337 J5**  
1-A 100% # 3987716 Tat.: BKT8 F337 

Birth: 3-19-18

Beckton Nebula E P084  
**BECKTON NEBULA EN S347**  
Ref. N

Beckton Eola P530 NB

Beckton Nebula M045  
BKT Pine Marie M119 EP  
Beckton Nebula M045  
Beckton Eola M663 EP  
TR Julian LT151  
Beckton Minerva L278 LN  
Beckton Lancer T5 L095  
Beckton Ruth E549 TP

**BECKTON RUTH U557 JT**  
Beckton Jet L P491  
Beckton Ruth P591 LN

**DAM**  
Age 10  
Wt 1160  
Prog.BW 79  
WR 110  
YR 110  
Wean Pct. 55%  
Cow Eff. 117

BWt 80  
WR 113  
YWt. 1163  
YR 113  
Feb.ADG 3.44  
Feb.Scr. 38  
Fr. 5.5

RAAA HerdBuilder index: **229** (Top 1% of RA breed)  
RAAA GridMaster index: **49** (Top 35% of RA breed)  
Calv.Ease BW WW YW Milk HPG Stay Maint.En.  
EPDs **14 -2.4 61 93 30 19 20 -9.0**  
Marb **+0.43** REA **-0.63** Bfat **+0.04**

★★★★★ for Low Maintenance, Growth, Marbling, Superior Cow, High Cow Efficiency, Calving Ease, Stayability.



Lot 1

**3** **BECKTON ACCENT F191 N5**  
1-A 100% # 3987878 Tat.: BKT8 F191 

Birth: 3-10-18

Beckton Accent Y260 L3  
**BECKTON ACCENT B150 N4**  
Ref. A-2

BKT Larkeisa S055 NB

Beckton Accent W180 C2  
Beckton Lana W463 L  
Beckton Nebula P P707  
Beckton Larkeisa P688 CH  
Beckton Nebula P P707  
Beckton Minerva J615 VG  
Beckton Nebula P P707  
Beckton Minerva U205 NB  
Beckton Minerva F495 CH

**BECKTON MINERVA X047 N**  
Beckton Nebula U206 V3  
Beckton Minerva U205 NB

**DAM**  
Age 8  
Wt 1150  
Prog.BW 70  
WR 106  
YR 105  
Wean Pct. 55%  
Cow Eff. 116

BWt 76  
WR 111  
YWt. 1147  
YR 112  
Feb.ADG 3.83  
Feb.Scr. 38  
Fr. 5.5

RAAA HerdBuilder index: **213** (Top 6% of RA breed)  
RAAA GridMaster index: **49** (Top 35% of RA breed)  
Calv.Ease BW WW YW Milk HPG Stay Maint.En.  
EPDs **14 -2.6 64 100 26 10 21 -4.0**  
Marb **+0.49** REA **-0.31** Bfat **+0.05**

★★★★★ for Low Maintenance, Growth, Marbling, Superior Cow, High Cow Efficiency, Calving Ease, Stayability.



Lot 4

**2** **BECKTON ACCENT F144 E5**  
1-A 100% # 3987930 Tat.: BKT8 F144 

Birth: 3-7-18

Beckton Accent Y260 L3  
**BECKTON ACCENT B150 N4**  
Ref. A-2

BKT Larkeisa S055 NB

Beckton Accent W180 C2  
Beckton Lana W463 L  
Beckton Nebula P P707  
Beckton Larkeisa P688 CH  
Beckton Epic KM M115  
Beckton Sierra N703 LM  
Beckton Vegas PK F485  
Beckton Minerva F433 VG

Beckton Epic K6 S569  
**BECKTON MINERVA X455 E**  
Beckton Minerva J615 VG

**DAM**  
Age 8  
Wt 1050  
Prog.BW 79  
WR 112  
YR 107  
Wean Pct. 63%  
Cow Eff. 134

BWt 83  
WR 117  
YWt. 1101  
YR 107  
Feb.ADG 2.39  
Feb.Scr. 38  
Fr. 6.0

RAAA HerdBuilder index: **207** (Top 9% of RA breed)  
RAAA GridMaster index: **47** (Top 75% of RA breed)  
Calv.Ease BW WW YW Milk HPG Stay Maint.En.  
EPDs **14 -1.8 58 85 29 10 20 -7.0**  
Marb **+0.37** REA **-0.31** Bfat **+0.05**

★★★★★ for Low Maintenance, Growth, Marbling, Superior Cow, High Cow Efficiency, Calving Ease, Stayability.

**4** **BECKTON LIKABLE F425 E5**  
1-A 100% # 3987594 Tat.: BKT8 F425 

Birth: 3-22-18

Beckton Likable X445 J3  
**BECKTON LIKABLE Z057 L4**  
Ref. L-1

Beckton Minola X107 L

Beckton Likable U130 L2  
Beckton Indigo U658 JL  
Beckton Likable U120 L2  
Beckton Minola U188 NB  
Beckton Epic K4 N795  
Beckton Belga K202 LN  
Beckton Nebula H R233  
Beckton Larkaba R809 NB

Beckton Epic T330 L5  
**BECKTON LARKABA W050 E**  
Beckton Larkaba T184 NB

**DAM**  
Age 9  
Wt 1095  
Prog.BW 71  
WR 101  
YR 105  
Wean Pct. 55%  
Cow Eff. 116

BWt 73  
WR 106  
YWt. 1172  
YR 114  
Feb.ADG 4.33  
Feb.Scr. 35  
Fr. 5.5

RAAA HerdBuilder index: **218** (Top 4% of RA breed)  
RAAA GridMaster index: **54** (Top 1% of RA breed)  
Calv.Ease BW WW YW Milk HPG Stay Maint.En.  
EPDs **16 -4.6 59 111 26 13 18 -6.0**  
Marb **+0.41** REA **-0.13** Bfat **+0.04**

★★★★★ for Low Maintenance, Growth, Gainability, Marbling, Calving Ease, Stayability.

• Bulls •

**5** **BECKTON EPIC F228 W8** 

1-A 100% # 3987830 Tat.: BKT8 F228

Birth: 3-13-18

Beckton Epic U749 D5  
Beckton Lydia S069 NB  
Beckton Epic U749 D5  
Beckton Larkaba U475 CT  
Beckton Warrior T1 H281  
Beckton Rose H074 EP  
Beckton Neptune R2 K065  
Beckton Ruth K464 JL

**BECKTON EPIC A286 E7**  
Ref. E-3  
Beckton Epic Y484 N6  
Beckton Larkaba Y648 E

**BECKTON RUTH U325 WR**  
Beckton Warrior N645 T1  
Beckton Ruth M047 NP

BWt	83
WR	112
YWt.	1156
YR	113
Feb.ADG	3.33
Feb.Scr.	38
Fr.	5.5

DAM	
Age	10
Wt	1270
Prog.BW	73
WR	110
YR	105
Wean Pct.	50%
Cow Eff.	106

RAAA HerdBuilder index:	199	(Top 18% of RA breed)						
RAAA GridMaster index:	52	(Top 4% of RA breed)						
Calv.Ease	BW	WW	YW	Milk	HPG	Stay	Maint.En.	
EPDs	14	-1.7	67	111	23	14	17	0.0
Marb	+0.36	REA	-0.15	Bfat	+0.05			



Lot 8

★★★★★ for Low Maintenance, Growth, Marbling, Superior Cow, Calving Ease, Stayability.

**6** **BECKTON ACCENT F469 L4** 

1-A 100% # 3987538 Tat.: BKT8 F469

Birth: 3-24-18

Beckton Cody K1 P014  
Beckton Christy R046 CQ  
Beckton Warrior W534 N4  
Beckton Coca U561 CT  
Beckton Likable U130 L2  
BKT Pine Marie S802 LO  
Beckton Dominor Z1 R610  
Beckton Lana S858 JL

**BECKTON ACCENT D806 W3**  
Ref. A-8  
Beckton Accent W180 C2  
Beckton Coca A907 W

**BECKTON LANA B316 L**  
Beckton Likable Y124 L3  
Beckton Lana W748 D

BWt	60
WR	110
YWt.	1097
YR	111
Feb.ADG	3.44
Feb.Scr.	34
Fr.	5.5

DAM	
Age	4
Wt	1160
Prog.BW	68
WR	114
YR	112
Wean Pct.	49%
Cow Eff.	103

RAAA HerdBuilder index:	223	(Top 2% of RA breed)						
RAAA GridMaster index:	50	(Top 21% of RA breed)						
Calv.Ease	BW	WW	YW	Milk	HPG	Stay	Maint.En.	
EPDs	20	-6.3	53	91	29	12	19	-5.0
Marb	+0.32	REA	+0.01	Bfat	+0.04			

**8** **BECKTON ACCENT F283 A4** 

1-A 100% # 3987774 Tat.: BKT8 F283

Birth: 3-16-18

Beckton Cody K1 P014  
Beckton Christy R046 CQ  
Beckton Nebula EN S347  
Beckton Larkaba N643 HR  
Beckton Accent U777 C2  
BKT Larkeisa S055 NB  
Beckton Nebula T054 H3  
Beckton Minola T675 JC

**BECKTON ACCENT D115 N3**  
Ref. A-5  
Beckton Accent W180 C2  
Beckton Larkaba W272 N

**BECKTON MINOLA B710 A**  
Beckton Accent Y312 N3  
Beckton Minola W064 N

BWt	66
WR	105
YWt.	1122
YR	109
Feb.ADG	3.17
Feb.Scr.	34
Fr.	5.5

DAM	
Age	4
Wt	1105
Prog.BW	51
WR	88
YR	108
Wean Pct.	52%
Cow Eff.	110

RAAA HerdBuilder index:	226	(Top 2% of RA breed)						
RAAA GridMaster index:	49	(Top 35% of RA breed)						
Calv.Ease	BW	WW	YW	Milk	HPG	Stay	Maint.En.	
EPDs	20	-5.3	58	96	29	13	19	-5.0
Marb	+0.29	REA	-0.06	Bfat	+0.05			

★★★★★ for Low Maintenance, Growth, Marbling, Calving Ease, Stayability.

**7** **BECKTON ACCENT F407 N3** 

1-A 100% # 3988568 Tat.: BSF8 F407

Birth: 3-22-18

Beckton Cody KH M390  
Beckton Rose M126 WR  
Beckton Cherokee N N479  
Beckton Christy N740 HR  
Beckton Nebula X353 E3  
Beckton Mona X817 H  
Beckton Clifftop W577 E3  
Beckton Barmaid P323 HR

**BECKTON ACCENT W180 C2**  
Ref. A-1  
Beckton Cody K1 P014  
Beckton Christy R046 CQ

**BECKTON BARMAID B802 N**  
Beckton Nebula Z180 H4  
Beckton Barmaid Z227 C

BWt	71
WR	106
YWt.	1085
YR	109
Feb.ADG	3.11
Feb.Scr.	36
Fr.	6.0

DAM	
Age	4
Wt	905
Prog.BW	66
WR	105
YR	105
Wean Pct.	61%
Cow Eff.	127

RAAA HerdBuilder index:	228	(Top 1% of RA breed)						
RAAA GridMaster index:	50	(Top 17% of RA breed)						
Calv.Ease	BW	WW	YW	Milk	HPG	Stay	Maint.En.	
EPDs	16	-3.4	62	101	27	11	21	-1.0
Marb	+0.28	REA	+0.02	Bfat	+0.04			



Lot 7

★★★★★ for Low Maintenance, Growth, Marbling, Superior Cow, High Cow Efficiency, Calving Ease, Stayability.



• Bulls •

**9** **BECKTON ACCENT F392 L5**  
 1-A 100% # 3987638 Tat.: BKT8 F392



Birth: 3-21-18

Beckton Accent Y260 L3  
**BECKTON ACCENT B150 N4**  
 Ref. A-2 BKT Larkeisa S055 NB

Beckton W180 C2  
 Beckton Lana W463 L  
 Beckton Nebula P P707  
 Beckton Larkeisa P688 CH  
 Beckton Likable X445 J3  
 Beckton Minola X107 L  
 Beckton Nebula T398 V3  
 Beckton Indigo T613 JT

BWt 70  
 WR 114  
 YWt. 1079  
 YR 110  
 Feb.ADG 2.83  
 Feb.Scr. 35  
 Fr. 6.0

**BECKTON INDIGO C269 L**  
 Beckton Likable Z057 L4  
 Beckton Indigo W772 N

DAM	
Age	3
Wt	935
Prog.BW	61
WR	109
YR	105
Wean Pct.	60%
Cow Eff.	126

RAAA HerdBuilder index: 217 (Top 4% of RA breed)  
 RAAA GridMaster index: 50 (Top 24% of RA breed)

Calv.Ease	BW	WW	YW	Milk	HPG	Stay	Maint.En.	
EPDs	14	-2.7	60	94	26	12	20	-6.0
Marb	+.47		REA	-.21		Bfat		+0.5



Lot 9

★★★★★ for Low Maintenance, Growth, Marbling, Superior Cow, High Cow Efficiency, Calving Ease, Stayability.

**10** **BECKTON EPIC F374 L8**  
 1-A 100% # 3987658 Tat.: BKT8 F374



Birth: 3-20-18

Beckton Epic Y484 N6  
**BECKTON EPIC A286 E7**  
 Ref. E-3 Beckton Larkaba Y648 E

Beckton Epic U749 D5  
 Beckton Lydia S069 NB  
 Beckton Epic U749 D5  
 Beckton Larkaba U475 CT  
 Beckton Lancer T A664  
 Bkt Suffeina A828 DM  
 Beckton Julian GG B571  
 Beckton Kit A517 NP

BWt 76  
 WR 113  
 YWt. 1160  
 YR 117  
 Feb.ADG 3.83  
 Feb.Scr. NA  
 Fr. 5.5

**BECKTON KIT S545 LN**  
 Beckton Lancer F442 T  
 Beckton Kit F468 JL

DAM	
Age	12
Wt	1220
Prog.BW	66
WR	96
YR	97
Wean Pct.	48%
Cow Eff.	101

RAAA HerdBuilder index: 203 (Top 13% of RA breed)  
 RAAA GridMaster index: 52 (Top 4% of RA breed)

Calv.Ease	BW	WW	YW	Milk	HPG	Stay	Maint.En.	
EPDs	16	-3.4	56	95	24	10	17	-5.0
Marb	+.37		REA	+.00		Bfat		+0.4

★★★★★ for Low Maintenance, Growth, Marbling, Calving Ease, Stayability.

**12** **BECKTON ACCENT F691 N4**  
 1-A 100% # 3988348 Tat.: BSF8 F691



Birth: 4-11-18

Beckton Accent W180 C2  
**BECKTON ACCENT B549 N3**  
 Ref. A-3 Beckton Minerva Y654 N

Beckton Cody K1 P014  
 Beckton Christy R046 CQ  
 Beckton Nebula T398 V3  
 Beckton Minerva M369 LO  
 Beckton Nebula W065 C3  
 Beckton Rose W402 N  
 Beckton Julian U742 W5  
 Beckton Minerva U586 CT

BWt 76  
 WR 108  
 YWt. 1113  
 YR 109  
 Feb.ADG 3.28  
 Feb.Scr. 35  
 Fr. 5.5

**BECKTON MINERVA A470 N**  
 Beckton Nebula Y036 N4  
 Beckton Minerva Y520 J

DAM	
Age	5
Wt	1005
Prog.BW	70
WR	105
YR	104
Wean Pct.	61%
Cow Eff.	129

RAAA HerdBuilder index: 230 (Top 1% of RA breed)  
 RAAA GridMaster index: 52 (Top 3% of RA breed)

Calv.Ease	BW	WW	YW	Milk	HPG	Stay	Maint.En.	
EPDs	14	-1.5	61	104	25	12	21	-4.0
Marb	+.35		REA	+.10		Bfat		+0.03

★★★★★ for Low Maintenance, Growth, Marbling, Superior Cow, High Cow Efficiency, Calving Ease, Stayability.

**11** **BECKTON EPIC F351 L7**  
 1-A 100% # 3988602 Tat.: BSF8 F351



Birth: 3-19-18

Beckton Epic X464 L5  
**BECKTON EPIC B310 J6**  
 Ref. E-4 Beckton Minerva Y116 J

Beckton Epic K6 S569  
 Beckton Lana M393 LN  
 Beckton Julian W743 H5  
 Beckton Minerva W081 N  
 Beckton Lancer F442 T  
 Beckton Kit F468 JL  
 Beckton Neptune R2 K065  
 Beckton Jane J874 CC

BWt 77  
 WR 101  
 YWt. 1089  
 YR 106  
 Feb.ADG 3.67  
 Feb.Scr. 34  
 Fr. 6.0

**BECKTON JANE B220 L**  
 Beckton Legend S670  
 Beckton Jane P410 NP

DAM	
Age	4
Wt	1100
Prog.BW	69
WR	107
YR	106
Wean Pct.	51%
Cow Eff.	107

RAAA HerdBuilder index: 202 (Top 14% of RA breed)  
 RAAA GridMaster index: 49 (Top 38% of RA breed)

Calv.Ease	BW	WW	YW	Milk	HPG	Stay	Maint.En.	
EPDs	13	-1.4	59	93	26	15	18	-6.0
Marb	+.29		REA	-.12		Bfat		+0.2

★★★★★ for Low Maintenance, Growth, Marbling, Superior Cow, Calving Ease, Stayability.



Lot 10

• Bulls •

**13 BECKTON ACCENT F436 D4**  
1-A 100% # 3988552 Tat.: BSF8 F436



Birth: 3-23-18

Beckton Accent U777 C2  
**BECKTON ACCENT B653 C3**  
 Ref. A-4  
 Beckton Christy W779 C

Beckton Cody K1 P014  
 Beckton Susan R022 CQ  
 BKT Clifftop TP R288  
 Beckton Christy S151 NB  
 Beckton Dominor Z E401  
 Beckton Barmaid J012 CO  
 Beckton Hustler CN J102  
 Beckton Minola K527 CO

BWt 89  
 WR 108  
 YWt. 1126  
 YR 110  
 Feb.ADG 3.56  
 Feb.Scr. 36  
 Fr. 5.5

**BECKTON MINOLA S674 DM**  
 Beckton Dominor ZC M919  
 Beckton Minola N760 HU

**DAM**  
 Age 12  
 Wt 1135  
 Prog.BW 76  
 WR 104  
 YR 107  
 Wean Pct. 53%  
 Cow Eff. 111

RAAA HerdBuilder index: 206 (Top 11% of RA breed)  
 RAAA GridMaster index: 50 (Top 14% of RA breed)

Calv.Ease	BW	WW	YW	Milk	HPG	Stay	Maint.En.
EPDs 14	0.2	62	103	25	13	18	-6.0

Marb +.34 REA -.10 Bfat +.03



Lot 13

★★★★★ for Low Maintenance, Growth, Marbling, Superior Cow, Calving Ease, Stayability.

**14 BECKTON ACCENT F239 N5**  
1-A 100% # 3987818 Tat.: BKT8 F239



Birth: 3-14-18

Beckton Accent Y260 L3  
**BECKTON ACCENT B150 N4**  
 Ref. A-2  
 BKT Larkeisa S055 NB

Beckton Accent W180 C2  
 Beckton Lana W463 L  
 Beckton Nebula P P707  
 Beckton Larkeisa P688 CH  
 Beckton Nebula E P084  
 Beckton Eola P530 NB  
 Beckton Loki C M740  
 Beckton Eola J454 JL

BWt 56  
 WR 108  
 YWt. 1061  
 YR 104  
 Feb.ADG 3.33  
 Feb.Scr. 37  
 Fr. 5.5

**BECKTON EOLA U027 NB**  
 Beckton Nebula EN S347  
 Beckton Eola S317 LO

**DAM**  
 Age 10  
 Wt 1035  
 Prog.BW 68  
 WR 113  
 YR 107  
 Wean Pct. 59%  
 Cow Eff. 125

RAAA HerdBuilder index: 198 (Top 19% of RA breed)  
 RAAA GridMaster index: 47 (Top 84% of RA breed)

Calv.Ease	BW	WW	YW	Milk	HPG	Stay	Maint.En.
EPDs 19	-5.7	52	77	30	15	17	-5.0

Marb +.50 REA -.41 Bfat +.06

★★★★★ for Low Maintenance, Marbling, Superior Cow, High Cow Efficiency, Calving Ease, Stayability.

**16 BECKTON RANGER F415 N6**  
1-A 100% # 3987610 Tat.: BKT8 F415



Birth: 3-22-18

Beckton Ranger Z225 J4  
**BECKTON RANGER B006 D5**  
 Ref. R-1  
 Beckton Suffeina Z731 D

Beckton Ranger T603 H3  
 Beckton Mona U564 JT  
 Beckton Dominor W640 C5  
 Beckton Suffeina W471 W  
 Beckton Nebula U206 V3  
 Beckton Tamara U185 NB  
 Beckton Heritage T270 J2  
 BKT Pine Marie R246 JE

BWt 81  
 WR 121  
 YWt. 1094  
 YR 110  
 Feb.ADG 3.39  
 Feb.Scr. 34  
 Fr. 6.0

**BKT PINE MARIE Z177 N**  
 Beckton Nebula X096 N4  
 BKT Pine Marie X540 H

**DAM**  
 Age 6  
 Wt 1260  
 Prog.BW 74  
 WR 118  
 YR 106  
 Wean Pct. 51%  
 Cow Eff. 108

RAAA HerdBuilder index: 176 (Top 57% of RA breed)  
 RAAA GridMaster index: 49 (Top 31% of RA breed)

Calv.Ease	BW	WW	YW	Milk	HPG	Stay	Maint.En.
EPDs 12	-1.1	65	100	26	13	16	-2.0

Marb +.43 REA -.11 Bfat +.04

★★★★★ for Low Maintenance, Growth, Marbling, Superior Cow, Calving Ease, Stayability.

**15 BECKTON NEBULA F458 A4**  
1-A 100% # 3987556 Tat.: BKT8 F458



Birth: 3-24-18

Beckton Nebula P P707  
**BECKTON NEBULA B557 J3**  
 Ref. N-3  
 Beckton Larkaba T813 JC

Beckton Nebula M045  
 Beckton Lana M809 EP  
 Beckton Justice CH M056  
 Beckton Larkaba P645 JL  
 Beckton Cody K1 P014  
 Beckton Christy R046 CQ  
 Beckton Julian G1 J526  
 Beckton Lana H533 LN

BWt 71  
 WR 105  
 YWt. 1027  
 YR 100  
 Feb.ADG 2.83  
 Feb.Scr. 38  
 Fr. 5.5

**BECKTON LANA Z916 A**  
 Beckton Accent W180 C2  
 Beckton Lana N664 JL

**DAM**  
 Age 6  
 Wt 1170  
 Prog.BW 66  
 WR 104  
 YR 99  
 Wean Pct. 51%  
 Cow Eff. 108

RAAA HerdBuilder index: 235 (Top 1% of RA breed)  
 RAAA GridMaster index: 49 (Top 28% of RA breed)

Calv.Ease	BW	WW	YW	Milk	HPG	Stay	Maint.En.
EPDs 15	-3.6	56	90	26	11	23	-4.0

Marb +.38 REA -.08 Bfat +.03

★★★★★ for Low Maintenance, Marbling, Calving Ease, Stayability.

**17 BECKTON ACCENT F289 E5**  
2 100% # 3988654 Tat.: BSF8 F289



Birth: 3-17-18

Beckton Accent Y260 L3  
**BECKTON ACCENT B150 N4**  
 Ref. A-2  
 BKT Larkeisa S055 NB

Beckton Accent W180 C2  
 Beckton Lana W463 L  
 Beckton Nebula P P707  
 Beckton Larkeisa P688 CH  
 Beckton Epic T330 L5  
 Beckton Kit R503 LN  
 BKT Clifftop TP R288  
 Beckton Minola R604 CD

BWt 69  
 WR 103  
 YWt. 1035  
 YR 101  
 Feb.ADG 2.50  
 Feb.Scr. 35  
 Fr. 6.0

**BECKTON MINOLA B307 E**  
 Beckton Epic X330 L6  
 Beckton Minola W808 C

**DAM**  
 Age 4  
 Wt 1175  
 Prog.BW 70  
 WR 101  
 YR 104  
 Wean Pct. 48%  
 Cow Eff. 101

RAAA HerdBuilder index: 191 (Top 30% of RA breed)  
 RAAA GridMaster index: 49 (Top 46% of RA breed)

Calv.Ease	BW	WW	YW	Milk	HPG	Stay	Maint.En.
EPDs 15	-3.0	59	92	24	10	18	-4.0

Marb +.50 REA -.32 Bfat +.05

★★★★★ for Low Maintenance, Marbling, Calving Ease, Stayability.



• Bulls •

**18** **BECKTON EPIC F512 C2** 

1-A 100% # 3987484 Tat.: BKT8 F512

Birth: 3-27-18

Beckton Epic K F075  
**BECKTON EPIC KM M115**  
 Ref. E Beckton Minerva F495 CH

Beckton Epic D404  
 Beckton Belga D483 KR  
 Beckton Champ RA583  
 Beckton Minerva CB69 JL  
 BKT Clifftop TP R288  
 Beckton Lydia S274 EP  
 Beckton Warrior T C371  
 Beckton Rose D741 LN

BWt 90  
 WR 116  
 YWt. 1242  
 YR 121  
 Feb.ADG 3.89  
 Feb.Scr. 37  
 Fr. 6.0

**BECKTON ROSE A430 C**  
 Beckton Clifftop W692 E3  
 Beckton Rose M126 WR

**DAM**  
 Age 5  
 Wt 1290  
 Prog.BW 72  
 WR 108  
 YR 108  
 Wean Pct. 51%  
 Cow Eff. 108

RAAA HerdBuilder index: **195** (Top 23% of RA breed)  
 RAAA GridMaster index: **53** (Top 2% of RA breed)

Calv.Ease	BW	WW	YW	Milk	HPG	Stay	Maint.En.
EPDs	11	0.1	70	122	29	9	17 1.0

Marb **+0.31** REA **-.42** Bfat **+0.04**



Lot 20

★★★★★ for Low Maintenance, Growth, Marbling, Superior Cow, Calving Ease, Stayability.

**19** **BECKTON EPIC F156 A7** 

1-A 100% # 3988750 Tat.: BSF8 F156

Birth: 3-8-18

Beckton Epic U749 D5  
**BECKTON EPIC Z674 E6**  
 Ref. E-2 Beckton Indigo U504 EP

Beckton Epic K4 N795  
 Beckton Denise R308 DM  
 Beckton Epic K6 S569  
 Beckton Indigo S016 NB  
 Beckton Cody K2 R168  
 Beckton Belga R716 DM  
 Beckton Julian 7526G  
 Beckton Lana L665 VG

BWt 61  
 WR 109  
 YWt. 1150  
 YR 112  
 Feb.ADG 3.22  
 Feb.Scr. 34  
 Fr. 5.5

**BECKTON LANA W125 A**  
 Beckton Action T061 D1  
 Beckton Lana T674 JL

**DAM**  
 Age 9  
 Wt 1230  
 Prog.BW 56  
 WR 96  
 YR 103  
 Wean Pct. 50%  
 Cow Eff. 106

RAAA HerdBuilder index: **198** (Top 19% of RA breed)  
 RAAA GridMaster index: **50** (Top 14% of RA breed)

Calv.Ease	BW	WW	YW	Milk	HPG	Stay	Maint.En.
EPDs	18	-5.3	61	107	25	12	16 -5.0

Marb **+0.24** REA **-.01** Bfat **+0.05**

**20** **BECKTON EPIC F340 N7** 

1-A 100% # 3987710 Tat.: BKT8 F340

Birth: 3-19-18

Beckton Epic U749 D5  
**BECKTON EPIC B483 N6**  
 Ref. E-5 BKT Pine Marie X339 N

Beckton Epic K4 N795  
 Beckton Denise R308 DM  
 Beckton Nebula T269 E2  
 BKT Pine Marie S467 JE  
 Beckton Nebula M045  
 Beckton Lakme LA06 JL  
 Beckton Epic KH P678  
 Beckton Coca P328 EP

BWt 76  
 WR 115  
 YWt. 1158  
 YR 117  
 Feb.ADG 3.22  
 Feb.Scr. 33  
 Fr. 5.5

**BECKTON COCA W823 N**  
 Beckton Nebula G S237  
 Beckton Coca S043 EP

**DAM**  
 Age 9  
 Wt 1250  
 Prog.BW 67  
 WR 100  
 YR 104  
 Wean Pct. 49%  
 Cow Eff. 104

RAAA HerdBuilder index: **166** (Top 72% of RA breed)  
 RAAA GridMaster index: **53** (Top 2% of RA breed)

Calv.Ease	BW	WW	YW	Milk	HPG	Stay	Maint.En.
EPDs	12	-2.3	60	108	25	13	13 1.0

Marb **+0.37** REA **-.25** Bfat **+0.05**

★★★★★ for Low Maintenance, Growth, Marbling, Calving Ease, Stayability.

★★★★★ for Low Maintenance, Growth, Marbling, Calving Ease, Stayability.



Lot 19

**21** **BECKTON ACCENT F116 W3** 

1-A 100% # 3987960 Tat.: BKT8 F116

Birth: 3-3-18

Beckton Cody K1 P014  
**BECKTON ACCENT W180 C2**  
 Ref. A-1 Beckton Christy R046 CQ

Beckton Cody KH M390  
 Beckton Rose M126 WR  
 Beckton Cherokee N N479  
 Beckton Christy N740 HR  
 Beckton Warrior W534 N4  
 Beckton Susan W058 E  
 Beckton Nebula U206 V3  
 Beckton Minola R720 JJ

BWt 62  
 WR 99  
 YWt. 1044  
 YR 105  
 Feb.ADG 3.22  
 Feb.Scr. 38  
 Fr. 6.0

**BECKTON MINOLA A873 W**  
 Beckton Warrior Y108 E5  
 Beckton Minola Y687 N

**DAM**  
 Age 5  
 Wt 1055  
 Prog.BW 62  
 WR 108  
 YR 106  
 Wean Pct. 50%  
 Cow Eff. 106

RAAA HerdBuilder index: **232** (Top 1% of RA breed)  
 RAAA GridMaster index: **49** (Top 41% of RA breed)

Calv.Ease	BW	WW	YW	Milk	HPG	Stay	Maint.En.
EPDs	20	-6.4	54	91	28	10	21 -3.0

Marb **+0.21** REA **-.03** Bfat **+0.03**

★★★★★ for Low Maintenance, Growth, Marbling, Superior Cow, Calving Ease, Stayability.



• Bulls •



Lot 22

## 24

**BECKTON EPIC F204 N7**  
1-A 100% # 3988716 Tat.: BSF8 F204

Birth: 3-11-18

Beckton Epic U749 D5

**BECKTON EPIC Z674 E6**  
Ref. E-2

Beckton Indigo U504 EP

Beckton Nebula EN S347

**BECKTON LANA W518 N**

Beckton Lana P073 EP

**DAM**

Age 9  
Wt 1185  
Prog.BW 67  
WR 110  
YR 108  
Wean Pct. 53%  
Cow Eff. 112

Beckton Epic K4 N795

Beckton Denise R308 DM

Beckton Epic K6 S569

Beckton Indigo S016 NB

Beckton Nebula E P084

Beckton Eola P530 NB

Beckton Epic KM M115

Beckton Lana M393 LN

BWt 52  
WR 111  
YWt. 1025  
YR 100  
Feb.ADG 2.39  
Feb.Scr. 34  
Fr. 5.0

RAAA HerdBuilder index: **201** (Top 15% of RA breed)  
RAAA GridMaster index: **47** (Top 78% of RA breed)

Calv.Ease	BW	WW	YW	Milk	HPG	Stay	Maint.En.
EPDs 18	-5.7	53	86	35	15	18	-3.0

Marb **+0.34** REA **-0.27** Bfat **+0.06**

★★★★★ for Low Maintenance, Marbling, Superior Cow, Calving Ease, Stayability.

## 22

**BECKTON WARRIOR F029 L7**  
1-A 100% # 3988042 Tat.: BKT8 F029

Birth: 2-17-18

Beckton Warrior Y108 E5

**BECKTON WARRIOR D359 L6**  
Ref. W-1

Beckton Lana W463 L

Beckton Likable Y124 L3

**BECKTON KIT D510 L**

Beckton Kit A102 O

**DAM**

Age 2  
Wt 835  
Prog.BW 61  
WR 112  
YR 105  
Wean Pct. 62%  
Cow Eff. 130

Beckton Warrior W534 N4

Beckton Susan W058 E

Beckton Loki CL S284

Beckton Lana R327 EP

Beckton Likable U130 L2

BKT Pine Marie S802 LO

Beckton Janus X799 L2

Beckton Kit S545 LN

BWt 61  
WR 112  
YWt. 1067  
YR 105  
Feb.ADG 3.22  
Feb.Scr. 36  
Fr. 5.5

RAAA HerdBuilder index: **191** (Top 29% of RA breed)  
RAAA GridMaster index: **50** (Top 26% of RA breed)

Calv.Ease	BW	WW	YW	Milk	HPG	Stay	Maint.En.
EPDs 18	-4.5	56	93	27	11	16	-3.0

Marb **+0.25** REA **+0.02** Bfat **+0.04**

★★★★★ for Low Maintenance, Growth, Marbling, Superior Cow, High Cow Efficiency, Calving Ease, Stayability.

## 25

**BECKTON LIKABLE F293 A5**  
1-A 100% # 3987758 Tat.: BKT8 F293

Birth: 3-17-18

Beckton Likable X445 J3

**BECKTON LIKABLE Z057 L4**  
Ref. L-1

Beckton Minola X107 L

Beckton Accent U777 C2

**BECKTON MINERVA A759 A**

Beckton Minerva X047 N

**DAM**

Age 5  
Wt 955  
Prog.BW 57  
WR 95  
YR 101  
Wean Pct. 58%  
Cow Eff. 122

Beckton Likable U130 L2

Beckton Indigo U658 JL

Beckton Likable U120 L2

Beckton Minola U188 NB

Beckton Cody K1 P014

Beckton Susan R022 CQ

Beckton Nebula U206 V3

Beckton Minerva U205 NB

BWt 71  
WR 97  
YWt. 1071  
YR 104  
Feb.ADG 3.17  
Feb.Scr. 40  
Fr. 5.0

RAAA HerdBuilder index: **219** (Top 3% of RA breed)  
RAAA GridMaster index: **52** (Top 5% of RA breed)

Calv.Ease	BW	WW	YW	Milk	HPG	Stay	Maint.En.
EPDs 16	-4.7	54	98	28	12	20	-9.0

Marb **+0.40** REA **+0.07** Bfat **+0.03**

★★★★★ for Low Maintenance, Marbling, High Cow Efficiency, Calving Ease, Stayability.

## 23

**BECKTON DOMINOR F371 N8**  
1-A 100% # 3987662 Tat.: BKT8 F371

Birth: 3-20-18

Beckton Dominor Y005 V6

**BECKTON DOMINOR A378 W7**  
Ref. D-1

Beckton Lana Y541 W

Beckton Nebula T398 V3

**BECKTON INDIGO W165 N**

Beckton Indigo T298 JM

**DAM**

Age 9  
Wt 1115  
Prog.BW 67  
WR 102  
YR 102  
Wean Pct. 55%  
Cow Eff. 115

Beckton Dominor W640 C5

Beckton Belga W108 V

Beckton Warrior T248 L5

Beckton Lana S074 EP

Beckton Nebula L P093

Beckton Minerva J615 VG

Beckton Jerome E N786

Beckton Indigo P078 NP

BWt 62  
WR 114  
YWt. 1003  
YR 101  
Feb.ADG 2.50  
Feb.Scr. 36  
Fr. 5.0

RAAA HerdBuilder index: **210** (Top 7% of RA breed)  
RAAA GridMaster index: **49** (Top 28% of RA breed)

Calv.Ease	BW	WW	YW	Milk	HPG	Stay	Maint.En.
EPDs 20	-4.9	51	83	29	15	17	-1.0

Marb **+0.38** REA **-0.02** Bfat **+0.05**

★★★★★ for Low Maintenance, Marbling, Calving Ease, Stayability.



Lot 25

• Bulls •

## 26 BECKTON ACCENT F414 L5

1-A 100% # 3987612 Tat.: BKT8 F414

Birth: 3-22-18

Beckton Accent Y260 L3  
**BECKTON ACCENT B150 N4**  
 Ref. A-2 BKT Larkeisa S055 NB

Beckton Loki CL S284  
**BECKTON SUSAN W846 L**  
 Beckton Susan S684 JJ

Beckton Accent W180 C2  
 Beckton Lana W463 L  
 Beckton Nebula P P707  
 Beckton Larkeisa P688 CH  
 Beckton Loki C M740  
 Beckton Lakme J460 LT  
 Beckton Juno N493  
 Beckton Susan M144 CH

BWt 66  
 WR 105  
 YWt. 1035  
 YR 104  
 Feb.ADG 3.17  
 Feb.Scr. 36  
 Fr. 5.5

**DAM**  
 Age 9  
 Wt 1260  
 Prog.BW 67  
 WR 102  
 YR 107  
 Wean Pct. 44%  
 Cow Eff. 94

RAAA HerdBuilder index: 187 (Top 37% of RA breed)  
 RAAA GridMaster index: 48 (Top 63% of RA breed)

Calv.Ease	BW	WW	YW	Milk	HPG	Stay	Maint.En.
EPDs 17	-4.5	56	85	25	10	17	0.0

Marb +.42 REA -.28 Bfat +.04

★★★★★ for Low Maintenance, Marbling, Calving Ease, Stayability.

## 29 BECKTON LIKABLE F482 N5

1-A 100% # 3987522 Tat.: BKT8 F482

Birth: 3-25-18

Beckton Likable X445 J3  
**BECKTON LIKABLE Z057 L4**  
 Ref. L-1 Beckton Minola X107 L

Beckton Nebula W486 D3  
**BECKTON EMERA B285 N**  
 Beckton Emera Y009 D

Beckton Likable U130 L2  
 Beckton Indigo U658 JL  
 Beckton Likable U120 L2  
 Beckton Minola U188 NB  
 Beckton Nebula L P093  
 Beckton Belga R716 DM  
 Beckton Dominor W640 C5  
 Beckton Emera W092 N

BWt 70  
 WR 101  
 YWt. 1083  
 YR 106  
 Feb.ADG 3.17  
 Feb.Scr. 34  
 Fr. 5.0

**DAM**  
 Age 4  
 Wt 1080  
 Prog.BW 70  
 WR 105  
 YR 108  
 Wean Pct. 51%  
 Cow Eff. 108

RAAA HerdBuilder index: 229 (Top 1% of RA breed)  
 RAAA GridMaster index: 52 (Top 3% of RA breed)

Calv.Ease	BW	WW	YW	Milk	HPG	Stay	Maint.En.
EPDs 17	-4.6	56	101	24	15.5	20	-7.0

Marb +.39 REA -.04 Bfat +.04

★★★★★ for Low Maintenance, Growth, Marbling, Superior Cow, Calving Ease, Stayability.

## 27 BECKTON ACCENT F559 N3

1-A 100% # 3988460 Tat.: BSF8 F559

Birth: 3-30-18

Beckton Cody K1 P014  
**BECKTON ACCENT W180 C2**  
 Ref. A-1 Beckton Christy R046 CQ

Beckton Nebula T398 V3  
**BECKTON LANA X466 N**  
 Beckton Lana T226 NB

Beckton Cody KH M390  
 Beckton Rose M126 WR  
 Beckton Cherokee N N479  
 Beckton Christy N740 HR  
 Beckton Nebula L P093  
 Beckton Minerva J615 VG  
 Beckton Nebula E P084  
 Beckton Lana P026 DM

BWt 74  
 WR 113  
 YWt. 1055  
 YR 103  
 Feb.ADG 2.50  
 Feb.Scr. 32  
 Fr. 5.0

**DAM**  
 Age 8  
 Wt 1270  
 Prog.BW 70  
 WR 107  
 YR 104  
 Wean Pct. 51%  
 Cow Eff. 107

RAAA HerdBuilder index: 242 (Top 1% of RA breed)  
 RAAA GridMaster index: 49 (Top 37% of RA breed)

Calv.Ease	BW	WW	YW	Milk	HPG	Stay	Maint.En.
EPDs 16	-3.3	60	95	27	13	23	-2.0

Marb +.29 REA +.01 Bfat +.04

★★★★★ for Low Maintenance, Marbling, Superior Cow, Calving Ease, Stayability.

## 30 BECKTON EPIC F385 S7

1-A 100% # 3988580 Tat.: BSF8 F385

Birth: 3-21-18

Beckton Epic X464 L5  
**BECKTON EPIC B310 J6**  
 Ref. E-4 Beckton Minerva Y116 J

Beckton Scamp X494 E3  
**BECKTON PINE MARIE B359 S**  
 BKT Pine Marie X204 J

Beckton Epic K6 S569  
 Beckton Lana M393 LN  
 Beckton Julian W743 H5  
 Beckton Minerva W081 N  
 Beckton Scamp T A825  
 Beckton Lana S074 EP  
 Beckton Jet L P491  
 BKT Pine Marie S802 LO

BWt 70  
 WR 110  
 YWt. 1092  
 YR 106  
 Feb.ADG 2.94  
 Feb.Scr. 34  
 Fr. 5.5

**DAM**  
 Age 4  
 Wt 1015  
 Prog.BW 62  
 WR 102  
 YR 100  
 Wean Pct. 60%  
 Cow Eff. 125

RAAA HerdBuilder index: 186 (Top 38% of RA breed)  
 RAAA GridMaster index: 48 (Top 48% of RA breed)

Calv.Ease	BW	WW	YW	Milk	HPG	Stay	Maint.En.
EPDs 16	-3.4	58	92	28	15	15	-3.0

Marb +.27 REA -.16 Bfat +.03

★★★★★ for Low Maintenance, Growth, Marbling, High Cow Efficiency, Calving Ease, Stayability.

## 28 BECKTON LIKABLE F506 S6

1-A 100% # 3987490 Tat.: BKT8 F506

Birth: 3-26-18

Beckton Likable Z057 L4  
**BECKTON LIKABLE B032 C5**  
 Ref. L-2 Beckton Mona Z270 C

Beckton Scamp T A825  
**BECKTON INDIGO A297 S**  
 Beckton Indigo W772 N

Beckton Likable X445 J3  
 Beckton Minola X107 L  
 Beckton Clifftop W577 E3  
 Beckton Mona U584 CD  
 Beckton Scamp 8954  
 BKT Encino 8459 TJ  
 Beckton Nebula T398 V3  
 Beckton Indigo T613 JT

BWt 86  
 WR 99  
 YWt. 1081  
 YR 105  
 Feb.ADG 3.11  
 Feb.Scr. 37  
 Fr. 5.5

**DAM**  
 Age 5  
 Wt 1025  
 Prog.BW 65  
 WR 106  
 YR 105  
 Wean Pct. 55%  
 Cow Eff. 116

RAAA HerdBuilder index: 209 (Top 8% of RA breed)  
 RAAA GridMaster index: 52 (Top 4% of RA breed)

Calv.Ease	BW	WW	YW	Milk	HPG	Stay	Maint.En.
EPDs 14	-3.0	53	98	28	14	18	-9.0

Marb +.39 REA -.17 Bfat +.04

★★★★★ for Low Maintenance, Growth, Marbling, Superior Cow, High Cow Efficiency, Calving Ease, Stayability.



Lot 28

• Bulls •

## 31 BECKTON WARRIOR F017 A7

1-A 100% # 3988882 Tat.: BSF8 F017

Birth: 2-14-18

Beckton Warrior Y108 E5  
**BECKTON WARRIOR D359 L6**  
 Ref. W-1

Beckton Lana W463 L

Beckton Accent W180 C2  
**BECKTON LANA D754 A**  
 Beckton Lana N291 JC

Beckton Warrior W534 N4  
 Beckton Susan W058 E  
 Beckton Loki CL S284  
 Beckton Lana R327 EP  
 Beckton Cody K1 P014  
 Beckton Christy R046 CQ  
 Beckton Justice G302  
 Beckton Lana H725 CH

BWt 59  
 WR 111  
 YWt. 1005  
 YR 104  
 Feb.ADG 2.83  
 Feb.Scr. 33  
 Fr. 5.5

**DAM**

Age 2  
 Wt 900  
 Prog.BW 59  
 WR 112  
 YR 104  
 Wean Pct. 54%  
 Cow Eff. 113

RAAA HerdBuilder index: **187** (Top 36% of RA breed)  
 RAAA GridMaster index: **48** (Top 68% of RA breed)

Calv.Ease	BW	WW	YW	Milk	HPG	Stay	Maint.En.
EPDs	16	-4.1	55	83	26	11	-3.0

Marb **+0.26**    REA **+0.09**    Bfat **+0.04**

## 34 BSF ACCENT F173 L4

1-B 99% # 3988734 Tat.: BSF8 F173

Birth: 3-9-18

Beckton Accent U777 C2  
**BECKTON ACCENT B653 C3**  
 Ref. A-4

Beckton Christy W779 C

Beckton Loki X833 H4  
**BSF NEBULANN 2012 L**  
 BSF Nebulann X393 N

Beckton Cody K1 P014  
 Beckton Susan R022 CQ  
 BKT Clifftop TP R288  
 Beckton Christy S151 NB  
 Beckton Loki CL S284  
 Beckton Vernice T447 HT  
 Beckton Nebula T269 E2  
 BSF Red G449

BWt 80  
 WR 99  
 YWt. 1149  
 YR 118  
 Feb.ADG 3.88  
 Feb.Scr. 37  
 Fr. 5.5

**DAM**

Age 6  
 Wt 1160  
 Prog.BW 76  
 WR 108  
 YR 110  
 Wean Pct. 46%  
 Cow Eff. 96

RAAA HerdBuilder index: **191** (Top 28% of RA breed)  
 RAAA GridMaster index: **52** (Top 5% of RA breed)

Calv.Ease	BW	WW	YW	Milk	HPG	Stay	Maint.En.
EPDs	14	-1.3	60	106	26	12	-3.0

Marb **+0.32**    REA **-0.13**    Bfat **+0.03**

★★★★★ for Low Maintenance, Marbling, Superior Cow, Calving Ease, Stayability.

★★★★★ for Low Maintenance, Growth, Marbling, Superior Cow, Calving Ease, Stayability.

## 32 BSF LIKABLE F197 W4

1-B 99% # 3988722 Tat.: BSF8 F197

Birth: 3-10-18

Beckton Likable U130 L2  
**BECKTON LIKABLE B509 J3**  
 Ref. L-3

Beckton Coca T363 JL

Beckton Warrior N645 T1  
**BSF JULIANNE U532 WR**  
 BSF Julianne R692 JL

Beckton Likable S633  
 Beckton Kit S478 LN  
 Beckton Julian G2 M345  
 Beckton Coca P435 CH  
 Beckton Warrior T1 H281  
 Beckton Rose H074 EP  
 Beckton Julian G1 J526  
 BSF Regus KA43 TZ

BWt 72  
 WR 106  
 YWt. 1075  
 YR 111  
 Feb.ADG 3.48  
 Feb.Scr. 38  
 Fr. 5.5

**DAM**

Age 10  
 Wt 1180  
 Prog.BW 65  
 WR 104  
 YR 104  
 Wean Pct. 48%  
 Cow Eff. 101

RAAA HerdBuilder index: **193** (Top 25% of RA breed)  
 RAAA GridMaster index: **50** (Top 19% of RA breed)

Calv.Ease	BW	WW	YW	Milk	HPG	Stay	Maint.En.
EPDs	14	-2.1	62	100	21	15	-6.0

Marb **+0.27**    REA **-0.07**    Bfat **+0.03**

★★★★★ for Low Maintenance, Growth, Marbling, Superior Cow, Calving Ease, Stayability.

## 35 BSF HUGHES F082 A3

1-B 99% # 3988822 Tat.: BSF8 F082

Birth: 2-25-18

Bieber H Hughes W109  
**BECKTON HUGHES D589 S2**  
 Ref. B-1

Beckton Sierra Z353 S

Beckton Accent B549 N3  
**BSF LAUREL D196 A**  
 BSF Laurel B696 A

Basin Hobo 0545  
 Basin Rose 06T0  
 Beckton Scamp X494 E3  
 Beckton Sierra X555 N  
 Beckton Accent W180 C2  
 Beckton Minerva Y654 N  
 Beckton Accent Y312 N3  
 BSF Laurel X098 W

BWt 77  
 WR 118  
 YWt. 1116  
 YR 119  
 Feb.ADG 3.37  
 Feb.Scr. 34  
 Fr. 6.0

**DAM**

Age 2  
 Wt 975  
 Prog.BW 77  
 WR 118  
 YR 119  
 Wean Pct. 56%  
 Cow Eff. 118

RAAA HerdBuilder index: **217** (Top 4% of RA breed)  
 RAAA GridMaster index: **53** (Top 2% of RA breed)

Calv.Ease	BW	WW	YW	Milk	HPG	Stay	Maint.En.
EPDs	14	-0.7	76	124	23	14	-5.0

Marb **+0.42**    REA **+0.11**    Bfat **+0.04**

★★★★★ for Low Maintenance, Growth, Marbling, Superior Cow, High Cow Efficiency, Calving Ease, Stayability.

## 33 BSF LIKABLE F317 C5

1-B 99% # 3988900 Tat.: BKB8 F317

Birth: 3-18-18

Beckton Likable X445 J3  
**BECKTON LIKABLE Z057 L4**  
 Ref. L-1

Beckton Minola X107 L

Beckton Clifftop W577 E3  
**BSF LANETTE Z660 C**  
 BSF Lanette W025 W

Beckton Likable U130 L2  
 Beckton Indigo U658 JL  
 Beckton Likable U120 L2  
 Beckton Minola U188 NB  
 BKT Clifftop TP R288  
 BKT Pine Marie R213 EP  
 Beckton Warrior T248 L5  
 BSF Lanette T717 JL

BWt 60  
 WR 103  
 YWt. 992  
 YR 102  
 Feb.ADG 2.42  
 Feb.Scr. 36  
 Fr. 5.5

**DAM**

Age 6  
 Wt 1000  
 Prog.BW 66  
 WR 102  
 YR 102  
 Wean Pct. 55%  
 Cow Eff. 116

RAAA HerdBuilder index: **218** (Top 4% of RA breed)  
 RAAA GridMaster index: **51** (Top 8% of RA breed)

Calv.Ease	BW	WW	YW	Milk	HPG	Stay	Maint.En.
EPDs	17	-5.2	46	83	26	15	-12.0

Marb **+0.46**    REA **-0.11**    Bfat **+0.03**

★★★★★ for Low Maintenance, Marbling, High Cow Efficiency, Calving Ease, Stayability.

## 36 BSF ACCENT F110 N5

1-B 99% # 3988792 Tat.: BSF8 F110

Birth: 3-2-18

Beckton Accent Y260 L3  
**BECKTON ACCENT D326 N4**  
 Ref. A-7

Beckton Lydia S069 NB

Beckton Nomad X290 N3  
**BSF NEBULANN Z158 N**  
 BSF Nebulann X483 J

Beckton Accent W180 C2  
 Beckton Lana W463 L  
 Beckton Nebula P P707  
 Beckton Lydia P583 WR  
 Beckton Nomad V 9871  
 Beckton Birdie S110 NB  
 Beckton Roman J S158  
 BSF Nebulann R163 NB

BWt 80  
 WR 104  
 YWt. 1060  
 YR 107  
 Feb.ADG 3.15  
 Feb.Scr. 35  
 Fr. 6.0

**DAM**

Age 6  
 Wt 1135  
 Prog.BW 63  
 WR 103  
 YR 103  
 Wean Pct. 52%  
 Cow Eff. 110

RAAA HerdBuilder index: **189** (Top 32% of RA breed)  
 RAAA GridMaster index: **50** (Top 22% of RA breed)

Calv.Ease	BW	WW	YW	Milk	HPG	Stay	Maint.En.
EPDs	15	-3.0	59	97	27	11	-4.0

Marb **+0.39**    REA **-0.11**    Bfat **+0.04**

★★★★★ for Low Maintenance, Growth, Marbling, Calving Ease, Stayability.



• Bulls •

**37** **BSF ACCENT F158 N4**   
 1-B 99% # 3988908 Tat.: BKB8 F158  
 Birth: 3-8-18  
 Beckton Accent U777 C2  
**BECKTON ACCENT D174 N3**  
 Ref. A-6 BKT Larkeisa S055 NB  
 Beckton Cody K1 P014  
 Beckton Susan R022 CQ  
 Beckton Nebula P P707  
 Beckton Larkeisa P688 CH  
 Beckton New Era Y194  
**BSF HELENA C408 N**  
 Beckton New Era A409 N2  
 BSF Helena Z869 S Beckton Eola W796 N  
 Beckton Scamp X458 H3  
 BSF Helena W042 W  
 BWT 81  
 WR 117  
 YWt. 1151  
 YR 121  
 Feb.ADG 3.65  
 Feb.Scr. 38  
 Fr. 5.5  
**DAM**  
 Age 3  
 Wt 1175  
 Prog.BW 81  
 WR 117  
 YR 121  
 Wean Pct. 49%  
 Cow Eff. 103  
 RAAA HerdBuilder index: **190** (Top 30% of RA breed)  
 RAAA GridMaster index: **50** (Top 26% of RA breed)  
 Calv.Ease BW WW YW Milk HPG Stay Maint.En.  
 EPDs **16 -2.7 60 98 26 13 16 -5.0**  
 Marb **+.37** REA **-.08** Bfat **+.04**

★★★★★ for Low Maintenance, Growth, Marbling, Superior Cow, Calving Ease, Stayability.

**39** **BSF ACCENT F164 C5**   
 1-B 99% # 3988742 Tat.: BSF8 F164  
 Birth: 3-8-18  
 Beckton Accent Y260 L3  
**BECKTON ACCENT D326 N4**  
 Ref. A-7 Beckton Lydia S069 NB  
 Beckton Accent W180 C2  
 Beckton Lana W463 L  
 Beckton Nebula P P707  
 Beckton Lydia P583 WR  
 Beckton Clifftop W692 E3  
 Beckton Lana W240 C  
**BSF CRUSITA B374 C**  
 Beckton Clifftop Y012 C4  
 BSF Crusita X071 L Beckton Likable U120 L2  
 BSF Crusita U036 NB  
 BWT 81  
 WR 102  
 YWt. 1101  
 YR 113  
 Feb.ADG 3.37  
 Feb.Scr. 37  
 Fr. 6.0  
**DAM**  
 Age 4  
 Wt 1105  
 Prog.BW 77  
 WR 103  
 YR 108  
 Wean Pct. 47%  
 Cow Eff. 100  
 RAAA HerdBuilder index: **213** (Top 6% of RA breed)  
 RAAA GridMaster index: **51** (Top 7% of RA breed)  
 Calv.Ease BW WW YW Milk HPG Stay Maint.En.  
 EPDs **14 -1.7 63 108 28 12 19 -6.0**  
 Marb **+.39** REA **-.10** Bfat **+.04**

★★★★★ for Low Maintenance, Growth, Marbling, Superior Cow, Calving Ease, Stayability.

**38** **BSF JULIAN F428 N7**   
 1-B 99% # 3988554 Tat.: BSF8 F428  
 Birth: 3-23-18  
 Beckton Julian X465 J5  
**BECKTON JULIAN D551 C6**  
 Ref. J-3 Beckton Tamara W550 A  
 Beckton Julian G5 S107  
 Beckton Suffeina P643 JL  
 Beckton Cody K1 P014  
 Beckton Tamara R175 CQ  
 Beckton New Era Y194  
**BSF EPIQUETTE D198 N**  
 Beckton New Era B265 J2  
 BSF Epiquette B344 E Beckton Minerva W901 J  
 Beckton Epic X330 L6  
 BSF Epiquette W644 N  
 BWT 66  
 WR 115  
 YWt. 1091  
 YR 108  
 Feb.ADG 3.20  
 Feb.Scr. 33  
 Fr. 5.5  
**DAM**  
 Age 2  
 Wt 815  
 Prog.BW 66  
 WR 116  
 YR 108  
 Wean Pct. 68%  
 Cow Eff. 142  
 RAAA HerdBuilder index: **194** (Top 24% of RA breed)  
 RAAA GridMaster index: **51** (Top 8% of RA breed)  
 Calv.Ease BW WW YW Milk HPG Stay Maint.En.  
 EPDs **15 -2.4 63 104 25 15 16 -6.0**  
 Marb **+.46** REA **-.21** Bfat **+.05**

★★★★★ for Low Maintenance, Growth, Marbling, Superior Cow, High Cow Efficiency, Calving Ease, Stayability.

**40** **BSF LIKABLE F180 E4**   
 1-B 99% # 3988916 Tat.: BKB8 F180  
 Birth: 3-9-18  
 Beckton Likable U130 L2  
**BECKTON LIKABLE D432 N3**  
 Ref. L-5 Beckton Firefly W013 N  
 Beckton Likable S633  
 Beckton Kit S478 LN  
 Beckton Nebula T054 H3  
 Beckton Firefly T003 JC  
 Beckton Epic Y484 N6  
**BSF BAYBERRY D406 E**  
 Beckton Epic B545 N7  
 BSF Bayberry B073 A Beckton Serena X338 N  
 Beckton Accent Z506 J3  
 BSF Bayberry Z735 L  
 BWT 75  
 WR 105  
 YWt. 1069  
 YR 114  
 Feb.ADG 3.20  
 Feb.Scr. 32  
 Fr. 5.5  
**DAM**  
 Age 2  
 Wt 855  
 Prog.BW 75  
 WR 105  
 YR 114  
 Wean Pct. 56%  
 Cow Eff. 118  
 RAAA HerdBuilder index: **215** (Top 5% of RA breed)  
 RAAA GridMaster index: **53** (Top 2% of RA breed)  
 Calv.Ease BW WW YW Milk HPG Stay Maint.En.  
 EPDs **14 -1.6 62 108 24 13 18 -6.0**  
 Marb **+.36** REA **+.17** Bfat **+.04**

★★★★★ for Low Maintenance, Growth, Marbling, Rib-eye area, Superior Cow, High Cow Efficiency, Calving Ease, Stayability.



Lot 36

**41** **BSF ACCENT F042 L5**   
 1-B 99% # 3988918 Tat.: BKB8 F042  
 Birth: 2-19-18  
 Beckton Accent Y260 L3  
**BECKTON ACCENT D326 N4**  
 Ref. A-7 Beckton Lydia S069 NB  
 Beckton Accent W180 C2  
 Beckton Lana W463 L  
 Beckton Nebula P P707  
 Beckton Lydia P583 WR  
 Beckton Loki CL S284  
**BSF JULIA D712 L**  
 Beckton Loki X833 H4  
 BSF Julia X752 L Beckton Vernice T447 HT  
 Beckton Laser N602  
 BSF Julia T175 JO  
 BWT 73  
 WR 114  
 YWt. 1025  
 YR 110  
 Feb.ADG 2.98  
 Feb.Scr. 34  
 Fr. 5.5  
**DAM**  
 Age 2  
 Wt 905  
 Prog.BW 73  
 WR 114  
 YR 110  
 Wean Pct. 58%  
 Cow Eff. 122  
 RAAA HerdBuilder index: **196** (Top 21% of RA breed)  
 RAAA GridMaster index: **50** (Top 22% of RA breed)  
 Calv.Ease BW WW YW Milk HPG Stay Maint.En.  
 EPDs **14 -2.3 61 100 27 10 18 -3.0**  
 Marb **+.37** REA **-.02** Bfat **+.03**

★★★★★ for Low Maintenance, Growth, Marbling, Superior Cow, High Cow Efficiency, Calving Ease, Stayability.

• Bulls •

**42 W CRA NEBULA F134** 

1-A 100% # 3970034 Tat.: WCRA8 FC13

Birth: 3-11-18

Beckton Nebula M045  
**BECKTON NEBULA P P707**  
 Ref. N-1 Beckton Lana M809 EP

Beckton Neptune R2 K065  
 Beckton Belga K285 JL  
 Beckton Epic K1 K863  
 Beckton Lana K253 DM  
 Beckton Warrior W534 N4  
 Beckton Susan W058 E  
 Beckton Lasso P741  
 Beckton Sierra P027 LN

BWt 76  
 WR 101  
 YWt. 1077  
 YR 107  
 Feb.ADG 3.43  
 Feb.Scr. 33  
 Fr. 6.0

Beckton Warrior Y108 E5  
**BECKTON SIERRA C254 W**  
 Beckton Sierra S065 LO

**DAM**  
 Age 3  
 Wt 1175  
 Prog.BW 76  
 WR 101  
 YR 107  
 Wean Pct. %  
 Cow Eff.

RAAA HerdBuilder index: **196** (Top 21% of RA breed)  
 RAAA GridMaster index: **49** (Top 38% of RA breed)  
 Calv.Ease BW WW YW Milk HPG Stay Maint.En.  
 EPDs **12 -3.5 58 102 25 11 19 -3.0**  
 Marb **+0.39** REA **-0.20** Bfat **+0.06**

**45 BECKTON ACCENT F411 N5** 

1-A 100% # 3988562 Tat.: BSF8 F411

Birth: 3-22-18

Beckton Accent Y260 L3  
**BECKTON ACCENT B150 N4**  
 Ref. A-2 BKT Larkeisa S055 NB

Beckton Accent W180 C2  
 Beckton Lana W463 L  
 Beckton Nebula P F707  
 Beckton Larkeisa P688 CH  
 Beckton Nebula U206 V3  
 Beckton Tamara U185 NB  
 Beckton Hasten U108 J3  
 Beckton Minola U630 NB

BWt 74  
 WR 107  
 YWt. 1019  
 YR 99  
 Feb.ADG 2.39  
 Feb.Scr. 36  
 Fr. 5.5

Beckton Nebula X096 N4  
**BECKTON MINOLA Z219 N**  
 Beckton Minola X015 H

**DAM**  
 Age 6  
 Wt 1115  
 Prog.BW 70  
 WR 105  
 YR 102  
 Wean Pct. 55%  
 Cow Eff. 115

RAAA HerdBuilder index: **201** (Top 15% of RA breed)  
 RAAA GridMaster index: **47** (Top 76% of RA breed)  
 Calv.Ease BW WW YW Milk HPG Stay Maint.En.  
 EPDs **14 -2.7 60 88 24 11 20 -3.0**  
 Marb **+0.42** REA **-0.28** Bfat **+0.05**

★★★★★ for Low Maintenance, Growth, Marbling, Calving Ease, Stayability.

★★★★★ for Low Maintenance, Marbling, Calving Ease, Stayability.

**43 BECKTON SCAMP F255 L5** 

1-A 100% # 3988676 Tat.: BSF8 F255

Birth: 3-15-18

Beckton Scamp X458 H3  
**BECKTON SCAMP B720 L4**  
 Ref. S-1 Beckton Larkaba Y448 L

Beckton Scamp T A825  
 BKT Pine Marie R401 HU  
 Beckton Likable U130 L2  
 Beckton Larkaba T655 NB  
 Beckton Lancer F442 T  
 Beckton Kit F468 JL  
 Beckton Nebula L P093  
 Beckton Tamara R200 HU

BWt 58  
 WR 107  
 YWt. 1051  
 YR 103  
 Feb.ADG 2.89  
 Feb.Scr. 37  
 Fr. 5.5

Beckton Legend S670  
**BECKTON TAMARA B547 L**  
 Beckton Tamara U244 NB

**DAM**  
 Age 4  
 Wt 1175  
 Prog.BW 70  
 WR 109  
 YR 103  
 Wean Pct. 50%  
 Cow Eff. 106

RAAA HerdBuilder index: **199** (Top 18% of RA breed)  
 RAAA GridMaster index: **51** (Top 11% of RA breed)  
 Calv.Ease BW WW YW Milk HPG Stay Maint.En.  
 EPDs **17 -3.8 60 97 24 14 16 -5.0**  
 Marb **+0.27** REA **+0.01** Bfat **+0.02**

★★★★★ for Low Maintenance, Marbling, Superior Cow, Calving Ease, Stayability.

**46 BECKTON EPIC F294 S7** 

1-A 100% # 3987756 Tat.: BKT8 F294

Birth: 3-17-18

Beckton Epic U749 D5  
**BECKTON EPIC Z674 E6**  
 Ref. E-2 Beckton Indigo U504 EP

Beckton Epic K4 N795  
 Beckton Denise R308 DM  
 Beckton Epic K6 S569  
 Beckton Indigo S016 NB  
 Beckton Scamp X494 E3  
 Beckton Serena R023 JC  
 Beckton Legend U331 E2  
 Beckton Larkaba W868 J

BWt 76  
 WR 122  
 YWt. 1103  
 YR 118  
 Feb.ADG 3.28  
 Feb.Scr. 31  
 Fr. 5.5

Beckton Scamp A627 J4  
**BECKTON LARKABA C279 S**  
 Beckton Larkaba A751 L

**DAM**  
 Age 3  
 Wt 1070  
 Prog.BW 66  
 WR 116  
 YR 112  
 Wean Pct. 51%  
 Cow Eff. 107

RAAA HerdBuilder index: **177** (Top 55% of RA breed)  
 RAAA GridMaster index: **51** (Top 10% of RA breed)  
 Calv.Ease BW WW YW Milk HPG Stay Maint.En.  
 EPDs **13 -1.1 66 111 26 13 15 -5.0**  
 Marb **+0.27** REA **-0.09** Bfat **+0.04**

★★★★★ for Low Maintenance, Growth, Marbling, Superior Cow, Calving Ease, Stayability.

**44 BECKTON SCAMP F632 J5** 

1-A 100% # 3988402 Tat.: BSF8 F632

Birth: 4-5-18

Beckton Scamp X458 H3  
**BECKTON SCAMP B720 L4**  
 Ref. S-1 Beckton Larkaba Y448 L

Beckton Scamp T A825  
 BKT Pine Marie R401 HU  
 Beckton Likable U130 L2  
 Beckton Larkaba T655 NB  
 Beckton Roman J S158  
 Beckton Sierra K557 LO  
 Beckton Ranger T603 H3  
 Beckton Lana S866 CH

BWt 68  
 WR 118  
 YWt. 1148  
 YR 116  
 Feb.ADG 3.72  
 Feb.Scr. 35  
 Fr. 6.0

Beckton Janus X799 L2  
**BECKTON LANA Z021 J**  
 Beckton Lana X410 R

**DAM**  
 Age 6  
 Wt 1210  
 Prog.BW 62  
 WR 111  
 YR 108  
 Wean Pct. 52%  
 Cow Eff. 110

RAAA HerdBuilder index: **174** (Top 60% of RA breed)  
 RAAA GridMaster index: **52** (Top 3% of RA breed)  
 Calv.Ease BW WW YW Milk HPG Stay Maint.En.  
 EPDs **17 -4.1 59 103 25 13 13 -3.0**  
 Marb **+0.21** REA **-0.02** Bfat **+0.02**

★★★★★ for Low Maintenance, Growth, Marbling, Superior Cow, Calving Ease, Stayability.



Lot 44

• Bulls •

## 47 BECKTON CARDINAL F012 L3

1-A 100% # 3988884 Tat.: BSF8 F012

Birth: 2-13-18

Beckton Cardinal B074 N  
**BECKTON CARDINAL D010 W2**  
 Ref. C-2  
 Beckton Firefly B052 W

Beckton Likable B509 J3  
**BECKTON ANGEL D066 L**  
 Beckton Angel B140 W

TR Double Eagle ZT220  
 BKT Pine Marie Z250 N  
 Beckton Warrior Z936 N6  
 Beckton Firefly Z663 N  
 Beckton Likable U130 L2  
 Beckton Coca T363 JL  
 Beckton Warrior Z936 N6  
 Beckton Angel Z927 W

BWt	61
WR	108
YWt.	1002
YR	99
Feb.ADG	2.50
Feb.Scr.	34
Fr.	5.5

Age	2
Wt	800
Prog.BW	61
WR	108
YR	99
Wean Pct.	62%
Cow Eff.	130

RAAA HerdBuilder index:	196	(Top 21% of RA breed)						
RAAA GridMaster index:	51	(Top 13% of RA breed)						
Calv.Ease	BW	WW	YW	Milk	HPG	Stay	Maint.En.	
EPDs	16	-4.5	53	89	25	14	16	-7.0
Marb	+0.41	REA	+0.03	Bfat	+0.03			



## 50 BECKTON EPIC F151 L8

1-A 100% # 3988756 Tat.: BSF8 F151

Birth: 3-7-18

Beckton Epic Z674 E6  
**BECKTON EPIC D344 N7**  
 Ref. E  
 Beckton Larkaba Y083 N

Beckton Likable Y124 L3  
**BECKTON MARTA C609 L**  
 Beckton Marta X293 H

Beckton Epic U749 D5  
 Beckton Indigo U504 EP  
 Beckton Nebula W130 D3  
 Beckton Larkaba W264 W  
 Beckton Likable U130 L2  
 BKT Pine Marie S802 LO  
 Beckton Hasten H S462  
 Beckton Marta G675 LN

BWt	75
WR	111
YWt.	1054
YR	107
Feb.ADG	3.11
Feb.Scr.	32
Fr.	5.5

Age	3
Wt	1155
Prog.BW	75
WR	111
YR	107
Wean Pct.	47%
Cow Eff.	99

RAAA HerdBuilder index:	193	(Top 25% of RA breed)						
RAAA GridMaster index:	50	(Top 20% of RA breed)						
Calv.Ease	BW	WW	YW	Milk	HPG	Stay	Maint.En.	
EPDs	12	-0.7	65	103	21	13	18	-3.5
Marb	+0.30	REA	-0.06	Bfat	+0.03			



★★★★★ for Low Maintenance, Marbling, High Cow Efficiency, Calving Ease, Stayability.

★★★★★ for Low Maintenance, Growth, Marbling, Superior Cow, Calving Ease, Stayability.

## 48 BECKTON EPIC F460 J8

1-A 100% # 3988530 Tat.: BSF8 F460

Birth: 3-24-18

Beckton Epic Y484 N6  
**BECKTON EPIC B545 N7**  
 Ref. E-6  
 Beckton Serena X338 N

Beckton Julian W841 J5  
**BECKTON TARA Y111 J**  
 Beckton Tara W482 L

Beckton Epic U749 D5  
 Beckton Lydia S069 NB  
 Beckton Nebula T398 V3  
 Beckton Serena S649 LO  
 Beckton Julian G5 S107  
 Beckton Christy J743 JL  
 Beckton Loki CL S284  
 Beckton Tara R609 JC

BWt	69
WR	101
YWt.	1071
YR	104
Feb.ADG	3.39
Feb.Scr.	36
Fr.	5.0

Age	7
Wt	1165
Prog.BW	69
WR	104
YR	102
Wean Pct.	49%
Cow Eff.	104

RAAA HerdBuilder index:	196	(Top 21% of RA breed)						
RAAA GridMaster index:	50	(Top 24% of RA breed)						
Calv.Ease	BW	WW	YW	Milk	HPG	Stay	Maint.En.	
EPDs	13	-2.2	59	102	25	16	18	-2.0
Marb	+0.25	REA	+0.01	Bfat	+0.05			



★★★★★ for Low Maintenance, Marbling, Calving Ease, Stayability.

## 51 BECKTON ACCENT F136 A4

1-A 100% # 3987940 Tat.: BKT8 F136

Birth: 3-6-18

Beckton Accent U777 C2  
**BECKTON ACCENT B653 C3**  
 Ref. A-4  
 Beckton Christy W779 C

Beckton Accent W180 C2  
**BECKTON COCA Z529 A**  
 Beckton Coca T168 NB

Beckton Cody K1 P014  
 Beckton Susan R022 CQ  
 BKT Clifftop TP R288  
 Beckton Christy S151 NB  
 Beckton Cody K1 P014  
 Beckton Christy R046 CQ  
 Beckton Nebula M045  
 Beckton Coca H256 JL

BWt	66
WR	96
YWt.	986
YR	96
Feb.ADG	2.94
Feb.Scr.	36
Fr.	5.0

Age	6
Wt	1145
Prog.BW	68
WR	102
YR	101
Wean Pct.	48%
Cow Eff.	100

RAAA HerdBuilder index:	224	(Top 2% of RA breed)						
RAAA GridMaster index:	48	(Top 51% of RA breed)						
Calv.Ease	BW	WW	YW	Milk	HPG	Stay	Maint.En.	
EPDs	18	-4.5	51	84	25	12	20	-6.0
Marb	+0.38	REA	-0.17	Bfat	+0.04			



★★★★★ for Low Maintenance, Marbling, Calving Ease, Stayability.

## 49 BECKTON ACCENT F140 N5

1-A 100% # 3987936 Tat.: BKT8 F140

Birth: 3-6-18

Beckton Accent Y260 L3  
**BECKTON ACCENT B150 N4**  
 Ref. A-2  
 BKT Larkeisa S055 NB

Beckton Nebula T398 V3  
**BECKTON INDIGO W772 N**  
 Beckton Indigo T613 JT

Beckton Accent W180 C2  
 Beckton Lana W463 L  
 Beckton Nebula P P707  
 Beckton Larkeisa P688 CH  
 Beckton Nebula L P093  
 Beckton Minerva J615 VG  
 TR Julian LT151  
 Beckton Indigo N467 LO

BWt	74
WR	110
YWt.	949
YR	96
Feb.ADG	2.33
Feb.Scr.	33
Fr.	5.0

Age	9
Wt	1150
Prog.BW	68
WR	107
YR	103
Wean Pct.	51%
Cow Eff.	108

RAAA HerdBuilder index:	222	(Top 2% of RA breed)						
RAAA GridMaster index:	48	(Top 65% of RA breed)						
Calv.Ease	BW	WW	YW	Milk	HPG	Stay	Maint.En.	
EPDs	15	-2.8	55	82	27	12	22	-3.0
Marb	+0.45	REA	-0.27	Bfat	+0.06			



★★★★★ for Low Maintenance, Marbling, Calving Ease, Stayability.



Lot 49



• Bulls •

**52 BECKTON EPIC F162 J7** 1-A 100% # 3987912 Tat.: BKT8 F162 

Birth: 3-8-18

Beckton Epic X464 L5  
**BECKTON EPIC B310 J6** Ref. E-4  
 Beckton Minerva Y116 J

Beckton Epic K6 S569  
 Beckton Lana M393 LN  
 Beckton Julian W743 H5  
 Beckton Minerva W081 N  
 Beckton Roman J S158  
 Beckton Sierra K557 LO  
 Beckton Nebula T054 H3  
 Beckton Rose T142 HI

BWt 85  
 WR 114  
 YWt. 1034  
 YR 101  
 Feb.ADG 2.33  
 Feb.Scr. 33  
 Fr. 5.5

Beckton Janus X799 L2  
**BECKTON ROSE Z078 J**  
 Beckton Rose X573 N

**DAM**  
 Age 6  
 Wt 1180  
 Prog.BW 80  
 WR 109  
 YR 101  
 Wean Pct. 55%  
 Cow Eff. 116

RAAA HerdBuilder index: 181 (Top 47% of RA breed)  
 RAAA GridMaster index: 48 (Top 56% of RA breed)  
 Calv.Ease BW WW YW Milk HPG Stay Maint.En.  
 EPDs 13 -0.6 63 96 25 13 17 -3.0  
 Marb +.24 REA -.14 Bfat +.03

**55 BECKTON HERITAGE F196 A5** 1-A 100% # 3987868 Tat.: BKT8 F196 

Birth: 3-10-18

Beckton Heritage A767 C3  
**BECKTON HERITAGE D195 L4** Ref. H-2  
 Beckton Susan W846 L

Beckton Heritage X356 E2  
 Beckton Rose W816 C  
 Beckton Loki CL S284  
 Beckton Susan S684 JJ  
 Beckton Cody K1 P014  
 Beckton Susan R022 CQ  
 Beckton Heritage T270 J2  
 Beckton Firefly T028 JR

BWt 78  
 WR 108  
 YWt. 1135  
 YR 112  
 Feb.ADG 3.54  
 Feb.Scr. 33  
 Fr. 5.5

Beckton Accent U777 C2  
**BECKTON FIREFLY D489 A**  
 Beckton Firefly W021 H

**DAM**  
 Age 2  
 Wt 900  
 Prog.BW 78  
 WR 108  
 YR 112  
 Wean Pct. 55%  
 Cow Eff. 116

RAAA HerdBuilder index: 185 (Top 39% of RA breed)  
 RAAA GridMaster index: 51 (Top 9% of RA breed)  
 Calv.Ease BW WW YW Milk HPG Stay Maint.En.  
 EPDs 14 -0.9 69 114 24 11 16 -2.0  
 Marb +.29 REA -.06 Bfat +.04

★★★★★ for Low Maintenance, Marbling, High Cow Efficiency, Calving Ease, Stayability.

★★★★★ for Low Maintenance, Growth, Marbling, Superior Cow, Calving Ease, Stayability.

**53 BECKTON LIKABLE F641 C6** 1-A 100% # 3987336 Tat.: BKT8 F641 

Birth: 4-6-18

Beckton Likable Z057 L4  
**BECKTON LIKABLE B032 C5** Ref. L-2  
 Beckton Mona Z270 C

Beckton Likable X445 J3  
 Beckton Minola X107 L  
 Beckton Clifftop W577 E3  
 Beckton Mona U584 CD  
 Beckton Clifftop W577 E3  
 Beckton Tamara R175 CQ  
 Beckton Heritage X356 E2  
 Beckton Coca Y649 N

BWt 72  
 WR 103  
 YWt. 1121  
 YR 109  
 Feb.ADG 3.48  
 Feb.Scr. 36  
 Fr. 5.5

Beckton Clifftop Z824 C4  
**BECKTON COCA B118 C**  
 Beckton Coca Z545 H

**DAM**  
 Age 4  
 Wt 865  
 Prog.BW 61  
 WR 101  
 YR 100  
 Wean Pct. 65%  
 Cow Eff. 138

RAAA HerdBuilder index: 224 (Top 2% of RA breed)  
 RAAA GridMaster index: 53 (Top 2% of RA breed)  
 Calv.Ease BW WW YW Milk HPG Stay Maint.En.  
 EPDs 16 -4.1 54 101 25 15.5 19 -7.0  
 Marb +.46 REA -.13 Bfat +.04

★★★★★ for Low Maintenance, Growth, Marbling, High Cow Efficiency, Calving Ease, Stayability.

**56 BECKTON ACCENT F216 C4** 1-A 100% # 3987848 Tat.: BKT8 F216 

Birth: 3-12-18

Beckton Accent W180 C2  
**BECKTON ACCENT B549 N3** Ref. A-3  
 Beckton Minerva Y654 N

Beckton Cody K1 P014  
 Beckton Christy R046 CQ  
 Beckton Nebula T398 V3  
 Beckton Minerva M369 LO  
 Bkt Clifftop TV G672  
 Beckton Lana J384 CD  
 Beckton Dominor ZC M919  
 Beckton Rose G688 CD

BWt 60  
 WR 88  
 YWt. 1026  
 YR 100  
 Feb.ADG 3.71  
 Feb.Scr. 37  
 Fr. 5.5

Beckton Clifftop T3 N800  
**BECKTON ROSE U726 CT**  
 Beckton Rose R545 DM

**DAM**  
 Age 10  
 Wt 1030  
 Prog.BW 59  
 WR 93  
 YR 97  
 Wean Pct. 49%  
 Cow Eff. 103

RAAA HerdBuilder index: 240 (Top 1% of RA breed)  
 RAAA GridMaster index: 51 (Top 8% of RA breed)  
 Calv.Ease BW WW YW Milk HPG Stay Maint.En.  
 EPDs 19 -4.6 51 92 27 11 21 -7.0  
 Marb +.37 REA +.04 Bfat +.04

★★★★★ for Low Maintenance, Marbling, Calving Ease, Stayability.

**54 BECKTON SCAMP F003 H6** 1-A 100% # 3988074 Tat.: BKT8 F003 

Birth: 2-8-18

Beckton Scamp A627 J4  
**BECKTON SCAMP D325 N5** Ref. S-3  
 Beckton Tamara Y039 N

Beckton Scamp X494 E3  
 Beckton Serena R023 JC  
 Beckton Nebula W065 C3  
 Beckton Tamara W232 J  
 Beckton Heritage X403 L3  
 Beckton Lana N291 JC  
 Beckton Likable U130 L2  
 Beckton Lana Y193 N

BWt 57  
 WR 105  
 YWt. 1057  
 YR 109  
 Feb.ADG 3.48  
 Feb.Scr. 33  
 Fr. 5.5

Beckton Heritage B612 J4  
**BECKTON LANA D088 H**  
 Beckton Lana B526 L

**DAM**  
 Age 2  
 Wt 845  
 Prog.BW 57  
 WR 106  
 YR 109  
 Wean Pct. 53%  
 Cow Eff. 113

RAAA HerdBuilder index: 197 (Top 20% of RA breed)  
 RAAA GridMaster index: 51 (Top 11% of RA breed)  
 Calv.Ease BW WW YW Milk HPG Stay Maint.En.  
 EPDs 17 -4.5 64 106 24 14 16 -5.0  
 Marb +.28 REA -.06 Bfat +.03

★★★★★ for Low Maintenance, Growth, Marbling, Superior Cow, Calving Ease, Stayability.

**57 BECKTON EPIC F430 N7** 1-A 100% # 3987586 Tat.: BKT8 F430 

Birth: 3-23-18

Beckton Epic U749 D5  
**BECKTON EPIC Z674 E6** Ref. E-2  
 Beckton Indigo U504 EP

Beckton Epic K4 N795  
 Beckton Denise R308 DM  
 Beckton Epic K6 S569  
 Beckton Indigo S016 NB  
 Beckton New Era Y194  
 Beckton Minerva X612 L  
 Beckton Nebula T269 E2  
 Beckton Larkaba W693 N

BWt 52  
 WR 102  
 YWt. 1121  
 YR 114  
 Feb.ADG 3.65  
 Feb.Scr. 34  
 Fr. 5.5

Beckton New Era A395 L2  
**BECKTON LARKABA C061 N**  
 Beckton Larkaba A804 N

**DAM**  
 Age 3  
 Wt 870  
 Prog.BW 51  
 WR 101  
 YR 106  
 Wean Pct. 57%  
 Cow Eff. 121

RAAA HerdBuilder index: 194 (Top 24% of RA breed)  
 RAAA GridMaster index: 51 (Top 12% of RA breed)  
 Calv.Ease BW WW YW Milk HPG Stay Maint.En.  
 EPDs 16 -4.0 59 104 27 11 17 -3.0  
 Marb +.37 REA -.15 Bfat +.05

★★★★★ for Low Maintenance, Growth, Marbling, High Cow Efficiency, Calving Ease, Stayability.

• Bulls •

**58** **BECKTON EPIC F733 E7** 

1-A 100% # 3987238 Tat.: BKT8 F733

Birth: 4-17-18

Beckton Epic U749 D5  
**BECKTON EPIC Z674 E6**  
 Ref. E-2  
 Beckton Indigo U504 EP

Beckton Epic K4 N795  
 Beckton Denise R308 DM  
 Beckton Epic K6 S569  
 Beckton Indigo S016 NB  
 Beckton Epic Y484 N6  
 Beckton Larkaba Y648 E  
 Beckton Clifftop W692 E3  
 Beckton Rose W063 H

BWt 80  
 WR 122  
 YWt. 1149  
 YR 117  
 Feb.ADG 3.26  
 Feb.Scr. 36  
 Fr. 6.0

Beckton Epic A286 E7  
**BECKTON ROSE C034 E**  
 Beckton Rose A417 C

**DAM**  
 Age 3  
 Wt 1005  
 Prog.BW 74  
 WR 122  
 YR 117  
 Wean Pct. 60%  
 Cow Eff. 126

RAAA HerdBuilder index: **182** (Top 44% of RA breed)  
 RAAA GridMaster index: **51** (Top 8% of RA breed)  
 Calv.Ease BW WW YW Milk HPG Stay Maint.En.  
 EPDs **12 -0.8 66 110 24 11 16 -4.0**  
 Marb **+0.38** REA **-0.16** Bfat **+0.05**

★★★★★ for Low Maintenance, Growth, Marbling, Superior Cow, High Cow Efficiency, Calving Ease, Stayability.

**61** **BSF SCAMP F607 J5** 

1-B 99% # 3988424 Tat.: BSF8 F607

Birth: 4-2-18

Beckton Scamp X458 H3  
**BECKTON SCAMP B720 L4**  
 Ref. S-1  
 Beckton Larkaba Y448 L

Beckton Scamp T A825  
 BKT Pine Marie R401 HU  
 Beckton Likable U130 L2  
 Beckton Larkaba T655 NB  
 Beckton Julian G5 S107  
 Beckton Suffeina P643 JL  
 Beckton Justice CH M056  
 BSF Regus L414 EP

BWt 55  
 WR 103  
 YWt. 1072  
 YR 109  
 Feb.ADG 3.44  
 Feb.Scr. 35  
 Fr. 5.5

Beckton Julian X465 J5  
**BSF JUSTICIA B286**  
 BSF Justicia S777 JC

**DAM**  
 Age 4  
 Wt 1140  
 Prog.BW 73  
 WR 110  
 YR 106  
 Wean Pct. 50%  
 Cow Eff. 105

RAAA HerdBuilder index: **183** (Top 43% of RA breed)  
 RAAA GridMaster index: **52** (Top 4% of RA breed)  
 Calv.Ease BW WW YW Milk HPG Stay Maint.En.  
 EPDs **18 -5.4 52 93 25 16 13 -7.0**  
 Marb **+0.36** REA **-0.04** Bfat **+0.02**

★★★★★ for Low Maintenance, Growth, Marbling, Superior Cow, Calving Ease, Stayability.

**59** **BSF ACCENT F642 J3** 

1-B 99% # 3988394 Tat.: BSF8 F642

Birth: 4-6-18

Beckton Cody K1 P014  
**BECKTON ACCENT W180 C2**  
 Ref. A-1  
 Beckton Christy R046 CQ

Beckton Cody KH M390  
 Beckton Rose M126 WR  
 Beckton Cherokee N N479  
 Beckton Christy N740 HR  
 Beckton Julian GG B571  
 Bkt Vernice 9733 PC  
 Beckton Copper JT G095  
 BSF Regus F207

BWt 88  
 WR 114  
 YWt. 1124  
 YR 117  
 Feb.ADG 3.67  
 Feb.Scr. 37  
 Fr. 6.0

Beckton Justice G302  
**BSF BUFFIE S394 JC**  
 BSF Buffie N856 CO

**DAM**  
 Age 12  
 Wt 1270  
 Prog.BW 82  
 WR 105  
 YR 109  
 Wean Pct. 46%  
 Cow Eff. 98

RAAA HerdBuilder index: **203** (Top 13% of RA breed)  
 RAAA GridMaster index: **53** (Top 2% of RA breed)  
 Calv.Ease BW WW YW Milk HPG Stay Maint.En.  
 EPDs **12 0.2 72 118 21 10 18 -2.0**  
 Marb **+0.32** REA **+0.07** Bfat **+0.04**

★★★★★ for Low Maintenance, Growth, Marbling, Superior Cow, Calving Ease, Stayability.

**62** **BSF DOMINOR F692 R7** 

1-B 99% # 3988346 Tat.: BSF8 F692

Birth: 4-11-18

Beckton Dominor W640 C5  
**BECKTON DOMINOR Y052 N6**  
 Ref. D  
 Beckton Indigo W772 N

Beckton Dominor Z1 R610  
 Beckton Mona R166 CQ  
 Beckton Nebula T398 V3  
 Beckton Indigo T613 JT  
 Beckton Ranger 9479R  
 Beckton Rose N044 HU  
 Beckton Epic KM M115  
 BSF Red G329

BWt 54  
 WR 108  
 YWt. 1148  
 YR 117  
 Feb.ADG 3.44  
 Feb.Scr. 34  
 Fr. 5.5

Beckton Ranger T603 H3  
**BSF ERICA W053 R**  
 BSF Erica T609 EP

**DAM**  
 Age 9  
 Wt 1185  
 Prog.BW 66  
 WR 106  
 YR 109  
 Wean Pct. 52%  
 Cow Eff. 110

RAAA HerdBuilder index: **190** (Top 30% of RA breed)  
 RAAA GridMaster index: **50** (Top 15% of RA breed)  
 Calv.Ease BW WW YW Milk HPG Stay Maint.En.  
 EPDs **18 -5.2 53 96 29 13 15 -3.0**  
 Marb **+0.31** REA **-0.24** Bfat **+0.05**

★★★★★ for Low Maintenance, Growth, Marbling, Superior Cow, Calving Ease, Stayability.

**60** **BSF EPIC F635 J8** 

1-B 99% # 3988398 Tat.: BSF8 F635

Birth: 4-6-18

Beckton Epic Y484 N6  
**BECKTON EPIC B545 N7**  
 Ref. E-6  
 Beckton Serena X338 N

Beckton Epic U749 D5  
 Beckton Lydia S069 NB  
 Beckton Nebula T398 V3  
 Beckton Serena S649 LO  
 Beckton Julian GG B571  
 Beckton Belga X379 L  
 Beckton Epic X330 L6  
 BSF Hustelle X278 L

BWt 62  
 WR 105  
 YWt. 1054  
 YR 112  
 Feb.ADG 3.28  
 Feb.Scr. 36  
 Fr. 5.5

Beckton Julian A565 J4  
**BSF HUSTELLE C233 J**  
 BSF Hustelle A756 E

**DAM**  
 Age 3  
 Wt 725  
 Prog.BW 57  
 WR 108  
 YR 113  
 Wean Pct. 71%  
 Cow Eff. 149

RAAA HerdBuilder index: **201** (Top 15% of RA breed)  
 RAAA GridMaster index: **52** (Top 6% of RA breed)  
 Calv.Ease BW WW YW Milk HPG Stay Maint.En.  
 EPDs **13 -2.1 64 108 23 12 18 -4.0**  
 Marb **+0.33** REA **+0.03** Bfat **+0.04**

★★★★★ for Low Maintenance, Growth, Marbling, Superior Cow, High Cow Efficiency, Calving Ease, Stayability.

**63** **BECKTON SCAMP F702 N5** 

1-A 100% # 3987270 Tat.: BKT8 F702

Birth: 4-13-18

Beckton Scamp X458 H3  
**BECKTON SCAMP B720 L4**  
 Ref. S-1  
 Beckton Larkaba Y448 L

Beckton Scamp T A825  
 BKT Pine Marie R401 HU  
 Beckton Likable U130 L2  
 Beckton Larkaba T655 NB  
 Beckton Nebula T398 V3  
 Beckton Mona X022 L  
 Beckton Julian W743 H5  
 Beckton Larkaba U498 EP

BWt 78  
 WR 104  
 YWt. 1068  
 YR 114  
 Feb.ADG 3.33  
 Feb.Scr. 36  
 Fr. 5.5

Beckton Nebula A773 L4  
**BECKTON LARKABA C094 N**  
 Beckton Larkaba A712 J

**DAM**  
 Age 3  
 Wt 865  
 Prog.BW 72  
 WR 103  
 YR 110  
 Wean Pct. 59%  
 Cow Eff. 124

RAAA HerdBuilder index: **192** (Top 28% of RA breed)  
 RAAA GridMaster index: **53** (Top 2% of RA breed)  
 Calv.Ease BW WW YW Milk HPG Stay Maint.En.  
 EPDs **13 -0.8 61 108 22 16 16 -4.0**  
 Marb **+0.27** REA **+0.00** Bfat **+0.03**

★★★★★ for Low Maintenance, Growth, Marbling, High Cow Efficiency, Calving Ease, Stayability.

• Bulls •

**64** **BSF EPIC F796 H7** 

1-B 99% # 3988252 Tat.: BSF8 F796

Birth: 4-25-18

Beckton Epic U749 D5  
**BECKTON EPIC Z674 E6**  
 Ref. E-2  
 Beckton Indigo U504 EP

Beckton Epic K4 N795  
 Beckton Denise R308 DM  
 Beckton Epic K6 S569  
 Beckton Indigo S016 NB  
 Beckton Hustler CN J102  
 Beckton Vernice F513 CL  
 Beckton Caesar M D023  
 BSF Regus Z112

BWt 60  
 WR 104  
 YWt. 1062  
 YR 111  
 Feb.ADG 2.94  
 Feb.Scr. 36  
 Fr. 5.5

BSF HUSTELLE U447 HH  
 BSF Regus G191

**DAM**  
 Age 10  
 Wt 1230  
 Prog.BW 69  
 WR 105  
 YR 103  
 Wean Pct. 45%  
 Cow Eff. 95

RAAA HerdBuilder index: 199 (Top 17% of RA breed)  
 RAAA GridMaster index: 51 (Top 13% of RA breed)  
 Calv.Ease BW WW YW Milk HPG Stay Maint.En.  
 EPDs 15 -3.4 61 104 25 12 17 -5.0  
 Marb +.41 REA -.18 Bfat +.04

**67** **WCRA JULIAN F135** 

1-A 100% # 3970024 Tat.: WCRA8 FC13

Birth: 4-6-18

Beckton Julian X465 J5  
**BECKTON JULIAN A434 N6**  
 Ref. J  
 Beckton Lakme T689 NX

Beckton Julian G5 S107  
 Beckton Suffeina P643 JL  
 Beckton Nexus L016  
 Beckton Lakme M669 EP  
 Beckton Emcee S466  
 Beckton Larkaba P645 JL  
 Beckton Epic KM M115  
 Beckton Rose N375 LN

BWt 66  
 WR 108  
 YWt. 1062  
 YR 105  
 Feb.ADG 2.92  
 Feb.Scr. 38  
 Fr. 5.5

BECKTON ROSE Z266 E  
 Beckton Rose T406 EP

**DAM**  
 Age 6  
 Wt  
 Prog.BW 66  
 WR 111  
 YR 105  
 Wean Pct. %  
 Cow Eff.

RAAA HerdBuilder index: 165 (Top 74% of RA breed)  
 RAAA GridMaster index: 49 (Top 41% of RA breed)  
 Calv.Ease BW WW YW Milk HPG Stay Maint.En.  
 EPDs 14 -3.6 57 95 26 15 14 -2.0  
 Marb +.22 REA -.06 Bfat +.03

★★★★★ for Low Maintenance, Growth, Marbling, Calving Ease, Stayability.

★★★★★ for Low Maintenance, Growth, Marbling, Superior Cow, Calving Ease, Stayability.

**65** **BSF EPIC F376 N8** 

1-B 99% # 3988590 Tat.: BSF8 F376

Birth: 3-20-18

Beckton Epic Y484 N6  
**BECKTON EPIC B545 N7**  
 Ref. E-6  
 Beckton Serena X338 N

Beckton Epic U749 D5  
 Beckton Lydia S069 NB  
 Beckton Nebula T398 V3  
 Beckton Serena S649 LO  
 Beckton New Era Y194  
 Beckton Eola W796 N  
 Beckton Accent U777 C2  
 BSF Epiquette U279 CT

BWt 71  
 WR 139  
 YWt. 1031  
 YR 113  
 Feb.ADG 2.30  
 Feb.Scr. 31  
 Fr. 5.5

BSF EPIQUETTE C255 N  
 BSF Epiquette Z961 A

**DAM**  
 Age 3  
 Wt 1000  
 Prog.BW 70  
 WR 122  
 YR 113  
 Wean Pct. 63%  
 Cow Eff. 132

RAAA HerdBuilder index: 198 (Top 18% of RA breed)  
 RAAA GridMaster index: 51 (Top 8% of RA breed)  
 Calv.Ease BW WW YW Milk HPG Stay Maint.En.  
 EPDs 11 0.1 74 122 25 12 18 -3.0  
 Marb +.26 REA +.08 Bfat +.04



Lot 67

★★★★★ for Low Maintenance, Growth, Marbling, Superior Cow, High Cow Efficiency, Calving Ease, Stayability.

**66** **BSF EPIC F008 L8** 

1-B 99% # 3988890 Tat.: BSF8 F008

Birth: 2-11-18

Beckton Epic B483 N6  
**BECKTON EPIC D001 L7**  
 Ref. E-7  
 Beckton Mona B713 L

Beckton Epic U749 D5  
 BKT Pine Marie X339 N  
 Beckton Legend U331 E2  
 Beckton Mona U564 JT  
 Beckton Lancer F442 T  
 Beckton Kit F468 JL  
 Beckton Nebula U031 D3  
 BSF Wendie U152 CT

BWt 58  
 WR 96  
 YWt. 950  
 YR 106  
 Feb.ADG 2.70  
 Feb.Scr. 31  
 Fr. 5.5

BSF WENDIE D191 L  
 BSF Wendie X068 N

**DAM**  
 Age 2  
 Wt 875  
 Prog.BW 58  
 WR 97  
 YR 106  
 Wean Pct. 47%  
 Cow Eff. 98

RAAA HerdBuilder index: 217 (Top 4% of RA breed)  
 RAAA GridMaster index: 52 (Top 4% of RA breed)  
 Calv.Ease BW WW YW Milk HPG Stay Maint.En.  
 EPDs 17 -4.8 53 95 24 12 18 -8.0  
 Marb +.43 REA -.09 Bfat +.04

**68** **BECKTON LIKABLE F541 N5** 

1-A 100% # 3988468 Tat.: BSF8 F541

Birth: 3-28-18

Beckton Likable X445 J3  
**BECKTON LIKABLE Z057 L4**  
 Ref. L-1  
 Beckton Minola X107 L

Beckton Likable U130 L2  
 Beckton Indigo U658 JL  
 Beckton Likable U120 L2  
 Beckton Minola U188 NB  
 Beckton Nebula M045  
 Beckton Lana M809 EP  
 Beckton Julian G5 S107  
 Beckton Marta S441 RN

BWt 60  
 WR 83  
 YWt. 970  
 YR 100  
 Feb.ADG 3.09  
 Feb.Scr. 35  
 Fr. 5.0

BECKTON MARTA A319 N  
 Beckton Marta X405 J

**DAM**  
 Age 5  
 Wt 985  
 Prog.BW 63  
 WR 101  
 YR 106  
 Wean Pct. 45%  
 Cow Eff. 94

RAAA HerdBuilder index: 206 (Top 11% of RA breed)  
 RAAA GridMaster index: 51 (Top 9% of RA breed)  
 Calv.Ease BW WW YW Milk HPG Stay Maint.En.  
 EPDs 17 -6.0 48 90 27 15 17 -10.0  
 Marb +.50 REA -.17 Bfat +.04

★★★★★ for Low Maintenance, Growth, Marbling, Calving Ease, Stayability.

★★★★★ for Low Maintenance, Marbling, Calving Ease, Stayability.



• Bulls •

**69** **BSF NEBULA F571 E4** 

1-B 99% # 3988450 Tat.: BSF8 F571

Birth: 3-31-18

Beckton Nebula P P707  
 Beckton Nebula M045  
 Beckton Lana M809 EP  
 Beckton Justice CH M056  
 Beckton Larkaba T813 JC  
 Beckton Larkaba P645 JL  
 Beckton Epic U749 D5  
 Beckton Lydia S069 NB  
 Beckton Nebula J R475  
 BSF Clifftana U655 CT

**BECKTON NEBULA B557 J3**  
 Ref. N-3

**BSF CLIFFTANA A320 E**  
 Beckton Epic Y484 N6  
 BSF Clifftana Y297 N

DAM	
Age	5
Wt	950
Prog.BW	67
WR	95
YR	99
Wean Pct.	56%
Cow Eff.	118

BWt	74
WR	93
YWt.	1035
YR	104
Feb.ADG	3.09
Feb.Scr.	35
Fr.	5.0

RAAA HerdBuilder index:	204	(Top 12% of RA breed)						
RAAA GridMaster index:	52	(Top 4% of RA breed)						
Calv.Ease	BW	WW	YW	Milk	HPG	Stay	Maint.En.	
EPDs	13	-2.4	57	102	23	11	18	-5.0
Marb	+0.41		REA	-0.06		Bfat	+0.04	

★★★★★ for Low Maintenance, Marbling, High Cow Efficiency, Calving Ease, Stayability.

**71** **BSF ACCENT F347 E4** 

1-B 99% # 3988608 Tat.: BSF8 F347

Birth: 3-19-18

Beckton Accent W180 C2  
 Beckton Cody K1 P014  
 Beckton Christy R046 CQ  
 Beckton Nebula T398 V3  
 Beckton Minerva Y654 N  
 Beckton Minerva M369 LO  
 Beckton Epic U749 D5  
 Beckton Indigo U504 EP  
 Beckton Nebula W040 E4  
 BSF Epiquette W654 E

**BECKTON ACCENT B549 N3**  
 Ref. A-3

**BSF EPIQUETTE B051 E**  
 Beckton Epic Z674 E6  
 BSF Epiquette Z187 N

DAM	
Age	4
Wt	1015
Prog.BW	70
WR	98
YR	103
Wean Pct.	46%
Cow Eff.	97

BWt	81
WR	91
YWt.	1008
YR	104
Feb.ADG	3.03
Feb.Scr.	34
Fr.	5.0

RAAA HerdBuilder index:	207	(Top 9% of RA breed)						
RAAA GridMaster index:	52	(Top 6% of RA breed)						
Calv.Ease	BW	WW	YW	Milk	HPG	Stay	Maint.En.	
EPDs	13	-1.0	61	106	26	10	19	-3.0
Marb	+0.36		REA	+0.08		Bfat	+0.04	

★★★★★ for Low Maintenance, Marbling, Calving Ease, Stayability.

**70** **BSF RANGER F235 N5** 

1-B 99% # 3988694 Tat.: BSF8 F235

Birth: 3-13-18

Beckton Ranger Z225 J4  
 Beckton Ranger T603 H3  
 Beckton Mona U564 JT  
 Beckton Dominor W640 C5  
 Beckton Suffeina Z731 D  
 Beckton Suffeina W471 W  
 Beckton Nebula G S237  
 Beckton Lana R058 EP  
 Beckton Epic U126 J5  
 BSF Codette U826 CD

**BECKTON RANGER B006 D5**  
 Ref. R-1

**BSF CODETTE Z044 N**  
 Beckton Nebula X353 E3  
 BSF Codette X384 E

DAM	
Age	6
Wt	1140
Prog.BW	65
WR	101
YR	102
Wean Pct.	51%
Cow Eff.	107

BWt	64
WR	102
YWt.	1005
YR	101
Feb.ADG	2.92
Feb.Scr.	31
Fr.	5.5

RAAA HerdBuilder index:	175	(Top 57% of RA breed)						
RAAA GridMaster index:	50	(Top 26% of RA breed)						
Calv.Ease	BW	WW	YW	Milk	HPG	Stay	Maint.En.	
EPDs	17	-3.8	53	87	27	13	14	-3.0
Marb	+0.46		REA	-0.03		Bfat	+0.04	

★★★★★ for Low Maintenance, Marbling, Calving Ease, Stayability.



Lot 72



Lot 68

**72** **BSF EPIC F001 L8** 

1-B 99% # 3988894 Tat.: BSF8 F001

Birth: 2-6-18

Beckton Epic B483 N6  
 Beckton Epic U749 D5  
 BKT Pine Marie X339 N  
 Beckton Legend U331 E2  
 Beckton Mona U564 JT  
 Beckton Loki CL S284  
 Beckton Vernice T447 HT  
 Beckton Cherokee N N479  
 BSF Lanette R748 LN

**BECKTON EPIC D001 L7**  
 Ref. E-7

**BSF LANETTE D532 L**  
 Beckton Loki X833 H4  
 BSF Lanette U463 CQ

DAM	
Age	2
Wt	900
Prog.BW	50
WR	107
YR	104
Wean Pct.	54%
Cow Eff.	114

BWt	50
WR	107
YWt.	975
YR	104
Feb.ADG	2.92
Feb.Scr.	35
Fr.	5.5

RAAA HerdBuilder index:	193	(Top 26% of RA breed)						
RAAA GridMaster index:	51	(Top 10% of RA breed)						
Calv.Ease	BW	WW	YW	Milk	HPG	Stay	Maint.En.	
EPDs	17	-5.3	59	101	28	10	16	-2.0
Marb	+0.33		REA	+0.02		Bfat	+0.04	

★★★★★ for Low Maintenance, Marbling, Superior Cow, Calving Ease, Stayability.

• Bulls •

**73 BECKTON ACCENT F574 N4**  
1-A 100% # 3987410 Tat.: BKT8 F574



Birth: 3-31-18

Beckton Accent W180 C2  
Beckton Christy R046 CQ  
Beckton Nebula T398 V3  
Beckton Minerva M369 LO  
Beckton Nebula T398 V3  
Beckton Mona X022 L  
Beckton Accent U777 C2  
BKT Pine Marie X424 H

**BECKTON ACCENT B549 N3**  
Ref. A-3

**BECKTON PINE MARIE C072 N**  
Beckton Nebula A773 L4  
Beckton Pine Marie A513 A

BWt	62
WR	101
YWt.	1018
YR	107
Feb.ADG	3.15
Feb.Scr.	32
Fr.	5.5

**DAM**

Age	3
Wt	830
Prog.BW	57
WR	102
YR	105
Wean Pct.	59%
Cow Eff.	125

RAAA HerdBuilder index: **246** (Top 1% of RA breed)  
RAAA GridMaster index: **52** (Top 5% of RA breed)

Calv.Ease	BW	WW	YW	Milk	HPG	Stay	Maint.En.	
EPDs	15	-2.6	62	107	25	12	23	-4.0

Marb **+0.29** REA **+1.10** Bfat **+0.4**

★★★★★ for Low Maintenance, Growth, Marbling, High Cow Efficiency, Calving Ease, Stayability.

**75 BSF HERITAGE F406 L5**  
1-B 99% # 3988570 Tat.: BSF8 F406



Birth: 3-22-18

Beckton Heritage X403 L3  
Beckton Indigo H150 LN  
Beckton Justice G302  
Beckton Lana H725 CH  
Beckton Lancer F442 T  
Beckton Kit F468 JL  
Beckton Vegas S1 K316  
BSF Red H119

**BECKTON HERITAGE B612 J4**  
Ref. H-1

**BSF VIOLET X528 L**  
Beckton Legend S670  
BSF Violet N382 VG

BWt	77
WR	117
YWt.	1036
YR	104
Feb.ADG	2.87
Feb.Scr.	36
Fr.	5.5

**DAM**

Age	8
Wt	1185
Prog.BW	67
WR	104
YR	99
Wean Pct.	56%
Cow Eff.	118

RAAA HerdBuilder index: **169** (Top 68% of RA breed)  
RAAA GridMaster index: **48** (Top 62% of RA breed)

Calv.Ease	BW	WW	YW	Milk	HPG	Stay	Maint.En.	
EPDs	14	-1.9	66	94	18	12	15	-7.0

Marb **+0.30** REA **-1.13** Bfat **+0.03**

★★★★★ for Low Maintenance, Marbling, High Cow Efficiency, Calving Ease, Stayability.



Lot 73

**76 BECKTON SCAMP F117 A6**  
1-A 100% # 3987958 Tat.: BKT8 F117



Birth: 3-3-18

Beckton Scamp A627 J4  
Beckton Scamp X494 E3  
Beckton Serena R023 JC  
Beckton Nebula W065 C3  
Beckton Tamara W232 J  
Beckton Cody K1 P014  
Beckton Susan R022 CQ  
Beckton Cherokee N N479  
Beckton Tamara N765 CO

**BECKTON SCAMP D325 N5**  
Ref. S-3

**BECKTON TAMARA D561 A**  
Beckton Accent U777 C2  
Beckton Tamara R175 CQ

BWt	75
WR	97
YWt.	978
YR	109
Feb.ADG	3.03
Feb.Scr.	34
Fr.	5.5

**DAM**

Age	2
Wt	825
Prog.BW	75
WR	97
YR	109
Wean Pct.	50%
Cow Eff.	105

RAAA HerdBuilder index: **196** (Top 21% of RA breed)  
RAAA GridMaster index: **50** (Top 15% of RA breed)

Calv.Ease	BW	WW	YW	Milk	HPG	Stay	Maint.En.	
EPDs	16	-2.8	57	98	28	13	17	-6.0

Marb **+0.28** REA **+0.01** Bfat **+0.04**

★★★★★ for Low Maintenance, Growth, Marbling, Calving Ease, Stayability.

**74 BECKTON CARDINAL F137 W3**  
1-A 100% # 3987938 Tat.: BKT8 F137



Birth: 3-6-18

Beckton Cardinal B074 N  
Beckton Warrior Z936 N6  
Beckton Firefly Z663 N  
Beckton Warrior W534 N4  
Beckton Susan W058 E  
Beckton Vega P079  
Beckton Rose P015 LN

**BECKTON CARDINAL D010 W2**  
Ref. C-2

**BECKTON ROSE C844 W**  
Beckton Warrior Y108 E5  
Beckton Rose U298 VA

BWt	66
WR	99
YWt.	974
YR	106
Feb.ADG	3.37
Feb.Scr.	33
Fr.	5.5

**DAM**

Age	3
Wt	890
Prog.BW	59
WR	99
YR	106
Wean Pct.	49%
Cow Eff.	102

RAAA HerdBuilder index: **191** (Top 28% of RA breed)  
RAAA GridMaster index: **50** (Top 17% of RA breed)

Calv.Ease	BW	WW	YW	Milk	HPG	Stay	Maint.En.	
EPDs	17	-5.1	50	90	26	12	16	-4.0

Marb **+0.30** REA **-1.18** Bfat **+0.03**

★★★★★ for Low Maintenance, Growth, Marbling, Calving Ease, Stayability.

**77 BSF CARDINAL F419 A**  
1-B 99% # 3988558 Tat.: BSF8 F419



Birth: 3-22-18

TR Ricardo DOS  
Beckton Justice C1 R483  
Beckton Lana H544 WR  
Beckton Cody K1 P014  
Beckton Christy R046 CQ  
Beckton Roman J S158  
BSF Lanette S490 HW

**TR DOUBLE EAGLE ZT220**  
Ref. C-1

**BSF LANETTE B190 A**  
Beckton Accent W180 C2  
BSF Lanette U009 RA

BWt	74
WR	91
YWt.	967
YR	100
Feb.ADG	3.15
Feb.Scr.	36
Fr.	5.0

**DAM**

Age	4
Wt	1210
Prog.BW	76
WR	100
YR	104
Wean Pct.	39%
Cow Eff.	82

RAAA HerdBuilder index: **191** (Top 29% of RA breed)  
RAAA GridMaster index: **48** (Top 47% of RA breed)

Calv.Ease	BW	WW	YW	Milk	HPG	Stay	Maint.En.	
EPDs	17	-2.9	57	92	25	11	17	-2.0

Marb **+0.31** REA **+0.09** Bfat **+0.03**

★★★★★ for Low Maintenance, Marbling, Calving Ease, Stayability.

• Bulls •

**78** **BSF HERITAGE F325 L5** 

1-B 99% # 3988624 Tat.: BSF8 F325

Birth: 3-18-18

Beckton Heritage X403 L3  
**BECKTON HERITAGE B612 J4**  
 Ref. H-1 Beckton Lana N291 JC

Beckton Legend S670  
**BSF CLIFFTANA A563 L**  
 BSF Clifftana U655 CT

Beckton Heritage T270 J2  
 Beckton Indigo H150 LN  
 Beckton Justice G302  
 Beckton Lana H725 CH  
 Beckton Lancer F442 T  
 Beckton Kit F468 JL  
 Beckton Clifftop T3 N800  
 BSF Regus L479 CH

BWt	78
WR	102
YWt.	943
YR	97
Feb.ADG	2.75
Feb.Scr.	33
Fr.	5.5

Age	5
Wt	1135
Prog.BW	65
WR	103
YR	102
Wean Pct.	48%
Cow Eff.	101

RAAA HerdBuilder index: **180** (Top 50% of RA breed)  
 RAAA GridMaster index: **47** (Top 76% of RA breed)

Calv.Ease	BW	WW	YW	Milk	HPG	Stay	Maint.En.	
EPDs	14	-2.3	60	83	19	12	17	-7.0

Marb **+0.33** REA **-0.04** Bfat **+0.03**

★★★★★ for Low Maintenance, Marbling, Calving Ease, Stayability.

**80** **BECKTON LIKABLE F361 A4** 

1-A 100% # 3987680 Tat.: BKT8 F361

Birth: 3-19-18

Beckton Likable U130 L2  
**BECKTON LIKABLE C643 L3**  
 Ref. L Beckton Minola X107 L

Beckton Accent U777 C2  
**BECKTON COCA A548 A**  
 Beckton Coca T515 WA

Beckton Likable S633  
 Beckton Kit S478 LN  
 Beckton Likable U120 L2  
 Beckton Minola U188 NB  
 Beckton Cody K1 P014  
 Beckton Susan R022 CQ  
 Beckton Warhawk N560  
 Beckton Coca M637 LO

BWt	80
WR	107
YWt.	991
YR	97
Feb.ADG	2.44
Feb.Scr.	35
Fr.	5.0

Age	5
Wt	1280
Prog.BW	66
WR	106
YR	103
Wean Pct.	48%
Cow Eff.	100

RAAA HerdBuilder index: **215** (Top 5% of RA breed)  
 RAAA GridMaster index: **49** (Top 31% of RA breed)

Calv.Ease	BW	WW	YW	Milk	HPG	Stay	Maint.En.	
EPDs	17	-2.9	56	86	23	14	19	-10.0

Marb **+0.36** REA **+0.10** Bfat **+0.03**

★★★★★ for Low Maintenance, Marbling, Calving Ease, Stayability.

**79** **BSF ACCENT F088 N5** 

1-B 99% # 3988816 Tat.: BSF8 F088

Birth: 2-26-18

Beckton Accent Y260 L3  
**BECKTON ACCENT D326 N4**  
 Ref. A-7 Beckton Lydia S069 NB

Beckton Nebula Z111 N5  
**BSF NEPTALA D891 N**  
 BSF Neptala S006 JP

Beckton Accent W180 C2  
 Beckton Lana W463 L  
 Beckton Nebula P P707  
 Beckton Lydia P583 WR  
 Beckton Nebula X096 N4  
 Beckton Minola X670 N  
 Beckton Juniper P381  
 BSF Neptala P236

BWt	65
WR	101
YWt.	974
YR	104
Feb.ADG	2.81
Feb.Scr.	32
Fr.	5.5

Age	2
Wt	820
Prog.BW	65
WR	101
YR	104
Wean Pct.	56%
Cow Eff.	118

RAAA HerdBuilder index: **198** (Top 19% of RA breed)  
 RAAA GridMaster index: **50** (Top 21% of RA breed)

Calv.Ease	BW	WW	YW	Milk	HPG	Stay	Maint.En.	
EPDs	14	-2.2	60	101	27	11	18	-2.0

Marb **+0.36** REA **-0.12** Bfat **+0.04**

★★★★★ for Low Maintenance, Marbling, High Cow Efficiency, Calving Ease, Stayability.



Lot 80



Lot 77

**81** **BECKTON CARDINAL F195 N** 

1-A 100% # 3987870 Tat.: BKT8 F195

Birth: 3-10-18

TR Ricardo DOS  
**TR DOUBLE EAGLE ZT220**  
 Ref. C-1 Beckton Lana U182 JC

Beckton Nebula T398 V3  
**BECKTON MINERVA Y385 N**  
 Beckton Minerva U310 LO

BFCK Cherokee Cnyn 4912  
 TR Dyna LT111  
 Beckton Justice C1 R483  
 Beckton Lana H544 WR  
 Beckton Nebula L P093  
 Beckton Minerva J615 VG  
 Beckton Loki CL S284  
 Beckton Minerva S283 HU

BWt	63
WR	93
YWt.	1000
YR	98
Feb.ADG	2.94
Feb.Scr.	34
Fr.	5.0

Age	7
Wt	1007
Prog.BW	62
WR	99
YR	99
Wean Pct.	53%
Cow Eff.	111

RAAA HerdBuilder index: **215** (Top 5% of RA breed)  
 RAAA GridMaster index: **48** (Top 63% of RA breed)

Calv.Ease	BW	WW	YW	Milk	HPG	Stay	Maint.En.	
EPDs	20	-5.7	48	78	25	12	19	-7.0

Marb **+0.24** REA **+0.16** Bfat **+0.03**

★★★★★ for Low Maintenance, Marbling, Rib-eye area, Calving Ease, Stayability.



• Bulls •

**82 BECKTON NEBULA F369 N4**  
1-A 100% # 3987666 Tat.: BKT8 F369



Birth: 3-20-18

Beckton Nebula P P707  
**BECKTON NEBULA B557 J3**  
Ref. N-3

Beckton Nebula U206 V3  
**BECKTON ROSE Y357 N**  
Beckton Rose U726 CT

Beckton Nebula M045  
Beckton Lana M809 EP  
Beckton Justice CH M056  
Beckton Larkaba P645 JL  
Beckton Nebula P P707  
Beckton Minerva J615 VG  
Beckton Clifftop T3 N800  
Beckton Rose R545 DM

BWt 64  
WR 98  
YWt. 1019  
YR 99  
Feb.ADG 2.89  
Feb.Scr. 38  
Fr. 5.5

**DAM**  
Age 7  
Wt 1000  
Prog.BW 62  
WR 101  
YR 100  
Wean Pct. 56%  
Cow Eff. 118

RAAA HerdBuilder index: **224** (Top 2% of RA breed)  
RAAA GridMaster index: **49** (Top 39% of RA breed)  
Calv.Ease BW WW YW Milk HPG Stay Maint.En.  
EPDs **17 -5.4 48 83 28 10 21 -6.0**  
Marb **+0.46** REA **-0.22** Bfat **+0.04**

**85 BECKTON SCAMP F339 L5**  
1-A 100% # 3987712 Tat.: BKT8 F339



Birth: 3-19-18

Beckton Scamp X458 H3  
**BECKTON SCAMP C349 C4**  
Ref. S-2

Beckton Lydia W178 C  
**BECKTON LARKABA X054 L**  
Beckton Larkaba U153 LE

Beckton Scamp T A825  
BKT Pine Marie R401 HU  
BKT Clifftop TP R288  
Beckton Lydia N047 LM  
Beckton Likable S633  
Beckton Lana S718 LN  
Beckton Legend S670  
Beckton Larkaba S299 EP

BWt 69  
WR 99  
YWt. 991  
YR 97  
Feb.ADG 2.72  
Feb.Scr. 39  
Fr. 5.5

**DAM**  
Age 8  
Wt 1075  
Prog.BW 71  
WR 101  
YR 94  
Wean Pct. 52%  
Cow Eff. 110

RAAA HerdBuilder index: **175** (Top 58% of RA breed)  
RAAA GridMaster index: **48** (Top 64% of RA breed)  
Calv.Ease BW WW YW Milk HPG Stay Maint.En.  
EPDs **16 -3.3 50 75 25 13 15 -9.0**  
Marb **+0.32** REA **-0.13** Bfat **+0.01**

★★★★★ for Low Maintenance, Marbling, High Cow Efficiency, Calving Ease, Stayability.

★★★★★ for Low Maintenance, Marbling, Calving Ease, Stayability.

**83 BECKTON HERITAGE F039 L5**  
1-A 100% # 3988868 Tat.: BSF8 F039



Birth: 2-18-18

Beckton Heritage A767 C3  
**BECKTON HERITAGE D195 L4**  
Ref. H-2

Beckton Susan W846 L  
**BECKTON INDIGO D691 L**  
Beckton Indigo Y343 N

Beckton Heritage X356 E2  
Beckton Rose W816 C  
Beckton Loki CL S284  
Beckton Susan S684 JJ  
Beckton Likable X445 J3  
Beckton Minola X107 L  
Beckton Nebula T398 V3  
Beckton Indigo H150 LN

BWt 53  
WR 103  
YWt. 1021  
YR 101  
Feb.ADG 3.28  
Feb.Scr. 35  
Fr. 5.0

**DAM**  
Age 2  
Wt 825  
Prog.BW 53  
WR 103  
YR 101  
Wean Pct. 57%  
Cow Eff. 120

RAAA HerdBuilder index: **209** (Top 8% of RA breed)  
RAAA GridMaster index: **51** (Top 10% of RA breed)  
Calv.Ease BW WW YW Milk HPG Stay Maint.En.  
EPDs **17 -4.8 58 100 25 11.5 18 -4.5**  
Marb **+0.35** REA **-0.03** Bfat **+0.04**

★★★★★ for Low Maintenance, Marbling, High Cow Efficiency, Calving Ease, Stayability.



Lot 85

**84 BECKTON LIKABLE F198 N5**  
1-A 100% # 3987866 Tat.: BKT8 F198



Birth: 3-11-18

Beckton Likable X445 J3  
**BECKTON LIKABLE Z057 L4**  
Ref. L-1

Beckton Minola U107 L  
**BECKTON TARA Z160 N**  
Beckton Tara W011 N

Beckton Likable U130 L2  
Beckton Indigo U658 JL  
Beckton Likable U120 L2  
Beckton Minola U188 NB  
Beckton Nebula T269 E2  
Beckton Indigo T613 JT  
Beckton Nebula T054 H3  
Beckton Tara T227 JC

BWt 67  
WR 111  
YWt. 962  
YR 94  
Feb.ADG 1.61  
Feb.Scr. 33  
Fr. 5.5

**DAM**  
Age 6  
Wt 1230  
Prog.BW 66  
WR 110  
YR 103  
Wean Pct. 52%  
Cow Eff. 109

RAAA HerdBuilder index: **206** (Top 11% of RA breed)  
RAAA GridMaster index: **50** (Top 20% of RA breed)  
Calv.Ease BW WW YW Milk HPG Stay Maint.En.  
EPDs **16 -5.0 51 86 28 13 18 -7.0**  
Marb **+0.39** REA **-0.10** Bfat **+0.03**

★★★★★ for Low Maintenance, Marbling, Superior Cow, Calving Ease, Stayability.

**86 BECKTON NOMAD F443 J3**  
1-A 100% # 3987574 Tat.: BKT8 F443



Birth: 3-23-18

Beckton Nomad 7496  
**BECKTON NOMAD V 9871**  
Ref. V

Bkt Barmaid 6986 VR  
**BECKTON SUSAN A251 J**  
Beckton Susan X199 L

Beckton Neva 5562  
Bkt Bolt Tamrck 3913  
Beckton Varo 5642  
Bkt Lahrogno-3  
Beckton Julian 7526G  
Bkt Marta 9A13 JL  
Beckton Loki CL S284  
Beckton Susan R022 CQ

BWt 68  
WR 111  
YWt. 1047  
YR 106  
Feb.ADG 3.22  
Feb.Scr. 34  
Fr. 5.5

**DAM**  
Age 5  
Wt 1195  
Prog.BW 62  
WR 111  
YR 102  
Wean Pct. 50%  
Cow Eff. 105

RAAA HerdBuilder index: **154** (Top 85% of RA breed)  
RAAA GridMaster index: **47** (Top 84% of RA breed)  
Calv.Ease BW WW YW Milk HPG Stay Maint.En.  
EPDs **20 -6.5 46 62 25 14 11 -13.0**  
Marb **+0.29** REA **-0.23** Bfat **+0.03**

★★★★★ for Low Maintenance, Growth, Marbling, Calving Ease.

• Bulls •

**87 BECKTON ACCENT F208 H5**  
1-A 100% # 3988708 Tat.: BSF8 F208



Birth: 3-12-18

Beckton Accent Y260 L3  
Beckton Lana W463 L  
Beckton Nebula P P707  
Beckton Larkeisa P688 CH  
Beckton Hasten P292  
Beckton Lakme G128 HD  
Beckton Jet L P491  
Beckton Encino P300 LN

**BECKTON ACCENT B150 N4**  
Ref. A-2  
BKT Larkeisa S055 NB

**BECKTON ENCINO W675 H**  
Beckton Hasten H S462  
Beckton Encino S090 JT

BWt	73
WR	105
YWt.	984
YR	96
Feb.ADG	2.61
Feb.Scr.	36
Fr.	5.5

**DAM**  
Age 9  
Wt 1140  
Prog.BW 71  
WR 98  
YR 97  
Wean Pct. 52%  
Cow Eff. 110

RAAA HerdBuilder index: **209** (Top 8% of RA breed)  
RAAA GridMaster index: **46** (Top 89% of RA breed)

Calv.Ease	BW	WW	YW	Milk	HPG	Stay	Maint.En.	
EPDs	16	-3.8	53	75	23	12	20	-6.0

Marb **+0.39** REA **-0.32** Bfat **+0.04**



Lot 87

★★★★★ for Low Maintenance, Marbling, Calving Ease, Stayability.

**88 BECKTON CARDINAL F015 L3**  
1-A 100% # 3988060 Tat.: BKT8 F015



Birth: 2-14-18

Beckton Cardinal B074 N  
Beckton Warrior Z936 N6  
Beckton Firefly Z663 N  
Beckton Likable S633  
Beckton Kit S478 LN  
Beckton Julian G5 S107  
Beckton Lana S212 EP

**BECKTON CARDINAL D010 W2**  
Ref. C-2  
Beckton Firefly B052 W

**BECKTON LANA D733 L**  
Beckton Likable U130 L2  
Beckton Lana A477 J

BWt	51
WR	102
YWt.	1006
YR	99
Feb.ADG	3.17
Feb.Scr.	34
Fr.	5.0

**DAM**  
Age 2  
Wt 885  
Prog.BW 51  
WR 102  
YR 99  
Wean Pct. 52%  
Cow Eff. 110

RAAA HerdBuilder index: **199** (Top 18% of RA breed)  
RAAA GridMaster index: **50** (Top 19% of RA breed)

Calv.Ease	BW	WW	YW	Milk	HPG	Stay	Maint.En.	
EPDs	19	-6.3	50	85	26	14	16	-6.0

Marb **+0.42** REA **-0.06** Bfat **+0.05**

**90 BSF EPIC F726 N7**  
1-B 99% # 3988316 Tat.: BSF8 F726



Birth: 4-15-18

Beckton Epic U749 D5  
Beckton Indigo U504 EP  
Beckton Nebula A773 L4  
BSF Clifftana A563 L

**BECKTON EPIC Z674 E6**  
Ref. E-2  
Beckton Epic K4 N795  
Beckton Denise R308 DM  
Beckton Epic K6 S569  
Beckton Indigo S016 NB  
Beckton Nebula T398 V3  
Beckton Mona X022 L  
Beckton Legend S670  
BSF Clifftana U655 CT

BWt	73
WR	110
YWt.	1082
YR	115
Feb.ADG	3.22
Feb.Scr.	35
Fr.	5.5

**DAM**  
Age 3  
Wt 975  
Prog.BW 66  
WR 107  
YR 111  
Wean Pct. 55%  
Cow Eff. 116

RAAA HerdBuilder index: **206** (Top 10% of RA breed)  
RAAA GridMaster index: **51** (Top 9% of RA breed)

Calv.Ease	BW	WW	YW	Milk	HPG	Stay	Maint.En.	
EPDs	12	-1.2	66	109	24	12	19	-6.0

Marb **+0.35** REA **-0.06** Bfat **+0.04**

★★★★★ for Low Maintenance, Growth, Marbling, Superior Cow, High Cow Efficiency, Calving Ease, Stayability.

**89 BECKTON CARDINAL F538 E**  
1-A 100% # 3988470 Tat.: BSF8 F538



Birth: 3-28-18

TR Ricardo DOS  
Beckton Justice C1 R483  
Beckton Lana H544 WR  
Beckton Epic K4 N795  
Beckton Denise R308 DM  
Beckton Epic K F075  
Bkt Larkabel E645 MB

**TR DOUBLE EAGLE ZT220**  
Ref. C-1  
Beckton Lana U182 JC

**BECKTON LARKABEL Y286 E**  
Beckton Epic U749 D5  
Bkt Larkabel K768 EP

BWt	68
WR	111
YWt.	1051
YR	106
Feb.ADG	2.67
Feb.Scr.	31
Fr.	5.5

**DAM**  
Age 7  
Wt 1140  
Prog.BW 70  
WR 102  
YR 101  
Wean Pct. 52%  
Cow Eff. 110

RAAA HerdBuilder index: **188** (Top 35% of RA breed)  
RAAA GridMaster index: **48** (Top 48% of RA breed)

Calv.Ease	BW	WW	YW	Milk	HPG	Stay	Maint.En.	
EPDs	18	-4.3	54	88	24	12	16	-5.0

Marb **+0.32** REA **+0.03** Bfat **+0.04**



Lot 89

★★★★★ for Low Maintenance, Growth, Marbling, Calving Ease, Stayability.

• Bulls •

**91** **BSF EPIC F719 S7** 

1-B 99% # 3988322 Tat.: BSF8 F719

Birth: 4-15-18

Beckton Epic U749 D5  
**BECKTON EPIC B483 N6**  
 Ref. E-5 BKT Pine Marie X339 N

Beckton Epic K4 N795  
 Beckton Denise R308 DM  
 Beckton Nebula T269 E2  
 BKT Pine Marie S467 JE  
 Beckton Scamp T A825  
 Beckton Lana S074 EP  
 Beckton Loki CL S284  
 BSF Julia S423 JO

BWt 66  
 WR 101  
 YWt. 1007  
 YR 105  
 Feb.ADG 3.17  
 Feb.Scr. 34  
 Fr. 5.0

Beckton Scamp X494 E3  
**BSF JULIA Z100 S**  
 BSF Julia X294 L

**DAM**  
 Age 6  
 Wt 1230  
 Prog.BW 69  
 WR 103  
 YR 101  
 Wean Pct. 44%  
 Cow Eff. 93

RAAA HerdBuilder index: **165** (Top 74% of RA breed)  
 RAAA GridMaster index: **50** (Top 26% of RA breed)  
 Calv.Ease BW WW YW Milk HPG Stay Maint.En.  
 EPDs **14 -3.8 49 87 28 13 14 -1.0**  
 Marb **+0.32** REA **-0.19** Bfat **+0.04**

**94** **BECKTON LIKABLE F802 D4** 

1-A 100% # 3988248 Tat.: BSF8 F802

Birth: 4-26-18

Beckton Likable U130 L2  
**BECKTON LIKABLE B509 J3**  
 Ref. L-3 Beckton Coca T363 JL

Beckton Likable S633  
 Beckton Kit S478 LN  
 Beckton Julian G2 M345  
 Beckton Coca P435 CH  
 Beckton Dominor Z E401  
 Beckton Barmaid J012 CO  
 Beckton Warrior T C371  
 Beckton Lana J235 JL

BWt 68  
 WR 102  
 YWt. 1037  
 YR 106  
 Feb.ADG 2.61  
 Feb.Scr. 34  
 Fr. 5.0

Beckton Dominor ZC M919  
**BECKTON LANA P026 DM**  
 Beckton Lana M552 WR

**DAM**  
 Age 14  
 Wt 990  
 Prog.BW 69  
 WR 105  
 YR 104  
 Wean Pct. 57%  
 Cow Eff. 119

RAAA HerdBuilder index: **209** (Top 8% of RA breed)  
 RAAA GridMaster index: **49** (Top 31% of RA breed)  
 Calv.Ease BW WW YW Milk HPG Stay Maint.En.  
 EPDs **15 -2.6 50 80 25 17 18 -7.0**  
 Marb **+0.33** REA **-0.03** Bfat **+0.02**

★★★★★ for Low Maintenance, Growth, Marbling, Calving Ease, Stayability.

★★★★★ for Low Maintenance, Growth, Marbling, Superior Cow, High Cow Efficiency, Calving Ease, Stayability.

**92** **BSF SCAMP F651 E5** 

1-B 99% # 3988388 Tat.: BSF8 F651

Birth: 4-7-18

Beckton Scamp X458 H3  
**BECKTON SCAMP C349 C4**  
 Ref. S-2 Beckton Lydia W178 C

Beckton Scamp T A825  
 BKT Pine Marie R401 HU  
 BKT Clifftop TP R288  
 Beckton Lydia N047 LM  
 Beckton Epic T330 L5  
 Beckton Kit R503 LN  
 Beckton Warrior T248 L5  
 BSF Lanette P615

BWt 64  
 WR 103  
 YWt. 993  
 YR 101  
 Feb.ADG 2.11  
 Feb.Scr. 35  
 Fr. 5.5

Beckton Epic X330 L6  
**BSF LANETTE Z079 E**  
 BSF Lanette X568 W

**DAM**  
 Age 6  
 Wt 1035  
 Prog.BW 64  
 WR 102  
 YR 102  
 Wean Pct. 57%  
 Cow Eff. 119

RAAA HerdBuilder index: **167** (Top 72% of RA breed)  
 RAAA GridMaster index: **48** (Top 58% of RA breed)  
 Calv.Ease BW WW YW Milk HPG Stay Maint.En.  
 EPDs **16 -4.5 53 85 25 12 14 -3.0**  
 Marb **+0.28** REA **-0.13** Bfat **+0.03**

★★★★★ for Low Maintenance, Marbling, High Cow Efficiency, Calving Ease, Stayability.

**95** **BECKTON EPIC F769 J8** 

1-A 100% # 3988278 Tat.: BSF8 F769

Birth: 4-21-18

Beckton Epic Y484 N6  
**BECKTON EPIC A286 E7**  
 Ref. E-3 Beckton Larkaba Y648 E

Beckton Epic U749 D5  
 Beckton Lydia S069 NB  
 Beckton Epic U749 D5  
 Beckton Larkaba U475 CT  
 Beckton Justice C1 R483  
 Beckton Scarlett R808 NB  
 Beckton Lancer T A664  
 Bkt Barmaid 9517 RN

BWt 61  
 WR 95  
 YWt. 1045  
 YR 106  
 Feb.ADG 3.22  
 Feb.Scr. 39  
 Fr. 5.0

Beckton Justice T124 C1  
**BECKTON BARMAID W423 J**  
 Beckton Barmaid G565 LN

**DAM**  
 Age 9  
 Wt 1260  
 Prog.BW 67  
 WR 108  
 YR 109  
 Wean Pct. 43%  
 Cow Eff. 91

RAAA HerdBuilder index: **198** (Top 18% of RA breed)  
 RAAA GridMaster index: **49** (Top 28% of RA breed)  
 Calv.Ease BW WW YW Milk HPG Stay Maint.En.  
 EPDs **21 -7.0 42 80 29 12 16 -7.0**  
 Marb **+0.40** REA **-0.14** Bfat **+0.05**

★★★★★ for Low Maintenance, Growth, Marbling, Superior Cow, Calving Ease, Stayability.

**93** **BECKTON ACCENT F655 A4** 

1-A 100% # 3988382 Tat.: BSF8 F655

Birth: 4-8-18

Beckton Accent U777 C2  
**BECKTON ACCENT B653 C3**  
 Ref. A-4 Beckton Christy W779 C

Beckton Cody K1 P014  
 Beckton Susan R022 CQ  
 BKT Clifftop TP R288  
 Beckton Christy S151 NB  
 Beckton Cody K1 P014  
 Beckton Christy R046 CQ  
 Beckton Nebula T269 E2  
 Beckton Christy S151 NB

BWt 73  
 WR 90  
 YWt. 1008  
 YR 105  
 Feb.ADG 2.94  
 Feb.Scr. 36  
 Fr. 5.5

Beckton Accent W180 C2  
**BECKTON CHRISTY B240 A**  
 Beckton Christy Y364 N

**DAM**  
 Age 4  
 Wt 825  
 Prog.BW 61  
 WR 100  
 YR 104  
 Wean Pct. 56%  
 Cow Eff. 119

RAAA HerdBuilder index: **221** (Top 3% of RA breed)  
 RAAA GridMaster index: **49** (Top 33% of RA breed)  
 Calv.Ease BW WW YW Milk HPG Stay Maint.En.  
 EPDs **17 -3.4 52 89 27 12 20 -7.0**  
 Marb **+0.27** REA **-0.05** Bfat **+0.04**

★★★★★ for Low Maintenance, Growth, Marbling, High Cow Efficiency, Calving Ease, Stayability.

**96** **BSF JULIAN F633 J7** 

1-B 99% # 3988400 Tat.: BSF8 F633

Birth: 4-5-18

Beckton Julian X465 J5  
**BECKTON JULIAN D551 C6**  
 Ref. J-3 Beckton Tamara W550 A

Beckton Julian G5 S107  
 Beckton Suffeina P643 JL  
 Beckton Cody K1 P014  
 Beckton Tamara R175 CQ  
 Beckton Julian G5 S107  
 Beckton Suffeina P643 JL  
 Beckton Nebula X603 J4  
 BSF Buffie X677 E

BWt 73  
 WR 112  
 YWt. 1048  
 YR 119  
 Feb.ADG 3.50  
 Feb.Scr. 33  
 Fr. 5.0

Beckton Julian X465 J5  
**BSF BUFFIE D211 J**  
 BSF Buffie Z172 N

**DAM**  
 Age 2  
 Wt 920  
 Prog.BW 73  
 WR 112  
 YR 119  
 Wean Pct. 52%  
 Cow Eff. 110

RAAA HerdBuilder index: **193** (Top 25% of RA breed)  
 RAAA GridMaster index: **53** (Top 2% of RA breed)  
 Calv.Ease BW WW YW Milk HPG Stay Maint.En.  
 EPDs **13 -0.7 68 116 22 17 16 -5.0**  
 Marb **+0.48** REA **-0.18** Bfat **+0.05**

★★★★★ for Low Maintenance, Growth, Marbling, Superior Cow, Calving Ease, Stayability.



• Bulls •

**97 BECKTON ACCENT F836 J5**  
1-A 100% # 3987122 Tat.: BKT8 F836 

Birth: 5-1-18

Beckton Accent Y260 L3  
Beckton Lana W463 L  
Beckton Nebula P P707  
Beckton Larkieisa P688 CH  
Beckton Justice CH M056  
Beckton Tamara M878 JC  
Beckton Dominor ZC M919  
Beckton Annie E066 WR

**BECKTON ACCENT B150 N4**  
Ref. A-2  
BKT Larkieisa S055 NB

**BECKTON ANNIE T016 JC**  
Beckton Justice C2 R695  
Beckton Annie R650 DM

**DAM**  
Age 11  
Wt 950  
Prog.BW 64  
WR 104  
YR 103  
Wean Pct. 54%  
Cow Eff. 113

RAAA HerdBuilder index: **220** (Top 3% of RA breed)  
RAAA GridMaster index: **49** (Top 46% of RA breed)  
Calv.Ease BW WW YW Milk HPG Stay Maint.En.  
EPDs **20 -5.8 46 75 28 12 19 -8.0**  
Marb **+.52** REA **-.25** Bfat **+.04**

BWt 58  
WR 99  
YWt. 1033  
YR 108  
Feb.ADG 3.00  
Feb.Scr. 36  
Fr. 5.0

★★★★★ for Low Maintenance, Growth, Marbling, Superior Cow, Calving Ease, Stayability.

**100 BECKTON LIKABLE F386 S7**  
1-A 100% # 3987648 Tat.: BKT8 F386 

Birth: 3-21-18

Beckton Likable U130 L2  
Beckton Kit S478 LN  
Beckton Nebula T054 H3  
Beckton Firefly T003 JC  
Beckton Accent W180 C2  
Beckton Lana W463 L  
Beckton Nebula P P707  
Beckton Pine Marie P475 LN

**BECKTON LIKABLE D432 N3**  
Ref. L-5  
Beckton Firefly W013 N

**BECKTON PINE MARIE D268 A**  
Beckton Accent Y260 L3  
Beckton Pine Marie U621 NB

**DAM**  
Age 2  
Wt 1060  
Prog.BW 64  
WR 112  
YR 109  
Wean Pct. 49%  
Cow Eff. 103

RAAA HerdBuilder index: **220** (Top 3% of RA breed)  
RAAA GridMaster index: **51** (Top 6% of RA breed)  
Calv.Ease BW WW YW Milk HPG Stay Maint.En.  
EPDs **17 -3.6 60 101 26 13 19 -4.0**  
Marb **+.36** REA **+.00** Bfat **+.04**

BWt 64  
WR 112  
YWt. 1107  
YR 109  
Feb.ADG 3.54  
Feb.Scr. 35  
Fr. 5.5

★★★★★ for Low Maintenance, Growth, Marbling, Superior Cow, Calving Ease, Stayability.

**98 BECKTON WARRIOR F804 N7**  
1-A 100% # 3987160 Tat.: BKT8 F804 

Birth: 4-26-18

Beckton Warrior Y108 E5  
Beckton Susan W058 E  
Beckton Heritage N013  
Beckton Christy N542 JC  
Beckton Nebula L P093  
Beckton Belga R716 DM  
Beckton Nebula T054 H3  
Beckton Tara T227 JC

**BECKTON WARRIOR C237 H6**  
Ref. W  
Beckton Christy T749 HT

**BECKTON TARA A278 N**  
Beckton Nebula W486 D3  
Beckton Tara W011 N

**DAM**  
Age 5  
Wt 1165  
Prog.BW 65  
WR 105  
YR 105  
Wean Pct. 49%  
Cow Eff. 102

RAAA HerdBuilder index: **190** (Top 30% of RA breed)  
RAAA GridMaster index: **49** (Top 38% of RA breed)  
Calv.Ease BW WW YW Milk HPG Stay Maint.En.  
EPDs **14 -3.0 51 86 26 14 17 -3.0**  
Marb **+.33** REA **-.14** Bfat **+.04**

BWt 80  
WR 99  
YWt. 1026  
YR 104  
Feb.ADG 3.06  
Feb.Scr. 36  
Fr. 5.5

★★★★★ for Low Maintenance, Marbling, Superior Cow, Calving Ease, Stayability.



Not for sale

**99 BSF EPIC F629 L7**  
1-B 99% # 3988406 Tat.: BSF8 F629 

Birth: 4-5-18

Beckton Epic U749 D5  
Beckton Denise R308 DM  
Beckton Epic K6 S569  
Beckton Indigo S016 NB  
Beckton Loki C M740  
Beckton Lakme J460 LT  
Beckton Hustler C2 L079  
BSF Regus M508 LN

**BECKTON EPIC Z674 E6**  
Ref. E-2  
Beckton Indigo U504 EP

**BSF HUSTELLE U113 LO**  
Beckton Loki CL S284  
BSF Hustelle S375 HU

**DAM**  
Age 10  
Wt 1050  
Prog.BW 61  
WR 102  
YR 104  
Wean Pct. 51%  
Cow Eff. 107

RAAA HerdBuilder index: **171** (Top 65% of RA breed)  
RAAA GridMaster index: **49** (Top 39% of RA breed)  
Calv.Ease BW WW YW Milk HPG Stay Maint.En.  
EPDs **17 -4.9 53 92 27 10 14 -3.0**  
Marb **+.37** REA **-.10** Bfat **+.04**

BWt 57  
WR 93  
YWt. 1006  
YR 102  
Feb.ADG 3.44  
Feb.Scr. 34  
Fr. 5.0

★★★★★ for Low Maintenance, Marbling, Calving Ease, Stayability.

**101 BECKTON DOMINOR F748 A9**  
1-A 100% # 3987220 Tat.: BKT8 F748 

Birth: 4-19-18

Beckton Dominor A378 W7  
Beckton Dominor Y005 V6  
Beckton Lana Y541 W  
Beckton Epic T330 L5  
Beckton Scarlett W497 J  
Beckton Accent W180 C2  
Beckton Susan P857 JO  
Beckton Nebula J R475  
Beckton Annie L680 JL

**BECKTON DOMINOR C052 E8**  
Ref. D-2  
Beckton Scarlett A406 E

**BECKTON ANNIE B146 A**  
Beckton Accent Z506 J3  
Beckton Annie Z331 N

**DAM**  
Age 4  
Wt 1010  
Prog.BW 89  
WR 111  
YR 108  
Wean Pct. 57%  
Cow Eff. 120

RAAA HerdBuilder index: **202** (Top 14% of RA breed)  
RAAA GridMaster index: **52** (Top 3% of RA breed)  
Calv.Ease BW WW YW Milk HPG Stay Maint.En.  
EPDs **13 -0.4 60 105 26 12 18 -5.5**  
Marb **+.40** REA **-.11** Bfat **+.05**

BWt 89  
WR 104  
YWt. 1106  
YR 108  
Feb.ADG 3.54  
Feb.Scr. 35  
Fr. 5.5

★★★★★ for Low Maintenance, Growth, Marbling, Superior Cow, High Cow Efficiency, Calving Ease, Stayability.

• Bulls •

**102 BECKTON SCAMP F150 L6**  
1-A 100% # 3987922 Tat.: BKT8 F150 

Birth: 3-7-18

Beckton Scamp A627 J4  
**BECKTON SCAMP D325 N5**  
Ref. S-3  
Beckton Tamara Y039 N

Beckton Legend S670  
**BECKTON LANA D222 L**  
Beckton Lana T348 NB

Beckton Scamp X494 E3  
Beckton Serena R023 JC  
Beckton Nebula W065 C3  
Beckton Tamara W232 J  
Beckton Lancer F442 T  
Beckton Kit F468 JL  
Beckton Nebula E P084  
Beckton Lana M167 LN

BWt 60  
WR 103  
YWt. 1079  
YR 107  
Feb.ADG 3.43  
Feb.Scr. 34  
Fr. 5.5

**DAM**  
Age 2  
Wt 970  
Prog.BW 60  
WR 103  
YR 107  
Wean Pct. 48%  
Cow Eff. 101

RAAA HerdBuilder index: **194** (Top 24% of RA breed)  
RAAA GridMaster index: **51** (Top 12% of RA breed)  
Calv.Ease BW WW YW Milk HPG Stay Maint.En.  
EPDs **17 -4.1 58 96 26 13 16 -7.0**  
Marb **+0.31** REA **-0.01** Bfat **+0.03**

**105 BECKTON CARDINAL F210 C**  
1-A 100% # 3987856 Tat.: BKT8 F210 

Birth: 3-12-18

TR Ricardo DOS  
**TR DOUBLE EAGLE ZT220**  
Ref. C-1  
Beckton Lana U182 JC

BKT Clifftop TP R288  
**BECKTON ROSE W816 C**  
Beckton Rose S487 LN

BFCK Cherokee Cnyn 4912  
TR Dyna LT111  
Beckton Justice C1 R483  
Beckton Lana H544 WR  
Beckton Clifftop T C075  
Beckton Christy K209 CO  
Beckton Lancer T9 N586  
Beckton Rose L083 LN

BWt 72  
WR 93  
YWt. 1034  
YR 104  
Feb.ADG 3.60  
Feb.Scr. 35  
Fr. 5.0

**DAM**  
Age 9  
Wt 1065  
Prog.BW 72  
WR 99  
YR 108  
Wean Pct. 47%  
Cow Eff. 99

RAAA HerdBuilder index: **201** (Top 15% of RA breed)  
RAAA GridMaster index: **49** (Top 28% of RA breed)  
Calv.Ease BW WW YW Milk HPG Stay Maint.En.  
EPDs **17 -3.2 50 87 25 12 17 -6.0**  
Marb **+0.32** REA **+0.02** Bfat **+0.04**

★★★★★ for Low Maintenance, Growth, Marbling, Calving Ease, Stayability.

★★★★★ for Low Maintenance, Marbling, Calving Ease, Stayability.

**103 BECKTON ACCENT F646 E4**  
1-A 100% # 3987330 Tat.: BKT8 F646 

Birth: 4-7-18

Beckton Accent W180 C2  
**BECKTON ACCENT B549 N3**  
Ref. A-3  
Beckton Minerva Y654 N

Beckton Epic Y484 N6  
**BECKTON MINOLA B538 E**  
Beckton Minola X428 E

Beckton Cody K1 P014  
Beckton Christy R046 CQ  
Beckton Nebula T398 V3  
Beckton Minerva M369 LO  
Beckton Epic U749 D5  
Beckton Lydia S069 NB  
Beckton Epic U126 J5  
Beckton Minola U234 CQ

BWt 71  
WR 100  
YWt. 1113  
YR 108  
Feb.ADG 3.65  
Feb.Scr. 36  
Fr. 5.5

**DAM**  
Age 4  
Wt 1005  
Prog.BW 66  
WR 100  
YR 105  
Wean Pct. 55%  
Cow Eff. 115

RAAA HerdBuilder index: **229** (Top 1% of RA breed)  
RAAA GridMaster index: **52** (Top 3% of RA breed)  
Calv.Ease BW WW YW Milk HPG Stay Maint.En.  
EPDs **16 -2.7 60 107 25 10 20 -5.0**  
Marb **+0.31** REA **+0.12** Bfat **+0.04**

★★★★★ for Low Maintenance, Growth, Marbling, Calving Ease, Stayability.

**106 BECKTON ACCENT F115 A4**  
1-A 100% # 3988788 Tat.: BSF8 F115 

Birth: 3-3-18

Beckton Accent U777 C2  
**BECKTON ACCENT D174 N3**  
Ref. A-6  
BKT Larkeisa S055 NB

Beckton Accent W180 C2  
**BECKTON MINERVA B452 A**  
Beckton Minerva Y520 J

Beckton Cody K1 P014  
Beckton Susan R022 CQ  
Beckton Nebula P P707  
Beckton Larkeisa P688 CH  
Beckton Cody K1 P014  
Beckton Christy R046 CQ  
Beckton Julian U742 W5  
Beckton Minerva U586 CT

BWt 69  
WR 89  
YWt. 979  
YR 99  
Feb.ADG 3.15  
Feb.Scr. 36  
Fr. 5.5

**DAM**  
Age 4  
Wt 930  
Prog.BW 70  
WR 100  
YR 102  
Wean Pct. 49%  
Cow Eff. 104

RAAA HerdBuilder index: **215** (Top 5% of RA breed)  
RAAA GridMaster index: **48** (Top 63% of RA breed)  
Calv.Ease BW WW YW Milk HPG Stay Maint.En.  
EPDs **18 -4.5 49 77 25 11 20 -6.0**  
Marb **+0.37** REA **-0.05** Bfat **+0.04**

★★★★★ for Low Maintenance, Marbling, Calving Ease, Stayability.

**104 BECKTON LIKABLE F026 N4**  
1-A 100% # 3988046 Tat.: BKT8 F026 

Birth: 2-16-18

Beckton Likable U130 L2  
**BECKTON LIKABLE D432 N3**  
Ref. L-5  
Beckton Firefly W013 N

Beckton Nebula X267 J3  
**BECKTON SERENA D835 N**  
Beckton Serena X617 J

Beckton Likable S633  
Beckton Kit S478 LN  
Beckton Nebula T054 H3  
Beckton Firefly T003 JC  
Beckton Nebula T269 E2  
Beckton Indigo T613 JT  
Beckton Julian G5 S107  
Beckton Serena R023 JC

BWt 62  
WR 104  
YWt. 1036  
YR 107  
Feb.ADG 3.37  
Feb.Scr. 33  
Fr. 5.5

**DAM**  
Age 2  
Wt 845  
Prog.BW 62  
WR 104  
YR 107  
Wean Pct. 53%  
Cow Eff. 111

RAAA HerdBuilder index: **208** (Top 9% of RA breed)  
RAAA GridMaster index: **51** (Top 6% of RA breed)  
Calv.Ease BW WW YW Milk HPG Stay Maint.En.  
EPDs **17 -3.8 53 94 24 14 17 -6.0**  
Marb **+0.28** REA **+0.00** Bfat **+0.04**

★★★★★ for Low Maintenance, Growth, Marbling, Superior Cow, Calving Ease, Stayability.

**107 BECKTON HUGHES F097 A3**  
1-A 100% # 3988806 Tat.: BSF8 F097 

Birth: 2-27-18

Bieber H Hughes W109  
**BECKTON HUGHES D589 S2**  
Ref. B-1  
Beckton Sierra Z353 S

Beckton Accent Y260 L3  
**BECKTON CHRISTY D232 A**  
Beckton Christy U415 JL

Basin Hobo 0545  
Basin Rose 06T0  
Beckton Scamp X494 E3  
Beckton Sierra X555 N  
Beckton Accent W180 C2  
Beckton Lana W463 L  
Beckton Julian GJ P535  
Beckton Christy P333 CH

BWt 59  
WR 100  
YWt. 1026  
YR 101  
Feb.ADG 3.20  
Feb.Scr. 34  
Fr. 5.5

**DAM**  
Age 2  
Wt 835  
Prog.BW 59  
WR 100  
YR 101  
Wean Pct. 54%  
Cow Eff. 115

RAAA HerdBuilder index: **192** (Top 27% of RA breed)  
RAAA GridMaster index: **47** (Top 74% of RA breed)  
Calv.Ease BW WW YW Milk HPG Stay Maint.En.  
EPDs **18 -4.8 55 85 27 16 16 -6.0**  
Marb **+0.35** REA **-0.12** Bfat **+0.04**

★★★★★ for Low Maintenance, Marbling, Calving Ease, Stayability.

• Bulls •

**108 BECKTON ACCENT F724 N4**  
1-A 100% # 3987246 Tat.: BKT8 F724 

Birth: 4-15-18

Beckton Accent U777 C2  
**BECKTON ACCENT B653 C3**  
Ref. A-4  
Beckton Christy W779 C

Beckton Nebula T269 E2  
**BECKTON SIERRA Y441 N**  
Beckton Sierra S120 HW

Beckton Cody K1 P014  
Beckton Susan R022 CQ  
BKT Clifftop TP R288  
Beckton Christy S151 NB  
Beckton Nebula M045  
Beckton Ruth M967 EP  
Beckton Hawk P248  
Beckton Sierra P348 JO

BWt 72  
WR 113  
YWt. 1056  
YR 107  
Feb.ADG 3.09  
Feb.Scr. 35  
Fr. 5.5

**DAM**  
Age 7  
Wt 1085  
Prog.BW 65  
WR 106  
YR 100  
Wean Pct. 56%  
Cow Eff. 117

RAAA HerdBuilder index: 212 (Top 6% of RA breed)  
RAAA GridMaster index: 48 (Top 52% of RA breed)  
Calv.Ease BW WW YW Milk HPG Stay Maint.En.  
EPDs 17 -3.5 54 88 27 12 19 -7.0  
Marb +.27 REA -.20 Bfat +.04

**111 BECKTON EPIC F079 L8**  
1-A 100% # 3988826 Tat.: BSF8 F079 

Birth: 2-25-18

Beckton Epic Z674 E6  
**BECKTON EPIC D275 L7**  
Ref. E-9  
Beckton Lana X839 L

Beckton Legend S670  
**BECKTON MINOLA D778 L**  
Beckton Minola Z796 J

Beckton Epic U749 D5  
Beckton Indigo U504 EP  
Beckton Legend S670  
Beckton Lana S371 DM  
Beckton Lancer F442 T  
Beckton Kit F468 JL  
Beckton Julian U699 L5  
Beckton Minola K527 CO

BWt 51  
WR 106  
YWt. 1018  
YR 105  
Feb.ADG 3.37  
Feb.Scr. 32  
Fr. 5.5

**DAM**  
Age 2  
Wt 755  
Prog.BW 51  
WR 106  
YR 105  
Wean Pct. 60%  
Cow Eff. 127

RAAA HerdBuilder index: 214 (Top 5% of RA breed)  
RAAA GridMaster index: 49 (Top 33% of RA breed)  
Calv.Ease BW WW YW Milk HPG Stay Maint.En.  
EPDs 19 -5.7 49 76 23 13 18 -12.0  
Marb +.45 REA -.09 Bfat +.02

★★★★★ for Low Maintenance, Growth, Marbling, High Cow Efficiency, Calving Ease, Stayability.

★★★★★ for Low Maintenance, Growth, Marbling, Superior Cow, High Cow Efficiency, Calving Ease, Stayability.

**109 BECKTON HUGHES F064 L3**  
1-A 100% # 3988010 Tat.: BKT8 F064 

Birth: 2-22-18

Bieber H Hughes W109  
**BECKTON HUGHES D589 S2**  
Ref. B-1  
Beckton Sierra Z353 S

Beckton Likable Z057 L4  
**BECKTON MINERVA D379 L**  
Beckton Minerva W662 E

Basin Hobo 0545  
Basin Rose 06T0  
Beckton Scamp X494 E3  
Beckton Sierra X555 N  
Beckton Likable X445 J3  
Beckton Minola X107 L  
Beckton Epic T330 L5  
Beckton Minerva T318 JC

BWt 57  
WR 110  
YWt. 983  
YR 102  
Feb.ADG 2.81  
Feb.Scr. 33  
Fr. 6.0

**DAM**  
Age 2  
Wt 925  
Prog.BW 57  
WR 110  
YR 102  
Wean Pct. 51%  
Cow Eff. 108

RAAA HerdBuilder index: 196 (Top 22% of RA breed)  
RAAA GridMaster index: 49 (Top 37% of RA breed)  
Calv.Ease BW WW YW Milk HPG Stay Maint.En.  
EPDs 17 -4.9 56 93 28 14 16 -7.0  
Marb +.39 REA -.17 Bfat +.03

★★★★★ for Low Maintenance, Marbling, Calving Ease, Stayability.

**112 BECKTON LIKABLE F598 C5**  
1-A 100% # 3988430 Tat.: BSF8 F598 

Birth: 4-2-18

Beckton Likable X445 J3  
**BECKTON LIKABLE Z057 L4**  
Ref. L-1  
Beckton Minola X107 L

Beckton Clifftop Y012 C4  
**BECKTON LARKABA C482 C**  
Beckton Larkaba S299 EP

Beckton Likable U130 L2  
Beckton Indigo U658 JL  
Beckton Likable U120 L2  
Beckton Minola U188 NB  
Beckton Clifftop W692 E3  
Beckton Lana W240 C  
Beckton Epic K4 N795  
Beckton Larkaba D170 JV

BWt 72  
WR 117  
YWt. 1125  
YR 114  
Feb.ADG 3.28  
Feb.Scr. 36  
Fr. 5.0

**DAM**  
Age 3  
Wt 1000  
Prog.BW 71  
WR 112  
YR 109  
Wean Pct. 58%  
Cow Eff. 122

RAAA HerdBuilder index: 196 (Top 22% of RA breed)  
RAAA GridMaster index: 53 (Top 2% of RA breed)  
Calv.Ease BW WW YW Milk HPG Stay Maint.En.  
EPDs 13 -2.5 61 106 26 11 17 -9.0  
Marb +.41 REA -.12 Bfat +.04

★★★★★ for Low Maintenance, Growth, Marbling, Superior Cow, High Cow Efficiency, Calving Ease, Stayability.

**110 BECKTON ACCENT F292 A4**  
1-A 100% # 3987760 Tat.: BKT8 F292 

Birth: 3-17-18

Beckton Accent U777 C2  
**BECKTON ACCENT D174 N3**  
Ref. A-6  
BKT Larkeisa S055 NB

Beckton Accent U777 C2  
**BECKTON SUFFEINA D287 A**  
Beckton Suffeina A190 A

Beckton Cody K1 P014  
Beckton Susan R022 CQ  
Beckton Nebula P P707  
Beckton Larkeisa P688 CH  
Beckton Cody K1 P014  
Beckton Susan R022 CQ  
Beckton Accent Y260 L3  
Beckton Suffeina Y242 N

BWt 74  
WR 102  
YWt. 1016  
YR 100  
Feb.ADG 3.54  
Feb.Scr. 36  
Fr. 5.5

**DAM**  
Age 2  
Wt 1010  
Prog.BW 74  
WR 102  
YR 100  
Wean Pct. 46%  
Cow Eff. 97

RAAA HerdBuilder index: 203 (Top 13% of RA breed)  
RAAA GridMaster index: 48 (Top 51% of RA breed)  
Calv.Ease BW WW YW Milk HPG Stay Maint.En.  
EPDs 15 -1.8 61 95 25 10 19 -6.0  
Marb +.43 REA -.07 Bfat +.05

★★★★★ for Low Maintenance, Marbling, Calving Ease, Stayability.



Lot 112



• Bulls •

## 113 BECKTON EPIC F365 D8

1-A 100% # 3988596 Tat.: BSF8 F365



Birth: 3-20-18

Beckton Epic U749 D5  
Beckton Lydia S069 NB

**BECKTON EPIC A286 E7**  
Ref. E-3

Beckton Epic Y484 N6  
Beckton Larkaba Y648 E

Beckton Epic U749 D5  
Beckton Larkaba U475 CT

**BECKTON BELGA W389 D**

Beckton Dominor Z1 R610  
Beckton Dominor ZC M919

Beckton Sierra K557 LO  
Beckton Epic K1 K863

Beckton Belga M050 EP  
Beckton Belga K588 HD

BWt	60
WR	105
YWt.	976
YR	99
Feb.ADG	2.67
Feb.Scr.	34
Fr.	5.0

**DAM**

Age 9  
Wt 1105  
Prog.BW 71  
WR 104  
YR 101  
Wean Pct. 51%  
Cow Eff. 107

RAAA HerdBuilder index: **214** (Top 5% of RA breed)  
RAAA GridMaster index: **48** (Top 55% of RA breed)

Calv.Ease	BW	WW	YW	Milk	HPG	Stay	Maint.En.	
EPDs	21	-7.0	45	75	29	13	18	-4.0

Marb **+0.37** REA **-1.14** Bfat **+0.4**

★★★★★ for Low Maintenance, Marbling, Calving Ease, Stayability.

## 115 BECKTON EPIC F358 L7

1-A 100% # 3987684 Tat.: BKT8 F358



Birth: 3-19-18

Beckton Epic U749 D5  
Beckton Denise R308 DM

**BECKTON EPIC Z674 E6**  
Ref. E-2

Beckton Indigo U504 EP  
Beckton Indigo S016 NB

Beckton Likable U120 L2  
Beckton Lana S718 LN

**BECKTON MONA A918 L**

Beckton Nebula T398 V3  
Beckton Mona T809 NB

BWt	69
WR	98
YWt.	984
YR	96
Feb.ADG	2.56
Feb.Scr.	34
Fr.	5.5

**DAM**

Age 5  
Wt 1070  
Prog.BW 61  
WR 97  
YR 99  
Wean Pct. 52%  
Cow Eff. 110

RAAA HerdBuilder index: **195** (Top 22% of RA breed)  
RAAA GridMaster index: **48** (Top 47% of RA breed)

Calv.Ease	BW	WW	YW	Milk	HPG	Stay	Maint.En.	
EPDs	15	-3.4	54	88	27	12	18	-5.0

Marb **+0.36** REA **-0.07** Bfat **+0.04**

★★★★★ for Low Maintenance, Marbling, Calving Ease, Stayability.



Lot 113

## 116 BECKTON JET F526 W3

1-A 100% # 3987470 Tat.: BKT8 F526



Birth: 3-27-18

TR Julian Lt151  
BECKTON JULIAN GG B571

**BECKTON JET L P491**  
Ref. J

Beckton Minerva L278 LN  
MS GEOMETRIC 917

Beckton Warrior W534 N4  
Beckton Lancer TS D390

**BECKTON LANA Y032 W**

Beckton Lana W031 E  
Beckton Minerva F495 CH

Beckton Warrior C1 S337  
BKT Larkeisa S055 NB

Beckton Emperor T641 E2  
Beckton Lana T200 EM

BWt	72
WR	102
YWt.	1012
YR	99
Feb.ADG	2.67
Feb.Scr.	35
Fr.	5.0

**DAM**

Age 7  
Wt 1160  
Prog.BW 67  
WR 107  
YR 105  
Wean Pct. 50%  
Cow Eff. 106

RAAA HerdBuilder index: **183** (Top 43% of RA breed)  
RAAA GridMaster index: **48** (Top 62% of RA breed)

Calv.Ease	BW	WW	YW	Milk	HPG	Stay	Maint.En.	
EPDs	18	-5.0	43	68	28	12	15	-7.0

Marb **+0.43** REA **-0.38** Bfat **+0.04**

★★★★★ for Low Maintenance, Marbling, Superior Cow, Calving Ease, Stayability.

## 114 BECKTON ACCENT F634 A5

1-A 100% # 3987346 Tat.: BKT8 F634



Birth: 4-5-18

Beckton Accent Y260 L3  
Beckton Accent W180 C2

**BECKTON ACCENT B150 N4**  
Ref. A-2

BKT Larkeisa S055 NB  
Beckton Lana W463 L

Beckton Nebula P P707  
Beckton Larkeisa P688 CH

Beckton Accent Z506 J3  
Beckton Accent W180 C2

**BECKTON TARA B325 A**

Beckton Tara Z772 N  
Beckton Susan P857 JO

Beckton Nebula W130 D3  
Beckton Tara T537 EP

BWt	58
WR	117
YWt.	1021
YR	103
Feb.ADG	3.00
Feb.Scr.	37
Fr.	5.0

**DAM**

Age 4  
Wt 960  
Prog.BW 63  
WR 116  
YR 108  
Wean Pct. 63%  
Cow Eff. 133

RAAA HerdBuilder index: **201** (Top 15% of RA breed)  
RAAA GridMaster index: **46** (Top 90% of RA breed)

Calv.Ease	BW	WW	YW	Milk	HPG	Stay	Maint.En.	
EPDs	17	-5.0	52	75	30	11	19	-4.0

Marb **+0.43** REA **-0.28** Bfat **+0.05**

★★★★★ for Low Maintenance, Marbling, Superior Cow, High Cow Efficiency, Calving Ease, Stayability.

## 117 BECKTON SCAMP F584 N5

1-A 100% # 3987400 Tat.: BKT8 F584



Birth: 4-1-18

Beckton Scamp X458 H3  
Beckton Scamp T A825

**BECKTON SCAMP C349 C4**  
Ref. S-2

Beckton Lydia W178 C  
BKT Pine Marie R401 HU

Beckton Nebula U206 V3  
BKT Clifftop TP R288

Beckton Rose W402 N  
Beckton Lydia N047 LM

Beckton Nebula P P707  
Beckton Minerva J615 VG

Beckton Nebula L P093  
Beckton Rose L311 LN

BWt	74
WR	102
YWt.	1021
YR	100
Feb.ADG	2.72
Feb.Scr.	35
Fr.	5.5

**DAM**

Age 6  
Wt 1085  
Prog.BW 72  
WR 99  
YR 97  
Wean Pct. 53%  
Cow Eff. 112

RAAA HerdBuilder index: **181** (Top 46% of RA breed)  
RAAA GridMaster index: **48** (Top 48% of RA breed)

Calv.Ease	BW	WW	YW	Milk	HPG	Stay	Maint.En.	
EPDs	12	-2.6	58	92	23	13	17	-3.0

Marb **+0.28** REA **-0.15** Bfat **+0.03**

★★★★★ for Low Maintenance, Marbling, Calving Ease, Stayability.

• Bulls •

**118 BECKTON LIKABLE F492 J6** 1-A 100% # 3987508 Tat.: BKT8 F492 

Birth: 3-25-18

Beckton Likable Z057 L4  
**BECKTON LIKABLE B032 C5** Ref. L-2  
 Beckton Mona Z270 C

Beckton Julian G5 S107  
**BECKTON LANA U840 JL**  
 Beckton Lana S827 JL

Beckton Likable X445 J3  
 Beckton Minola X107 L  
 Beckton Clifftop W577 E3  
 Beckton Mona U584 CD  
 Beckton Julian GJ P535  
 Beckton Minola P826 DM  
 Beckton Julian G2 M345  
 Beckton Lana N163 JL

BWt	59
WR	101
YWt.	1009
YR	98
Feb.ADG	2.61
Feb.Scr.	37
Fr.	5.5

DAM	
Age	10
Wt	1055
Prog.BW	62
WR	105
YR	102
Wean Pct.	54%
Cow Eff.	114

RAAA HerdBuilder index:	206	(Top 10% of RA breed)						
RAAA GridMaster index:	50	(Top 23% of RA breed)						
Calv.Ease	BW	WW	YW	Milk	HPG	Stay	Maint.En.	
EPDs	18	-5.8	50	88	26	19	17	-10.0
Marb	+.42		REA	-.19		Bfat	+.05	

★★★★★ for Low Maintenance, Marbling, Calving Ease, Stayability.

**120 BECKTON ACCENT F118 N4** 1-A 100% # 3988786 Tat.: BSF8 F118 

Birth: 3-3-18

Beckton Accent U777 C2  
**BECKTON ACCENT D174 N3** Ref. A-6  
 BKT Larkeisa S055 NB

Beckton Nebula B046 N5  
**BECKTON JANE D070 N**  
 Beckton Jane B220 L

Beckton Cody K1 P014  
 Beckton Susan R022 CQ  
 Beckton Nebula P F707  
 Beckton Larkeisa P688 CH  
 Beckton Nebula Z180 H4  
 Beckton Tamara U151 NB  
 Beckton Legend S670  
 Beckton Jane P410 NP

BWt	47
WR	110
YWt.	983
YR	104
Feb.ADG	2.56
Feb.Scr.	37
Fr.	5.0

DAM	
Age	2
Wt	775
Prog.BW	48
WR	106
YR	103
Wean Pct.	67%
Cow Eff.	141

RAAA HerdBuilder index:	207	(Top 10% of RA breed)						
RAAA GridMaster index:	48	(Top 67% of RA breed)						
Calv.Ease	BW	WW	YW	Milk	HPG	Stay	Maint.En.	
EPDs	17	-3.9	56	83	25	13	19	-6.0
Marb	+.38		REA	-.16		Bfat	+.04	

★★★★★ for Low Maintenance, Marbling, Superior Cow, High Cow Efficiency, Calving Ease, Stayability.



Lot 119

**121 BECKTON HERITAGE F558 C5** 1-A 100% # 3987430 Tat.: BKT8 F558 

Birth: 3-30-18

Beckton Heritage X403 L3  
**BECKTON HERITAGE B612 J4** Ref. H-1  
 Beckton Lana N291 JC

BKT Clifftop TP R288  
**BECKTON LANA W240 C**  
 Beckton Lana L923 CD

Beckton Heritage T270 J2  
 Beckton Indigo H150 LN  
 Beckton Justice G302  
 Beckton Lana H725 CH  
 Beckton Clifftop T C075  
 Beckton Christy K209 CO  
 Beckton Cody K G701  
 Beckton Lana D232 HV

BWt	75
WR	101
YWt.	1015
YR	99
Feb.ADG	2.89
Feb.Scr.	35
Fr.	5.0

DAM	
Age	9
Wt	1145
Prog.BW	64
WR	104
YR	103
Wean Pct.	50%
Cow Eff.	105

RAAA HerdBuilder index:	185	(Top 39% of RA breed)						
RAAA GridMaster index:	47	(Top 83% of RA breed)						
Calv.Ease	BW	WW	YW	Milk	HPG	Stay	Maint.En.	
EPDs	14	-2.8	57	86	24	13	18	-7.0
Marb	+.24		REA	-.14		Bfat	+.05	

★★★★★ for Low Maintenance, Marbling, Calving Ease, Stayability.

**119 BECKTON NEBULA F516 N4** 1-A 100% # 3987482 Tat.: BKT8 F516 

Birth: 3-27-18

Beckton Nebula P P707  
**BECKTON NEBULA B557 J3** Ref. N-3  
 Beckton Larkaba T813 JC

Beckton Nebula P P707  
**BECKTON ROSE Z247 N**  
 Beckton Rose R507 CT

Beckton Nebula M045  
 Beckton Lana M809 EP  
 Beckton Justice CH M056  
 Beckton Larkaba P645 JL  
 Beckton Nebula M045  
 Beckton Lana M809 EP  
 Beckton Clifftop T3 N800  
 Beckton Rose N125 LN

BWt	67
WR	97
YWt.	1002
YR	98
Feb.ADG	2.89
Feb.Scr.	33
Fr.	5.0

DAM	
Age	6
Wt	1200
Prog.BW	65
WR	98
YR	96
Wean Pct.	46%
Cow Eff.	97

RAAA HerdBuilder index:	211	(Top 6% of RA breed)						
RAAA GridMaster index:	50	(Top 23% of RA breed)						
Calv.Ease	BW	WW	YW	Milk	HPG	Stay	Maint.En.	
EPDs	15	-4.4	54	93	26	10	20	-2.0
Marb	+.52		REA	-.22		Bfat	+.04	

★★★★★ for Low Maintenance, Marbling, Calving Ease, Stayability.



Lot 121

• Bulls •

**122 BECKTON NEBULA F465 C4** 2 100% # 3987546 Tat.: BKT8 F465 

Birth: 3-24-18

Beckton Nebula M045  
**BECKTON NEBULA E P084**  
 Ref. N BKT Pine Marie M119 EP

Beckton Neptune R2 K065  
 Beckton Belga K285 JL  
 Beckton Epic K F075  
 Bkt Pine Marie D126 JL  
 BKT Clifftop TP R288  
 Beckton Lydia S274 EP  
 Beckton Clifftop T3 N800  
 Beckton Larkaba M116 CE

**BECKTON LARKABA B704 C**  
 Beckton Clifftop W692 E3  
 Beckton Larkaba U619 CT

BWt	65
WR	102
YWt.	1008
YR	98
Feb.ADG	2.72
Feb.Scr.	36
Fr.	5.0

**DAM**  
 Age 4  
 Wt 1280  
 Prog.BW 71  
 WR 103  
 YR 100  
 Wean Pct. 44%  
 Cow Eff. 92

RAAA HerdBuilder index: **198** (Top 19% of RA breed)  
 RAAA GridMaster index: **48** (Top 64% of RA breed)

Calv.Ease	BW	WW	YW	Milk	HPG	Stay	Maint.En.	
EPDs	18	-5.4	46	77	27	14	17	-5.0

Marb **+0.36** REA **-0.41** Bfat **+0.06**

★★★★★ for Low Maintenance, Marbling, Calving Ease, Stayability.

**125 BECKTON ACCENT F587 N4** 1-A 100% # 3987396 Tat.: BKT8 F587 

Birth: 4-1-18

Beckton Accent W180 C2  
**BECKTON ACCENT D806 W3**  
 Ref. A-8 Beckton Coca A907 W

Beckton Cody K1 P014  
 Beckton Christy R046 CQ  
 Beckton Warrior W534 N4  
 Beckton Coca U561 CT  
 Beckton Nebula P P707  
 BKT Larkeisa T310 JC  
 Beckton Likable U130 L2  
 Beckton Tamara T201 CT

**BECKTON TAMARA B394 N**  
 Beckton New Era Y194  
 Beckton Tamara Y612 L

BWt	77
WR	103
YWt.	998
YR	97
Feb.ADG	2.89
Feb.Scr.	37
Fr.	5.0

**DAM**  
 Age 4  
 Wt 1160  
 Prog.BW 76  
 WR 104  
 YR 101  
 Wean Pct. 49%  
 Cow Eff. 103

RAAA HerdBuilder index: **203** (Top 13% of RA breed)  
 RAAA GridMaster index: **49** (Top 37% of RA breed)

Calv.Ease	BW	WW	YW	Milk	HPG	Stay	Maint.En.	
EPDs	16	-2.5	59	94	24	11	19	-3.0

Marb **+0.31** REA **+0.09** Bfat **+0.04**

★★★★★ for Low Maintenance, Marbling, Calving Ease, Stayability.

**123 BECKTON EPIC F463 J7** 1-A 100% # 3987550 Tat.: BKT8 F463 

Birth: 3-24-18

Beckton Epic U749 D5  
**BECKTON EPIC B483 N6**  
 Ref. E-5 BKT Pine Marie X339 N

Beckton Epic K4 N795  
 Beckton Denise R308 DM  
 Beckton Nebula T269 E2  
 BKT Pine Marie S467 JE  
 TR Julian LT151  
 Beckton Minerva L278 LN  
 Beckton Cherokee N N479  
 BKT Pine Marie N783 CO

**BKT PINE MARIE W404 J**  
 Beckton Jet L P491  
 BKT Pine Marie R056 CQ

BWt	66
WR	98
YWt.	1000
YR	98
Feb.ADG	3.56
Feb.Scr.	32
Fr.	5.5

**DAM**  
 Age 9  
 Wt 965  
 Prog.BW 70  
 WR 100  
 YR 97  
 Wean Pct. 58%  
 Cow Eff. 121

RAAA HerdBuilder index: **208** (Top 8% of RA breed)  
 RAAA GridMaster index: **49** (Top 29% of RA breed)

Calv.Ease	BW	WW	YW	Milk	HPG	Stay	Maint.En.	
EPDs	16	-4.7	43	75	29	11	19	-4.0

Marb **+0.40** REA **-0.20** Bfat **+0.04**

★★★★★ for Low Maintenance, Marbling, High Cow Efficiency, Calving Ease, Stayability.

**126 BECKTON EPIC F090 A8** 1-A 100% # 3988814 Tat.: BSF8 F090 

Birth: 2-26-18

Beckton Epic Z674 E6  
**BECKTON EPIC D275 L7**  
 Ref. E-9 Beckton Lana X839 L

Beckton Epic U749 D5  
 Beckton Indigo U504 EP  
 Beckton Legend S670  
 Beckton Lana S371 DM  
 Beckton Accent Y260 L3  
 BKT Larkeisa S055 NB  
 Beckton Accent Y260 L3  
 Beckton Minola X107 L

**BECKTON MINOLA D026 A**  
 Beckton Accent B150 N4  
 Beckton Minola B671 A

BWt	48
WR	100
YWt.	1024
YR	101
Feb.ADG	3.26
Feb.Scr.	34
Fr.	5.0

**DAM**  
 Age 2  
 Wt 775  
 Prog.BW 48  
 WR 100  
 YR 101  
 Wean Pct. 58%  
 Cow Eff. 123

RAAA HerdBuilder index: **209** (Top 8% of RA breed)  
 RAAA GridMaster index: **48** (Top 54% of RA breed)

Calv.Ease	BW	WW	YW	Milk	HPG	Stay	Maint.En.	
EPDs	19	-5.9	52	81	26	13	18	-7.5

Marb **+0.42** REA **-0.16** Bfat **+0.04**

★★★★★ for Low Maintenance, Marbling, High Cow Efficiency, Calving Ease, Stayability.

**124 BECKTON HERITAGE F341 W5** 1-A 100% # 3987708 Tat.: BKT8 F341 

Birth: 3-19-18

Beckton Heritage A767 C3  
**BECKTON HERITAGE D195 L4**  
 Ref. H-2 Beckton Susan W846 L

Beckton Heritage X356 E2  
 Beckton Rose W816 C  
 Beckton Loki CL S284  
 Beckton Susan S684 JJ  
 Beckton Warrior W534 N4  
 Beckton Susan W058 E  
 Beckton Warrior U636 J5  
 Beckton Lana W208 N

**BECKTON LANA D226 W**  
 Beckton Warrior Y108 E5  
 Beckton Lana Z941 W

BWt	74
WR	117
YWt.	1022
YR	101
Feb.ADG	2.83
Feb.Scr.	35
Fr.	5.5

**DAM**  
 Age 2  
 Wt 910  
 Prog.BW 74  
 WR 117  
 YR 101  
 Wean Pct. 60%  
 Cow Eff. 125

RAAA HerdBuilder index: **176** (Top 56% of RA breed)  
 RAAA GridMaster index: **51** (Top 13% of RA breed)

Calv.Ease	BW	WW	YW	Milk	HPG	Stay	Maint.En.	
EPDs	14	-1.8	69	110	21	12	15	-1.5

Marb **+0.37** REA **-0.13** Bfat **+0.04**

★★★★★ for Low Maintenance, Marbling, High Cow Efficiency, Calving Ease, Stayability.



Lot 124



• Bulls •

## 127 BECKTON LIKABLE F078 L5

1-A 100% # 3987996 Tat.: BKT8 F078 

Birth: 2-25-18

Beckton Likable Y124 L3  
**BECKTON LIKABLE D063 N4**  
 Ref. L-4  
 Beckton Serena W738 N

Beckton Likable U130 L2  
 BKT Pine Marie S802 LO  
 Beckton Nebula PJ S543  
 Beckton Serena S649 LO  
 Beckton Likable U130 L2  
 BKT Pine Marie S802 LO  
 Beckton Nebula W778 J4  
 Beckton Lana W712 N

**BECKTON LANA D598 L**  
 Beckton Lana A886 N

<b>DAM</b>
Age 2
Wt 800
Prog.BW 64
WR 103
YR 98
Wean Pct. 59%
Cow Eff. 123

BWt 64
WR 103
YWt. 993
YR 98
Feb.ADG 3.15
Feb.Scr. 33
Fr. 5.5

RAAA HerdBuilder index: 198 (Top 19% of RA breed)
RAAA GridMaster index: 49 (Top 31% of RA breed)
Calv.Ease BW WW YW Milk HPG Stay Maint.En.
EPDs 18 -4.1 53 84 25 14 17 0.0
Marb +.47 REA -.14 Bfat +.05

## 130 BECKTON SCAMP F619 D5

1-A 100% # 3988414 Tat.: BSF8 F619 

Birth: 4-4-18

Beckton Scamp X458 H3  
**BECKTON SCAMP B720 L4**  
 Ref. S-1  
 Beckton Larkaba Y448 L

Beckton Scamp T A825  
 BKT Pine Marie R401 HU  
 Beckton Likable U130 L2  
 Beckton Larkaba T655 NB  
 Beckton Dominor Y005 V6  
 Beckton Lana Y541 W

Beckton Dominor A378 W7  
**BECKTON CHRISTY C149 D**  
 Beckton Christy A234 N  
 Beckton Christy X526 L

<b>DAM</b>
Age 3
Wt 880
Prog.BW 62
WR 108
YR 107
Wean Pct. 59%
Cow Eff. 125

BWt 57
WR 107
YWt. 1065
YR 108
Feb.ADG 3.48
Feb.Scr. 36
Fr. 5.0

RAAA HerdBuilder index: 198 (Top 19% of RA breed)
RAAA GridMaster index: 52 (Top 3% of RA breed)
Calv.Ease BW WW YW Milk HPG Stay Maint.En.
EPDs 19 -4.8 54 97 27 14 15 -5.0
Marb +.42 REA +.04 Bfat +.03

★★★★★ for Low Maintenance, Marbling, High Cow Efficiency, Calving Ease, Stayability.

★★★★★ for Low Maintenance, Growth, Marbling, Superior Cow, High Cow Efficiency, Calving Ease, Stayability.

## 128 BECKTON EPIC F736 C7

1-A 100% # 3987236 Tat.: BKT8 F736 

Birth: 4-17-18

Beckton Epic U749 D5  
**BECKTON EPIC Y484 N6**  
 Ref. E-1  
 Beckton Lydia S069 NB

Beckton Epic K4 N795  
 Beckton Denise R308 DM  
 Beckton Nebula P P707  
 Beckton Lydia P583 WR  
 BKT Clifftop TP R288  
 Beckton Lydia S274 EP  
 Beckton Epic K4 N795  
 Beckton Christy L654 JL

Beckton Clifftop W692 E3  
**BECKTON CHRISTY Z587 C**  
 Beckton Christy S475 EP

<b>DAM</b>
Age 6
Wt 1240
Prog.BW 71
WR 104
YR 105
Wean Pct. 49%
Cow Eff. 102

BWt 76
WR 106
YWt. 1110
YR 108
Feb.ADG 3.32
Feb.Scr. 33
Fr. 5.0

RAAA HerdBuilder index: 177 (Top 55% of RA breed)
RAAA GridMaster index: 51 (Top 10% of RA breed)
Calv.Ease BW WW YW Milk HPG Stay Maint.En.
EPDs 13 -1.8 60 107 25 9 16 0.0
Marb +.26 REA -.06 Bfat +.05

★★★★★ for Low Maintenance, Growth, Marbling, Superior Cow, Calving Ease, Stayability.

## 131 BECKTON ACCENT F125 L4

1-A 100% # 3987952 Tat.: BKT8 F125 

Birth: 3-4-18

Beckton Accent U777 C2  
**BECKTON ACCENT D174 N3**  
 Ref. A-6  
 BKT Larkeisa S055 NB

Beckton Cody K1 P014  
 Beckton Susan R022 CQ  
 Beckton Nebula P P707  
 Beckton Larkeisa P688 CH  
 Beckton Loki CL S284  
 Beckton Vernice T447 HT  
 Beckton Nebula W130 D3  
 Beckton Larkaba S083 JL

Beckton Loki X833 H4  
**BECKTON LARKABA D713 L**  
 Beckton Larkaba Z573 N

<b>DAM</b>
Age 2
Wt 745
Prog.BW 68
WR 104
YR 104
Wean Pct. 60%
Cow Eff. 125

BWt 68
WR 104
YWt. 1006
YR 104
Feb.ADG 2.87
Feb.Scr. 35
Fr. 5.0

RAAA HerdBuilder index: 193 (Top 26% of RA breed)
RAAA GridMaster index: 50 (Top 24% of RA breed)
Calv.Ease BW WW YW Milk HPG Stay Maint.En.
EPDs 16 -3.6 57 90 24 11 17 -5.0
Marb +.47 REA -.05 Bfat +.05

★★★★★ for Low Maintenance, Marbling, Superior Cow, High Cow Efficiency, Calving Ease, Stayability.

## 129 BECKTON ACCENT F555 N5

1-A 100% # 3987434 Tat.: BKT8 F555 

Birth: 3-29-18

Beckton Accent Y260 L3  
**BECKTON ACCENT B150 N4**  
 Ref. A-2  
 BKT Larkeisa S055 NB

Beckton Accent W180 C2  
 Beckton Lana W463 L  
 Beckton Nebula P P707  
 Beckton Larkeisa P688 CH  
 Beckton Nebula T269 E2  
 Beckton Lana T104 CT  
 Beckton Julian GG B571  
 Beckton Tamara S025 EP

Beckton Nebula W065 C3  
**BECKTON TAMARA Y039 N**  
 Beckton Tamara W232 J

<b>DAM</b>
Age 7
Wt 1120
Prog.BW 61
WR 101
YR 100
Wean Pct. 50%
Cow Eff. 104

BWt 66
WR 98
YWt. 1006
YR 98
Feb.ADG 2.53
Feb.Scr. 35
Fr. 5.0

RAAA HerdBuilder index: 195 (Top 22% of RA breed)
RAAA GridMaster index: 48 (Top 66% of RA breed)
Calv.Ease BW WW YW Milk HPG Stay Maint.En.
EPDs 17 -4.7 52 80 27 12 18 -4.0
Marb +.41 REA -.22 Bfat +.05

★★★★★ for Low Maintenance, Marbling, Calving Ease, Stayability.

## 132 BECKTON EPIC F256 A7

1-A 100% # 3987804 Tat.: BKT8 F256 

Birth: 3-15-18

Beckton Epic U749 D5  
**BECKTON EPIC Z674 E6**  
 Ref. E-2  
 Beckton Indigo U504 EP

Beckton Epic K4 N795  
 Beckton Denise R308 DM  
 Beckton Epic K6 S569  
 Beckton Indigo S016 NB  
 Beckton Cody K1 P014  
 Beckton Christy R046 CQ  
 Beckton Cherokee N N479  
 Beckton Emera P378 LN

Beckton Accent W180 C2  
**BECKTON EMERA A186 A**  
 Beckton Emera U675 CQ

<b>DAM</b>
Age 5
Wt 1100
Prog.BW 67
WR 96
YR 97
Wean Pct. 45%
Cow Eff. 96

BWt 71
WR 88
YWt. 935
YR 91
Feb.ADG 2.98
Feb.Scr. 33
Fr. 5.0

RAAA HerdBuilder index: 207 (Top 10% of RA breed)
RAAA GridMaster index: 48 (Top 52% of RA breed)
Calv.Ease BW WW YW Milk HPG Stay Maint.En.
EPDs 15 -3.2 54 88 25 11 19 -4.0
Marb +.41 REA -.20 Bfat +.04

★★★★★ for Low Maintenance, Marbling, Calving Ease, Stayability.

• Bulls •

**133 BECKTON ACCENT F119 N4**  
1-A 100% # 3988784 Tat.: BSF8 F119 

Birth: 3-3-18

Beckton Accent U777 C2  
Beckton Susan R022 CQ  
Beckton Nebula P P707  
Beckton Larkeisa P688 CH  
Beckton Nebula Z180 H4  
Beckton Tamara U151 NB  
Beckton Legend S670  
Beckton Jane P410 NP

**BECKTON ACCENT D174 N3**  
Ref. A-6  
BKT Larkeisa S055 NB

**BECKTON JANE D070 N**  
Beckton Nebula B046 N5  
Beckton Jane B220 L

BWt	48
WR	101
YWt.	968
YR	102
Feb.ADG	2.98
Feb.Scr.	37
Fr.	5.5

DAM	
Age	2
Wt	
Prog.BW	48
WR	106
YR	103
Wean Pct.	%
Cow Eff.	

RAAA HerdBuilder index:	207	(Top 10% of RA breed)						
RAAA GridMaster index:	48	(Top 67% of RA breed)						
Calv.Ease	BW	WW	YW	Milk	HPG	Stay	Maint.En.	
EPDs	17	-3.9	56	83	25	13	19	-6.0
Marb	+0.38	REA	-0.16	Bfat	+0.4			

**136 BECKTON ACCENT F747 A4**  
1-A 100% # 3987222 Tat.: BKT8 F747 

Birth: 4-19-18

Beckton Accent U777 C2  
Beckton Susan R022 CQ  
BKT Clifftop TP R288  
Beckton Christy S151 NB  
Beckton Cody K1 P014  
Beckton Christy R046 CQ  
Beckton Nebula T398 V3  
Beckton Belga T551 EP

**BECKTON ACCENT B653 C3**  
Ref. A-4  
Beckton Christy W779 C

**BECKTON BELGA A160 A**  
Beckton Accent W180 C2  
Beckton Belga W103 N

BWt	70
WR	104
YWt.	1028
YR	104
Feb.ADG	3.09
Feb.Scr.	34
Fr.	5.5

DAM	
Age	5
Wt	1330
Prog.BW	64
WR	94
YR	104
Wean Pct.	42%
Cow Eff.	88

RAAA HerdBuilder index:	231	(Top 1% of RA breed)						
RAAA GridMaster index:	49	(Top 32% of RA breed)						
Calv.Ease	BW	WW	YW	Milk	HPG	Stay	Maint.En.	
EPDs	18	-3.8	56	93	25	12	21	-7.0
Marb	+0.28	REA	-0.01	Bfat	+0.04			

★★★★★ for Low Maintenance, Marbling, Superior Cow, Calving Ease, Stayability.

★★★★★ for Low Maintenance, Marbling, Calving Ease, Stayability.

**134 BECKTON LIKABLE F763 W5**  
1-A 100% # 3988284 Tat.: BSF8 F763 

Birth: 4-20-18

Beckton Likable X445 J3  
Beckton Indigo U658 JL  
Beckton Likable U120 L2  
Beckton Minola U188 NB  
Beckton Warrior C1 S337  
BKT Larkeisa S055 NB  
Beckton Loki CL S284  
Beckton Tara R609 JC

**BECKTON LIKABLE Z057 L4**  
Ref. L-1  
Beckton Minola X107 L

**BECKTON TARA A845 W**  
Beckton Warrior W534 N4  
Beckton Tara W482 L

BWt	68
WR	97
YWt.	1070
YR	104
Feb.ADG	3.65
Feb.Scr.	39
Fr.	5.0

DAM	
Age	5
Wt	1040
Prog.BW	64
WR	99
YR	101
Wean Pct.	53%
Cow Eff.	112

RAAA HerdBuilder index:	201	(Top 15% of RA breed)						
RAAA GridMaster index:	51	(Top 6% of RA breed)						
Calv.Ease	BW	WW	YW	Milk	HPG	Stay	Maint.En.	
EPDs	16	-5.0	50	91	27	14	17	-10.0
Marb	+0.45	REA	-0.09	Bfat	+0.03			

★★★★★ for Low Maintenance, Marbling, Calving Ease, Stayability.

**137 BECKTON LIKABLE F567 C5**  
1-A 100% # 3987420 Tat.: BKT8 F567 

Birth: 3-31-18

Beckton Likable X445 J3  
Beckton Indigo U658 JL  
Beckton Likable U120 L2  
Beckton Minola U188 NB  
Beckton Clifftop T C075  
Beckton Christy K209 CO  
Beckton Laramie L044  
Beckton Lydia L647 JL

**BECKTON LIKABLE Z057 L4**  
Ref. L-1  
Beckton Minola X107 L

**BECKTON LYDIA W178 C**  
BKT Clifftop TP R288  
Beckton Lydia N047 LM

BWt	54
WR	101
YWt.	995
YR	100
Feb.ADG	3.03
Feb.Scr.	33
Fr.	5.0

DAM	
Age	9
Wt	1360
Prog.BW	72
WR	101
YR	104
Wean Pct.	40%
Cow Eff.	84

RAAA HerdBuilder index:	209	(Top 8% of RA breed)						
RAAA GridMaster index:	50	(Top 16% of RA breed)						
Calv.Ease	BW	WW	YW	Milk	HPG	Stay	Maint.En.	
EPDs	16	-5.4	53	90	26	14	18	-6.0
Marb	+0.43	REA	-0.05	Bfat	+0.03			

★★★★★ for Low Maintenance, Marbling, Calving Ease, Stayability.

**135 BECKTON EPIC F388 D5**  
1-A 100% # 3987646 Tat.: BKT8 F388 

Birth: 3-21-18

Beckton Epic Y484 N6  
Beckton Lydia S069 NB  
Beckton Lancer F442 T  
Beckton Rose F306 JL  
Beckton Nebula X096 N4  
Beckton Lakme P513 EP  
Beckton Nebula Z180 H4  
Beckton Lana Z555 E

**BECKTON EPIC D454 L7**  
Ref. E-10  
Beckton Rose W606 L

**BECKTON LANA D020 N**  
Beckton Nebula B620 E5  
Beckton Lana B832 N

BWt	66
WR	110
YWt.	1085
YR	107
Feb.ADG	3.43
Feb.Scr.	32
Fr.	5.5

DAM	
Age	2
Wt	855
Prog.BW	66
WR	110
YR	107
Wean Pct.	59%
Cow Eff.	124

RAAA HerdBuilder index:	183	(Top 43% of RA breed)						
RAAA GridMaster index:	51	(Top 9% of RA breed)						
Calv.Ease	BW	WW	YW	Milk	HPG	Stay	Maint.En.	
EPDs	11	-0.8	66	108	23	11	17	0.0
Marb	+0.26	REA	+0.05	Bfat	+0.04			

★★★★★ for Low Maintenance, Growth, Marbling, Superior Cow, High Cow Efficiency, Calving Ease, Stayability.

**138 BECKTON ACCENT F384 N5**  
1-A 100% # 3988582 Tat.: BSF8 F384 

Birth: 3-21-18

Beckton Accent Y260 L3  
Beckton Accent W180 C2  
Beckton Lana W463 L  
Beckton Nebula P P707  
Beckton Larkeisa P688 CH  
Beckton Nebula M045  
Beckton Lana M809 EP  
Beckton Epic T524 L5  
Beckton Christy U702 RA

**BECKTON ACCENT B150 N4**  
Ref. A-2  
BKT Larkeisa S055 NB

**BECKTON CHRISTY B411 N**  
Beckton Nebula P P707  
Beckton Christy X694 E

BWt	66
WR	95
YWt.	981
YR	96
Feb.ADG	3.09
Feb.Scr.	36
Fr.	5.5

DAM	
Age	4
Wt	1010
Prog.BW	61
WR	92
YR	93
Wean Pct.	51%
Cow Eff.	108

RAAA HerdBuilder index:	200	(Top 17% of RA breed)						
RAAA GridMaster index:	47	(Top 83% of RA breed)						
Calv.Ease	BW	WW	YW	Milk	HPG	Stay	Maint.En.	
EPDs	17	-4.5	50	76	25	10	19	-3.0
Marb	+0.51	REA	-0.34	Bfat	+0.06			

★★★★★ for Low Maintenance, Marbling, Calving Ease, Stayability.

• Bulls •

## 139 BECKTON CARDINAL F022 E3

1-A 100% # 3988050 Tat.: BKT8 F022



Birth: 2-15-18

Beckton Cardinal B074 N  
Beckton Firefly B052 W

Beckton Epic X330 L6  
Beckton Susan T685 EP

TR Double Eagle ZT220  
BKT Pine Marie Z250 N  
Beckton Warrior Z936 N6  
Beckton Firefly Z663 N  
Beckton Epic T330 L5  
Beckton Kit R503 LN  
Beckton Epic K4 N795  
Beckton Susan P090 CE

BWt	47
WR	104
YWt.	1015
YR	105
Feb.ADG	3.20
Feb.Scr.	32
Fr.	5.0

**DAM**

Age	2
Wt	1055
Prog.BW	47
WR	105
YR	105
Wean Pct.	42%
Cow Eff.	89

RAAA HerdBuilder index: **187** (Top 35% of RA breed)  
RAAA GridMaster index: **51** (Top 11% of RA breed)

Calv.Ease	BW	WW	YW	Milk	HPG	Stay	Maint.En.	
EPDs	18	-6.8	51	93	27	10	15	-4.0

Marb **+0.41** REA **-0.05** Bfat **+0.04**

## 142 BSF LIKABLE F036 E5

1-B 99% # 3988872 Tat.: BSF8 F036



Birth: 2-18-18

Beckton Likable Y124 L3  
Beckton Serena W738 N

Beckton Epic B376 N6  
BSF Nebulann A492 N

Beckton Likable U130 L2  
BKT Pine Marie S802 LO  
Beckton Nebula PJ S543  
Beckton Serena S649 LO  
Beckton Epic U749 D5  
Beckton Tamara U185 NB  
Beckton Nebula H R233  
BSF Nebulann W084 N

BWt	56
WR	95
YWt.	945
YR	101
Feb.ADG	3.15
Feb.Scr.	35
Fr.	5.0

**DAM**

Age	2
Wt	825
Prog.BW	56
WR	95
YR	101
Wean Pct.	52%
Cow Eff.	109

RAAA HerdBuilder index: **199** (Top 18% of RA breed)  
RAAA GridMaster index: **49** (Top 31% of RA breed)

Calv.Ease	BW	WW	YW	Milk	HPG	Stay	Maint.En.	
EPDs	18	-4.7	53	92	23	14	17	0.0

Marb **+0.32** REA **-0.18** Bfat **+0.04**

★★★★★ for Low Maintenance, Marbling, Superior Cow, Calving Ease, Stayability.

★★★★★ for Low Maintenance, Marbling, Calving Ease, Stayability.

## 140 BSF EPIC F315 J8

1-B 99% # 3988628 Tat.: BSF8 F315



Birth: 3-18-18

Beckton Epic Y484 N6  
Beckton Larkaba Y648 E

Beckton Julian U699 L5  
BSF Laurel U202 CQ

Beckton Epic U749 D5  
Beckton Lydia S069 NB  
Beckton Epic U749 D5  
Beckton Larkaba U475 CT  
Beckton Julian G1 J526  
Beckton Rose L311 LN  
Beckton Cherokee N N479  
BSF Laurel N839 LN

BWt	68
WR	89
YWt.	900
YR	91
Feb.ADG	2.36
Feb.Scr.	36
Fr.	5.0

**DAM**

Age	6
Wt	1020
Prog.BW	69
WR	96
YR	97
Wean Pct.	49%
Cow Eff.	104

RAAA HerdBuilder index: **204** (Top 12% of RA breed)  
RAAA GridMaster index: **48** (Top 61% of RA breed)

Calv.Ease	BW	WW	YW	Milk	HPG	Stay	Maint.En.	
EPDs	18	-5.6	44	74	24	13	18	-7.0

Marb **+0.31** REA **-0.11** Bfat **+0.05**

★★★★★ for Low Maintenance, Marbling, Calving Ease, Stayability.

## 143 BECKTON NEBULA F489 A4

1-A 100% # 3987512 Tat.: BKT8 F489



Birth: 3-25-18

Beckton Nebula P P707  
Beckton Larkaba T813 JC

Beckton Accent A175 O3  
Beckton Lydia A407 J

Beckton Nebula M045  
Beckton Lana M809 EP  
Beckton Justice CH M056  
Beckton Larkaba P645 JL  
Beckton Accent W180 C2  
Beckton Lana R214 RA  
Beckton Julian G5 S107  
Beckton Lydia W083 N

BWt	63
WR	104
YWt.	966
YR	106
Feb.ADG	3.48
Feb.Scr.	32
Fr.	5.0

**DAM**

Age	3
Wt	980
Prog.BW	66
WR	112
YR	110
Wean Pct.	47%
Cow Eff.	98

RAAA HerdBuilder index: **208** (Top 9% of RA breed)  
RAAA GridMaster index: **51** (Top 9% of RA breed)

Calv.Ease	BW	WW	YW	Milk	HPG	Stay	Maint.En.	
EPDs	15	-3.2	57	100	28	13	18	-3.0

Marb **+0.40** REA **-0.08** Bfat **+0.04**

★★★★★ for Low Maintenance, Growth, Marbling, Superior Cow, Calving Ease, Stayability.

## 141 BECKTON LIKABLE F612 C4

1-A 100% # 3987366 Tat.: BKT8 F612



Birth: 4-3-18

Beckton Likable U130 L2  
Beckton Coca T363 JL

Beckton Clifftop W577 E3  
Beckton Suffeina W369 N

Beckton Likable S633  
Beckton Kit S478 LN  
Beckton Julian G2 M345  
Beckton Coca P435 CH  
BKT Clifftop TP R288  
BKT Pine Marie R213 EP  
Beckton Nomad T 9A14  
Beckton Suffeina P603 JL

BWt	71
WR	89
YWt.	945
YR	97
Feb.ADG	3.03
Feb.Scr.	37
Fr.	5.0

**DAM**

Age	7
Wt	1020
Prog.BW	71
WR	100
YR	96
Wean Pct.	47%
Cow Eff.	99

RAAA HerdBuilder index: **197** (Top 20% of RA breed)  
RAAA GridMaster index: **49** (Top 31% of RA breed)

Calv.Ease	BW	WW	YW	Milk	HPG	Stay	Maint.En.	
EPDs	15	-2.6	44	73	24	15	17	-7.0

Marb **+0.30** REA **-0.05** Bfat **+0.02**

★★★★★ for Low Maintenance, Marbling, Calving Ease, Stayability.

## 144 BECKTON HERITAGE F493 L5

1-A 100% # 3987506 Tat.: BKT8 F493



Birth: 3-25-18

Beckton Heritage A767 C3  
Beckton Susan W846 L

Beckton Likable Y362 L3  
Beckton Sierra Y441 N

Beckton Heritage X356 E2  
Beckton Rose W816 C  
Beckton Loki CL S284  
Beckton Susan S684 JJ  
Beckton Likable U130 L2  
Beckton Tamara M515 LN  
Beckton Nebula T269 E2  
Beckton Sierra S120 HW

BWt	74
WR	100
YWt.	993
YR	106
Feb.ADG	2.98
Feb.Scr.	34
Fr.	5.5

**DAM**

Age	2
Wt	935
Prog.BW	74
WR	100
YR	106
Wean Pct.	48%
Cow Eff.	102

RAAA HerdBuilder index: **180** (Top 50% of RA breed)  
RAAA GridMaster index: **51** (Top 9% of RA breed)

Calv.Ease	BW	WW	YW	Milk	HPG	Stay	Maint.En.	
EPDs	14	-2.0	63	105	23	11	16	-2.5

Marb **+0.38** REA **-0.14** Bfat **+0.04**

★★★★★ for Low Maintenance, Growth, Marbling, Calving Ease, Stayability.



• Bulls •

## 145 BECKTON LIKABLE F081 C4

1-A 100% # 3987994 Tat.: BKT8 F081



Birth: 2-25-18

Beckton Likable U130 L2  
**BECKTON LIKABLE D432 N3**  
 Ref. L-5  
 Beckton Firefly W013 N

Beckton Likable S633  
 Beckton Kit S478 LN  
 Beckton Nebula T054 H3  
 Beckton Firefly T003 JC  
 Beckton Clifftop Z824 C4  
 Beckton Christy Z679 C  
 Beckton Clifftop W692 E3  
 Beckton Minerva X374 E

**BECKTON MINERVA D028 C**  
 Beckton Clifftop B079 C5  
 Beckton Minerva B586 C

BWt	63
WR	91
YWt.	935
YR	100
Feb.ADG	2.92
Feb.Scr.	34
Fr.	5.5

Age	2
Wt	825
Prog.BW	63
WR	91
YR	100
Wean Pct.	49%
Cow Eff.	103

RAAA HerdBuilder index: **201** (Top 15% of RA breed)  
 RAAA GridMaster index: **50** (Top 14% of RA breed)

Calv.Ease	BW	WW	YW	Milk	HPG	Stay	Maint.En.	
EPDs	17	-3.0	47	84	24	13	17	-7.0

Marb **+0.35** REA **-0.04** Bfat **+0.04**

★★★★★ for Low Maintenance, Marbling, Calving Ease, Stayability.

## 148 BECKTON HUGHES F135 H3

1-A 100% # 3987942 Tat.: BKT8 F135



Birth: 3-6-18

Bieber H Hughes W109  
**BECKTON HUGHES D589 S2**  
 Ref. B-1  
 Beckton Sierra Z353 S

Basin Hobo 0545  
 Basin Rose 06T0  
 Beckton Scamp X494 E3  
 Beckton Sierra X555 N  
 Basin Hobo 0545  
 Basin Rose 06T0  
 Beckton Scamp T A825  
 Beckton Indigo W772 N

**BECKTON INDIGO D412 B**  
 Bieber H Hughes W109  
 Beckton Indigo A297 S

BWt	59
WR	97
YWt.	938
YR	105
Feb.ADG	2.53
Feb.Scr.	33
Fr.	5.5

Age	2
Wt	820
Prog.BW	59
WR	97
YR	105
Wean Pct.	50%
Cow Eff.	106

RAAA HerdBuilder index: **201** (Top 15% of RA breed)  
 RAAA GridMaster index: **48** (Top 64% of RA breed)

Calv.Ease	BW	WW	YW	Milk	HPG	Stay	Maint.En.	
EPDs	17	-4.1	58	91	26	16	17	-6.0

Marb **+0.35** REA **-0.11** Bfat **+0.04**

★★★★★ for Low Maintenance, Marbling, Calving Ease, Stayability.

## 146 BSF ACCENT F103 W4

1-B 99% # 3988794 Tat.: BSF8 F103



Birth: 3-1-18

Beckton Accent W180 C2  
**BECKTON ACCENT D115 N3**  
 Ref. A-5  
 Beckton Larkaba W272 N

Beckton Cody K1 P014  
 Beckton Christy R046 CQ  
 Beckton Nebula EN S347  
 Beckton Larkaba N643 HR  
 Beckton Warrior W534 N4  
 Beckton Susan W058 E  
 Beckton Likable Y675 E3  
 BSF Hustelle Y509 N

Beckton Warrior Y108 E5  
**BSF HUSTELLE D768 W**  
 BSF Hustelle A370 L

BWt	54
WR	112
YWt.	914
YR	102
Feb.ADG	2.42
Feb.Scr.	32
Fr.	5.5

Age	2
Wt	1000
Prog.BW	54
WR	112
YR	102
Wean Pct.	48%
Cow Eff.	102

RAAA HerdBuilder index: **223** (Top 2% of RA breed)  
 RAAA GridMaster index: **49** (Top 36% of RA breed)

Calv.Ease	BW	WW	YW	Milk	HPG	Stay	Maint.En.	
EPDs	20	-5.5	55	91	29	13	19	-6.0

Marb **+0.29** REA **-0.04** Bfat **+0.04**

★★★★★ for Low Maintenance, Marbling, Calving Ease, Stayability.



Lot 148

## 147 BECKTON HUGHES F396 C3

1-A 100% # 3987632 Tat.: BKT8 F396



Birth: 3-21-18

Bieber H Hughes W109  
**BECKTON HUGHES D589 S2**  
 Ref. B-1  
 Beckton Sierra Z353 S

Basin Hobo 0545  
 Basin Rose 06T0  
 Beckton Scamp X494 E3  
 Beckton Sierra X555 N  
 Beckton Clifftop W692 E3  
 Beckton Lana W240 C  
 Beckton Cherokee N N479  
 Beckton Tamara J229 NP

Beckton Clifftop Y012 C4  
**BECKTON TAMARA C147 C**  
 Beckton Tamara T111 CQ

BWt	50
WR	95
YWt.	955
YR	100
Feb.ADG	2.81
Feb.Scr.	33
Fr.	5.5

Age	3
Wt	970
Prog.BW	49
WR	95
YR	100
Wean Pct.	47%
Cow Eff.	99

RAAA HerdBuilder index: **202** (Top 14% of RA breed)  
 RAAA GridMaster index: **46** (Top 87% of RA breed)

Calv.Ease	BW	WW	YW	Milk	HPG	Stay	Maint.En.	
EPDs	20	-6.8	47	75	28	14	17	-6.0

Marb **+0.26** REA **-0.14** Bfat **+0.04**

★★★★★ for Low Maintenance, Marbling, Calving Ease, Stayability.

## 149 BECKTON DOMINOR F381 L8

1-A 100% # 3987652 Tat.: BKT8 F381



Birth: 3-21-18

Beckton Dominor Y005 V6  
**BECKTON DOMINOR A378 W7**  
 Ref. D-1  
 Beckton Lana Y541 W

Beckton Dominor W640 C5  
 Beckton Belga W108 V  
 Beckton Warrior T248 L5  
 Beckton Lana S074 EP  
 Beckton Likable S633  
 Beckton Kit S478 LN  
 BKT Clifftop TP R288  
 BKT Pine Marie M119 EP

Beckton Likable U130 L2  
**BECKTON PINE MARIE B170 L**  
 BKT Pine Marie W102 C

BWt	69
WR	83
YWt.	938
YR	97
Feb.ADG	3.15
Feb.Scr.	32
Fr.	5.0

Age	4
Wt	1040
Prog.BW	67
WR	93
YR	97
Wean Pct.	41%
Cow Eff.	86

RAAA HerdBuilder index: **217** (Top 4% of RA breed)  
 RAAA GridMaster index: **51** (Top 11% of RA breed)

Calv.Ease	BW	WW	YW	Milk	HPG	Stay	Maint.En.	
EPDs	19	-4.0	45	80	27	15	18	-5.0

Marb **+0.39** REA **+0.09** Bfat **+0.05**

★★★★★ for Low Maintenance, Marbling, Calving Ease, Stayability.

• Bulls •

## 150 BECKTON EPIC F186 A8

1-A 100% # 3987882 Tat.: BKT8 F186

Birth: 3-10-18

Beckton Epic Z674 E6  
Beckton Indigo U504 EP  
Beckton Clifftop W577 E3  
Beckton Mona U584 CD  
Beckton Cody K1 P014  
Beckton Susan R022 CQ  
Beckton Nebula X353 E3  
Beckton Kit X236 L

Beckton Epic U749 D5  
Beckton Indigo U504 EP  
Beckton Clifftop W577 E3  
Beckton Mona U584 CD  
Beckton Cody K1 P014  
Beckton Susan R022 CQ  
Beckton Nebula X353 E3  
Beckton Kit X236 L

Beckton Epic D457 C7  
Ref. E-11  
Beckton Mona Z270 C

Beckton Accent U777 C2  
Beckton Kit D126 A  
Beckton Kit Z049 N

BWt	60
WR	99
YWt.	943
YR	101
Feb.ADG	2.70
Feb.Scr.	34
Fr.	5.0

Age	2
Wt	820
Prog.BW	60
WR	98
YR	101
Wean Pct.	54%
Cow Eff.	114

RAAA HerdBuilder index: **203** (Top 13% of RA breed)  
RAAA GridMaster index: **49** (Top 35% of RA breed)

Calv.Ease	BW	WW	YW	Milk	HPG	Stay	Maint.En.	
EPDs	18	-4.8	51	89	27	11	18	-5.0

Marb **+0.33** REA **-0.03** Bfat **+0.04**

★★★★★ for Low Maintenance, Marbling, Calving Ease, Stayability.

## 153 BSF EPIC F057 L8

1-B 99% # 3988848 Tat.: BSF8 F057

Birth: 2-22-18

Beckton Epic B310 J6  
Beckton Minerva Y116 J  
Beckton Julian X465 J5  
BKT Pine Marie P351 EP  
Beckton Likable U130 L2  
BKT Pine Marie S802 LO  
Beckton Loki CL S284  
BSF Hustelle S375 HU

Beckton Epic X464 L5  
Beckton Minerva Y116 J  
Beckton Julian X465 J5  
BKT Pine Marie P351 EP  
Beckton Likable U130 L2  
BKT Pine Marie S802 LO  
Beckton Loki CL S284  
BSF Hustelle S375 HU

Beckton Epic D110 J7  
Ref. E-8  
Beckton Pine Marie B248 J

Beckton Likable Y124 L3  
BSF Hustelle U113 LO

BWt	58
WR	111
YWt.	945
YR	106
Feb.ADG	2.70
Feb.Scr.	32
Fr.	5.5

Age	2
Wt	875
Prog.BW	58
WR	111
YR	106
Wean Pct.	55%
Cow Eff.	115

RAAA HerdBuilder index: **188** (Top 34% of RA breed)  
RAAA GridMaster index: **50** (Top 27% of RA breed)

Calv.Ease	BW	WW	YW	Milk	HPG	Stay	Maint.En.	
EPDs	17	-4.2	59	98	27	14	15	-3.0

Marb **+0.35** REA **-0.06** Bfat **+0.04**

★★★★★ for Low Maintenance, Growth, Marbling, Superior Cow, Calving Ease, Stayability.

## 151 BECKTON HERITAGE F030 H5

1-A 100% # 3988040 Tat.: BKT8 F030

Birth: 2-17-18

Beckton Heritage A767 C3  
Beckton Rose W816 C  
Beckton Loki CL S284  
Beckton Susan S684 JJ  
Beckton Heritage X356 E2  
Beckton Rose W816 C  
Beckton Epic T524 L5  
Beckton Tamara T783 NW

Beckton Heritage X356 E2  
Beckton Rose W816 C  
Beckton Epic T524 L5  
Beckton Tamara T783 NW

Beckton Heritage D195 L4  
Ref. H-2  
Beckton Susan W846 L

Beckton Heritage A767 C3  
Beckton Tamara D529 H  
Beckton Tamara W204 E

BWt	49
WR	89
YWt.	1003
YR	112
Feb.ADG	3.76
Feb.Scr.	34
Fr.	5.0

Age	2
Wt	800
Prog.BW	49
WR	89
YR	112
Wean Pct.	46%
Cow Eff.	97

RAAA HerdBuilder index: **197** (Top 20% of RA breed)  
RAAA GridMaster index: **51** (Top 13% of RA breed)

Calv.Ease	BW	WW	YW	Milk	HPG	Stay	Maint.En.	
EPDs	19	-5.7	54	96	25	10.5	16	-3.0

Marb **+0.34** REA **-0.06** Bfat **+0.05**

★★★★★ for Low Maintenance, Growth, Marbling, Calving Ease, Stayability.

## 154 WCRA NEBULA F139

1-A 100% # 3970044 Tat.: WCRA8 FC13

Birth: 3-14-18

Beckton Nebula M045  
Beckton Neptune R2 K065  
Beckton Belga K285 JL  
Beckton Epic K1 K863  
Beckton Lana K253 DM  
Beckton Likable U130 L2  
Beckton Marta W883 J  
Beckton Likable U130 L2  
Beckton Christy N626 LN

Beckton Nebula M045  
Beckton Neptune R2 K065  
Beckton Belga K285 JL  
Beckton Epic K1 K863  
Beckton Lana K253 DM  
Beckton Likable U130 L2  
Beckton Marta W883 J  
Beckton Likable U130 L2  
Beckton Christy N626 LN

Beckton Nebula P P707  
Ref. N-1  
Beckton Lana M809 EP

Beckton Likable B353 J3  
Beckton D111 L4  
Beckton Christy B208 L

BWt	67
WR	91
YWt.	960
YR	95
Feb.ADG	2.75
Feb.Scr.	32
Fr.	5.5

Age	2
Wt	800
Prog.BW	NA
WR	NA
YR	NA
Wean Pct.	%
Cow Eff.	

RAAA HerdBuilder index: **200** (Top 16% of RA breed)  
RAAA GridMaster index: **49** (Top 37% of RA breed)

Calv.Ease	BW	WW	YW	Milk	HPG	Stay	Maint.En.	
EPDs	12	-3.8	56	96	25	11	20	-4.0

Marb **+0.60** REA **-0.29** Bfat **+0.06**

★★★★★ for Low Maintenance, Marbling, Calving Ease, Stayability.

## 152 BECKTON LIKABLE F494 E5

1-A 100% # 3988510 Tat.: BSF8 F494

Birth: 3-25-18

Beckton Likable X445 J3  
Beckton Indigo U658 JL  
Beckton Likable U120 L2  
Beckton Minola U188 NB  
Beckton Emperor Y459 J3  
Beckton Minola Y634 W  
Beckton Nebula E P084  
Beckton Suffeina W294 D

Beckton Likable U130 L2  
Beckton Indigo U658 JL  
Beckton Likable U120 L2  
Beckton Minola U188 NB  
Beckton Emperor Y459 J3  
Beckton Minola Y634 W  
Beckton Nebula E P084  
Beckton Suffeina W294 D

Beckton Likable Z057 L4  
Ref. L-1  
Beckton Minola X107 L

Beckton Emperor A165 W4  
Beckton Suffeina C124 E  
Beckton Suffeina A439 N

BWt	61
WR	99
YWt.	967
YR	106
Feb.ADG	2.81
Feb.Scr.	33
Fr.	5.5

Age	3
Wt	845
Prog.BW	55
WR	103
YR	109
Wean Pct.	51%
Cow Eff.	108

RAAA HerdBuilder index: **202** (Top 14% of RA breed)  
RAAA GridMaster index: **53** (Top 2% of RA breed)

Calv.Ease	BW	WW	YW	Milk	HPG	Stay	Maint.En.	
EPDs	16	-4.6	54	99	26	15.5	16	-9.0

Marb **+0.47** REA **-0.07** Bfat **+0.03**

★★★★★ for Low Maintenance, Growth, Marbling, Superior Cow, Calving Ease, Stayability.

## 155 BECKTON CLIFFTOP F488 N6

1-A 100% # 3987514 Tat.: BKT8 F488

Birth: 3-25-18

Beckton Clifftop B848 J4  
Beckton Clifftop W692 E3  
Beckton Belga S198 JL  
Beckton Clifftop W692 E3  
Beckton Larkaba X054 L  
Beckton Nebula W778 J4  
Beckton Lana T104 CT  
Beckton Nebula Y002 C5  
Beckton Ruth Y047 N

Beckton Clifftop W692 E3  
Beckton Belga S198 JL  
Beckton Clifftop W692 E3  
Beckton Larkaba X054 L  
Beckton Nebula W778 J4  
Beckton Lana T104 CT  
Beckton Nebula Y002 C5  
Beckton Ruth Y047 N

Beckton Clifftop D059 C5  
Ref. C-3  
Beckton Larkaba B565 C

Beckton Nebula A394 C5  
Beckton Ruth C356 N  
Beckton Ruth A010 N

BWt	56
WR	103
YWt.	984
YR	100
Feb.ADG	2.98
Feb.Scr.	33
Fr.	5.5

Age	3
Wt	900
Prog.BW	59
WR	103
YR	100
Wean Pct.	56%
Cow Eff.	118

RAAA HerdBuilder index: **203** (Top 13% of RA breed)  
RAAA GridMaster index: **48** (Top 61% of RA breed)

Calv.Ease	BW	WW	YW	Milk	HPG	Stay	Maint.En.	
EPDs	17	-3.6	53	80	23	14	18	-4.0

Marb **+0.34** REA **-0.21** Bfat **+0.04**

★★★★★ for Low Maintenance, Marbling, High Cow Efficiency, Calving Ease, Stayability.

• Bulls •

## 156 BECKTON NEBULA F699 A5

1-A 100% # 3987276 Tat.: BKT8 F699 

Birth: 4-12-18

Beckton Nebula T398 V3  
**BECKTON NEBULA X603 J4**  
 Ref. N-2 Beckton Firefly T003 JC

Beckton Nebula L P093  
 Beckton Minerva J615 VG  
 Beckton Justice C1 R483  
 Beckton Firefly R064 NW  
 Beckton Cody K1 P014  
 Beckton Susan R022 CQ  
 Beckton Lancer T7 M089  
 Beckton Rose L083 LN

BWt 77  
 WR 109  
 YWt. 1002  
 YR 101  
 Feb.ADG 2.75  
 Feb.Scr. 35  
 Fr. 5.0

Beckton Accent U777 C2  
**BECKTON ROSE Y101 A**  
 Beckton Rose R353 LN

**DAM**  
 Age 7  
 Wt 1240  
 Prog.BW 60  
 WR 100  
 YR 101  
 Wean Pct. 47%  
 Cow Eff. 99

RAAA HerdBuilder index: **222** (Top 2% of RA breed)  
 RAAA GridMaster index: **48** (Top 54% of RA breed)  
 Calv.Ease BW WW YW Milk HPG Stay Maint.En.  
 EPDs **17 -3.6 54 85 25 13 21 -4.0**  
 Marb **+0.30** REA **-0.01** Bfat **+0.40**

★★★★★ for Low Maintenance, Marbling, Calving Ease, Stayability.

## 159 BECKTON ACCENT F778 E3

1-A 100% # 3987188 Tat.: BKT8 F778 

Birth: 4-22-18

Beckton Cody K1 P014  
**BECKTON ACCENT W180 C2**  
 Ref. A-1 Beckton Christy R046 CQ

Beckton Cody KH M390  
 Beckton Rose M126 WR  
 Beckton Cherokee N N479  
 Beckton Christy N740 HR  
 Beckton Epic K6 S569  
 Beckton Lana M393 LN  
 Beckton Loki C M740  
 Beckton Indigo M571 EP

BWt 67  
 WR 103  
 YWt. 1047  
 YR 102  
 Feb.ADG 3.20  
 Feb.Scr. 36  
 Fr. 5.5

Beckton Epic X464 L5  
**BECKTON INDIGO B204 E**  
 Beckton Indigo P043 LO

**DAM**  
 Age 4  
 Wt 1150  
 Prog.BW 76  
 WR 112  
 YR 107  
 Wean Pct. 49%  
 Cow Eff. 104

RAAA HerdBuilder index: **211** (Top 6% of RA breed)  
 RAAA GridMaster index: **49** (Top 39% of RA breed)  
 Calv.Ease BW WW YW Milk HPG Stay Maint.En.  
 EPDs **16 -3.1 61 99 27 11 20 0.0**  
 Marb **+0.22** REA **+0.03** Bfat **+0.03**

★★★★★ for Low Maintenance, Marbling, Superior Cow, Calving Ease, Stayability.

## 157 BECKTON LIKABLE F589 E5

1-A 100% # 3987394 Tat.: BKT8 F589 

Birth: 4-1-18

Beckton Likable X445 J3  
**BECKTON LIKABLE Z057 L4**  
 Ref. L-1 Beckton Minola X107 L

Beckton Likable U130 L2  
 Beckton Indigo U658 JL  
 Beckton Likable U120 L2  
 Beckton Minola U188 NB  
 Beckton Epic U749 D5  
 Beckton Lydia S069 NB  
 Beckton Epic U749 D5  
 Beckton Eola T435 NB

BWt 55  
 WR 95  
 YWt. 980  
 YR 99  
 Feb.ADG 3.15  
 Feb.Scr. 36  
 Fr. 4.5

Beckton Epic Y484 N6  
**BECKTON EOLA A020 E**  
 Beckton Eola Y412 E

**DAM**  
 Age 5  
 Wt 990  
 Prog.BW 69  
 WR 98  
 YR 97  
 Wean Pct. 51%  
 Cow Eff. 108

RAAA HerdBuilder index: **203** (Top 13% of RA breed)  
 RAAA GridMaster index: **51** (Top 8% of RA breed)  
 Calv.Ease BW WW YW Milk HPG Stay Maint.En.  
 EPDs **16 -5.3 51 93 26 14 18 -6.0**  
 Marb **+0.37** REA **+0.02** Bfat **+0.03**

★★★★★ for Low Maintenance, Marbling, Calving Ease, Stayability.

## 160 BECKTON HERITAGE F720 J5

1-A 100% # 3987252 Tat.: BKT8 F720 

Birth: 4-15-18

Beckton Heritage X403 L3  
**BECKTON HERITAGE B612 J4**  
 Ref. H-1 Beckton Lana N291 JC

Beckton Heritage T270 J2  
 Beckton Indigo H150 LN  
 Beckton Justice G302  
 Beckton Lana H725 CH  
 TR Julian LT151  
 Beckton Minerva L278 LN  
 Beckton Lancer T7 M089  
 Beckton Rose M131 HR

BWt 75  
 WR 112  
 YWt. 1049  
 YR 106  
 Feb.ADG 3.26  
 Feb.Scr. 34  
 Fr. 5.0

Beckton Jet L P491  
**BECKTON ROSE W283 J**  
 Beckton Rose P016 LN

**DAM**  
 Age 9  
 Wt 1270  
 Prog.BW 78  
 WR 106  
 YR 106  
 Wean Pct. 47%  
 Cow Eff. 100

RAAA HerdBuilder index: **173** (Top 62% of RA breed)  
 RAAA GridMaster index: **48** (Top 49% of RA breed)  
 Calv.Ease BW WW YW Milk HPG Stay Maint.En.  
 EPDs **13 -1.5 65 97 21 11 16 -2.0**  
 Marb **+0.31** REA **-0.21** Bfat **+0.03**

★★★★★ for Low Maintenance, Growth, Marbling, Superior Cow, Calving Ease, Stayability.

## 158 BECKTON SCAMP F091 A6

1-A 100% # 3987984 Tat.: BKT8 F091 

Birth: 2-26-18

Beckton Scamp B720 L4  
**BECKTON SCAMP D065 L5**  
 Ref. S Beckton Lana B316 L

Beckton Scamp X458 H3  
 Beckton Larkaba Y448 L  
 Beckton Likable Y124 L3  
 Beckton Lana W748 D  
 Beckton Cody K1 P014  
 Beckton Christy R046 CQ  
 Beckton Julio L233  
 Beckton Lana R121 JC

BWt 61  
 WR 101  
 YWt. 967  
 YR 95  
 Feb.ADG 2.87  
 Feb.Scr. 34  
 Fr. 5.5

Beckton Accent W180 C2  
**BECKTON LANA D364 A**  
 Beckton Lana W479 J

**DAM**  
 Age 2  
 Wt 965  
 Prog.BW 61  
 WR 101  
 YR 95  
 Wean Pct. 48%  
 Cow Eff. 100

RAAA HerdBuilder index: **190** (Top 31% of RA breed)  
 RAAA GridMaster index: **47** (Top 72% of RA breed)  
 Calv.Ease BW WW YW Milk HPG Stay Maint.En.  
 EPDs **17 -4.0 50 75 25 13 17 -6.0**  
 Marb **+0.39** REA **-0.02** Bfat **+0.04**

★★★★★ for Low Maintenance, Marbling, Calving Ease, Stayability.

## 161 BECKTON ACCENT F327 A3

1-A 100% # 3987724 Tat.: BKT8 F327 

Birth: 3-18-18

Beckton Cody K1 P014  
**BECKTON ACCENT W180 C2**  
 Ref. A-1 Beckton Christy R046 CQ

Beckton Cody KH M390  
 Beckton Rose M126 WR  
 Beckton Cherokee N N479  
 Beckton Christy N740 HR  
 Beckton Accent W180 C2  
 Beckton Lana W463 L  
 Beckton Clifftop W577 E3  
 Beckton Emera P378 LN

BWt 59  
 WR 119  
 YWt. 950  
 YR 102  
 Feb.ADG 2.81  
 Feb.Scr. 34  
 Fr. 5.5

Beckton Accent Y260 L3  
**BECKTON EMERA C369 A**  
 Beckton Emera Z775 C

**DAM**  
 Age 3  
 Wt 1085  
 Prog.BW 63  
 WR 114  
 YR 107  
 Wean Pct. 49%  
 Cow Eff. 103

RAAA HerdBuilder index: **236** (Top 1% of RA breed)  
 RAAA GridMaster index: **48** (Top 53% of RA breed)  
 Calv.Ease BW WW YW Milk HPG Stay Maint.En.  
 EPDs **18 -4.1 57 89 27 10 22 -1.0**  
 Marb **+0.31** REA **+0.00** Bfat **+0.03**

★★★★★ for Low Maintenance, Marbling, Superior Cow, Calving Ease, Stayability.



• Bulls •

**162 BECKTON EPIC F313 A7** 1-A 100% # 3987740 Tat.: BKT8 F313 

Birth: 3-18-18

Beckton Epic U749 D5  
**BECKTON EPIC Y484 N6** Ref. E-1  
 Beckton Lydia S069 NB

Beckton Epic K4 N795  
 Beckton Denise R308 DM  
 Beckton Nebula P P707  
 Beckton Lydia P583 WR  
 Beckton Accent W180 C2  
 Beckton Lana W463 L  
 Beckton Accent W180 C2  
 Beckton Lana R205 EP

BWt 60  
 WR 115  
 YWt. 964  
 YR 103  
 Feb.ADG 2.53  
 Feb.Scr. 34  
 Fr. 5.5

Beckton Accent Y260 L3  
**BECKTON LANA C676 A**  
 Beckton Lana Z724 A

**DAM**  
 Age 3  
 Wt 830  
 Prog.BW 61  
 WR 115  
 YR 105  
 Wean Pct. 61%  
 Cow Eff. 129

RAAA HerdBuilder index: 187 (Top 36% of RA breed)  
 RAAA GridMaster index: 49 (Top 31% of RA breed)  
 Calv.Ease BW WW YW Milk HPG Stay Maint.En.  
 EPDs 14 -3.1 57 97 26 8 17 -2.0  
 Marb +.29 REA +.04 Bfat +.04

**165 BECKTON CLIFFTOP F329 N6** 1-A 100% # 3987722 Tat.: BKT8 F329 

Birth: 3-18-18

Beckton Clifftop B848 J4  
**BECKTON CLIFFTOP D059 C5** Ref. C-3  
 Beckton Larkaba B565 C

Beckton Clifftop W692 E3  
 Beckton Belga S198 JL  
 Beckton Clifftop W692 E3  
 Beckton Larkaba X054 L  
 Beckton Nebula P P707  
 BKT Larkeisa T310 JC  
 Beckton Emcee W271 L2  
 Beckton Ruth W488 J

BWt 65  
 WR 93  
 YWt. 944  
 YR 92  
 Feb.ADG 2.64  
 Feb.Scr. 33  
 Fr. 5.0

Beckton New Era Y194  
**BECKTON RUTH B426 N**  
 Beckton Ruth Y015 E

**DAM**  
 Age 4  
 Wt 1190  
 Prog.BW 63  
 WR 98  
 YR 98  
 Wean Pct. 43%  
 Cow Eff. 90

RAAA HerdBuilder index: 183 (Top 44% of RA breed)  
 RAAA GridMaster index: 47 (Top 72% of RA breed)  
 Calv.Ease BW WW YW Milk HPG Stay Maint.En.  
 EPDs 17 -3.2 49 77 28 11 16 -5.5  
 Marb +.34 REA -.15 Bfat +.03

★★★★★ for Low Maintenance, Marbling, Superior Cow, High Cow Efficiency, Calving Ease, Stayability.

★★★★★ for Low Maintenance, Marbling, Calving Ease, Stayability.

**163 BECKTON SCAMP F743 A5** 1-A 100% # 3988298 Tat.: BSF8 F743 

Birth: 4-17-18

Beckton Scamp X458 H3  
**BECKTON SCAMP B720 L4** Ref. S-1  
 Beckton Larkaba Y448 L

Beckton Scamp T A825  
 BKT Pine Marie R401 HU  
 Beckton Likable U130 L2  
 Beckton Larkaba T655 NB  
 Beckton Accent U777 C2  
 BKT Larkeisa S055 NB  
 Beckton Warrior N645 T1  
 Beckton Suffeina P671 LN

BWt 57  
 WR 101  
 YWt. 1053  
 YR 103  
 Feb.ADG 2.98  
 Feb.Scr. 37  
 Fr. 5.0

Beckton Accent Y312 N3  
**BECKTON SUFFEINA B474 A**  
 Beckton Suffeina W471 W

**DAM**  
 Age 4  
 Wt 1080  
 Prog.BW 64  
 WR 98  
 YR 93  
 Wean Pct. 51%  
 Cow Eff. 108

RAAA HerdBuilder index: 182 (Top 45% of RA breed)  
 RAAA GridMaster index: 51 (Top 10% of RA breed)  
 Calv.Ease BW WW YW Milk HPG Stay Maint.En.  
 EPDs 19 -5.4 57 96 23 14 13 -4.0  
 Marb +.39 REA -.06 Bfat +.03

★★★★★ for Low Maintenance, Marbling, Calving Ease, Stayability.

**166 BECKTON ACCENT F583 C4** 1-A 100% # 3988442 Tat.: BSF8 F583 

Birth: 4-1-18

Beckton Accent U777 C2  
**BECKTON ACCENT B653 C3** Ref. A-4  
 Beckton Christy W779 C

Beckton Cody K1 P014  
 Beckton Susan R022 CQ  
 BKT Clifftop TP R288  
 Beckton Christy S151 NB  
 Beckton Cherokee N N479  
 Beckton Annie M337 LN  
 Beckton Julian 7526G  
 Beckton Lana L665 VG

BWt 64  
 WR 89  
 YWt. 943  
 YR 92  
 Feb.ADG 2.92  
 Feb.Scr. 36  
 Fr. 5.0

Beckton Cherokee T450 L3  
**BECKTON LANA X767 C**  
 Beckton Lana T674 JL

**DAM**  
 Age 8  
 Wt 1010  
 Prog.BW 64  
 WR 107  
 YR 106  
 Wean Pct. 50%  
 Cow Eff. 106

RAAA HerdBuilder index: 200 (Top 17% of RA breed)  
 RAAA GridMaster index: 47 (Top 84% of RA breed)  
 Calv.Ease BW WW YW Milk HPG Stay Maint.En.  
 EPDs 19 -4.8 44 74 28 13 18 -7.0  
 Marb +.21 REA -.08 Bfat +.04

★★★★★ for Low Maintenance, Marbling, Superior Cow, Calving Ease, Stayability.

**164 BECKTON EPIC F775 D7** 1-A 100% # 3987190 Tat.: BKT8 F775 

Birth: 4-22-18

Beckton Epic U749 D5  
**BECKTON EPIC Z674 E6** Ref. E-2  
 Beckton Indigo U504 EP

Beckton Epic K4 N795  
 Beckton Denise R308 DM  
 Beckton Epic K6 S569  
 Beckton Indigo S016 NB  
 Beckton Dominor Z1 R610  
 Beckton Mona R166 CQ  
 Beckton Justice G302  
 Bkt Larkeisa G448 CT

BWt 72  
 WR 103  
 YWt. 997  
 YR 97  
 Feb.ADG 2.58  
 Feb.Scr. 35  
 Fr. 5.0

Beckton Dominor W640 C5  
**BECKTON LARKEISA Z396 D**  
 Beckton Larkeisa M138 JC

**DAM**  
 Age 6  
 Wt 1095  
 Prog.BW 64  
 WR 92  
 YR 106  
 Wean Pct. 54%  
 Cow Eff. 113

RAAA HerdBuilder index: 192 (Top 28% of RA breed)  
 RAAA GridMaster index: 48 (Top 52% of RA breed)  
 Calv.Ease BW WW YW Milk HPG Stay Maint.En.  
 EPDs 16 -3.9 52 85 22 13 17 -6.0  
 Marb +.36 REA -.11 Bfat +.04

★★★★★ for Low Maintenance, Marbling, Calving Ease, Stayability.

**167 BSF NEBULA F782 N5** 1-B 99% # 3988266 Tat.: BSF8 F782 

Birth: 4-23-18

Beckton Nebula T398 V3  
**BECKTON NEBULA X603 J4** Ref. N-2  
 Beckton Firefly T003 JC

Beckton Nebula L P093  
 Beckton Minerva J615 VG  
 Beckton Justice C1 R483  
 Beckton Firefly R064 NW  
 Beckton New Era Y194  
 Beckton Eola W796 N  
 Beckton Hustler CN J102  
 WF Regus H107

BWt 65  
 WR 103  
 YWt. 970  
 YR 103  
 Feb.ADG 2.83  
 Feb.Scr. 35  
 Fr. 5.0

Beckton New Era A409 N2  
**BSF HUSTLE C852 N**  
 BSF Hustle P748

**DAM**  
 Age 3  
 Wt 1095  
 Prog.BW 65  
 WR 103  
 YR 103  
 Wean Pct. 46%  
 Cow Eff. 96

RAAA HerdBuilder index: 209 (Top 8% of RA breed)  
 RAAA GridMaster index: 49 (Top 29% of RA breed)  
 Calv.Ease BW WW YW Milk HPG Stay Maint.En.  
 EPDs 16 -3.3 56 93 26 14 18 -4.0  
 Marb +.30 REA -.02 Bfat +.04

★★★★★ for Low Maintenance, Marbling, Calving Ease, Stayability.

• Bulls •

**168** **BECKTON EPIC F766 A7**   
 1-A 100% # 3988280 Tat.: BSF8 F766  
 Birth: 4-21-18  
 Beckton Epic U749 D5  
**BECKTON EPIC B483 N6** Ref. E-5  
 BKT Pine Marie X339 N  
 Beckton Epic K4 N795  
 Beckton Denise R308 DM  
 Beckton Nebula T269 E2  
 BKT Pine Marie S467 JE  
 Beckton Accent Y260 L3  
 Beckton Ruth Y015 E  
 Beckton Accent Y260 L3  
 Beckton Larkabel Y487 A  
 BWT 73  
 WR 111  
 YWt. 1063  
 YR 113  
 Feb.ADG 2.94  
 Feb.Scr. NA  
 Fr. 5.0

**BECKTON LARKABEL C101 A**  
 Beckton Accent A110 E4  
 Beckton Larkabel A015 A

**DAM**  
 Age 3  
 Wt 900  
 Prog.BW 64  
 WR 107  
 YR 106  
 Wean Pct. 60%  
 Cow Eff. 127

RAAA HerdBuilder index: **185** (Top 39% of RA breed)  
 RAAA GridMaster index: **51** (Top 6% of RA breed)  
 Calv.Ease BW WW YW Milk HPG Stay Maint.En.  
 EPDs **11 -1.1 58 102 29 11 17 -1.0**  
 Marb **+0.34** REA **-1.10** Bfat **+0.04**

**171** **BSF LIKABLE F783 N5**   
 1-B 99% # 3988264 Tat.: BSF8 F783  
 Birth: 4-23-18  
 Beckton Likable X445 J3  
**BECKTON LIKABLE Z057 L4** Ref. L-1  
 Beckton Minola X107 L  
 Beckton Likable U130 L2  
 Beckton Indigo U658 JL  
 Beckton Likable U120 L2  
 Beckton Minola U188 NB  
 Beckton Nebula W778 J4  
 Beckton Lana T104 CT  
 Beckton Julian W743 H5  
 BSF Nebulann X483 J  
 BWT 61  
 WR 111  
 YWt. 993  
 YR 110  
 Feb.ADG 3.39  
 Feb.Scr. 34  
 Fr. 5.5

**BSF NEBULANN C013 N**  
 Beckton Nebula A394 C5  
 BSF Nebulann A714 J

**DAM**  
 Age 3  
 Wt 930  
 Prog.BW 60  
 WR 108  
 YR 105  
 Wean Pct. 53%  
 Cow Eff. 111

RAAA HerdBuilder index: **205** (Top 11% of RA breed)  
 RAAA GridMaster index: **51** (Top 7% of RA breed)  
 Calv.Ease BW WW YW Milk HPG Stay Maint.En.  
 EPDs **15 -3.9 58 98 25 16.5 18 -6.5**  
 Marb **+0.41** REA **-0.08** Bfat **+0.03**

★★★★★ for Low Maintenance, Growth, Marbling, Superior Cow, High Cow Efficiency, Calving Ease, Stayability.

★★★★★ for Low Maintenance, Growth, Marbling, Superior Cow, Calving Ease, Stayability.

**169** **BECKTON EPIC F718 N7**   
 1-A 100% # 3987254 Tat.: BKT8 F718  
 Birth: 4-15-18  
 Beckton Epic X464 L5  
**BECKTON EPIC B310 J6** Ref. E-4  
 Beckton Minerva Y116 J  
 Beckton Epic K6 S569  
 Beckton Lana M393 LN  
 Beckton Julian W743 H5  
 Beckton Minerva W081 N  
 Beckton Nebula U206 V3  
 Beckton Tamara U185 NB  
 Beckton Warrior T248 L5  
 Beckton Lana S074 EP  
 BWT 61  
 WR 118  
 YWt. 993  
 YR 110  
 Feb.ADG 2.94  
 Feb.Scr. 34  
 Fr. 5.0

**BECKTON LANA C464 N**  
 Beckton Nebula X096 N4  
 Beckton Lana Y541 W

**DAM**  
 Age 3  
 Wt 875  
 Prog.BW 56  
 WR 107  
 YR 106  
 Wean Pct. 60%  
 Cow Eff. 127

RAAA HerdBuilder index: **199** (Top 18% of RA breed)  
 RAAA GridMaster index: **50** (Top 20% of RA breed)  
 Calv.Ease BW WW YW Milk HPG Stay Maint.En.  
 EPDs **14 -2.5 65 107 27 14 18 -2.0**  
 Marb **+0.32** REA **-0.07** Bfat **+0.04**

★★★★★ for Low Maintenance, Growth, Marbling, Superior Cow, High Cow Efficiency, Calving Ease, Stayability.

**172** **BECKTON EPIC F761 J8**   
 1-A 100% # 3987206 Tat.: BKT8 F761  
 Birth: 4-20-18  
 Beckton Epic Y484 N6  
**BECKTON EPIC A286 E7** Ref. E-3  
 Beckton Larkaba Y648 E  
 Beckton Epic U749 D5  
 Beckton Lydia S069 NB  
 Beckton Epic U749 D5  
 Beckton Larkaba U475 CT  
 Beckton Julian 7526G  
 Bkt Marta 9A13 JL  
 Beckton Justice G302  
 Beckton Maiata C997 CB  
 BWT 66  
 WR 91  
 YWt. 966  
 YR 98  
 Feb.ADG 2.89  
 Feb.Scr. 34  
 Fr. 5.0

**BECKTON MAIATA U518 JL**  
 Beckton Julian GG B571  
 Beckton Maiata M854 JC

**DAM**  
 Age 10  
 Wt 1260  
 Prog.BW 74  
 WR 106  
 YR 105  
 Wean Pct. 41%  
 Cow Eff. 87

RAAA HerdBuilder index: **202** (Top 14% of RA breed)  
 RAAA GridMaster index: **49** (Top 34% of RA breed)  
 Calv.Ease BW WW YW Milk HPG Stay Maint.En.  
 EPDs **18 -5.1 49 81 24 13 17 -3.0**  
 Marb **+0.35** REA **-0.14** Bfat **+0.05**

★★★★★ for Low Maintenance, Marbling, Superior Cow, Calving Ease, Stayability.

**170** **BECKTON NEBULA F771 E5**   
 1-A 100% # 3988276 Tat.: BSF8 F771  
 Birth: 4-21-18  
 Beckton Nebula T398 V3  
**BECKTON NEBULA X603 J4** Ref. N-2  
 Beckton Firefly T003 JC  
 Beckton Nebula L P093  
 Beckton Minerva J615 VG  
 Beckton Justice C1 R483  
 Beckton Firefly R064 NW  
 Beckton Epic U749 D5  
 Beckton Lydia S069 NB  
 Beckton Nebula T269 E2  
 Beckton Christy S151 NB  
 BWT 75  
 WR 101  
 YWt. 931  
 YR 97  
 Feb.ADG 2.33  
 Feb.Scr. 35  
 Fr. 5.5

**BECKTON CHRISTY A163 E**  
 Beckton Epic Y484 N6  
 Beckton Christy Y364 N

**DAM**  
 Age 5  
 Wt 1090  
 Prog.BW 62  
 WR 104  
 YR 100  
 Wean Pct. 49%  
 Cow Eff. 104

RAAA HerdBuilder index: **210** (Top 7% of RA breed)  
 RAAA GridMaster index: **47** (Top 71% of RA breed)  
 Calv.Ease BW WW YW Milk HPG Stay Maint.En.  
 EPDs **16 -3.6 49 78 25 13 20 -8.0**  
 Marb **+0.29** REA **-0.06** Bfat **+0.05**

★★★★★ for Low Maintenance, Marbling, Calving Ease, Stayability.

**173** **BECKTON SCAMP F712 N5**   
 1-A 100% # 3987260 Tat.: BKT8 F712  
 Birth: 4-14-18  
 Beckton Scamp X458 H3  
**BECKTON SCAMP B720 L4** Ref. S-1  
 Beckton Larkaba Y448 L  
 Beckton Scamp T A825  
 BKT Pine Marie R401 HU  
 Beckton Likable U130 L2  
 Beckton Larkaba T655 NB  
 Beckton Nebula L P093  
 Beckton Minerva J615 VG  
 Beckton Epic K3 M606  
 Beckton Belga K285 JL  
 BWT 54  
 WR 81  
 YWt. 957  
 YR 100  
 Feb.ADG 3.39  
 Feb.Scr. 36  
 Fr. 5.0

**BECKTON BELGA W103 N**  
 Beckton Nebula T398 V3  
 Beckton Belga T551 EP

**DAM**  
 Age 9  
 Wt 1035  
 Prog.BW 63  
 WR 98  
 YR 102  
 Wean Pct. 42%  
 Cow Eff. 88

RAAA HerdBuilder index: **206** (Top 10% of RA breed)  
 RAAA GridMaster index: **50** (Top 16% of RA breed)  
 Calv.Ease BW WW YW Milk HPG Stay Maint.En.  
 EPDs **20 -6.6 44 82 27 14 16 -10.0**  
 Marb **+0.28** REA **-0.06** Bfat **+0.03**

★★★★★ for Low Maintenance, Marbling, Calving Ease, Stayability.

• Bulls •

**174 BECKTON ACCENT F690 E4**  
1-A 100% # 3988350 Tat.: BSF8 F690



Birth: 4-11-18

Beckton Cody K1 P014  
Beckton Rose M126 WR  
Beckton Cherokee N N479  
Beckton Christy N740 HR  
Beckton Epic D404  
Beckton Belga D483 KR  
Bkt Milebar BX 9822  
Bkt Larkabel 8697 RR

**BECKTON ACCENT W180 C2**  
Ref. A-1  
Beckton Christy R046 CQ

**BKT LARKABEL K768 EP**  
Beckton Epic K F075  
Bkt Larkabel E645 MB

BWt	64
WR	83
YWt.	930
YR	95
Feb.ADG	2.94
Feb.Scr.	33
Fr.	5.0

**DAM**  
Age 18  
Wt 1000  
Prog.BW 69  
WR 102  
YR 103  
Wean Pct. 45%  
Cow Eff. 96

RAAA HerdBuilder index: **216** (Top 4% of RA breed)  
RAAA GridMaster index: **45** (Top 96% of RA breed)

Calv.Ease	BW	WW	YW	Milk	HPG	Stay	Maint.En.	
EPDs	17	-5.1	39	65	30	14	21	-2.0

Marb **+0.23** REA **-1.13** Bfat **+0.03**

★★★★★ for Low Maintenance, Marbling, Calving Ease, Stayability.

**177 BECKTON ACCENT F652 N5**  
1-A 100% # 3988386 Tat.: BSF8 F652



Birth: 4-7-18

Beckton Accent Y260 L3  
Beckton Lana W463 L  
Beckton Nebula P F707  
Beckton Larkeisa P688 CH  
Beckton Nebula M045  
Beckton Ruth M967 EP  
Beckton Lancer T A664  
Bkt Barmaid 9517 RN

**BECKTON ACCENT B150 N4**  
Ref. A-2  
BKT Larkeisa S055 NB

**BECKTON BARMAID X231 N**  
Beckton Nebula T269 E2  
Beckton Barmaid G565 LN

BWt	58
WR	84
YWt.	899
YR	94
Feb.ADG	2.83
Feb.Scr.	35
Fr.	5.0

**DAM**  
Age 8  
Wt 1060  
Prog.BW 65  
WR 102  
YR 98  
Wean Pct. 42%  
Cow Eff. 89

RAAA HerdBuilder index: **195** (Top 22% of RA breed)  
RAAA GridMaster index: **46** (Top 94% of RA breed)

Calv.Ease	BW	WW	YW	Milk	HPG	Stay	Maint.En.	
EPDs	19	-6.6	36	55	29	11	18	-7.0

Marb **+0.48** REA **-0.35** Bfat **+0.04**

★★★★★ for Low Maintenance, Marbling, Calving Ease, Stayability.

**175 BECKTON ACCENT F793 S5**  
1-A 100% # 3987174 Tat.: BKT8 F793



Birth: 4-25-18

Beckton Accent Y260 L3  
Beckton Lana W463 L  
Beckton Nebula P F707  
Beckton Larkeisa P688 CH  
Beckton Scamp T A825  
Beckton Lana S074 EP  
Beckton Julian U699 L5  
Beckton Tamara S432 DM

**BECKTON ACCENT B150 N4**  
Ref. A-2  
BKT Larkeisa S055 NB

**BECKTON TAMARA B253 S**  
Beckton Scamp X494 E3  
Beckton Tamara X587 J

BWt	76
WR	107
YWt.	928
YR	97
Feb.ADG	2.28
Feb.Scr.	34
Fr.	5.5

**DAM**  
Age 4  
Wt 1035  
Prog.BW 68  
WR 106  
YR 101  
Wean Pct. 53%  
Cow Eff. 113

RAAA HerdBuilder index: **183** (Top 44% of RA breed)  
RAAA GridMaster index: **46** (Top 86% of RA breed)

Calv.Ease	BW	WW	YW	Milk	HPG	Stay	Maint.En.	
EPDs	15	-3.0	51	72	26	14	17	-7.0

Marb **+0.44** REA **-0.27** Bfat **+0.04**

★★★★★ for Low Maintenance, Marbling, Calving Ease, Stayability.

**178 BECKTON SCAMP F685 A5**  
1-A 100% # 3987288 Tat.: BKT8 F685



Birth: 4-11-18

Beckton Scamp X458 H3  
Beckton Scamp T A825  
BKT Pine Marie R401 HU  
BKT Clifftop TP R288  
Beckton Lydia W178 C  
Beckton Lydia N047 LM  
Beckton Accent U777 C2  
BKT Larkeisa S055 NB  
Beckton Warrior T248 L5  
Beckton Serena N088 WR

**BECKTON SCAMP C349 C4**  
Ref. S-2

**BECKTON SERENA B275 A**  
Beckton Accent Y312 N3  
Beckton Serena X287 W

BWt	62
WR	100
YWt.	973
YR	102
Feb.ADG	2.67
Feb.Scr.	32
Fr.	5.0

**DAM**  
Age 4  
Wt 850  
Prog.BW 63  
WR 97  
YR 95  
Wean Pct. 61%  
Cow Eff. 128

RAAA HerdBuilder index: **183** (Top 43% of RA breed)  
RAAA GridMaster index: **47** (Top 70% of RA breed)

Calv.Ease	BW	WW	YW	Milk	HPG	Stay	Maint.En.	
EPDs	18	-5.5	50	79	24	14	15	-6.0

Marb **+0.33** REA **-0.21** Bfat **+0.03**

★★★★★ for Low Maintenance, Marbling, High Cow Efficiency, Calving Ease, Stayability.

**176 BSF DOMINOR F627 E9**  
1-B 99% # 3988410 Tat.: BSF8 F627



Birth: 4-5-18

Beckton Dominor A378 W7  
Beckton Lana Y541 W  
Beckton Epic T330 L5  
Beckton Scarlett W497 J  
Beckton Epic K4 N795  
Beckton Denise R308 DM  
Beckton Cody K1 P014  
BSF Juleste R644 JE

**BECKTON DOMINOR C052 E8**  
Ref. D-2  
Beckton Scarlett A406 E

**BSF JULESTE Z478 E**  
Beckton Epic U749 D5  
BSF Juleste U662 CD

BWt	74
WR	91
YWt.	993
YR	104
Feb.ADG	3.28
Feb.Scr.	32
Fr.	5.0

**DAM**  
Age 6  
Wt 1170  
Prog.BW 68  
WR 101  
YR 102  
Wean Pct. 42%  
Cow Eff. 88

RAAA HerdBuilder index: **175** (Top 58% of RA breed)  
RAAA GridMaster index: **51** (Top 8% of RA breed)

Calv.Ease	BW	WW	YW	Milk	HPG	Stay	Maint.En.	
EPDs	16	-3.0	49	91	28	11	14	-3.0

Marb **+0.37** REA **-0.04** Bfat **+0.04**

★★★★★ for Low Maintenance, Marbling, Calving Ease, Stayability.

**179 BECKTON ACCENT F739 A4**  
1-A 100% # 3988300 Tat.: BSF8 F739



Birth: 4-17-18

Beckton Accent W180 C2  
Beckton Cody K1 P014  
Beckton Christy R046 CQ  
Beckton Nebula T398 V3  
Beckton Minerva M369 LO  
Beckton Accent W180 C2  
Beckton Susan P857 JO  
Beckton Clifftop W692 E3  
Beckton Christy S151 NB

**BECKTON ACCENT B549 N3**  
Ref. A-3  
Beckton Minerva Y654 N

**BECKTON CHRISTY B147 A**  
Beckton Accent Z506 J3  
Beckton Christy Z533 C

BWt	81
WR	130
YWt.	982
YR	99
Feb.ADG	0.94
Feb.Scr.	35
Fr.	5.5

**DAM**  
Age 4  
Wt 1115  
Prog.BW 78  
WR 125  
YR 110  
Wean Pct. 61%  
Cow Eff. 127

RAAA HerdBuilder index: **217** (Top 4% of RA breed)  
RAAA GridMaster index: **49** (Top 41% of RA breed)

Calv.Ease	BW	WW	YW	Milk	HPG	Stay	Maint.En.	
EPDs	12	-0.7	64	99	29	12	22	-2.0

Marb **+0.32** REA **+0.07** Bfat **+0.04**

★★★★★ for Low Maintenance, Marbling, Superior Cow, High Cow Efficiency, Calving Ease, Stayability.



• Bulls •



Lot 180

**182 BECKTON LIKABLE F658 D6**  
1-A 100% # 3987318 Tat.: BKT8 F658



Birth: 4-8-18

Beckton Likable Z057 L4  
Beckton Minola X107 L

**BECKTON LIKABLE B032 C5**  
Ref. L-2  
Beckton Mona Z270 C

Beckton Dominor Y052 N6  
Beckton Indigo W772 N

**BECKTON FIREFLY A402 D**  
Beckton Firefly Y376 N  
Beckton Nebula T398 V3  
Beckton Firefly T028 JR

BWt	81
WR	104
YWt.	938
YR	91
Feb.ADG	2.00
Feb.Scr.	37
Fr.	5.5

RAAA HerdBuilder index: **217** (Top 4% of RA breed)  
RAAA GridMaster index: **50** (Top 26% of RA breed)

Calv.Ease	BW	WW	YW	Milk	HPG	Stay	Maint.En.	
EPDs	13	-3.1	53	90	25	14	21	-5.0

Marb **+0.41** REA **-0.12** Bfat **+0.05**

★★★★★ for Low Maintenance, Marbling, High Cow Efficiency, Calving Ease, Stayability.

**180 BECKTON SCAMP F346 L5**  
1-A 100% # 3987698 Tat.: BKT8 F346



Birth: 3-19-18

Beckton Scamp X458 H3  
Beckton Pine Marie R401 HU

**BECKTON SCAMP B720 L4**  
Ref. S-1  
Beckton Larkaba Y448 L

Beckton Larkaba T655 NB  
Beckton Lancer F442 T

Beckton Legend S670  
Beckton Kit F468 JL

**BECKTON ROSE X802 L**  
Beckton Rose R353 LN  
Beckton Lancer T7 M089  
Beckton Rose L083 LN

BWt	72
WR	97
YWt.	925
YR	90
Feb.ADG	2.28
Feb.Scr.	34
Fr.	5.5

RAAA HerdBuilder index: **189** (Top 32% of RA breed)  
RAAA GridMaster index: **49** (Top 29% of RA breed)

Calv.Ease	BW	WW	YW	Milk	HPG	Stay	Maint.En.	
EPDs	17	-4.3	49	77	23	13	16	-8.0

Marb **+0.30** REA **+0.03** Bfat **+0.01**

★★★★★ for Low Maintenance, Marbling, Calving Ease, Stayability.

**183 BECKTON HERITAGE F656 W5**  
1-A 100% # 3988380 Tat.: BSF8 F656



Birth: 4-8-18

Beckton Heritage X403 L3  
Beckton Heritage T270 J2

**BECKTON HERITAGE B612 J4**  
Ref. H-1  
Beckton Lana N291 JC

Beckton Justice G302  
Beckton Lana H725 CH

Beckton Warrior T248 L5  
Beckton Warrior N645 T1

**BECKTON ENCINO X642 W**  
Beckton Kit R503 LN  
Beckton Jet L P491  
Beckton Encino P300 LN

BWt	61
WR	105
YWt.	949
YR	93
Feb.ADG	2.06
Feb.Scr.	37
Fr.	5.0

RAAA HerdBuilder index: **192** (Top 28% of RA breed)  
RAAA GridMaster index: **46** (Top 89% of RA breed)

Calv.Ease	BW	WW	YW	Milk	HPG	Stay	Maint.En.	
EPDs	16	-4.9	55	76	19	14	18	-7.0

Marb **+0.36** REA **-0.13** Bfat **+0.04**

★★★★★ for Low Maintenance, Marbling, Calving Ease, Stayability.

**181 BECKTON JAVELIN F290 C2**  
1-A 100% # 3987762 Tat.: BKT8 F290



Birth: 3-17-18

Beckton Javelin 6587  
Beckton Trojan 5253

**BKT JAVELIN 7466 R**  
Ref. J-1  
Beckton Rose 6807 RZ

Beckton Ileximka -3  
Beckton Raza 2308-N

Beckton Cody K1 P014  
Beckton Cody KH M390

**BECKTON LANA U612 CD**  
Beckton Lana R327 EP  
Beckton Rose M126 WR  
Beckton Epic KM M115  
Beckton Lana K840 LN

BWt	67
WR	99
YWt.	949
YR	93
Feb.ADG	2.33
Feb.Scr.	36
Fr.	5.5

RAAA HerdBuilder index: **183** (Top 43% of RA breed)  
RAAA GridMaster index: **45** (Top 96% of RA breed)

Calv.Ease	BW	WW	YW	Milk	HPG	Stay	Maint.En.	
EPDs	18	-5.3	36	54	28	10	17	-8.0

Marb **+0.22** REA **-0.34** Bfat **+0.02**

★★★★★ for Low Maintenance, Marbling, Superior Cow, Calving Ease, Stayability.



Lot 181

• Bulls •

## 184 BECKTON LIKABLE F606 N5

1-A 100% # 3987372 Tat.: BKT8 F606 

Birth: 4-2-18

Beckton Likable U130 L2  
Beckton Indigo U658 JL  
Beckton Likable U120 L2  
Beckton Minola U188 NB  
Beckton Nebula M045  
Beckton Ruth M967 EP  
TR Julian RT561  
Beckton Coca R490 JC

Beckton Likable X445 J3  
Beckton Minola X107 L

**BECKTON LIKABLE Z057 L4**  
Ref. L-1

Beckton Nebula T269 E2  
Beckton Coca U187 JD

**BECKTON COCA Y114 N**

DAM	
Age	7
Wt	1085
Prog.BW	63
WR	101
YR	99
Wean Pct.	54%
Cow Eff.	114

BWt	64
WR	103
YWt.	923
YR	90
Feb.ADG	1.67
Feb.Scr.	35
Fr.	5.5

RAAA HerdBuilder index:	196	(Top 22% of RA breed)						
RAAA GridMaster index:	49	(Top 42% of RA breed)						
Calv.Ease	BW	WW	YW	Milk	HPG	Stay	Maint.En.	
EPDs	17	-5.7	49	79	26	13	17	-12.0
Marb	+.39		REA	-.10		Bfat	+.03	

## 187 BECKTON SCAMP F814 N5

1-A 100% # Tat.: BKT8 F814 

Birth: 4-28-18

Beckton Scamp X458 H3  
BKT Pine Marie R401 HU  
BKT Clifftop TP R288  
Beckton Lydia N047 LM  
Beckton Nebula U206 V3  
Beckton Tamara U185 NB  
Beckton Neptune R2 K065  
Bkt Larkeisa G448 CT

Beckton Scamp T A825

**BECKTON SCAMP C349 C4**  
Ref. S-2

Beckton Lydia W178 C

Beckton Nebula X096 N4  
Beckton Larkeisa P136 NP

**BECKTON LARKEISA B168 N**

DAM	
Age	4
Wt	1340
Prog.BW	73
WR	105
YR	108
Wean Pct.	34%
Cow Eff.	71

BWt	65
WR	83
YWt.	981
YR	100
Feb.ADG	3.28
Feb.Scr.	33
Fr.	5.0

RAAA HerdBuilder index:		(Top 47% of RA breed)						
RAAA GridMaster index:		(Top 47% of RA breed)						
Calv.Ease	BW	WW	YW	Milk	HPG	Stay	Maint.En.	
EPDs	12	-0.8	56.5	90.5	25.5	13	14	-1.7
Marb	+.37		REA	-.10		Bfat	+.01	

★★★★★ for Low Maintenance, Marbling, Calving Ease, Stayability.

★★★★★ for Low Maintenance, Marbling, Superior Cow, Calving Ease, Stayability.

## 185 BECKTON EPIC F452 L7

1-A 100% # 3987562 Tat.: BKT8 F452 

Birth: 3-23-18

Beckton Epic X464 L5  
Beckton Epic K6 S569  
Beckton Lana M393 LN  
Beckton Julian W743 H5  
Beckton Minerva W081 N  
Beckton Likable U120 L2  
Beckton Firefly T331 EP  
Beckton Nebula U206 V3  
Beckton Christy S475 EP

Beckton Epic B310 J6  
Ref. E-4

Beckton Minerva Y116 J

Beckton Likable Y675 E3  
Beckton Christy Y413 N

**BECKTON CHRISTY A231 L**

DAM	
Age	5
Wt	970
Prog.BW	60
WR	98
YR	95
Wean Pct.	59%
Cow Eff.	123

BWt	67
WR	100
YWt.	856
YR	84
Feb.ADG	1.39
Feb.Scr.	33
Fr.	5.0

RAAA HerdBuilder index:	190	(Top 31% of RA breed)						
RAAA GridMaster index:	45	(Top 98% of RA breed)						
Calv.Ease	BW	WW	YW	Milk	HPG	Stay	Maint.En.	
EPDs	16	-3.9	50	72	27	13	19	-1.0
Marb	+.27		REA	-.06		Bfat	+.03	

★★★★★ for Low Maintenance, Marbling, High Cow Efficiency, Calving Ease, Stayability.

## 188 BECKTON LIKABLE F727 L5

1-A 100% # 3987244 Tat.: BKT8 F727 

Birth: 4-15-18

Beckton Likable X445 J3  
Beckton Likable U130 L2  
Beckton Indigo U658 JL  
Beckton Likable U120 L2  
Beckton Minola U188 NB  
Beckton Loki CL S284  
Beckton Lana L538 LN  
Beckton Vega P079  
Beckton Lana P317 JL

Beckton Likable U130 L2

**BECKTON LIKABLE Z057 L4**  
Ref. L-1

Beckton Minola X107 L

Beckton Loki X507 L4  
Beckton Lana U297 VA

**BECKTON LANA B485 L**

DAM	
Age	4
Wt	1020
Prog.BW	59
WR	98
YR	98
Wean Pct.	50%
Cow Eff.	105

BWt	59
WR	99
YWt.	966
YR	101
Feb.ADG	2.83
Feb.Scr.	34
Fr.	4.5

RAAA HerdBuilder index:	197	(Top 20% of RA breed)						
RAAA GridMaster index:	50	(Top 16% of RA breed)						
Calv.Ease	BW	WW	YW	Milk	HPG	Stay	Maint.En.	
EPDs	18	-6.2	46	82	26	12	17	-7.0
Marb	+.41		REA	+.00		Bfat	+.03	

★★★★★ for Low Maintenance, Marbling, Calving Ease, Stayability.

## 186 BECKTON EPIC F788 J8

1-A 100% # 3987178 Tat.: BKT8 F788 

Birth: 4-24-18

Beckton Epic Y484 N6  
Beckton Epic U749 D5  
Beckton Lydia S069 NB  
Beckton Epic U749 D5  
Beckton Larkaba U475 CT  
Beckton Julian G5 S107  
Beckton Suffeina P643 JL  
Beckton Heritage T270 J2  
Beckton Scarlett R808 NB

Beckton Epic A286 E7  
Ref. E-3

Beckton Larkaba Y648 E

Beckton Julian X465 J5  
Beckton Scarlett X414 H

**BECKTON SCARLETT Z076 J**

DAM	
Age	6
Wt	1040
Prog.BW	77
WR	107
YR	98
Wean Pct.	63%
Cow Eff.	132

BWt	81
WR	115
YWt.	987
YR	96
Feb.ADG	1.94
Feb.Scr.	34
Fr.	5.5

RAAA HerdBuilder index:	175	(Top 59% of RA breed)						
RAAA GridMaster index:	48	(Top 66% of RA breed)						
Calv.Ease	BW	WW	YW	Milk	HPG	Stay	Maint.En.	
EPDs	15	-3.3	51	81	25	14	16	-6.0
Marb	+.38		REA	-.23		Bfat	+.05	

★★★★★ for Low Maintenance, Marbling, High Cow Efficiency, Calving Ease, Stayability.

## 189 BECKTON ACCENT F703 C4

1-A 100% # 3988338 Tat.: BSF8 F703 

Birth: 4-13-18

Beckton Accent W180 C2  
Beckton Cody K1 P014  
Beckton Christy R046 CQ  
Beckton Nebula T398 V3  
Beckton Minerva M369 LO  
Beckton Clifftop W692 E3  
Beckton Lana W240 C  
Beckton Accent W180 C2  
Beckton Larkabel W557 L

Beckton Accent B549 N3  
Ref. A-3

Beckton Minerva Y654 N

Beckton Clifftop Y012 C4  
Beckton Larkabel Y487 A

**BECKTON LARKABEL C736 C**

DAM	
Age	3
Wt	785
Prog.BW	63
WR	102
YR	102
Wean Pct.	59%
Cow Eff.	124

BWt	67
WR	96
YWt.	942
YR	100
Feb.ADG	2.56
Feb.Scr.	NA
Fr.	5.0

RAAA HerdBuilder index:	230	(Top 1% of RA breed)						
RAAA GridMaster index:	50	(Top 23% of RA breed)						
Calv.Ease	BW	WW	YW	Milk	HPG	Stay	Maint.En.	
EPDs	16	-2.8	54	92	28	12	21	-3.0
Marb	+.30		REA	+.07		Bfat	+.04	

★★★★★ for Low Maintenance, Marbling, High Cow Efficiency, Calving Ease, Stayability.

• Bulls •

**190 BECKTON NEW ERA F639 N3**  
1-A 100% # 3987340 Tat.: BKT8 F639 

Birth: 4-6-18

Beckton New Era Y194  
**BECKTON NEW ERA D478 C2**  
Ref. N

Beckton New Era Y194  
**BECKTON INDIGO D431 N**  
Beckton Indigo Z666 N

Beckton Nebula P P707  
BKT Larkeisa T310 JC  
Beckton Cherokee T450 L3  
Beckton Coca T080 NB  
Beckton Nebula P P707  
BKT Larkeisa T310 JC  
Beckton Nebula W130 D3  
Beckton Indigo S262 JC

BWt 74  
WR 98  
YWt. 958  
YR 109  
Feb.ADG 3.00  
Feb.Scr. 32  
Fr. 5.5

**DAM**  
Age 2  
Wt 925  
Prog.BW 74  
WR 99  
YR 109  
Wean Pct. 45%  
Cow Eff. 95

RAAA HerdBuilder index: **197** (Top 20% of RA breed)  
RAAA GridMaster index: **50** (Top 16% of RA breed)  
Calv.Ease BW WW YW Milk HPG Stay Maint.En.  
EPDs **14 -0.7 62 105 25 12 18 -3.0**  
Marb **+0.38** REA **-1.19** Bfat **+0.04**

**193 BECKTON EPIC F636 E7**  
1-A 100% # 3987344 Tat.: BKT8 F636 

Birth: 4-6-18

Beckton Epic U749 D5  
**BECKTON EPIC B483 N6**  
Ref. E-5

Beckton Epic U749 D5  
**BECKTON INDIGO C261 E**  
Beckton Indigo U504 EP

Beckton Epic K4 N795  
Beckton Denise R308 DM  
Beckton Nebula T269 E2  
BKT Pine Marie S467 JE  
Beckton Epic U749 D5  
Beckton Lydia S069 NB  
Beckton Epic K6 S569  
Beckton Indigo S016 NB

BWt 58  
WR 87  
YWt. 927  
YR 99  
Feb.ADG 2.89  
Feb.Scr. 31  
Fr. 5.0

**DAM**  
Age 3  
Wt 900  
Prog.BW 59  
WR 89  
YR 99  
Wean Pct. 46%  
Cow Eff. 98

RAAA HerdBuilder index: **182** (Top 44% of RA breed)  
RAAA GridMaster index: **50** (Top 14% of RA breed)  
Calv.Ease BW WW YW Milk HPG Stay Maint.En.  
EPDs **11 -2.1 53 97 27 11 17 -4.0**  
Marb **+0.37** REA **-1.13** Bfat **+0.05**

★★★★★ for Low Maintenance, Growth, Marbling, Calving Ease, Stayability.

★★★★★ for Low Maintenance, Marbling, Calving Ease, Stayability.

**191 BECKTON EPIC F698 E8**  
1-A 100% # 3987278 Tat.: BKT8 F698 

Birth: 4-12-18

Beckton Epic Y484 N6  
**BECKTON EPIC D454 L7**  
Ref. E-10

Beckton Epic Y484 N6  
**BECKTON INDIGO D740 E**  
Beckton Indigo A745 J

Beckton Epic U749 D5  
Beckton Lydia S069 NB  
Beckton Lancer F442 T  
Beckton Rose F306 JL  
Beckton Epic U749 D5  
Beckton Lydia S069 NB  
Beckton Julian X465 J5  
Beckton Indigo W477 E

BWt 76  
WR 99  
YWt. 923  
YR 105  
Feb.ADG 3.06  
Feb.Scr. 33  
Fr. 5.5

**DAM**  
Age 2  
Wt 790  
Prog.BW 76  
WR 99  
YR 105  
Wean Pct. 53%  
Cow Eff. 112

RAAA HerdBuilder index: **173** (Top 62% of RA breed)  
RAAA GridMaster index: **52** (Top 5% of RA breed)  
Calv.Ease BW WW YW Milk HPG Stay Maint.En.  
EPDs **10 0.8 65 110 21 12 16 -1.0**  
Marb **+0.26** REA **+0.11** Bfat **+0.03**

★★★★★ for Low Maintenance, Marbling, Calving Ease, Stayability.

**194 BSF EPIC F618 N7**  
1-B 99% # 3988416 Tat.: BSF8 F618 

Birth: 4-4-18

Beckton Epic X464 L5  
**BECKTON EPIC B310 J6**  
Ref. E-4

Beckton Epic X464 L5  
**BSF HUSTELLE C558 N**  
BSF Hustelle Z850 S

Beckton Epic K6 S569  
Beckton Lana M393 LN  
Beckton Julian W743 H5  
Beckton Minerva W081 N  
Beckton Nebula PJ S543  
Beckton Lana S197 JT  
Beckton Scamp X494 E3  
BSF Hustelle X343 J

BWt 61  
WR 95  
YWt. 937  
YR 104  
Feb.ADG 3.44  
Feb.Scr. 30  
Fr. 5.0

**DAM**  
Age 3  
Wt 960  
Prog.BW 55  
WR 96  
YR 101  
Wean Pct. 43%  
Cow Eff. 91

RAAA HerdBuilder index: **187** (Top 35% of RA breed)  
RAAA GridMaster index: **48** (Top 54% of RA breed)  
Calv.Ease BW WW YW Milk HPG Stay Maint.En.  
EPDs **16 -3.4 56 90 25 16 16 -2.0**  
Marb **+0.31** REA **-1.17** Bfat **+0.04**

★★★★★ for Low Maintenance, Marbling, Calving Ease, Stayability.

**192 BECKTON SCAMP F740 W5**  
1-A 100% # 3987234 Tat.: BKT8 F740 

Birth: 4-17-18

Beckton Scamp X458 H3  
**BECKTON SCAMP C349 C4**  
Ref. S-2

Beckton Warrior W534 N4  
**BECKTON BELGA A812 W**  
Beckton Belga U057 EP

Beckton Scamp T A825  
BKT Pine Marie R401 HU  
BKT Clifftop TP R288  
Beckton Lydia N047 LM  
Beckton Warrior C1 S337  
BKT Larkeisa S055 NB  
Beckton Epic K6 S569  
Beckton Belga S198 JL

BWt 60  
WR 88  
YWt. 894  
YR 93  
Feb.ADG 2.89  
Feb.Scr. 33  
Fr. 4.5

**DAM**  
Age 5  
Wt 970  
Prog.BW 61  
WR 95  
YR 96  
Wean Pct. 49%  
Cow Eff. 103

RAAA HerdBuilder index: **174** (Top 61% of RA breed)  
RAAA GridMaster index: **47** (Top 81% of RA breed)  
Calv.Ease BW WW YW Milk HPG Stay Maint.En.  
EPDs **18 -5.2 44 70 26 13 15 -4.0**  
Marb **+0.31** REA **-1.18** Bfat **+0.03**

★★★★★ for Low Maintenance, Marbling, Calving Ease, Stayability.

**195 BSF SCAMP F645 S5**  
1-B 99% # 3988392 Tat.: BSF8 F645 

Birth: 4-7-18

Beckton Scamp X458 H3  
**BECKTON SCAMP C349 C4**  
Ref. S-2

Beckton Scamp X458 H3  
**BSF LANETTE C484 S**  
BSF Lanette X568 W

Beckton Scamp T A825  
BKT Pine Marie R401 HU  
BKT Clifftop TP R288  
Beckton Lydia N047 LM  
Beckton Scamp T A825  
BKT Pine Marie R401 HU  
Beckton Warrior T248 L5  
BSF Lanette P615

BWt 47  
WR 96  
YWt. 964  
YR 107  
Feb.ADG 3.67  
Feb.Scr. 32  
Fr. 5.5

**DAM**  
Age 3  
Wt 970  
Prog.BW 47  
WR 111  
YR 113  
Wean Pct. 43%  
Cow Eff. 91

RAAA HerdBuilder index: **165** (Top 74% of RA breed)  
RAAA GridMaster index: **49** (Top 41% of RA breed)  
Calv.Ease BW WW YW Milk HPG Stay Maint.En.  
EPDs **19 -5.9 49 86 29 15 12 -4.0**  
Marb **+0.22** REA **-1.11** Bfat **+0.02**

★★★★★ for Low Maintenance, Growth, Marbling, Superior Cow, Calving Ease.



• Bulls •

**196 BECKTON LIKABLE F540 E4**  
1-A 100% # 3987458 Tat.: BKT8 F540 

Birth: 3-28-18

Beckton Likable U130 L2  
**BECKTON LIKABLE B509 J3**  
Ref. L-3  
Beckton Coca T363 JL

Beckton Epic K4 N795  
**BECKTON ROSE W655 E**  
Beckton Rose M126 WR

Beckton Likable S633  
Beckton Kit S478 LN  
Beckton Julian G2 M345  
Beckton Coca P435 CH  
Beckton Epic KJ J722  
Beckton Sierra J789 EP  
Beckton Warrior T C371  
Beckton Rose D741 LN

BWt 80  
WR 94  
YWt. 1001  
YR 101  
Feb.ADG 3.15  
Feb.Scr. 34  
Fr. 5.5

**DAM**  
Age 9  
Wt 1290  
Prog.BW 76  
WR 106  
YR 104  
Wean Pct. 39%  
Cow Eff. 82

RAAA HerdBuilder index: **184** (Top 42% of RA breed)  
RAAA GridMaster index: **51** (Top 11% of RA breed)  
Calv.Ease BW WW YW Milk HPG Stay Maint.En.  
EPDs **12 -0.3 58 99 24 11 17 -2.0**  
Marb **+0.29** REA **-0.04** Bfat **+0.03**

**199 BECKTON RANGER F582 N6**  
1-A 100% # 3987402 Tat.: BKT8 F582 

Birth: 4-1-18

Beckton Ranger Z225 J4  
**BECKTON RANGER B006 D5**  
Ref. R-1  
Beckton Suffeina Z731 D

Beckton New Era Y194  
**BECKTON COCA C564 N**  
Beckton Coca T363 JL

Beckton Ranger T603 H3  
Beckton Mona U564 JT  
Beckton Dominor W640 C5  
Beckton Suffeina W471 W  
Beckton Nebula P P707  
BKT Larkeisa T310 JC  
Beckton Julian G2 M345  
Beckton Coca P435 CH

BWt 76  
WR 105  
YWt. 987  
YR 100  
Feb.ADG 2.75  
Feb.Scr. 34  
Fr. 5.5

**DAM**  
Age 3  
Wt 1040  
Prog.BW 75  
WR 105  
YR 100  
Wean Pct. 49%  
Cow Eff. 104

RAAA HerdBuilder index: **168** (Top 70% of RA breed)  
RAAA GridMaster index: **49** (Top 41% of RA breed)  
Calv.Ease BW WW YW Milk HPG Stay Maint.En.  
EPDs **13 -0.1 60 94 24 14 15 -6.0**  
Marb **+0.39** REA **-0.05** Bfat **+0.03**

★★★★★ for Low Maintenance, Marbling, Superior Cow, Calving Ease, Stayability.

★★★★★ for Low Maintenance, Marbling, Calving Ease, Stayability.

**197 BECKTON SCAMP F664 L5**  
1-A 100% # 3987310 Tat.: BKT8 F664 

Birth: 4-9-18

Beckton Scamp X458 H3  
**BECKTON SCAMP C349 C4**  
Ref. S-2  
Beckton Lydia W178 C

Beckton Legend U331 E2  
**BECKTON LANA B698 L**  
Beckton Lana Y106 E

Beckton Scamp T A825  
BKT Pine Marie R401 HU  
BKT Clifftop TP R288  
Beckton Lydia N047 LM  
Beckton Legend S670  
Beckton Lana S669 EP  
Beckton Emcee W526 J2  
Beckton Lana W338 N

BWt 62  
WR 108  
YWt. 943  
YR 95  
Feb.ADG 1.69  
Feb.Scr. 36  
Fr. 5.5

**DAM**  
Age 4  
Wt 890  
Prog.BW 58  
WR 96  
YR 93  
Wean Pct. 63%  
Cow Eff. 133

RAAA HerdBuilder index: **188** (Top 34% of RA breed)  
RAAA GridMaster index: **48** (Top 65% of RA breed)  
Calv.Ease BW WW YW Milk HPG Stay Maint.En.  
EPDs **19 -6.5 47 72 25 13 16 -4.0**  
Marb **+0.34** REA **-0.14** Bfat **+0.03**

★★★★★ for Low Maintenance, Marbling, High Cow Efficiency, Calving Ease, Stayability.

**200 BECKTON RANGER F370 W6**  
1-A 100% # 3987664 Tat.: BKT8 F370 

Birth: 3-20-18

Beckton Ranger Z225 J4  
**BECKTON RANGER B006 D5**  
Ref. R-1  
Beckton Suffeina Z731 D

Beckton Warhawk N560  
**BECKTON LARKABA R011 WA**  
Beckton Larkaba N394 HR

Beckton Ranger T603 H3  
Beckton Mona U564 JT  
Beckton Dominor W640 C5  
Beckton Suffeina W471 W  
Beckton Warrior T1 H281  
Beckton Firefly H195 HD  
Beckton Herald FJ J776  
Beckton Larkaba F136 LN

BWt 63  
WR 96  
YWt. 893  
YR 87  
Feb.ADG 2.08  
Feb.Scr. 33  
Fr. 5.5

**DAM**  
Age 13  
Wt 1160  
Prog.BW 65  
WR 102  
YR 102  
Wean Pct. 46%  
Cow Eff. 96

RAAA HerdBuilder index: **168** (Top 69% of RA breed)  
RAAA GridMaster index: **46** (Top 93% of RA breed)  
Calv.Ease BW WW YW Milk HPG Stay Maint.En.  
EPDs **20 -4.9 44 69 25 17 13 -3.0**  
Marb **+0.28** REA **-0.16** Bfat **+0.04**

★★★★★ for Low Maintenance, Marbling, Calving Ease, Stayability.

**198 BECKTON EPIC F799 S7**  
1-A 100% # 3987166 Tat.: BKT8 F799 

Birth: 4-26-18

Beckton Epic U749 D5  
**BECKTON EPIC Y484 N6**  
Ref. E-1  
Beckton Lydia S069 NB

Beckton Scamp A626 H3  
**BECKTON SUSAN C047 S**  
Beckton Susan A112 S

Beckton Epic K4 N795  
Beckton Denise R308 DM  
Beckton Nebula P P707  
Beckton Lydia P583 WR  
Beckton Scamp T A825  
Beckton Rose T770 HI  
Beckton Scamp X494 E3  
Beckton Susan T199 CT

BWt 70  
WR 116  
YWt. 1067  
YR 109  
Feb.ADG 2.87  
Feb.Scr. 33  
Fr. 5.5

**DAM**  
Age 3  
Wt 920  
Prog.BW 63  
WR 109  
YR 108  
Wean Pct. 62%  
Cow Eff. 131

RAAA HerdBuilder index: **166** (Top 73% of RA breed)  
RAAA GridMaster index: **49** (Top 29% of RA breed)  
Calv.Ease BW WW YW Milk HPG Stay Maint.En.  
EPDs **14 -1.7 58 98 24 10 15 -4.0**  
Marb **+0.23** REA **-0.06** Bfat **+0.03**

★★★★★ for Low Maintenance, Growth, Marbling, Superior Cow, High Cow Efficiency, Calving Ease, Stayability.

**201 BECKTON DOMINOR F276 L9**  
1-A 100% # 3988658 Tat.: BSF8 F276 

Birth: 3-16-18

Beckton Dominor A378 W7  
**BECKTON DOMINOR D254 N8**  
Ref. D-3  
Beckton Indigo W772 N

Beckton Legend S670  
**BECKTON LANA C351 L**  
Beckton Lana X556 L

Beckton Dominor Y005 V6  
Beckton Lana Y541 W  
Beckton Nebula T398 V3  
Beckton Indigo T613 JT  
Beckton Lancer F442 T  
Beckton Kit F468 JL  
Beckton Legend S670  
Beckton Lana T148 NB

BWt 52  
WR 99  
YWt. 927  
YR 94  
Feb.ADG 2.87  
Feb.Scr. 34  
Fr. 5.0

**DAM**  
Age 3  
Wt 865  
Prog.BW 52  
WR 99  
YR 94  
Wean Pct. 55%  
Cow Eff. 117

RAAA HerdBuilder index: **229** (Top 1% of RA breed)  
RAAA GridMaster index: **48** (Top 51% of RA breed)  
Calv.Ease BW WW YW Milk HPG Stay Maint.En.  
EPDs **20 -5.6 44 69 27 14 20 -8.0**  
Marb **+0.37** REA **-0.02** Bfat **+0.03**

★★★★★ for Low Maintenance, Marbling, High Cow Efficiency, Calving Ease, Stayability.

• Bulls •

## 202 BECKTON SCAMP F716 J5

1-A 100% # 3988326 Tat.: BSF8 F716

Birth: 4-14-18

Beckton Scamp X458 H3  
**BECKTON SCAMP B720 L4**  
 Ref. S-1 Beckton Larkaba Y448 L

Beckton Julian W743 H5  
**BECKTON CHRISTY A641 J**  
 Beckton Christy X005 L

Beckton Scamp T A825  
 BKT Pine Marie R401 HU  
 Beckton Likable U130 L2  
 Beckton Larkaba T655 NB  
 Beckton Julian G5 S107  
 Beckton Kit L399 HR  
 Beckton Legend U331 E2  
 Beckton Christy U415 JL

BWt 71  
 WR 98  
 YWt. 1033  
 YR 101  
 Feb.ADG 2.75  
 Feb.Scr. 36  
 Fr. 5.5

**DAM**  
 Age 5  
 Wt 1125  
 Prog.BW 68  
 WR 98  
 YR 105  
 Wean Pct. 50%  
 Cow Eff. 105

RAAA HerdBuilder index: **185** (Top 39% of RA breed)  
 RAAA GridMaster index: **51** (Top 7% of RA breed)  
 Calv.Ease BW WW YW Milk HPG Stay Maint.En.  
 EPDs **17 -4.3 51 90 24 18 13 -7.0**  
 Marb **+0.35** REA **-0.07** Bfat **+0.03**

## 205 BECKTON LIKABLE F165 A5

1-A 100% # 3988740 Tat.: BSF8 F165

Birth: 3-8-18

Beckton Likable Y124 L3  
**BECKTON LIKABLE D063 N4**  
 Ref. L-4 Beckton Serena W738 N

Beckton Accent Y260 L3  
**BECKTON COCA C732 A**  
 Beckton Coca W362 J

Beckton Likable U130 L2  
 BKT Pine Marie S802 LO  
 Beckton Nebula PJ S543  
 Beckton Serena S649 LO  
 Beckton Accent W180 C2  
 Beckton Lana W463 L  
 Beckton Justice C1 R483  
 Beckton Coca P440 JL

BWt 71  
 WR 89  
 YWt. 915  
 YR 96  
 Feb.ADG 2.81  
 Feb.Scr. 34  
 Fr. 5.5

**DAM**  
 Age 3  
 Wt 1140  
 Prog.BW 71  
 WR 88  
 YR 96  
 Wean Pct. 37%  
 Cow Eff. 79

RAAA HerdBuilder index: **201** (Top 16% of RA breed)  
 RAAA GridMaster index: **50** (Top 16% of RA breed)  
 Calv.Ease BW WW YW Milk HPG Stay Maint.En.  
 EPDs **17 -3.2 49 85 27 13 18 1.0**  
 Marb **+0.45** REA **-0.14** Bfat **+0.04**

★★★★★ for Low Maintenance, Marbling, Calving Ease, Stayability.

★★★★★ for Low Maintenance, Marbling, Calving Ease, Stayability.

## 203 BECKTON JAVELIN F709 N4

1-A 100% # 3988330 Tat.: BSF8 F709

Birth: 4-13-18

Beckton Javelin 6587  
**BKT JAVELIN 7466 R**  
 Ref. J-1 Beckton Rose 6807 RZ

Beckton Nebula W486 D3  
**BECKTON COCA A341 N**  
 Beckton Coca U616 EP

Beckton Trojan 5253  
 Beckton Ileximka -3  
 Beckton Raza 2308-N  
 Bkt Baya Rose 5195  
 Beckton Nebula L P093  
 Beckton Belga R716 DM  
 Beckton Epic K4 N795  
 Beckton Coca P713 NP

BWt 61  
 WR 105  
 YWt. 986  
 YR 96  
 Feb.ADG 2.53  
 Feb.Scr. 38  
 Fr. 5.5

**DAM**  
 Age 5  
 Wt 1240  
 Prog.BW 73  
 WR 113  
 YR 108  
 Wean Pct. 48%  
 Cow Eff. 102

RAAA HerdBuilder index: **180** (Top 48% of RA breed)  
 RAAA GridMaster index: **46** (Top 92% of RA breed)  
 Calv.Ease BW WW YW Milk HPG Stay Maint.En.  
 EPDs **18 -5.0 41 63 22 11 16 -9.0**  
 Marb **+0.26** REA **-0.34** Bfat **+0.03**



Lot 205

★★★★★ for Low Maintenance, Marbling, Superior Cow, Calving Ease, Stayability.

## 204 BECKTON WARRIOR F202 W7

1-A 100% # 3988718 Tat.: BKT8 F202

Birth: 3-11-18

Beckton Warrior Y108 E5  
**BECKTON WARRIOR D359 L6**  
 Ref. W-1 Beckton Lana W463 L

Beckton Warrior Y108 E5  
**BECKTON COCA D237 W**  
 Beckton Coca Y579 H

Beckton Warrior W534 N4  
 Beckton Susan W058 E  
 Beckton Loki CL S284  
 Beckton Lana R327 EP  
 Beckton Warrior W534 N4  
 Beckton Susan W058 E  
 Beckton Hasten U108 J3  
 Beckton Coca T080 NB

BWt 69  
 WR 96  
 YWt. 934  
 YR 100  
 Feb.ADG 3.03  
 Feb.Scr. 33  
 Fr. 5.5

**DAM**  
 Age 2  
 Wt 860  
 Prog.BW 69  
 WR 96  
 YR 100  
 Wean Pct. 50%  
 Cow Eff. 106

RAAA HerdBuilder index: **187** (Top 36% of RA breed)  
 RAAA GridMaster index: **48** (Top 63% of RA breed)  
 Calv.Ease BW WW YW Milk HPG Stay Maint.En.  
 EPDs **17 -5.0 50 83 26 11 16 -6.0**  
 Marb **+0.26** REA **-0.12** Bfat **+0.05**

## 206 BECKTON EPIC F264 E7

1-A 100% # 3987794 Tat.: BKT8 F264

Birth: 3-15-18

Beckton Epic U749 D5  
**BECKTON EPIC B483 N6**  
 Ref. E-5 BKT Pine Marie X339 N

Beckton Epic Y484 N6  
**BECKTON MINERVA A244 E**  
 Beckton Minerva Y385 N

Beckton Epic K4 N795  
 Beckton Denise R308 DM  
 Beckton Nebula T269 E2  
 BKT Pine Marie S467 JE  
 Beckton Epic U749 D5  
 Beckton Lydia S069 NB  
 Beckton Nebula T398 V3  
 Beckton Minerva U310 LO

BWt 71  
 WR 80  
 YWt. 959  
 YR 97  
 Feb.ADG 3.15  
 Feb.Scr. 31  
 Fr. 5.0

**DAM**  
 Age 5  
 Wt 1105  
 Prog.BW 64  
 WR 90  
 YR 96  
 Wean Pct. 41%  
 Cow Eff. 87

RAAA HerdBuilder index: **190** (Top 30% of RA breed)  
 RAAA GridMaster index: **50** (Top 16% of RA breed)  
 Calv.Ease BW WW YW Milk HPG Stay Maint.En.  
 EPDs **12 -2.9 47 90 26 10 18 -2.0**  
 Marb **+0.28** REA **-0.12** Bfat **+0.05**

★★★★★ for Low Maintenance, Marbling, Calving Ease, Stayability.

★★★★★ for Low Maintenance, Marbling, Calving Ease, Stayability.

• Bulls •

## 207 BECKTON CARDINAL F108 A3

1-A 100% # 3987970 Tat.: BKT8 F108



Birth: 3-2-18

Beckton Cardinal B074 N  
 Beckton Firefly B052 W

Beckton Cardinal D010 W2  
 Ref. C-2

Beckton Accent B549 N3  
 Beckton Lana B973 S

Beckton LANA D125 A

TR Double Eagle ZT220  
 BKT Pine Marie Z250 N  
 Beckton Warrior Z936 N6  
 Beckton Firefly Z663 N  
 Beckton Accent W180 C2  
 Beckton Minerva Y654 N  
 Beckton Scamp X458 H3  
 Beckton Lana W157 N

BWt	61
WR	94
YWt.	912
YR	97
Feb.ADG	2.58
Feb.Scr.	36
Fr.	5.0

DAM

Age	2
Wt	850
Prog.BW	61
WR	94
YR	97
Wean Pct.	50%
Cow Eff.	104

RAAA HerdBuilder index: **206** (Top 10% of RA breed)  
 RAAA GridMaster index: **51** (Top 11% of RA breed)

Calv.Ease	BW	WW	YW	Milk	HPG	Stay	Maint.En.	
EPDs	17	-5.0	51	89	26	14	18	-4.0

Marb **+0.42** REA **+0.01** Bfat **+0.04**

★★★★★ for Low Maintenance, Marbling, Calving Ease, Stayability.

## 210 BECKTON EPIC F044 L9

1-A 100% # 3988862 Tat.: BSF8 F044



Birth: 2-19-18

Beckton Epic B545 N7  
 Beckton Christy B701 E

Beckton Epic D002 E8  
 Ref. E

Beckton Epic Y484 N6  
 Beckton Serena X338 N  
 Beckton Epic Y484 N6  
 Beckton Christy X005 L  
 Beckton Likable X445 J3  
 Beckton Minola X107 L  
 Beckton Nebula T398 V3  
 Beckton Minerva M369 L0

BWt	60
WR	94
YWt.	891
YR	99
Feb.ADG	2.87
Feb.Scr.	33
Fr.	5.5

DAM

Age	2
Wt	800
Prog.BW	60
WR	95
YR	99
Wean Pct.	50%
Cow Eff.	105

RAAA HerdBuilder index: **215** (Top 4% of RA breed)  
 RAAA GridMaster index: **52** (Top 4% of RA breed)

Calv.Ease	BW	WW	YW	Milk	HPG	Stay	Maint.En.	
EPDs	13	-2.8	61	106	25	12.5	20	-6.0

Marb **+0.36** REA **+0.09** Bfat **+0.04**

★★★★★ for Low Maintenance, Marbling, Calving Ease, Stayability.

## 208 BSF EPIC F510 S7

1-B 99% # 3988498 Tat.: BSF8 F510



Birth: 3-27-18

Beckton Epic U749 D5  
 BKT Pine Marie X339 N

Beckton Epic B483 N6  
 Ref. E-5

Beckton Scamp A627 J4  
 BSF Codette A666 D

Beckton Epic K4 N795  
 Beckton Denise R308 DM  
 Beckton Nebula T269 E2  
 BKT Pine Marie S467 JE  
 Beckton Scamp X494 E3  
 Beckton Serena R023 JC  
 Beckton Dominor Y005 V6  
 BSF Codette Y525 W

BWt	63
WR	100
YWt.	990
YR	104
Feb.ADG	2.75
Feb.Scr.	32
Fr.	5.5

DAM

Age	3
Wt	880
Prog.BW	61
WR	104
YR	106
Wean Pct.	56%
Cow Eff.	117

RAAA HerdBuilder index: **180** (Top 50% of RA breed)  
 RAAA GridMaster index: **52** (Top 5% of RA breed)

Calv.Ease	BW	WW	YW	Milk	HPG	Stay	Maint.En.	
EPDs	15	-3.9	51	95	28	12	15	-2.0

Marb **+0.35** REA **-0.12** Bfat **+0.04**

★★★★★ for Low Maintenance, Marbling, Superior Cow, High Cow Efficiency, Calving Ease, Stayability.

## 211 BECKTON EPIC F401 A7

1-A 100% # 3988574 Tat.: BSF8 F401



Birth: 3-22-18

Beckton Epic U749 D5  
 Beckton Indigo U504 EP

Beckton Epic Z674 E6  
 Ref. E-2

Beckton Accent W180 C2  
 Beckton Firefly U409 JD

Beckton Epic K4 N795  
 Beckton Denise R308 DM  
 Beckton Epic K6 S569  
 Beckton Indigo S016 NB  
 Beckton Cody K1 P014  
 Beckton Christy R046 CQ  
 TR Julian RT561  
 Beckton Firefly J650 CD

BWt	68
WR	97
YWt.	959
YR	101
Feb.ADG	2.98
Feb.Scr.	NA
Fr.	5.5

DAM

Age	3
Wt	985
Prog.BW	70
WR	100
YR	103
Wean Pct.	48%
Cow Eff.	101

RAAA HerdBuilder index: **193** (Top 26% of RA breed)  
 RAAA GridMaster index: **50** (Top 23% of RA breed)

Calv.Ease	BW	WW	YW	Milk	HPG	Stay	Maint.En.	
EPDs	13	-1.6	58	97	25	10	18	-3.0

Marb **+0.36** REA **-0.10** Bfat **+0.04**

★★★★★ for Low Maintenance, Marbling, Calving Ease, Stayability.

## 209 BSF SCAMP F291 C6

1-B 100% # 3988652 Tat.: BSF8 F291



Birth: 3-17-18

Beckton Scamp A627 J4  
 Beckton Coca A120 N

Beckton SCAMP D739 N5  
 Ref. S-4

Beckton Clifftop W692 E3  
 Beckton Encino Z090 S

Beckton Scamp X494 E3  
 Beckton Serena R023 JC  
 Beckton Nebula Y002 C5  
 Beckton Coca Y190 J  
 BKT Clifftop TP R288  
 Beckton Lydia S274 EP  
 Beckton Scamp X494 E3  
 Beckton Encino X642 W

BWt	54
WR	99
YWt.	978
YR	103
Feb.ADG	2.87
Feb.Scr.	34
Fr.	5.0

DAM

Age	3
Wt	1020
Prog.BW	54
WR	99
YR	103
Wean Pct.	47%
Cow Eff.	99

RAAA HerdBuilder index: **184** (Top 41% of RA breed)  
 RAAA GridMaster index: **49** (Top 31% of RA breed)

Calv.Ease	BW	WW	YW	Milk	HPG	Stay	Maint.En.	
EPDs	19	-6.0	49	83	25	15	14	-6.0

Marb **+0.36** REA **-0.29** Bfat **+0.04**

★★★★★ for Low Maintenance, Marbling, Calving Ease, Stayability.



Lot 212



• Bulls •

**212 BSF EPIC F579 J7** 1-B 99% # 3988446 Tat.: BSF8 F579 

Birth: 4-1-18

Beckton Epic X464 L5  
**BECKTON EPIC B310 J6** Ref. E-4  
 Beckton Minerva Y116 J

Beckton Epic K6 S569  
 Beckton Lana M393 LN  
 Beckton Julian W743 H5  
 Beckton Minerva W081 N  
 Beckton Julian X721 E6  
 Beckton Larkaba X064 J  
 Red Angus multiple sire  
 Beckton Belga M050 EP

BWt 64  
 WR 98  
 YWt. 962  
 YR 99  
 Feb.ADG 2.75  
 Feb.Scr. 33  
 Fr. 5.0

Beckton Julian Z382 J7  
**BSF JULIANNE B007 M8**  
 BSF Regina Z326 M

DAM		RAAA HerdBuilder index: 191 (Top 28% of RA breed)																
Age	4	RAAA GridMaster index: 46 (Top 87% of RA breed)																
Wt	910	Calv.Ease	BW	WW	YW	Milk	HPG	Stay	Maint.En.	EPDs	18	-5.3	49	76	26	14	17	-7.0
Prog.BW	57	Marb +.30			REA -.05			Bfat +.03										
WR	99																	
YR	97																	
Wean Pct.	56%																	
Cow Eff.	117																	

**215 BECKTON ACCENT F472 R4** 1-A 100% # 3988524 Tat.: BSF8 F472 

Birth: 3-25-18

Beckton Accent U777 C2  
**BECKTON ACCENT D174 N3** Ref. A-6  
 BKT Larkeisa S055 NB

Beckton Cody K1 P014  
 Beckton Susan R022 CQ  
 Beckton Nebula P F707  
 Beckton Larkeisa P688 CH  
 Beckton Ranger Z225 J4  
 Beckton Suffeina Z731 D  
 Beckton Ranger Z225 J4  
 Beckton Encino Z782 D

BWt 67  
 WR 98  
 YWt. 965  
 YR 103  
 Feb.ADG 2.98  
 Feb.Scr. 33  
 Fr. 5.5

Beckton Ranger B006 D5  
**BECKTON ENCINO D102 R**  
 Beckton Encino B056 R

DAM		RAAA HerdBuilder index: 189 (Top 32% of RA breed)																
Age	2	RAAA GridMaster index: 49 (Top 38% of RA breed)																
Wt	835	Calv.Ease	BW	WW	YW	Milk	HPG	Stay	Maint.En.	EPDs	17	-3.0	57	91	25	12	16	-7.0
Prog.BW	67	Marb +.43			REA -.08			Bfat +.05										
WR	98																	
YR	103																	
Wean Pct.	53%																	
Cow Eff.	111																	

★★★★★ for Low Maintenance, Marbling, High Cow Efficiency, Calving Ease, Stayability.

★★★★★ for Low Maintenance, Marbling, Calving Ease, Stayability.

**213 BECKTON ACCENT F372 W4** 1-A 100% # 3987660 Tat.: BKT8 F372 

Birth: 3-20-18

Beckton Accent W180 C2  
**BECKTON ACCENT B549 N3** Ref. A-3  
 Beckton Minerva Y654 N

Beckton Cody K1 P014  
 Beckton Christy R046 CQ  
 Beckton Nebula T398 V3  
 Beckton Minerva M369 LO  
 Beckton Warrior W534 N4  
 Beckton Susan W058 E  
 Beckton Accent W180 C2  
 Beckton Maiata W189 J

BWt 67  
 WR 92  
 YWt. 897  
 YR 94  
 Feb.ADG 2.81  
 Feb.Scr. 34  
 Fr. 5.5

Beckton Warrior Y108 E5  
**BECKTON MAIATA C343 W**  
 Beckton Maiata Y201 A

DAM		RAAA HerdBuilder index: 228 (Top 1% of RA breed)																
Age	3	RAAA GridMaster index: 50 (Top 22% of RA breed)																
Wt	820	Calv.Ease	BW	WW	YW	Milk	HPG	Stay	Maint.En.	EPDs	17	-3.3	55	92	25	11	21	-2.0
Prog.BW	66	Marb +.33			REA +.12			Bfat +.04										
WR	95																	
YR	96																	
Wean Pct.	54%																	
Cow Eff.	114																	

★★★★★ for Low Maintenance, Marbling, Calving Ease, Stayability.

**216 BECKTON HUGHES F308 S3** 1-A 100% # 3988632 Tat.: BSF8 F308 

Birth: 3-18-18

Bieber H Hughes W109  
**BECKTON HUGHES D589 S2** Ref. B-1  
 Beckton Sierra Z353 S

Basin Hobo 0545  
 Basin Rose 06T0  
 Beckton Scamp X494 E3  
 Beckton Sierra X555 N  
 Beckton Scamp X494 E3  
 Beckton Serena R023 JC  
 Beckton Jet L P491  
 Beckton Lana S866 CH

BWt 64  
 WR 100  
 YWt. 911  
 YR 97  
 Feb.ADG 2.42  
 Feb.Scr. 33  
 Fr. 6.0

Beckton Scamp A627 J4  
**BECKTON LANA D278 S**  
 Beckton Lana W314 J

DAM		RAAA HerdBuilder index: 186 (Top 37% of RA breed)																
Age	2	RAAA GridMaster index: 48 (Top 62% of RA breed)																
Wt	860	Calv.Ease	BW	WW	YW	Milk	HPG	Stay	Maint.En.	EPDs	17	-4.3	53	83	26	16	15	-7.0
Prog.BW	64	Marb +.30			REA -.15			Bfat +.03										
WR	100																	
YR	97																	
Wean Pct.	53%																	
Cow Eff.	111																	

★★★★★ for Low Maintenance, Marbling, Calving Ease, Stayability.

**214 BECKTON HERITAGE F546 H5** 1-A 100% # 3987448 Tat.: BKT8 F546 

Birth: 3-29-18

Beckton Heritage A767 C3  
**BECKTON HERITAGE D195 L4** Ref. H-2  
 Beckton Susan W846 L

Beckton Heritage X356 E2  
 Beckton Rose W816 C  
 Beckton Loki CL S284  
 Beckton Susan S684 JJ  
 Beckton Heritage X356 E2  
 Beckton Rose W816 C  
 Beckton Accent W180 C2  
 Beckton Lana R205 EP

BWt 64  
 WR 105  
 YWt. 966  
 YR 103  
 Feb.ADG 2.70  
 Feb.Scr. 32  
 Fr. 5.5

Beckton Heritage A767 C3  
**BECKTON LANA D260 H**  
 Beckton Lana Z724 A

DAM		RAAA HerdBuilder index: 180 (Top 49% of RA breed)																
Age	2	RAAA GridMaster index: 50 (Top 14% of RA breed)																
Wt	915	Calv.Ease	BW	WW	YW	Milk	HPG	Stay	Maint.En.	EPDs	16	-3.4	60	102	24	10	15	-2.0
Prog.BW	64	Marb +.38			REA -.08			Bfat +.04										
WR	105																	
YR	103																	
Wean Pct.	52%																	
Cow Eff.	110																	

★★★★★ for Low Maintenance, Marbling, Superior Cow, Calving Ease, Stayability.



Lot 214

• Bulls •

**217** **BSF EPIC F041 N8**   
 1-B 99% # 3988866 Tat.: BSF8 F041

Birth: 2-18-18

Beckton Epic B310 J6  
**BECKTON EPIC D110 J7**  
 Ref. E-8  
 Beckton Pine Marie B248 J

Beckton Epic X464 L5  
 Beckton Minerva Y116 J  
 Beckton Julian X465 J5  
 BKT Pine Marie P351 EP  
 Beckton Nebula P P707  
 Beckton Larkaba T813 JC  
 Beckton Legend S670  
 BSF Erica W053 R

BWt 60  
 WR 97  
 YWt. 880  
 YR 98  
 Feb.ADG 2.64  
 Feb.Scr. 32  
 Fr. 5.5

Beckton Nebula B557 J3  
**BSF ERICA D089 N**  
 BSF Erica B207 L

**DAM**  
 Age 2  
 Wt 805  
 Prog.BW 60  
 WR 97  
 YR 98  
 Wean Pct. 51%  
 Cow Eff. 107

RAAA HerdBuilder index: **190** (Top 30% of RA breed)  
 RAAA GridMaster index: **49** (Top 36% of RA breed)  
 Calv.Ease BW WW YW Milk HPG Stay Maint.En.  
 EPDs **15 -3.4 55 91 27 14.5 17 -6.5**  
 Marb **+0.35** REA **-0.11** Bfat **+0.03**

★★★★★ for Low Maintenance, Marbling, Calving Ease, Stayability.

**219** **BECKTON ACCENT F416 L4**   
 1-A 100% # 3987608 Tat.: BKT8 F416

Birth: 3-22-18

Beckton Accent W180 C2  
**BECKTON ACCENT D115 N3**  
 Ref. A-5  
 Beckton Larkaba W272 N

Beckton Cody K1 P014  
 Beckton Christy R046 CQ  
 Beckton Nebula EN S347  
 Beckton Larkaba N643 HR  
 Beckton Loki CL S284  
 Beckton Vernice T447 HT  
 Beckton Nebula T398 V3  
 BKT Pine Marie W404 J

BWt 57  
 WR 100  
 YWt. 891  
 YR 95  
 Feb.ADG 2.25  
 Feb.Scr. 35  
 Fr. 5.0

Beckton Loki X833 H4  
**BECKTON PINE MARIE D634 L**  
 Beckton Pine Marie A975 N

**DAM**  
 Age 2  
 Wt 800  
 Prog.BW 57  
 WR 100  
 YR 95  
 Wean Pct. 57%  
 Cow Eff. 119

RAAA HerdBuilder index: **227** (Top 1% of RA breed)  
 RAAA GridMaster index: **48** (Top 59% of RA breed)  
 Calv.Ease BW WW YW Milk HPG Stay Maint.En.  
 EPDs **19 -5.7 52 81 29 13 20 -4.0**  
 Marb **+0.33** REA **-0.11** Bfat **+0.04**

★★★★★ for Low Maintenance, Marbling, High Cow Efficiency, Calving Ease, Stayability.



Lot 217

**220** **BECKTON CARDINAL F148 C3**   
 1-A 100% # 3987926 Tat.: BKT8 F148

Birth: 3-7-18

Beckton Cardinal B074 N  
**BECKTON CARDINAL D010 W2**  
 Ref. C-2  
 Beckton Firefly B052 W

TR Double Eagle ZT220  
 BKT Pine Marie Z250 N  
 Beckton Warrior Z936 N6  
 Beckton Firefly Z663 N  
 TR Double Eagle ZT220  
 BKT Pine Marie Z250 N  
 Beckton Accent Z506 J3  
 Beckton Indigo Z870 E

BWt 55  
 WR 103  
 YWt. 887  
 YR 99  
 Feb.ADG 2.36  
 Feb.Scr. 34  
 Fr. 5.0

Beckton Cardinal B074 N  
**BECKTON INDIGO D005 C**  
 Beckton Indigo B327 A

**DAM**  
 Age 2  
 Wt 895  
 Prog.BW 55  
 WR 103  
 YR 99  
 Wean Pct. 49%  
 Cow Eff. 104

RAAA HerdBuilder index: **200** (Top 16% of RA breed)  
 RAAA GridMaster index: **50** (Top 27% of RA breed)  
 Calv.Ease BW WW YW Milk HPG Stay Maint.En.  
 EPDs **19 -6.7 50 85 28 14 17 -5.5**  
 Marb **+0.38** REA **-0.10** Bfat **+0.04**

★★★★★ for Low Maintenance, Marbling, Calving Ease, Stayability.

**218** **BECKTON EPIC F284 A8**   
 1-A 100% # 3987772 Tat.: BKT8 F284

Birth: 3-16-18

Beckton Epic Z674 E6  
**BECKTON EPIC D275 L7**  
 Ref. E-9  
 Beckton Lana X839 L

Beckton Epic U749 D5  
 Beckton Indigo U504 EP  
 Beckton Legend S670  
 Beckton Lana S371 DM  
 Beckton Accent W180 C2  
 Beckton Lana W463 L  
 Beckton Loki CL S284  
 Beckton Lana S482 CT

BWt 64  
 WR 96  
 YWt. 965  
 YR 103  
 Feb.ADG 3.09  
 Feb.Scr. 30  
 Fr. 5.5

Beckton Accent Y260 L3  
**BECKTON LANA D614 A**  
 Beckton Lana U025 LO

**DAM**  
 Age 2  
 Wt 955  
 Prog.BW 64  
 WR 96  
 YR 103  
 Wean Pct. 45%  
 Cow Eff. 95

RAAA HerdBuilder index: **198** (Top 18% of RA breed)  
 RAAA GridMaster index: **50** (Top 14% of RA breed)  
 Calv.Ease BW WW YW Milk HPG Stay Maint.En.  
 EPDs **16 -3.4 57 94 24 10 17 -4.0**  
 Marb **+0.44** REA **-0.07** Bfat **+0.04**

★★★★★ for Low Maintenance, Marbling, Calving Ease, Stayability.



Lot 218

• Bulls •

**221 BSF HERITAGE F206 R5** 

1-B 99% # 3988712 Tat.: BSF8 F206

Birth: 3-12-18

Beckton Heritage X403 L3  
**BECKTON HERITAGE B612 J4**  
 Ref. H-1  
 Beckton Lana N291 JC

Beckton Heritage T270 J2  
 Beckton Indigo H150 LN  
 Beckton Justice G302  
 Beckton Lana H725 CH  
 Beckton Ranger T603 H3  
 Beckton Mona U564 JT  
 Beckton Nomad X290 N3  
 BSF Nebulann X483 J

BWt 67  
 WR 100  
 YWt. 965  
 YR 97  
 Feb.ADG 2.14  
 Feb.Scr. 33  
 Fr. 5.0

Beckton Ranger Z225 J4  
**BSF NEBULANN B084 R**  
 BSF Nebulann Z158 N

**DAM**  
 Age 4  
 Wt 930  
 Prog.BW 62  
 WR 100  
 YR 98  
 Wean Pct. 59%  
 Cow Eff. 125

RAAA HerdBuilder index: **164** (Top 76% of RA breed)  
 RAAA GridMaster index: **47** (Top 78% of RA breed)

Calv.Ease	BW	WW	YW	Milk	HPG	Stay	Maint.En.
EPDs 16	-3.7	61	90	21	12	14	-6.0

Marb **+0.33** REA **-0.20** Bfat **+0.04**

**223 BECKTON SCAMP F338 E5** 

1-A 100% # 3987714 Tat.: BKT8 F338

Birth: 3-19-18

Beckton Scamp X458 H3  
**BECKTON SCAMP B720 L4**  
 Ref. S-1  
 Beckton Larkaba Y448 L

Beckton Scamp T A825  
 BKT Pine Marie R401 HU  
 Beckton Likable U130 L2  
 Beckton Larkaba T655 NB  
 Beckton Epic T330 L5  
 Beckton Kit R503 LN  
 Beckton Nebula U206 V3  
 Beckton Rose W402 N

BWt 46  
 WR 96  
 YWt. 925  
 YR 97  
 Feb.ADG 3.09  
 Feb.Scr. 35  
 Fr. 5.5

Beckton Epic X330 L6  
**BECKTON ROSE C753 E**  
 Beckton Rose Z729 N

**DAM**  
 Age 3  
 Wt 870  
 Prog.BW 49  
 WR 98  
 YR 102  
 Wean Pct. 54%  
 Cow Eff. 113

RAAA HerdBuilder index: **185** (Top 39% of RA breed)  
 RAAA GridMaster index: **50** (Top 14% of RA breed)

Calv.Ease	BW	WW	YW	Milk	HPG	Stay	Maint.En.
EPDs 18	-6.3	51	90	24	12	15	-5.0

Marb **+0.33** REA **-0.01** Bfat **+0.03**

★★★★★ for Low Maintenance, Marbling, High Cow Efficiency, Calving Ease, Stayability.

★★★★★ for Low Maintenance, Marbling, Calving Ease, Stayability.



Lot 221

**224 BECKTON ROOSEVELT F595 A3** 

1-A 100% # 3988434 Tat.: BSF8 F595

Birth: 4-2-18

Bieber Roosevelt W384  
**BECKTON ROOSEVELT D391 L2**  
 Ref. B  
 Beckton Indigo Y406 L

Bieber Rough Rider 10712  
 Bieber Sheba 9602  
 Beckton Likable U130 L2  
 Beckton Indigo R745 WR  
 Beckton Accent W180 C2  
 Beckton Minerva Y654 N  
 Beckton Accent W180 C2  
 Beckton Christy Y364 N

BWt 56  
 WR 103  
 YWt. 898  
 YR 96  
 Feb.ADG 2.30  
 Feb.Scr. 32  
 Fr. 5.5

Beckton Accent B549 N3  
**BECKTON CHRISTY D025 A**  
 Beckton Christy B240 A

**DAM**  
 Age 2  
 Wt 755  
 Prog.BW 56  
 WR 103  
 YR 96  
 Wean Pct. 62%  
 Cow Eff. 131

RAAA HerdBuilder index: **219** (Top 3% of RA breed)  
 RAAA GridMaster index: **48** (Top 54% of RA breed)

Calv.Ease	BW	WW	YW	Milk	HPG	Stay	Maint.En.
EPDs 18	-4.2	54	84	25	11	20	-6.0

Marb **+0.32** REA **+0.09** Bfat **+0.04**

★★★★★ for Low Maintenance, Marbling, High Cow Efficiency, Calving Ease, Stayability.

**222 BECKTON EPIC F522 L7** 

1-A 100% # 3987474 Tat.: BKT8 F522

Birth: 3-27-18

Beckton Epic U749 D5  
**BECKTON EPIC Z674 E6**  
 Ref. E-2  
 Beckton Indigo U504 EP

Beckton Epic K4 N795  
 Beckton Denise R308 DM  
 Beckton Epic K6 S569  
 Beckton Indigo S016 NB  
 Beckton Loki C M740  
 Beckton Lakme J460 LT  
 Beckton Nebula M045  
 Beckton Coca P459 LN

BWt 72  
 WR 83  
 YWt. 930  
 YR 94  
 Feb.ADG 2.47  
 Feb.Scr. 33  
 Fr. 5.0

Beckton Loki CL S284  
**BECKTON COCA X433 L**  
 Beckton Coca T419 NB

**DAM**  
 Age 8  
 Wt 1250  
 Prog.BW 72  
 WR 100  
 YR 99  
 Wean Pct. 38%  
 Cow Eff. 79

RAAA HerdBuilder index: **167** (Top 71% of RA breed)  
 RAAA GridMaster index: **48** (Top 58% of RA breed)

Calv.Ease	BW	WW	YW	Milk	HPG	Stay	Maint.En.
EPDs 14	-3.3	50	85	24	11	15	0.0

Marb **+0.36** REA **-0.20** Bfat **+0.05**

★★★★★ for Low Maintenance, Marbling, Calving Ease, Stayability.

**225 BECKTON EPIC F596 L7** 

1-A 100% # 3988432 Tat.: BSF8 F596

Birth: 4-2-18

Beckton Epic U749 D5  
**BECKTON EPIC Z674 E6**  
 Ref. E-2  
 Beckton Indigo U504 EP

Beckton Epic K4 N795  
 Beckton Denise R308 DM  
 Beckton Epic K6 S569  
 Beckton Indigo S016 NB  
 Beckton Likable U130 L2  
 Beckton Tamara M515 LN  
 Beckton Nebula T398 V3  
 Beckton Angel T004 CT

BWt 66  
 WR 102  
 YWt. 906  
 YR 95  
 Feb.ADG 2.42  
 Feb.Scr. 33  
 Fr. 5.5

Beckton Likable Y362 L3  
**BECKTON ANGEL C816 L**  
 Beckton Angel X450 N

**DAM**  
 Age 3  
 Wt 920  
 Prog.BW 64  
 WR 101  
 YR 102  
 Wean Pct. 54%  
 Cow Eff. 114

RAAA HerdBuilder index: **183** (Top 43% of RA breed)  
 RAAA GridMaster index: **49** (Top 36% of RA breed)

Calv.Ease	BW	WW	YW	Milk	HPG	Stay	Maint.En.
EPDs 13	-2.3	55	91	25	11	17	-4.0

Marb **+0.42** REA **-0.13** Bfat **+0.05**

★★★★★ for Low Maintenance, Marbling, Calving Ease, Stayability.



• Bulls •

## 226 BSF LIKABLE F404 E4

1-B 99% # 3988572 Tat.: BSF8 F404

Birth: 3-22-18

Beckton Likable U130 L2  
**BECKTON LIKABLE D432 N3**  
 Ref. L-5  
 Beckton Firefly W013 N

Beckton Emperor Y459 J3  
**BSF LANETTE D433 E**  
 BSF Lanette Z079 E

Beckton Likable S633  
 Beckton Kit S478 LN  
 Beckton Nebula T054 H3  
 Beckton Firefly T003 JC  
 Beckton Emperor T641 E2  
 Beckton Indigo S354 JT  
 Beckton Epic X330 L6  
 BSF Lanette X568 W

BWt 69  
 WR 94  
 YWt. 941  
 YR 101  
 Feb.ADG 2.75  
 Feb.Scr. 33  
 Fr. 5.5

**DAM**  
 Age 2  
 Wt 925  
 Prog.BW 69  
 WR 94  
 YR 101  
 Wean Pct. 46%  
 Cow Eff. 96

RAAA HerdBuilder index: **197** (Top 20% of RA breed)  
 RAAA GridMaster index: **51** (Top 9% of RA breed)

Calv.Ease	BW	WW	YW	Milk	HPG	Stay	Maint.En.
EPDs 17	-3.2	52	90	24	13	16	-8.0

Marb **+0.36** REA **+0.02** Bfat **+0.03**

★★★★★ for Low Maintenance, Marbling, Calving Ease, Stayability.

## 229 BECKTON DOMINOR F560 R9

1-A 100% # 3988458 Tat.: BSF8 F560

Birth: 3-30-18

Beckton Dominor A378 W7  
**BECKTON DOMINOR D254 N8**  
 Ref. D-3  
 Beckton Indigo W772 N

Beckton Ranger B006 D5  
**BECKTON INDIGO D079 R**  
 Beckton Indigo B054 W

Beckton Dominor Y005 V6  
 Beckton Lana Y541 W  
 Beckton Nebula T398 V3  
 Beckton Indigo T613 JT  
 Beckton Ranger Z225 J4  
 Beckton Suffeina Z731 D  
 Beckton Warrior Z936 N6  
 Beckton Indigo Z094 J

BWt 54  
 WR 104  
 YWt. 897  
 YR 100  
 Feb.ADG 2.47  
 Feb.Scr. 33  
 Fr. 5.0

**DAM**  
 Age 2  
 Wt 905  
 Prog.BW 54  
 WR 105  
 YR 100  
 Wean Pct. 49%  
 Cow Eff. 104

RAAA HerdBuilder index: **199** (Top 17% of RA breed)  
 RAAA GridMaster index: **51** (Top 9% of RA breed)

Calv.Ease	BW	WW	YW	Milk	HPG	Stay	Maint.En.
EPDs 18	-3.7	56	95	27	14	16	-5.0

Marb **+0.45** REA **+0.00** Bfat **+0.04**

★★★★★ for Low Maintenance, Marbling, Calving Ease, Stayability.

## 227 BECKTON HUGHES F218 H2

1-A 100% # 3987846 Tat.: BKT8 F218

Birth: 3-12-18

Bieber H Hughes W109  
**BECKTON HUGHES D589 S2**  
 Ref. B-1  
 Beckton Sierra Z353 S

Bieber H Hughes W109  
**BECKTON LARKABA D590 B**  
 Beckton Larkaba A329 E

Basin Hobo 0545  
 Basin Rose 06T0  
 Beckton Scamp X494 E3  
 Beckton Sierra X555 N  
 Basin Hobo 0545  
 Basin Rose 06T0  
 Beckton Epic U749 D5  
 Beckton Larkaba P645 JL

BWt 39  
 WR 99  
 YWt. 891  
 YR 99  
 Feb.ADG 2.75  
 Feb.Scr. 33  
 Fr. 5.0

**DAM**  
 Age 2  
 Wt 825  
 Prog.BW 39  
 WR 99  
 YR 99  
 Wean Pct. 51%  
 Cow Eff. 107

RAAA HerdBuilder index: **202** (Top 14% of RA breed)  
 RAAA GridMaster index: **47** (Top 74% of RA breed)

Calv.Ease	BW	WW	YW	Milk	HPG	Stay	Maint.En.
EPDs 20	-6.8	51	79	27	15	16	-4.0

Marb **+0.41** REA **-0.03** Bfat **+0.04**

★★★★★ for Low Maintenance, Marbling, Calving Ease, Stayability.

## 230 BSF EPIC F454 W8

1-B 99% # 3988534 Tat.: BSF8 F454

Birth: 3-23-18

Beckton Epic Y484 N6  
**BECKTON EPIC B545 N7**  
 Ref. E-6  
 Beckton Serena X338 N

Beckton Warrior W534 N4  
**BSF CODETTE Z834 W**  
 BSF Codette U860 CD

Beckton Epic U749 D5  
 Beckton Lydia S069 NB  
 Beckton Nebula T398 V3  
 Beckton Serena S649 LO  
 Beckton Warrior C1 S337  
 BKT Larkeisa S055 NB  
 Beckton Cody K1 P014  
 BSF Regus M604 LN

BWt 76  
 WR 91  
 YWt. 899  
 YR 91  
 Feb.ADG 2.75  
 Feb.Scr. 32  
 Fr. 4.5

**DAM**  
 Age 6  
 Wt 1140  
 Prog.BW 71  
 WR 106  
 YR 103  
 Wean Pct. 45%  
 Cow Eff. 95

RAAA HerdBuilder index: **192** (Top 27% of RA breed)  
 RAAA GridMaster index: **48** (Top 59% of RA breed)

Calv.Ease	BW	WW	YW	Milk	HPG	Stay	Maint.En.
EPDs 13	-1.9	54	89	24	11	19	-4.0

Marb **+0.27** REA **+0.01** Bfat **+0.04**

★★★★★ for Low Maintenance, Marbling, Calving Ease, Stayability.

## 228 BECKTON EPIC F524 W7

1-A 100% # 3988484 Tat.: BSF8 F524

Birth: 3-27-18

Beckton Epic X464 L5  
**BECKTON EPIC B310 J6**  
 Ref. E-4  
 Beckton Minerva Y116 J

Beckton Warrior Y108 E5  
**BECKTON LARKEISA C533 W**  
 Beckton Larkeisa Y524 W

Beckton Epic K6 S569  
 Beckton Lana M393 LN  
 Beckton Julian W743 H5  
 Beckton Minerva W081 N  
 Beckton Warrior W534 N4  
 Beckton Susan W058 E  
 Beckton Warrior W534 N4  
 BKT Larkeisa U583 NB

BWt 56  
 WR 101  
 YWt. 894  
 YR 98  
 Feb.ADG 2.36  
 Feb.Scr. 32  
 Fr. 5.0

**DAM**  
 Age 3  
 Wt 955  
 Prog.BW 54  
 WR 102  
 YR 101  
 Wean Pct. 47%  
 Cow Eff. 98

RAAA HerdBuilder index: **193** (Top 26% of RA breed)  
 RAAA GridMaster index: **47** (Top 72% of RA breed)

Calv.Ease	BW	WW	YW	Milk	HPG	Stay	Maint.En.
EPDs 17	-4.5	51	83	27	14	17	-5.5

Marb **+0.27** REA **-0.13** Bfat **+0.04**

★★★★★ for Low Maintenance, Marbling, Calving Ease, Stayability.



Lot 228

• Bulls •

**231 BECKTON EPIC F272 E8** 

1-A 100% # 3988662 Tat.: BSF8 F272

Birth: 3-15-18

Beckton Epic Z674 E6  
**BECKTON EPIC D457 C7**  
 Ref. E-11 Beckton Mona Z270 C

Beckton Epic U749 D5  
 Beckton Indigo U504 EP  
 Beckton Clifftop W577 E3  
 Beckton Mona U584 CD  
 Beckton Epic U749 D5  
 Beckton Indigo U504 EP  
 Beckton Legend X561 J2  
 Beckton Encino W287 N

BWt 77  
 WR 101  
 YWt. 958  
 YR 102  
 Feb.ADG 2.47  
 Feb.Scr. 30  
 Fr. 5.0

Beckton Epic Z674 E6  
**BECKTON ENCINO D441 E**  
 Beckton Encino Z514 L

**DAM**  
 Age 2  
 Wt 870  
 Prog.BW 77  
 WR 101  
 YR 102  
 Wean Pct. 52%  
 Cow Eff. 110

RAAA HerdBuilder index: 201 (Top 15% of RA breed)  
 RAAA GridMaster index: 50 (Top 14% of RA breed)  
 Calv.Ease BW WW YW Milk HPG Stay Maint.En.  
 EPDs 12 -0.3 61 104 25 13.5 19 -3.0  
 Marb +.43 REA -.17 Bfat +.05

★★★★★ for Low Maintenance, Marbling, Calving Ease, Stayability.

**234 BECKTON MAXIMUS F553 N** 

3 # N/A Tat.: BKT8 F553

Birth: 3-29-18

Beckton Red Angus Sire  
**BECKTON RED ANGUS SIRE**  
 Ref. Beckton Red Angus Dam

Beckton Red Angus Sire  
 Beckton Red Angus Dam  
 Beckton Red Angus Dam  
 Beckton Nebula U206 V3  
 Beckton Tamara U185 NB  
 Beckton Epic K4 N795  
 Beckton Larkeisa P136 NP

BWt 59  
 WR 112  
 YWt. 1082  
 YR 109  
 Feb.ADG 2.67  
 Feb.Scr. 34  
 Fr. 5.5

Beckton Nebula X096 N4  
**BECKTON LARKEISA B179 N**  
 Beckton Larkeisa W227 E

**DAM**  
 Age 4  
 Wt 1150  
 Prog.BW 52  
 WR 108  
 YR 101  
 Wean Pct. 51%  
 Cow Eff. 106

RAAA HerdBuilder index: 143 (Top 92% of RA breed)  
 RAAA GridMaster index: 48 (Top 59% of RA breed)  
 Calv.Ease BW WW YW Milk HPG Stay Maint.En.  
 EPDs 16 -4.4 52 82 23 4.5 12 0.5  
 Marb +.22 REA +.10 Bfat +.00

★★★★★ for Low Maintenance, Growth, Marbling, Calving Ease.

**232 BECKTON MAXIMUS F576 N** 

3 # N/A Tat.: BKT8 F576

Birth: 3-31-18

Beckton Red Angus Sire  
**BECKTON RED ANGUS SIRE**  
 Ref. Beckton Red Angus Dam

Beckton Red Angus Sire  
 Beckton Red Angus Dam  
 Beckton Red Angus Dam  
 Beckton Nebula M045  
 Beckton Lana M809 EP  
 Beckton Warrior TD L493  
 BKT Pine Marie L650 EP

BWt 69  
 WR 86  
 YWt. 951  
 YR 98  
 Feb.ADG 3.09  
 Feb.Scr. 32  
 Fr. 5.0

Beckton Nebula P P707  
**BKT PINE MARIE U454 NB**  
 BKT Pine Marie N582 WR

**DAM**  
 Age 10  
 Wt 1330  
 Prog.BW 73  
 WR 108  
 YR 103  
 Wean Pct. 35%  
 Cow Eff. 73

RAAA HerdBuilder index: 143 (Top 92% of RA breed)  
 RAAA GridMaster index: 49 (Top 46% of RA breed)  
 Calv.Ease BW WW YW Milk HPG Stay Maint.En.  
 EPDs 14 -2.8 44 73 24 8 12 1.0  
 Marb +.31 REA +.09 Bfat -.01

★★★★★ for Low Maintenance, Marbling, Calving Ease.

**235 BECKTON MAXIMUS F505 N** 

3 # N/A Tat.: BKT8 F505

Birth: 3-26-18

Beckton Red Angus Sire  
**BECKTON RED ANGUS SIRE**  
 Ref. Beckton Red Angus Dam

Beckton Red Angus Sire  
 Beckton Red Angus Dam  
 Beckton Red Angus Dam  
 Beckton Nebula M045  
 Beckton Ruth M967 EP  
 Beckton Heritage N013  
 Beckton Christy N542 JC

BWt 78  
 WR 99  
 YWt. 961  
 YR 94  
 Feb.ADG 2.89  
 Feb.Scr. 34  
 Fr. 4.5

Beckton Nebula T269 E2  
**BECKTON CHRISTY Z279 N**  
 Beckton Christy T749 HT

**DAM**  
 Age 6  
 Wt 1310  
 Prog.BW 64  
 WR 96  
 YR 93  
 Wean Pct. 43%  
 Cow Eff. 91

RAAA HerdBuilder index: 127 (Top 96% of RA breed)  
 RAAA GridMaster index: 46 (Top 88% of RA breed)  
 Calv.Ease BW WW YW Milk HPG Stay Maint.En.  
 EPDs 13 -2.0 45 63 22 6.5 11 -2.5  
 Marb +.25 REA +.03 Bfat -.01

★★★★★ for Low Maintenance, Marbling, Calving Ease.

**233 BECKTON MAXIMUS F780 C** 

3 # N/A Tat.: BKT8 F780

Birth: 4-22-18

Beckton Red Angus Sire  
**BECKTON RED ANGUS SIRE**  
 Ref. Beckton Red Angus Dam

Beckton Red Angus Sire  
 Beckton Red Angus Dam  
 Beckton Red Angus Dam  
 Beckton Clifftop W577 E3  
 Beckton Tamara R175 CQ  
 Beckton Clifftop W577 E3  
 Beckton Larkaba W050 E

BWt 79  
 WR 110  
 YWt. 1115  
 YR 109  
 Feb.ADG 3.03  
 Feb.Scr. 35  
 Fr. 6.0

Beckton Clifftop Z824 C4  
**BECKTON LARKABA B061 C**  
 Beckton Larkaba Z703 C

**DAM**  
 Age 4  
 Wt 1085  
 Prog.BW 79  
 WR 110  
 YR 109  
 Wean Pct. 56%  
 Cow Eff. 118

RAAA HerdBuilder index: (Top 1% of RA breed)  
 RAAA GridMaster index: 0 (Top 5% of RA breed)  
 Calv.Ease BW WW YW Milk HPG Stay Maint.En.  
 EPDs 6.5 -3.2 19 34 16.5 8 8.5 -1.5  
 Marb +.16 REA -.07 Bfat +.03

★★★★★ for Low Maintenance, Marbling, Superior Cow, High Cow Efficiency, Calving Ease.



Lot 235

# The Yearling Heifers

Heifer pregnancy and loss warranty  
**OPTIONAL WARRANTY**  
 See page 3 for more details.



Beckton females are nearly ideal for today's industry – moderately sized, efficient producers. They combine calving ease, growth, and desirable carcass traits. They are feminine, maternal and quiet, with nice udders and sound feet. All of our heifer calves trailed up with their mothers into the Bighorn Mountains to spend their first summer. They have learned the meaning of mothering ability. And they have the productive capacity to produce

the bulls that you see in our sale. The sale heifers are a select group from the top of our replacements.

If you wish, we can also keep any sale heifers through the summer and breed them in natural service to the same herd sires we use with our own replacements. There will be a charge of \$250 per heifer plus delivery at cost in the fall. Visit with Cam about this program.



Beckton is offering two straws of P707 semen or any other sire (for which we have adequate supply) to go with every heifer purchased. The buyer will only be responsible for shipping from Billings, MT and semen may be used on any animal the buyer would like.

## Heifer Pregnancy EPD

Heifer Pregnancy (HPG) is an EPD used to measure fertility. Because fertility as a trait is low in heritability, genetic predictions, or EPD's, of fertility may be of limited accuracy. Using 10 years of our own heifer pregnancy data, over 2500 heifer matings in total, the following tables show the relation of pregnancy percentage relative to the heifer's weight, and to the Heifer Pregnancy EPD (HPG) of the heifer's sire at the time she was bred.

The main factor influencing heifer pregnancy is heifer condition going into breeding season. For heifers that are in good flesh and "on the gain", in our data the HPG EPD of the sire appears to have little significant predictive value.

Heifer Weight	750+	651-750	551-650	up to 550 lbs.		
% Bred	93%	93%	87%	74%		
Sire HPG EPD	15+	13-14	11-12	9-10	7-8	6 or less
% Bred	92%	98%	94%	93%	91%	92%

Note: For heifers above 850 lbs the percentage bred declined, but the number of heifers was not significant.



• Heifers •

**301 BECKTON INDIGO F274 L**  
1-A 100% # 3988660 Tattoo: BSF8 F274

Birth: 3-16-18

Beckton Likable Z057 L4 < Beckton Likable X445 J3  
Beckton Minola X107 L

**BECKTON LIKABLE B032 C5**  
Ref. L-2 < Beckton Clifftop W577 E3  
Beckton Mona Z270 C < Beckton Mona U584 CD

Beckton Nebula T398 V3 < Beckton Nebula L P093  
Beckton Minerva J615 VG

**BECKTON INDIGO Y343 N**  
Beckton Lancer TE F363  
Beckton Indigo H150 LN < Beckton Indigo F376 CT

BWt **74**  
WR **126**  
YR **119**  
Fr. **Med**

DAM		RAAA HerdBuilder index: <b>245</b> (Top 1% of RA breed)
Age	7	RAAA GridMaster index: <b>52</b> (Top 3% of RA breed)
Wt	1110	Calv.Ease BW WW YW Milk HPG Stay Maint.En.
Prog.BW	66	EPDs <b>15 -3.7 62 107 24 13 22 -5.0</b>
WR	103	Marb <b>+0.39</b> REA <b>-0.11</b> Bfat <b>+0.04</b>
YR	103	
Cow Eff.	102	

★★★★★ for Low Maintenance, Growth, Marbling, Calving Ease, Stayability.

**304 BECKTON LARKEISA F215 A**  
1-A 100% # 3987850 Tattoo: BKT8 F215

Birth: 3-12-18

Beckton Cody K1 P014 < Beckton Cody KH M390  
Beckton Rose M126 WR

**BECKTON ACCENT W180 C2**  
Ref. A-1 < Beckton Cherokee N N479  
Beckton Christy R046 CQ < Beckton Christy N740 HR

Beckton Hasten H S462 < Beckton Hasten P292  
Beckton Lakme G128 HD

**BKT LARKEISA U535 HS**  
Beckton Hasten P292  
BKT Larkeisa S637 HS < BKT Larkeisa J800 LN

BWt **65**  
WR **112**  
YR **109**  
Fr. **Med**

DAM		RAAA HerdBuilder index: <b>218</b> (Top 4% of RA breed)
Age	10	RAAA GridMaster index: <b>49</b> (Top 46% of RA breed)
Wt	1065	Calv.Ease BW WW YW Milk HPG Stay Maint.En.
Prog.BW	71	EPDs <b>16 -3.7 62 95 24 9 20 -3.0</b>
WR	105	Marb <b>+0.24</b> REA <b>-0.03</b> Bfat <b>+0.02</b>
YR	100	
Cow Eff.	95	

★★★★★ for Low Maintenance, Growth, Marbling, Calving Ease, Stayability.

**302 BECKTON CHRISTY F147 A**  
1-A 100% # 3988758 Tattoo: BSF8 F147

Birth: 3-7-18

Beckton Cody K1 P014 < Beckton Cody KH M390  
Beckton Rose M126 WR

**BECKTON ACCENT W180 C2**  
Ref. A-1 < Beckton Cherokee N N479  
Beckton Christy R046 CQ < Beckton Christy N740 HR

Beckton Nebula U206 V3 < Beckton Nebula P P707  
Beckton Minerva J615 VG

**BECKTON CHRISTY Y686 N**  
Beckton Julian GG B571  
Beckton Christy J743 JL < Beckton Christy A111 VQ

BWt **66**  
WR **116**  
YR **118**  
Fr. **Med**

DAM		RAAA HerdBuilder index: <b>230</b> (Top 1% of RA breed)
Age	7	RAAA GridMaster index: <b>49</b> (Top 29% of RA breed)
Wt	1200	Calv.Ease BW WW YW Milk HPG Stay Maint.En.
Prog.BW	67	EPDs <b>16 -3.4 62 98 27 11 22 -1.0</b>
WR	109	Marb <b>+0.26</b> REA <b>+0.01</b> Bfat <b>+0.03</b>
YR	109	
Cow Eff.	87	

★★★★★ for Low Maintenance, Growth, Marbling, Superior Cow, Calving Ease, Stayability.

**305 BECKTON ROSE F542 A**  
1-A 100% # 3987456 Tattoo: BKT8 F542

Birth: 3-28-18

Beckton Accent U777 C2 < Beckton Cody K1 P014  
Beckton Susan R022 CQ

**BECKTON ACCENT B653 C3**  
Ref. A-4 < BKT Clifftop TP R288  
Beckton Christy W779 C < Beckton Christy S151 NB

Beckton Epic K6 S569 < Beckton Epic KM M115  
Beckton Sierra N703 LM

**BECKTON ROSE X389 E**  
Beckton Lancer T7 M089  
Beckton Rose P015 LN < Beckton Rose M131 HR

BWt **75**  
WR **118**  
YR **114**  
Fr. **Med**

DAM		RAAA HerdBuilder index: <b>203</b> (Top 13% of RA breed)
Age	8	RAAA GridMaster index: <b>49</b> (Top 45% of RA breed)
Wt	935	Calv.Ease BW WW YW Milk HPG Stay Maint.En.
Prog.BW	73	EPDs <b>16 -1.5 62 99 28 11 18 -6.0</b>
WR	113	Marb <b>+0.23</b> REA <b>-0.11</b> Bfat <b>+0.03</b>
YR	108	
Cow Eff.	114	

★★★★★ for Low Maintenance, Growth, Marbling, Superior Cow, Calving Ease, Stayability.

**303 BECKTON SUSAN F353 A**  
1-A 100% # 3987692 Tattoo: BKT8 F353

Birth: 3-19-18

Beckton Accent Y260 L3 < Beckton Accent W180 C2  
Beckton Lana W463 L

**BECKTON ACCENT B150 N4**  
Ref. A-2 < Beckton Nebula P P707  
BKT Larkeisa S055 NB < Beckton Larkeisa P688 CH

Beckton Epic T330 L5 < Beckton Epic K4 N795  
Beckton Belga K202 LN

**BECKTON SUSAN W058 E**  
Beckton Nebula H R233  
Beckton Susan T048 NB < Beckton Susan R022 CQ

BWt **73**  
WR **118**  
YR **115**  
Fr. **Med**

DAM		RAAA HerdBuilder index: <b>196</b> (Top 22% of RA breed)
Age	9	RAAA GridMaster index: <b>49</b> (Top 46% of RA breed)
Wt	1005	Calv.Ease BW WW YW Milk HPG Stay Maint.En.
Prog.BW	65	EPDs <b>16 -3.4 58 91 27 11 18 -2.0</b>
WR	109	Marb <b>+0.40</b> REA <b>-0.19</b> Bfat <b>+0.05</b>
YR	109	
Cow Eff.	105	

★★★★★ for Low Maintenance, Growth, Marbling, Superior Cow, Calving Ease, Stayability.

**306 BECKTON COCA F034 A**  
1-A 100% # 3988034 Tattoo: BKT8 F034

Birth: 2-17-18

Beckton Accent W180 C2 < Beckton Cody K1 P014  
Beckton Christy R046 CQ

**BECKTON ACCENT D115 N3**  
Ref. A-5 < Beckton Nebula EN S347  
Beckton Larkaba W272 N < Beckton Larkaba N643 HR

Beckton Accent W180 C2 < Beckton Cody K1 P014  
Beckton Christy R046 CQ

**BECKTON COCA D239 A**  
Beckton Nexus L016  
Beckton Coca T454 NX < Beckton Coca P597 CD

BWt **62**  
WR **126**  
YR **121**  
Fr. **Med**

DAM		RAAA HerdBuilder index: <b>238</b> (Top 1% of RA breed)
Age	2	RAAA GridMaster index: <b>50</b> (Top 23% of RA breed)
Wt	845	Calv.Ease BW WW YW Milk HPG Stay Maint.En.
Prog.BW	62	EPDs <b>18 -4.0 64 104 28 15 21 -3.0</b>
WR	126	Marb <b>+0.27</b> REA <b>-0.03</b> Bfat <b>+0.03</b>
YR	121	
Cow Eff.	109	

★★★★★ for Low Maintenance, Growth, Marbling, Superior Cow, Calving Ease, Stayability.

• Heifers •



**307 BECKTON SERENA F286 R**  
1-A 100% # 3987768 Tattoo: BKT8 F286

Birth: 3-16-18  
 Beckton Ranger Z225 J4 < Beckton Ranger T603 H3  
 Beckton Ranger B006 D5 < Beckton Mona U564 JT  
 Ref. R-1 Beckton Suffeina Z731 D < Beckton Dominor W640 C5  
 Beckton Suffeina W471 W  
 Beckton Dominor Y005 V6 < Beckton Dominor W640 C5  
 Beckton Belga W108 V  
 Beckton Serena A269 D < Beckton Emcoe W271 L2  
 Beckton Serena Y044 E < Beckton Serena W366 E

BWt **75**  
 WR **110**  
 YR **114**  
 Fr. **Med**

<b>DAM</b>	RAAA HerdBuilder index: <b>181</b> (Top <b>47%</b> of RA breed)									
Age	RAAA GridMaster index: <b>50</b> (Top <b>25%</b> of RA breed)									
Wt	945	Calv.Ease	BW	WW	YW	Milk	HPG	Stay	Maint.En.	
Prog.BW	64	EPDs	<b>16</b>	<b>-2.0</b>	<b>58</b>	<b>94</b>	<b>26</b>	<b>13</b>	<b>15</b>	<b>-3.0</b>
WR	102	Marb	<b>+0.39</b>		REA	<b>-0.05</b>		Bfat	<b>+0.04</b>	
YR	103									
Cow Eff.	105									

★★★★★ for Low Maintenance, Growth, Marbling, Calving Ease, Stayability.

**308 BECKTON LARKABA F309 N**  
1-A 100% # 3987746 Tattoo: BKT8 F309

Birth: 3-18-18  
 Beckton Neva 5562 < Beckton Pine 2778-8  
 Beckton NOMAD 7496 < Bkt Mona 1634-1549  
 Ref. V Bkt Bolt Tamrck 3913 < Thunderbolt  
 MD 373 RC 523  
 Beckton Julian G5 S107 < Beckton Julian GJ P535  
 Beckton LARKABA X247 J < Beckton Minola P826 DM  
 Beckton Larkaba D388 SC < Beckton Scamp T A825  
 Beckton Larkaba A833 JL

BWt **77**  
 WR **126**  
 YR **109**  
 Fr. **Med**

<b>DAM</b>	RAAA HerdBuilder index: <b>174</b> (Top <b>61%</b> of RA breed)									
Age	RAAA GridMaster index: <b>48</b> (Top <b>62%</b> of RA breed)									
Wt	1185	Calv.Ease	BW	WW	YW	Milk	HPG	Stay	Maint.En.	
Prog.BW	75	EPDs	<b>17</b>	<b>-3.5</b>	<b>51</b>	<b>76</b>	<b>21</b>	<b>21</b>	<b>13</b>	<b>-9.0</b>
WR	112	Marb	<b>+0.24</b>		REA	<b>-0.42</b>		Bfat	<b>+0.03</b>	
YR	114									
Cow Eff.	96									

★★★★★ for Low Maintenance, Growth, Marbling, Superior Cow, Calving Ease, Stayability.

**310 BECKTON CHRISTY F527 R**  
1-A 100% # 3988482 Tattoo: BSF8 F527

Birth: 3-27-18  
 Beckton Ranger Z225 J4 < Beckton Ranger T603 H3  
 Beckton RANGER B006 D5 < Beckton Mona U564 JT  
 Ref. R-1 Beckton Suffeina Z731 D < Beckton Dominor W640 C5  
 Beckton Suffeina W471 W  
 Beckton Epic U749 D5 < Beckton Epic K4 N795  
 Beckton CHRISTY Z958 E < Beckton Denise R308 DM  
 Beckton Christy W831 A < Beckton Cody K1 P014  
 Beckton Christy M362 WR

BWt **60**  
 WR **106**  
 YR **109**  
 Fr. **Med**

<b>DAM</b>	RAAA HerdBuilder index: <b>167</b> (Top <b>71%</b> of RA breed)									
Age	RAAA GridMaster index: <b>51</b> (Top <b>13%</b> of RA breed)									
Wt	1080	Calv.Ease	BW	WW	YW	Milk	HPG	Stay	Maint.En.	
Prog.BW	65	EPDs	<b>16</b>	<b>-2.7</b>	<b>57</b>	<b>96</b>	<b>26</b>	<b>12</b>	<b>13</b>	<b>-1.0</b>
WR	103	Marb	<b>+0.39</b>		REA	<b>+0.01</b>		Bfat	<b>+0.03</b>	
YR	105									
Cow Eff.	89									

★★★★★ for Low Maintenance, Growth, Marbling, Calving Ease, Stayability.

**309 BECKTON LARKEISA F508 S**  
1-A 100% # 3987488 Tattoo: BKT8 F508

Birth: 3-26-18  
 Beckton Scamp X458 H3 < Beckton Scamp T A825  
 Beckton SCAMP C349 C4 < BKT Pine Marie R401 HU  
 Ref. S-2 Beckton Lydia W178 C < BKT Clifftop TP R288  
 Beckton Lydia N047 LM  
 Beckton Dominor ZC M919 < Beckton Dominor Z E401  
 Beckton Barmaid J012 CO  
 BKT LARKEISA R676 DM < Beckton Epic KJ J722  
 BKT Larkeisa M816 EP < BKT Larkeisa J076 DM

BWt **68**  
 WR **118**  
 YR **112**  
 Fr. **Med**

<b>DAM</b>	RAAA HerdBuilder index: <b>177</b> (Top <b>55%</b> of RA breed)									
Age	RAAA GridMaster index: <b>50</b> (Top <b>16%</b> of RA breed)									
Wt	1240	Calv.Ease	BW	WW	YW	Milk	HPG	Stay	Maint.En.	
Prog.BW	69	EPDs	<b>14</b>	<b>-2.4</b>	<b>57</b>	<b>93</b>	<b>22</b>	<b>13</b>	<b>15</b>	<b>-3.0</b>
WR	101	Marb	<b>+0.35</b>		REA	<b>-0.17</b>		Bfat	<b>+0.03</b>	
YR	102									
Cow Eff.	83									

★★★★★ for Low Maintenance, Growth, Marbling, Calving Ease, Stayability.

**311 BECKTON VERNICE F318 L**  
1-A 100% # 3987736 Tattoo: BKT8 F318

Birth: 3-18-18  
 Beckton Likable Z057 L4 < Beckton Likable X445 J3  
 Beckton Minola X107 L  
 Beckton LIKABLE B032 C5 < Beckton Clifftop W577 E3  
 Ref. L-2 Beckton Mona Z270 C < Beckton Mona U584 CD  
 Beckton Cody K1 P014  
 Beckton Accent U777 C2 < Beckton Susan R022 CQ  
 Beckton VERNICE A176 A < Beckton Lancer TZ D525  
 Beckton Vernice L382 LN < Beckton Vernice G373 WR

BWt **39**  
 WR **82**  
 YR **100**  
 Fr. **Med**

<b>DAM</b>	RAAA HerdBuilder index: <b>225</b> (Top <b>2%</b> of RA breed)									
Age	RAAA GridMaster index: <b>49</b> (Top <b>43%</b> of RA breed)									
Wt	985	Calv.Ease	BW	WW	YW	Milk	HPG	Stay	Maint.En.	
Prog.BW	56	EPDs	<b>21</b>	<b>-8.1</b>	<b>41</b>	<b>77</b>	<b>29</b>	<b>13</b>	<b>19</b>	<b>-8.0</b>
WR	100	Marb	<b>+0.38</b>		REA	<b>-0.06</b>		Bfat	<b>+0.04</b>	
YR	101									
Cow Eff.	75									

★★★★★ for Low Maintenance, Marbling, Calving Ease, Stayability.

• Heifers •

**312 BECKTON MINOLA F178 S**  
1-A 100% # 3988732 Tattoo: BSF8 F178

Birth: 3-9-18

Beckton Scamp A627 J4 < Beckton Scamp X494 E3  
Beckton Serena R023 JC

**BECKTON SCAMP D739 N5**  
Ref. S-4 < Beckton Nebula Y002 C5  
Beckton Coca A120 N < Beckton Coca Y190 J

Beckton Emperor Z750 N3 < Beckton Emperor T641 E2  
Beckton Lana U789 NB

**BECKTON MINOLA B063 E**  
< Beckton Nebula W130 D3  
Beckton Minola Z752 N < Beckton Minola N751 JL

BWt **51**  
WR **103**  
YR **110**  
Fr. **Med**

DAM		RAAA HerdBuilder index: <b>199</b> (Top <b>18%</b> of RA breed)
Age	4	RAAA GridMaster index: <b>48</b> (Top <b>62%</b> of RA breed)
Wt	965	Calv.Ease BW WW YW Milk HPG Stay Maint.En.
Prog.BW	55	EPDs <b>21 -7.2 48 82 26 16 16 -5.0</b>
WR	104	Marb <b>+0.30</b> REA <b>-0.35</b> Bfat <b>+0.04</b>
YR	106	
Cow Eff.	92	

★★★★★ for Low Maintenance, Growth, Marbling, Superior Cow, Calving Ease, Stayability.

**314 BECKTON CHRISTY F128 S**  
1-A 100% # 3987948 Tattoo: BKT8 F128

Birth: 3-5-18

Beckton Scamp B720 L4 < Beckton Scamp X458 H3  
Beckton Larkaba Y448 L

**BECKTON SCAMP D065 L5**  
Ref. S < Beckton Likable Y124 L3  
Beckton Lana B316 L < Beckton Lana W748 D

Beckton Epic X464 L5 < Beckton Epic K6 S569  
Beckton Lana M393 LN

**BECKTON CHRISTY C559 E**  
< Beckton Julian X721 E6  
Beckton Christy Z125 J < Beckton Christy X354 N

BWt **50**  
WR **107**  
YR **107**  
Fr. **Med**

DAM		RAAA HerdBuilder index: <b>179</b> (Top <b>50%</b> of RA breed)
Age	3	RAAA GridMaster index: <b>48</b> (Top <b>52%</b> of RA breed)
Wt	980	Calv.Ease BW WW YW Milk HPG Stay Maint.En.
Prog.BW	60	EPDs <b>17 -4.3 55 86 27 12 15 -5.8</b>
WR	107	Marb <b>+0.31</b> REA <b>-0.09</b> Bfat <b>+0.04</b>
YR	107	
Cow Eff.	90	

★★★★★ for Low Maintenance, Growth, Marbling, Superior Cow, Calving Ease, Stayability.

**313 BECKTON COCA F431 J**  
1-A 100% # 3990206 Tattoo: BKT8 F431

Birth: 3-23-18

Beckton Julian 7526G < Beckton Julian 6592  
Bkt Belga 6746 GS

**BECKTON JULIAN GG B571**  
Ref. J-2 < Beckton Julian 7526G  
Bkt Marta 9A13 JL < Bkt Marta 6498 XM

Beckton Warrior W534 N4 < Beckton Warrior C1 S337  
BKT Larkeisa S055 NB

**BECKTON COCA A907 W**  
< Beckton Clifftop T3 N800  
Beckton Coca U561 CT < Beckton Coca P328 EP

BWt **71**  
WR **102**  
YR **107**  
Fr. **Med**

DAM		RAAA HerdBuilder index: <b>188</b> (Top <b>34%</b> of RA breed)
Age	5	RAAA GridMaster index: <b>49</b> (Top <b>31%</b> of RA breed)
Wt	860	Calv.Ease BW WW YW Milk HPG Stay Maint.En.
Prog.BW	66	EPDs <b>18 -5.2 48 76 26 13 16 -7.0</b>
WR	105	Marb <b>+0.40</b> REA <b>-0.13</b> Bfat <b>+0.05</b>
YR	112	
Cow Eff.	107	

★★★★★ for Low Maintenance, Growth, Marbling, Superior Cow, Calving Ease, Stayability.

**315 BECKTON RUTH F083 S**  
1-A 100% # 3987992 Tattoo: BKT8 F083

Birth: 2-25-18

Beckton Scamp A627 J4 < Beckton Scamp X494 E3  
Beckton Serena R023 JC

**BECKTON SCAMP D325 N5**  
Ref. S-3 < Beckton Nebula W065 C3  
Beckton Tamara Y039 N < Beckton Tamara W232 J

Beckton Scamp A627 J4 < Beckton Scamp X494 E3  
Beckton Serena R023 JC

**BECKTON RUTH D728 S**  
< Beckton Nebula Y002 C5  
Beckton Ruth A010 N < Beckton Ruth Y047 N

BWt **48**  
WR **95**  
YR **111**  
Fr. **Med**

DAM		RAAA HerdBuilder index: <b>183</b> (Top <b>42%</b> of RA breed)
Age	2	RAAA GridMaster index: <b>49</b> (Top <b>39%</b> of RA breed)
Wt	765	Calv.Ease BW WW YW Milk HPG Stay Maint.En.
Prog.BW	48	EPDs <b>19 -6.5 51 86 26 15 14 -5.0</b>
WR	95	Marb <b>+0.27</b> REA <b>-0.19</b> Bfat <b>+0.03</b>
YR	111	
Cow Eff.	87	

★★★★★ for Low Maintenance, Growth, Marbling, Superior Cow, Calving Ease, Stayability.



Family members of assisant office administrators

**316 BECKTON TAMARA F432 E**  
1-A 100% # 3987584 Tattoo: BKT8 F432

Birth: 3-23-18

Beckton Epic X464 L5 < Beckton Epic K6 S569  
Beckton Lana M393 LN

**BECKTON EPIC B310 J6**  
Ref. E-4 < Beckton Julian W743 H5  
Beckton Minerva Y116 J < Beckton Minerva W081 N

Beckton Roman J S158 < TR Romeo NT379  
Beckton Belga K285 JL

**BECKTON TAMARA X447 J**  
< Beckton Justice CH M056  
Beckton Tamara R834 JC < Beckton Tamara J229 NP

BWt **80**  
WR **99**  
YR **104**  
Fr. **Med**

DAM		RAAA HerdBuilder index: <b>175</b> (Top <b>59%</b> of RA breed)
Age	8	RAAA GridMaster index: <b>49</b> (Top <b>36%</b> of RA breed)
Wt	1180	Calv.Ease BW WW YW Milk HPG Stay Maint.En.
Prog.BW	69	EPDs <b>12 0.1 62 101 27 12 17 1.0</b>
WR	106	Marb <b>+0.24</b> REA <b>-0.08</b> Bfat <b>+0.03</b>
YR	109	
Cow Eff.	75	

★★★★★ for Low Maintenance, Marbling, Superior Cow, Calving Ease, Stayability.



• Heifers •



Beckton office

**319** **BSF LAUREL F654 E**  
 1-B 99% # 3988384 Tattoo: BSF8 F654  
 Birth: 4-8-18  
 Beckton Epic B310 J6 < Beckton Epic X464 L5  
 Beckton Minerva Y116 J  
**BECKTON EPIC D082 E7**  
 Ref. E < Beckton Epic X464 L5  
 Beckton Indigo B204 E < Beckton Indigo P043 LO  
 Beckton Julian X721 E6  
 Beckton Larkaba X064 J  
**BSF LAUREL B171 J**  
 Beckton Julian Z382 J7 < Beckton Clifftop W692 E3  
 BSF Laurel Z303 C < BSF Laurel U629 WR  
 BWT **62**  
 WR **109**  
 YR **103**  
 Fr. **Med**

DAM		RAAA HerdBuilder index: <b>194</b> (Top <b>24%</b> of RA breed)								
Age	4	RAAA GridMaster index: <b>48</b> (Top <b>49%</b> of RA breed)								
Wt	1065	Calv.Ease	BW	WW	YW	Milk	HPG	Stay	Maint.En.	
Prog.BW	65	EPDs	<b>15</b>	<b>-3.2</b>	<b>62</b>	<b>97</b>	<b>26</b>	<b>13</b>	<b>17</b>	<b>-3.5</b>
WR	110	Marb	<b>+0.25</b>		REA	<b>-0.10</b>		Bfat	<b>+0.04</b>	
YR	106									
Cow Eff.	89									

★★★★★ for Low Maintenance, Marbling, Superior Cow, Calving Ease, Stayability.

**317** **BECKTON SIERRA F080 A**  
 2 100% # 3988824 Tattoo: BSF8 F080  
 Birth: 2-25-18  
 Beckton Accent U777 C2 < Beckton Cody K1 P014  
 Beckton Susan R022 CQ  
**BECKTON ACCENT D174 N3**  
 Ref. A-6 < BKT Larkeisa S055 NB < Beckton Nebula P P707  
 Beckton Larkeisa P688 CH  
 BWT **47**  
 WR **105**  
 YR **103**  
 Fr. **Sma**

DAM		RAAA HerdBuilder index: <b>208</b> (Top <b>8%</b> of RA breed)								
Age	2	RAAA GridMaster index: <b>47</b> (Top <b>80%</b> of RA breed)								
Wt	745	Calv.Ease	BW	WW	YW	Milk	HPG	Stay	Maint.En.	
Prog.BW	47	EPDs	<b>20</b>	<b>-6.3</b>	<b>53</b>	<b>82</b>	<b>27</b>	<b>14</b>	<b>18</b>	<b>-6.0</b>
WR	105	Marb	<b>+0.37</b>		REA	<b>-0.09</b>		Bfat	<b>+0.05</b>	
YR	103									
Cow Eff.	101									

★★★★★ for Low Maintenance, Marbling, Calving Ease, Stayability.

**320** **BECKTON LARKEISA F054 S**  
 1-A 100% # 3988852 Tattoo: BSF8 F054  
 Birth: 2-21-18  
 Beckton Scamp A627 J4 < Beckton Scamp X494 E3  
 Beckton Serena R023 JC  
**BECKTON SCAMP D325 N5**  
 Ref. S-3 < Beckton Nebula W065 C3  
 Beckton Tamara W232 J  
 Beckton Accent Y260 L3 < Beckton Accent W180 C2  
 Beckton Lana W463 L  
**BECKTON LARKEISA D756 A**  
 Beckton Larkeisa Z924 E < Beckton Emperor T641 J2  
 BKT Larkeisa T310 JC  
 BWT **50**  
 WR **95**  
 YR **105**  
 Fr. **Med**

DAM		RAAA HerdBuilder index: <b>181</b> (Top <b>47%</b> of RA breed)								
Age	2	RAAA GridMaster index: <b>49</b> (Top <b>34%</b> of RA breed)								
Wt	765	Calv.Ease	BW	WW	YW	Milk	HPG	Stay	Maint.En.	
Prog.BW	50	EPDs	<b>17</b>	<b>-4.5</b>	<b>52</b>	<b>90</b>	<b>29</b>	<b>13</b>	<b>15</b>	<b>-5.0</b>
WR	95	Marb	<b>+0.29</b>		REA	<b>-0.09</b>		Bfat	<b>+0.03</b>	
YR	105									
Cow Eff.	88									

★★★★★ for Low Maintenance, Growth, Marbling, Calving Ease, Stayability.

**318** **BECKTON RUTH F185 S**  
 1-A 100% # 3987884 Tattoo: BKT8 F185  
 Birth: 3-9-18  
 Beckton Scamp X458 H3 < Beckton Scamp T A825  
 BKT Pine Marie R401 HU  
**BECKTON SCAMP B720 L4**  
 Ref. S-1 < Beckton Likable U130 L2  
 Beckton Larkaba T655 NB  
 Beckton Loki C M740  
 Beckton Lakme J460 LT  
**BECKTON RUTH W246 L**  
 Beckton Loki CL S284 < Beckton Lancer T5 L095  
 Beckton Ruth P591 LN < Beckton Ruth E549 TP  
 BWT **61**  
 WR **95**  
 YR **99**  
 Fr. **Med**

DAM		RAAA HerdBuilder index: <b>178</b> (Top <b>53%</b> of RA breed)								
Age	9	RAAA GridMaster index: <b>50</b> (Top <b>25%</b> of RA breed)								
Wt	1175	Calv.Ease	BW	WW	YW	Milk	HPG	Stay	Maint.En.	
Prog.BW	65	EPDs	<b>17</b>	<b>-4.5</b>	<b>50</b>	<b>85</b>	<b>24</b>	<b>13</b>	<b>14</b>	<b>-2.0</b>
WR	97	Marb	<b>+0.27</b>		REA	<b>-0.10</b>		Bfat	<b>+0.02</b>	
YR	102									
Cow Eff.	72									

★★★★★ for Low Maintenance, Marbling, Calving Ease, Stayability.

**321** **BSF HUSTELLE F413 S**  
 1-B 99% # 3988560 Tattoo: BSF8 F413  
 Birth: 3-22-18  
 Beckton Scamp A627 J4 < Beckton Scamp X494 E3  
 Beckton Serena R023 JC  
**BECKTON SCAMP D739 N5**  
 Ref. S-4 < Beckton Nebula Y002 C5  
 Beckton Coca Y190 J  
 Beckton Likable U120 L2  
 Beckton Firefly T331 EP  
**BSF HUSTELLE A370 L**  
 Beckton Likable Y675 E3 < Beckton Nebula T054 H3  
 BSF Hustelle Y509 N < BSF Hustelle U113 LO  
 BWT **67**  
 WR **99**  
 YR **111**  
 Fr. **Sma**

DAM		RAAA HerdBuilder index: <b>191</b> (Top <b>30%</b> of RA breed)								
Age	5	RAAA GridMaster index: <b>49</b> (Top <b>37%</b> of RA breed)								
Wt	945	Calv.Ease	BW	WW	YW	Milk	HPG	Stay	Maint.En.	
Prog.BW	66	EPDs	<b>18</b>	<b>-4.8</b>	<b>49</b>	<b>81</b>	<b>25</b>	<b>14</b>	<b>16</b>	<b>-6.0</b>
WR	104	Marb	<b>+0.38</b>		REA	<b>-0.16</b>		Bfat	<b>+0.04</b>	
YR	107									
Cow Eff.	94									

★★★★★ for Low Maintenance, Growth, Marbling, Superior Cow, Calving Ease, Stayability.

• Heifers •

**322** **BECKTON INDIGO F565 E**  
1-B 50% # 3987424 Tattoo: BKT8 F565

Birth: 3-30-18

Beckton Epic U749 D5 < Beckton Epic K4 N795  
Beckton Denise R308 DM

**BECKTON EPIC Z674 E6** BWT **70**  
Ref. E-2 Beckton Indigo U504 EP < Beckton Epic K6 S569  
WR **100**  
Beckton Indigo S016 NB

TR Julian LT151 < Beckton Julian GG B571  
MS Geometric 917

**BECKTON INDIGO T613 JT** YR **100**  
Fr. **Med**  
Beckton Loki F251  
Beckton Indigo H150 LN

DAM		RAAA HerdBuilder index: <b>187</b> (Top <b>36%</b> of RA breed)
Age	11	RAAA GridMaster index: <b>50</b> (Top <b>21%</b> of RA breed)
Wt	1010	Calv.Ease BW WW YW Milk HPG Stay Maint.En.
Prog.BW	70	EPDs <b>13 -2.2 57 96 24 9 18 0.0</b>
WR	103	Marb <b>+0.41</b> REA <b>-0.15</b> Bfat <b>+0.05</b>
YR	104	
Cow Eff.	85	

★★★★★ for Low Maintenance, Marbling, Superior Cow, Calving Ease, Stayability.

**324** **BECKTON SIERRA F912 A**  
1-A 100% # 3987046 Tattoo: BKT8 F912

Birth: 5-19-18

Beckton Accent U777 C2 < Beckton Cody K1 P014  
Beckton Susan R022 CQ

**BECKTON ACCENT B653 C3** BWT **94**  
Ref. A-4 Beckton Christy W779 C < BKT Clifftop TP R288  
WR **104**  
Beckton Christy S151 NB

Beckton Accent A485 C3 < Beckton Accent U777 C2  
Beckton Tamara R175 CQ

**BECKTON SIERRA C015 A** YR **103**  
Fr. **Med**  
Beckton New Era Y194  
Beckton Sierra S847 WR

DAM		RAAA HerdBuilder index: <b>203</b> (Top <b>13%</b> of RA breed)
Age	3	RAAA GridMaster index: <b>51</b> (Top <b>10%</b> of RA breed)
Wt	800	Calv.Ease BW WW YW Milk HPG Stay Maint.En.
Prog.BW	82	EPDs <b>12 1.6 67 110 22 13 18 -6.0</b>
WR	105	Marb <b>+0.32</b> REA <b>-0.03</b> Bfat <b>+0.04</b>
YR	103	
Cow Eff.	107	

★★★★★ for Low Maintenance, Marbling, Superior Cow, Calving Ease, Stayability.



Pregnant heifers on winter pasture

**325** **BECKTON ROSE F543 H**  
2 100% # 3987454 Tattoo: BKT8 F543

Birth: 3-28-18

Beckton Heritage X403 L3 < Beckton Heritage T270 J2  
Beckton Indigo H150 LN

**BECKTON HERITAGE B612 J4** BWT **60**  
Ref. H-1 Beckton Lana N291 JC < Beckton Justice G302  
WR **97**  
Beckton Lana H725 CH

Beckton Lancer T9 N586 < Beckton Lancer TA K644  
BKT Larkeisa H232 SC

**BECKTON ROSE S487 LN** YR **95**  
Fr. **Med**  
Beckton Lancer T4 J536  
Beckton Rose J152 LN

DAM		RAAA HerdBuilder index: <b>176</b> (Top <b>57%</b> of RA breed)
Age	12	RAAA GridMaster index: <b>46</b> (Top <b>88%</b> of RA breed)
Wt	930	Calv.Ease BW WW YW Milk HPG Stay Maint.En.
Prog.BW	74	EPDs <b>15 -2.9 54 77 22 12 16 -8.0</b>
WR	105	Marb <b>+0.27</b> REA <b>-0.12</b> Bfat <b>+0.04</b>
YR	101	
Cow Eff.	90	

★★★★★ for Low Maintenance, Marbling, Calving Ease, Stayability.

**323** **BECKTON INDIGO F923 E**  
1-A 100% # 3988140 Tattoo: BSF8 F923

Birth: 5-24-18

Beckton Epic Y484 N6 < Beckton Epic U749 D5  
Beckton Lydia S069 NB

**BECKTON EPIC B545 N7** BWT **91**  
Ref. E-6 Beckton Serena X338 N < Beckton Nebula T398 V3  
WR **108**  
Beckton Serena S649 LO

Beckton Jules L429 < Beckton Julian G1 J526  
Beckton Barona J591 EP

**BECKTON INDIGO W419 J** YR **108**  
Fr. **Med**  
Beckton Herald F1 L151  
Beckton Indigo LC22 LO

DAM		RAAA HerdBuilder index: <b>187</b> (Top <b>36%</b> of RA breed)
Age	9	RAAA GridMaster index: <b>51</b> (Top <b>9%</b> of RA breed)
Wt	1110	Calv.Ease BW WW YW Milk HPG Stay Maint.En.
Prog.BW	70	EPDs <b>8 1.3 67 112 23 14 18 -2.0</b>
WR	108	Marb <b>+0.27</b> REA <b>-0.01</b> Bfat <b>+0.04</b>
YR	106	
Cow Eff.	88	

★★★★★ for Low Maintenance, Growth, Marbling, Superior Cow, Calving Ease, Stayability.

**326** **BECKTON LANA F922 E**  
1-A 100% # 3988142 Tattoo: BSF8 F922

Birth: 5-23-18

Beckton Epic X464 L5 < Beckton Epic K6 S569  
Beckton Lana M393 LN

**BECKTON EPIC B310 J6** BWT **88**  
Ref. E-4 Beckton Minerva Y116 J < Beckton Julian W743 H5  
WR **104**  
Beckton Minerva W081 N

Beckton Legend S670 < Beckton Lancer F442 T  
Beckton Kit F468 JL

**BECKTON LANA X556 L** YR **102**  
Fr. **Med**  
Beckton Nebula E P084  
Beckton Lana M078 LN

DAM		RAAA HerdBuilder index: <b>197</b> (Top <b>21%</b> of RA breed)
Age	8	RAAA GridMaster index: <b>48</b> (Top <b>49%</b> of RA breed)
Wt	1065	Calv.Ease BW WW YW Milk HPG Stay Maint.En.
Prog.BW	63	EPDs <b>13 -1.3 56 84 25 15 18 -7.0</b>
WR	98	Marb <b>+0.30</b> REA <b>-0.07</b> Bfat <b>+0.02</b>
YR	97	
Cow Eff.	88	

★★★★★ for Low Maintenance, Marbling, Calving Ease, Stayability.

• Heifers •

**327** **BECKTON LANA F373 C**  
1-A 100% # 3988594 Tattoo: BSF8 F373

Birth: 3-20-18  
 Beckton Clifftop B848 J4 < Beckton Clifftop W692 E3  
**BECKTON CLIFFTOP D059 C5** < Beckton Belga S198 JL BWT **65**  
 Ref. C-3 < Beckton Larkaba B565 C < Beckton Clifftop W692 E3 WR **95**  
 < Beckton Larkaba X054 L < Beckton Julian X721 E6 YR **106**  
**BECKTON LANA D279 J** < Beckton Larkaba X064 J Fr. **Med**  
 < Beckton Julian Z382 J7 < Beckton Janus X799 L2  
 < Beckton Lana Z021 J < Beckton Lana X410 R

<b>DAM</b>	RAAA HerdBuilder index: <b>186</b> (Top <b>37%</b> of RA breed)									
Age	RAAA GridMaster index: <b>48</b> (Top <b>48%</b> of RA breed)									
Wt	2	Calv.Ease	BW	WW	YW	Milk	HPG	Stay	Maint.En.	
Prog.BW	65	EPDs	16	-2.7	52	83	26	12	17	-5.5
WR	95	Marb	+.29		REA	-.14		Bfat	+.03	
YR	106									
Cow Eff.	88									

★★★★★ for Low Maintenance, Growth, Marbling, Calving Ease, Stayability.

**329** **BECKTON LAKME F378 D**  
1-B 50% # 3987654 Tattoo: BKT8 F378

Birth: 3-20-18  
 Beckton Dominor ZC M919 < Beckton Dominor Z E401  
**BECKTON DOMINOR Z1 R610** < Beckton Barmaid J012 CO BWT **67**  
 Ref. D < Beckton Sierra K557 LO < Beckton Loki F251 WR **93**  
 < Beckton Sierra C157 CL < Beckton Epic D404 YR **91**  
**BECKTON LAKME P513 EP** < Beckton Belga D483 KR Fr. **Sma**  
 < Beckton Epic K F075 < Bkt Clifftop TV G672  
 < Beckton Lakme K697 CT < Beckton Lakme G128 HD

<b>DAM</b>	RAAA HerdBuilder index: <b>200</b> (Top <b>16%</b> of RA breed)									
Age	RAAA GridMaster index: <b>48</b> (Top <b>49%</b> of RA breed)									
Wt	14	Calv.Ease	BW	WW	YW	Milk	HPG	Stay	Maint.En.	
Prog.BW	71	EPDs	15	-3.7	44	77	25	14	18	-4.0
WR	102	Marb	+.28		REA	-.10		Bfat	+.04	
YR	102									
Cow Eff.	76									

★★★★★ for Low Maintenance, Marbling, Calving Ease, Stayability.

**328** **BECKTON TAMARA F176 E**  
1-A 100% # 3987896 Tattoo: BKT8 F176

Birth: 3-9-18  
 Beckton Epic Z674 E6 < Beckton Epic U749 D5  
**BECKTON EPIC D275 L7** < Beckton Indigo U504 EP BWT **61**  
 Ref. E-9 < Beckton Lana X839 L < Beckton Legend S670 WR **87**  
 < Beckton Lana S371 DM < Beckton Accent U777 C2 YR **98**  
**BECKTON TAMARA D073 A** < Beckton Christy W779 C Fr. **Sma**  
 < Beckton Accent B653 C3 < Beckton Julian GG B571  
 < Beckton Tamara B592 J < Beckton Tamara W232 J

<b>DAM</b>	RAAA HerdBuilder index: <b>204</b> (Top <b>12%</b> of RA breed)									
Age	RAAA GridMaster index: <b>50</b> (Top <b>16%</b> of RA breed)									
Wt	2	Calv.Ease	BW	WW	YW	Milk	HPG	Stay	Maint.En.	
Prog.BW	61	EPDs	17	-3.2	52	87	23	15	17	-8.0
WR	87	Marb	+.44		REA	-.04		Bfat	+.04	
YR	98									
Cow Eff.	80									

★★★★★ for Low Maintenance, Marbling, Calving Ease, Stayability.

**330** **BECKTON BELGA F447 N**  
1-A 100% # 3988540 Tattoo: BSF8 F447

Birth: 3-23-18  
 Beckton Nebula P P707 < Beckton Nebula M045  
**BECKTON NEBULA B557 J3** < Beckton Lana M809 EP BWT **62**  
 Ref. N-3 < Beckton Larkaba T813 JC < Beckton Justice CH M056 WR **64**  
 < Beckton Larkaba P645 JL < Beckton Emperor R100 YR **88**  
**BECKTON BELGA X736 E** < Beckton Vernice R416 EP Fr. **Sma**  
 < Beckton Emperor T641 E2 < Beckton Epic K1 K863  
 < Beckton Belga M050 EP < Beckton Belga K588 HD

<b>DAM</b>	RAAA HerdBuilder index: <b>200</b> (Top <b>16%</b> of RA breed)									
Age	RAAA GridMaster index: <b>47</b> (Top <b>79%</b> of RA breed)									
Wt	8	Calv.Ease	BW	WW	YW	Milk	HPG	Stay	Maint.En.	
Prog.BW	65	EPDs	18	-5.2	36	64	29	12	18	-9.0
WR	93	Marb	+.40		REA	-.17		Bfat	+.03	
YR	94									
Cow Eff.	56									

★★★★★ for Low Maintenance, Marbling, Calving Ease, Stayability.



**351** **PEN OF 12 COMMERCIAL HEIFERS**

This lot contains 12 high-percentage Beckton Red Angus yearling heifers

**352** **PEN OF 12 COMMERCIAL HEIFERS**

This lot contains 12 high-percentage Beckton Red Angus yearling heifers

**353** **PEN OF 12 COMMERCIAL HEIFERS**

This lot contains 12 high-percentage Beckton Red Angus yearling heifers



# Reference Sire Lot Index

Lot	ID	Lot	ID	Lot	ID	Lot	ID	Lot	ID	Lot	ID	Lot	ID
<b>Accent W180 (A-1)</b>		<b>Accent D174 (A-6)</b>		<b>Dominator C052 (D-2)</b>		<b>Epic B310 (E-4)</b>		<b>Heritage D195 (H-2)</b>		<b>Likable D432 (L-5)</b>		<b>Scamp C349 (S-2)</b>	
7.....	F407	37.....	F158	101....	F748	11.....	F351	55.....	F196	40.....	F180	85.....	F339
21.....	F116	106.....	F115	176....	F627	30.....	F385	83.....	F039	100....	F386	92.....	F651
27.....	F559	110.....	F292	<b>Dominator D254 (D-3)</b>		52.....	F162	124....	F341	104....	F026	117....	F584
59.....	F642	120.....	F118	201....	F276	169....	F718	144....	F493	145....	F081	178....	F685
159....	F778	131.....	F125	229....	F560	185....	F452	151....	F030	226....	F404	187....	F814
161....	F327	133.....	F119	<b>Epic D002 (E)</b>		194....	F618	214....	F546	<b>New Era D478 (N)</b>		192....	F740
174....	F690	215....	F472	210....	F044	212....	F579	<b>Julian A434 (J)</b>		190....	F639	195....	F645
302..	F147(H)	317..	F080(H)	<b>Epic D082 (E)</b>		228....	F524	67....	FC135	<b>Nebula P084 (N)</b>		197....	F664
304..	F215(H)	<b>Accent D326 (A-7)</b>		319..	F654(H)	316..	F432(H)	<b>Jet P491 (J)</b>		122....	F465	309..	F508(H)
<b>Accent B150 (A-2)</b>		36.....	F110	<b>Epic D344 (E)</b>		326..	F922(H)	<b>Julian D551 (J-3)</b>		<b>Nebula S347 (N)</b>		<b>Scamp D325 (S-3)</b>	
2.....	F144	39.....	F164	50.....	F151	<b>Epic B483 (E-5)</b>		116....	F526	1.....	F337	54.....	F003
3.....	F191	41.....	F042	<b>Epic M115 (E)</b>		20.....	F340	<b>Javelin 7466 (J-1)</b>		<b>Nebula P707 (N-1)</b>		76.....	F117
9.....	F392	79.....	F088	18.....	F512	91.....	F719	181....	F290	42....	FC134	102....	F150
14.....	F239	<b>Accent D806 (A-8)</b>		<b>Epic Y484 (E-1)</b>		123....	F463	203....	F709	154..	FC139	315..	F083(H)
17.....	F289	6.....	F469	128....	F736	168....	F766	<b>Julian B571 (J-2)</b>		<b>Nebula X603 (N-2)</b>		320..	F054(H)
26.....	F414	125....	F587	162....	F313	193....	F636	313..	F431(H)	156....	F699	<b>Scamp D739 (S-4)</b>	
45.....	F411	<b>Roosevelt D391 (B)</b>		198....	F799	206....	F264	<b>Julian D551 (J-3)</b>		167....	F782	209....	F291
49.....	F140	224....	F595	<b>Epic Z674 (E-2)</b>		208....	F510	38.....	F428	170....	F771	312..	F178(H)
87.....	F208	<b>Hughes D589 (B-1)</b>		19.....	F156	<b>Epic B545 (E-6)</b>		96.....	F633	<b>Nebula B557 (N-3)</b>		321..	F413(H)
97.....	F836	35.....	F082	24.....	F204	48.....	F460	<b>Likable C643 (L)</b>		15.....	F458	<b>Nomad 7496 (V)</b>	
114....	F634	107....	F097	46.....	F294	60.....	F635	80.....	F361	69.....	F571	<b>Nomad 9871 (V)</b>	
129....	F555	109....	F064	57.....	F430	65.....	F376	<b>Likable Z057 (L-1)</b>		82.....	F369	86.....	F443
138....	F384	147....	F396	58.....	F733	230....	F454	4.....	F425	119....	F516	<b>Warrior C237 (W)</b>	
175....	F793	148....	F135	64.....	F796	323..	F923(H)	25.....	F293	143....	F489	<b>Warrior D359 (W-1)</b>	
177....	F652	216....	F308	90.....	F726	<b>Epic D001 (E-7)</b>		29.....	F482	330..	F447(H)	98.....	F804
303..	F353(H)	227....	F218	99.....	F629	66.....	F008	33.....	F317	<b>Ranger B003 (R-1)</b>		<b>Warrior Y108 (W-2)</b>	
<b>Accent B549 (A-3)</b>		<b>Dbl Eagle ZT220 (C-1)</b>		115....	F358	72.....	F001	68.....	F541	16.....	F415	22.....	F029
12.....	F691	77.....	F419	132....	F256	<b>Epic D110 (E-8)</b>		84.....	F198	70.....	F235	31.....	F017
56.....	F216	81.....	F195	164....	F775	153....	F057	112....	F598	199....	F582	204....	F202
71.....	F347	89.....	F538	211....	F401	217....	F041	134....	F763	200....	F370	157....	F589
73.....	F574	105....	F210	222....	F522	<b>Epic D275 (E-9)</b>		137....	F567	307..	F286(H)	228....	F524
103....	F646	<b>Cardinal D010 (C-2)</b>		225....	F596	111....	F079	152....	F494	310..	F527(H)	<b>Warrior D065 (S)</b>	
179....	F739	47.....	F012	322..	F565(H)	126....	F090	157....	F589	<b>Scamp D065 (S)</b>		17.....	F289
189....	F703	74.....	F137	<b>Epic A286 (E-3)</b>		218....	F284	171....	F783	158....	F091	47.....	F012
213....	F372	88.....	F015	5.....	F228	328..	F176(H)	184....	F606	314..	F128(H)	58.....	F733
<b>Accent B653 (A-4)</b>		139....	F022	10.....	F374	<b>Epic D454 (E-10)</b>		188....	F727	<b>Scamp B720 (S-1)</b>		128....	F736
13.....	F436	207....	F108	95.....	F769	135....	F388	<b>Likable B032 (J-2)</b>		43.....	F255	213....	F372
34.....	F173	220....	F148	113....	F365	191....	F698	28.....	F506	44.....	F632	223....	F338
51.....	F136	<b>Clifftop D059 (C-3)</b>		140....	F315	<b>Epic D457 (E-11)</b>		53.....	F641	61.....	F607	313..	F431(H)
93.....	F655	155....	F488	172....	F761	150....	F186	118....	F492	63.....	F702	325..	F543(H)
108....	F724	165....	F329	186....	F788	231....	F272	182....	F658	130....	F619	<b>Scamp D065 (S)</b>	
136....	F747	327..	F373(H)	<b>Epic D457 (E-11)</b>		<b>Heritage B612 (H-1)</b>		301..	F274(H)	163....	F743	<b>Scamp B720 (S-1)</b>	
166....	F583	<b>Dominator R610 (D)</b>		75.....	F406	44.....	F641	311..	F318(H)	173....	F712	43.....	F255
305..	F542(H)	329..	F378(H)	78.....	F325	53.....	F641	<b>Likable B509 (L-3)</b>		180....	F346	44.....	F632
324..	F912(H)	<b>Dominator Y052 (D)</b>		121....	F558	94.....	F802	28.....	F506	202....	F716	61.....	F607
<b>Accent D115 (A-5)</b>		62.....	F692	160....	F720	118....	F492	53.....	F641	223....	F338	63.....	F702
8.....	F283	<b>Dominator A378 (D-1)</b>		183....	F656	182....	F658	118....	F492	318..	F185(H)	130....	F619
146....	F103	23.....	F371	221....	F206	301..	F274(H)	182....	F658	<b>Scamp D065 (S)</b>		163....	F743
219....	F416	149....	F381	325..	F543(H)	311..	F318(H)	301..	F274(H)	<b>Scamp B720 (S-1)</b>		173....	F712
306..	F034(H)	<b>Epic D063 (L-4)</b>		<b>Heritage B612 (H-1)</b>		<b>Likable B509 (L-3)</b>		311..	F318(H)	43.....	F255	180....	F346
<b>Accent D115 (A-5)</b>		127....	F078	75.....	F406	32.....	F197	<b>Likable B509 (L-3)</b>		180....	F346	202....	F716
8.....	F283	142....	F036	78.....	F325	94.....	F802	<b>Likable D063 (L-4)</b>		223....	F338	223....	F338
146....	F103	205....	F165	121....	F558	141....	F612	<b>Likable D063 (L-4)</b>		318..	F185(H)	313..	F431(H)
219....	F416	<b>Likable D063 (L-4)</b>		160....	F720	142....	F036	28.....	F506	<b>Scamp B720 (S-1)</b>		325..	F543(H)
306..	F034(H)	127....	F078	183....	F656	142....	F036	53.....	F641	<b>Scamp B720 (S-1)</b>		<b>Warrior Y108 (W-2)</b>	
<b>Accent D115 (A-5)</b>		127....	F078	221....	F206	205....	F165	118....	F492	43.....	F255	17.....	F289
8.....	F283	<b>Likable D063 (L-4)</b>		325..	F543(H)	<b>Likable B509 (L-3)</b>		182....	F658	44.....	F632	47.....	F012
146....	F103	127....	F078	<b>Heritage B612 (H-1)</b>		<b>Likable B509 (L-3)</b>		301..	F274(H)	61.....	F607	58.....	F733
219....	F416	127....	F078	75.....	F406	32.....	F197	311..	F318(H)	63.....	F702	128....	F736
306..	F034(H)	142....	F036	78.....	F325	94.....	F802	311..	F318(H)	130....	F619	213....	F372
<b>Accent D115 (A-5)</b>		142....	F036	121....	F558	141....	F612	<b>Likable B509 (L-3)</b>		163....	F743	223....	F338
8.....	F283	142....	F036	160....	F720	141....	F612	<b>Likable B509 (L-3)</b>		173....	F712	313..	F431(H)
146....	F103	142....	F036	183....	F656	142....	F036	<b>Likable B509 (L-3)</b>		180....	F346	325..	F543(H)
219....	F416	142....	F036	221....	F206	205....	F165	<b>Likable B509 (L-3)</b>		202....	F716	<b>Warrior D065 (S)</b>	
306..	F034(H)	142....	F036	325..	F543(H)	<b>Likable B509 (L-3)</b>		28.....	F506	223....	F338	<b>Warrior Y108 (W-2)</b>	
<b>Accent D115 (A-5)</b>		142....	F036	<b>Heritage B612 (H-1)</b>		<b>Likable B509 (L-3)</b>		53.....	F641	318..	F185(H)	<b>Warrior D065 (S)</b>	
8.....	F283	142....	F036	75.....	F406	32.....	F197	118....	F492	<b>Scamp D065 (S)</b>		17.....	F289
146....	F103	142....	F036	78.....	F325	94.....	F802	182....	F658	<b>Scamp B720 (S-1)</b>		47.....	F012
219....	F416	142....	F036	121....	F558	141....	F612	301..	F274(H)	<b>Scamp B720 (S-1)</b>		58.....	F733
306..	F034(H)	142....	F036	160....	F720	142....	F036	311..	F318(H)	<b>Scamp B720 (S-1)</b>		128....	F736
<b>Accent D115 (A-5)</b>		142....	F036	183....	F656	142....	F036	311..	F318(H)	<b>Scamp B720 (S-1)</b>		213....	F372
8.....	F283	142....	F036	221....	F206	205....	F165	311..	F318(H)	<b>Scamp B720 (S-1)</b>		223....	F338
146....	F103	142....	F036	325..	F543(H)	<b>Likable B509 (L-3)</b>		311..	F318(H)	<b>Scamp B720 (S-1)</b>		313..	F431(H)
219....	F416	142....	F036	<b>Heritage B612 (H-1)</b>		<b>Likable B509 (L-3)</b>		311..	F318(H)	<b>Scamp B720 (S-1)</b>		325..	F543(H)
306..	F034(H)	142....	F036	75.....	F406	32.....	F197	<b>Likable B509 (L-3)</b>		<b>Scamp B720 (S-1)</b>		<b>Warrior Y108 (W-2)</b>	
<b>Accent D115 (A-5)</b>		142....	F036	78.....	F325	94.....	F802	<b>Likable B509 (L-3)</b>		<b>Scamp B720 (S-1)</b>		17.....	F289
8.....	F283	142....	F036	121....	F558	141....	F612	<b>Likable B509 (L-3)</b>		<b>Scamp B720 (S-1)</b>		47.....	F012
146....	F103	142....	F036	160....	F720	142....	F036	<b>Likable B509 (L-3)</b>		<b>Scamp B720 (S-1)</b>		58.....	F733
219....	F416	142....	F036	183....	F656	142....	F036	<b>Likable B509 (L-3)</b>		<b>Scamp B720 (S-1)</b>		128....	F736
306..	F034(H)	142....	F036	221....	F206	205....	F165	<b>Likable B509 (L-3)</b>		<b>Scamp B720 (S-1)</b>		213....	F372

# Reference Sires

The goal for Beckton's program has always been to develop breeding seedstock which offer increased levels of performance for the commercial cattleman. Increased performance does not mean maximizing weight and size, which have already reached the upper limit of economic

value for the packer and consumer. It does, however, mean increasing performance related to calving percentage and weaning percentage; and increasing performance related to cow maintenance requirements and "pounds of calf per acre" efficiency.



***Beckton Julian B571 (Ref. Sire J-2)***

• Reference Sires •

**A-1 BECKTON ACCENT W180 C2**  
1-A 100% # 1331776 Tattoo: BKB9 W180

Birth: 3-12-09	Beckton Cody KH M390	Beckton Cody K G701	BWt <b>77</b>
	Beckton Rose M126 WR	Beckton Tamara J124 HR	WR <b>116</b>
<b>BECKTON CODY K1 P014</b>	Beckton Warrior T C371	Beckton Rose D741 LN	ADG <b>4.23</b>
Ref. A	Beckton Cherokee N N479	BFCCK Cherokee Cnyn 4912	YR <b>114</b>
	Beckton Christy N740 HR	Beckton Dinah C440 NM	Scr. <b>39</b>
<b>BECKTON CHRISTY R046 CQ</b>	Beckton Herald FJ J776	Beckton Christy K141 VG	Fr. <b>5.5</b>

RAAA HerdBuilder index: **245** (Top 2% of RA breed)  
RAAA GridMaster index: **49** (Top 40% of RA breed)

Calv.Ease	BW	WW	YW	Milk	HPG	Stay	Maint.En.
EPDs <b>19</b>	<b>-4.2</b>	<b>61</b>	<b>99</b>	<b>27</b>	<b>9</b>	<b>23</b>	<b>0.0</b>
Acc. (.58)	(.84)	(.80)	(.80)	(.64)	(.37)	(.38)	(.63)
Marb <b>+.28</b>	(.43)	REA <b>+.16</b>	(.49)	Bfat <b>+.03</b>	(.32)		

**DAM**

Age	4
Wt	1140
Wean Pct.	57%
Cow Eff.	121

★★★★★ for Low Maintenance, Growth, Gainability, Marbling, Rib-eye area, High Cow Efficiency, Calving Ease, Stayability.

**A-3 BECKTON ACCENT B549 N3**  
1-A 100% # 1705673 Tattoo: BKB4 B549

Birth: 3-31-14	Beckton Cody K1 P014	Beckton Cody KH M390	BWt <b>75</b>
	Beckton Christy R046 CQ	Beckton Rose M126 WR	WR <b>119</b>
<b>BECKTON ACCENT W180 C2</b>	Beckton Cherokee N N479	Beckton Christy N740 HR	ADG <b>4.77</b>
Ref. A-1	Beckton Nebula T398 V3	Beckton Nebula L P093	YR <b>122</b>
	Beckton Minerva M369 LO	Beckton Minerva J615 VG	Scr. <b>39</b>
<b>BECKTON MINERVA Y654 N</b>	Beckton Loki F251	Beckton Minerva H403 LN	Fr. <b>6.0</b>

RAAA HerdBuilder index: **252** (Top 1% of RA breed)  
RAAA GridMaster index: **53** (Top 4% of RA breed)

Calv.Ease	BW	WW	YW	Milk	HPG	Stay	Maint.En.
EPDs <b>14</b>	<b>-1.2</b>	<b>69</b>	<b>120</b>	<b>26</b>	<b>11</b>	<b>23</b>	<b>-1.0</b>
Acc. (.26)	(.62)	(.55)	(.53)	(.31)	(.08)	(.19)	(.04)
Marb <b>+.35</b>	(.26)	REA <b>+.29</b>	(.33)	Bfat <b>+.04</b>	(.20)		

**DAM**

Age	3
Wt	1046
Wean Pct.	54%
Cow Eff.	114

★★★★★ for Low Maintenance, Growth, Gainability, Marbling, Rib-eye area, Calving Ease, Stayability.

**A-4 BECKTON ACCENT B653 C3**  
1-A 100% # 1705555 Tattoo: BSF4 B653

Birth: 4-8-14	Beckton Cody K1 P014	Beckton Cody KH M390	BWt <b>77</b>
	Beckton Susan R022 CQ	Beckton Rose M126 WR	WR <b>108</b>
<b>BECKTON ACCENT U777 C2</b>	Beckton Cherokee N N479	Beckton Susan N023 JE	ADG <b>3.98</b>
Ref. A	BKT Clifftop TP R288	Beckton Clifftop T C075	YR <b>108</b>
	Beckton Christy S151 NB	Beckton Christy K209 CO	Scr. <b>39</b>
<b>BECKTON CHRISTY W779 C</b>	Beckton Nebula E P084	Beckton Christy P333 CH	Fr. <b>5.5</b>

RAAA HerdBuilder index: **210** (Top 17% of RA breed)  
RAAA GridMaster index: **48** (Top 59% of RA breed)

Calv.Ease	BW	WW	YW	Milk	HPG	Stay	Maint.En.
EPDs <b>18</b>	<b>-2.3</b>	<b>56</b>	<b>92</b>	<b>24</b>	<b>13</b>	<b>18</b>	<b>-8.0</b>
Acc. (.40)	(.65)	(.60)	(.58)	(.39)	(.09)	(.19)	(.19)
Marb <b>+.24</b>	(.23)	REA <b>-.05</b>	(.34)	Bfat <b>+.04</b>	(.19)		

**DAM**

Age	5
Wt	1040
Wean Pct.	58%
Cow Eff.	123

★★★★★ for Low Maintenance, Growth, Marbling, High Cow Efficiency, Calving Ease, Stayability.

**A-2 BECKTON ACCENT B150 N4**  
1-A 100% # 1705827 Tattoo: BKT4 B150

Birth: 3-6-14	Beckton Accent W180 C2	Beckton Cody K1 P014	BWt <b>70</b>
	Beckton Lana W463 L	Beckton Christy R046 CQ	WR <b>102</b>
<b>BECKTON ACCENT Y260 L3</b>	Beckton Nebula P P707	Beckton Loki CL S284	ADG <b>3.86</b>
Ref. A	Beckton Larkeisa P688 CH	Beckton Lana R327 EP	YR <b>103</b>
	BKT Larkeisa J564 HR	Beckton Nebula M045	Scr. <b>38</b>
<b>BKT LARKEISA S055 NB</b>	Beckton Champ R3 H338	Beckton Lana M809 EP	Fr. <b>5.0</b>

RAAA HerdBuilder index: **206** (Top 20% of RA breed)  
RAAA GridMaster index: **49** (Top 47% of RA breed)

Calv.Ease	BW	WW	YW	Milk	HPG	Stay	Maint.En.
EPDs <b>16</b>	<b>-3.1</b>	<b>57</b>	<b>92</b>	<b>26</b>	<b>11</b>	<b>19</b>	<b>-4.0</b>
Acc. (.28)	(.66)	(.61)	(.54)	(.30)	(.16)	(.17)	(.04)
Marb <b>+.45</b>	(.22)	REA <b>-.27</b>	(.31)	Bfat <b>+.06</b>	(.20)		

**DAM**

Age	8
Wt	1144
Wean Pct.	47%
Cow Eff.	98

★★★★★ for Low Maintenance, Marbling, Calving Ease, Stayability.



Accent B150 (A-2)



• Reference Sires •

### A-5 BECKTON ACCENT D115 N3

1-A 100% # 3551780 Tattoo: BKT6 D115

Birth: 2-27-16

Beckton Cody K1 P014 < Beckton Cody KH M390  
Beckton Rose M126 WR

**BECKTON ACCENT W180 C2**  
Ref. A-1 < Beckton Cherokee N N479  
Beckton Christy R046 CQ < Beckton Christy N740 HR

Beckton Nebula EN S347 < Beckton Nebula E P084  
Beckton Eola P530 NB

**BECKTON LARKABA W272 N**  
Beckton Larkaba N643 HR < Beckton Herald FJ J776  
Beckton Larkaba J765 CH

BWt	64
WR	104
ADG	3.83
YR	106
Scr.	37
Fr.	5.0

RAAA HerdBuilder index: **251** (Top 1% of RA breed)  
RAAA GridMaster index: **50** (Top 23% of RA breed)

DAM	Age	Wt	Wean Pct.	Cow Eff.
7	945	61%	128	

Calv.Ease	BW	WW	YW	Milk	HPG	Stay	Maint.En.	
EPDs	20	-5.3	58	96	31	15	22	-6.0
Acc.	(.26)	(.54)	(.47)	(.46)	(.27)	(.08)	(.18)	(.18)

Marb **+0.30** (.22) REA **-0.01** (.29) Bfat **+0.04** (.19)

★★★★★ for Low Maintenance, Growth, Marbling, High Cow Efficiency, Calving Ease, Stayability.

### A-8 BECKTON ACCENT D806 W3

1-A 100% # 3551568 Tattoo: BKT6 D806

Birth: 4-23-16

Beckton Cody K1 P014 < Beckton Cody KH M390  
Beckton Rose M126 WR

**BECKTON ACCENT W180 C2**  
Ref. A-1 < Beckton Cherokee N N479  
Beckton Christy R046 CQ < Beckton Christy N740 HR

Beckton Warrior W534 N4 < Beckton Warrior C1 S337  
BKT Larkeisa S055 NB

**BECKTON COCA A907 W**  
Beckton Coca U561 CT < Beckton Clifftop T3 N800  
Beckton Coca P328 EP

BWt	74
WR	105
ADG	5
YR	120
Scr.	NA
Fr.	5.5

RAAA HerdBuilder index: **210** (Top 7% of RA breed)  
RAAA GridMaster index: **50** (Top 18% of RA breed)

DAM	Age	Wt	Wean Pct.	Cow Eff.
3	850	60%	127	

Calv.Ease	BW	WW	YW	Milk	HPG	Stay	Maint.En.	
EPDs	17	-3.4	58	97	26	9	19	-4.0
Acc.	(.23)	(.42)	(.37)	(.36)	(.23)	(.08)	(.20)	(.04)

Marb **+0.27** (.22) REA **+0.15** (.27) Bfat **+0.04** (.20)

★★★★★ for Low Maintenance, Growth, Gainability, Marbling, Rib-eye area, High Cow Efficiency, Calving Ease, Stayability.

### A-6 BECKTON ACCENT D174 N3

1-A 100% # 3551707 Tattoo: BKT6 D174

Birth: 3-7-16

Beckton Cody K1 P014 < Beckton Cody KH M390  
Beckton Rose M126 WR

**BECKTON ACCENT U777 C2**  
Ref. A < Beckton Cherokee N N479  
Beckton Susan R022 CQ < Beckton Susan N023 JE

Beckton Nebula P P707 < Beckton Nebula M045  
Beckton Lana M809 EP

**BKT LARKEISA S055 NB**  
Beckton Larkeisa P688 CH < Beckton Champ R3 H338  
BKT Larkeisa J564 HR

BWt	66
WR	112
ADG	3.72
YR	110
Scr.	40
Fr.	5.5

RAAA HerdBuilder index: **214** (Top 4% of RA breed)  
RAAA GridMaster index: **49** (Top 41% of RA breed)

DAM	Age	Wt	Wean Pct.	Cow Eff.
10	1055	58%	122	

Calv.Ease	BW	WW	YW	Milk	HPG	Stay	Maint.En.	
EPDs	19	-4.8	58	94	25	11	19	-7.0
Acc.	(.29)	(.54)	(.48)	(.47)	(.28)	(.19)	(.20)	(.19)

Marb **+0.37** (.26) REA **-0.07** (.30) Bfat **+0.06** (.21)

★★★★★ for Low Maintenance, Growth, Marbling, High Cow Efficiency, Calving Ease, Stayability.

### B-1 BECKTON HUGHES D589 S2

1-A 100% # 3551912 Tattoo: BKT6 D589

Birth: 3-31-16

Basin Hobo 0545 < Basin Hobo 79E  
Basin Erica 330E

**BIEBER H HUGHES W109**  
Ref. B < Red Brylor New Trend 22  
Basin Rose 06T0 < Basin Rose F521

Beckton Scamp X494 E3 < Beckton Scamp T A825  
Beckton Lana S074 EP

**BECKTON SIERRA Z353 S**  
Beckton Sierra X555 N < Beckton Nebula PJ S543  
Beckton Sierra S639 JO

BWt	88
WR	117
ADG	4
YR	111
Scr.	36
Fr.	6.0

RAAA HerdBuilder index: **192** (Top 24% of RA breed)  
RAAA GridMaster index: **47** (Top 74% of RA breed)

DAM	Age	Wt	Wean Pct.	Cow Eff.
4	1095	56%	118	

Calv.Ease	BW	WW	YW	Milk	HPG	Stay	Maint.En.	
EPDs	17	-4.0	59	89	26	17	16	-6.0
Acc.	(.24)	(.48)	(.42)	(.41)	(.23)	(.12)	(.17)	(.04)

Marb **+0.32** (.23) REA **-0.02** (.27) Bfat **+0.04** (.19)

★★★★★ for Low Maintenance, Growth, Marbling, High Cow Efficiency, Calving Ease, Stayability.

### A-7 BECKTON ACCENT D326 N4

1-A 100% # 3551708 Tattoo: BKT6 D326

Birth: 3-19-16

Beckton Accent W180 C2 < Beckton Cody K1 P014  
Beckton Christy R046 CQ

**BECKTON ACCENT Y260 L3**  
Ref. A < Beckton Loki CL S284  
Beckton Lana W463 L < Beckton Lana R327 EP

Beckton Nebula P P707 < Beckton Nebula M045  
Beckton Lana M809 EP

**BECKTON LYDIA S069 NB**  
Beckton Lydia P583 WR < Beckton Warrior CL M686  
Beckton Lydia M121 WR

BWt	77
WR	111
ADG	4.22
YR	111
Scr.	39
Fr.	5.5

RAAA HerdBuilder index: **212** (Top 5% of RA breed)  
RAAA GridMaster index: **49** (Top 26% of RA breed)

DAM	Age	Wt	Wean Pct.	Cow Eff.
10	1005	60%	126	

Calv.Ease	BW	WW	YW	Milk	HPG	Stay	Maint.En.	
EPDs	14	-2.6	59	99	28	10	20	-4.0
Acc.	(.26)	(.47)	(.43)	(.42)	(.26)	(.16)	(.16)	(.04)

Marb **+0.38** (.22) REA **-0.06** (.29) Bfat **+0.04** (.20)

★★★★★ for Low Maintenance, Growth, Gainability, Marbling, High Cow Efficiency, Calving Ease, Stayability.

### C-1 TR DOUBLE EAGLE ZT220

1-A 100% # 1519714 Tattoo: BKB2 ZT220

Birth: 3-20-12

BFCK Cherokee Cnyn 4912 < Buf Crk Chf 824-1658  
MRM 1431 8611 9109

**TR RICARDO DOS**  
Ref. < Beckton Julian GG B571  
TR Dyna LT111 < BSF Dyna JT976

Beckton Justice C1 R483 < Beckton Justice CH M056  
Beckton Tamara J124 HR

**BECKTON LANA U182 JC**  
Beckton Lana H544 WR < Beckton Warrior TC E801  
Beckton Lana E545 CL

BWt	76
WR	124
ADG	2.97
YR	117
Scr.	NA
Fr.	4.5

RAAA HerdBuilder index: **182** (Top 52% of RA breed)  
RAAA GridMaster index: **48** (Top 57% of RA breed)

DAM	Age	Wt	Wean Pct.	Cow Eff.
4	NA	NA%	NA	

Calv.Ease	BW	WW	YW	Milk	HPG	Stay	Maint.En.	
EPDs	20	-4.4	55	87	23	12	15	-7.0
Acc.	(.44)	(.70)	(.65)	(.65)	(.42)	(.16)	(.15)	(.19)

Marb **+0.39** (.25) REA **+0.18** (.37) Bfat **+0.03** (.23)

★★★★★ for Low Maintenance, Growth, Marbling, Rib-eye area, Calving Ease, Stayability.

• Reference Sires •



Dominor A378 (D-1)

**D-1 BECKTON DOMINOR A378 W7**  
1-A 100% # 1626650 Tattoo: BKT3 A378

Birth: 3-26-13	Beckton Dominor W640 C5	Beckton Dominor Z1 R610	BWt <b>64</b>
		Beckton Mona R166 CQ	WR <b>100</b>
<b>BECKTON DOMINOR Y005 V6</b>	Ref. D	Beckton Vega P079	ADG <b>3.43</b>
	Beckton Belga W108 V	Beckton Belga K476 JL	YR <b>104</b>
	Beckton Warrior T248 L5	Beckton Warrior N645 T1	Scr. <b>34</b>
<b>BECKTON LANA Y541 W</b>		Beckton Kit R503 LN	Fr. <b>5.5</b>
	Beckton Lana S074 EP	Beckton Epic KH P678	
		Beckton Lana P317 JL	

RAAA HerdBuilder index: **209** (Top **18%** of RA breed)

RAAA GridMaster index: **52** (Top **10%** of RA breed)

<b>DAM</b>	Calv.Ease	BW	WW	YW	Milk	HPG	Stay	Maint.En.
Age <b>2</b>	EPDs <b>21</b>	<b>-3.4</b>	<b>50</b>	<b>88</b>	<b>29</b>	<b>15</b>	<b>15</b>	<b>-3.0</b>
Wt <b>885</b>	Acc. (.43)	(.71)	(.66)	(.66)	(.43)	(.14)	(.14)	(.10)
Wean Pct. <b>50%</b>								
Cow Eff. <b>106</b>	Marb <b>+.52</b>	(.34)	REA <b>+.16</b>	(.38)	Bfat <b>+.05</b>	(.22)		

★★★★★ for Low Maintenance, Marbling, Rib-eye area, Calving Ease, Stayability.

**C-2 BECKTON CARDINAL D010 W2**  
1-A 100% # 3551012 Tattoo: BSF6 D010

Birth: 2-10-16	TR Double Eagle ZT220	TR Ricardo DOS	BWt <b>54</b>
		Beckton Lana U182 JC	WR <b>101</b>
<b>BECKTON CARDINAL B074 N</b>	Ref. C	Beckton Nebula J R475	ADG <b>4.10</b>
	BKT Pine Marie Z250 N	BKT Pine Marie U621 NB	YR <b>106</b>
	Beckton Warrior Z936 N6	Beckton Warrior T248 L5	Scr. <b>35</b>
<b>BECKTON FIREFLY B052 W</b>		Beckton Freyja W462 N	Fr. <b>5.0</b>
	Beckton Firefly Z663 N	Beckton Nebula U206 V3	
		Beckton Firefly W750 J	

RAAA HerdBuilder index: **202** (Top **12%** of RA breed)

RAAA GridMaster index: **50** (Top **23%** of RA breed)

<b>DAM</b>	Calv.Ease	BW	WW	YW	Milk	HPG	Stay	Maint.En.
Age <b>2</b>	EPDs <b>19</b>	<b>-7.8</b>	<b>44</b>	<b>79</b>	<b>27</b>	<b>14</b>	<b>17</b>	<b>-5.0</b>
Wt <b>800</b>	Acc. (.26)	(.52)	(.44)	(.42)	(.20)	(.03)	(.11)	(.06)
Wean Pct. <b>50%</b>								
Cow Eff. <b>106</b>	Marb <b>+.41</b>	(.19)	REA <b>-.08</b>	(.25)	Bfat <b>+.03</b>	(.16)		

★★★★★ for Low Maintenance, Growth, Gainability, Marbling, Calving Ease, Stayability.

**D-2 BECKTON DOMINOR C052 E8**  
1-A 100% # 3487512 Tattoo: BKT5 C052

Birth: 2-23-15	Beckton Dominor Y005 V6	Beckton Dominor W640 C5	BWt <b>70</b>
		Beckton Belga W108 V	WR <b>107</b>
<b>BECKTON DOMINOR A378 W7</b>	Ref. D-1	Beckton Warrior T248 L5	ADG <b>4.43</b>
	Beckton Lana Y541 W	Beckton Lana S074 EP	YR <b>116</b>
	Beckton Epic T330 L5	Beckton Epic K4 N795	Scr. <b>38</b>
<b>BECKTON SCARLETT A406 E</b>		Beckton Belga K202 LN	Fr. <b>5.0</b>
	Beckton Scarlett W497 J	Beckton Jet L P491	
		Beckton Scarlett R808 NB	

RAAA HerdBuilder index: **188** (Top **44%** of RA breed)

RAAA GridMaster index: **51** (Top **23%** of RA breed)

<b>DAM</b>	Calv.Ease	BW	WW	YW	Milk	HPG	Stay	Maint.En.
Age <b>2</b>	EPDs <b>17</b>	<b>-2.5</b>	<b>49</b>	<b>87</b>	<b>29</b>	<b>12</b>	<b>15</b>	<b>-4.0</b>
Wt <b>NA</b>	Acc. (.32)	(.56)	(.51)	(.51)	(.28)	(.06)	(.12)	(.02)
Wean Pct. <b>NA%</b>								
Cow Eff. <b>NA</b>	Marb <b>+.45</b>	(.21)	REA <b>-.10</b>	(.30)	Bfat <b>+.05</b>	(.16)		

★★★★★ for Low Maintenance, Growth, Gainability, Marbling, Calving Ease, Stayability.

**C-3 BECKTON CLIFFTOP D059 C5**  
1-A 100% # 3551638 Tattoo: BKT6 D059

Birth: 2-19-16	Beckton Clifftop W692 E3	BKT Clifftop TP R288	BWt <b>76</b>
		Beckton Lydia S274 EP	WR <b>106</b>
<b>BECKTON CLIFFTOP B848 J4</b>	Ref. C	Beckton Julian G3 P608	ADG <b>3.82</b>
	Beckton Belga S198 JL	Beckton Belga P431 HR	YR <b>105</b>
	Beckton Clifftop W692 E3	BKT Clifftop TP R288	Scr. <b>33</b>
<b>BECKTON LARKABA B565 C</b>		Beckton Lydia S274 EP	Fr. <b>5.0</b>
	Beckton Larkaba X054 L	Beckton Likable U120 L2	
		Beckton Larkaba U153 LE	

RAAA HerdBuilder index: **185** (Top **34%** of RA breed)

RAAA GridMaster index: **49** (Top **26%** of RA breed)

<b>DAM</b>	Calv.Ease	BW	WW	YW	Milk	HPG	Stay	Maint.En.
Age <b>2</b>	EPDs <b>14</b>	<b>-0.7</b>	<b>55</b>	<b>87</b>	<b>26</b>	<b>13</b>	<b>17</b>	<b>-6.0</b>
Wt <b>770</b>	Acc. (.22)	(.51)	(.45)	(.44)	(.23)	(.07)	(.10)	(.06)
Wean Pct. <b>56%</b>								
Cow Eff. <b>118</b>	Marb <b>+.36</b>	(.21)	REA <b>-.15</b>	(.26)	Bfat <b>+.03</b>	(.19)		

★★★★★ for Low Maintenance, Growth, Marbling, High Cow Efficiency, Calving Ease, Stayability.

**D-3 BECKTON DOMINOR D254 N8**  
1-A 100% # 3551799 Tattoo: BKT6 D254

Birth: 3-15-16	Beckton Dominor Y005 V6	Beckton Dominor W640 C5	BWt <b>67</b>
		Beckton Belga W108 V	WR <b>101</b>
<b>BECKTON DOMINOR A378 W7</b>	Ref. D-1	Beckton Warrior T248 L5	ADG <b>4.72</b>
	Beckton Lana Y541 W	Beckton Lana S074 EP	YR <b>110</b>
	Beckton Nebula T398 V3	Beckton Nebula L P093	Scr. <b>41</b>
<b>BECKTON INDIGO W772 N</b>		Beckton Minerva J615 VG	Fr. <b>5.5</b>
	Beckton Indigo T613 JT	TR Julian LT151	
		Beckton Indigo N467 LO	

RAAA HerdBuilder index: **240** (Top **1%** of RA breed)

RAAA GridMaster index: **52** (Top **3%** of RA breed)

<b>DAM</b>	Calv.Ease	BW	WW	YW	Milk	HPG	Stay	Maint.En.
Age <b>7</b>	EPDs <b>19</b>	<b>-3.8</b>	<b>54</b>	<b>98</b>	<b>29</b>	<b>14</b>	<b>20</b>	<b>-2.0</b>
Wt <b>1090</b>	Acc. (.25)	(.52)	(.43)	(.43)	(.24)	(.08)	(.13)	(.11)
Wean Pct. <b>50%</b>								
Cow Eff. <b>106</b>	Marb <b>+.39</b>	(.22)	REA <b>+.15</b>	(.27)	Bfat <b>+.05</b>	(.18)		

★★★★★ for Low Maintenance, Growth, Gainability, Marbling, Rib-eye area, Calving Ease, Stayability.

• Reference Sires •



Epic N795 (grandsire to E-1, E-2, and E-5)

**E-3** **BECKTON EPIC A286 E7**  
1-A 100% # 1626664 Tattoo: BKT3 A286

Birth: 3-22-13	Beckton Epic U749 D5	Beckton Epic K4 N795	BWt <b>60</b>
		Beckton Denise R308 DM	WR <b>98</b>
<b>BECKTON EPIC Y484 N6</b>	Ref. E-1	Beckton Nebula P P707	ADG <b>3.82</b>
	Beckton Lydia S069 NB	Beckton Lydia P583 WR	YR <b>101</b>
		Beckton Epic K4 N795	Scr. <b>35</b>
<b>BECKTON LARKABA Y648 E</b>		Beckton Denise R308 DM	Fr. <b>5.0</b>
	Beckton Epic U749 D5	BKT Clifftop TP R288	
	Beckton Larkaba U475 CT	Beckton Larkaba R809 NB	

RAAA HerdBuilder index: **208** (Top **19%** of RA breed)

RAAA GridMaster index: **50** (Top **31%** of RA breed)

<b>DAM</b>	Calv.Ease	BW	WW	YW	Milk	HPG	Stay	Maint.En.
Age <b>2</b>	EPDs <b>20</b>	<b>-6.6</b>	<b>47</b>	<b>87</b>	<b>26</b>	<b>11</b>	<b>17</b>	<b>-3.0</b>
Wt <b>790</b>	Acc. (.42)	(.68)	(.64)	(.63)	(.43)	(.11)	(.15)	(.14)
Wean Pct. <b>55%</b>								
Cow Eff. <b>116</b>	Marb <b>+.35</b>	(.31)	REA <b>-.10</b>	(.37)	Bfat <b>+.06</b>	(.26)		

★★★★★ for Low Maintenance, Marbling, High Cow Efficiency, Calving Ease, Stayability.

**E-1** **BECKTON EPIC Y484 N6**  
1-A 100% # 1451237 Tattoo: BKT1 Y484

Birth: 4-8-11	Beckton Epic K4 N795	Beckton Epic KJ J722	BWt <b>77</b>
		Beckton Sierra J789 EP	WR <b>116</b>
<b>BECKTON EPIC U749 D5</b>	Ref. E	Beckton Dominor ZC M919	ADG <b>3.60</b>
	Beckton Denise R308 DM	Beckton Denise L639 JL	YR <b>116</b>
		Beckton Nebula M045	Scr. <b>38</b>
<b>BECKTON LYDIA S069 NB</b>		Beckton Lana M809 EP	Fr. <b>5.5</b>
	Beckton Nebula P P707	Beckton Warrior CL M686	
	Beckton Lydia P583 WR	Beckton Lydia M121 WR	

RAAA HerdBuilder index: **181** (Top **54%** of RA breed)

RAAA GridMaster index: **51** (Top **14%** of RA breed)

<b>DAM</b>	Calv.Ease	BW	WW	YW	Milk	HPG	Stay	Maint.En.
Age <b>5</b>	EPDs <b>11</b>	<b>-0.5</b>	<b>63</b>	<b>114</b>	<b>22</b>	<b>9</b>	<b>17</b>	<b>-1.0</b>
Wt <b>980</b>	Acc. (.47)	(.75)	(.71)	(.71)	(.53)	(.17)	(.30)	(.19)
Wean Pct. <b>71%</b>								
Cow Eff. <b>149</b>	Marb <b>+.23</b>	(.41)	REA <b>+.17</b>	(.45)	Bfat <b>+.04</b>	(.31)		

★★★★★ for Low Maintenance, Growth, Marbling, Rib-eye area, High Cow Efficiency, Calving Ease, Stayability.

**E-4** **BECKTON EPIC B310 J6**  
1-A 100% # 1706097 Tattoo: BKT4 B310

Birth: 3-21-14	Beckton Epic K6 S569	Beckton Epic KM M115	BWt <b>66</b>
		Beckton Sierra N703 LM	WR <b>121</b>
<b>BECKTON EPIC X464 L5</b>	Ref. E	Beckton Lancer T3 J396	ADG <b>3.92</b>
	Beckton Lana M393 LN	Beckton Lana F081 LN	YR <b>112</b>
		Beckton Julian G5 S107	Scr. <b>37</b>
<b>BECKTON MINERVA Y116 J</b>		Beckton Kit L399 HR	Fr. <b>6.0</b>
	Beckton Julian W743 H5	Beckton Nebula G S237	
	Beckton Minerva W081 N	Beckton Minerva F495 CH	

RAAA HerdBuilder index: **188** (Top **43%** of RA breed)

RAAA GridMaster index: **49** (Top **46%** of RA breed)

<b>DAM</b>	Calv.Ease	BW	WW	YW	Milk	HPG	Stay	Maint.En.
Age <b>3</b>	EPDs <b>14</b>	<b>-1.7</b>	<b>65</b>	<b>105</b>	<b>28</b>	<b>16</b>	<b>16</b>	<b>-3.0</b>
Wt <b>1125</b>	Acc. (.29)	(.63)	(.58)	(.54)	(.28)	(.07)	(.16)	(.02)
Wean Pct. <b>57%</b>								
Cow Eff. <b>120</b>	Marb <b>+.25</b>	(.22)	REA <b>+.01</b>	(.31)	Bfat <b>+.03</b>	(.20)		

★★★★★ for Low Maintenance, Growth, Marbling, High Cow Efficiency, Calving Ease, Stayability.

**E-2** **BECKTON EPIC Z674 E6**  
2 100% # 1544788 Tattoo: BKT2 Z674

Birth: 4-2-12	Beckton Epic K4 N795	Beckton Epic KJ J722	BWt <b>80</b>
		Beckton Sierra J789 EP	WR <b>115</b>
<b>BECKTON EPIC U749 D5</b>	Ref. E	Beckton Dominor ZC M919	ADG <b>3.75</b>
	Beckton Denise R308 DM	Beckton Denise L639 JL	YR <b>114</b>
		Beckton Epic KM M115	Scr. <b>32</b>
<b>BECKTON INDIGO U504 EP</b>		Beckton Sierra N703 LM	Fr. <b>5.5</b>
	Beckton Epic K6 S569	Beckton Nebula P P707	
	Beckton Indigo S016 NB	Beckton Indigo P062 NB	

RAAA HerdBuilder index: **174** (Top **63%** of RA breed)

RAAA GridMaster index: **51** (Top **14%** of RA breed)

<b>DAM</b>	Calv.Ease	BW	WW	YW	Milk	HPG	Stay	Maint.En.
Age <b>4</b>	EPDs <b>11</b>	<b>-1.5</b>	<b>64</b>	<b>113</b>	<b>27</b>	<b>10</b>	<b>15</b>	<b>-5.0</b>
Wt <b>825</b>	Acc. (.46)	(.76)	(.72)	(.72)	(.48)	(.08)	(.22)	(.04)
Wean Pct. <b>81%</b>								
Cow Eff. <b>170</b>	Marb <b>+.43</b>	(.35)	REA <b>-.11</b>	(.38)	Bfat <b>+.05</b>	(.24)		

★★★★★ for Low Maintenance, Growth, Marbling, High Cow Efficiency, Calving Ease, Stayability.

**E-5** **BECKTON EPIC B483 N6**  
1-A 100% # 1706043 Tattoo: BKT4 B483

Birth: 3-28-14	Beckton Epic K4 N795	Beckton Epic KJ J722	BWt <b>89</b>
		Beckton Sierra J789 EP	WR <b>123</b>
<b>BECKTON EPIC U749 D5</b>	Ref. E	Beckton Dominor ZC M919	ADG <b>4.66</b>
	Beckton Denise R308 DM	Beckton Denise L639 JL	YR <b>125</b>
		Beckton Nebula M045	Scr. <b>35</b>
<b>BKT PINE MARIE X339 N</b>		Beckton Ruth M967 EP	Fr. <b>6.0</b>
	Beckton Nebula T269 E2	Beckton Jules L429	
	BKT Pine Marie S467 JE	BKT Pine Marie M119 EP	

RAAA HerdBuilder index: **166** (Top **73%** of RA breed)

RAAA GridMaster index: **52** (Top **11%** of RA breed)

<b>DAM</b>	Calv.Ease	BW	WW	YW	Milk	HPG	Stay	Maint.En.
Age <b>4</b>	EPDs <b>10</b>	<b>-1.7</b>	<b>51</b>	<b>97</b>	<b>28</b>	<b>10</b>	<b>15</b>	<b>1.0</b>
Wt <b>992</b>	Acc. (.42)	(.69)	(.64)	(.62)	(.39)	(.08)	(.20)	(.19)
Wean Pct. <b>63%</b>								
Cow Eff. <b>133</b>	Marb <b>+.38</b>	(.23)	REA <b>-.08</b>	(.33)	Bfat <b>+.05</b>	(.21)		

★★★★★ for Low Maintenance, Growth, Gainability, Marbling, High Cow Efficiency, Calving Ease, Stayability.



• Reference Sires •

### E-6 BECKTON EPIC B545 N7

1-A 100% # 1706042 Tattoo: BKT4 B545

Birth: 3-31-14

Beckton Epic U749 D5 < Beckton Epic K4 N795  
Beckton Denise R308 DM

**BECKTON EPIC Y484 N6**  
Ref. E-1 < Beckton Lydia S069 NB < Beckton Nebula P P707  
Beckton Lydia P583 WR

Beckton Nebula T398 V3 < Beckton Nebula L P093  
Beckton Minerva J615 VG

**BECKTON SERENA X338 N**  
Beckton Serena S649 LO < Beckton Loki C M740  
Beckton Serena F248 CZ

BWt	90
WR	113
ADG	4.03
YR	112
Scr.	34
Fr.	5.5

RAAA HerdBuilder index: **196** (Top 32% of RA breed)  
RAAA GridMaster index: **52** (Top 9% of RA breed)

DAM		Calv.Ease	BW	WW	YW	Milk	HPG	Stay	Maint.En.
Age	4								
Wt	1068								
Wean Pct.	54%								
Cow Eff.	113								
EPDs	8	1.4	76	128	20	12	19	-1.0	
Acc.	(.35)	(.65)	(.59)	(.58)	(.37)	(.13)	(.15)	(.14)	
Marb	+0.26	(.26)	REA	+0.20	(.33)	Bfat	+0.04	(.19)	

### E-9 BECKTON EPIC D275 L7

1-A 100% # 3551843 Tattoo: BKT6 D275

Birth: 3-16-16

Beckton Epic U749 D5 < Beckton Epic K4 N795  
Beckton Denise R308 DM

**BECKTON EPIC Z674 E6**  
Ref. E-2 < Beckton Indigo U504 EP < Beckton Epic K6 S569  
Beckton Indigo S016 NB

Beckton Legend S670 < Beckton Lancer F442 T  
Beckton Kit F468 JL

**BECKTON LANA X839 L**  
Beckton Lana S371 DM < Beckton Dominor ZC M919  
Beckton Lana L367 LN

BWt	71
WR	102
ADG	3.94
YR	105
Scr.	34
Fr.	5.5

RAAA HerdBuilder index: **212** (Top 5% of RA breed)  
RAAA GridMaster index: **52** (Top 3% of RA breed)

DAM		Calv.Ease	BW	WW	YW	Milk	HPG	Stay	Maint.En.
Age	6								
Wt	1075								
Wean Pct.	52%								
Cow Eff.	110								
EPDs	17	-4.1	58	99	22	13	17	-9.0	
Acc.	(.27)	(.51)	(.44)	(.44)	(.26)	(.05)	(.16)	(.10)	
Marb	+0.53	(.24)	REA	-0.01	(.29)	Bfat	+0.03	(.19)	

★★★★★ for Low Maintenance, Growth, Gainability, Marbling, Rib-eye area, Calving Ease, Stayability.

★★★★★ for Low Maintenance, Marbling, Calving Ease, Stayability.

### E-7 BECKTON EPIC D001 L7

1-A 100% # 3551655 Tattoo: BKT6 D001

Birth: 2-4-16

Beckton Epic U749 D5 < Beckton Epic K4 N795  
Beckton Denise R308 DM

**BECKTON EPIC B483 N6**  
Ref. E-5 < BKT Pine Marie X339 N < Beckton Nebula T269 E2  
BKT Pine Marie S467 JE

Beckton Legend U331 E2 < Beckton Legend S670  
Beckton Lana S669 EP

**BECKTON MONA B713 L**  
Beckton Mona U564 JT < Beckton Jet L P491  
Beckton Mona P874 WR

BWt	63
WR	109
ADG	4.78
YR	119
Scr.	34
Fr.	5.5

RAAA HerdBuilder index: **206** (Top 9% of RA breed)  
RAAA GridMaster index: **52** (Top 4% of RA breed)

DAM		Calv.Ease	BW	WW	YW	Milk	HPG	Stay	Maint.En.
Age	2								
Wt	770								
Wean Pct.	57%								
Cow Eff.	120								
EPDs	17	-5.6	52	96	25	11	17	-3.0	
Acc.	(.23)	(.44)	(.37)	(.38)	(.21)	(.07)	(.13)	(.10)	
Marb	+0.38	(.20)	REA	+0.02	(.25)	Bfat	+0.04	(.17)	

★★★★★ for Low Maintenance, Growth, Gainability, Marbling, High Cow Efficiency, Calving Ease, Stayability.

### E-10 BECKTON EPIC D454 L7

1-A 100% # 3551792 Tattoo: BKT6 D454

Birth: 3-24-16

Beckton Epic U749 D5 < Beckton Epic K4 N795  
Beckton Denise R308 DM

**BECKTON EPIC Y484 N6**  
Ref. E-1 < Beckton Lydia S069 NB < Beckton Nebula P P707  
Beckton Lydia P583 WR

Beckton Lancer F442 T < Beckton Lancer T A664  
Bkt Suffeina A828 DM

**BECKTON ROSE W606 L**  
Beckton Rose F306 JL < Beckton Julian GG B571  
Beckton Rose C320 JV

BWt	93
WR	108
ADG	4.11
YR	110
Scr.	34
Fr.	5.5

RAAA HerdBuilder index: **179** (Top 44% of RA breed)  
RAAA GridMaster index: **53** (Top 2% of RA breed)

DAM		Calv.Ease	BW	WW	YW	Milk	HPG	Stay	Maint.En.
Age	7								
Wt	1165								
Wean Pct.	51%								
Cow Eff.	106								
EPDs	9	1.8	69	116	19	10	16	1.0	
Acc.	(.26)	(.50)	(.44)	(.44)	(.25)	(.07)	(.18)	(.16)	
Marb	+0.21	(.23)	REA	+0.29	(.28)	Bfat	+0.02	(.21)	

★★★★★ for Low Maintenance, Growth, Gainability, Marbling, Rib-eye area, Calving Ease, Stayability.

### E-8 BECKTON EPIC D110 J7

1-A 100% # 3551608 Tattoo: BKT6 D110

Birth: 2-27-16

Beckton Epic X464 L5 < Beckton Epic K6 S569  
Beckton Lana M393 LN

**BECKTON EPIC B310 J6**  
Ref. E-4 < Beckton Minerva Y116 J < Beckton Julian W743 H5  
Beckton Minerva W081 N

Beckton Julian X465 J5 < Beckton Julian G5 S107  
Beckton Suffeina P643 JL

**BECKTON PINE MARIE B248 J**  
BKT Pine Marie P351 EP < Beckton Epic KJ J722  
BKT Pine Marie L002 HR

BWt	66
WR	122
ADG	4.28
YR	114
Scr.	35
Fr.	5.5

RAAA HerdBuilder index: **180** (Top 43% of RA breed)  
RAAA GridMaster index: **50** (Top 24% of RA breed)

DAM		Calv.Ease	BW	WW	YW	Milk	HPG	Stay	Maint.En.
Age	2								
Wt	830								
Wean Pct.	61%								
Cow Eff.	127								
EPDs	13	-1.3	68	107	25	16	15	-4.0	
Acc.	(.18)	(.40)	(.34)	(.34)	(.18)	(.04)	(.18)	(.09)	
Marb	+0.36	(.19)	REA	-0.06	(.25)	Bfat	+0.04	(.16)	

★★★★★ for Low Maintenance, Growth, Gainability, Marbling, High Cow Efficiency, Calving Ease, Stayability.

### E-11 BECKTON EPIC D457 C7

1-A 100% # 3551288 Tattoo: BSF6 D457

Birth: 3-24-16

Beckton Epic U749 D5 < Beckton Epic K4 N795  
Beckton Denise R308 DM

**BECKTON EPIC Z674 E6**  
Ref. E-2 < Beckton Indigo U504 EP < Beckton Epic K6 S569  
Beckton Indigo S016 NB

Beckton Clifftop W577 E3 < BKT Clifftop TP R288  
BKT Pine Marie R213 EP

**BECKTON MONA Z270 C**  
Beckton Mona U584 CD < Beckton Cody K2 R168  
Beckton Mona P539 CH

BWt	63
WR	102
ADG	3.78
YR	106
Scr.	33
Fr.	5.5

RAAA HerdBuilder index: **209** (Top 7% of RA breed)  
RAAA GridMaster index: **50** (Top 14% of RA breed)

DAM		Calv.Ease	BW	WW	YW	Milk	HPG	Stay	Maint.En.
Age	4								
Wt	1045								
Wean Pct.	52%								
Cow Eff.	110								
EPDs	15	-2.8	55	100	27	14	19	-4.0	
Acc.	(.27)	(.52)	(.46)	(.45)	(.23)	(.07)	(.13)	(.10)	
Marb	+0.33	(.21)	REA	-0.21	(.25)	Bfat	+0.04	(.18)	

★★★★★ for Low Maintenance, Growth, Marbling, Calving Ease, Stayability.

• Reference Sires •

**H-1 BECKTON HERITAGE B612 J4**  
1-A 100% # 1705435 Tattoo: BSF4 B612

Birth: 4-4-14	Beckton Heritage T270 J2	Beckton Heritage N013	BWt	<b>79</b>
		Beckton Coca P602 JL	WR	<b>116</b>
<b>BECKTON HERITAGE X403 L3</b>	Beckton Lancer TE F363	Beckton Indigo F376 CT	ADG	<b>4.21</b>
Ref. H	Beckton Indigo H150 LN	Beckton Julian GG B571	YR	<b>111</b>
		Bkt Vernice 9733 PC	Scr.	<b>39</b>
<b>BECKTON LANA N291 JC</b>	Beckton Justice G302	Beckton Champ RK E121	Fr.	<b>5.5</b>
	Beckton Lana H725 CH	Beckton Lana E937 NM		

RAAA HerdBuilder index: **167** (Top **72%** of RA breed)

RAAA GridMaster index: **48** (Top **69%** of RA breed)

<b>DAM</b>	Calv.Ease	BW	WW	YW	Milk	HPG	Stay	Maint.En.
Age <b>11</b>	EPDs <b>13</b>	<b>-1.7</b>	<b>72</b>	<b>105</b>	<b>17</b>	<b>11</b>	<b>16</b>	<b>-3.0</b>
Wt <b>1330</b>	Acc. (.26)	(.62)	(.56)	(.54)	(.28)	(.16)	(.13)	(.16)
Wean Pct. <b>45%</b>	Marb <b>+0.31</b>	(.23)	REA <b>-0.11</b>	(.30)	Bfat <b>+0.05</b>	(.16)		
Cow Eff. <b>94</b>								

★★★★★ for Low Maintenance, Growth, Gainability, Marbling, Calving Ease, Stayability.

**J-1 BKT JAVELIN 7466 R**  
1-A 100% # 173533 Tattoo: WF4 7466

Birth: 3-17-84	Beckton Trojan 5253	Beckton Dito 4374	BWt	<b>66</b>
		Bkt Mana Anexa 4473	WR	<b>107</b>
<b>BECKTON JAVELIN 6587</b>	Beckton lleximka -3	Bkt Ry Mtn 1195	ADG	<b>3.56</b>
Ref.		Beckton Lsa 1632 96	YR	<b>114</b>
		Choctaw Chief 373	Scr.	<b>NA</b>
<b>BECKTON ROSE 6807 RZ</b>	Beckton Raza 2308-N	Bkt Osalalxi -L	Fr.	<b>NA</b>
	Bkt Baya Rose 5195	Beckton Jiba 1067-C		
		Bkt Ximi Rose 4218		

RAAA HerdBuilder index: **166** (Top **74%** of RA breed)

RAAA GridMaster index: **45** (Top **98%** of RA breed)

<b>DAM</b>	Calv.Ease	BW	WW	YW	Milk	HPG	Stay	Maint.En.
Age <b>2</b>	EPDs <b>20</b>	<b>-7.4</b>	<b>21</b>	<b>27</b>	<b>23</b>	<b>10</b>	<b>14</b>	<b>-18.0</b>
Wt <b>791</b>	Acc. (.27)	(.75)	(.69)	(.70)	(.52)	(.57)	(.32)	(.65)
Wean Pct. <b>56%</b>	Marb <b>+0.23</b>	(.24)	REA <b>-0.39</b>	(.35)	Bfat <b>+0.01</b>	(.10)		
Cow Eff. <b>112</b>								

★★★★★ for Low Maintenance, Marbling, Calving Ease, Stayability.



Julian B571 (J-2)

**J-2 BECKTON JULIAN GG B571**  
1-A 100% # 387580 Tattoo: WF2 B571

Birth: 3-27-92	Beckton Julian 6592	Beckton Trojan 5253	BWt	<b>65</b>
		Lchmn Christy 2339	WR	<b>113</b>
<b>BECKTON JULIAN 7526G</b>	Beckton Gisa 4454	Beckton Lalaxigu -2	ADG	<b>3.18</b>
Ref.	Bkt Belga 6746 GS	Beckton Julian 6592	YR	<b>112</b>
		Bkt Belga 6746 GS	Scr.	<b>NA</b>
<b>BKT MARTA 9A13 JL</b>	Beckton Julian 7526G	Beckton Xime 4736	Fr.	<b>5.0</b>
	Bkt Marta 6498 XM	Beckton Marwa -K		

RAAA HerdBuilder index: **211** (Top **16%** of RA breed)

RAAA GridMaster index: **51** (Top **20%** of RA breed)

<b>DAM</b>	Calv.Ease	BW	WW	YW	Milk	HPG	Stay	Maint.En.
Age <b>3</b>	EPDs <b>20</b>	<b>-6.6</b>	<b>49</b>	<b>76</b>	<b>25</b>	<b>17</b>	<b>17</b>	<b>-6.0</b>
Wt <b>1015</b>	Acc. (.85)	(.93)	(.92)	(.92)	(.89)	(.91)	(.79)	(.70)
Wean Pct. <b>56%</b>	Marb <b>+0.44</b>	(.75)	REA <b>-0.12</b>	(.81)	Bfat <b>+0.05</b>	(.74)		
Cow Eff. <b>118</b>								

★★★★★ for Low Maintenance, Growth, Marbling, High Cow Efficiency, Calving Ease, Stayability.

**H-2 BECKTON HERITAGE D195 L4**  
1-A 100% # 3551804 Tattoo: BKT6 D195

Birth: 3-10-16	Beckton Heritage X356 E2	Beckton Heritage N013	BWt	<b>82</b>
		Beckton Lana S489 EP	WR	<b>128</b>
<b>BECKTON HERITAGE A767 C3</b>	BKT Clifftop TP R288	Beckton Rose S487 LN	ADG	<b>4.06</b>
Ref. H	Beckton Rose W816 C	Beckton Loki C M740	YR	<b>118</b>
		Beckton Lakme J460 LT	Scr.	<b>37</b>
<b>BECKTON SUSAN W846 L</b>	Beckton Loki CL S284	Beckton Juno N493	Fr.	<b>5.5</b>
	Beckton Susan S684 JJ	Beckton Susan M144 CH		

RAAA HerdBuilder index: **178** (Top **46%** of RA breed)

RAAA GridMaster index: **51** (Top **7%** of RA breed)

<b>DAM</b>	Calv.Ease	BW	WW	YW	Milk	HPG	Stay	Maint.En.
Age <b>7</b>	EPDs <b>15</b>	<b>-2.4</b>	<b>69</b>	<b>113</b>	<b>22</b>	<b>10</b>	<b>15</b>	<b>0.0</b>
Wt <b>1150</b>	Acc. (.23)	(.51)	(.43)	(.42)	(.22)	(.07)	(.13)	(.15)
Wean Pct. <b>62%</b>	Marb <b>+0.44</b>	(.19)	REA <b>-0.11</b>	(.24)	Bfat <b>+0.04</b>	(.16)		
Cow Eff. <b>130</b>								

★★★★★ for Low Maintenance, Growth, Gainability, Marbling, High Cow Efficiency, Calving Ease, Stayability.

**J-3 BECKTON JULIAN D551 C6**  
1-A 100% # 3551791 Tattoo: BKT6 D551

Birth: 3-28-16	Beckton Julian G5 S107	Beckton Julian GJ P535	BWt	<b>69</b>
		Beckton Minola P826 DM	WR	<b>123</b>
<b>BECKTON JULIAN X465 J5</b>	Beckton Julian GG B571	Bkt Suffeina A828 DM	ADG	<b>4.61</b>
Ref. J	Beckton Suffeina P643 JL	Beckton Cody KH M390	YR	<b>122</b>
		Beckton Rose M126 WR	Scr.	<b>36</b>
<b>BECKTON TAMARA W550 A</b>	Beckton Cody K1 P014	Beckton Cherokee N N479	Fr.	<b>5.5</b>
	Beckton Tamara R175 CQ	Beckton Tamara N765 CO		

RAAA HerdBuilder index: **207** (Top **9%** of RA breed)

RAAA GridMaster index: **51** (Top **8%** of RA breed)

<b>DAM</b>	Calv.Ease	BW	WW	YW	Milk	HPG	Stay	Maint.En.
Age <b>7</b>	EPDs <b>15</b>	<b>-3.1</b>	<b>65</b>	<b>110</b>	<b>26</b>	<b>17</b>	<b>17</b>	<b>-5.0</b>
Wt <b>1100</b>	Acc. (.26)	(.48)	(.42)	(.42)	(.27)	(.08)	(.17)	(.17)
Wean Pct. <b>61%</b>	Marb <b>+0.49</b>	(.25)	REA <b>-0.18</b>	(.28)	Bfat <b>+0.06</b>	(.21)		
Cow Eff. <b>128</b>								

★★★★★ for Low Maintenance, Growth, Gainability, Marbling, High Cow Efficiency, Calving Ease, Stayability.

• Reference Sires •

**L-1 BECKTON LIKABLE Z057 L4**  
1-A 100% # 1544436 Tattoo: BKT2 Z057

Birth: 2-18-12	Beckton Likable U130 L2	Beckton Likable S633	BWt	<b>54</b>
		Beckton Kit S478 LN	WR	<b>99</b>
<b>BECKTON LIKABLE X445 J3</b>	Beckton Julian GJ P535	Beckton Indigo R567 WA	ADG	<b>3.87</b>
Ref. L	Beckton Indigo U658 JL		YR	<b>113</b>
	Beckton Likable U120 L2	Beckton Likable S633	Scr.	<b>37</b>
<b>BECKTON MINOLA X107 L</b>	Beckton Lana S718 LN	Beckton Nebula P P707	Fr.	<b>5.0</b>
	Beckton Minola U188 NB	Beckton Minola N729 JL		

RAAA HerdBuilder index: **211** (Top 16% of RA breed)  
RAAA GridMaster index: **53** (Top 5% of RA breed)

Calv.Ease	BW	WW	YW	Milk	HPG	Stay	Maint.En.
EPDs <b>14</b>	<b>-4.9</b>	<b>55</b>	<b>99</b>	<b>26</b>	<b>16</b>	<b>18</b>	<b>-13.0</b>
Acc. (.45)	(.75)	(.71)	(.68)	(.48)	(.06)	(.15)	(.02)
Marb <b>+0.52</b>	(.34)	REA <b>+0.02</b>	(.44)	Bfat <b>+0.03</b>	(.24)		

**DAM**

Age	<b>2</b>
Wt	<b>700</b>
Wean Pct.	<b>67%</b>
Cow Eff.	<b>140</b>

★★★★★ for Low Maintenance, Growth, Marbling, High Cow Efficiency, Calving Ease, Stayability.

**L-3 BECKTON LIKABLE B509 J3**  
1-A 100% # 1705862 Tattoo: BKT4 B509

Birth: 3-29-14	Beckton Likable S633	Beckton Lancer F442 T	BWt	<b>81</b>
		Beckton Kit F468 JL	WR	<b>111</b>
<b>BECKTON LIKABLE U130 L2</b>	Beckton Lancer F442 T	Beckton Kit F468 JL	ADG	<b>4.26</b>
Ref. L	Beckton Kit S478 LN		YR	<b>112</b>
	Beckton Julian G2 M345	Beckton Julian GG B571	Scr.	<b>40</b>
<b>BECKTON COCA T363 JL</b>	Beckton Lana H544 WR	Beckton Champ R1 H024	Fr.	<b>6.0</b>
	Beckton Coca P435 CH	Beckton Coca J882 HR		

RAAA HerdBuilder index: **198** (Top 29% of RA breed)  
RAAA GridMaster index: **50** (Top 32% of RA breed)

Calv.Ease	BW	WW	YW	Milk	HPG	Stay	Maint.En.
EPDs <b>14</b>	<b>-1.4</b>	<b>55</b>	<b>86</b>	<b>23</b>	<b>14</b>	<b>18</b>	<b>-8.0</b>
Acc. (.36)	(.69)	(.64)	(.61)	(.39)	(.07)	(.17)	(.18)
Marb <b>+0.22</b>	(.27)	REA <b>+0.21</b>	(.34)	Bfat <b>+0.02</b>	(.21)		

**DAM**

Age	<b>7</b>
Wt	<b>1192</b>
Wean Pct.	<b>52%</b>
Cow Eff.	<b>109</b>

★★★★★ for Low Maintenance, Growth, Gainability, Marbling, Rib-eye area, Calving Ease, Stayability.

**L-2 BECKTON LIKABLE B032 C5**  
1-A 100% # 1705725 Tattoo: BKB4 B032

Birth: 2-17-14	Beckton Likable X445 J3	Beckton Likable U130 L2	BWt	<b>63</b>
		Beckton Indigo U658 JL	WR	<b>110</b>
<b>BECKTON LIKABLE Z057 L4</b>	Beckton Likable U120 L2	Beckton Minola U188 NB	ADG	<b>4.72</b>
Ref. L-1	Beckton Minola X107 L		YR	<b>119</b>
	Beckton Clifftop W577 E3	BKT Clifftop TP R288	Scr.	<b>35</b>
<b>BECKTON MONA Z270 C</b>	BKT Pine Marie R213 EP	Beckton Cody K2 R168	Fr.	<b>6.0</b>
	Beckton Mona U584 CD	Beckton Mona P539 CH		

RAAA HerdBuilder index: **230** (Top 5% of RA breed)  
RAAA GridMaster index: **53** (Top 6% of RA breed)

Calv.Ease	BW	WW	YW	Milk	HPG	Stay	Maint.En.
EPDs <b>15</b>	<b>-5.3</b>	<b>57</b>	<b>104</b>	<b>26</b>	<b>14</b>	<b>20</b>	<b>-9.0</b>
Acc. (.27)	(.60)	(.55)	(.52)	(.28)	(.02)	(.15)	(.10)
Marb <b>+0.51</b>	(.19)	REA <b>-0.11</b>	(.30)	Bfat <b>+0.04</b>	(.18)		

**DAM**

Age	<b>2</b>
Wt	<b>884</b>
Wean Pct.	<b>50%</b>
Cow Eff.	<b>106</b>

★★★★★ for Low Maintenance, Growth, Gainability, Marbling, Calving Ease, Stayability.



Nebula P707 (N-1)



Likeable B032 (L-2)

**L-4 BECKTON LIKABLE D063 N4**  
1-A 100% # 3551798 Tattoo: BKT6 D063

Birth: 2-20-16	Beckton Likable U130 L2	Beckton Likable S633	BWt	<b>70</b>
		Beckton Kit S478 LN	WR	<b>104</b>
<b>BECKTON LIKABLE Y124 L3</b>	Beckton Lasso P741	BKT Pine Marie P475 LN	ADG	<b>4.22</b>
Ref. L	BKT Pine Marie S802 LO		YR	<b>108</b>
	Beckton Nebula PJ S543	Beckton Nebula P P707	Scr.	<b>36</b>
<b>BECKTON SERENA W738 N</b>	Beckton Lana P685 JO	Beckton Loki C M740	Fr.	<b>5.5</b>
	Beckton Serena S649 LO	Beckton Serena F248 CZ		

RAAA HerdBuilder index: **194** (Top 21% of RA breed)  
RAAA GridMaster index: **50** (Top 15% of RA breed)

Calv.Ease	BW	WW	YW	Milk	HPG	Stay	Maint.En.
EPDs <b>18</b>	<b>-4.3</b>	<b>54</b>	<b>94</b>	<b>26</b>	<b>14</b>	<b>16</b>	<b>2.0</b>
Acc. (.24)	(.52)	(.45)	(.44)	(.24)	(.07)	(.15)	(.03)
Marb <b>+0.39</b>	(.20)	REA <b>-0.15</b>	(.26)	Bfat <b>+0.05</b>	(.18)		

**DAM**

Age	<b>7</b>
Wt	<b>1145</b>
Wean Pct.	<b>50%</b>
Cow Eff.	<b>106</b>

★★★★★ for Low Maintenance, Growth, Gainability, Marbling, Calving Ease, Stayability.



• Reference Sires •

**L-5 BECKTON LIKABLE D432 N3**  
1-A 100% # 3551764 Tattoo: BKT6 D432

Birth: 3-23-16	Beckton Likable S633	Beckton Lancer F442 T	BWt <b>75</b>
		Beckton Kit F468 JL	WR <b>94</b>
<b>BECKTON LIKABLE U130 L2</b>	Ref. L	Beckton Lancer F442 T	ADG <b>4.05</b>
	Beckton Kit S478 LN	Beckton Kit F468 JL	YR <b>105</b>
	Beckton Nebula T054 H3	Beckton Nebula J R475	Scr. <b>36</b>
<b>BECKTON FIREFLY W013 N</b>		BKT Pine Marie R401 HU	Fr. <b>5.5</b>
	Beckton Firefly T003 JC	Beckton Justice C1 R483	
		Beckton Firefly R064 NW	

RAAA HerdBuilder index: **213** (Top 5% of RA breed)

RAAA GridMaster index: **51** (Top 11% of RA breed)

<b>DAM</b>	Age <b>7</b>	Wt <b>890</b>	Wean Pct. <b>59%</b>	Cow Eff. <b>123</b>			
Calv.Ease	BW	WW	YW	Milk	HPG	Stay	Maint.En.
EPDs <b>19</b>	<b>-4.1</b>	<b>48</b>	<b>79</b>	<b>24</b>	<b>14</b>	<b>17</b>	<b>-10.0</b>
Acc. (.29)	(.50)	(.45)	(.44)	(.29)	(.07)	(.18)	(.18)
Marb <b>+.39</b>	(.24)	REA <b>+.18</b>	(.29)	Bfat <b>+.04</b>	(.21)		



Nebula M045 (sire to N-1 and grandsire to N-3)

★★★★★ for Low Maintenance, Gainability, Marbling, Rib-eye area, High Cow Efficiency, Calving Ease, Stayability.

**N-1 BECKTON NEBULA P P707**  
1-A 100% # 979031 Tattoo: BKT4 P707

Birth: 4-1-04	Beckton Neptune R2 K065	Beckton Neptune RR B284	BWt <b>68</b>
		Beckton Lana C735 TP	WR <b>127</b>
<b>BECKTON NEBULA M045</b>	Ref. N	Beckton Julian GG B571	ADG <b>3.85</b>
	Beckton Belga K285 JL	Beckton Belga G493 HR	YR <b>122</b>
	Beckton Epic K1 K863	Beckton Epic KN H110	Scr. <b>37</b>
<b>BECKTON LANA M809 EP</b>		Beckton Rose H019 SC	Fr. <b>5.0</b>
	Beckton Lana K253 DM	Beckton Dominor ZJ H657	
		Beckton Lana HA34 DM	

RAAA HerdBuilder index: **219** (Top 10% of RA breed)

RAAA GridMaster index: **48** (Top 15% of RA breed)

<b>DAM</b>	Age <b>2</b>	Wt <b>890</b>	Wean Pct. <b>71%</b>	Cow Eff. <b>150</b>			
Calv.Ease	BW	WW	YW	Milk	HPG	Stay	Maint.En.
EPDs <b>15</b>	<b>-5.8</b>	<b>54</b>	<b>94</b>	<b>24</b>	<b>10</b>	<b>22</b>	<b>-7.0</b>
Acc. (.82)	(.91)	(.90)	(.90)	(.85)	(.83)	(.69)	(.69)
Marb <b>+.65</b>	(.73)	REA <b>-.56</b>	(.73)	Bfat <b>+.07</b>	(.68)		

★★★★★ for Low Maintenance, Growth, Marbling, High Cow Efficiency, Calving Ease, Stayability.

**N-3 BECKTON NEBULA B557 J3**  
1-A 100% # 1705884 Tattoo: BKT4 B557

Birth: 4-1-14	Beckton Nebula M045	Beckton Neptune R2 K065	BWt <b>80</b>
		Beckton Belga K285 JL	WR <b>111</b>
<b>BECKTON NEBULA P P707</b>	Ref. N-1	Beckton Epic K1 K863	ADG <b>3.81</b>
	Beckton Lana M809 EP	Beckton Lana K253 DM	YR <b>105</b>
	Beckton Justice CH M056	Beckton Justice C K449	Scr. <b>38</b>
<b>BECKTON LARKABA T813 JC</b>		Beckton Ruth K802 HD	Fr. <b>5.0</b>
	Beckton Larkaba P645 JL	Beckton Julian GG B571	
		Beckton Larkaba L312 LN	

RAAA HerdBuilder index: **223** (Top 8% of RA breed)

RAAA GridMaster index: **51** (Top 22% of RA breed)

<b>DAM</b>	Age <b>7</b>	Wt <b>1166</b>	Wean Pct. <b>50%</b>	Cow Eff. <b>105</b>			
Calv.Ease	BW	WW	YW	Milk	HPG	Stay	Maint.En.
EPDs <b>15</b>	<b>-3.8</b>	<b>55</b>	<b>94</b>	<b>27</b>	<b>11</b>	<b>21</b>	<b>-6.0</b>
Acc. (.31)	(.62)	(.56)	(.54)	(.33)	(.22)	(.22)	(.04)
Marb <b>+.55</b>	(.30)	REA <b>-.08</b>	(.37)	Bfat <b>+.04</b>	(.28)		

★★★★★ for Low Maintenance, Growth, Marbling, Calving Ease, Stayability.

**N-2 BECKTON NEBULA X603 J4**  
1-A 100% # 1383179 Tattoo: BKT0 X603

Birth: 4-4-10	Beckton Nebula L P093	Beckton Nebula M045	BWt <b>64</b>
		Beckton Marta M021 LN	WR <b>104</b>
<b>BECKTON NEBULA T398 V3</b>	Ref. N	Beckton Vegas PK F485	ADG <b>3.95</b>
	Beckton Minerva J615 VG	Beckton Minerva F433 VG	YR <b>105</b>
	Beckton Justice C1 R483	Beckton Justice CH M056	Scr. <b>39</b>
<b>BECKTON FIREFLY T003 JC</b>		Beckton Tamara J124 HR	Fr. <b>5.0</b>
	Beckton Firefly R064 NW	Beckton Newark Cn N567	
		Beckton Firefly N655 NP	

RAAA HerdBuilder index: **237** (Top 3% of RA breed)

RAAA GridMaster index: **49** (Top 56% of RA breed)

<b>DAM</b>	Age <b>3</b>	Wt <b>855</b>	Wean Pct. <b>65%</b>	Cow Eff. <b>137</b>			
Calv.Ease	BW	WW	YW	Milk	HPG	Stay	Maint.En.
EPDs <b>18</b>	<b>-4.5</b>	<b>51</b>	<b>82</b>	<b>25</b>	<b>15</b>	<b>21</b>	<b>-9.0</b>
Acc. (.32)	(.59)	(.52)	(.52)	(.40)	(.29)	(.27)	(.56)
Marb <b>+.37</b>	(.28)	REA <b>+.00</b>	(.32)	Bfat <b>+.05</b>	(.22)		

★★★★★ for Low Maintenance, Marbling, High Cow Efficiency, Calving Ease, Stayability.

**N-4 BECKTON NEW ERA Y194**  
1-A 100% # 1451309 Tattoo: BKB1 Y194

Birth: 3-20-11	Beckton Nebula M045	Beckton Neptune R2 K065	BWt <b>67</b>
		Beckton Belga K285 JL	WR <b>132</b>
<b>BECKTON NEBULA P P707</b>	Ref. N-1	Beckton Epic K1 K863	ADG <b>3.50</b>
	Beckton Lana M809 EP	Beckton Lana K253 DM	YR <b>121</b>
	Beckton Justice C1 R483	Beckton Justice CH M056	Scr. <b>36</b>
<b>BKT LARKEISA T310 JC</b>		Beckton Tamara J124 HR	Fr. <b>5.5</b>
	BKT Larkeisa R775 JC	Beckton Justice C K449	
		BKT Larkeisa L149 CK	

RAAA HerdBuilder index: **213** (Top 14% of RA breed)

RAAA GridMaster index: **49** (Top 42% of RA breed)

<b>DAM</b>	Age <b>4</b>	Wt <b>950</b>	Wean Pct. <b>82%</b>	Cow Eff. <b>174</b>			
Calv.Ease	BW	WW	YW	Milk	HPG	Stay	Maint.En.
EPDs <b>17</b>	<b>-3.1</b>	<b>64</b>	<b>108</b>	<b>21</b>	<b>11</b>	<b>19</b>	<b>-5.0</b>
Acc. (.62)	(.83)	(.80)	(.81)	(.69)	(.51)	(.36)	(.19)
Marb <b>+.41</b>	(.57)	REA <b>-.11</b>	(.55)	Bfat <b>+.04</b>	(.36)		

★★★★★ for Low Maintenance, Growth, Marbling, High Cow Efficiency, Calving Ease, Stayability.

• Reference Sires •

**R-1 BECKTON RANGER B006 D5**  
1-A 100% # 1705764 Tattoo: BSF4 B006

Birth: 2-11-14	Beckton Ranger T603 H3	Beckton Ranger 9479R	BWt	<b>69</b>
		Beckton Rose N044 HU	WR	<b>113</b>
<b>BECKTON RANGER Z225 J4</b>	Beckton Jet L P491	Beckton Jet L P491	ADG	<b>4.03</b>
Ref. R	Beckton Mona U564 JT	Beckton Mona P874 WR	YR	<b>109</b>
		Beckton Dominor Z1 R610	Scr.	<b>35</b>
<b>BECKTON SUFFEINA Z731 D</b>	Beckton Dominor W640 C5	Beckton Warrior N645 T1	Fr.	<b>6.0</b>
	Beckton Suffeina W471 W	Beckton Suffeina P671 LN		

RAAA HerdBuilder index: **156** (Top **83%** of RA breed)  
RAAA GridMaster index: **51** (Top **25%** of RA breed)

	Calv.Ease	BW	WW	YW	Milk	HPG	Stay	Maint.En.
EPDs	<b>14</b>	<b>-0.4</b>	<b>62</b>	<b>102</b>	<b>24</b>	<b>14</b>	<b>12</b>	<b>-5.0</b>
Acc.	(.22)	(.60)	(.53)	(.49)	(.26)	(.07)	(.15)	(.14)
Marb	<b>+0.45</b>	(.20)	REA	<b>-0.04</b>	(.27)	Bfat	<b>+0.03</b>	(.18)

DAM	
Age	<b>2</b>
Wt	<b>918</b>
Wean Pct.	<b>54%</b>
Cow Eff.	<b>114</b>

★★★★★ for Low Maintenance, Growth, Gainability, Marbling, Calving Ease.

**S-3 BECKTON SCAMP D325 N5**  
1-A 100% # 3551849 Tattoo: BKT6 D325

Birth: 3-18-16	Beckton Scamp X494 E3	Beckton Scamp T A825	BWt	<b>72</b>
		Beckton Lana S074 EP	WR	<b>107</b>
<b>BECKTON SCAMP A627 J4</b>	Beckton Justice Cc N265	Beckton Justice Cc N265	ADG	<b>4.22</b>
Ref. S	Beckton Serena R023 JC	Beckton Serena N469 JC	YR	<b>109</b>
		Beckton Nebula T269 E2	Scr.	<b>36</b>
<b>BECKTON TAMARA Y039 N</b>	Beckton Nebula W065 C3	Beckton Lana T104 CT	Fr.	<b>5.5</b>
	Beckton Tamara W232 J	Beckton Julian GG B571		
		Beckton Tamara S025 EP		

RAAA HerdBuilder index: **173** (Top **55%** of RA breed)  
RAAA GridMaster index: **49** (Top **28%** of RA breed)

	Calv.Ease	BW	WW	YW	Milk	HPG	Stay	Maint.En.
EPDs	<b>17</b>	<b>-4.9</b>	<b>54</b>	<b>92</b>	<b>28</b>	<b>15</b>	<b>14</b>	<b>-6.0</b>
Acc.	(.21)	(.50)	(.43)	(.43)	(.23)	(.05)	(.13)	(.13)
Marb	<b>+0.23</b>	(.20)	REA	<b>-0.12</b>	(.26)	Bfat	<b>+0.03</b>	(.16)

DAM	
Age	<b>5</b>
Wt	<b>1045</b>
Wean Pct.	<b>57%</b>
Cow Eff.	<b>119</b>

★★★★★ for Low Maintenance, Growth, Gainability, Marbling, High Cow Efficiency, Calving Ease, Stayability.

**S-1 BECKTON SCAMP B720 L4**  
1-A 100% # 1706126 Tattoo: BKT4 B720

Birth: 4-14-14	Beckton Scamp T A825	Beckton Scamp 8954	BWt	<b>75</b>
		Bkt Encino 8459 TJ	WR	<b>93</b>
<b>BECKTON SCAMP X458 H3</b>	Beckton Hustler C2 L079	Beckton Hustler C2 L079	ADG	<b>3.54</b>
Ref. S	BKT Pine Marie R401 HU	Bkt Pine Marie LC30 CD	YR	<b>96</b>
		Beckton Likable S633	Scr.	<b>37</b>
<b>BECKTON LARKABA Y448 L</b>	Beckton Likable U130 L2	Beckton Kit S478 LN	Fr.	<b>5.5</b>
	Beckton Larkaba T655 NB	Beckton Nebula J R475		
		Beckton Larkaba R332 CK		

RAAA HerdBuilder index: **169** (Top **70%** of RA breed)  
RAAA GridMaster index: **52** (Top **8%** of RA breed)

	Calv.Ease	BW	WW	YW	Milk	HPG	Stay	Maint.En.
EPDs	<b>18</b>	<b>-4.8</b>	<b>55</b>	<b>95</b>	<b>22</b>	<b>15</b>	<b>11</b>	<b>-7.0</b>
Acc.	(.37)	(.66)	(.62)	(.60)	(.36)	(.08)	(.16)	(.03)
Marb	<b>+0.31</b>	(.24)	REA	<b>+0.09</b>	(.32)	Bfat	<b>+0.01</b>	(.20)

DAM	
Age	<b>3</b>
Wt	<b>1035</b>
Wean Pct.	<b>42%</b>
Cow Eff.	<b>88</b>

★★★★★ for Low Maintenance, Marbling, Calving Ease.

**S-4 BECKTON SCAMP D739 N5**  
1-A 100% # 3551509 Tattoo: BKT6 D739

Birth: 4-15-16	Beckton Scamp X494 E3	Beckton Scamp T A825	BWt	<b>62</b>
		Beckton Lana S074 EP	WR	<b>111</b>
<b>BECKTON SCAMP A627 J4</b>	Beckton Justice Cc N265	Beckton Justice Cc N265	ADG	<b>4.06</b>
Ref. S	Beckton Serena R023 JC	Beckton Serena N469 JC	YR	<b>107</b>
		Beckton Nebula W778 J4	Scr.	<b>NA</b>
<b>BECKTON COCA A120 N</b>	Beckton Nebula Y002 C5	BKT Pine Marie W102 C	Fr.	<b>5.5</b>
	Beckton Coca Y190 J	Beckton Julian W743 H5		
		Beckton Coca W512 N		

RAAA HerdBuilder index: **186** (Top **32%** of RA breed)  
RAAA GridMaster index: **48** (Top **50%** of RA breed)

	Calv.Ease	BW	WW	YW	Milk	HPG	Stay	Maint.En.
EPDs	<b>21</b>	<b>-7.0</b>	<b>47</b>	<b>75</b>	<b>24</b>	<b>18</b>	<b>14</b>	<b>-7.0</b>
Acc.	(.20)	(.43)	(.38)	(.36)	(.22)	(.04)	(.12)	(.07)
Marb	<b>+0.40</b>	(.19)	REA	<b>-0.25</b>	(.26)	Bfat	<b>+0.04</b>	(.17)

DAM	
Age	<b>3</b>
Wt	<b>880</b>
Wean Pct.	<b>60%</b>
Cow Eff.	<b>127</b>

★★★★★ for Low Maintenance, Growth, Gainability, Marbling, High Cow Efficiency, Calving Ease, Stayability.

**S-2 BECKTON SCAMP C349 C4**  
1-A 100% # 3487330 Tattoo: BKT5 C349

Birth: 3-22-15	Beckton Scamp T A825	Beckton Scamp 8954	BWt	<b>78</b>
		Bkt Encino 8459 TJ	WR	<b>107</b>
<b>BECKTON SCAMP X458 H3</b>	Beckton Hustler C2 L079	Beckton Hustler C2 L079	ADG	<b>3.56</b>
Ref. S	BKT Pine Marie R401 HU	Bkt Pine Marie LC30 CD	YR	<b>108</b>
		Beckton Clifftop T C075	Scr.	<b>35</b>
<b>BECKTON LYDIA W178 C</b>	BKT Clifftop TP R288	Beckton Christy K209 CO	Fr.	<b>6.0</b>
	Beckton Lydia N047 LM	Beckton Laramie L044		
		Beckton Lydia L647 JL		

RAAA HerdBuilder index: **144** (Top **91%** of RA breed)  
RAAA GridMaster index: **48** (Top **63%** of RA breed)

	Calv.Ease	BW	WW	YW	Milk	HPG	Stay	Maint.En.
EPDs	<b>14</b>	<b>-3.0</b>	<b>56</b>	<b>88</b>	<b>24</b>	<b>15</b>	<b>11</b>	<b>-3.0</b>
Acc.	(.33)	(.59)	(.55)	(.54)	(.32)	(.08)	(.14)	(.03)
Marb	<b>+0.23</b>	(.21)	REA	<b>-0.12</b>	(.27)	Bfat	<b>+0.02</b>	(.15)

DAM	
Age	<b>6</b>
Wt	<b>1280</b>
Wean Pct.	<b>50%</b>
Cow Eff.	<b>105</b>

★★★★★ for Low Maintenance, Growth, Marbling, Calving Ease.

**W-1 BECKTON WARRIOR D359 L6**  
1-A 100% # 3551786 Tattoo: BKT6 D359

Birth: 3-20-16	Beckton Warrior W534 N4	Beckton Warrior C1 S337	BWt	<b>78</b>
		BKT Larkeisa S055 NB	WR	<b>117</b>
<b>BECKTON WARRIOR Y108 E5</b>	Beckton Epic T330 L5	Beckton Epic T330 L5	ADG	<b>3.94</b>
Ref. W	Beckton Susan W058 E	Beckton Susan T048 NB	YR	<b>113</b>
		Beckton Loki C M740	Scr.	<b>39</b>
<b>BECKTON LANA W463 L</b>	Beckton Loki CL S284	Beckton Lakme J460 LT	Fr.	<b>5.5</b>
	Beckton Lana R327 EP	Beckton Epic KM M115		
		Beckton Lana K840 LN		

RAAA HerdBuilder index: **182** (Top **39%** of RA breed)  
RAAA GridMaster index: **48** (Top **44%** of RA breed)

	Calv.Ease	BW	WW	YW	Milk	HPG	Stay	Maint.En.
EPDs	<b>17</b>	<b>-5.1</b>	<b>55</b>	<b>94</b>	<b>28</b>	<b>10</b>	<b>16</b>	<b>-4.0</b>
Acc.	(.26)	(.51)	(.43)	(.43)	(.26)	(.08)	(.14)	(.14)
Marb	<b>+0.26</b>	(.22)	REA	<b>-0.09</b>	(.27)	Bfat	<b>+0.05</b>	(.20)

DAM	
Age	<b>7</b>
Wt	<b>1135</b>
Wean Pct.	<b>56%</b>
Cow Eff.	<b>118</b>

★★★★★ for Low Maintenance, Growth, Marbling, High Cow Efficiency, Calving Ease, Stayability.

# Sale Terms and Conditions

Except for those stated in the terms and conditions below, there are no warranties, either expressed or implied, as to the merchantability or fitness for a particular purpose with respect to the cattle being sold at this auction. The warranties and guarantees set forth in the "Terms and Conditions" are in lieu of all other warranties, either expressed or implied, and the remedies provided therein shall be the sole and exclusive remedy for the Buyer, or any party claiming through Buyer, for any breach of warranty or guarantee therein provided, and all other obligations or liabilities.

The information in the catalog is believed to be accurate, and the information seller believes to be most representative. It is the nature of seller's business that the seller engages in a continual process of collecting new data and information. Therefore, any information presented at the time of sale is always subject to revision, correction or update.

## I. BIDDING

The Auctioneer in charge will settle any disputes as to bids, and his decision on such matters shall be final.

## II. TERMS

Terms of sale are cash or personal check unless satisfactory credit arrangements have been made with vendor prior to sale.

## III. PURCHASER'S RISK

Each animal becomes the risk of the purchaser as soon as sold, but it shall be the obligation of the Seller to see that animals are fed and cared for free of charge to purchaser, until loaded for shipment or until the expiration of 48 hours after the sale, whichever occurs sooner.

## IV. DELIVERY

For any animals for which seller's arrange delivery, the following terms shall apply. Each animal becomes the risk of the purchaser as soon as sold, and through the time of delivery. The seller will arrange transportation and delivery schedules, and may combine animals from one or more purchasers for convenience and to reduce costs. If delivery is arranged, seller assumes no other liability. Once the purchaser has been notified of the date and approximate time of delivery (morning, afternoon, evening, etc.), it is the responsibility of the purchaser to arrange adequate and agreeable location and facilities for unloading each animal. When unloaded at the agreed upon location, all care and management of the animal is the responsibility of the purchaser.

## V. CERTIFICATE OF REGISTRY

A transferred certificate of registry will be furnished to the purchaser for each animal for which a Registration number is listed.

## VI. HEALTH

All animals are eligible for interstate shipment, except as otherwise announced. Interstate health papers will be furnished for each animal requiring T.B, Bang's, and trich tests in accordance with federal and state regulations.

## VII. DIVISIBILITY

The percentage of ownership interest received by the buyer, whether it is 100% or 2/3 or otherwise as defined in the catalog or by the auctioneer, may not be subsequently divided without the express written consent of the seller.

## VIII. ANNOUNCEMENTS

Any changes from information of any kind in this catalog will be announced from the auction box and such announcements shall take precedence.

## IX. BREEDING GUARANTEE

Any female that has had a calf prior to the date of sale shall be considered a breeder without further guarantee. All females sold as 'bred' or 'pregnant' have been pregnancy checked by a licensed veterinarian and are guaranteed bred on the day of sale. The purchaser may elect to have any female so listed rechecked at their cost within 30 days of delivery by a licensed veterinarian of their choice. Any such female determined open by this recheck may be returned to the seller for a full refund. Due to conditions out of seller's control, once a female leaves seller's possession, this is the only guarantee offered.

All bulls are sold as guaranteed breeders. Each bull has been officially fertility tested as "Satisfactory Breeder" prior to the sale. However, seller cannot guarantee against physical injury or illness following the sale. But if within 8 months following the sale, the buyer has evidence that the animal is not a breeder, the buyer may obtain a statement signed by a licensed veterinarian to that effect, such statement also indicating that there has been no injury or illness to the animal following the sale, and return the bull to the farm of the seller for adjustment. If the seller cannot then prove the animal to be a breeder, an adjustment will be made by the seller, either by substituting an animal of equal value, or by the refund of the full purchase price. Such adjustment shall be considered full settlement and satisfaction of all claims. No guarantees apply to animals which are shown following the sale.

## X. GENETIC DEFECT GUARANTEE AND PARENTAGE

All parentage and pedigrees presented in the catalog are believed accurate based upon the breeding and DNA information we have available. However, parentage and pedigree information cannot be guaranteed 100%, because it is always possible that new information or new DNA technology and testing might show that there have been inadvertent errors.

Osteopetrosis: The Red Angus Association along with animal scientists have developed a DNA marker test for osteopetrosis (OS), a genetic disorder which in rare instances can cause the loss of a calf at birth. Since the test was developed, Beckton has tested every sire being used in our breeding program. Only one sire, from outside our program, tested positive as a carrier of the gene. Every sire bred and raised at Beckton has tested 'Free'. All of our major semen sires have also been tested 'Free'. We guarantee every sale animal to be OS Free, and if you have a concern, we will have any sale animal tested on request. If an animal were to test positive, we would replace the animal or refund the purchase price. The testing we have done shows no incidence of occurrence in any Beckton bloodlines for the past 30 years, and so we believe there is no safer herd than ours.

## XI. RETAINED INTEREST AND SEMEN RIGHTS:

Beckton is selling full possession and one half semen interest in all the bulls in the catalog. Seller is retaining one half interest in all bulls in the catalog. This is done so we can use some of the bulls in herd and reserve the right to collect and market semen on these bulls. Any collection on our behalf would be at our expense and could be done during the off-season and at the convenience of the buyer. The buyer would have the option to share in the collection and retain semen for the buyer's use also. If semen is marketed by either party, Seller receives one half royalty interest on gross semen sales, and buyer receives one half interest. Regardless of semen collection and marketing, the buyer retains full possession, full pasture use rights, and full salvage value in these bulls.

## XII. RIGHTS AND OBLIGATIONS

A. The above terms and conditions of sale shall constitute a contract between the Buyer and Seller of each animal and shall be equally binding upon both. Each sale or resale of an animal constitutes a separate transaction.

B. Neither the sale manager, the owner, nor any other person connected with the management of the sale, assumes any liability, legal or otherwise.



# RAAA Herd EPD Tables

## Proven and Genetic Opportunity Sires (Spring 2019)

	HB	GM	CED	BW	WW	YW	ADG	DMI	MILK	ME	HPG	CEM	STAY	MARB	YG	CW	REA	FAT
Min.	-139	6	-16	-13.6	-58	-105	-.31	-1.13	-20	-28	-9	-24	-13	-5.22	-1.10	-76	-1.40	-.26
<b>Avg.</b>	<b>168</b>	<b>48</b>	<b>12</b>	<b>-1.1</b>	<b>55</b>	<b>86</b>	<b>.19</b>	<b>0.81</b>	<b>23</b>	<b>0</b>	<b>11</b>	<b>7</b>	<b>16</b>	<b>.35</b>	<b>.10</b>	<b>14</b>	<b>-0.06</b>	<b>.02</b>
Max.	290	71	28	9.5	150	243	.58	2.85	50	25	24	21	28	1.57	.56	93	2.49	.14
1%	250	53	19	-5.5	79	129	.32	-0.10	34	-12	16	12	25	.72	-.08	38	.36	-.02
2%	241	52	18	-5.0	76	124	.31	0.01	33	-10	16	11	24	.68	-.05	35	.31	-.01
3%	235	52	18	-4.7	74	120	.30	0.07	32	-9	15	11	23	.65	-.04	33	.28	-.01
4%	230	52	17	-4.4	73	118	.29	0.12	31	-9	15	11	23	.63	-.03	32	.26	-.01
5%	226	52	17	-4.2	72	116	.29	0.17	31	-8	15	10	22	.61	-.03	31	.24	.00
<b>10%</b>	<b>213</b>	<b>51</b>	<b>16</b>	<b>-3.5</b>	<b>68</b>	<b>109</b>	<b>.27</b>	<b>0.31</b>	<b>29</b>	<b>-6</b>	<b>14</b>	<b>10</b>	<b>21</b>	<b>.56</b>	<b>.00</b>	<b>27</b>	<b>.17</b>	<b>.01</b>
15%	205	50	15	-3.1	65	105	.25	0.40	28	-5	13	9	20	.52	.02	25	.13	.01
20%	198	50	14	-2.7	63	101	.24	0.48	27	-4	13	9	19	.49	.04	23	.09	.01
25%	192	49	14	-2.4	62	98	.23	0.54	26	-3	12	8	19	.46	.05	21	.06	.01
30%	186	49	13	-2.1	60	95	.22	0.60	26	-2	12	8	18	.44	.06	19	.04	.02
35%	181	49	13	-1.8	59	93	.22	0.66	25	-2	12	8	17	.41	.07	18	.01	.02
40%	177	48	13	-1.6	57	90	.21	0.71	24	-1	11	7	17	.39	.08	16	-.01	.02
45%	172	48	12	-1.3	56	88	.20	0.76	24	0	11	7	16	.37	.09	15	-.04	.02
<b>50%</b>	<b>168</b>	<b>48</b>	<b>12</b>	<b>-1.1</b>	<b>55</b>	<b>86</b>	<b>.19</b>	<b>0.81</b>	<b>23</b>	<b>0</b>	<b>11</b>	<b>7</b>	<b>16</b>	<b>.35</b>	<b>.10</b>	<b>14</b>	<b>-0.06</b>	<b>.03</b>
55%	163	47	11	-0.8	53	83	.19	0.86	23	1	10	6	15	.33	.11	13	-.08	.03
60%	159	47	11	-0.6	52	81	.18	0.91	22	2	10	6	15	.31	.12	11	-.11	.03
65%	154	47	11	-0.3	51	79	.17	0.96	21	2	10	6	14	.29	.13	10	-.13	.03
70%	149	46	10	-0.1	49	76	.16	1.01	21	3	9	5	14	.27	.14	8	-.16	.03
75%	144	46	10	0.2	48	73	.16	1.07	20	4	9	5	13	.25	.15	7	-.18	.03
80%	138	46	9	0.6	46	70	.15	1.14	19	5	9	5	13	.22	.16	5	-.21	.04
85%	131	45	9	0.9	44	66	.14	1.21	18	6	8	4	12	.19	.18	3	-.25	.04
<b>90%</b>	<b>122</b>	<b>45</b>	<b>8</b>	<b>1.4</b>	<b>41</b>	<b>62</b>	<b>.12</b>	<b>1.31</b>	<b>17</b>	<b>7</b>	<b>7</b>	<b>4</b>	<b>11</b>	<b>.15</b>	<b>.20</b>	<b>1</b>	<b>-0.29</b>	<b>.05</b>
95%	109	44	7	2.1	37	55	.10	1.45	16	9	7	3	10	.09	.22	-3	-.36	.05

## Active Cows (Spring 2019)

	HB	GM	CED	BW	WW	YW	ADG	DMI	MILK	ME	HPG	CEM	STAY	MARB	YG	CW	REA	FAT
Min.	-8	40	-2	-10.6	5	1	-.02	-0.94	-3	-20	-3	-9	-5	-2.25	-.87	-29	-.74	-.16
<b>Avg.</b>	<b>178</b>	<b>48</b>	<b>12</b>	<b>-1.1</b>	<b>55</b>	<b>87</b>	<b>.20</b>	<b>0.82</b>	<b>24</b>	<b>1</b>	<b>11</b>	<b>7</b>	<b>17</b>	<b>.35</b>	<b>.10</b>	<b>14</b>	<b>-0.07</b>	<b>.02</b>
Max.	283	57	24	8.8	92	158	.47	2.67	48	28	23	16	29	1.38	.44	56	1.83	.10
1%	238	52	18	-5.6	75	121	.30	-0.06	35	-10	17	11	24	.68	-.06	34	.31	-.01
2%	231	52	18	-5.0	73	117	.29	0.05	34	-9	16	11	23	.64	-.04	31	.26	-.01
3%	226	51	17	-4.7	72	115	.28	0.11	33	-8	15	10	23	.61	-.03	30	.23	-.01
4%	223	51	17	-4.4	70	113	.28	0.16	32	-8	15	10	22	.60	-.02	29	.21	.00
5%	220	51	16	-4.2	69	111	.27	0.20	32	-7	15	10	22	.58	-.02	28	.20	.00
<b>10%</b>	<b>211</b>	<b>50</b>	<b>15</b>	<b>-3.5</b>	<b>66</b>	<b>106</b>	<b>.25</b>	<b>0.34</b>	<b>30</b>	<b>-5</b>	<b>14</b>	<b>9</b>	<b>21</b>	<b>.53</b>	<b>.01</b>	<b>25</b>	<b>.14</b>	<b>.00</b>
15%	205	50	15	-3.1	64	102	.24	0.43	29	-4	13	9	20	.49	.03	23	.10	.01
20%	200	49	14	-2.7	63	99	.23	0.51	28	-3	13	8	20	.46	.04	21	.07	.01
25%	195	49	14	-2.4	61	97	.23	0.57	27	-2	12	8	19	.44	.05	19	.04	.01
30%	192	49	13	-2.1	60	95	.22	0.63	26	-2	12	8	19	.42	.06	18	.02	.01
35%	188	48	13	-1.8	59	92	.21	0.68	26	-1	12	8	18	.40	.07	17	-.01	.02
40%	185	48	13	-1.6	57	91	.21	0.73	25	0	11	7	18	.38	.08	16	-.03	.02
45%	181	48	12	-1.3	56	89	.20	0.78	24	0	11	7	18	.36	.09	15	-.05	.02
<b>50%</b>	<b>178</b>	<b>48</b>	<b>12</b>	<b>-1.1</b>	<b>55</b>	<b>87</b>	<b>.20</b>	<b>0.82</b>	<b>24</b>	<b>1</b>	<b>11</b>	<b>7</b>	<b>17</b>	<b>.34</b>	<b>.10</b>	<b>14</b>	<b>-0.07</b>	<b>.02</b>
55%	175	48	11	-0.8	54	85	.19	0.87	23	1	10	6	17	.32	.11	13	-.09	.02
60%	172	47	11	-0.6	53	83	.19	0.92	23	2	10	6	16	.31	.12	11	-.11	.03
65%	168	47	11	-0.3	52	81	.18	0.97	22	3	10	6	16	.29	.13	10	-.13	.03
70%	165	47	10	-0.1	51	79	.17	1.02	21	3	9	6	16	.27	.14	9	-.15	.03
75%	161	47	10	0.2	49	77	.17	1.08	21	4	9	5	15	.24	.15	8	-.18	.03
80%	157	46	9	0.5	48	74	.16	1.14	20	5	9	5	15	.22	.16	6	-.20	.04
85%	152	46	9	0.9	46	71	.15	1.22	19	6	8	5	14	.19	.17	5	-.24	.04
<b>90%</b>	<b>146</b>	<b>45</b>	<b>8</b>	<b>1.4</b>	<b>44</b>	<b>68</b>	<b>.14</b>	<b>1.31</b>	<b>18</b>	<b>7</b>	<b>7</b>	<b>4</b>	<b>13</b>	<b>.16</b>	<b>.19</b>	<b>3</b>	<b>-0.28</b>	<b>.04</b>
95%	136	45	7	2.1	41	62	.12	1.45	16	9	7	3	12	.10	.21	-1	-.33	.05

## Non-Parents (Spring 2019)

	HB	GM	CED	BW	WW	YW	ADG	DMI	MILK	ME	HPG	CEM	STAY	MARB	YG	CW	REA	FAT
Min.	-54	34	-3	-11.5	0	0	-0.02	-1.66	0	-20	-4	-6	0	-0.32	-0.92	-62	-0.75	-0.19
<b>Avg.</b>	<b>177</b>	<b>48</b>	<b>12</b>	<b>-1.4</b>	<b>57</b>	<b>90</b>	<b>.21</b>	<b>0.88</b>	<b>23</b>	<b>1</b>	<b>11</b>	<b>7</b>	<b>17</b>	<b>.38</b>	<b>.10</b>	<b>16</b>	<b>.03</b>	<b>.02</b>
Max.	301	59	26	9.6	106	165	.46	2.80	40	17	25	15	30	1.39	.43	63	1.94	.12
1%	235	53	19	-5.6	77	125	.31	-0.01	32	-10	16	11	23	.73	-0.09	36	.36	-0.02
2%	228	52	18	-5.1	75	121	.30	0.10	31	-9	15	11	22	.69	-0.07	33	.32	-0.01
3%	224	52	18	-4.8	74	119	.29	0.16	31	-8	15	10	22	.67	-0.05	32	.29	-0.01
4%	221	52	17	-4.6	72	117	.29	0.21	30	-8	15	10	21	.65	-0.04	31	.27	-0.01
5%	218	52	17	-4.4	71	115	.28	0.25	30	-8	14	10	21	.63	-0.04	30	.25	-0.01
<b>10%</b>	<b>209</b>	<b>51</b>	<b>16</b>	<b>-3.7</b>	<b>68</b>	<b>110</b>	<b>.26</b>	<b>0.39</b>	<b>28</b>	<b>-6</b>	<b>13</b>	<b>9</b>	<b>20</b>	<b>.57</b>	<b>-0.04</b>	<b>27</b>	<b>.19</b>	<b>.00</b>
15%	203	50	15	-3.3	66	106	.25	0.49	27	-5	13	9	19	.54	.01	25	.15	.00
20%	198	50	15	-2.9	64	103	.25	0.56	27	-4	12	8	19	.51	.03	23	.11	.01
25%	194	50	14	-2.6	63	101	.24	0.62	26	-4	12	8	18	.48	.04	22	.09	.01
30%	190	49	14	-2.3	62	98	.23	0.68	25	-3	12	8	18	.46	.05	20	.06	.01
35%	187	49	13	-2.1	60	96	.23	0.73	25	-2	11	8	18	.44	.07	19	.04	.02
40%	184	49	13	-1.8	59	94	.22	0.79	24	-2	11	7	17	.42	.08	18	.01	.02
45%	181	49	13	-1.6	58	92	.21	0.83	24	-1	11	7	17	.40	.09	17	-0.01	.02
<b>50%</b>	<b>177</b>	<b>48</b>	<b>12</b>	<b>-1.4</b>	<b>57</b>	<b>90</b>	<b>.21</b>	<b>0.88</b>	<b>23</b>	<b>-1</b>	<b>11</b>	<b>7</b>	<b>17</b>	<b>.38</b>	<b>.10</b>	<b>16</b>	<b>-0.03</b>	<b>.02</b>
55%	174	48	12	-1.1	56	88	.20	0.93	23	0	10	7	16	.36	.11	15	-0.05	.03
60%	171	48	12	-0.9	55	87	.20	0.98	22	0	10	6	16	.34	.12	14	-0.07	.03
65%	168	48	11	-0.7	54	85	.19	1.03	22	1	10	6	15	.32	.13	12	-0.09	.03
70%	164	47	11	-0.4	52	82	.18	1.08	21	1	9	6	15	.30	.14	11	-0.12	.03
75%	161	47	10	-0.1	51	80	.18	1.14	21	2	9	6	15	.28	.15	10	-0.14	.03
80%	157	47	10	0.2	50	78	.17	1.20	20	3	9	5	14	.25	.16	9	-0.17	.04
85%	152	46	9	0.5	48	75	.16	1.28	19	3	8	5	14	.23	.18	7	-0.20	.04
<b>90%</b>	<b>146</b>	<b>46</b>	<b>9</b>	<b>1.0</b>	<b>46</b>	<b>71</b>	<b>.15</b>	<b>1.37</b>	<b>18</b>	<b>4</b>	<b>8</b>	<b>5</b>	<b>13</b>	<b>.19</b>	<b>.20</b>	<b>5</b>	<b>-0.25</b>	<b>.05</b>
95%	137	45	8	1.6	43	66	.14	1.51	17	6	7	4	12	.13	.23	2	-0.30	.05

## EPD Accuracies and Possible Change

EPDs are predictions, not true values, and we can therefore expect that EPDs will change from sire evaluation, as more information (i.e. progeny data) is included. A possible change value is an estimate of the amount of change (in trait units) that can be expected for a given EPD.

Technically, there is a 68% chance that the real genetic value (an EPD with a accuracy of 1.0) for any trait lies between its EPD plus its possible change value and its EPD minus its possible change value. For example, if a sire has a weaning EPD of +25 lb. and a possible change value of 10 lb., we can expect the true genetic value to be between +15 lb. (25 - 10) and +35 lb. (25 + 10) 68% of the time. We should not be surprised if his EPD in next year's evaluation is as high as +35 or as low as +15. If next year's EPD should happen to be slightly outside of this

range, keep in mind there is nearly a one-in-three chance of that happening; however, significantly larger deviations can occur.

Possible change is simply another way of expressing accuracy of an EPD. High accuracy sires will have small possible changes and vice versa. Many breeders feel that possible change values complement accuracies and help them determine just how thoroughly an animal has been evaluated. The accuracy/possible change chart lists possible changes in EPDs that can be expected with different levels of accuracy for the various traits.

For more information on possible change values, please see the article by Dr. Bob Hough titled "Understanding EPD Accuracies and Possible Change". This article can be downloaded from the Red Angus Association of America website at [www.redangus.org](http://www.redangus.org).

Accuracy	CED	BW	WW	YW	DMI	MILK	ME	HPG	CEM	STAY	MARB	YG	CW	REA	FAT
<b>0.0</b>	7.8	3.0	16.3	25.7	.92	11.9	3	11	7.9	7.1	.26	.20	19.3	.43	.04
<b>0.1</b>	7.0	2.7	14.7	23.1	.82	10.7	2	10	7.1	6.4	.23	.18	17.4	.39	.04
<b>0.2</b>	6.2	2.4	13.0	20.6	.73	9.5	2	9	6.3	5.7	.21	.16	15.4	.34	.03
<b>0.3</b>	5.4	2.1	11.4	18.0	.64	8.3	2	8	5.5	4.9	.18	.14	13.5	.30	.03
<b>0.4</b>	4.7	1.8	9.8	15.5	.55	7.1	2	7	4.7	4.2	.16	.12	11.6	.26	.02
<b>0.5</b>	3.9	1.5	8.2	12.9	.46	6.0	1	6	3.9	3.5	.13	.10	9.7	.22	.02
<b>0.6</b>	3.1	1.2	6.5	10.3	.37	4.8	1	4	3.1	2.8	.10	.08	7.7	.17	.02
<b>0.7</b>	2.3	0.9	4.9	7.7	.27	3.6	1	3	2.4	2.1	.08	.06	5.8	.13	.01
<b>0.8</b>	1.6	0.6	3.3	5.1	.18	2.4	1	2	1.6	1.4	.05	.04	3.9	.09	.01
<b>0.9</b>	0.8	0.3	1.6	2.6	.09	1.2	0	1	0.8	0.7	.03	.02	1.9	.04	.00
<b>1.0</b>	0.0	0.0	0.0	0.0	.00	0.0	0	0	0.0	0.0	.00	.00	0.0	.00	.00

# Sire Bloodline Charts

Name Family

- Accent A
- Cardinal C
- Cherokee C
- Clifftop C
- Clipper A
- Cody A
- Dominor D
- Epic E
- Hasten H
- Herald H
- Heritage H
- Hughes B
- Hustler H
- Javelin J
- Jet J
- Julian J
- Lancer L
- Legend L
- Likable L
- Nebula N
- New Era N
- Nomad V
- Ranger R
- Roosevelt B
- Scamp S
- Warrior W

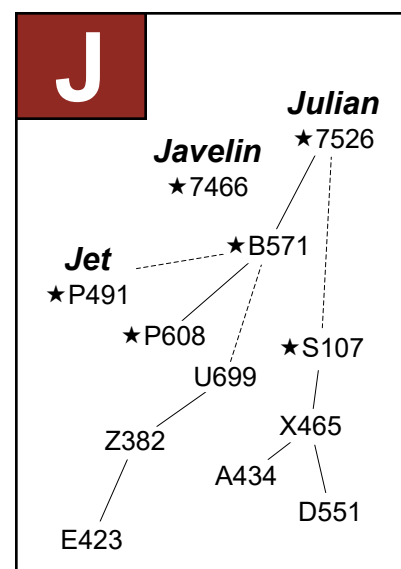
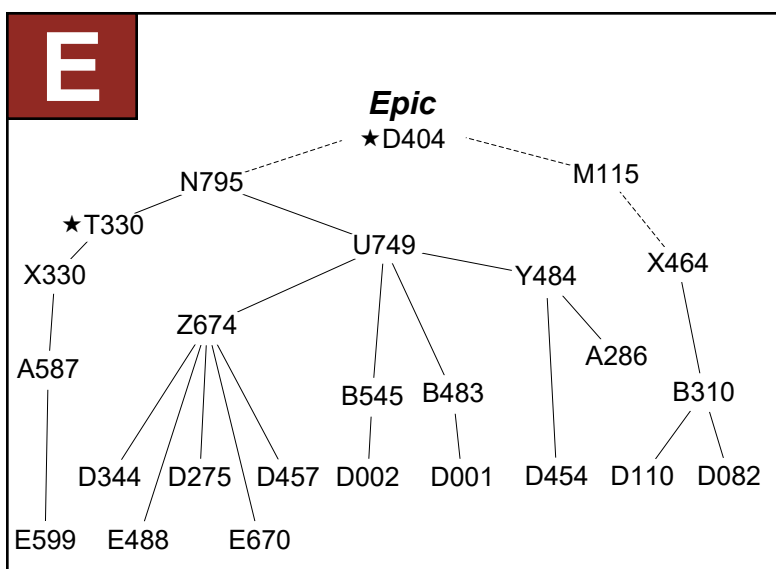
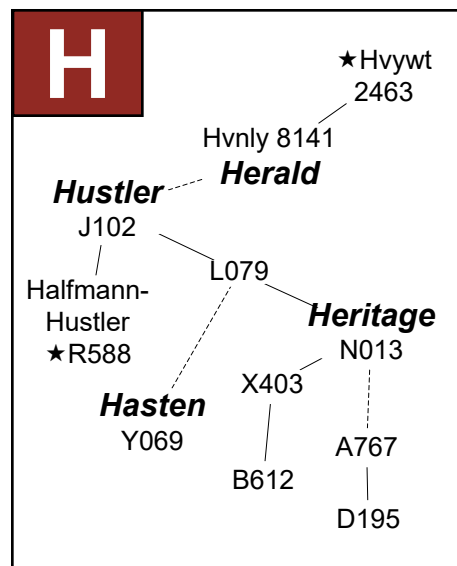
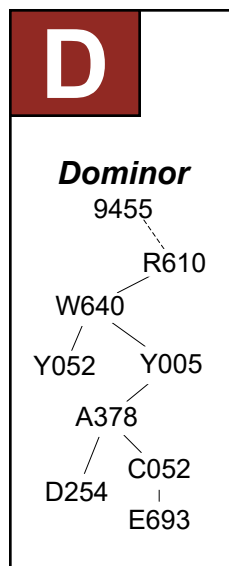
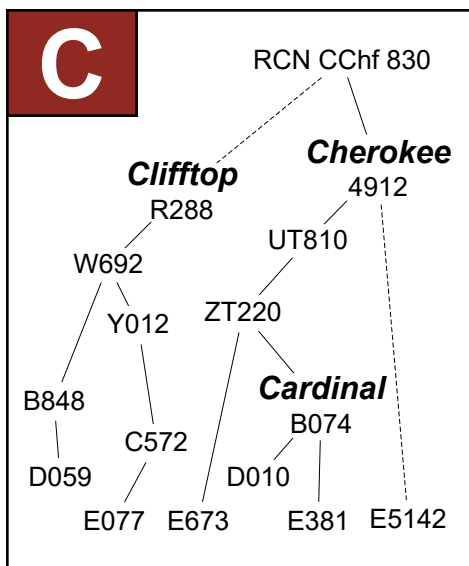
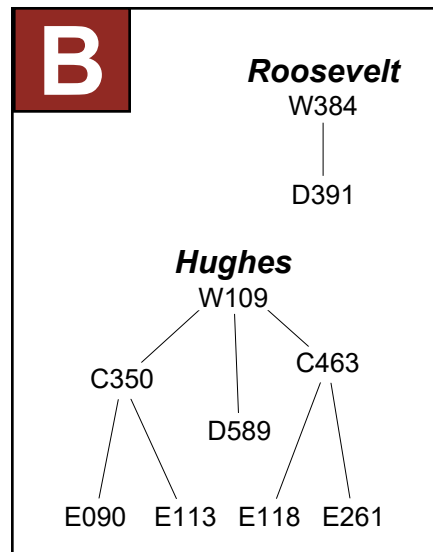
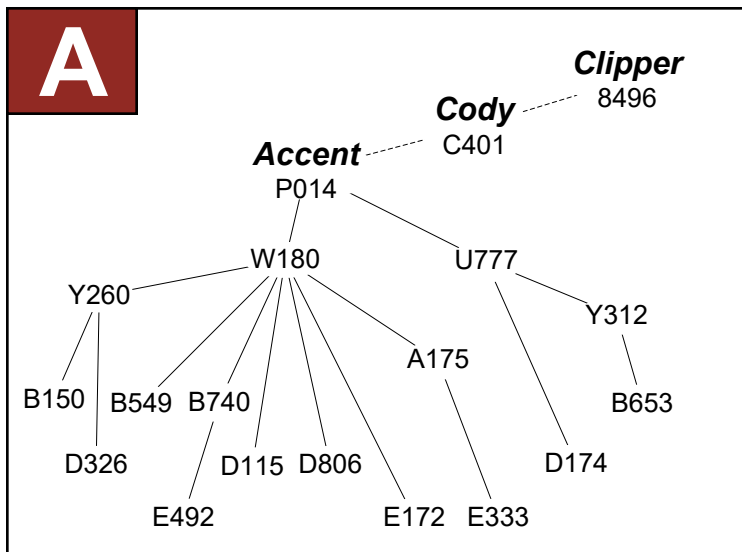

★ Red Angus Trait Leader



# L

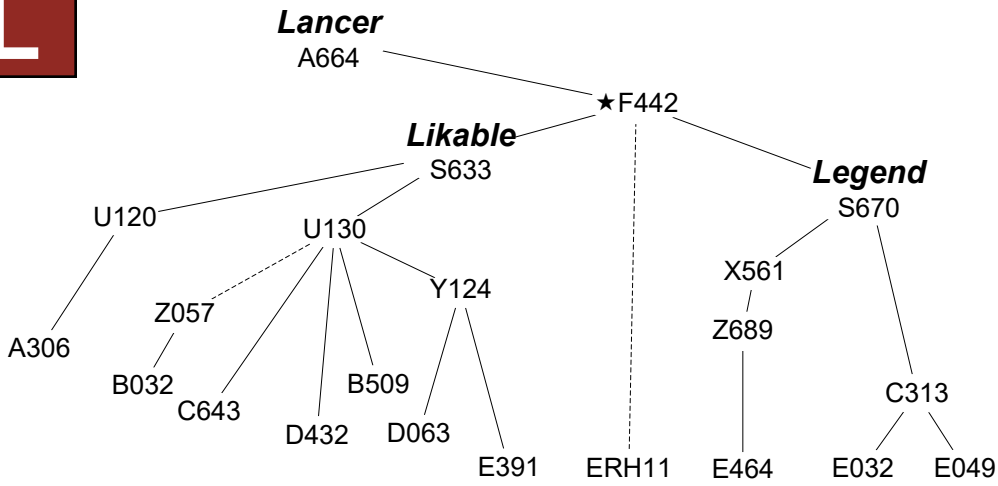

# N

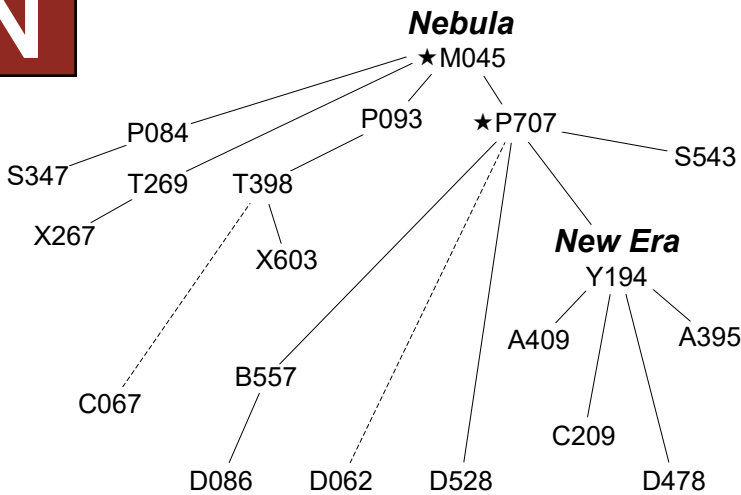

# R

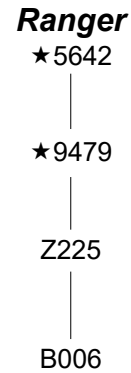

# S

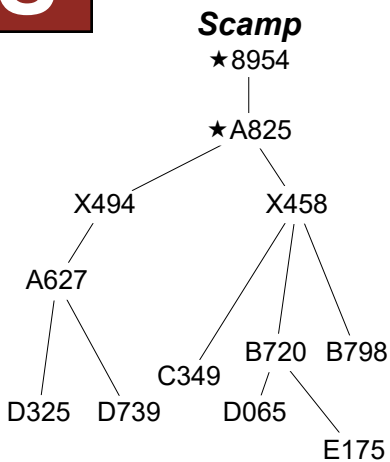

# V

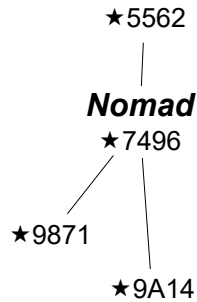

# W

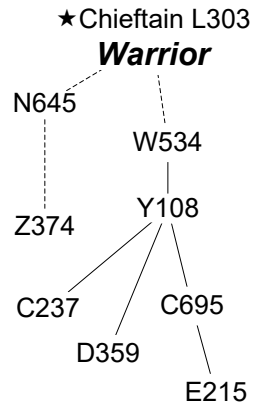

Name	Tag	Family
Javelin	7466	J-1
Nomad	7496	V
Nomad	9871	V
Epic	A286	E-3
Dominor	A378	D-1
Julian	A434	J
Ranger	B003	R-1
Likable	B032	J-2
Accent	B150	A-2
Epic	B310	E-4
Epic	B483	E-5
Likable	B509	L-3
Epic	B545	E-6
Accent	B549	A-3
Nebula	B557	N-3
Julian	B571	J-2
Heritage	B612	H-1
Accent	B653	A-4
Scamp	B720	S-1
Dominor	C052	D-2
Warrior	C237	W
Scamp	C349	S-2
Likable	C643	L
Epic	D001	E-7
Epic	D002	E
Cardinal	D010	C-2
Clifftop	D059	C-3
Likable	D063	L-4
Scamp	D065	S
Epic	D082	E
Epic	D110	E-8
Accent	D115	A-5
Accent	D174	A-6
Heritage	D195	H-2
Dominor	D254	D-3
Epic	D275	E-9
Scamp	D325	S-3
Accent	D326	A-7
Epic	D344	E
Warrior	D359	W-1
Roosevelt	D391	B
Likable	D432	L-5
Epic	D454	E-10
Epic	D457	E-11
New Era	D478	N
Julian	D551	J-3
Hughes	D589	B-1
Scamp	D739	S-4
Accent	D806	A-8
Epic	M115	E
Nebula	P084	N
Jet	P491	J
Nebula	P707	N-1
Dominor	R610	D
Nebula	S347	N
Accent	W180	A-1
Nebula	X603	N-2
Dominor	Y052	D
New Era	Y194	N-4
Epic	Y484	E-1
Likable	Z057	L-1
Epic	Z674	E-2
Dbl Eagle	ZT220	C-1

# Lot-Tag Cross Reference

ID	Lot	ID	Lot	ID	Lot	ID	Lot	ID	Lot	ID	Lot	ID	Lot
<i>Bulls</i>								<i>Heifers</i>				<i>Ref. Sires</i>	
F001	.72	F195	.81	F384	.138	F571	.69	F733	.58	F034	.306	7466	J-1
F003	.54	F196	.55	F385	.30	F574	.73	F736	.128	F054	.320	A286	E-3
F008	.66	F197	.32	F386	.100	F576	.232	F739	.179	F080	.317	A378	D-1
F012	.47	F198	.84	F388	.135	F579	.212	F740	.192	F083	.315	B006	R-1
F015	.88	F202	.204	F392	.9	F582	.199	F743	.163	F128	.314	B032	L-2
F017	.31	F204	.24	F396	.147	F583	.166	F747	.136	F147	.302	B150	A-2
F022	.139	F206	.221	F401	.211	F584	.117	F748	.101	F176	.328	B310	E-4
F026	.104	F208	.87	F404	.226	F587	.125	F761	.172	F178	.312	B483	E-5
F029	.22	F210	.105	F406	.75	F589	.157	F763	.134	F185	.318	B509	L-3
F030	.151	F216	.56	F407	.7	F595	.224	F766	.168	F215	.304	B545	E-6
F036	.142	F218	.227	F411	.45	F596	.225	F769	.95	F274	.301	B549	A-3
F039	.83	F228	.5	F414	.26	F598	.112	F771	.170	F286	.307	B557	N-3
F041	.217	F235	.70	F415	.16	F606	.184	F775	.164	F309	.308	B571	J-2
F042	.41	F239	.14	F416	.219	F607	.61	F778	.159	F318	.311	B612	H-1
F044	.210	F255	.43	F419	.77	F612	.141	F780	.233	F353	.303	B653	A-4
F057	.153	F256	.132	F425	.4	F618	.194	F782	.167	F373	.327	B720	S-1
F064	.109	F264	.206	F428	.38	F619	.130	F783	.171	F378	.329	C052	D-2
F078	.127	F272	.231	F430	.57	F627	.176	F788	.186	F413	.321	C349	S-2
F079	.111	F276	.201	F436	.13	F629	.99	F793	.175	F431	.313	D001	E-7
F081	.145	F283	.8	F443	.86	F632	.44	F796	.64	F432	.316	D010	C-2
F082	.35	F284	.218	F452	.185	F633	.96	F799	.198	F447	.330	D059	C-3
F088	.79	F289	.17	F454	.230	F634	.114	F802	.94	F508	.309	D063	L-4
F090	.126	F290	.181	F458	.15	F635	.60	F804	.98	F527	.310	D110	E-8
F091	.158	F291	.209	F460	.48	F636	.193	F814	.187	F542	.305	D115	A-5
F097	.107	F292	.110	F463	.123	F639	.190	F836	.97	F543	.325	D174	A-6
F103	.146	F293	.25	F465	.122	F641	.53	FC134	.42	F565	.322	D195	H-2
F108	.207	F294	.46	F469	.6	F642	.59	FC135	.67	F654	.319	D254	D-3
F110	.36	F308	.216	F472	.215	F645	.195	FC139	.154	F912	.324	D275	E-9
F115	.106	F313	.162	F482	.29	F646	.103			F922	.326	D325	S-3
F116	.21	F315	.140	F488	.155	F651	.92			F923	.323	D326	A-7
F117	.76	F317	.33	F489	.143	F652	.177					D359	W-1
F118	.120	F325	.78	F492	.118	F655	.93					D432	L-5
F119	.133	F327	.161	F493	.144	F656	.183					D454	E-10
F125	.131	F329	.165	F494	.152	F658	.182					D457	E-11
F135	.148	F337	.1	F505	.235	F664	.197					D551	J-3
F136	.51	F338	.223	F506	.28	F685	.178					D589	B-1
F137	.74	F339	.85	F510	.208	F690	.174					D739	S-4
F140	.49	F340	.20	F512	.18	F691	.12					D806	A-8
F144	.2	F341	.124	F516	.119	F692	.62					P707	N-1
F148	.220	F346	.180	F522	.222	F698	.191					W180	A-1
F150	.102	F347	.71	F524	.228	F699	.156					X603	N-2
F151	.50	F351	.11	F526	.116	F702	.63					Y484	E-1
F156	.19	F358	.115	F538	.89	F703	.189					Z057	L-1
F158	.37	F361	.80	F540	.196	F709	.203					Z674	E-2
F162	.52	F365	.113	F541	.68	F712	.173					ZT220	C-1
F164	.39	F369	.82	F546	.214	F716	.202						
F165	.205	F370	.200	F553	.234	F718	.169						
F173	.34	F371	.23	F555	.129	F719	.91						
F180	.40	F372	.213	F558	.121	F720	.160						
F186	.150	F374	.10	F559	.27	F724	.108						
F191	.3	F376	.65	F560	.229	F726	.90						
		F381	.149	F567	.137	F727	.188						

# Family who help us in many ways over the course of the year



*Jeff, Katie, Julia, Ellen, and Sarah Durkin*



*Sheila and Doug Bingham*



*Julia Forbes and Ed Waddington  
(with Tazmin and Flinder)*



*Doug Foster and Sarah Forbes*



*Don Bingham, Kate Bingham, Sandra Brody, and Alison Brody*



*Elfie Forbes and Ruth Sylvester*



*Jason Brown and Shelley Forbes  
with new addition Nolan*



*Stephen Forbes and  
Morgan Baldwin*



*Justin Lee and Tallie Forbes  
with Claire and new addition Ryan*



# Beckton Stock Farm

Cam Forbes

37 Beckton Drive

Sheridan, WY 82801

Tel.: 307.674.6095, 674.8162 (evening)

Fax: 307.672.7281

Email: becktonwyo@gmail.com

Web: www.BecktonRedAngus.com

Video of Sale Bulls available on our Website

## FIRST CLASS

### Bulls to Build a Herd and more!!!

**The 1-A Red Angus bulls in this sale have an average Herd Builder Index of 212, compared to the Red Angus breed average of 177!!! 14 of the top 20 highest ranking sires in the Red Angus breed for HerdBuilder are Beckton sires or descended from Beckton sires.**

**HERD STAYABILITY** – Beckton is the #1 Herd in the breed for Stayability, and has been for many years. **11 of the top 20 sires in the breed for Stayability EPD are Beckton sires or descended from Beckton sires.**

**LOW MAINTENANCE ENERGY** – Beckton has also been the #1 Herd for Low Maintenance Energy requirements for many years. **13 of the top 20 sires in the entire breed for lowest Maintenance Energy EPD are Beckton sires or descended from Beckton sires.**

**EASY CALVING** – The #1 Herd in the breed for easy calving, with the best average Calving Ease EPD of any major herd. **18 of the top 20 sires in the breed for best Calving Ease EPD are Beckton sires or descended from Beckton sires.** The average Calving Ease EPD of all 235 sale bulls is +16, which is the top 10 % of the Red Angus breed.

**GROWTH RATE from Birth to Market** – Here is the best volume of bulls combining this high calving ease with high growth rate to market weight, together with fertility and Stayability.

**These are the bulls and heifers to build you the best possible cow herd, with cattle that will stay in your herd for many years.**

HerdBuilder Beef bulls, Lot 1 all the way to Lot 235, Ready to Work.



Lot 221



Lot 228



Lot 235



Superior Productions will provide internet and representative bidding services for buyers who can't make it to the sale. Please see page 3 for more information.

**Free Delivery**  
anywhere in the Continental US