

75th Anniversary Production Sale

Tuesday April 14th, 2020

Industry Leader for
Low Maintenance, Maternal Traits

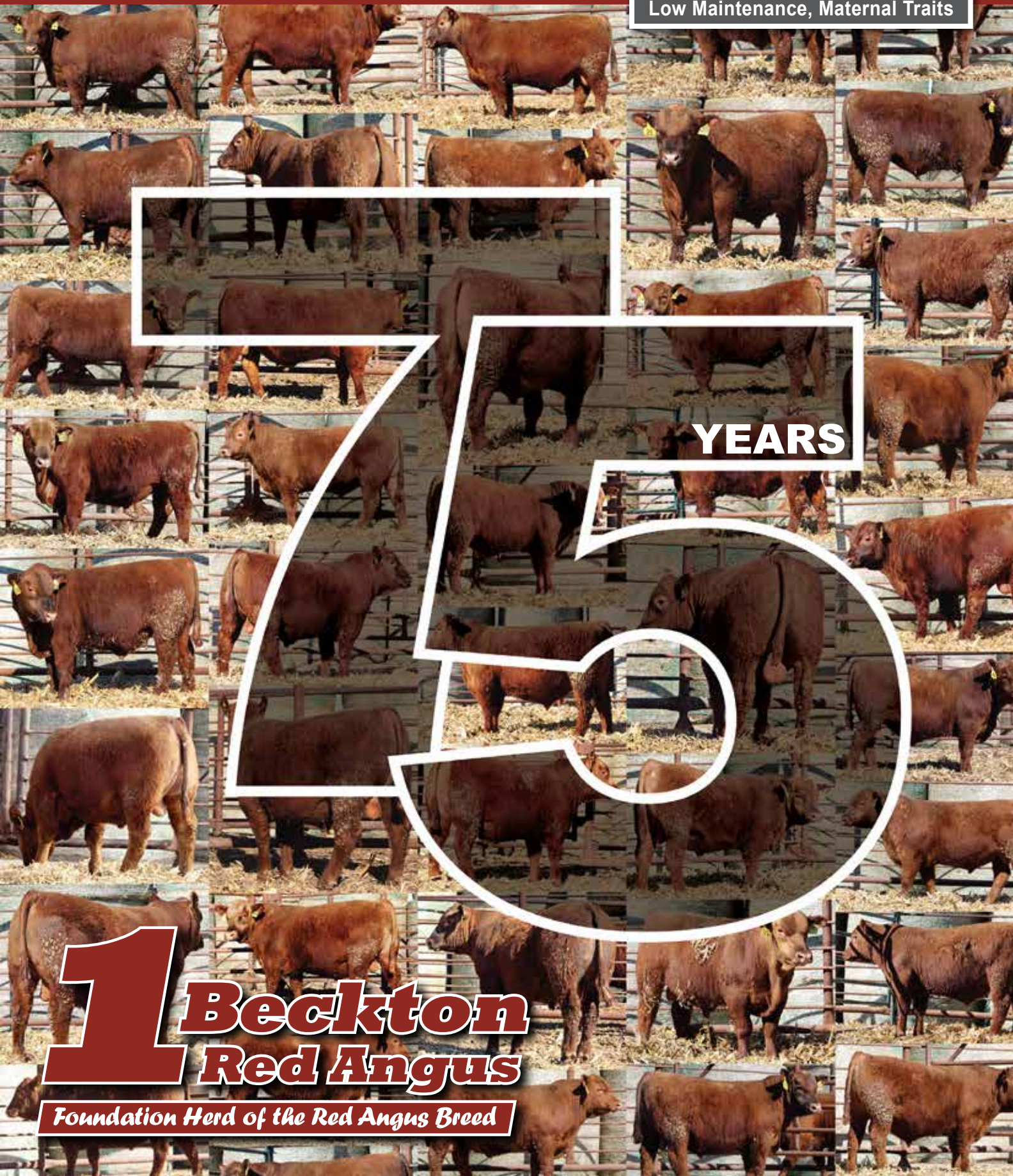

YEARS

**1 Beckton
Red Angus**

Foundation Herd of the Red Angus Breed

1 Beckton Red Angus

37 Beckton Drive • Sheridan, WY 82801 • becktonwyo@gmail.com
Office: 307.674.6095 • Evenings: 674.8162 • Fax: 672.7281

Dear Friends and Cattlemen,

Welcome to Beckton's 75th Anniversary Sale !! It has been that long since our family started putting together the very first herd of Red Angus cattle, basing our new herd on genetic science and selection. The cattle and genetics have come a long way since then. This year both bulls and heifers have come through a nice winter, and they look really good. We hope you can take advantage of this opportunity to see them.

We refer often to the Herd Builder Index, because it is to date the best indicator of overall commercial cattle profitability put together by the Red Angus Association. All of the economically relevant traits (fertility, growth, carcass, etc.) which go into this Index value are genetically heritable, which means as you keep replacement females from these bulls, you also increase the long-term base profit potential of your cowherd. Ag economists have long known that the traits which most improve ranch profitability are the "maternal" traits like fertility and calving ease, which increase calving percentage and weaning percentage. Weaning percentage has always been more important than weaning weight. Beckton genetics are famous for being maternal genetics. They excel year after year on those measures, and today 43 of the top 50 sires in the breed for Herd Builder traits use Beckton bloodlines.

Something new in our catalog this year is a beef "Tenderness" Score. It is well known from scientific research that the Calpain and Calpastatin enzymes are important to the tenderness and eating quality of beef. Neogen Corp uses DNA technology to measure these enzymes, plus myostatin, in individual animals. Results are provided on a simple 1 to 10 scale, with 10 being the best. The beef industry average is 6.

Since 2007 we have been using this measure in our herd sire selection to build inherent beef tenderness into our herd genetics. The results have been phenomenal. Today the preponderance of our herd sires measure 8, 9, or 10, with the average about 9, compared to an industry average of 6. We are very near the max. We realize this is a trait which will take time to develop in the current commercial feedlot/packer industry. But we believe beef tenderness is an important trait for the overall competitive position of beef in the marketplace. It is a trait we want to develop, produce, and help build into the beef industry.

Tenderness is a trait that will already benefit producers raising grass-fed or "natural" specialty beef for local high-end markets. We have quite a few of these bull customers. For this reason we are including for each sale animal the Igenity Tenderness Score for their sire. A chart below shows how to rank the measure.

We welcome you again to our 75th. Please join us for our complimentary prime rib dinner at the Holiday Inn right after the sale ends. We look forward to seeing you on Tuesday the 14th, and will help you however we can.

Sincerely,

Cam Forbes



Cam and Trish Forbes

Tenderness Scores:

Outstanding	9-10
Very Good	7-8
Average	5-6
Poor	3-4
Very Poor	1-2

Beckton Red Angus • Since 1945
The Foundation Herd of the Red Angus Breed

Sale Information

Beckton Ranch

9½ miles West of Sheridan

Phone: 307.674.6095

Please join us for a complimentary dinner after the sale at the Holiday Inn.

Tuesday, April 14th, 2020

1 o'clock pm (Lunch at noon)

237 Bulls • 43 Heifers

Selling in catalog order, heifers sell following the bulls



Some Facts about the Beckton Herd

The Herd Builder Index is the best measure of overall commercial cattle profitability developed by the Red Angus Association, and Beckton has the best overall selection of high Herd Builder bulls in the industry. **An amazing 17 of the top 20 highest ranking sires in the Red Angus breed (and 43 of the top 50) for Herd Builder profitability are Beckton sires or descended from Beckton sires.** Just the average Beckton bull in our sale is in the top 20% of the breed. If you keep your own heifers for replacements, select bulls in the top third or at least the top 50% of the breed.

► **HERD STAYABILITY:** Beckton is the #1 Herd in the breed for Stayability, and has been for many years. **7 of the top 10 sires in the breed for Stayability EPD are Beckton sires or descended from Beckton sires.**

► **EASY CALVING:** The #1 Herd in the breed for easy calving, with the best average Calving Ease EPD of any major herd. **18 of the top 20 sires in the breed for best Calving Ease EPD are Beckton sires or descended from Beckton sires.** If you are breeding heifers, these are your top choice.

► **LOW MAINTENANCE ENERGY:** Beckton has also been the #1 Herd for Low Maintenance Energy requirements for many years, with more of the top 10 sires than any other herd.

► **OTHER IMPORTANT TRAITS:** Fast Gainability to an early market weight; good Disposition; Fertility; Mothering ability and good Udders; Adapted both to short grass range and High Altitudes; very good Marbling and Carcass quality. **Our genetics have been developed over 75 years to thrive in Wyoming without supplemental feed.**

Sale Details

Site-Unseen Purchase

If you are unable to attend the sale, we can help you select the bulls or heifers to fit your needs. Give us a call, letter, fax or email, and we can handle bidding for you according to your directions. Satisfaction is guaranteed on all animals purchased "sight-unseen". Over a quarter of our bulls sell this way, mostly to long-time and repeat customers. To provide adequate time to assist you, please contact us before actual sale day.

Internet Bidding via Superior Productions

Internet bidding and phone bidding are now available with Superior Productions. See more information on page 3.

Conference Call Buying

Conference call bidding will be available with Bill Pelton, Pelton Livestock. See more information on page 3.

Payments

Payments can be made with cash, check payable to Beckton Stock Farm, Inc. or Visa/Mastercard on sale day.

All Bulls "Trich" Tested

In all the years we have been selling and delivering bulls, Beckton has never had a bull test positive for "trich". But because an increasing number of states require testing of yearling bulls, and to avoid any delay in delivery time, we will have all the sale bulls tested negative for "trich" prior to the sale. Customers from any state may also come to the sale with their trailer and load out directly after the sale.

Free Delivery

We provide free delivery for all bulls throughout the continental U.S. If you bring a trailer to haul your own, \$200 will be deducted from the price of each bull. Heifers will be delivered free within 400 miles, and at cost for additional miles. Most of the sale cattle will be delivered from 1 to 3 weeks after the sale, although we will try to accommodate if you need your bulls right away. Although there occasionally are limitations, in most cases we can deliver the cattle directly to your ranch.

Accommodations

Holiday Inn

307.672.8931, I-90, Exit 25
Ask for special Beckton Sale rate

Best Western Sheridan Center

307.674.7421, 612 N. Main Street

Days Inn

307.672.2888, 1104 Brundage Lane

Super 8 Motel

307.672.9725, 2435 N. Main Street

Transportation

United / United Express

Daily CRJ200 flights between Denver and Sheridan
www.united.com

Avis Car Rental

307.672.2226, Sheridan Airport



Auctioneer Roger Jacobs
406.698.7686



Bob Hough
817.296.0976



Pete Crow
Western Livestock
Journal
303.722.7600



Curt Cox
Wyoming Livestock
Roundup
307.630.4604



Matt Wznick
Tri-State Livestock
406.489.2414



Alan Sears
Western Ag Reporter
970.454.3986

Additional Sale Information

- ▶ The animals sell in catalog order. We will have a conference call available for telephone bidding. You must register in advance, and conference number and instructions will be available then.
- ▶ All bulls have passed a rigorous fertility exam that included live semen evaluation, scrotal measurements, and reproductive tract examinations.
- ▶ Beckton has a comprehensive herd-wide health program which includes vaccinations for 7-Way, IBR, BVD, PI3, BRSV, Lepto, and ivermectin. The heifers are also vaccinated for bangs and vibrio.
- ▶ When a genetic test was developed by RAAA for osteopetrosis (OS), Beckton tested every sire in use in our program, as well as our major AI sires. Every Beckton bred sire (nearly 80 in total) tested OS Free.
- ▶ We plan to have semen collected on some of the bulls before the sale. We will also work with the buyer to collect bulls after the sale.
- ▶ Buyer receives full possession and one half semen interest in all the bulls in the catalog. Seller is retaining one half interest in all bulls in the catalog. This is done so we can use some of the bulls in herd and reserve the right to collect and market semen on these bulls. Any collection on our behalf would be at our expense and could be done during the off-season and at the convenience of the buyer. The buyer would have the option to share in the collection and retain semen for the buyer's use also. If semen is marketed by either party, Seller receives one half royalty interest on gross semen sales, and buyer receives one half interest. Regardless of semen collection and marketing, the buyer retains full possession, full pasture use rights, and full salvage value in these bulls.
- ▶ Payments can be made with cash, check payable to Beckton Stock Farm, Inc. or Visa/Mastercard on sale day.

Table of Contents

The Beckton Program	4
The Bulls	10
The Yearling Heifers	58
Ref. Sire Cross Reference. . .	64
Reference Sires.	65
Sale Terms & Conditions . . .	75
RAAA Herd EPD Tables	76
Sire Bloodline Charts.	78
Lot-Tag Cross Reference. . . .	80



Serving our customers for 75 years with industry leading genetics and the highest quality cattle.



BECKTON BULL AND HEIFER WARRANTY

Optional protection against injury or death, plus Pregnancy coverage for heifers

BULLS: Injury or loss protection coverage - If your bull is permanently injured or dies any time up to 5 months after purchase, you will receive a credit toward purchase of another bull in the amount of the original purchase price minus salvage. The cost is 5% of the purchase price paid at settlement (eg. \$150 for a \$3,000 bull).

HEIFERS: Injury or loss protection plus Pregnancy Guarantee – likewise good for 5 months after purchase. If your heifer fails to become pregnant when exposed to a bull who settles 75% of the other heifers in the same pasture; or in the event your heifer is permanently injured or dies, you will receive a credit toward purchase of another heifer in the amount of the original purchase price minus any salvage. The cost is 10% of the purchase price paid at settlement (eg. \$200 for a \$2,000 heifer).

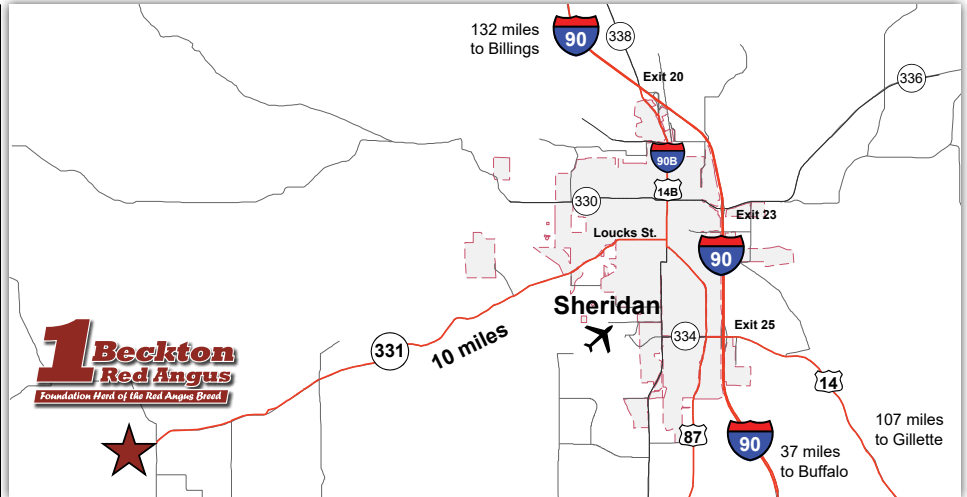

How to Participate as an Absentee Bidder: 1, 2, or 3

1. Site-Unseen Purchase

If you are unable to attend the sale, we can help you select the bulls or heifers to fit your needs. Give us a call, letter, fax or email, and we can handle bidding for you according to your directions. Satisfaction is guaranteed on all animals purchased "sight-unseen". Over a quarter of our bulls sell this way, mostly to long-time and repeat customers. To provide adequate time to assist you, please contact us before actual sale day.

2. Superior Livestock Productions

Turn in Bids Over the Phone. To get started simply go online to www.superiorlivestock.com and click on the tab titled "Register for a Buyer Number". Select the registration form for Superior Productions and print the registration form, fill it out and fax it in to Superior Productions at (817) 378-3380 with a signature on it, or scan and email the form to info@superiorauction.com. You can also mail it in to the address provided on the form. Upon receipt of this information Superior will call you with a buyer's number and the bid line phone number that you will use on sale day to place bids over the phone. **Important: If you plan to bid by phone through Superior Livestock or 'Click-to-Bid', you must register at www.superiorlivestock.com prior to bidding.**

Click-To-Bid. This is Superior's online bidding platform for cattle buying. Please note that high speed internet is required – this is not for dial-up or satellite internet. Registration is free, but you must become a member of www.superiorclicktobid.com to sign up. Becoming a member is easy - just go to the homepage of www.superiorclicktobid.com and follow the out-lined steps to get started. Input your information and select a username and password. You will receive an e-mail confirming you are a member. From that point forward you just have to sign in and select the sale you would like to register for and once approved you will receive an e-mail confirming which sale you are now registered for.

3. Sale Day Conference Call

Our goal is to have you in the seats but if you can't make it on sale day, we're fixin' to get you "on the line!"

Easy as 1~2~3
Call BILL PELTON in Advance to...

1. Pre-Register for your buyer number
2. Receive the toll-free Call in Number & Pin
3. Get last minute instructions for the call

Pelton Livestock
Marketing & Consulting
www.billpelton.com | 406-671-5100



Buyers purchasing via Superior or Pelton Livestock can mail a check after the sale with brief delivery instructions and an approximate date you would like delivery by. If you would like to pay with a credit card, please call the office the day after the sale

The Beckton Program

Cow Size

The goal for Beckton's program has always been to develop breeding seedstock which offer increased levels of performance for the commercial cattleman. Increased performance does not mean maximizing weight and size, which have already reached the upper limit of economic value for the packer and consumer. It does, however, mean increasing performance related to calving percentage and weaning percentage; and increasing performance related to cow maintenance requirements and "pounds of calf per acre" efficiency.

Size Matters

Beckton cattle are already big enough for the consumer and the packer. Using yearling weight EPD as the best available indicator of market size, the average for our sale bulls is +80, about the same as the Red Angus breed average, so for market size our cattle are directly comparable.

The big difference with Beckton's program is that we select for additional weaning and yearling weight, but with the restriction that we have maintained the same cow size over time. In contrast, the industry has allowed cow size to increase at the same rate as calf size. Cow size is the largest factor determining maintenance requirements. Our goal has been to increase efficiency, not size. No other seedstock breeding program has had such a goal and maintained it for so long.

Beckton Cow Weight Average (lb.)

Year	1978	1986	1994	2002	2010	2018
Weight	1,126	1,064	1,067	1,104	1,068	1,074

(mature lactating cows taken at weaning)

Cow weights vary from year to year depending on grass, weather or other short term factors. But overall our cow size has stayed fairly constant over time.

The Industry Problem

As shown on the graph on the next page, industry-wide cow size has increased substantially, 31% since 1978. Hay use per cow has increased even more, from 1.43 tons per animal to 1.91 tons.

Why does hay use increase at a faster rate than cow size or production per cow? Hay and grain are supplements to the cow's main diet, which is grass, and grass supply is relatively fixed by environment. Each increase in cow feed requirement must be met entirely by supplements, or by a combination of supplement and reduced stocking rate. A small increase in cow feed requirement leads to a reduction in stocking rate or a large increase in higher-cost, supplemental feed needs.

Any gains achieved in the feedlot sector due to increased animal growth, have been overwhelmed by increased cost of production in the cow-calf sector.



The Beckton Crew...



Randy Zier



Alan Sanders



Roger Zier



Shelby MacMillan

Efficiency

The graphic at right shows how, for the U.S. cattle industry overall, the increase in average calf weights, as measured by steer slaughter weights, has been directly matched by an increase in average cow weights. (Percentages are based on USDA slaughter weight data for steers and cows respectively, using 1978 as a base year. Data for heifers slaughtered shows an identical trend.) Over 40 years, there has been minimal change in overall cowherd efficiency.

This graph shows the failure of cross-breeding and composite breeding to do little more than simply increase general cattle size. In the promotion of composites, the impact of retained heterosis on mature weight is too often ignored. Crossbreeding and composites are sold as a free lunch, but they aren't free.

The graphic shows Beckton cowherd data over the same time period.

1. Beckton cow size has shown no significant change over the past 40 years, while the industry has experienced a substantial increase in cow size.

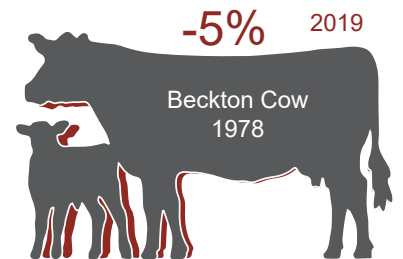
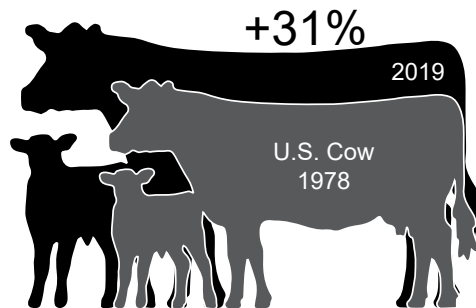
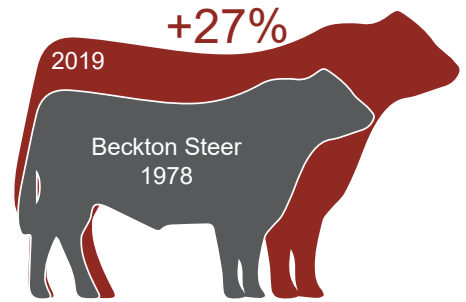
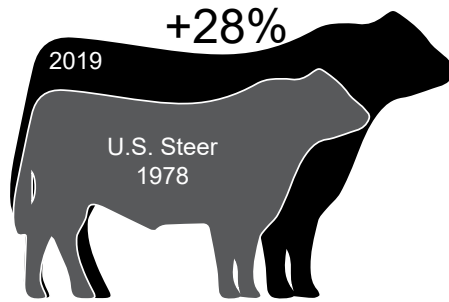

2. Even without increasing cow size, we have raised the rate of early growth in Beckton cattle, using intense genetic selection and generation turnover.
3. The net change in efficiency as measured simply by "calf weight divided by cow weight" is significantly higher with Beckton's genetic program, compared to mainstream cross-breeding based on retained heterosis.

We have accomplished this by selecting for growth, restricting birth weight and cow size creep, and multiplying each incremental change rapidly throughout our entire cowherd and all of our bloodlines. Usually this has meant working within our own bloodlines rather than introducing out-crosses, because the outside genetics for the direction we wanted to go haven't been available. The overall key to success is simply that we have been making small progress in multiple traits, but doing it consistently over a very long period of time.

... making the Beckton Program work!



Morgan Armstrong



Matt Zier



Pam Leeper



Braxton Rosalez

Management

One Bull – the Simple Solution is the Best Solution

Many cattlemen use Beckton bulls for their heifers because of their low birth weights and high calving ease. Our bulls are even better when used on cows, because replacement heifers tend to be selected from calves out of older cows. **Keeping replacement heifers sired by Beckton bulls is the quickest way to limit cow size creep and to moderate cow size for the future.** In our own program we use the same bulls on both heifers and cows. Every bull is used his first year with heifers to evaluate calving ease, and used in future years with older cows. We get calving ease, growth, and moderate-sized replacements, all with the same bull.

Quietness and Ease of Handling

The necessity of record keeping means that our cattle will be handled much more than commercial cows. **This benefits our seedstock customers because our cattle will be quieter and easier to handle.** Good disposition is one of our most valued traits.

Selection for Industry Requirements

In order to make selection decisions appropriate to the commercial beef industry, seedstock cattle need to be managed and measured under conditions which will approximate the commercial industry. **Our cows are run entirely on grass, with hay only if weather conditions require it, because that is how the commercial industry runs cows.** However, almost all commercial calves go into feedlots before slaughter, so feedlot performance and efficiency is an important trait for calves. **Simply put, a producer needs to know how his cows perform on grass, and how his calves perform with feed.**

Our bulls are run on a performance test designed to provide the fairest basis of comparison among them, and

this requires a compromise. Our bulls receive a “growing” ration high in roughage and protein and not as high in energy as a steer would receive. **We want to get a good measure of gainability with which to compare bulls, but we don’t want the bulls fat.**



Craig Uden, Darr Feeders Manager
Photo courtesy of the Lexington Clipper-Herald



Mitch Ziebell, Darr Feeders

Mitch Ziebell, Craig Uden of Darr, NE

Since 1979 all of our bulls have been performance tested at a facility owned and managed by the Kugler family near Cozad, Nebraska. In the fall of 2005, Lane Kugler retired and the operation was bought by a neighboring operation – Darr Feeders. The overall operation is managed by Craig Uden, president of the NCBA, with the bulls under the daily management of Mitch Ziebell. **We have been very impressed with the conscientious care with which Mitch oversees all aspects of the bull management.**

Contributing to the success of the Beckton Program...



Sarah Schreiber
Our vet



Janet Drake
Health Permit Expert



Cody Cunningham
Brand Inspector



Fracky & Howard
Assistant Office Admins



Bob Milner
Our AI tech

Additional Facts about the Beckton Program

- Birth weight**
- ▶ Every sire entering our own program is used first on our own heifers, then on our cows.
 - ▶ We have never used high birth weight sires in any part of our program, so big birth weights are rare.
 - ▶ We get the pay weight, but with lower birth weights and greater calving ease.
 - ▶ Full production from heifers. We use the same bulls on heifers and cows.

- Growth**
- ▶ Weaning efficiency, and rate of gain to slaughter weight second to none.
 - ▶ Growth traits must be consistent with maintaining maternal qualities.
 - ▶ Beckton cattle are ideally sized for today's packer demand.

- Hardiness**
- ▶ Every cow in the herd has spent part of her life in the Big Horn Mountain summer range, at elevations from 7000 to 10,500 feet.
 - ▶ In 2001 we PAP tested all of our herd sires. The herd average PAP score was 32.5 at 4000', equivalent to a herd average PAP of 39 at 8000' (excellent scores).
 - ▶ By the time she is 5, our average cow will have been trailed over 80 miles, above and beyond normal pasture rotation.

- Efficiency**
- ▶ The typical dam of our bulls weans over 50% of her body weight in 205 days, under range conditions, with no creep-feeding.
 - ▶ The average dam produces over 100% of her own body weight in a year.
 - ▶ The average mature cow (age 5+) weighs about 1100-1125 pounds.

- Fertility**
- ▶ Every bull in our program is used in natural service, with 30-50 heifers/cows.
 - ▶ Every cow in our program must cycle naturally and breed early under range conditions.

- Value**
- ▶ Beckton Red Angus produce more growth without high birth weights.
 - ▶ They are the one-bull solution that can be used on both heifers and cows.
 - ▶ Carcass quality is an extra benefit.

- Reliability**
- ▶ Beckton has been genetically improving Red Angus since 1945, a 30-60 year lead time over other producers.
 - ▶ It is a complete, genetically sound breeding program, which demands whole-herd performance.



Lorna Tucker
Helping out in many ways throughout the year

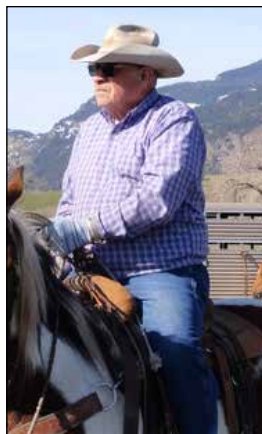

Chuck Overturf
Friend and neighbor - helps us every year



Sherry Kobielus
Always here to help even after retirement



Cody and Chad Halfmann, Halfmann Red Angus

Beckton History



Young Sal Forbes up on the mountain.



Waldo Forbes - 1st President of the Red Angus Association.



Beckton house/office before being moved in 1905 to its current location. This house was built in the 1880s by George Beck, the original homesteader. The antlers are still on the porch, and it is one of the oldest buildings in Sheridan County.



*The Waldo Forbes family in 1959:
Ellen, Julia, Sal, Sarah, Cherry, Spike, and Cam & Elfie in front.*



1960s Beckton Sale with Berdon's broadcast van.



*Beckton Larkabeau O "220" in 1959 -
the 1st Red Angus Bull at ABS*



Mrs. Waldo (Sal) Forbes was honored as the first woman inducted into the Saddle and Sirloin Club's portrait gallery in Louisville, KY.

Using New Selection Tools

HerdBuilder and GridMaster Indices

The new Red Angus Association HERDBuilder and GRIDMaster Indices are given for each sale animal, in the box just above the EPDs. The Index number is followed by the “Percentile” showing how that animal ranks compared to all other Red Angus bulls or heifers. A higher Index number results in a lower “Percentile” number, which means a higher ranking within the breed, and is therefore better. The development of these Indices by the RAAA is described in the article written by Larry Keenan and reprinted.

The familiar Birth Weight or Yearling Weight EPDs, for example, are measured in pounds of increase in weight, whereas these Indices are measured in ‘dollars of increase in profitability’ - the expected increase in profit that each animal is expected to generate per mating of that animal. A bull with a HerdBuilder Index of 160, compared to a second bull with an index of 110, should produce $160 - 110 = 50$ dollars of expected increased profit for each cow to which he is mated, compared to the second bull (note that this is ‘per mating’, not ‘per calf produced’). The Index considers and weights all economic factors – fertility, calving ease, maintenance costs, growth rate, stayability, carcass quality, etc. - according to best available science,

You will find Beckton bulls individually and as a group ranking in the top of the breed for profitability, as measured by these new Indices.

Maintenance EPD

This EPD predicts the relative feed energy requirement for maintenance, for cows produced by a sire or female. A bull with an ME of -3 (minus 3) is expected to sire replacement daughters which will need 10 fewer mcals of energy per month than a bull with an ME of +7.

We believe this is an important EPD because feed costs, both direct and indirect through ranch overhead, make up by far the largest proportion of operating costs. It can have much more direct impact on ranch profitability than Marbling or Ribeye EPD for example.

The Beckton herd has been one of the breed’s top herd for low maintenance energy requirements for many years.

Calving Ease

The Red Angus Calving Ease EPD was introduced in 2003, and is a more direct measure of calving ease than birth weight alone. Calving Ease is defined as follows: “The expected differences of calving ease measured as the probability difference (between sires) of unassisted calvings among offspring.” For Calving Ease EPD, the higher number is better.

There are two Calving Ease EPD’s - “Direct”, a predictor of an animal’s own offspring; and “Maternal”, a predictor of a daughters calving ease. Unless stated otherwise, we publish the Calving Ease Direct because most of our customers’ primary concern is selecting bulls for use on first calf heifers.

Beckton’s average Calving Ease EPD is +12, a full eight points higher than the the Red Angus breed average of 4, due to our long history of selection for moderate birth weights. **The average Beckton bull is in the top 4% of the entire breed for highest Calving Ease.**

Cow Efficiency

We present two indicators of efficiency. The first is Weaning Percent, a simple percentage of calf 205 day weight divided by the dam’s actual weight at weaning. The second is PRI Cow Efficiency. This also measures calf weaning weight, but relative to the cow’s metabolic weight, and is expressed as an index above or below 100.

These efficiency measures are best used as indicators of where an animal is relative to others, rather than directly for selection. For example, if we see an animal with a low efficiency, we would look at the actual calf and cow weights to decide if the calf is too small, or the cow too big for the environment. That in turn will suggest corrective actions. In general, select for the traits you need to change to make cattle more efficient, and efficiency will be the result.

Beckton has been performance tested selection since 1945, and we believe our cattle today are the most efficient in the industry.

Dam Information

A major difference with our catalog is the greater amount of information about the dams we provide. Weaning percent and Cow Efficiency are explained above. In addition, with each sale animal we give the dam’s age when this calf was born, and the dam’s actual weight when the calf was weaned the previous fall. We also provide her progeny averages – the average birth weight, weaning ratio, and yearling ratio – of her calves.

The Bulls

Our bulls are managed in a manner to gain important performance data and information, and equally importantly, to develop and provide our customers with many years of productive service. We have been testing breeding bulls over 50 years, longer than almost any other producer. Our own breeding is based primarily on natural service, not AI, so we see how our bulls work in the pasture. We use bulls raised and managed just this way, with our own cows and heifers, on every kind of terrain, and high in the Bighorn Mountains.

For the first twenty years our bulls were tested at home here in Wyoming. They received some grain, but otherwise grass pasture and dry hay. In 1979 we moved our test to a facility managed by the Kugler family in Cozad, Nebraska, where the bulls got a ration including silage, corn and protein. When we brought our first bulls home from Kuglers' and used them with

our own cowherd, we discovered a dramatic increase in libido and breeding performance. The effect of proper nutrition was apparent, and the bulls would maintain condition and hold up better through the entire breeding season. We have continued managing our bulls at the same facility ever since (now managed by Craig Uden), and we continue to see the same benefits.

We have since used over 500 of these bulls natural service in our own breeding program, on dry range and in the mountains, and have never had a bull fall out of our program early due to his feeding or testing management. Beckton Julian B571, Lancer F442, Nebula M045, Nebula P707, and all of our other great sires were fed and managed in Cozad. Every year we see the results and success of our bull management program, and we serve many satisfied customers.



Lot 237

• Bulls •

1 BECKTON LIKABLE G269 N5
1-A 100% # 4171344 Tat.: BKT9 G269



Birth: 3-19-19

Beckton Likable U130 L2
Beckton Indigo U658 JL
Beckton Likable U120 L2
Beckton Minola U188 NB
Beckton Nebula M045
Beckton Ruth M967 EP
Beckton Nebula T252 L3
Beckton Lana T226 NB

BECKTON LIKABLE Z057 L4
Ref. L-1
Beckton Likable X445 J3
Beckton Minola X107 L

BECKTON LANA Z832 N
Beckton Nebula T269 E2
Beckton Lana W113 N

DAM
Age 7
Wt 1105
Prog.BW 68
WR 96
YR 103
Wean Pct. 56%
Cow Eff. 118

RAAA HerdBuilder index: **199** (Top 9% of RA breed)
RAAA GridMaster index: **52** (Top 1% of RA breed)
Sire Beef Tenderness: **9** 'Outstanding'
Calv.Ease BW WW YW Milk HPG Stay Maint.En.
EPDs **13 -2.6 63 115 21 15 17 -8.0**
Marb **+0.38** REA **+0.00** Bfat **+0.4**

BWt 88
WR 114
YWt. 1257
YR 121
Feb.ADG 4.57
Feb.Scr. 38
Fr. 5.5



Lot 4

★★★★★ for Low Maintenance, Growth, Gainability, Marbling, High Cow Efficiency, Calving Ease, Stayability.

2 BECKTON NEBULA G422 N4
1-A 100% # 4170858 Tat.: BKT9 G422



Birth: 3-26-19

Beckton Nebula M045
BKT Pine Marie M119 EP
Beckton Nebula M045
Beckton Eola M663 EP
Beckton Nebula M045
Beckton Lana M809 EP
Beckton Warrior U636 J5
Beckton Lana W208 N

BECKTON NEBULA EN S347
Ref. N
Beckton Nebula E P084
Beckton Eola P530 NB

BECKTON LANA C795 N
Beckton Nebula P P707
Beckton Lana Z941 W

DAM
Age 4
Wt 1120
Prog.BW 77
WR 113
YR 116
Wean Pct. 57%
Cow Eff. 121

RAAA HerdBuilder index: **208** (Top 4% of RA breed)
RAAA GridMaster index: **50** (Top 12% of RA breed)
Sire Beef Tenderness: **8** 'Very Good'
Calv.Ease BW WW YW Milk HPG Stay Maint.En.
EPDs **15 -2.7 67 108 29 14 19 -5.0**
Marb **+0.53** REA **-0.10** Bfat **+0.06**

BWt 87
WR 122
YWt. 1253
YR 121
Feb.ADG 3.97
Feb.Scr. 37
Fr. 6.0

★★★★★ for Low Maintenance, Growth, Marbling, Superior Cow, High Cow Efficiency, Calving Ease, Stayability.

4 BECKTON LIKABLE G168 J4
1-A 100% # 4170434 Tat.: BKT9 G168



Birth: 3-12-19

Beckton Likable U130 L2
Beckton Likable S633
Beckton Kit S478 LN
Beckton Roman J S158
Beckton Tamara R834 JC
Beckton Julian G5 S107
Beckton Suffeina P643 JL
Beckton Julian U699 L5
Beckton Tamara S432 DM

BECKTON LIKABLE C229 R3
Ref. L-4
Beckton Likable X447 J

BECKTON TAMARA A701 J
Beckton Julian X465 J5
Beckton Tamara X587 J

DAM
Age 6
Wt 1075
Prog.BW 68
WR 112
YR 107
Wean Pct. 65%
Cow Eff. 136

RAAA HerdBuilder index: **176** (Top 40% of RA breed)
RAAA GridMaster index: **49** (Top 21% of RA breed)
Sire Beef Tenderness: **9** 'Outstanding'
Calv.Ease BW WW YW Milk HPG Stay Maint.En.
EPDs **12 -0.9 72 111 20 12 17 -2.0**
Marb **+0.47** REA **+0.06** Bfat **+0.05**

BWt 80
WR 138
YWt. 1163
YR 119
Feb.ADG 3.32
Feb.Scr. 34
Fr. 5.5

★★★★★ for Low Maintenance, Growth, Marbling, Superior Cow, High Cow Efficiency, Calving Ease, Stayability.

3 BECKTON LIKABLE G253 J5
1-A 100% # 4170154 Tat.: BKT9 G253



Birth: 3-18-19

Beckton Likable U130 L2
Beckton Indigo U658 JL
Beckton Likable U120 L2
Beckton Minola U188 NB
Beckton Julian GG B571
Bkt Suffeina A828 DM
Beckton Lancer T4 J536
Beckton Eola C611 SC

BECKTON LIKABLE Z057 L4
Ref. L-1
Beckton Likable X445 J3
Beckton Minola X107 L

BECKTON EOLA U689 JL
Beckton Julian G3 P608
Beckton Eola N491 LN

DAM
Age 11
Wt 1070
Prog.BW 67
WR 105
YR 106
Wean Pct. 51%
Cow Eff. 108

RAAA HerdBuilder index: **193** (Top 15% of RA breed)
RAAA GridMaster index: **52** (Top 2% of RA breed)
Sire Beef Tenderness: **9** 'Outstanding'
Calv.Ease BW WW YW Milk HPG Stay Maint.En.
EPDs **18 -5.7 55 99 24 16 15 -7.0**
Marb **+0.49** REA **+0.02** Bfat **+0.02**

BWt 61
WR 113
YWt. 1148
YR 117
Feb.ADG 3.97
Feb.Scr. 36
Fr. 5.5

★★★★★ for Low Maintenance, Growth, Marbling, Superior Cow, Calving Ease, Stayability.



Lot 3

• Bulls •

5 **BECKTON EPIC G454 N7**
1-A 100% # 4171340 Tat.: BSF9 G454



Birth: 3-28-19

Beckton Epic X464 L5
BECKTON EPIC B310 J6
Ref. E-2

Beckton Minerva Y116 J

Beckton Epic K6 S569
Beckton Lana M393 LN
Beckton Julian W743 H5
Beckton Minerva W081 N
Beckton Nebula U206 V3
Beckton Tamara U185 NB
Beckton Emperor T641 E2
Beckton Belga M050 EP

BWt 85
WR 115
YWt. 1147
YR 111
Feb.ADG 3.64
Feb.Scr. 37
Fr. 6.0

BECKTON BELGA Z031 N
Beckton Nebula X096 N4
Beckton Belga X736 E

DAM
Age 7
Wt 1120
Prog.BW 65
WR 106
YR 106
Wean Pct. 56%
Cow Eff. 118

RAAA HerdBuilder index: **188** (Top 20% of RA breed)
RAAA GridMaster index: **47** (Top 50% of RA breed)
Sire Beef Tenderness: **10** 'Outstanding'
Calv.Ease BW WW YW Milk HPG Stay Maint.En.
EPDs **15 -1.9 67 103 24 11 18 -2.0**
Marb **+0.35** REA **+0.07** Bfat **+0.03**



Lot 7

★★★★★ for Low Maintenance, Growth, Marbling, Superior Cow, High Cow Efficiency, Calving Ease, Stayability.

6 **BECKTON ACCENT G146 N3**
1-A 100% # 4171456 Tat.: BSF9 G146



Birth: 3-11-19

Beckton Accent U777 C2
BECKTON ACCENT B553 L2
Ref. A-3

Beckton Lana X839 L

Beckton Cody K1 P014
Beckton Susan R022 CQ
Beckton Legend S670
Beckton Lana S371 DM
Beckton Nebula M045
Beckton Lana M809 EP
Beckton Epic T524 L5
Beckton Christy U702 RA

BWt 81
WR 98
YWt. 1102
YR 106
Feb.ADG 3.91
Feb.Scr. 40
Fr. 6.0

BECKTON CHRISTY B411 N
Beckton Nebula P P707
Beckton Christy X694 E

DAM
Age 5
Wt 1020
Prog.BW 66
WR 93
YR 97
Wean Pct. 52%
Cow Eff. 110

RAAA HerdBuilder index: **190** (Top 17% of RA breed)
RAAA GridMaster index: **50** (Top 14% of RA breed)
Sire Beef Tenderness: **10** 'Outstanding'
Calv.Ease BW WW YW Milk HPG Stay Maint.En.
EPDs **15 -2.5 55 94 24 12 17 -6.0**
Marb **+0.46** REA **-0.04** Bfat **+0.04**

★★★★★ for Low Maintenance, Growth, Marbling, Calving Ease, Stayability.



Lot 8

7 **BECKTON EPIC G145 A8**
1-A 100% # 4170284 Tat.: BKT9 G145



Birth: 3-11-19

Beckton Epic Z674 E6
BECKTON EPIC D275 L7
Ref. E-3

Beckton Lana X839 L

Beckton Epic U749 D5
Beckton Indigo U504 EP
Beckton Legend S670
Beckton Lana S371 DM
Beckton Cody K1 P014
Beckton Susan R022 CQ
Beckton Epic R350 K
Beckton Larkaba R336 CK

BWt 80
WR 125
YWt. 1183
YR 121
Feb.ADG 3.64
Feb.Scr. 38
Fr. 6.0

BECKTON LARKABA Y454 A
Beckton Accent U777 C2
Beckton Larkaba U498 EP

DAM
Age 8
Wt 1170
Prog.BW 76
WR 104
YR 107
Wean Pct. 54%
Cow Eff. 113

RAAA HerdBuilder index: **182** (Top 30% of RA breed)
RAAA GridMaster index: **50** (Top 12% of RA breed)
Sire Beef Tenderness: **7** 'Very Good'
Calv.Ease BW WW YW Milk HPG Stay Maint.En.
EPDs **16 -1.8 69 114 23 11 15 -3.0**
Marb **+0.37** REA **+0.03** Bfat **+0.04**

★★★★★ for Low Maintenance, Growth, Marbling, Superior Cow, Calving Ease, Stayability.

8 **BECKTON ACCENT G427 E4**
1-A 100% # 4170458 Tat.: BKT9 G427



Birth: 3-27-19

Beckton Accent U777 C2
BECKTON ACCENT B653 C3
Ref. A-4

Beckton Christy W779 C

Beckton Cody K1 P014
Beckton Susan R022 CQ
BKT Clifftop TP R288
Beckton Christy S151 NB
Beckton Epic K6 S569
Beckton Lana M393 LN
Beckton Loki C M740
Beckton Indigo M571 EP

BWt 87
WR 116
YWt. 1218
YR 117
Feb.ADG 4.13
Feb.Scr. 38
Fr. 5.5

BECKTON INDIGO B204 E
Beckton Epic X464 L5
Beckton Indigo P043 LO

DAM
Age 5
Wt 1125
Prog.BW 79
WR 113
YR 109
Wean Pct. 56%
Cow Eff. 118

RAAA HerdBuilder index: **171** (Top 50% of RA breed)
RAAA GridMaster index: **49** (Top 20% of RA breed)
Sire Beef Tenderness: **10** 'Outstanding'
Calv.Ease BW WW YW Milk HPG Stay Maint.En.
EPDs **13 -0.1 68 112 25 11 16 -1.0**
Marb **+0.27** REA **+0.04** Bfat **+0.04**

★★★★★ for Low Maintenance, Growth, Gainability, Marbling, Superior Cow, High Cow Efficiency, Calving Ease, Stayability.

• Bulls •

9 BECKTON NEBULA G249 N4
1-A 100% # 4171298 Tat.: BSF9 G249



Birth: 3-18-19

Beckton Nebula P P707
Beckton Nebula M045
Beckton Lana M809 EP
Beckton Justice CH M056
Beckton Larkaba T813 JC
Beckton Larkaba P645 JL
Beckton Nebula T269 E2
Beckton Eola T070 DM
Beckton Dominor Z1 R610
Beckton Lana W525 D
Beckton Lana S520 JO

BECKTON NEBULA B557 J3
Ref. N-4

BECKTON LANA Y130 N

DAM
Age 8
Wt 1120
Prog.BW 68
WR 105
YR 106
Wean Pct. 55%
Cow Eff. 115

RAAA HerdBuilder index: **206** (Top 5% of RA breed)
RAAA GridMaster index: **51** (Top 5% of RA breed)
Sire Beef Tenderness: **6** 'Average'
Calv.Ease BW WW YW Milk HPG Stay Maint.En.
EPDs **14 -3.9 59 105 26 12 19 -5.0**
Marb **+0.54** REA **-0.14** Bfat **+0.05**

BWt 75
WR 121
YWt. 1171
YR 120
Feb.ADG 4.02
Feb.Scr. 39
Fr. 5.5

12 BECKTON NEBULA G225 A4
1-A 100% # 4170392 Tat.: BKT9 G225



Birth: 3-16-19

Beckton Nebula P P707
Beckton Nebula M045
Beckton Lana M809 EP
Beckton Justice CH M056
Beckton Larkaba T813 JC
Beckton Larkaba P645 JL
Beckton Cody K1 P014
Beckton Christy R046 CQ
Beckton Accent W180 C2
Beckton Epic K3 M606
Beckton Lana T646 EP
Beckton Lana N664 JL

BECKTON NEBULA B557 J3
Ref. N-4

BECKTON LANA A172 A

DAM
Age 6
Wt 1095
Prog.BW 76
WR 107
YR 107
Wean Pct. 50%
Cow Eff. 106

RAAA HerdBuilder index: **204** (Top 6% of RA breed)
RAAA GridMaster index: **48** (Top 36% of RA breed)
Sire Beef Tenderness: **6** 'Average'
Calv.Ease BW WW YW Milk HPG Stay Maint.En.
EPDs **14 -3.8 54 88 26 9 20 -4.0**
Marb **+0.41** REA **+0.05** Bfat **+0.05**

BWt 69
WR 101
YWt. 1133
YR 109
Feb.ADG 4.24
Feb.Scr. 36
Fr. 5.5

★★★★★ for Low Maintenance, Growth, Gainability, Marbling, Superior Cow, Calving Ease, Stayability.

★★★★★ for Low Maintenance, Growth, Gainability, Marbling, Superior Cow, Calving Ease, Stayability.

10 BECKTON DOMINOR G217 L8
1-A 100% # 4171322 Tat.: BSF9 G217



Birth: 3-16-19

Beckton Dominor Y005 V6
Beckton Dominor W640 C5
Beckton Belga W108 V
Beckton Warrior T248 L5
Beckton Lana Y541 W
Beckton Lana S074 EP
Beckton Likable U130 L2
Beckton Likable U130 L2
Beckton Indigo U658 JL
Beckton Accent U777 C2
Beckton Minola X198 A
Beckton Minola U378 JL

BECKTON DOMINOR A378 W7
Ref. D-1

BECKTON MINOLA Z052 L

DAM
Age 7
Wt 960
Prog.BW 65
WR 103
YR 100
Wean Pct. 58%
Cow Eff. 121

RAAA HerdBuilder index: **184** (Top 26% of RA breed)
RAAA GridMaster index: **51** (Top 5% of RA breed)
Sire Beef Tenderness: **9** 'Outstanding'
Calv.Ease BW WW YW Milk HPG Stay Maint.En.
EPDs **19 -3.7 52 93 27 14 14 -11.0**
Marb **+0.44** REA **+0.06** Bfat **+0.04**

BWt 72
WR 110
YWt. 1122
YR 115
Feb.ADG 4.02
Feb.Scr. 36
Fr. 5.5

★★★★★ for Low Maintenance, Growth, Gainability, Marbling, High Cow Efficiency, Calving Ease, Stayability.



Lot 12

11 BECKTON HERITAGE G245 N5
1-A 100% # 4170322 Tat.: BKT9 G245



Birth: 3-17-19

Beckton Heritage A767 C3
Beckton Heritage X356 E2
Beckton Rose W816 C
Beckton Loki CL S284
Beckton Susan W846 L
Beckton Susan S684 JJ
Beckton Nebula T269 E2
Beckton Nebula M045
Beckton Ruth M967 EP
Beckton Epic KM M115
Beckton Lakme T692 EP
Beckton Lakme P513 EP

BECKTON HERITAGE D195 L4
Ref. H-1

BECKTON LAKME Z405 N

DAM
Age 7
Wt 1280
Prog.BW 72
WR 108
YR 106
Wean Pct. 46%
Cow Eff. 97

RAAA HerdBuilder index: **169** (Top 53% of RA breed)
RAAA GridMaster index: **49** (Top 27% of RA breed)
Sire Beef Tenderness: **10** 'Outstanding'
Calv.Ease BW WW YW Milk HPG Stay Maint.En.
EPDs **14 -2.5 63 106 26 10 15 -1.0**
Marb **+0.33** REA **-0.15** Bfat **+0.05**

BWt 77
WR 109
YWt. 1156
YR 111
Feb.ADG 3.70
Feb.Scr. 36
Fr. 5.5

★★★★★ for Low Maintenance, Growth, Marbling, Superior Cow, Calving Ease, Stayability.

13 BECKTON ACCENT G134 E3
1-A 100% # 4170450 Tat.: BKT9 G134



Birth: 3-10-19

Beckton Accent U777 C2
Beckton Cody K1 P014
Beckton Susan R022 CQ
Beckton Legend S670
Beckton Lana S371 DM
Beckton Epic U749 D5
Beckton Lydia S069 NB
Beckton Epic Y484 N6
Beckton Nebula T398 V3
Beckton Minerva Y385 N
Beckton Minerva U310 LO

BECKTON ACCENT B553 L2
Ref. A-3

BECKTON MINERVA A244 E

DAM
Age 6
Wt 1095
Prog.BW 67
WR 93
YR 99
Wean Pct. 49%
Cow Eff. 103

RAAA HerdBuilder index: **193** (Top 15% of RA breed)
RAAA GridMaster index: **50** (Top 10% of RA breed)
Sire Beef Tenderness: **10** 'Outstanding'
Calv.Ease BW WW YW Milk HPG Stay Maint.En.
EPDs **15 -1.8 59 101 23 12 17 -5.0**
Marb **+0.32** REA **+0.21** Bfat **+0.04**

BWt 79
WR 106
YWt. 1084
YR 111
Feb.ADG 3.80
Feb.Scr. 33
Fr. 5.5

★★★★★ for Low Maintenance, Growth, Marbling, Rib-eye area, Calving Ease, Stayability.

• Bulls •

14 BECKTON ACCENT G635 E4
1-A 100% # 4170648 Tat.: BKT9 G635



Birth: 4-11-19

Beckton Accent W180 C2
Beckton Christy R046 CQ
Beckton Warrior W534 N4
Beckton Lana W370 E
Beckton Epic K6 S569
Beckton Lana M393 LN
Beckton Julian X721 E6
Beckton Christy X354 N

BECKTON ACCENT B740 W3
Ref. A-5

BECKTON CHRISTY C559 E
Beckton Christy Z125 J

DAM
Age 4
Wt 995
Prog.BW 66
WR 114
YR 114
Wean Pct. 59%
Cow Eff. 124

RAAA HerdBuilder index: **209** (Top 4% of RA breed)
RAAA GridMaster index: **50** (Top 8% of RA breed)
Sire Beef Tenderness: **9** 'Outstanding'
Calv.Ease BW WW YW Milk HPG Stay Maint.En.
EPDs **16 -2.7 70 118 27 12 18 -5.0**
Marb **+0.31** REA **+0.29** Bfat **+0.04**

BWt 78
WR 120
YWt. 1185
YR 121
Feb.ADG 4.08
Feb.Scr. 35
Fr. 5.5

★★★★★ for Low Maintenance, Growth, Gainability, Marbling, Rib-eye area, Superior Cow, High Cow Efficiency, Calving Ease, Stayability.

17 BECKTON WARRIOR G582 E7
1-A 100% # 4170300 Tat.: BKT9 G582



Birth: 4-5-19

Beckton Warrior Y108 E5
Beckton Susan W058 E
Beckton Loki CL S284
Beckton Lana R327 EP
Beckton Emcee S466
Beckton Lana M621 LN
Beckton Emcee S466
Beckton Serena N088 WR

BECKTON WARRIOR D359 L6
Ref. W-1

BECKTON SERENA Y044 E
Beckton Serena W366 E

DAM
Age 8
Wt 1080
Prog.BW 65
WR 108
YR 105
Wean Pct. 57%
Cow Eff. 119

RAAA HerdBuilder index: **156** (Top 73% of RA breed)
RAAA GridMaster index: **47** (Top 50% of RA breed)
Sire Beef Tenderness: **9** 'Outstanding'
Calv.Ease BW WW YW Milk HPG Stay Maint.En.
EPDs **16 -3.2 57 96 30 8 14 -4.0**
Marb **+0.22** REA **-0.02** Bfat **+0.04**

BWt 77
WR 113
YWt. 1195
YR 115
Feb.ADG 4.29
Feb.Scr. 38
Fr. 5.5

★★★★★ for Low Maintenance, Growth, Gainability, Marbling, Superior Cow, High Cow Efficiency, Calving Ease, Stayability.

15 BECKTON WARRIOR G562 E7
1-A 100% # 4170598 Tat.: BKT9 G562



Birth: 4-3-19

Beckton Warrior Y108 E5
Beckton Susan W058 E
Beckton Loki CL S284
Beckton Lana W463 L
Beckton Lana R327 EP
Beckton Epic K6 S569
Beckton Lana M393 LN
Beckton Dominor Z1 R610
Beckton Lana S858 JL

BECKTON WARRIOR D359 L6
Ref. W-1

BECKTON LANA C353 E
Beckton Epic X464 L5
Beckton Lana W748 D

DAM
Age 4
Wt 1075
Prog.BW 61
WR 111
YR 105
Wean Pct. 59%
Cow Eff. 125

RAAA HerdBuilder index: **184** (Top 26% of RA breed)
RAAA GridMaster index: **47** (Top 64% of RA breed)
Sire Beef Tenderness: **9** 'Outstanding'
Calv.Ease BW WW YW Milk HPG Stay Maint.En.
EPDs **16 -3.3 61 98 28 12 17 -4.0**
Marb **+0.28** REA **-0.04** Bfat **+0.04**

BWt 79
WR 121
YWt. 1153
YR 111
Feb.ADG 3.64
Feb.Scr. 36
Fr. 5.5

★★★★★ for Low Maintenance, Growth, Marbling, Superior Cow, High Cow Efficiency, Calving Ease, Stayability.

18 BECKTON NEBULA G484 E4
1-A 100% # 4170222 Tat.: BKT9 G484



Birth: 3-30-19

Beckton Nebula P P707
Beckton Nebula M045
Beckton Lana M809 EP
Beckton Justice CH M056
Beckton Larkaba T813 JC
Beckton Larkaba P645 JL
Beckton Epic KM M115
Beckton Sierra N703 LM
Beckton Lancer T7 M089
Beckton Rose M131 HR

BECKTON NEBULA B557 J3
Ref. N-4

BECKTON ROSE X389 E
Beckton Epic K6 S569
Beckton Rose P015 LN

DAM
Age 9
Wt NA
Prog.BW 75
WR 112
YR 107
Wean Pct. NA%
Cow Eff. NA

RAAA HerdBuilder index: **194** (Top 14% of RA breed)
RAAA GridMaster index: **48** (Top 35% of RA breed)
Sire Beef Tenderness: **6** 'Average'
Calv.Ease BW WW YW Milk HPG Stay Maint.En.
EPDs **13 -2.0 55 91 30 11 19 -6.0**
Marb **+0.41** REA **-0.14** Bfat **+0.04**

BWt 86
WR 102
YWt. 1065
YR 103
Feb.ADG 3.10
Feb.Scr. 36
Fr. 6.0

★★★★★ for Low Maintenance, Marbling, Superior Cow, Calving Ease, Stayability.

16 BECKTON SCAMP G166 E6
1-A 100% # 4170282 Tat.: BKT9 G166



Birth: 3-12-19

Beckton Scamp A627 J4
Beckton Scamp X494 E3
Beckton Serena R023 JC
Beckton Nebula W065 C3
Beckton Tamara W232 J
Beckton Epic K4 N795
Beckton Denise R308 DM
BKT Clifftop TP R288
Beckton Larkaba R809 NB

BECKTON SCAMP D325 N5
Ref. S-1

BECKTON LARKABA Y648 E
Beckton Epic U749 D5
Beckton Larkaba U475 CT

DAM
Age 8
Wt 1175
Prog.BW 75
WR 104
YR 105
Wean Pct. 51%
Cow Eff. 106

RAAA HerdBuilder index: **162** (Top 64% of RA breed)
RAAA GridMaster index: **49** (Top 29% of RA breed)
Sire Beef Tenderness: **10** 'Outstanding'
Calv.Ease BW WW YW Milk HPG Stay Maint.En.
EPDs **19 -4.9 54 94 26 10 13 -8.0**
Marb **+0.24** REA **-0.01** Bfat **+0.04**

BWt 80
WR 109
YWt. 1124
YR 108
Feb.ADG 3.15
Feb.Scr. 38
Fr. 5.5

★★★★★ for Low Maintenance, Growth, Marbling, Superior Cow, Calving Ease, Stayability.



Lot 16

• Bulls •

19 BECKTON SCAMP G469 H5

1-A 100% # 4170578 Tat.: BKT9 G469

Birth: 3-29-19

BECKTON SCAMP C349 C4
Ref. S

BECKTON LARKEISA C393 H

DAM

Age 4
Wt 1110
Prog. BW 71
WR 113
YR 105
Wean Pct. 54%
Cow Eff. 113

Beckton Scamp X458 H3
Beckton Lydia W178 C

Beckton Scamp T A825
BKT Pine Marie R401 HU
BKT Clifftop TP R288
Beckton Lydia N047 LM
Basin Hobo 0545
Basin Rose 06T0
Beckton Dominor W640 C5
Beckton Larkeisa M138 JC

BWt 80
WR 114
YWt. 1142
YR 110
Feb. ADG 3.59
Feb. Scr. 38
Fr. 6.0



RAAA HerdBuilder index: 161 (Top 66% of RA breed)	
RAAA GridMaster index: 47 (Top 52% of RA breed)	
Sire Beef Tenderness: 9 'Outstanding'	
Calv. Ease	BW WW YW Milk HPG Stay Maint. En.
EPDs	15 -2.2 62 98 23 13 14 -4.0
Marb	+0.24 REA +0.05 Bfat +0.03

22 BECKTON ACCENT G333 W4

1-A 100% # 4171856 Tat.: BSF9 G333

Birth: 3-22-19

BECKTON ACCENT E172 L3
Ref. A-6

BECKTON LARKABEL E016 W

DAM

Age 2
Wt 675
Prog. BW 74
WR 131
YR 126
Wean Pct. 77%
Cow Eff. 163

Beckton Accent W180 C2
Beckton Indigo Y406 L

Beckton Cody K1 P014
Beckton Christy R046 CQ
Beckton Likable U130 L2
Beckton Indigo R745 WR
Beckton Warrior Y108 E5
Beckton Lana Y033 W
Beckton Accent A485 C3
Beckton Larkabel A589 A

BWt 74
WR 131
YWt. 1153
YR 126
Feb. ADG 3.87
Feb. Scr. 35
Fr. 5.5



RAAA HerdBuilder index: 170 (Top 51% of RA breed)	
RAAA GridMaster index: 49 (Top 17% of RA breed)	
Sire Beef Tenderness: 9 'Outstanding'	
Calv. Ease	BW WW YW Milk HPG Stay Maint. En.
EPDs	10 -2.3 67 110 24 12 17 -6.0
Marb	+0.34 REA +0.11 Bfat +0.05

★★★★★ for Low Maintenance, Growth, Marbling, Superior Cow, Calving Ease, Stayability.

★★★★★ for Low Maintenance, Growth, Marbling, Superior Cow, High Cow Efficiency, Calving Ease, Stayability.

20 BECKTON ACCENT G480 D4

1-A 100% # 4171342 Tat.: BKT9 G480

Birth: 3-30-19

BECKTON ACCENT B740 W3
Ref. A-5

BECKTON COCA Z639 D

DAM

Age 7
Wt 1115
Prog. BW 68
WR 111
YR 107
Wean Pct. 48%
Cow Eff. 101

Beckton Accent W180 C2
Beckton Lana Y033 W

Beckton Cody K1 P014
Beckton Christy R046 CQ
Beckton Warrior W534 N4
Beckton Lana W370 E
Beckton Dominor Z1 R610
Beckton Mona R166 CQ
Beckton Nebula N R573
Beckton Coca R375 WR

BWt 70
WR 106
YWt. 1155
YR 118
Feb. ADG 4.57
Feb. Scr. 37
Fr. 5.5



RAAA HerdBuilder index: 211 (Top 4% of RA breed)	
RAAA GridMaster index: 51 (Top 5% of RA breed)	
Sire Beef Tenderness: 9 'Outstanding'	
Calv. Ease	BW WW YW Milk HPG Stay Maint. En.
EPDs	21 -5.9 59 105 24 12 17 -6.0
Marb	+0.39 REA +0.25 Bfat +0.05

★★★★★ for Low Maintenance, Growth, Gainability, Marbling, Rib-eye area, Superior Cow, Calving Ease, Stayability.

23 BECKTON LIKABLE G456 W5

1-A 100% # 4170654 Tat.: BKT9 G456

Birth: 3-28-19

BECKTON LIKABLE Z057 L4
Ref. L-1

BECKTON MINERVA C549 W

DAM

Age 4
Wt 945
Prog. BW 61
WR 104
YR 105
Wean Pct. 57%
Cow Eff. 119

Beckton Likable X445 J3
Beckton Minola X107 L

Beckton Likable U130 L2
Beckton Indigo U658 JL
Beckton Likable U120 L2
Beckton Minola U188 NB
Beckton Warrior W534 N4
Beckton Susan W058 E
Beckton Nebula T398 V3
Beckton Minerva U310 LO

BWt 70
WR 110
YWt. 1113
YR 114
Feb. ADG 3.71
Feb. Scr. 36
Fr. 5.5



RAAA HerdBuilder index: 194 (Top 13% of RA breed)	
RAAA GridMaster index: 51 (Top 6% of RA breed)	
Sire Beef Tenderness: 9 'Outstanding'	
Calv. Ease	BW WW YW Milk HPG Stay Maint. En.
EPDs	18 -5.5 55 99 25 14.5 16 -11.0
Marb	+0.41 REA +0.11 Bfat +0.03

★★★★★ for Low Maintenance, Growth, Marbling, Superior Cow, High Cow Efficiency, Calving Ease, Stayability.

21 BECKTON LIKABLE G435 W6

1-A 100% # 4171502 Tat.: BSF9 G435

Birth: 3-27-19

BECKTON LIKABLE B032 C5
Ref. L-2

BECKTON LARKEISA C533 W

DAM

Age 4
Wt 945
Prog. BW 58
WR 102
YR 106
Wean Pct. 56%
Cow Eff. 118

Beckton Likable Z057 L4
Beckton Mona Z270 C

Beckton Likable X445 J3
Beckton Minola X107 L
Beckton Clifftop W577 E3
Beckton Mona U584 CD
Beckton Warrior W534 N4
Beckton Susan W058 E
Beckton Warrior W534 N4
BKT Larkeisa U583 NB

BWt 67
WR 101
YWt. 1200
YR 116
Feb. ADG 4.68
Feb. Scr. 37
Fr. 5.5



RAAA HerdBuilder index: 200 (Top 9% of RA breed)	
RAAA GridMaster index: 51 (Top 3% of RA breed)	
Sire Beef Tenderness: 7 'Very Good'	
Calv. Ease	BW WW YW Milk HPG Stay Maint. En.
EPDs	20 -6.0 51 101 27 14.5 16 -5.0
Marb	+0.43 REA +0.05 Bfat +0.04

★★★★★ for Low Maintenance, Growth, Gainability, Marbling, High Cow Efficiency, Calving Ease, Stayability.



Lot 23

• Bulls •

24 BECKTON LIKABLE G511 E5 

1-A 100% # 4170788 Tat.: BKT9 G511

Birth: 3-31-19

Beckton Likable X445 J3
BECKTON LIKABLE Z057 L4 Ref. L-1
 Beckton Minola X107 L

Beckton Indigo U658 JL
 Beckton Likable U120 L2
 Beckton Minola U188 NB
 Beckton Epic U749 D5
 Beckton Lydia S069 NB
 Beckton Jet L P491
 Beckton Scarlett R808 NB

Beckton Epic Y484 N6
BECKTON SCARLETT D331 E
 Beckton Scarlett W497 J

BWt	71
WR	112
YWt.	1183
YR	118
Feb.ADG	4.09
Feb.Scr.	38
Fr.	5.5

Age	3
Wt	960
Prog.BW	61
WR	117
YR	114
Wean Pct.	55%
Cow Eff.	115

RAAA HerdBuilder index: **183** (Top 28% of RA breed)
 RAAA GridMaster index: **52** (Top 1% of RA breed)
 Sire Beef Tenderness: **9** 'Outstanding'
 Calv.Ease BW WW YW Milk HPG Stay Maint.En.
 EPDs **15 -3.6 58 108 27 12 15 -9.0**
 Marb **+0.47** REA **+0.14** Bfat **+0.03**

26 BSF LIKABLE G358 L6 

1-B 99% # 4171326 Tat.: BSF9 G358

Birth: 3-23-19

Beckton Likable Z057 L4
BECKTON LIKABLE B032 C5 Ref. L-2
 Beckton Mona Z270 C

Beckton Likable X445 J3
 Beckton Minola X107 L
 Beckton Clifftop W577 E3
 Beckton Mona U584 CD
 Beckton Loki CL S284
 Beckton Vernice T447 HT
 Beckton Nebula T269 E2
 BSF Red G449

Beckton Loki X833 H4
BSF NEBULANN 2012 L
 BSF Nebulann X393 N

BWt	79
WR	117
YWt.	1104
YR	106
Feb.ADG	3.15
Feb.Scr.	37
Fr.	6.0

Age	7
Wt	1115
Prog.BW	77
WR	109
YR	109
Wean Pct.	57%
Cow Eff.	120

RAAA HerdBuilder index: **171** (Top 48% of RA breed)
 RAAA GridMaster index: **49** (Top 19% of RA breed)
 Sire Beef Tenderness: **7** 'Very Good'
 Calv.Ease BW WW YW Milk HPG Stay Maint.En.
 EPDs **15 -3.3 57 100 26 11 15 -2.0**
 Marb **+0.45** REA **-0.11** Bfat **+0.04**

★★★★★ for Low Maintenance, Growth, Gainability, Marbling, Rib-eye area, Superior Cow, Calving Ease, Stayability.

★★★★★ for Low Maintenance, Growth, Marbling, Superior Cow, High Cow Efficiency, Calving Ease, Stayability.

25 BSF LIKABLE G288 N6 

1-B 99% # 4171382 Tat.: BSF9 G288

Birth: 3-20-19

Beckton Likable Z057 L4
BECKTON LIKABLE B032 C5 Ref. L-2
 Beckton Mona Z270 C

Beckton Likable X445 J3
 Beckton Minola X107 L
 Beckton Clifftop W577 E3
 Beckton Mona U584 CD
 Beckton Nebula PJ S543
 Beckton Lana S197 JT
 Beckton Justice C1 R483
 BSF Regus M638 WR

Beckton Nebula W778 J4
BSF JUSTICIA A684 N
 BSF Justicia U855 JC

BWt	74
WR	124
YWt.	1159
YR	119
Feb.ADG	3.59
Feb.Scr.	37
Fr.	5.5

Age	6
Wt	1200
Prog.BW	64
WR	107
YR	105
Wean Pct.	52%
Cow Eff.	109

RAAA HerdBuilder index: **211** (Top 4% of RA breed)
 RAAA GridMaster index: **50** (Top 7% of RA breed)
 Sire Beef Tenderness: **7** 'Very Good'
 Calv.Ease BW WW YW Milk HPG Stay Maint.En.
 EPDs **19 -5.0 60 103 23 14 18 0.0**
 Marb **+0.53** REA **+0.05** Bfat **+0.04**



Lot 26

★★★★★ for Low Maintenance, Growth, Marbling, Superior Cow, Calving Ease, Stayability.



Lot 25

27 BSF LIKABLE G280 N5 

1-B 99% # 4171694 Tat.: BSF9 G280

Birth: 3-20-19

Beckton Likable Y124 L3
BECKTON LIKABLE E391 N4 Ref. L-7
 Beckton Lana X466 N

Beckton Likable U130 L2
 BKT Pine Marie S802 LO
 Beckton Nebula T398 V3
 Beckton Lana T226 NB
 Beckton Nebula P P707
 BKT Larkeisa T310 JC
 Beckton Janus X799 L2
 BSF Lanette W106 N

Beckton New Era Y194
BSF LANETTE D395 N
 BSF Lanette A272 O

BWt	70
WR	120
YWt.	1091
YR	109
Feb.ADG	3.42
Feb.Scr.	33
Fr.	6.0

Age	3
Wt	965
Prog.BW	61
WR	120
YR	109
Wean Pct.	59%
Cow Eff.	124

RAAA HerdBuilder index: **209** (Top 4% of RA breed)
 RAAA GridMaster index: **48** (Top 31% of RA breed)
 Sire Beef Tenderness: **8** 'Very Good'
 Calv.Ease BW WW YW Milk HPG Stay Maint.En.
 EPDs **15 -3.1 63 105 25 12 20 -3.0**
 Marb **+0.34** REA **-0.06** Bfat **+0.04**

★★★★★ for Low Maintenance, Growth, Marbling, Superior Cow, High Cow Efficiency, Calving Ease, Stayability.

• Bulls •

28 **BSF LIKABLE G398 E6** 

1-B 99% # 4171356 Tat.: BSF9 G398

Birth: 3-25-19

Beckton Likable Z057 L4
BECKTON LIKABLE B032 C5
 Ref. L-2 Beckton Mona Z270 C

Beckton Likable X445 J3
 Beckton Minola X107 L
 Beckton Clifftop W577 E3
 Beckton Mona U584 CD
 Beckton Epic K4 N795
 Beckton Denise R308 DM
 Beckton Cody K1 P014
 BSF Juleste R644 JE

BWt 80
 WR 103
 YWt. 1184
 YR 114
 Feb.ADG 4.13
 Feb.Scr. 37
 Fr. 5.5

Beckton Epic U749 D5
BSF JULESTE Z478 E
 BSF Juleste U662 CD

DAM
 Age 7
 Wt 1170
 Prog.BW 71
 WR 102
 YR 105
 Wean Pct. 48%
 Cow Eff. 101

RAAA HerdBuilder index: **181** (Top 31% of RA breed)
 RAAA GridMaster index: **52** (Top 2% of RA breed)
 Sire Beef Tenderness: **7** 'Very Good'
 Calv.Ease BW WW YW Milk HPG Stay Maint.En.
 EPDs **17 -3.7 57 109 25 11 15 -3.0**

Marb **+0.46** REA **+0.13** Bfat **+0.04**

30 **BSF LIKABLE G620 J4** 

1-B 99% # 4165172 Tat.: BKB9 G620

Birth: 4-10-19

Beckton Likable U130 L2
BECKTON LIKABLE C229 R3
 Ref. L-4 Beckton Tamara X447 J

Beckton Likable S633
 Beckton Kit S478 LN
 Beckton Roman J S158
 Beckton Tamara R834 JC
 Beckton Julian X721 E6
 Beckton Larkaba X064 J
 Beckton Nebula W486 D3
 BSF Hustelle W076 W

BWt 71
 WR 122
 YWt. 1162
 YR 116
 Feb.ADG 3.80
 Feb.Scr. 36
 Fr. 6.0

Beckton Julian Z382 J7
BSF HUSTELLE D853 J
 BSF Hustelle A787 N

DAM
 Age 3
 Wt 1000
 Prog.BW 60
 WR 104
 YR 100
 Wean Pct. 58%
 Cow Eff. 122

RAAA HerdBuilder index: **196** (Top 12% of RA breed)
 RAAA GridMaster index: **48** (Top 48% of RA breed)
 Sire Beef Tenderness: **9** 'Outstanding'
 Calv.Ease BW WW YW Milk HPG Stay Maint.En.
 EPDs **16 -3.3 57 88 21 11 18 -4.0**

Marb **+0.34** REA **+0.03** Bfat **+0.04**

★★★★★ for Low Maintenance, Growth, Gainability, Marbling, Rib-eye area, Calving Ease, Stayability.

★★★★★ for Low Maintenance, Growth, Marbling, High Cow Efficiency, Calving Ease, Stayability.



Lot 28

31 **BSF HUGHES G033 L4** 

1-B 99% # 4171876 Tat.: BSF9 G033

Birth: 2-21-19

Beckton Hughes C350 N2
BECKTON HUGHES E090 H3
 Ref. B Beckton Rose C258 H

Bieber H Hughes W109
 Beckton Kit Z049 N
 Bieber H Hughes W109
 Beckton Rose Z078 J
 Beckton Likable Y124 L3
 Beckton Tara Z160 N
 Beckton Epic Y484 N6
 BSF Nebulann T046 JC

BWt 59
 WR 113
 YWt. 1050
 YR 115
 Feb.ADG 3.53
 Feb.Scr. 34
 Fr. 5.5

Beckton Likable C744 N4
BSF NEBULANN E060 L
 BSF Nebulann C362 E

DAM
 Age 2
 Wt 725
 Prog.BW 59
 WR 113
 YR 115
 Wean Pct. 62%
 Cow Eff. 130

RAAA HerdBuilder index: **190** (Top 18% of RA breed)
 RAAA GridMaster index: **48** (Top 36% of RA breed)
 Sire Beef Tenderness: **7** 'Very Good'
 Calv.Ease BW WW YW Milk HPG Stay Maint.En.
 EPDs **19 -3.9 62 102 26 13 16 -2.5**

Marb **+0.37** REA **+0.01** Bfat **+0.04**

★★★★★ for Low Maintenance, Growth, Marbling, Superior Cow, High Cow Efficiency, Calving Ease, Stayability.

29 **BECKTON ACCENT G721 A4** 

1-A 100% # 4171604 Tat.: BSF9 G721

Birth: 4-22-19

Beckton Accent U777 C2
BECKTON ACCENT B653 C3
 Ref. A-4 Beckton Christy W779 C

Beckton Cody K1 P014
 Beckton Susan R022 CQ
 BKT Clifftop TP R288
 Beckton Christy S151 NB
 Beckton Accent Y260 L3
 BKT Larkaba S055 NB
 Beckton Accent Y260 L3
 Beckton Larkaba Y156 N

BWt 94
 WR 113
 YWt. 1158
 YR 116
 Feb.ADG 3.70
 Feb.Scr. 32
 Fr. 6.0

Beckton Accent B150 N4
BECKTON LARKABA D014 A
 Beckton Larkaba B352 A

DAM
 Age 3
 Wt 910
 Prog.BW 90
 WR 111
 YR 115
 Wean Pct. 58%
 Cow Eff. 123

RAAA HerdBuilder index: **193** (Top 14% of RA breed)
 RAAA GridMaster index: **50** (Top 10% of RA breed)
 Sire Beef Tenderness: **10** 'Outstanding'
 Calv.Ease BW WW YW Milk HPG Stay Maint.En.
 EPDs **11 0.9 69 113 25 13 19 -4.0**

Marb **+0.43** REA **-0.06** Bfat **+0.05**

★★★★★ for Low Maintenance, Growth, Marbling, Superior Cow, High Cow Efficiency, Calving Ease, Stayability.



Lot 31

• Bulls •

32 BSF EPIC G116 S8 

1-B 99% # 4171588 Tat.: BSF9 G116

Birth: 3-8-19

Beckton Epic Z674 E6
BECKTON EPIC D275 L7
 Ref. E-3
 Beckton Lana X839 L

Beckton Epic U749 D5
 Beckton Indigo U504 EP
 Beckton Legend S670
 Beckton Lana S371 DM
 Beckton Scamp X494 E3
 Beckton Coca W061 N
 Beckton Warrior Z936 N6
 BSF Justicia Z009 N

BWt 59
 WR 115
 YWt. 1090
 YR 109
 Feb.ADG 3.70
 Feb.Scr. 32
 Fr. 6.0

Beckton Scamp B497 N4
BSF JUSTICIA D664 S
 BSF Justicia B020 W

DAM
 Age 3
 Wt 885
 Prog.BW 52
 WR 115
 YR 109
 Wean Pct. 61%
 Cow Eff. 128

RAAA HerdBuilder index: 175 (Top 42% of RA breed)
 RAAA GridMaster index: 48 (Top 30% of RA breed)
 Sire Beef Tenderness: 7 'Very Good'
 Calv.Ease BW WW YW Milk HPG Stay Maint.En.
 EPDs 20 -5.5 57 92 26 14 14 -6.0
 Marb +.39 REA -.08 Bfat +.04

35 BECKTON EPIC G250 D8 

1-A 100% # 4170416 Tat.: BKT9 G250

Birth: 3-18-19

Beckton Epic Z674 E6
BECKTON EPIC D275 L7
 Ref. E-3
 Beckton Lana X839 L

Beckton Epic U749 D5
 Beckton Indigo U504 EP
 Beckton Legend S670
 Beckton Lana S371 DM
 Beckton Dominor Z1 R610
 Beckton Mona R166 CQ
 Beckton Justice T124 C1
 Beckton Tamara S623 RA

BWt 71
 WR 111
 YWt. 1110
 YR 114
 Feb.ADG 3.97
 Feb.Scr. 35
 Fr. 5.0

Beckton Dominor W640 C5
BECKTON TAMARA A809 D
 Beckton Tamara W579 J

DAM
 Age 6
 Wt 1105
 Prog.BW 71
 WR 109
 YR 107
 Wean Pct. 51%
 Cow Eff. 107

RAAA HerdBuilder index: 182 (Top 30% of RA breed)
 RAAA GridMaster index: 49 (Top 24% of RA breed)
 Sire Beef Tenderness: 7 'Very Good'
 Calv.Ease BW WW YW Milk HPG Stay Maint.En.
 EPDs 19 -4.5 57 95 25 11 15 -5.0
 Marb +.34 REA +.10 Bfat +.05

★★★★★ for Low Maintenance, Growth, Marbling, Superior Cow, High Cow Efficiency, Calving Ease, Stayability.

★★★★★ for Low Maintenance, Growth, Marbling, Superior Cow, Calving Ease, Stayability.

33 BECKTON ACCENT G377 A 

1-A 100% # 4170414 Tat.: BKT9 G377

Birth: 3-24-19

Beckton Accent W180 C2
BECKTON ACCENT B740 W3
 Ref. A-5
 Beckton Lana Y033 W

Beckton Cody K1 P014
 Beckton Christy R046 CQ
 Beckton Warrior W534 N4
 Beckton Lana W370 E
 Beckton Nebula P P707
 BKT Larkeisa T310 JC
 Beckton Warrior T248 L5
 BKT Suffeina T500 EP

BWt 79
 WR NA
 YWt. NA
 YR NA
 Feb.ADG 3.80
 Feb.Scr. 35
 Fr. 5.5

Beckton New Era Y194
BECKTON SUFFEINA A138 N
 Beckton Suffeina W489 W

DAM
 Age 6
 Wt 1045
 Prog.BW 66
 WR 103
 YR 103
 Wean Pct. NA%
 Cow Eff. NA

RAAA HerdBuilder index: 198 (Top 10% of RA breed)
 RAAA GridMaster index: 48 (Top 34% of RA breed)
 Sire Beef Tenderness: 9 'Outstanding'
 Calv.Ease BW WW YW Milk HPG Stay Maint.En.
 EPDs 18 -4.6 59 100 26 10 18 -4.0
 Marb +.34 REA +.05 Bfat +.04



Lot 35

★★★★★ for Low Maintenance, Marbling, Superior Cow, Calving Ease, Stayability.

34 BSF ACCENT G485 H4 

1-B 99% # 4171202 Tat.: BSF9 G485

Birth: 3-30-19

Beckton Accent W180 C2
BECKTON ACCENT B549 N3
 Ref. A-2
 Beckton Minerva Y654 N

Beckton Cody K1 P014
 Beckton Christy R046 CQ
 Beckton Nebula T398 V3
 Beckton Minerva M369 LO
 Beckton Hustler CN J102
 Beckton Vernice F513 CL
 Beckton Caesar M D023
 BSF Regus Z112

BWt 88
 WR 105
 YWt. 1044
 YR 101
 Feb.ADG 3.59
 Feb.Scr. 34
 Fr. 5.5

Beckton HalfmannHustler R588
BSF HUSTELLE U447 HH
 BSF Regus G191

DAM
 Age 11
 Wt 1150
 Prog.BW 71
 WR 105
 YR 102
 Wean Pct. 48%
 Cow Eff. 101

RAAA HerdBuilder index: 198 (Top 10% of RA breed)
 RAAA GridMaster index: 48 (Top 46% of RA breed)
 Sire Beef Tenderness: 9 'Outstanding'
 Calv.Ease BW WW YW Milk HPG Stay Maint.En.
 EPDs 12 -1.0 61 98 24 14 20 -2.0
 Marb +.38 REA -.06 Bfat +.03

★★★★★ for Low Maintenance, Marbling, Calving Ease, Stayability.

36 BECKTON NEBULA G251 N4 

1-A 100% # 4170658 Tat.: BKT9 G251

Birth: 3-18-19

Beckton Nebula E P084
BECKTON NEBULA EN S347
 Ref. N-2
 Beckton Eola P530 NB

Beckton Nebula M045
 BKT Pine Marie M119 EP
 Beckton Nebula M045
 Beckton Eola M663 EP
 Beckton Nebula M045
 Beckton Lana M809 EP
 Beckton Warrior T248 L5
 Beckton Emera P378 LN

BWt 63
 WR 102
 YWt. 1079
 YR 104
 Feb.ADG 3.59
 Feb.Scr. 36
 Fr. 5.5

Beckton Nebula P P707
BECKTON EMERA C459 N
 Beckton Emera Y196 W

DAM
 Age 4
 Wt 1035
 Prog.BW 65
 WR 101
 YR 104
 Wean Pct. 51%
 Cow Eff. 108

RAAA HerdBuilder index: 223 (Top 1% of RA breed)
 RAAA GridMaster index: 47 (Top 65% of RA breed)
 Sire Beef Tenderness: 7 'Very Good'
 Calv.Ease BW WW YW Milk HPG Stay Maint.En.
 EPDs 19 -6.1 47 75 31 14 20 -8.0
 Marb +.51 REA -.34 Bfat +.05

★★★★★ for Low Maintenance, Marbling, Calving Ease, Stayability.

• Bulls •

37 BECKTON HUGHES G588 J3

1-A 100% # 4170542 Tat.: BKT9 G588

Birth: 4-6-19

BECKTON HUGHES C350 N2
Ref. B-1

BECKTON SERENA B069 J

DAM

Age 5
Wt 1105
Prog. BW 71
WR 95
YR 112
Wean Pct. 53%
Cow Eff. 111

Bieber H Hughes W109
Basin Hobo 0545
Basin Rose 06T0
Beckton Nebula X353 E3
Beckton Kit X236 L
Beckton Julian X721 E6
Beckton Larkaba X064 J
Beckton Nebula J R475
Beckton Serena W265 E

BWt 81
WR 107
YWt. 1091
YR 105
Feb. ADG 3.75
Feb. Scr. 34
Fr. 5.5



RAAA HerdBuilder index: 191 (Top 17% of RA breed)	
RAAA GridMaster index: 47 (Top 62% of RA breed)	
Sire Beef Tenderness: 9 'Outstanding'	
Calv. Ease	BW WW YW Milk HPG Stay Maint. En.
EPDs	16 -3.0 61 95 25 11 17 0.0
Marb +0.34 REA -0.09 Bfat +0.05	

★★★★★ for Low Maintenance, Growth, Marbling, Calving Ease, Stayability.

40 BECKTON NEW ERA G481 N3

1-A 100% # 4170668 Tat.: BKT9 G481

Birth: 3-30-19

BECKTON NEW ERA A908 A2
Ref. N

BECKTON SUFFEINA C168 N

DAM

Age 4
Wt 1085
Prog. BW 77
WR 117
YR 111
Wean Pct. 60%
Cow Eff. 126

Beckton New Era Y194
Beckton Nebula P P707
BKT Larkeisa T310 JC
Beckton Cody K1 P014
Beckton Lana R327 EP
Beckton New Era Y194
Beckton Minerva X612 L
Beckton New Era Y194
Beckton Suffeina A138 N
Beckton Suffeina W489 W

BWt 89
WR 123
YWt. 1110
YR 107
Feb. ADG 3.48
Feb. Scr. 33
Fr. 5.5



RAAA HerdBuilder index: 187 (Top 22% of RA breed)	
RAAA GridMaster index: 47 (Top 67% of RA breed)	
Sire Beef Tenderness: 10 'Outstanding'	
Calv. Ease	BW WW YW Milk HPG Stay Maint. En.
EPDs	10 -0.1 66 106 28 9 20 -3.0
Marb +0.32 REA -0.12 Bfat +0.04	

★★★★★ for Low Maintenance, Growth, Marbling, Superior Cow, High Cow Efficiency, Calving Ease, Stayability.

38 BECKTON DOMINOR G580 W8

1-A 100% # 4170342 Tat.: BKT9 G580

Birth: 4-5-19

BECKTON DOMINOR A378 W7
Ref. D-1

BECKTON LANA Z941 W

DAM

Age 7
Wt 1300
Prog. BW 78
WR 105
YR 109
Wean Pct. 44%
Cow Eff. 93

Beckton Dominor Y005 V6
Beckton Belga W108 V
Beckton Warrior T248 L5
Beckton Lana S074 EP
Beckton Warrior N645 T1
Beckton Lydia H159 JL
Beckton Nebula L P093
Beckton Lana M793 LO

BWt 85
WR 114
YWt. 1123
YR 115
Feb. ADG 3.75
Feb. Scr. 36
Fr. 5.5



RAAA HerdBuilder index: 175 (Top 42% of RA breed)	
RAAA GridMaster index: 51 (Top 4% of RA breed)	
Sire Beef Tenderness: 9 'Outstanding'	
Calv. Ease	BW WW YW Milk HPG Stay Maint. En.
EPDs	15 -1.1 62 105 23 14 14 -4.0
Marb +0.46 REA +0.18 Bfat +0.04	

★★★★★ for Low Maintenance, Growth, Marbling, Rib-eye area, Superior Cow, Calving Ease, Stayability.

41 BECKTON ACCENT G559 A5

1-A 100% # 4171614 Tat.: BKB9 G559

Birth: 4-3-19

BECKTON ACCENT E492 N4
Ref. A-8

BECKTON INDIGO D465 A

DAM

Age 3
Wt 945
Prog. BW 68
WR 123
YR 120
Wean Pct. 59%
Cow Eff. 124

Beckton Accent B740 W3
Beckton Nebula X096 N4
BKT Pine Marie Z177 N
Beckton Accent U777 C2
Beckton Susan R022 CQ
Beckton Loki F251
Beckton Indigo LC22 LO
Beckton Indigo E370 RN

BWt 68
WR 123
YWt. 1154
YR 120
Feb. ADG 3.80
Feb. Scr. 37
Fr. 5.5



RAAA HerdBuilder index: 191 (Top 17% of RA breed)	
RAAA GridMaster index: 48 (Top 43% of RA breed)	
Sire Beef Tenderness: 6 'Average'	
Calv. Ease	BW WW YW Milk HPG Stay Maint. En.
EPDs	19 -4.8 57 93 28 11 17 -4.0
Marb +0.38 REA +0.07 Bfat +0.04	

★★★★★ for Low Maintenance, Growth, Marbling, Superior Cow, High Cow Efficiency, Calving Ease, Stayability.

39 BECKTON NEBULA G310 L4

1-A 100% # 4170398 Tat.: BKT9 G310

Birth: 3-21-19

BECKTON NEBULA B557 J3
Ref. N-4

BECKTON PINE MARIE A446 L

DAM

Age 6
Wt 1130
Prog. BW 69
WR 105
YR 107
Wean Pct. 53%
Cow Eff. 111

Beckton Nebula P P707
Beckton Nebula M045
Beckton Lana M809 EP
Beckton Justice CH M056
Beckton Larkaba P645 JL
Beckton Likable S633
Beckton Lana S718 LN
Beckton Nomad 7496
BKT Pine Marie R246 JE

BWt 81
WR 118
YWt. 1059
YR 108
Feb. ADG 3.21
Feb. Scr. 35
Fr. 5.5



RAAA HerdBuilder index: 200 (Top 9% of RA breed)	
RAAA GridMaster index: 49 (Top 28% of RA breed)	
Sire Beef Tenderness: 6 'Average'	
Calv. Ease	BW WW YW Milk HPG Stay Maint. En.
EPDs	15 -2.9 58 93 24 11 19 -7.0
Marb +0.50 REA -0.11 Bfat +0.03	

★★★★★ for Low Maintenance, Growth, Marbling, Superior Cow, Calving Ease, Stayability.

42 BECKTON EPIC G516 N8

1-A 100% # 4170276 Tat.: BKT9 G516

Birth: 3-31-19

BECKTON EPIC D275 L7
Ref. E-3

BECKTON ROSE Y467 N

DAM

Age 8
Wt 1070
Prog. BW 75
WR 115
YR 112
Wean Pct. 55%
Cow Eff. 116

Beckton Epic Z674 E6
Beckton Epic U749 D5
Beckton Indigo U504 EP
Beckton Legend S670
Beckton Lana S371 DM
Beckton Nebula M045
Beckton Ruth M967 EP
Beckton Hilltop R157
Beckton Rose R507 CT

BWt 84
WR 118
YWt. 1116
YR 114
Feb. ADG 3.59
Feb. Scr. 35
Fr. 5.5



RAAA HerdBuilder index: 167 (Top 55% of RA breed)	
RAAA GridMaster index: 49 (Top 26% of RA breed)	
Sire Beef Tenderness: 7 'Very Good'	
Calv. Ease	BW WW YW Milk HPG Stay Maint. En.
EPDs	13 -1.2 61 99 24 9 16 -3.0
Marb +0.38 REA -0.16 Bfat +0.04	

★★★★★ for Low Maintenance, Growth, Marbling, Superior Cow, High Cow Efficiency, Calving Ease, Stayability.

• Bulls •



Lot 42

45 BECKTON LEGEND G140 C3 

1-A 100% # 4170476 Tat.: BKT9 G140

Birth: 3-10-19

Beckton Legend S670
Beckton Lancer F442 T
Beckton Kit F468 JL

BECKTON LEGEND C313 C2
Ref. L-5
Beckton Minola W808 C
BKT Clifftop TP R288
Beckton Minola R604 CD
BKT Clifftop TP R288

Beckton Clifftop W692 E3
BECKTON LARKABA B704 C
Beckton Larkaba U619 CT
Beckton Lydia S274 EP
Beckton Clifftop T3 N800
Beckton Larkaba M116 CE

BWt	93
WR	110
YWt.	1145
YR	110
Feb.ADG	3.53
Feb.Scr.	36
Fr.	5.5

DAM

Age	5
Wt	1250
Prog.BW	78
WR	105
YR	104
Wean Pct.	48%
Cow Eff.	101

RAAA HerdBuilder index: **169** (Top 53% of RA breed)
RAAA GridMaster index: **50** (Top 14% of RA breed)
Sire Beef Tenderness: **9** 'Outstanding'
Calv.Ease BW WW YW Milk HPG Stay Maint.En.
EPDs **12 0.1 60 100 24 12 16 -4.0**

Marb **+0.42** REA **-0.09** Bfat **+0.04**

★★★★★ for Low Maintenance, Growth, Marbling, Superior Cow, Calving Ease, Stayability.

43 BECKTON EPIC G110 A8 

1-A 100% # 4171622 Tat.: BSF9 G110

Birth: 3-8-19

Beckton Epic Z674 E6
BECKTON EPIC D275 L7
Ref. E-3
Beckton Lana X839 L

Beckton Epic U749 D5
Beckton Indigo U504 EP
Beckton Legend S670
Beckton Lana S371 DM
Beckton Cody K1 P014
Beckton Susan R022 CQ
Beckton Epic KM M115
Beckton Minola J409 LN

BWt	61
WR	111
YWt.	1085
YR	109
Feb.ADG	3.64
Feb.Scr.	37
Fr.	5.5

DAM

Age	3
Wt	940
Prog.BW	62
WR	110
YR	109
Wean Pct.	56%
Cow Eff.	117

RAAA HerdBuilder index: **183** (Top 28% of RA breed)
RAAA GridMaster index: **49** (Top 24% of RA breed)
Sire Beef Tenderness: **7** 'Very Good'
Calv.Ease BW WW YW Milk HPG Stay Maint.En.
EPDs **18 -4.2 59 98 26 10 15 -5.0**

Marb **+0.44** REA **-0.09** Bfat **+0.04**

★★★★★ for Low Maintenance, Growth, Marbling, Superior Cow, High Cow Efficiency, Calving Ease, Stayability.

46 BECKTON LIKABLE G442 S5 

1-A 100% # 4170366 Tat.: BKT9 G442

Birth: 3-27-19

Beckton Likable X445 J3
BECKTON LIKABLE Z057 L4
Ref. L-1
Beckton Minola X107 L

Beckton Likable U130 L2
Beckton Indigo U658 JL
Beckton Likable U120 L2
Beckton Minola U188 NB
Beckton Scamp T A825
Beckton Lana S074 EP
Beckton Nebula PJ S543
Beckton Sierra S639 JO

BWt	79
WR	114
YWt.	1099
YR	106
Feb.ADG	3.42
Feb.Scr.	36
Fr.	6.0

DAM

Age	7
Wt	1220
Prog.BW	71
WR	102
YR	100
Wean Pct.	51%
Cow Eff.	107

RAAA HerdBuilder index: **165** (Top 59% of RA breed)
RAAA GridMaster index: **49** (Top 17% of RA breed)
Sire Beef Tenderness: **9** 'Outstanding'
Calv.Ease BW WW YW Milk HPG Stay Maint.En.
EPDs **18 -5.2 52 90 24 13 13 -7.0**

Marb **+0.44** REA **+0.01** Bfat **+0.03**

★★★★★ for Low Maintenance, Growth, Marbling, Calving Ease, Stayability.

44 BECKTON SCAMP G150 L6 

1-A 100% # 4171284 Tat.: BSF9 G150

Birth: 3-11-19

Beckton Scamp A627 J4
BECKTON SCAMP D325 N5
Ref. S-1
Beckton Tamara Y039 N

Beckton Scamp X494 E3
Beckton Serena R023 JC
Beckton Nebula W065 C3
Beckton Tamara W232 J
Beckton Likable S633
Beckton Lana S718 LN
Beckton Nebula P P707
Beckton Minola N729 JL

BWt	66
WR	94
YWt.	1019
YR	98
Feb.ADG	3.75
Feb.Scr.	36
Fr.	5.5

DAM

Age	9
Wt	960
Prog.BW	65
WR	101
YR	102
Wean Pct.	53%
Cow Eff.	112

RAAA HerdBuilder index: **180** (Top 33% of RA breed)
RAAA GridMaster index: **49** (Top 25% of RA breed)
Sire Beef Tenderness: **10** 'Outstanding'
Calv.Ease BW WW YW Milk HPG Stay Maint.En.
EPDs **20 -6.3 48 85 28 12 14 -12.0**

Marb **+0.38** REA **+0.06** Bfat **+0.03**

★★★★★ for Low Maintenance, Marbling, Calving Ease, Stayability.



Lot 44

• Bulls •

47 BECKTON ACCENT G300 C4
1-A 100% # 4170318 Tat.: BKT9 G300 

Birth: 3-21-19

Beckton Accent U777 C2
Beckton Cody K1 P014
Beckton Susan R022 CQ
Beckton Clifftop TP R288
Beckton Christy S151 NB
Beckton Clifftop TP R288
Beckton Lydia S274 EP
Beckton Epic K4 N795
Beckton Christy L654 JL

BECKTON ACCENT B653 C3
Ref. A-4
Beckton Christy W779 C

BECKTON CHRISTY Z587 C
Beckton Clifftop W692 E3
Beckton Christy S475 EP

BWt	81
WR	109
YWt.	1104
YR	106
Feb.ADG	3.64
Feb.Scr.	36
Fr.	5.5

DAM
Age 7
Wt 1230
Prog.BW 73
WR 105
YR 105
Wean Pct. 48%
Cow Eff. 102

RAAA HerdBuilder index: **149** (Top 81% of RA breed)
RAAA GridMaster index: **48** (Top 44% of RA breed)
Sire Beef Tenderness: **10** 'Outstanding'
Calv.Ease BW WW YW Milk HPG Stay Maint.En.
EPDs **14 -2.1 57 95 27 9 14 -6.0**
Marb **+0.33** REA **-0.11** Bfat **+0.05**

★★★★★ for Low Maintenance, Growth, Marbling, Superior Cow, Calving Ease, Stayability.

50 BECKTON DOMINOR G604 H9
1-A 100% # 4170146 Tat.: BKT9 G604 

Birth: 4-7-19

Beckton Dominor A378 W7
Beckton Dominor Y005 V6
Beckton Lana Y541 W
Beckton Nebula T398 V3
Beckton Indigo T613 JT
Beckton Hustler C2 L079
Beckton Lana L007 JL
Beckton Justice G302
Beckton Christy J743 JL

BECKTON DOMINOR D254 N8
Ref. D-2
Beckton Indigo W772 N

BECKTON CHRISTY T749 HT
Beckton Heritage N013
Beckton Christy N542 JC

BWt	72
WR	112
YWt.	1133
YR	116
Feb.ADG	4.25
Feb.Scr.	38
Fr.	5.5

DAM
Age 12
Wt 1190
Prog.BW 73
WR 103
YR 102
Wean Pct. 46%
Cow Eff. 96

RAAA HerdBuilder index: **207** (Top 5% of RA breed)
RAAA GridMaster index: **50** (Top 10% of RA breed)
Sire Beef Tenderness: **10** 'Outstanding'
Calv.Ease BW WW YW Milk HPG Stay Maint.En.
EPDs **16 -3.5 56 96 27 13 18 -3.0**
Marb **+0.38** REA **+0.14** Bfat **+0.04**

★★★★★ for Low Maintenance, Growth, Gainability, Marbling, Rib-eye area, Calving Ease, Stayability.

48 BECKTON DOMINOR G342 L8
1-A 100% # 4170242 Tat.: BKT9 G342 

Birth: 3-22-19

Beckton Dominor Y005 V6
Beckton Belga W108 V
Beckton Warrior T248 L5
Beckton Lana Y541 W
Beckton Lana S074 EP
Beckton Likable S633
Beckton Lana S718 LN
Beckton Nebula EN S347
Beckton Eola S317 LO

BECKTON DOMINOR A378 W7
Ref. D-1
Beckton Lana Y541 W

BECKTON EOLA X216 L
Beckton Likable U120 L2
Beckton Eola U027 NB

BWt	86
WR	121
YWt.	1157
YR	112
Feb.ADG	3.42
Feb.Scr.	36
Fr.	5.5

DAM
Age 9
Wt 1140
Prog.BW 71
WR 114
YR 105
Wean Pct. 58%
Cow Eff. 121

RAAA HerdBuilder index: **178** (Top 36% of RA breed)
RAAA GridMaster index: **49** (Top 18% of RA breed)
Sire Beef Tenderness: **9** 'Outstanding'
Calv.Ease BW WW YW Milk HPG Stay Maint.En.
EPDs **17 -2.2 55 89 30 12 15 -8.0**
Marb **+0.50** REA **+0.10** Bfat **+0.04**

★★★★★ for Low Maintenance, Growth, Marbling, Superior Cow, High Cow Efficiency, Calving Ease, Stayability.

51 BECKTON RANGER G299 N6
1-A 100% # 4170624 Tat.: BKT9 G299 

Birth: 3-20-19

Beckton Ranger Z225 J4
Beckton Ranger T603 H3
Beckton Mona U564 JT
Beckton Dominor W640 C5
Beckton Suffeina Z731 D
Beckton Suffeina W471 W
Beckton Nebula T398 V3
Beckton Mona X022 L
Beckton Nebula T398 V3
Beckton Indigo U465 EP

BECKTON RANGER B006 D5
Ref. R-1
Beckton Suffeina Z731 D

BECKTON INDIGO C018 N
Beckton Nebula A773 L4
Beckton Indigo A849 N

BWt	74
WR	106
YWt.	1069
YR	109
Feb.ADG	3.98
Feb.Scr.	36
Fr.	5.5

DAM
Age 4
Wt 1030
Prog.BW 64
WR 101
YR 102
Wean Pct. 50%
Cow Eff. 105

RAAA HerdBuilder index: **191** (Top 17% of RA breed)
RAAA GridMaster index: **50** (Top 14% of RA breed)
Sire Beef Tenderness: **7** 'Very Good'
Calv.Ease BW WW YW Milk HPG Stay Maint.En.
EPDs **15 -2.9 60 101 25 12 17 -4.0**
Marb **+0.42** REA **+0.15** Bfat **+0.05**

★★★★★ for Low Maintenance, Growth, Marbling, Rib-eye area, Calving Ease, Stayability.

49 BECKTON LIKABLE G726 N4
1-A 100% # 4170168 Tat.: BKT9 G726 

Birth: 4-23-19

Beckton Likable U130 L2
Beckton Likable S633
Beckton Kit S478 LN
Beckton Roman J S158
Beckton Tamara R834 JC
Beckton Nebula E P084
Beckton Eola P530 NB
Beckton Loki C M740
Beckton Eola J454 JL

BECKTON LIKABLE C229 R3
Ref. L-4
Beckton Tamara X447 J

BECKTON EOLA U027 NB
Beckton Nebula EN S347
Beckton Eola S317 LO

BWt	66
WR	113
YWt.	1168
YR	113
Feb.ADG	3.66
Feb.Scr.	37
Fr.	5.5

DAM
Age 11
Wt 980
Prog.BW 68
WR 113
YR 108
Wean Pct. 61%
Cow Eff. 128

RAAA HerdBuilder index: **189** (Top 20% of RA breed)
RAAA GridMaster index: **48** (Top 49% of RA breed)
Sire Beef Tenderness: **9** 'Outstanding'
Calv.Ease BW WW YW Milk HPG Stay Maint.En.
EPDs **18 -4.2 56 88 28 12 17 -3.0**
Marb **+0.38** REA **-0.02** Bfat **+0.05**

★★★★★ for Low Maintenance, Growth, Marbling, Superior Cow, High Cow Efficiency, Calving Ease, Stayability.

52 BECKTON HERITAGE G197 N5
1-A 100% # 4170736 Tat.: BKT9 G197 

Birth: 3-15-19

Beckton Heritage A767 C3
Beckton Heritage X356 E2
Beckton Rose W816 C
Beckton Loki CL S284
Beckton Susan S684 JJ
Beckton Nebula X096 N4
Beckton Lakme P513 EP
Beckton New Era Y194
Beckton Christy T410 JO

BECKTON HERITAGE D195 L4
Ref. H-1
Beckton Susan W846 L

BECKTON CHRISTY D394 N
Beckton Nebula B620 E5
Beckton Christy B471 N

BWt	70
WR	108
YWt.	1084
YR	113
Feb.ADG	3.82
Feb.Scr.	35
Fr.	5.5

DAM
Age 3
Wt 815
Prog.BW 59
WR 105
YR 107
Wean Pct. 59%
Cow Eff. 125

RAAA HerdBuilder index: **177** (Top 38% of RA breed)
RAAA GridMaster index: **49** (Top 15% of RA breed)
Sire Beef Tenderness: **10** 'Outstanding'
Calv.Ease BW WW YW Milk HPG Stay Maint.En.
EPDs **15 -2.7 63 110 25 12.5 16 -4.0**
Marb **+0.41** REA **-0.08** Bfat **+0.04**

★★★★★ for Low Maintenance, Growth, Marbling, Superior Cow, High Cow Efficiency, Calving Ease, Stayability.

• Bulls •



Lot 52

55 BECKTON NEW ERA G409 L3
1-A 100% # 4170718 Tat.: BKT9 G409

Birth: 3-26-19

Beckton New Era Y194
Beckton Nebula P P707
BKT Larkeisa T310 JC

BECKTON NEW ERA A908 A2
Ref. N Beckton Lana U612 CD
Beckton Cody K1 P014
Beckton Lana R327 EP
Beckton Likable Z057 L4
Beckton Mona Z270 C

Beckton Likable B032 C5
BECKTON LANA D357 L
Beckton Lana B153 A
Beckton Accent Z506 J3
Beckton Lana Z724 A

DAM
Age 3
Wt 1035
Prog. BW 62
WR 116
YR 114
Wean Pct. 51%
Cow Eff. 107

RAAA HerdBuilder index: **199** (Top 10% of RA breed)
RAAA GridMaster index: **49** (Top 29% of RA breed)
Sire Beef Tenderness: **10** 'Outstanding'
Calv. Ease BW WW YW Milk HPG Stay Maint. En.
EPDs **14 -1.9 62 107 28 10 20 -3.0**
Marb **+0.37** REA **-1.10** Bfat **+0.04**

BWt 74
WR 116
YWt. 1092
YR 114
Feb. ADG 3.71
Feb. Scr. 36
Fr. 5.5

★★★★★ for Low Maintenance, Growth, Marbling, Superior Cow, Calving Ease, Stayability.

53 BECKTON RANGER G632 E6
1-A 100% # 4171438 Tat.: BSF9 G632

Birth: 4-10-19

Beckton Ranger Z225 J4
BECKTON RANGER B006 D5
Ref. R-1 Beckton Suffeina Z731 D

Beckton Ranger T603 H3
Beckton Mona U564 JT
Beckton Dominor W640 C5
Beckton Suffeina W471 W
Beckton Epic U749 D5
Beckton Epic Y484 N6
BECKTON CHRISTY B701 E
Beckton Lydia S069 NB
Beckton Legend U331 E2
Beckton Christy X005 L
Beckton Christy U415 JL

DAM
Age 5
Wt 915
Prog. BW 59
WR 105
YR 106
Wean Pct. 59%
Cow Eff. 123

RAAA HerdBuilder index: **172** (Top 46% of RA breed)
RAAA GridMaster index: **50** (Top 9% of RA breed)
Sire Beef Tenderness: **7** 'Very Good'
Calv. Ease BW WW YW Milk HPG Stay Maint. En.
EPDs **18 -5.0 50 92 28 12 13 -6.0**
Marb **+0.45** REA **+1.13** Bfat **+0.04**

BWt 60
WR 99
YWt. 1116
YR 108
Feb. ADG 3.87
Feb. Scr. 39
Fr. 5.5

★★★★★ for Low Maintenance, Growth, Marbling, Rib-eye area, Superior Cow, High Cow Efficiency, Calving Ease, Stayability.

56 BECKTON LEGEND G014 A5
1-A 100% # 4171782 Tat.: BSF9 G014

Birth: 2-14-19

Beckton Legend Z689 J3
BECKTON LEGEND E464 L4
Ref. L-8 Beckton Ucola X143 L

Beckton Legend X561 J2
Beckton Larkaba W868 J
Beckton Likable U120 L2
Beckton Ucola U709 LO
Beckton Accent W180 C2
Beckton Lana R214 RA
BECKTON JANE E340 A
Beckton Jane B220 L
Beckton Legend S670
Beckton Jane P410 NP

DAM
Age 2
Wt 875
Prog. BW 65
WR 110
YR 111
Wean Pct. 49%
Cow Eff. 104

RAAA HerdBuilder index: **193** (Top 15% of RA breed)
RAAA GridMaster index: **48** (Top 35% of RA breed)
Sire Beef Tenderness: **10** 'Outstanding'
Calv. Ease BW WW YW Milk HPG Stay Maint. En.
EPDs **16 -1.6 62 99 22 10 18 -2.0**
Marb **+0.32** REA **+0.04** Bfat **+0.03**

BWt 65
WR 110
YWt. 1012
YR 111
Feb. ADG 3.55
Feb. Scr. 34
Fr. 5.0

★★★★★ for Low Maintenance, Growth, Marbling, Superior Cow, Calving Ease, Stayability.

54 BECKTON ACCENT G380 L3
1-A 100% # 4170394 Tat.: BKT9 G380

Birth: 3-24-19

Beckton Cody K1 P014
BECKTON ACCENT W180 C2
Ref. A-1 Beckton Christy R046 CQ

Beckton Cody KH M390
Beckton Rose M126 WR
Beckton Cherokee N N479
Beckton Christy N740 HR
Beckton Lancer F442 T
Beckton Kit F468 JL
Beckton Legend S670
BECKTON FREYJA A425 L
Beckton Justice C1 R483
Beckton Freyja M659 WR
Beckton Freyja U464 JC

DAM
Age 6
Wt 1190
Prog. BW 63
WR 98
YR 104
Wean Pct. 43%
Cow Eff. 90

RAAA HerdBuilder index: **249** (Top 1% of RA breed)
RAAA GridMaster index: **48** (Top 38% of RA breed)
Sire Beef Tenderness: **9** 'Outstanding'
Calv. Ease BW WW YW Milk HPG Stay Maint. En.
EPDs **19 -4.4 54 87 24 15 23 -3.0**
Marb **+0.31** REA **+0.06** Bfat **+0.03**

BWt 66
WR 94
YWt. 1053
YR 102
Feb. ADG 3.76
Feb. Scr. 36
Fr. 5.0

★★★★★ for Low Maintenance, Marbling, Calving Ease, Stayability.

57 BECKTON RANGER G639 D6
1-A 100% # 4170710 Tat.: BKT9 G639

Birth: 4-11-19

Beckton Ranger Z225 J4
BECKTON RANGER B006 D5
Ref. R-1 Beckton Suffeina Z731 D

Beckton Ranger T603 H3
Beckton Mona U564 JT
Beckton Dominor W640 C5
Beckton Suffeina W471 W
Beckton Dominor Y005 V6
Beckton Lana Y541 W
Beckton Epic Y484 N6
BECKTON MINERVA D506 D
Beckton Minerva A885 E
Beckton Minerva Y324 N

DAM
Age 3
Wt 930
Prog. BW 72
WR 113
YR 113
Wean Pct. 57%
Cow Eff. 121

RAAA HerdBuilder index: **167** (Top 56% of RA breed)
RAAA GridMaster index: **51** (Top 6% of RA breed)
Sire Beef Tenderness: **7** 'Very Good'
Calv. Ease BW WW YW Milk HPG Stay Maint. En.
EPDs **16 -2.4 58 103 28 12 13 -6.0**
Marb **+0.46** REA **+0.22** Bfat **+0.04**

BWt 70
WR 113
YWt. 1128
YR 113
Feb. ADG 3.93
Feb. Scr. 40
Fr. 5.5

★★★★★ for Low Maintenance, Growth, Marbling, Rib-eye area, Superior Cow, High Cow Efficiency, Calving Ease, Stayability.

• Bulls •

58 BECKTON EPIC G590 L7 
 1-A 100% # 4170406 Tat.: BKT9 G590

Birth: 4-6-19

Beckton Epic X464 L5
BECKTON EPIC B310 J6 Ref. E-2
 Beckton Minerva Y116 J

Beckton Epic K6 S569
 Beckton Lana M393 LN
 Beckton Julian W743 H5
 Beckton Minerva W081 N
 Beckton Likable S633
 Beckton Lana S718 LN
 Beckton Nebula T398 V3
 Beckton Mona T809 NB

BWt 73
 WR 103
 YWt. 1014
 YR 98
 Feb.ADG 3.17
 Feb.Scr. 34
 Fr. 5.5

Beckton Likable U120 L2
BECKTON MONA A918 L
 Beckton Mona W093 N

DAM
 Age 6
 Wt 1025
 Prog.BW 63
 WR 98
 YR 99
 Wean Pct. 55%
 Cow Eff. 115

RAAA HerdBuilder index: **204** (Top 6% of RA breed)
 RAAA GridMaster index: **46** (Top 83% of RA breed)
 Sire Beef Tenderness: **10** 'Outstanding'
 Calv.Ease BW WW YW Milk HPG Stay Maint.En.
 EPDs **16 -3.1 56 82 26 12 20 -5.0**

Marb **+0.32** REA **-0.06** Bfat **+0.03**

★★★★★ for Low Maintenance, Marbling, Calving Ease, Stayability.

60 BSF LIKABLE G673 J6 
 1-B 99% # 4171242 Tat.: BSF9 G673

Birth: 4-15-19

Beckton Likable Z057 L4
BECKTON LIKABLE B032 C5 Ref. L-2
 Beckton Mona Z270 C

Beckton Likable X445 J3
 Beckton Minola X107 L
 Beckton Clifftop W577 E3
 Beckton Mona U584 CD
 Beckton Jet L P491
 Beckton Lydia N047 LM
 Beckton Cherokee N N479
 BSF Regus L683 CT

BWt 76
 WR 111
 YWt. 1155
 YR 111
 Feb.ADG 3.80
 Feb.Scr. 33
 Fr. 5.5

Beckton Jet U473 L2
BSF CHERISE X058 J
 BSF Cherise U771 CQ

DAM
 Age 9
 Wt 1080
 Prog.BW 73
 WR 107
 YR 105
 Wean Pct. 56%
 Cow Eff. 118

RAAA HerdBuilder index: **188** (Top 21% of RA breed)
 RAAA GridMaster index: **51** (Top 6% of RA breed)
 Sire Beef Tenderness: **7** 'Very Good'
 Calv.Ease BW WW YW Milk HPG Stay Maint.En.
 EPDs **16 -2.9 60 108 26 14 16 -1.0**

Marb **+0.44** REA **+0.03** Bfat **+0.04**

★★★★★ for Low Maintenance, Growth, Marbling, Superior Cow, High Cow Efficiency, Calving Ease, Stayability.

59 BECKTON WARRIOR G290 S7 
 1-A 100% # 4170586 Tat.: BKT9 G290

Birth: 3-20-19

Beckton Warrior Y108 E5
BECKTON WARRIOR D359 L6 Ref. W-1
 Beckton Lana W463 L

Beckton Warrior W534 N4
 Beckton Susan W058 E
 Beckton Loki CL S284
 Beckton Lana R327 EP
 Beckton Scamp T A825
 Beckton Lana S074 EP
 Beckton Warrior T248 L5
 Beckton Serena N088 WR

BWt 81
 WR 89
 YWt. 1073
 YR 103
 Feb.ADG 4.14
 Feb.Scr. 39
 Fr. 5.5

Beckton Scamp X494 E3
BECKTON SERENA C296 S
 Beckton Serena X287 W

DAM
 Age 4
 Wt 965
 Prog.BW 59
 WR 104
 YR 111
 Wean Pct. 48%
 Cow Eff. 102

RAAA HerdBuilder index: **157** (Top 72% of RA breed)
 RAAA GridMaster index: **48** (Top 46% of RA breed)
 Sire Beef Tenderness: **9** 'Outstanding'
 Calv.Ease BW WW YW Milk HPG Stay Maint.En.
 EPDs **17 -3.5 44 77 29 12 13 -8.0**

Marb **+0.31** REA **-0.26** Bfat **+0.03**

★★★★★ for Low Maintenance, Gainability, Marbling, Superior Cow, Calving Ease, Stayability.

61 BECKTON SCAMP G084 L6 
 1-A 100% # 4170890 Tat.: BKT9 G084

Birth: 3-5-19

Beckton Scamp B720 L4
BECKTON SCAMP E175 N5 Ref. S-2
 Beckton Belga W103 N

Beckton Scamp X458 H3
 Beckton Larkaba Y448 L
 Beckton Nebula T398 V3
 Beckton Belga T551 EP
 Beckton Likable S633
 Beckton Kit S478 LN
 Beckton Julio L233
 Beckton Lana R121 JC

BWt 64
 WR 104
 YWt. 1023
 YR 112
 Feb.ADG 3.48
 Feb.Scr. 33
 Fr. 5.5

Beckton Likable U130 L2
BECKTON LANA E698 L
 Beckton Lana W479 J

DAM
 Age 2
 Wt 840
 Prog.BW 64
 WR 104
 YR 112
 Wean Pct. 48%
 Cow Eff. 102

RAAA HerdBuilder index: **213** (Top 3% of RA breed)
 RAAA GridMaster index: **51** (Top 6% of RA breed)
 Sire Beef Tenderness: **9** 'Outstanding'
 Calv.Ease BW WW YW Milk HPG Stay Maint.En.
 EPDs **17 -2.8 62 106 23 12 18 -10.0**

Marb **+0.25** REA **+0.24** Bfat **+0.04**

★★★★★ for Low Maintenance, Growth, Marbling, Rib-eye area, Superior Cow, Calving Ease, Stayability.



Lot 57

62 BSF ACCENT G339 S4 
 1-B 99% # 4171376 Tat.: BSF9 G339

Birth: 3-22-19

Beckton Accent W180 C2
BECKTON ACCENT B740 W3 Ref. A-5
 Beckton Lana Y033 W

Beckton Cody K1 P014
 Beckton Christy R046 CQ
 Beckton Warrior W534 N4
 Beckton Lana W370 E
 Beckton Scamp T A825
 Beckton Lana S074 EP
 Beckton Warhawk N560
 BSF Regus L616 LN

BWt 74
 WR 95
 YWt. 1080
 YR 104
 Feb.ADG 3.86
 Feb.Scr. 37
 Fr. 5.5

Beckton Scamp X494 E3
BSF WARHANNA A555 S
 BSF Warhanna U471 WA

DAM
 Age 6
 Wt 1100
 Prog.BW 72
 WR 100
 YR 104
 Wean Pct. 47%
 Cow Eff. 98

RAAA HerdBuilder index: **181** (Top 31% of RA breed)
 RAAA GridMaster index: **50** (Top 11% of RA breed)
 Sire Beef Tenderness: **9** 'Outstanding'
 Calv.Ease BW WW YW Milk HPG Stay Maint.En.
 EPDs **19 -3.5 59 101 24 14 14 -5.0**

Marb **+0.31** REA **+0.14** Bfat **+0.03**

★★★★★ for Low Maintenance, Marbling, Rib-eye area, Calving Ease, Stayability.

• Bulls •

63 BSF ORACLE G114 C2 

1-B 99% # 4171762 Tat.: BSF9 G114

Birth: 3-8-19

Schuler Sudden Impact 0004X
SCHULER ORACLE-7142E
 Ref. O-2 Sor Marlee Cmmmtnt 0470X

Red Crowfoot Ole's Oscar
 SOR Duchess TS 8915U
 Brown Commitment S7206
 SOR Marlee Beef 4511P

Beckton Cardinal B074 N
BSF CLIFFTANA E375 C
 BSF Clifftana A563 L

TR Double Eagle ZT220
 BKT Pine Marie Z250 N
 Beckton Legend S670
 BSF Clifftana U655 CT

BWt 58
 WR 120
 YWt. 1010
 YR 115
 Feb.ADG 3.32
 Feb.Scr. 36
 Fr. 5.5

DAM
 Age 2
 Wt 815
 Prog.BW 58
 WR 120
 YR 115
 Wean Pct. 55%
 Cow Eff. 116

RAAA HerdBuilder index: 228 (Top 1% of RA breed)
 RAAA GridMaster index: 51 (Top 6% of RA breed)
 Sire Beef Tenderness: 10 'Outstanding'
 Calv.Ease BW WW YW Milk HPG Stay Maint.En.
 EPDs 20 -4.5 62 102 24 12 19 -2.5
 Marb +.57 REA +.18 Bfat +.02

66 BSF LIKABLE G182 L4 

1-B 99% # 4171250 Tat.: BSF9 G182

Birth: 3-13-19

Beckton Likable U130 L2
BECKTON LIKABLE C229 R3
 Ref. L-4 Beckton Tamara X447 J

Beckton Likable S633
 Beckton Kit S478 LN
 Beckton Roman J S158
 Beckton Tamara R834 JC
 Beckton Lancer F442 T
 Beckton Kit F468 JL
 Beckton Vegas S1 K316
 BSF Red H119

BWt 76
 WR 96
 YWt. 1028
 YR 99
 Feb.ADG 3.10
 Feb.Scr. 33
 Fr. 5.5

DAM
 Age 9
 Wt 1190
 Prog.BW 68
 WR 103
 YR 99
 Wean Pct. 44%
 Cow Eff. 93

RAAA HerdBuilder index: 183 (Top 28% of RA breed)
 RAAA GridMaster index: 48 (Top 34% of RA breed)
 Sire Beef Tenderness: 9 'Outstanding'
 Calv.Ease BW WW YW Milk HPG Stay Maint.En.
 EPDs 15 -2.6 55 86 22 11 17 -3.0
 Marb +.31 REA +.21 Bfat +.03

★★★★★ for Low Maintenance, Growth, Marbling, Rib-eye area, Superior Cow, High Cow Efficiency, Calving Ease, Stayability.

★★★★★ for Low Maintenance, Marbling, Rib-eye area, Calving Ease, Stayability.

64 BSF LEGEND G155 N3 

1-B 99% # 4171330 Tat.: BSF9 G155

Birth: 3-11-19

Beckton Legend S670
BECKTON LEGEND C313 C2
 Ref. L-5 Beckton Minola W808 C

Beckton Lancer F442 T
 Beckton Kit F468 JL
 BKT Clifftop TP R288
 Beckton Minola R604 CD
 Beckton Nomad V 9871
 Beckton Birdie S110 NB
 Beckton Roman J S158
 BSF Nebulann R163 NB

Beckton Nomad X290 N3
BSF NEBULANN Z158 N
 BSF Nebulann X483 J

BWt 71
 WR 97
 YWt. 1040
 YR 100
 Feb.ADG 3.59
 Feb.Scr. 37
 Fr. 5.5

DAM
 Age 7
 Wt 1045
 Prog.BW 65
 WR 101
 YR 102
 Wean Pct. 50%
 Cow Eff. 106

RAAA HerdBuilder index: 172 (Top 47% of RA breed)
 RAAA GridMaster index: 48 (Top 46% of RA breed)
 Sire Beef Tenderness: 9 'Outstanding'
 Calv.Ease BW WW YW Milk HPG Stay Maint.En.
 EPDs 18 -4.1 51 82 26 11 15 -7.0
 Marb +.29 REA +.02 Bfat +.03

★★★★★ for Low Maintenance, Marbling, Calving Ease, Stayability.

67 BSF ACCENT G691 E3 

1-B 99% # 4171562 Tat.: BSF9 G691

Birth: 4-18-19

Beckton Accent U777 C2
BECKTON ACCENT B553 L2
 Ref. A-3 Beckton Lana X839 L

Beckton Cody K1 P014
 Beckton Susan R022 CQ
 Beckton Legend S670
 Beckton Lana S371 DM
 Beckton Epic X330 L6
 Beckton Lana W113 N
 Beckton Nebula Y002 C5
 BSF Dominique Y109 A

BWt 74
 WR 102
 YWt. 1043
 YR 101
 Feb.ADG 3.42
 Feb.Scr. 34
 Fr. 5.5

DAM
 Age 4
 Wt 1080
 Prog.BW 69
 WR 99
 YR 104
 Wean Pct. 50%
 Cow Eff. 104

RAAA HerdBuilder index: 190 (Top 18% of RA breed)
 RAAA GridMaster index: 49 (Top 29% of RA breed)
 Sire Beef Tenderness: 10 'Outstanding'
 Calv.Ease BW WW YW Milk HPG Stay Maint.En.
 EPDs 14 -2.0 57 92 22 12 18 -4.0
 Marb +.39 REA -.06 Bfat +.04

★★★★★ for Low Maintenance, Marbling, Calving Ease, Stayability.

65 BSF NEW ERA G387 J3 

1-B 99% # 4171210 Tat.: BSF9 G387

Birth: 3-25-19

Beckton New Era Y194
BECKTON NEW ERA D478 C2
 Ref. N-6 Beckton Coca X734 C

Beckton Nebula P P707
 BKT Larkeisa T310 JC
 Beckton Cherokee T450 L3
 Beckton Coca T080 NB
 Beckton Justice CH M056
 Beckton Tamara J124 HR
 Beckton Julian G1 J526
 BSF Regus G340

Beckton Justice C1 R483
BSF JULIANNE U743 JC
 BSF Julianne R839 JL

BWt 69
 WR 98
 YWt. 1033
 YR 100
 Feb.ADG 3.04
 Feb.Scr. 37
 Fr. 5.5

DAM
 Age 11
 Wt 1280
 Prog.BW 70
 WR 106
 YR 107
 Wean Pct. 40%
 Cow Eff. 85

RAAA HerdBuilder index: 201 (Top 8% of RA breed)
 RAAA GridMaster index: 47 (Top 61% of RA breed)
 Sire Beef Tenderness: 10 'Outstanding'
 Calv.Ease BW WW YW Milk HPG Stay Maint.En.
 EPDs 18 -5.1 52 86 25 13 18 -3.0
 Marb +.38 REA -.21 Bfat +.05

★★★★★ for Low Maintenance, Marbling, Superior Cow, Calving Ease, Stayability.

68 BECKTON ACCENT G538 A4 

1-A 100% # 4170548 Tat.: BKT9 G538

Birth: 4-2-19

Beckton Accent W180 C2
BECKTON ACCENT D806 W3
 Ref. A Beckton Coca A907 W

Beckton Cody K1 P014
 Beckton Christy R046 CQ
 Beckton Warrior W534 N4
 Beckton Coca U561 CT
 Beckton Accent W180 C2
 Beckton Susan P857 JO
 Beckton Nebula U206 V3
 Beckton Angel T652 NB

BWt 77
 WR 88
 YWt. 1006
 YR 97
 Feb.ADG 3.97
 Feb.Scr. 35
 Fr. 5.5

DAM
 Age 5
 Wt 1230
 Prog.BW 57
 WR 92
 YR 99
 Wean Pct. 39%
 Cow Eff. 82

RAAA HerdBuilder index: 210 (Top 4% of RA breed)
 RAAA GridMaster index: 48 (Top 48% of RA breed)
 Sire Beef Tenderness: 7 'Very Good'
 Calv.Ease BW WW YW Milk HPG Stay Maint.En.
 EPDs 15 -3.3 50 85 26 13 20 -2.0
 Marb +.32 REA +.01 Bfat +.05

★★★★★ for Low Maintenance, Marbling, Calving Ease, Stayability.

• Bulls •

69 BSF LIKABLE G509 J5 

1-B 99% # 4171480 Tat.: BSF9 G509

Birth: 3-30-19

BECKTON LIKABLE Z057 L4
Ref. L-1

BSF LAUREL B171 J

DAM

Age	5
Wt	1115
Prog.BW	67
WR	108
YR	104
Wean Pct.	51%
Cow Eff.	106

Beckton Likable U130 L2
Beckton Indigo U658 JL
Beckton Likable U120 L2
Beckton Minola U188 NB
Beckton Julian X721 E6
Beckton Larkaba X064 J
Beckton Clifftop W692 E3
BSF Laurel U629 WR

BWt 70
WR 104
YWt. 1044
YR 101
Feb.ADG 2.66
Feb.Scr. 35
Fr. 5.5

RAAA HerdBuilder index: 187 (Top 22% of RA breed)
RAAA GridMaster index: 49 (Top 20% of RA breed)
Sire Beef Tenderness: 9 'Outstanding'
Calv.Ease BW WW YW Milk HPG Stay Maint.En.
EPDs 17 -5.4 53 91 25 11 16 -6.0
Marb +.49 REA -.03 Bfat +.04

71 BECKTON LIKABLE G517 J5 

1-A 100% # 4171224 Tat.: BSF9 G517

Birth: 3-31-19

BECKTON LIKABLE Z057 L4
Ref. L-1

BECKTON CHRISTY W827 J

DAM

Age	10
Wt	1135
Prog.BW	62
WR	104
YR	101
Wean Pct.	51%
Cow Eff.	108

Beckton Likable U130 L2
Beckton Indigo U658 JL
Beckton Likable U120 L2
Beckton Minola U188 NB
Beckton Justice CH M056
Beckton Tamara J124 HR
Beckton Cody KH M390
Beckton Christy M362 WR

BWt 57
WR 116
YWt. 1063
YR 109
Feb.ADG 3.64
Feb.Scr. 34
Fr. 5.0

RAAA HerdBuilder index: 203 (Top 7% of RA breed)
RAAA GridMaster index: 49 (Top 21% of RA breed)
Sire Beef Tenderness: 9 'Outstanding'
Calv.Ease BW WW YW Milk HPG Stay Maint.En.
EPDs 21 -7.4 51 91 26 14 17 -6.0
Marb +.43 REA +.00 Bfat +.03

★★★★★ for Low Maintenance, Marbling, Superior Cow, Calving Ease, Stayability.

★★★★★ for Low Maintenance, Growth, Marbling, Calving Ease, Stayability.

70 BECKTON CLIFFTOP G499 N6 

1-A 100% # 4170492 Tat.: BKT9 G499

Birth: 3-30-19

BECKTON CLIFFTOP C572 N5
Ref. C-3

BECKTON ROSE B251 N

DAM

Age	5
Wt	1065
Prog.BW	63
WR	102
YR	105
Wean Pct.	53%
Cow Eff.	111

Beckton Clifftop Y012 C4
Beckton Lana W240 C
Beckton Nebula P P707
BKT Pine Marie U454 NB
Beckton New Era Y194
Beckton Rose W606 L
Beckton Clifftop W692 E3
Beckton Lana W240 C
Beckton Nebula P P707
BKT Pine Marie N582 WR
Beckton Nebula P P707
BKT Larkeisa T310 JC
Beckton Lancer F442 T
Beckton Rose F306 JL

BWt 70
WR 103
YWt. 1124
YR 108
Feb.ADG 3.42
Feb.Scr. 35
Fr. 5.0

RAAA HerdBuilder index: 191 (Top 16% of RA breed)
RAAA GridMaster index: 49 (Top 21% of RA breed)
Sire Beef Tenderness: 7 'Very Good'
Calv.Ease BW WW YW Milk HPG Stay Maint.En.
EPDs 16 -3.6 55 94 27 9 18 -4.0
Marb +.38 REA +.00 Bfat +.04

72 BECKTON DOMINOR G461 N8 

1-A 100% # 4170594 Tat.: BKT9 G461

Birth: 3-28-19

BECKTON DOMINOR A378 W7
Ref. D-1

BECKTON ROSE C767 N

DAM

Age	4
Wt	1040
Prog.BW	66
WR	103
YR	97
Wean Pct.	55%
Cow Eff.	116

Beckton Dominor Y005 V6
Beckton Lana Y541 W
Beckton Nebula EN S347
Beckton Rose W816 C
Beckton Dominor W640 C5
Beckton Belga W108 V
Beckton Warrior T248 L5
Beckton Lana S074 EP
Beckton Nebula E P084
Beckton Eola P530 NB
BKT Clifftop TP R288
Beckton Rose S487 LN

BWt 70
WR 118
YWt. 1112
YR 114
Feb.ADG 3.59
Feb.Scr. 35
Fr. 5.5

RAAA HerdBuilder index: 195 (Top 13% of RA breed)
RAAA GridMaster index: 49 (Top 18% of RA breed)
Sire Beef Tenderness: 9 'Outstanding'
Calv.Ease BW WW YW Milk HPG Stay Maint.En.
EPDs 19 -3.7 53 89 29 13 16 -9.0
Marb +.46 REA +.16 Bfat +.05

★★★★★ for Low Maintenance, Growth, Marbling, Calving Ease, Stayability.

★★★★★ for Low Maintenance, Growth, Marbling, Rib-eye area, High Cow Efficiency, Calving Ease, Stayability.



Lot 70

73 BECKTON JULIAN G496 L5 

1-A 100% # 4171226 Tat.: BSF9 G496

Birth: 3-30-19

BECKTON JULIAN G3 P608
Ref. J-3

BECKTON TARA W482 L

DAM

Age	10
Wt	1125
Prog.BW	68
WR	108
YR	107
Wean Pct.	52%
Cow Eff.	109

Beckton Julian GG B571
Bkt Sufteina A828 DM
Beckton Loki CL S284
Beckton Tara R609 JC
Beckton Julian 7526G
Bkt Marta 9A13 JL
Beckton Dominor 9455
Bkt Sufteina 9493 TT
Beckton Loki C M740
Beckton Lakme J460 LT
Beckton Justice CH M056
Beckton Tara M635 JL

BWt 82
WR 107
YWt. 1106
YR 107
Feb.ADG 2.99
Feb.Scr. 35
Fr. 5.0

RAAA HerdBuilder index: 170 (Top 51% of RA breed)
RAAA GridMaster index: 49 (Top 16% of RA breed)
Sire Beef Tenderness: 8 'Very Good'
Calv.Ease BW WW YW Milk HPG Stay Maint.En.
EPDs 18 -4.5 51 84 25 12 14 -8.0
Marb +.49 REA -.16 Bfat +.02

★★★★★ for Low Maintenance, Growth, Marbling, Superior Cow, Calving Ease, Stayability.

• Bulls •

74 BECKTON DOMINOR G343 N8 1-A 100% # 4170266 Tat.: BKT9 G343 

Birth: 3-22-19

Beckton Dominor Y005 V6 < Beckton Dominor W640 C5
Beckton Belga W108 V

BECKTON DOMINOR A378 W7
Ref. D-1 < Beckton Lana Y541 W < Beckton Warrior T248 L5
Beckton Lana S074 EP

Beckton Nebula U206 V3 < Beckton Nebula P P707
Beckton Minerva J615 VG

BECKTON CHRISTY Y413 N
Beckton Christy S475 EP < Beckton Epic K4 N795
Beckton Christy L654 JL

BWt	66
WR	107
YWt.	1058
YR	108
Feb.ADG	3.53
Feb.Scr.	37
Fr.	5.0

DAM
Age 8
Wt 1200
Prog.BW 63
WR 104
YR 104
Wean Pct. 45%
Cow Eff. 94

RAAA HerdBuilder index: **190** (Top 18% of RA breed)
RAAA GridMaster index: **49** (Top 28% of RA breed)
Sire Beef Tenderness: **9** 'Outstanding'
Calv.Ease BW WW YW Milk HPG Stay Maint.En.
EPDs **18 -4.6 50 86 28 12 16 -5.0**
Marb **+0.39** REA **+0.16** Bfat **+0.05**

76 BECKTON EPIC G681 N7 1-A 100% # 4171272 Tat.: BSF9 G681 

Birth: 4-16-19

Beckton Epic X464 L5 < Beckton Epic K6 S569
Beckton Lana M393 LN

BECKTON EPIC B310 J6
Ref. E-2 < Beckton Minerva Y116 J < Beckton Julian W743 H5
Beckton Minerva W081 N

Beckton Nebula T398 V3 < Beckton Nebula L P093
Beckton Minerva J615 VG

BECKTON LANA X466 N
Beckton Lana T226 NB < Beckton Nebula E P084
Beckton Lana P026 DM

BWt	68
WR	112
YWt.	1092
YR	105
Feb.ADG	3.26
Feb.Scr.	36
Fr.	5.5

DAM
Age 9
Wt 1210
Prog.BW 70
WR 108
YR 104
Wean Pct. 50%
Cow Eff. 106

RAAA HerdBuilder index: **209** (Top 4% of RA breed)
RAAA GridMaster index: **47** (Top 52% of RA breed)
Sire Beef Tenderness: **10** 'Outstanding'
Calv.Ease BW WW YW Milk HPG Stay Maint.En.
EPDs **15 -3.3 61 96 26 13 20 -1.0**
Marb **+0.33** REA **-0.01** Bfat **+0.04**

★★★★★ for Low Maintenance, Growth, Marbling, Rib-eye area, Superior Cow, Calving Ease, Stayability.

★★★★★ for Low Maintenance, Growth, Marbling, Superior Cow, Calving Ease, Stayability.



Lot 74

77 BECKTON EPIC G498 A8 1-A 100% # 4170376 Tat.: BKT9 G498 

Birth: 3-30-19

Beckton Epic Z674 E6 < Beckton Epic U749 D5
Beckton Indigo U504 EP

BECKTON EPIC D275 L7
Ref. E-3 < Beckton Lana X839 L < Beckton Legend S670
Beckton Lana S371 DM

Beckton Accent U777 C2 < Beckton Cody K1 P014
Beckton Susan R022 CQ

BECKTON VERNICE A176 A
Beckton Vernice L382 LN < Beckton Lancer TZ D525
Beckton Vernice G373 WR

BWt	59
WR	111
YWt.	1059
YR	108
Feb.ADG	3.64
Feb.Scr.	32
Fr.	5.5

DAM
Age 6
Wt 1040
Prog.BW 56
WR 102
YR 103
Wean Pct. 54%
Cow Eff. 113

RAAA HerdBuilder index: **191** (Top 17% of RA breed)
RAAA GridMaster index: **48** (Top 44% of RA breed)
Sire Beef Tenderness: **7** 'Very Good'
Calv.Ease BW WW YW Milk HPG Stay Maint.En.
EPDs **21 -6.3 52 87 25 11 16 -4.0**
Marb **+0.36** REA **+0.04** Bfat **+0.04**

★★★★★ for Low Maintenance, Growth, Marbling, Calving Ease, Stayability.

75 BECKTON LEGEND G482 E4 1-A 100% # 4171528 Tat.: BSF9 G482 

Birth: 3-30-19

Beckton Legend X561 J2 < Beckton Legend S670
Beckton Lana T279 JO

BECKTON LEGEND Z689 J3
Ref. L < Beckton Julian G5 S107
Beckton Larkaba S663 JE

Beckton Epic X464 L5 < Beckton Epic K6 S569
Beckton Lana M393 LN

BECKTON MARTA C679 E
Beckton Marta X010 N < Beckton Nebula U031 D3
Beckton Marta U079 NB

BWt	86
WR	105
YWt.	1038
YR	100
Feb.ADG	3.21
Feb.Scr.	34
Fr.	5.5

DAM
Age 4
Wt 1045
Prog.BW 78
WR 105
YR 101
Wean Pct. 53%
Cow Eff. 111

RAAA HerdBuilder index: **186** (Top 23% of RA breed)
RAAA GridMaster index: **47** (Top 60% of RA breed)
Sire Beef Tenderness: **10** 'Outstanding'
Calv.Ease BW WW YW Milk HPG Stay Maint.En.
EPDs **10 0.3 62 93 24 13 19 0.0**
Marb **+0.33** REA **-0.06** Bfat **+0.04**

★★★★★ for Low Maintenance, Marbling, Calving Ease, Stayability.

78 BECKTON CLIFFTOP G440 E6 1-A 100% # 4171546 Tat.: BSF9 G440 

Birth: 3-27-19

Beckton Clifftop Y012 C4 < Beckton Clifftop W692 E3
Beckton Lana W240 C

BECKTON CLIFFTOP C572 N5
Ref. C-3 < BKT Pine Marie U454 NB < Beckton Nebula P P707
BKT Pine Marie N582 WR

Beckton Epic A286 E7 < Beckton Epic Y484 N6
Beckton Larkaba Y648 E

BECKTON JANE C065 E
Beckton Jane A724 E < Beckton Epic U749 D5
Beckton Jane X164 N

BWt	80
WR	118
YWt.	1050
YR	107
Feb.ADG	3.32
Feb.Scr.	38
Fr.	5.5

DAM
Age 4
Wt 1130
Prog.BW 66
WR 116
YR 109
Wean Pct. 51%
Cow Eff. 107

RAAA HerdBuilder index: **167** (Top 55% of RA breed)
RAAA GridMaster index: **48** (Top 33% of RA breed)
Sire Beef Tenderness: **7** 'Very Good'
Calv.Ease BW WW YW Milk HPG Stay Maint.En.
EPDs **16 -2.9 56 94 28 9 15 -1.0**
Marb **+0.41** REA **-0.04** Bfat **+0.05**

★★★★★ for Low Maintenance, Growth, Marbling, Superior Cow, Calving Ease, Stayability.

• Bulls •

79 BECKTON WARRIOR G372 A8
1-A 100% # 4170772 Tat.: BKT9 G372



Birth: 3-24-19

Beckton Warrior C695 W6
 Beckton Lana Y033 W
 Beckton Emperor A165 W4
 Beckton Suffeina C124 E
 Beckton Suffeina A439 N
 Beckton Cody K1 P014
 Beckton Christy R046 CQ
 Beckton Epic K3 M606
 Beckton Tara M635 JL

BECKTON WARRIOR E215 E7
Ref. W-2

BECKTON TARA D477 A
Beckton Tara T537 EP

BWt	75
WR	124
YWt.	1068
YR	111
Feb.ADG	3.53
Feb.Scr.	36
Fr.	5.5

DAM

Age	3
Wt	1070
Prog.BW	66
WR	124
YR	111
Wean Pct.	53%
Cow Eff.	111

RAAA HerdBuilder index: **171** (Top 49% of RA breed)
 RAAA GridMaster index: **48** (Top 39% of RA breed)
 Sire Beef Tenderness: **7** 'Very Good'
 Calv.Ease BW WW YW Milk HPG Stay Maint.En.
 EPDs **18 -4.7 60 98 26 10 15 -5.0**
 Marb **+0.36** REA **+0.05** Bfat **+0.04**



Lot 81

★★★★★ for Low Maintenance, Growth, Marbling, Superior Cow, Calving Ease, Stayability.

80 BECKTON ACCENT G207 J3
1-A 100% # 4171370 Tat.: BSF9 G207



Birth: 3-15-19

Beckton Cody K1 P014
 Beckton Rose M126 WR
 Beckton Cherokee N N479
 Beckton Christy R046 CQ
 Beckton Christy N740 HR
 Beckton Julian GJ P535
 Beckton Minola P826 DM
 Beckton Julian G3 P608
 Beckton Larkaba N708 HR

BECKTON ACCENT W180 C2
Ref. A-1

BECKTON LARKABA A491 J
Beckton Larkaba U274 JL

BWt	82
WR	85
YWt.	985
YR	95
Feb.ADG	3.55
Feb.Scr.	36
Fr.	5.5

DAM

Age	6
Wt	1010
Prog.BW	64
WR	94
YR	98
Wean Pct.	46%
Cow Eff.	97

RAAA HerdBuilder index: **212** (Top 3% of RA breed)
 RAAA GridMaster index: **48** (Top 45% of RA breed)
 Sire Beef Tenderness: **9** 'Outstanding'
 Calv.Ease BW WW YW Milk HPG Stay Maint.En.
 EPDs **17 -3.7 52 85 23 16 19 -6.0**
 Marb **+0.28** REA **-0.09** Bfat **+0.04**

★★★★★ for Low Maintenance, Marbling, Calving Ease, Stayability.



Lot 80

81 BECKTON ACCENT G500 N4
1-A 100% # 4170676 Tat.: BKT9 G500



Birth: 3-30-19

Beckton Accent U777 C2
 Beckton Susan R022 CQ
 BKT Clifftop TP R288
 Beckton Christy W779 C
 Beckton Christy S151 NB
 Beckton Nebula W778 J4
 Beckton Lana T104 CT
 Beckton Nebula Y002 C5
 Beckton Ruth Y047 N

BECKTON ACCENT B653 C3
Ref. A-4

BECKTON RUTH C356 N
Beckton Ruth A010 N

BWt	54
WR	96
YWt.	1090
YR	105
Feb.ADG	3.60
Feb.Scr.	35
Fr.	5.5

DAM

Age	4
Wt	920
Prog.BW	57
WR	99
YR	103
Wean Pct.	54%
Cow Eff.	114

RAAA HerdBuilder index: **196** (Top 12% of RA breed)
 RAAA GridMaster index: **48** (Top 47% of RA breed)
 Sire Beef Tenderness: **10** 'Outstanding'
 Calv.Ease BW WW YW Milk HPG Stay Maint.En.
 EPDs **20 -5.8 52 87 25 11 17 -9.0**
 Marb **+0.31** REA **-0.11** Bfat **+0.04**

★★★★★ for Low Maintenance, Growth, Marbling, Calving Ease, Stayability.

82 BECKTON RANGER G475 C6
1-A 100% # 4171194 Tat.: BSF9 G475



Birth: 3-29-19

Beckton Ranger Z225 J4
 Beckton Ranger T603 H3
 Beckton Mona U564 JT
 Beckton Dominor W640 C5
 Beckton Suffeina W471 W
 Beckton Cody KH M390
 Beckton Rose M126 WR
 Beckton Loki F251
 Beckton Angel F571 LN

BECKTON RANGER B006 D5
Ref. R-1

BECKTON ANGEL U746 CD
Beckton Angel H164 LO

BWt	71
WR	95
YWt.	1016
YR	98
Feb.ADG	3.71
Feb.Scr.	34
Fr.	5.5

DAM

Age	11
Wt	1210
Prog.BW	72
WR	101
YR	102
Wean Pct.	41%
Cow Eff.	86

RAAA HerdBuilder index: **178** (Top 36% of RA breed)
 RAAA GridMaster index: **49** (Top 19% of RA breed)
 Sire Beef Tenderness: **7** 'Very Good'
 Calv.Ease BW WW YW Milk HPG Stay Maint.En.
 EPDs **15 -2.7 54 92 27 11 16 -3.0**
 Marb **+0.40** REA **-0.04** Bfat **+0.03**

★★★★★ for Low Maintenance, Marbling, Calving Ease, Stayability.

• Bulls •

83 BECKTON NEBULA G206 N4
1-A 100% # 4170272 Tat.: BKT9 G206 

Birth: 3-15-19

Beckton Nebula P P707
BECKTON NEBULA B557 J3
Ref. N-4

Beckton Larkaba T813 JC

Beckton Nebula M045
Beckton Lana M809 EP
Beckton Justice CH M056
Beckton Larkaba P645 JL
Beckton Nebula L P093
Beckton Minerva J615 VG
Beckton Nebula E P084
Beckton Lana M167 LN

BWt 55
WR 90
YWt. 981
YR 95
Feb.ADG 2.85
Feb.Scr. 33
Fr. 5.5

BECKTON LANA Y726 N
Beckton Nebula T398 V3
Beckton Lana T348 NB

DAM
Age 8
Wt 1065
Prog.BW 64
WR 105
YR 102
Wean Pct. 46%
Cow Eff. 97

RAAA HerdBuilder index: **221** (Top 1% of RA breed)
RAAA GridMaster index: **49** (Top 29% of RA breed)
Sire Beef Tenderness: **6** 'Average'
Calv.Ease BW WW YW Milk HPG Stay Maint.En.
EPDs **17 -6.5 45 79 31 12 21 -4.0**
Marb **+0.53** REA **-0.02** Bfat **+0.05**

★★★★★ for Low Maintenance, Marbling, Calving Ease, Stayability.

86 BECKTON LIKABLE G154 A4
1-A 100% # 4170570 Tat.: BKT9 G154 

Birth: 3-11-19

Beckton Likable U130 L2
BECKTON LIKABLE C229 R3
Ref. L-4

Beckton Tamara X447 J

Beckton Likable S633
Beckton Kit S478 LN
Beckton Roman J S158
Beckton Tamara R834 JC
Beckton Accent W180 C2
Beckton Lana W463 L
Beckton Clifftop W577 E3
Beckton Emera P378 LN

BWt 82
WR 95
YWt. 995
YR 96
Feb.ADG 3.33
Feb.Scr. 35
Fr. 5.5

BECKTON EMERA C369 A
Beckton Accent Y260 L3
Beckton Emera Z775 C

DAM
Age 4
Wt 1050
Prog.BW 69
WR 108
YR 103
Wean Pct. 47%
Cow Eff. 99

RAAA HerdBuilder index: **210** (Top 4% of RA breed)
RAAA GridMaster index: **47** (Top 57% of RA breed)
Sire Beef Tenderness: **9** 'Outstanding'
Calv.Ease BW WW YW Milk HPG Stay Maint.En.
EPDs **14 -1.7 53 82 24 11 21 -3.0**
Marb **+0.40** REA **-0.11** Bfat **+0.05**

★★★★★ for Low Maintenance, Marbling, Superior Cow, Calving Ease, Stayability.

84 BECKTON LANCER G050 A2
1-A 100% # 4171102 Tat.: BKT9 G050 

Birth: 2-25-19

Redhill U199 Lancer 9B
REDHILL 9B LANCER 11E
Ref. O-1

Redhill T189 Barmaid 190W

Buf Crk The Right Kind U199
Buf Crk Redpride P154
Buf Crk Nice'N Easy T189
1BWJ Barmaid 54P
Beckton Accent Y312 N3
Beckton Minerva Y654 N
Beckton Scamp X458 H3
Beckton Susan Z427 L

BWt 62
WR 110
YWt. 1023
YR 112
Feb.ADG 3.71
Feb.Scr. 36
Fr. 5.5

BECKTON SUSAN E005 A
Beckton Accent C557 N4
Beckton Susan C884 S

DAM
Age 2
Wt 790
Prog.BW 62
WR 110
YR 112
Wean Pct. 54%
Cow Eff. 115

RAAA HerdBuilder index: **168** (Top 55% of RA breed)
RAAA GridMaster index: **49** (Top 19% of RA breed)
Sire Beef Tenderness: **7** 'Very Good'
Calv.Ease BW WW YW Milk HPG Stay Maint.En.
EPDs **14 -1.8 66 105 25 13 14 -6.0**
Marb **+0.37** REA **+0.09** Bfat **+0.04**

★★★★★ for Low Maintenance, Growth, Marbling, Superior Cow, Calving Ease, Stayability.

87 BECKTON ACCENT G212 J4
1-A 100% # 4170368 Tat.: BKT9 G212 

Birth: 3-16-19

Beckton Accent U777 C2
BECKTON ACCENT B653 C3
Ref. A-4

Beckton Christy W779 C

Beckton Cody K1 P014
Beckton Susan R022 CQ
BKT Clifftop TP R288
Beckton Christy S151 NB
Beckton Roman J S158
Beckton Sierra K557 LO
Beckton Nebula T054 H3
Beckton Rose T142 HI

BWt 85
WR 96
YWt. 988
YR 101
Feb.ADG 3.50
Feb.Scr. 35
Fr. 5.5

BECKTON ROSE Z078 J
Beckton Janus X799 L2
Beckton Rose X573 N

DAM
Age 7
Wt 1160
Prog.BW 81
WR 106
YR 101
Wean Pct. 42%
Cow Eff. 88

RAAA HerdBuilder index: **160** (Top 68% of RA breed)
RAAA GridMaster index: **48** (Top 42% of RA breed)
Sire Beef Tenderness: **10** 'Outstanding'
Calv.Ease BW WW YW Milk HPG Stay Maint.En.
EPDs **14 -1.0 54 90 26 10 15 -4.0**
Marb **+0.26** REA **-0.13** Bfat **+0.04**

★★★★★ for Low Maintenance, Marbling, Calving Ease, Stayability.

85 BECKTON CLIFFTOP G574 L6
1-A 100% # 4170380 Tat.: BKT9 G574 

Birth: 4-5-19

Beckton Clifftop Y012 C4
BECKTON CLIFFTOP C572 N5
Ref. C-3

BKT Pine Marie U454 NB

Beckton Clifftop W692 E3
Beckton Lana W240 C
Beckton Nebula P P707
BKT Pine Marie N582 WR
Beckton Likable S633
Beckton Lana S718 LN
Beckton Jules L429
Beckton Susan L258 LR

BWt 64
WR 98
YWt. 1021
YR 104
Feb.ADG 3.76
Feb.Scr. 36
Fr. 5.5

BECKTON SUSAN A839 L
Beckton Likable U120 L2
Beckton Susan N023 JE

DAM
Age 6
Wt 970
Prog.BW 64
WR 92
YR 98
Wean Pct. 51%
Cow Eff. 108

RAAA HerdBuilder index: **207** (Top 5% of RA breed)
RAAA GridMaster index: **49** (Top 25% of RA breed)
Sire Beef Tenderness: **7** 'Very Good'
Calv.Ease BW WW YW Milk HPG Stay Maint.En.
EPDs **19 -5.3 48 81 29 10 18 -8.0**
Marb **+0.42** REA **+0.05** Bfat **+0.04**

★★★★★ for Low Maintenance, Marbling, Calving Ease, Stayability.

88 BECKTON RANGER G621 A6
1-A 100% # 4170840 Tat.: BKT9 G621 

Birth: 4-10-19

Beckton Ranger Z225 J4
BECKTON RANGER B006 D5
Ref. R-1

Beckton Suffeina Z731 D

Beckton Ranger T603 H3
Beckton Mona U564 JT
Beckton Dominor W640 C5
Beckton Suffeina W471 W
Beckton Cody K1 P014
Beckton Susan R022 CQ
Beckton Accent W180 C2
Beckton Coca T168 NB

BWt 71
WR 109
YWt. 1037
YR 104
Feb.ADG 3.33
Feb.Scr. 35
Fr. 5.5

BECKTON COCA D139 A
Beckton Accent U777 C2
Beckton Coca Z529 A

DAM
Age 3
Wt 1040
Prog.BW 65
WR 110
YR 104
Wean Pct. 49%
Cow Eff. 103

RAAA HerdBuilder index: **171** (Top 49% of RA breed)
RAAA GridMaster index: **48** (Top 38% of RA breed)
Sire Beef Tenderness: **7** 'Very Good'
Calv.Ease BW WW YW Milk HPG Stay Maint.En.
EPDs **16 -2.9 58 95 26 13 15 -3.0**
Marb **+0.44** REA **+0.01** Bfat **+0.04**

★★★★★ for Low Maintenance, Marbling, Superior Cow, Calving Ease, Stayability.

• Bulls •

89 BECKTON ACCENT G163 N4
1-A 100% # 4170490 Tat.: BKT9 G163



Birth: 3-12-19

Beckton Accent W180 C2
Beckton Christy R046 CQ
Beckton Nebula T398 V3
Beckton Minerva Y654 N
Beckton Minerva M369 LO
Beckton Nebula U206 V3
Beckton Tamara U185 NB
Beckton Epic K4 N795
Beckton Larkeisa P136 NP

BECKTON ACCENT B549 N3
Ref. A-2

BECKTON LARKEISA B179 N
Beckton Larkeisa W227 E

DAM
Age 5
Wt 1090
Prog.BW 60
WR 101
YR 97
Wean Pct. 43%
Cow Eff. 91

BWt 77
WR 87
YWt. 940
YR 91
Feb.ADG 3.07
Feb.Scr. 35
Fr. 5.5

RAAA HerdBuilder index: 191 (Top 17% of RA breed)
RAAA GridMaster index: 46 (Top 77% of RA breed)
Sire Beef Tenderness: 9 'Outstanding'
Calv.Ease BW WW YW Milk HPG Stay Maint.En.
EPDs 13 -2.7 51 85 27 10 20 1.0
Marb +.35 REA -.17 Bfat +.04

91 BECKTON JET G441 N2
1-A 100% # 4170464 Tat.: BKT9 G441



Birth: 3-27-19

TR Julian Lt151
Beckton Julian GG B571
MS GEOMETRIC 917
Beckton Lancer TS D390
Beckton Minerva F495 CH
Beckton Nebula P P707
BKT Larkeisa T310 JC
Beckton Cherokee N N479
Beckton Susan N023 JE

BECKTON JET L P491
Ref. J

BECKTON SUSAN B246 N
Beckton Susan R022 CQ

DAM
Age 5
Wt 1040
Prog.BW 57
WR 94
YR 106
Wean Pct. 51%
Cow Eff. 106

BWt 66
WR 104
YWt. 1056
YR 108
Feb.ADG 3.33
Feb.Scr. 38
Fr. 5.0

RAAA HerdBuilder index: 212 (Top 3% of RA breed)
RAAA GridMaster index: 48 (Top 42% of RA breed)
Sire Beef Tenderness: 8 'Very Good'
Calv.Ease BW WW YW Milk HPG Stay Maint.En.
EPDs 20 -6.7 48 77 27 11 19 -5.0
Marb +.44 REA -.05 Bfat +.04

★★★★★ for Low Maintenance, Marbling, Calving Ease, Stayability.

★★★★★ for Low Maintenance, Growth, Marbling, Calving Ease, Stayability.



Lot 90



Lot 92

90 BECKTON CARDINAL G043 C2
1-A 100% # 4170880 Tat.: BKT9 G043



Birth: 2-24-19

TR Double Eagle ZT220
Beckton Ricardo DOS
Beckton Lana U182 JC
Beckton Legend U331 E2
Beckton Larkaba T418 WA
Beckton Ricardo DOS
Beckton Lana U182 JC
Beckton Julian G3 P608
Beckton Minerva L344 CH

BECKTON CARDINAL E673 L
Ref. C-6

BECKTON MINERVA E181 D
Beckton Minerva W901 J

DAM
Age 2
Wt 725
Prog.BW 59
WR 117
YR 119
Wean Pct. 61%
Cow Eff. 127

BWt 59
WR 117
YWt. 1039
YR 119
Feb.ADG 3.87
Feb.Scr. 36
Fr. 5.5

RAAA HerdBuilder index: 215 (Top 3% of RA breed)
RAAA GridMaster index: 50 (Top 7% of RA breed)
Sire Beef Tenderness: 6 'Average'
Calv.Ease BW WW YW Milk HPG Stay Maint.En.
EPDs 21 -4.7 65 106 22 14 16 -6.0
Marb +.38 REA +.20 Bfat +.04

★★★★★ for Low Maintenance, Growth, Marbling, Rib-eye area, Superior Cow, High Cow Efficiency, Calving Ease, Stayability.

92 BECKTON EPIC G471 C7
1-A 100% # 4170730 Tat.: BKT9 G471



Birth: 3-29-19

Beckton Epic U749 D5
Beckton Epic K4 N795
Beckton Denise R308 DM
Beckton Epic K6 S569
Beckton Indigo S016 NB
TR Double Eagle ZT220
BKT Pine Marie Z250 N
Beckton Accent Z506 J3
Beckton Indigo Z870 E

BECKTON EPIC Z674 E6
Ref. E-1

BECKTON INDIGO D005 C
Beckton Cardinal B074 N
Beckton Indigo B327 A

DAM
Age 3
Wt 870
Prog.BW 64
WR 104
YR 107
Wean Pct. 56%
Cow Eff. 118

BWt 73
WR 105
YWt. 1143
YR 114
Feb.ADG 4.25
Feb.Scr. 35
Fr. 5.5

RAAA HerdBuilder index: 181 (Top 32% of RA breed)
RAAA GridMaster index: 51 (Top 5% of RA breed)
Sire Beef Tenderness: 10 'Outstanding'
Calv.Ease BW WW YW Milk HPG Stay Maint.En.
EPDs 16 -2.8 64 112 27 9 15 -3.0
Marb +.39 REA +.13 Bfat +.05

★★★★★ for Low Maintenance, Growth, Gainability, Marbling, Rib-eye area, Superior Cow, High Cow Efficiency, Calving Ease, Stayability.

• Bulls •

93 BECKTON EPIC G533 L7
1-A 100% # 4170496 Tat.: BKT9 G533



Birth: 4-1-19

Beckton Epic U749 D5
BECKTON EPIC Z674 E6
Ref. E-1

Beckton Indigo U504 EP

Beckton Epic K4 N795
Beckton Denise R308 DM
Beckton Epic K6 S569
Beckton Indigo S016 NB
Beckton Likable U130 L2
BKT Pine Marie S802 LO
Beckton Dominor Z1 R610
Beckton Lana S858 JL

BWt 62
WR 96
YWt. 1040
YR 100
Feb.ADG 3.33
Feb.Scr. 38
Fr. 5.0

Beckton Likable Y124 L3
BECKTON LANA B316 L
Beckton Lana W748 D

DAM
Age 5
Wt 1165
Prog.BW 66
WR 108
YR 108
Wean Pct. 45%
Cow Eff. 94

RAAA HerdBuilder index: 191 (Top 17% of RA breed)
RAAA GridMaster index: 48 (Top 41% of RA breed)
Sire Beef Tenderness: 10 'Outstanding'
Calv.Ease BW WW YW Milk HPG Stay Maint.En.
EPDs 20 -5.9 49 84 28 10 16 -2.0
Marb +.43 REA -.18 Bfat +.05

96 BECKTON ACCENT G370 N4
1-A 100% # 4170628 Tat.: BKT9 G370



Birth: 3-24-19

Beckton Accent U777 C2
BECKTON ACCENT B653 C3
Ref. A-4

Beckton Christy W779 C

Beckton Cody K1 P014
Beckton Susan R022 CQ
BKT Clifftop TP R288
Beckton Christy S151 NB
Beckton New Era Y194
Beckton Minerva X612 L
Beckton New Era A395 L2
BECKTON LARKABA C061 N
Beckton Larkaba A804 N
Beckton Nebula T269 E2
Beckton Larkaba W693 N

BWt 60
WR 108
YWt. 1036
YR 106
Feb.ADG 3.71
Feb.Scr. 36
Fr. 5.0

DAM
Age 4
Wt 915
Prog.BW 54
WR 103
YR 106
Wean Pct. 57%
Cow Eff. 120

RAAA HerdBuilder index: 186 (Top 23% of RA breed)
RAAA GridMaster index: 48 (Top 46% of RA breed)
Sire Beef Tenderness: 10 'Outstanding'
Calv.Ease BW WW YW Milk HPG Stay Maint.En.
EPDs 18 -4.7 54 92 28 13 17 -4.0
Marb +.31 REA +.02 Bfat +.04

★★★★★ for Low Maintenance, Marbling, Superior Cow, Calving Ease, Stayability.

★★★★★ for Low Maintenance, Growth, Marbling, Superior Cow, High Cow Efficiency, Calving Ease, Stayability.

94 BECKTON ACCENT G603 L4
1-A 100% # 4170822 Tat.: BKT9 G603



Birth: 4-7-19

Beckton Accent W180 C2
BECKTON ACCENT B740 W3
Ref. A-5

Beckton Lana Y033 W

Beckton Cody K1 P014
Beckton Christy R046 CQ
Beckton Warrior W534 N4
Beckton Lana W370 E
Beckton Likable S633
Beckton Kit S478 LN
Beckton Nebula T398 V3
Beckton Lana T348 NB

BWt 66
WR 112
YWt. 1113
YR 111
Feb.ADG 3.66
Feb.Scr. 36
Fr. 5.5

Beckton Likable U130 L2
BECKTON LANA D429 L
Beckton Lana Y726 N

DAM
Age 3
Wt 875
Prog.BW 65
WR 107
YR 109
Wean Pct. 60%
Cow Eff. 127

RAAA HerdBuilder index: 216 (Top 2% of RA breed)
RAAA GridMaster index: 50 (Top 10% of RA breed)
Sire Beef Tenderness: 9 'Outstanding'
Calv.Ease BW WW YW Milk HPG Stay Maint.En.
EPDs 17 -4.2 65 106 24 12 19 -4.0
Marb +.38 REA +.35 Bfat +.04

★★★★★ for Low Maintenance, Growth, Marbling, Rib-eye area, Superior Cow, High Cow Efficiency, Calving Ease, Stayability.

97 BECKTON EPIC G666 C8
1-A 100% # 4170546 Tat.: BKT9 G666



Birth: 4-14-19

Beckton Epic Z674 E6
BECKTON EPIC D275 L7
Ref. E-3

Beckton Lana X839 L

Beckton Epic U749 D5
Beckton Indigo U504 EP
Beckton Legend S670
Beckton Lana S371 DM
Beckton Clifftop W577 E3
Beckton Tamara R175 CQ
Beckton Clifftop W577 E3
Beckton Emera P378 LN

BWt 73
WR 106
YWt. 1106
YR 107
Feb.ADG 3.82
Feb.Scr. 36
Fr. 5.5

Beckton Clifftop Z824 C4
BECKTON EMERA B174 C
Beckton Emera Z775 C

DAM
Age 5
Wt 1005
Prog.BW 71
WR 92
YR 107
Wean Pct. 57%
Cow Eff. 121

RAAA HerdBuilder index: 203 (Top 7% of RA breed)
RAAA GridMaster index: 49 (Top 20% of RA breed)
Sire Beef Tenderness: 7 'Very Good'
Calv.Ease BW WW YW Milk HPG Stay Maint.En.
EPDs 17 -3.4 54 91 20 13.5 18 -5.0
Marb +.43 REA -.09 Bfat +.04

★★★★★ for Low Maintenance, Growth, Marbling, High Cow Efficiency, Calving Ease, Stayability.

95 BECKTON NEBULA G529 A4
1-A 100% # 4170794 Tat.: BKT9 G529



Birth: 4-1-19

Beckton Nebula P P707
BECKTON NEBULA B557 J3
Ref. N-4

Beckton Larkaba T813 JC

Beckton Nebula M045
Beckton Lana M809 EP
Beckton Justice CH M056
Beckton Larkaba P645 JL
Beckton Cody K1 P014
Beckton Susan R022 CQ
Beckton Nebula U206 V3
Beckton Minerva U205 NB

BWt 70
WR 105
YWt. 1082
YR 108
Feb.ADG 3.60
Feb.Scr. 35
Fr. 5.5

Beckton Accent U777 C2
BECKTON MINERVA D123 A
Beckton Minerva X047 N

DAM
Age 3
Wt 1210
Prog.BW 63
WR 109
YR 110
Wean Pct. 41%
Cow Eff. 86

RAAA HerdBuilder index: 202 (Top 8% of RA breed)
RAAA GridMaster index: 50 (Top 13% of RA breed)
Sire Beef Tenderness: 6 'Average'
Calv.Ease BW WW YW Milk HPG Stay Maint.En.
EPDs 14 -3.1 60 104 29 12 19 -4.0
Marb +.51 REA +.03 Bfat +.04

★★★★★ for Low Maintenance, Growth, Marbling, Superior Cow, Calving Ease, Stayability.



Lot 95

• Bulls •

98 BECKTON EPIC G311 N8 1-A 100% # 4170550 Tat.: BKT9 G311 

Birth: 3-21-19

Beckton Epic Z674 E6
BECKTON EPIC D275 L7
 Ref. E-3
 Beckton Lana X839 L

Beckton Epic U749 D5
 Beckton Indigo U504 EP
 Beckton Legend S670
 Beckton Lana S371 DM
 Beckton Nebula X353 E3
 Beckton Mona X817 H
 Beckton Julian U699 L5
 Beckton Ruth U557 JT

BWt 69
 WR 89
 YWt. 1022
 YR 99
 Feb.ADG 3.66
 Feb.Scr. 35
 Fr. 5.0

Beckton Nebula Z180 H4
BECKTON RUTH B078 N
 Beckton Ruth Z858 J

DAM
 Age 5
 Wt 1035
 Prog.BW 60
 WR 90
 YR 92
 Wean Pct. 47%
 Cow Eff. 98

RAAA HerdBuilder index: 197 (Top 11% of RA breed)
 RAAA GridMaster index: 49 (Top 28% of RA breed)
 Sire Beef Tenderness: 7 'Very Good'
 Calv.Ease BW WW YW Milk HPG Stay Maint.En.
 EPDs 19 -5.3 52 84 23 14 17 -5.0
 Marb +.40 REA -.09 Bfat +.04

★★★★★ for Low Maintenance, Marbling, Calving Ease, Stayability.

100 BECKTON LIKABLE G424 J6 1-A 100% # 4170470 Tat.: BKT9 G424 

Birth: 3-27-19

Beckton Likable Z057 L4
BECKTON LIKABLE B032 C5
 Ref. L-2
 Beckton Mona Z270 C

Beckton Likable X445 J3
 Beckton Minola X107 L
 Beckton Clifftop W577 E3
 Beckton Mona U584 CD
 Beckton Julian G5 S107
 Beckton Suffeina P643 JL
 BKT Clifftop TP R288
 Beckton Larkaba R809 NB

BWt 58
 WR 98
 YWt. 1011
 YR 103
 Feb.ADG 3.60
 Feb.Scr. 36
 Fr. 5.0

Beckton Julian X465 J5
BECKTON LARKABA B724 J
 Beckton Larkaba U475 CT

DAM
 Age 5
 Wt 945
 Prog.BW 61
 WR 93
 YR 98
 Wean Pct. 53%
 Cow Eff. 111

RAAA HerdBuilder index: 206 (Top 5% of RA breed)
 RAAA GridMaster index: 50 (Top 8% of RA breed)
 Sire Beef Tenderness: 7 'Very Good'
 Calv.Ease BW WW YW Milk HPG Stay Maint.En.
 EPDs 20 -7.0 49 92 24 14 17 -8.0
 Marb +.52 REA -.09 Bfat +.04

★★★★★ for Low Maintenance, Marbling, Calving Ease, Stayability.



Lot 97

101 BECKTON LIKABLE G544 C6 1-A 100% # 4170192 Tat.: BKT9 G544 

Birth: 4-2-19

Beckton Likable Z057 L4
BECKTON LIKABLE B032 C5
 Ref. L-2
 Beckton Mona Z270 C

Beckton Likable X445 J3
 Beckton Minola X107 L
 Beckton Clifftop W577 E3
 Beckton Mona U584 CD
 Beckton Clifftop T C075
 Beckton Christy K209 CO
 Beckton Lancer T9 N586
 Beckton Rose L083 LN

BWt 61
 WR 107
 YWt. 1034
 YR 106
 Feb.ADG 3.76
 Feb.Scr. 33
 Fr. 5.0

BKT Clifftop TP R288
BECKTON ROSE W816 C
 Beckton Rose S487 LN

DAM
 Age 10
 Wt 1130
 Prog.BW 71
 WR 100
 YR 108
 Wean Pct. 48%
 Cow Eff. 101

RAAA HerdBuilder index: 201 (Top 8% of RA breed)
 RAAA GridMaster index: 50 (Top 11% of RA breed)
 Sire Beef Tenderness: 7 'Very Good'
 Calv.Ease BW WW YW Milk HPG Stay Maint.En.
 EPDs 18 -5.1 51 94 27 12 17 -7.0
 Marb +.44 REA +.05 Bfat +.04

★★★★★ for Low Maintenance, Growth, Marbling, Calving Ease, Stayability.

99 BECKTON DOMINOR G650 E8 1-A 100% # 4170584 Tat.: BKT9 G650 

Birth: 4-13-19

Beckton Dominor Y005 V6
BECKTON DOMINOR A378 W7
 Ref. D-1
 Beckton Lana Y541 W

Beckton Dominor W640 C5
 Beckton Belga W108 V
 Beckton Warrior T248 L5
 Beckton Lana S074 EP
 Beckton Epic T330 L5
 Beckton Kit R503 LN
 Beckton Epic K6 S569
 Beckton Tamara T201 CT

BWt 69
 WR 99
 YWt. 1071
 YR 103
 Feb.ADG 3.66
 Feb.Scr. 33
 Fr. 5.5

Beckton Epic X330 L6
BECKTON TAMARA C360 E
 Beckton Tamara X628 E

DAM
 Age 4
 Wt 1120
 Prog.BW 68
 WR 108
 YR 108
 Wean Pct. 46%
 Cow Eff. 97

RAAA HerdBuilder index: 169 (Top 52% of RA breed)
 RAAA GridMaster index: 50 (Top 13% of RA breed)
 Sire Beef Tenderness: 9 'Outstanding'
 Calv.Ease BW WW YW Milk HPG Stay Maint.En.
 EPDs 17 -3.0 52 90 27 11 14 -4.0
 Marb +.46 REA +.03 Bfat +.05

★★★★★ for Low Maintenance, Marbling, Superior Cow, Calving Ease, Stayability.



Lot 101

• Bulls •

102 BECKTON ACCENT G679 L3
1-A 100% # 4171350 Tat.: BSF9 G679



Birth: 4-16-19

Beckton Accent U777 C2
Beckton Cody K1 P014
Beckton Susan R022 CQ
Beckton Legend S670
Beckton Lana S371 DM
Beckton Likable S633
Beckton Lana S157 JT
Beckton Nebula L P093
Beckton Encino H115 HD

BECKTON ACCENT B553 L2
Ref. A-3
Beckton Lana X839 L

BECKTON ENCINO Z278 L
Beckton Likable U091 J2
Beckton Encino U181 NB

BWt	78
WR	107
YWt.	952
YR	92
Feb.ADG	2.42
Feb.Scr.	34
Fr.	5.5

DAM
Age 7
Wt 1250
Prog.BW 68
WR 103
YR 104
Wean Pct. 46%
Cow Eff. 98

RAAA HerdBuilder index: **208** (Top 5% of RA breed)
RAAA GridMaster index: **47** (Top 65% of RA breed)
Sire Beef Tenderness: **10** 'Outstanding'
Calv.Ease BW WW YW Milk HPG Stay Maint.En.
EPDs **15 -2.1 49 75 26 14 20 -4.0**
Marb **+0.43** REA **-0.10** Bfat **+0.03**

105 BECKTON LIKABLE G468 L6
1-A 100% # 4171270 Tat.: BSF9 G468



Birth: 3-29-19

Beckton Likable Z057 L4
Beckton Minola X107 L
Beckton Loki X833 H4
Beckton Lana X157 L
Beckton Lancer F442 T
Beckton Kit F468 JL
Beckton Legend S670
Beckton Nebula E P084
Beckton Lana T148 NB
Beckton Lana M078 LN

BECKTON LIKABLE B274 L5
Ref. L-3
Beckton Lana Z216 L

BECKTON LANA X556 L
Beckton Lana T148 NB

BWt	70
WR	101
YWt.	1058
YR	102
Feb.ADG	3.70
Feb.Scr.	37
Fr.	5.0

DAM
Age 9
Wt 1035
Prog.BW 64
WR 99
YR 98
Wean Pct. 53%
Cow Eff. 112

RAAA HerdBuilder index: **193** (Top 14% of RA breed)
RAAA GridMaster index: **48** (Top 33% of RA breed)
Sire Beef Tenderness: **10** 'Outstanding'
Calv.Ease BW WW YW Milk HPG Stay Maint.En.
EPDs **17 -4.6 50 79 22 11 17 -9.0**
Marb **+0.43** REA **-0.02** Bfat **+0.03**

★★★★★ for Low Maintenance, Marbling, Calving Ease, Stayability.

★★★★★ for Low Maintenance, Marbling, Calving Ease, Stayability.

103 BECKTON LIKABLE G470 L6
1-A 100% # 4170644 Tat.: BKT9 G470



Birth: 3-29-19

Beckton Likable Z057 L4
Beckton Minola X107 L
Beckton Loki X833 H4
Beckton Lana X157 L
Mushrush Lunesta MD Y097
Mushrush Candice JL X212
Beckton Likable Y124 L3
Beckton Sierra Y188 N

BECKTON LIKABLE B274 L5
Ref. L-3
Beckton Lana Z216 L

BECKTON SIERRA C324 L
Mushrush Lunesta A007
Beckton Sierra A245 L

BWt	64
WR	114
YWt.	1103
YR	113
Feb.ADG	3.80
Feb.Scr.	36
Fr.	5.0

DAM
Age 4
Wt 1060
Prog.BW 60
WR 106
YR 105
Wean Pct. 53%
Cow Eff. 111

RAAA HerdBuilder index: **197** (Top 11% of RA breed)
RAAA GridMaster index: **49** (Top 15% of RA breed)
Sire Beef Tenderness: **10** 'Outstanding'
Calv.Ease BW WW YW Milk HPG Stay Maint.En.
EPDs **16 -4.3 61 102 25 12 18 -4.0**
Marb **+0.50** REA **+0.03** Bfat **+0.04**



Lot 105

★★★★★ for Low Maintenance, Growth, Marbling, Superior Cow, Calving Ease, Stayability.

104 BECKTON EPIC G337 N7
100% # not reg. Tat.: BKT9 G337



Birth: 3-22-19

Beckton Epic X464 L5
Beckton Epic K6 S569
Beckton Lana M393 LN
Beckton Julian W743 H5
Beckton Minerva W081 N
Beckton Nebula U206 V3
Beckton Tamara U185 NB
Beckton Neptune R2 K065
Bkt Larkeisa G448 CT

BECKTON EPIC B310 J6
Ref. E-2
Beckton Minerva Y116 J

BECKTON LARKEISA B168 N
Beckton Nebula X096 N4
Beckton Larkeisa P136 NP

BWt	61
WR	107
YWt.	1054
YR	108
Feb.ADG	3.37
Feb.Scr.	37
Fr.	5.0

DAM
Age 5
Wt 1280
Prog.BW 70
WR 106
YR 108
Wean Pct. 42%
Cow Eff. 89

RAAA HerdBuilder index: **NA** (Top 20% of RA breed)
RAAA GridMaster index: **0** (Top 48% of RA breed)
Sire Beef Tenderness: **10** 'Outstanding'
Calv.Ease BW WW YW Milk HPG Stay Maint.En.
EPDs **12.5 -0.9 59.5 95 25 12.5 16.5 -1.2**
Marb **+0.38** REA **+0.01** Bfat **+0.02**

★★★★★ for Low Maintenance, Growth, Marbling, Superior Cow, Calving Ease, Stayability.

106 BECKTON NEBULA G519 L5
1-A 100% # 4170564 Tat.: BKT9 G519



Birth: 3-31-19

Beckton Nebula U206 V3
Beckton Nebula P P707
Beckton Minerva J615 VG
Beckton Nebula P P707
Beckton Tamara P813 CH
Beckton Likable U120 L2
Beckton Lana N869 LO
Beckton Clifftop Y012 C4
Beckton Maiata Y266 J

BECKTON NEBULA X096 N4
Ref. N
Beckton Tamara U185 NB

BECKTON MAIATA C031 L
Beckton Likable A306 L3
Beckton Maiata A091 C

BWt	78
WR	113
YWt.	1090
YR	105
Feb.ADG	2.99
Feb.Scr.	36
Fr.	5.5

DAM
Age 4
Wt 1160
Prog.BW 78
WR 106
YR 105
Wean Pct. 51%
Cow Eff. 108

RAAA HerdBuilder index: **187** (Top 22% of RA breed)
RAAA GridMaster index: **47** (Top 53% of RA breed)
Sire Beef Tenderness: **7** 'Very Good'
Calv.Ease BW WW YW Milk HPG Stay Maint.En.
EPDs **13 -2.0 61 96 28 10 19 1.0**
Marb **+0.42** REA **-0.15** Bfat **+0.04**

★★★★★ for Low Maintenance, Growth, Marbling, Superior Cow, Calving Ease, Stayability.

• Bulls •

107 BECKTON CLIFFTOP G510 A6

1-A 100% # 4170502 Tat.: BKT9 G510

Birth: 3-30-19

Beckton Clifftop Z824 C4
BECKTON CLIFFTOP B079 C5
 Ref. C-2
 Beckton Christy W2679 C

Beckton Clifftop W577 E3
 Beckton Tamara R175 CQ
 Beckton Clifftop W577 E3
 Beckton Christy W280 J
 Beckton Accent U777 C2
 BKT Larkeisa S055 NB
 Beckton Julian U742 W5
 Beckton Susan U201 VA

Beckton Accent Y312 N3
BECKTON SUSAN B593 A
 Beckton Susan X145 J

DAM
 Age 5
 Wt 1085
 Prog.BW 68
 WR 113
 YR 110
 Wean Pct. 54%
 Cow Eff. 114

RAAA HerdBuilder index: **148** (Top 82% of RA breed)
 RAAA GridMaster index: **46** (Top 80% of RA breed)
 Sire Beef Tenderness: **10** 'Outstanding'
 Calv.Ease BW WW YW Milk HPG Stay Maint.En.
 EPDs **16 -4.0 47 72 26 14 14 -5.0**

Marb **+0.47** REA **-0.09** Bfat **+0.05**

BWt 64
 WR 117
 YWt. **1053**
 YR **108**
 Feb.ADG **2.83**
 Feb.Scr. **36**
 Fr. **5.5**



110 BECKTON ACCENT G107 C4

1-A 100% # 4170888 Tat.: BKT9 G107

Birth: 3-8-19

Beckton Accent W180 C2
BECKTON ACCENT E172 L3
 Ref. A-6
 Beckton Indigo Y406 L

Beckton Cody K1 P014
 Beckton Christy R046 CQ
 Beckton Likable U130 L2
 Beckton Indigo R745 WR
 TR Ricardo DOS
 Beckton Lana U182 JC
 Beckton Jet L P491
 BKT Pine Marie R056 CQ

TR Double Eagle ZT220
BECKTON PINE MARIE E206 D
 BKT Pine Marie W404 J

DAM
 Age 2
 Wt 885
 Prog.BW 59
 WR 115
 YR 116
 Wean Pct. 51%
 Cow Eff. 108

RAAA HerdBuilder index: **236** (Top 1% of RA breed)
 RAAA GridMaster index: **50** (Top 12% of RA breed)
 Sire Beef Tenderness: **9** 'Outstanding'
 Calv.Ease BW WW YW Milk HPG Stay Maint.En.
 EPDs **19 -3.7 63 104 24 11 20 -5.0**

Marb **+0.28** REA **+0.34** Bfat **+0.04**

BWt 59
 WR **115**
 YWt. **1055**
 YR **116**
 Feb.ADG **3.82**
 Feb.Scr. **35**
 Fr. **5.0**



★★★★★ for Low Maintenance, Growth, Marbling, Superior Cow, Calving Ease, Stayability.

★★★★★ for Low Maintenance, Growth, Marbling, Rib-eye area, Superior Cow, Calving Ease, Stayability.

108 BECKTON EPIC G483 J8

1-A 100% # 4170836 Tat.: BKT9 G483

Birth: 3-30-19

Beckton Epic Z674 E6
BECKTON EPIC E670 E7
 Ref. E-5
 Beckton Christy Z958 E

Beckton Epic U749 D5
 Beckton Indigo U504 EP
 Beckton Epic U749 D5
 Beckton Christy W831 A
 Beckton Julian G5 S107
 Beckton Suffeina P643 JL
 Beckton Accent U777 C2
 Beckton Coca P602 JL

Beckton Julian X465 J5
BECKTON COCA D537 J
 Beckton Coca Z356 A

DAM
 Age 3
 Wt 950
 Prog.BW 61
 WR 120
 YR 106
 Wean Pct. 57%
 Cow Eff. 121

RAAA HerdBuilder index: **161** (Top 66% of RA breed)
 RAAA GridMaster index: **48** (Top 32% of RA breed)
 Sire Beef Tenderness: **8** 'Very Good'
 Calv.Ease BW WW YW Milk HPG Stay Maint.En.
 EPDs **18 -4.0 61 100 26 11 13 -2.0**

Marb **+0.43** REA **-0.02** Bfat **+0.05**

BWt 62
 WR **120**
 YWt. **1017**
 YR **106**
 Feb.ADG **2.72**
 Feb.Scr. **31**
 Fr. **5.5**



Lot 110

★★★★★ for Low Maintenance, Growth, Marbling, Superior Cow, High Cow Efficiency, Calving Ease, Stayability.

109 BECKTON WARRIOR G630 D7

1-A 100% # 4170438 Tat.: BKT9 G630

Birth: 4-10-19

Beckton Warrior Y108 E5
BECKTON WARRIOR D359 L6
 Ref. W-1
 Beckton Lana W463 L

Beckton Warrior W534 N4
 Beckton Susan W058 E
 Beckton Loki CL S284
 Beckton Lana R327 EP
 Beckton Dominor W640 C5
 Beckton Belga W108 V
 Beckton Emcoe W271 L2
 Beckton Serena W366 E

Beckton Dominor Y005 V6
BECKTON SERENA A269 D
 Beckton Serena Y044 E

DAM
 Age 6
 Wt 1040
 Prog.BW 64
 WR 103
 YR 103
 Wean Pct. 56%
 Cow Eff. 117

RAAA HerdBuilder index: **168** (Top 54% of RA breed)
 RAAA GridMaster index: **46** (Top 82% of RA breed)
 Sire Beef Tenderness: **9** 'Outstanding'
 Calv.Ease BW WW YW Milk HPG Stay Maint.En.
 EPDs **19 -5.1 51 81 28 10 15 -7.0**

Marb **+0.29** REA **-0.12** Bfat **+0.04**

BWt 68
 WR **107**
 YWt. **1049**
 YR **101**
 Feb.ADG **3.37**
 Feb.Scr. **37**
 Fr. **5.5**



111 BECKTON SCAMP G660 N6

1-A 100% # 4170802 Tat.: BKT9 G660

Birth: 4-13-19

Beckton Scamp A627 J4
BECKTON SCAMP D325 N5
 Ref. S-1
 Beckton Tamara Y039 N

Beckton Scamp X494 E3
 Beckton Serena R023 JC
 Beckton Nebula W065 C3
 Beckton Tamara W232 J
 Beckton Nebula L P093
 Beckton Belga R716 DM
 Beckton Epic K6 S569
 Beckton Tamara T201 CT

Beckton Nebula W486 D3
BECKTON TAMARA D428 N
 Beckton Tamara X628 E

DAM
 Age 3
 Wt 835
 Prog.BW 66
 WR 119
 YR 110
 Wean Pct. 66%
 Cow Eff. 140

RAAA HerdBuilder index: **182** (Top 30% of RA breed)
 RAAA GridMaster index: **49** (Top 22% of RA breed)
 Sire Beef Tenderness: **10** 'Outstanding'
 Calv.Ease BW WW YW Milk HPG Stay Maint.En.
 EPDs **17 -3.2 58 98 27 13.5 15 -3.0**

Marb **+0.23** REA **+0.03** Bfat **+0.03**

BWt 72
 WR **122**
 YWt. **1124**
 YR **117**
 Feb.ADG **3.28**
 Feb.Scr. **36**
 Fr. **5.5**



★★★★★ for Low Maintenance, Marbling, High Cow Efficiency, Calving Ease, Stayability.

★★★★★ for Low Maintenance, Growth, Marbling, Superior Cow, High Cow Efficiency, Calving Ease, Stayability.

• Bulls •

112 BECKTON CARDINAL G056 C2

1-A 100% # 4170876 Tat.: BKT9 G056

Birth: 2-26-19

TR Double Eagle ZT220
BECKTON CARDINAL E673 L
 Ref. C-6
 Beckton Larkaba A911 L

TR Ricardo DOS
 Beckton Lana U182 JC
 Beckton Legend U331 E2
 Beckton Larkaba T418 WA

TR Double Eagle ZT220
BECKTON LARKABA E267 D
 Beckton Larkaba U498 EP

TR Ricardo DOS
 Beckton Lana U182 JC
 Beckton Epic R350 K
 Beckton Larkaba R336 CK

BWt	65
WR	107
YWt	1016
YR	111
Feb.ADG	3.50
Feb.Scr.	33
Fr.	5.0

Age	2
Wt	890
Prog.BW	65
WR	107
YR	111
Wean Pct.	47%
Cow Eff.	98

RAAA HerdBuilder index: **205** (Top 6% of RA breed)
 RAAA GridMaster index: **50** (Top 7% of RA breed)
 Sire Beef Tenderness: **6** 'Average'
 Calv.Ease BW WW YW Milk HPG Stay Maint.En.
 EPDs **19 -3.1 65 109 22 10 16 -3.0**

Marb **+0.37** REA **+0.17** Bfat **+0.04**

115 BECKTON EPIC G156 E8

1-A 100% # 4170348 Tat.: BKT9 G156

Birth: 3-11-19

Beckton Epic Z674 E6
BECKTON EPIC D275 L7
 Ref. E-3
 Beckton Lana X839 L

Beckton Epic U749 D5
 Beckton Indigo U504 EP
 Beckton Legend S670
 Beckton Lana S371 DM
 Beckton Epic T330 L5
 Beckton Kit R503 LN

Beckton Epic X330 L6
BECKTON LARKEISA Z556 E
 Beckton Larkeisa X091 L

Beckton Legend U331 E2
 BKT Larkeisa U066 LO

BWt	61
WR	87
YWt	982
YR	100
Feb.ADG	3.71
Feb.Scr.	34
Fr.	5.0

Age	7
Wt	1025
Prog.BW	63
WR	103
YR	106
Wean Pct.	43%
Cow Eff.	90

RAAA HerdBuilder index: **173** (Top 46% of RA breed)
 RAAA GridMaster index: **50** (Top 10% of RA breed)
 Sire Beef Tenderness: **7** 'Very Good'
 Calv.Ease BW WW YW Milk HPG Stay Maint.En.
 EPDs **18 -5.2 51 90 24 9 14 -3.0**

Marb **+0.39** REA **+0.03** Bfat **+0.04**

★★★★★ for Low Maintenance, Growth, Marbling, Rib-eye area, Superior Cow, Calving Ease, Stayability.

★★★★★ for Low Maintenance, Marbling, Calving Ease, Stayability.

113 WCRA JULIAN G149

1-A 100% #4149806 Tat.: WCRA9 GC14

Birth: 4-12-19

Beckton Julian X465 J5
BECKTON JULIAN A434 N6
 Ref. J-4
 Beckton Lakme T689 NX

Beckton Julian G5 S107
 Beckton Suffeina P643 JL
 Beckton Nexus L016
 Beckton Lakme M669 EP
 Beckton Warrior N645 T1

Beckton Warrior U636 J5
BKT PINE MARIE Z513 W
 BKT Pine Marie N582 WR

Beckton Lydia H159 JL
 Beckton Warrior TD L493
 BKT Pine Marie L650 EP

BWt	79
WR	109
YWt	1010
YR	113
Feb.ADG	3.55
Feb.Scr.	37
Fr.	5.5

Age	7
Wt	1170
Prog.BW	78
WR	107
YR	114
Wean Pct.	46%
Cow Eff.	NA

RAAA HerdBuilder index: **152** (Top 78% of RA breed)
 RAAA GridMaster index: **50** (Top 9% of RA breed)
 Sire Beef Tenderness: **7** 'Very Good'
 Calv.Ease BW WW YW Milk HPG Stay Maint.En.
 EPDs **11 -1.4 64 106 21 6.5 13 -4.0**

Marb **+0.38** REA **+0.09** Bfat **+0.02**

116 BECKTON NEBULA G535 A4

1-A 100% # 4171556 Tat.: BSF9 G535

Birth: 4-2-19

Beckton Nebula P P707
BECKTON NEBULA B557 J3
 Ref. N-4
 Beckton Larkaba T813 JC

Beckton Nebula M045
 Beckton Lana M809 EP
 Beckton Justice CH M056
 Beckton Larkaba P645 JL
 Beckton Accent U777 C2

Beckton Accent A485 C3
BECKTON MINOLA C198 A
 Beckton Minola A330 S

Beckton Tamara R175 CQ
 Beckton Scamp X494 E3
 Beckton Minola P611 JL

BWt	61
WR	104
YWt	1018
YR	104
Feb.ADG	3.23
Feb.Scr.	41
Fr.	5.5

Age	4
Wt	895
Prog.BW	61
WR	115
YR	112
Wean Pct.	56%
Cow Eff.	118

RAAA HerdBuilder index: **202** (Top 7% of RA breed)
 RAAA GridMaster index: **48** (Top 32% of RA breed)
 Sire Beef Tenderness: **6** 'Average'
 Calv.Ease BW WW YW Milk HPG Stay Maint.En.
 EPDs **19 -6.2 49 84 30 12 18 -9.0**

Marb **+0.45** REA **+0.01** Bfat **+0.04**

★★★★★ for Low Maintenance, Growth, Marbling, Superior Cow, Calving Ease, Stayability.

★★★★★ for Low Maintenance, Marbling, Superior Cow, High Cow Efficiency, Calving Ease, Stayability.

114 BECKTON HUGHES G610 L4

1-A 100% # 4171470 Tat.: BSF9 G610

Birth: 4-7-19

Bieber H Hughes W109
BECKTON HUGHES C350 N2
 Ref. B-1
 Beckton Kit Z049 N

Basin Hobo 0545
 Basin Rose 06T0
 Beckton Nebula X353 E3
 Beckton Kit X236 L
 Beckton Nebula X096 N4
 Beckton Minola X670 N

Beckton Nebula Z111 N5
BECKTON BELGA B004 N
 Beckton Belga Z031 N

Beckton Nebula X096 N4
 Beckton Belga X736 E

BWt	53
WR	93
YWt	999
YR	96
Feb.ADG	3.23
Feb.Scr.	34
Fr.	5.0

Age	5
Wt	1090
Prog.BW	54
WR	99
YR	99
Wean Pct.	47%
Cow Eff.	98

RAAA HerdBuilder index: **189** (Top 19% of RA breed)
 RAAA GridMaster index: **45** (Top 92% of RA breed)
 Sire Beef Tenderness: **9** 'Outstanding'
 Calv.Ease BW WW YW Milk HPG Stay Maint.En.
 EPDs **20 -6.6 48 76 28 12 17 1.0**

Marb **+0.37** REA **-0.22** Bfat **+0.04**



Lot 114

★★★★★ for Low Maintenance, Marbling, Calving Ease, Stayability.

• Bulls •

117 BECKTON EPIC G295 N7

1-A 100% # 4170292 Tat.: BKT9 G295

Birth: 3-20-19

Beckton Epic U749 D5
BECKTON EPIC Z674 E6
 Ref. E-1 Beckton Indigo U504 EP

Beckton Epic K4 N795
 Beckton Denise R308 DM
 Beckton Epic K6 S569
 Beckton Indigo S016 NB
 Beckton Nebula PJ S543
 Beckton Lana S197 JT
 Beckton Loki CL S284
 Beckton Ruth P591 LN

BWt 59
 WR 95
 YWt. 989
 YR 101
 Feb.ADG 3.50
 Feb.Scr. 35
 Fr. 5.0

Beckton Nebula W778 J4
BECKTON RUTH Y047 N
 Beckton Ruth W246 L

DAM
 Age 8
 Wt 1145
 Prog.BW 63
 WR 94
 YR 92
 Wean Pct. 42%
 Cow Eff. 88

RAAA HerdBuilder index: 174 (Top 43% of RA breed)
 RAAA GridMaster index: 48 (Top 48% of RA breed)
 Sire Beef Tenderness: 10 'Outstanding'
 Calv.Ease BW WW YW Milk HPG Stay Maint.En.
 EPDs 20 -5.8 52 86 23 8 15 -1.0
 Marb +.40 REA -.18 Bfat +.04

120 BECKTON RANGER G599 A6

1-A 100% # 4171416 Tat.: BSF9 G599

Birth: 4-7-19

Beckton Ranger Z225 J4
BECKTON RANGER B006 D5
 Ref. R-1 Beckton Suffeina Z731 D

Beckton Ranger T603 H3
 Beckton Mona U564 JT
 Beckton Dominor W640 C5
 Beckton Suffeina W471 W
 Beckton Cody K1 P014
 Beckton Susan R022 CQ
 Beckton Dominor ZC M919
 BKT Suffeina H693 LN

BWt 66
 WR 105
 YWt. 977
 YR 100
 Feb.ADG 3.23
 Feb.Scr. 38
 Fr. 5.0

Beckton Accent U777 C2
BECKTON SUFFEINA B858 A
 BKT Suffeina R651 DM

DAM
 Age 5
 Wt 1055
 Prog.BW 78
 WR 102
 YR 98
 Wean Pct. 50%
 Cow Eff. 106

RAAA HerdBuilder index: 160 (Top 68% of RA breed)
 RAAA GridMaster index: 48 (Top 43% of RA breed)
 Sire Beef Tenderness: 7 'Very Good'
 Calv.Ease BW WW YW Milk HPG Stay Maint.En.
 EPDs 17 -3.3 54 87 24 12 14 -6.0
 Marb +.45 REA -.04 Bfat +.04

★★★★★ for Low Maintenance, Marbling, Calving Ease, Stayability.

★★★★★ for Low Maintenance, Marbling, Calving Ease, Stayability.

118 BECKTON ACCENT G244 E3

1-A 100% # 4171486 Tat.: BSF9 G244

Birth: 3-17-19

Beckton Cody K1 P014
BECKTON ACCENT W180 C2
 Ref. A-1 Beckton Christy R046 CQ

Beckton Cody KH M390
 Beckton Rose M126 WR
 Beckton Cherokee N N479
 Beckton Christy N740 HR
 Beckton Emperor T641 E2
 Beckton Lana U789 NB
 Beckton Nebula W130 D3
 Beckton Minola N751 JL

BWt 64
 WR 92
 YWt. 917
 YR 88
 Feb.ADG 2.80
 Feb.Scr. 34
 Fr. 5.0

Beckton Emperor Z750 N3
BECKTON MINOLA B063 E
 Beckton Minola Z752 N

DAM
 Age 5
 Wt 1065
 Prog.BW 58
 WR 100
 YR 100
 Wean Pct. 47%
 Cow Eff. 99

RAAA HerdBuilder index: 220 (Top 2% of RA breed)
 RAAA GridMaster index: 45 (Top 87% of RA breed)
 Sire Beef Tenderness: 9 'Outstanding'
 Calv.Ease BW WW YW Milk HPG Stay Maint.En.
 EPDs 20 -6.3 50 80 26 12 21 -3.0
 Marb +.31 REA -.14 Bfat +.04



Lot 120

★★★★★ for Low Maintenance, Marbling, Calving Ease, Stayability.

119 WCRA ACCENT G142

1-A 100% #4149830 Tat.: WCRA9 GC14

Birth: 3-20-19

Beckton Cody K1 P014
BECKTON ACCENT W180 C2
 Ref. A-1 Beckton Christy R046 CQ

Beckton Cody KH M390
 Beckton Rose M126 WR
 Beckton Cherokee N N479
 Beckton Christy N740 HR
 Beckton Julian X465 J5
 Beckton Lakme T689 NX
 Beckton Emcoe W526 J2
 Beckton Rose T406 EP

BWt 69
 WR 111
 YWt. 955
 YR 107
 Feb.ADG 3.07
 Feb.Scr. 37
 Fr. 5.5

Beckton Julian A434 N6
WCRA ROSE E119 J
 WCRA Rose E119 J

DAM
 Age 2
 Wt 976
 Prog.BW 69
 WR 111
 YR 108
 Wean Pct. 56%
 Cow Eff. NA

RAAA HerdBuilder index: 205 (Top 6% of RA breed)
 RAAA GridMaster index: 47 (Top 60% of RA breed)
 Sire Beef Tenderness: 9 'Outstanding'
 Calv.Ease BW WW YW Milk HPG Stay Maint.En.
 EPDs 16 -3.5 62 99 26 12 20 -1.0
 Marb +.27 REA -.03 Bfat +.03

121 BECKTON WARRIOR G214 L7

1-A 100% # 4171488 Tat.: BKT9 G214

Birth: 3-16-19

Beckton Warrior Y108 E5
BECKTON WARRIOR D359 L6
 Ref. W-1 Beckton Lana W463 L

Beckton Warrior W534 N4
 Beckton Susan W058 E
 Beckton Loki CL S284
 Beckton Lana R327 EP
 Beckton Likable S633
 Beckton Kit S478 LN
 Beckton Hasten U108 J3
 Beckton Coca T080 NB

BWt 84
 WR 97
 YWt. 902
 YR 92
 Feb.ADG 3.17
 Feb.Scr. 34
 Fr. 5.0

Beckton Likable U130 L2
BECKTON COCA B456 L
 Beckton Coca Y579 H

DAM
 Age 5
 Wt 940
 Prog.BW 73
 WR 102
 YR 98
 Wean Pct. 52%
 Cow Eff. 109

RAAA HerdBuilder index: 174 (Top 43% of RA breed)
 RAAA GridMaster index: 46 (Top 83% of RA breed)
 Sire Beef Tenderness: 9 'Outstanding'
 Calv.Ease BW WW YW Milk HPG Stay Maint.En.
 EPDs 16 -3.4 50 76 24 11 16 -10.0
 Marb +.31 REA -.17 Bfat +.04

★★★★★ for Low Maintenance, Growth, Marbling, Superior Cow, Calving Ease, Stayability.

★★★★★ for Low Maintenance, Marbling, Calving Ease, Stayability.

• Bulls •

122 BSF CARDINAL G602 C2 

1-B 99% # 4171854 Tat.: BSF9 G602

Birth: 4-7-19

BECKTON CARDINAL E673 L
Ref. C-6

BSF CODETTE E132 C

DAM

Age	2
Wt	745
Prog.BW	56
WR	109
YR	111
Wean Pct.	57%
Cow Eff.	120

TR Double Eagle ZT220
Beckton Larkaba A911 L

TR Ricardo DOS
Beckton Lana U182 JC
Beckton Legend U331 E2
Beckton Larkaba T418 WA
Beckton Clifftop Y012 C4
Beckton Minola X198 A
Beckton Scamp A627 J4
BSF Codette A666 D

BWt 56
WR 109
YWt. 1011
YR 111
Feb.ADG 3.50
Feb.Scr. 32
Fr. 5.0

RAAA HerdBuilder index: 195 (Top 12% of RA breed)
RAAA GridMaster index: 49 (Top 15% of RA breed)
Sire Beef Tenderness: 6 'Average'

Calv.Ease	BW	WW	YW	Milk	HPG	Stay	Maint.En.	
EPDs	21	-5.3	60	100	25	12	15	-7.0

Marb +.41 REA +.10 Bfat +.04

125 BECKTON DOMINOR G644 A9 

1-A 100% # 4171698 Tat.: BSF9 G644

Birth: 4-12-19

BECKTON DOMINOR D254 N8
Ref. D-2

BECKTON BELGA D833 A

DAM

Age	3
Wt	920
Prog.BW	66
WR	101
YR	99
Wean Pct.	45%
Cow Eff.	96

Beckton Dominor A378 W7
Beckton Indigo W772 N

Beckton Dominor Y005 V6
Beckton Lana Y541 W
Beckton Nebula T398 V3
Beckton Indigo T613 JT
Beckton Accent W180 C2
Beckton Lana W463 L
Beckton Nebula X096 N4
Beckton Belga X736 E

BWt 64
WR 90
YWt. 959
YR 96
Feb.ADG 3.28
Feb.Scr. 33
Fr. 5.5

RAAA HerdBuilder index: 225 (Top 1% of RA breed)
RAAA GridMaster index: 49 (Top 25% of RA breed)
Sire Beef Tenderness: 10 'Outstanding'

Calv.Ease	BW	WW	YW	Milk	HPG	Stay	Maint.En.	
EPDs	18	-4.6	47	83	30	13	20	-3.0

Marb +.43 REA +.04 Bfat +.05

★★★★★ for Low Maintenance, Growth, Marbling, Superior Cow, High Cow Efficiency, Calving Ease, Stayability.

★★★★★ for Low Maintenance, Marbling, Calving Ease, Stayability.

123 BECKTON EPIC G781 A7 

1-A 100% # 4171434 Tat.: BSF9 G781

Birth: 5-8-19

BECKTON EPIC B310 J6
Ref. E-2

BECKTON MINOLA B679 A

DAM

Age	5
Wt	1030
Prog.BW	65
WR	105
YR	103
Wean Pct.	51%
Cow Eff.	108

Beckton Epic X464 L5
Beckton Minerva Y116 J

Beckton Epic K6 S569
Beckton Lana M393 LN
Beckton Julian W743 H5
Beckton Minerva W081 N
Beckton Cody K1 P014
Beckton Christy R046 CQ
Beckton Dominor Z1 R610
Beckton Minola P611 JL

BWt 71
WR 105
YWt. 1002
YR 103
Feb.ADG 3.01
Feb.Scr. 35
Fr. 5.5

RAAA HerdBuilder index: 214 (Top 3% of RA breed)
RAAA GridMaster index: 47 (Top 69% of RA breed)
Sire Beef Tenderness: 10 'Outstanding'

Calv.Ease	BW	WW	YW	Milk	HPG	Stay	Maint.En.	
EPDs	18	-4.0	58	88	26	13	20	-2.0

Marb +.31 REA +.00 Bfat +.03

★★★★★ for Low Maintenance, Marbling, Calving Ease, Stayability.

126 BECKTON ACCENT G656 C3 

1-A 100% # 4171512 Tat.: BSF9 G656

Birth: 4-13-19

BECKTON ACCENT B553 L2
Ref. A-3

BECKTON LANA C551 C

DAM

Age	4
Wt	950
Prog.BW	60
WR	100
YR	102
Wean Pct.	46%
Cow Eff.	96

Beckton Accent U777 C2
Beckton Lana X839 L

Beckton Cody K1 P014
Beckton Susan R022 CQ
Beckton Legend S670
Beckton Lana S371 DM
Beckton Clifftop W692 E3
Beckton Lana W240 C
Beckton Cherokee T450 L3
Beckton Lana T674 JL

BWt 47
WR 84
YWt. 947
YR 91
Feb.ADG 3.23
Feb.Scr. 32
Fr. 5.0

RAAA HerdBuilder index: 188 (Top 21% of RA breed)
RAAA GridMaster index: 46 (Top 71% of RA breed)
Sire Beef Tenderness: 10 'Outstanding'

Calv.Ease	BW	WW	YW	Milk	HPG	Stay	Maint.En.	
EPDs	21	-6.3	43	74	29	11	16	-8.0

Marb +.30 REA -.24 Bfat +.05

★★★★★ for Low Maintenance, Marbling, Calving Ease, Stayability.

124 BSF ACCENT G752 W4 

1-B 99% # 4171584 Tat.: BSF9 G752

Birth: 4-30-19

BECKTON ACCENT B549 N3
Ref. A-2

BSF OLIVE D523 W

DAM

Age	3
Wt	985
Prog.BW	68
WR	103
YR	99
Wean Pct.	51%
Cow Eff.	107

Beckton Accent W180 C2
Beckton Minerva Y654 N

Beckton Warrior Y108 E5
BSF Olive A863 C

Beckton Cody K1 P014
Beckton Christy R046 CQ
Beckton Nebula T398 V3
Beckton Minerva M369 LO
Beckton Warrior W534 N4
Beckton Susan W058 E
Beckton Clifftop Y012 C4
BSF Olive Y105 L

BWt 66
WR 106
YWt. 1028
YR 103
Feb.ADG 3.33
Feb.Scr. 33
Fr. 5.5

RAAA HerdBuilder index: 193 (Top 15% of RA breed)
RAAA GridMaster index: 48 (Top 33% of RA breed)
Sire Beef Tenderness: 9 'Outstanding'

Calv.Ease	BW	WW	YW	Milk	HPG	Stay	Maint.En.	
EPDs	17	-3.4	61	101	26	12	17	-3.0

Marb +.33 REA +.07 Bfat +.05

★★★★★ for Low Maintenance, Marbling, Calving Ease, Stayability.

127 BECKTON CARDINAL G554 D2 

1-A 100% # 4170908 Tat.: BKT9 G554

Birth: 4-3-19

BECKTON CARDINAL E673 L
Ref. C-6

BECKTON COCA E332 D

DAM

Age	2
Wt	825
Prog.BW	70
WR	109
YR	104
Wean Pct.	52%
Cow Eff.	109

TR Double Eagle ZT220
Beckton Larkaba A911 L

TR Ricardo DOS
Beckton Lana U182 JC
Beckton Legend U331 E2
Beckton Larkaba T418 WA
Beckton Dominor Y005 V6
Beckton Lana Y541 W
Beckton Nebula T398 V3
Beckton Coca T499 SC

BWt 70
WR 109
YWt. 949
YR 104
Feb.ADG 3.01
Feb.Scr. 33
Fr. 5.5

RAAA HerdBuilder index: 216 (Top 2% of RA breed)
RAAA GridMaster index: 50 (Top 13% of RA breed)
Sire Beef Tenderness: 6 'Average'

Calv.Ease	BW	WW	YW	Milk	HPG	Stay	Maint.En.	
EPDs	19	-3.0	59	97	23	13	18	-5.0

Marb +.42 REA +.17 Bfat +.04

★★★★★ for Low Maintenance, Marbling, Rib-eye area, Superior Cow, Calving Ease, Stayability.

• Bulls •

128 BSF DOMINOR G412 L8 

1-B 99% # 4171582 Tat.: BSF9 G412

Birth: 3-26-19

Beckton Dominor Y005 V6
BECKTON DOMINOR A378 W7
 Ref. D-1 Beckton Lana Y541 W

Beckton Dominor W640 C5
 Beckton Belga W108 V
 Beckton Warrior T248 L5
 Beckton Lana S074 EP
 Beckton Loki CL S284
 Beckton Vernice T447 HT
 Beckton Legend U331 E2
 BSF Julianne U532 WR

BWt 67
 WR 86
 YWt. 931
 YR 93
 Feb.ADG 3.39
 Feb.Scr. 33
 Fr. 5.5

BSF JULIANNE D575 L
 BSF Julianne A654 L

DAM
 Age 3
 Wt 940
 Prog.BW 66
 WR 97
 YR 101
 Wean Pct. 42%
 Cow Eff. 89

RAAA HerdBuilder index: 171 (Top 49% of RA breed)
 RAAA GridMaster index: 49 (Top 16% of RA breed)
 Sire Beef Tenderness: 9 'Outstanding'
 Calv.Ease BW WW YW Milk HPG Stay Maint.En.
 EPDs 18 -3.9 46 81 25 11 14 -6.0

Marb +.46 REA +.00 Bfat +.04

★★★★★ for Low Maintenance, Marbling, Calving Ease, Stayability.

131 BECKTON ACCENT G035 W5 

1-A 100% # 4170996 Tat.: BKT9 G035

Birth: 2-22-19

Beckton Accent A175 O3
BECKTON ACCENT E333 N4
 Ref. A-7 Beckton Eola U027 NB

Beckton Accent W180 C2
 Beckton Lana R214 RA
 Beckton Nebula EN S347
 Beckton Eola S317 LO
 Beckton Warrior W534 N4
 Beckton Susan W058 E
 Beckton Julian W743 H5
 Beckton Lana U025 LO

BWt 55
 WR 95
 YWt. 937
 YR 103
 Feb.ADG 3.50
 Feb.Scr. 33
 Fr. 5.5

BECKTON LANA E512 W
 Beckton Lana A401 J

DAM
 Age 2
 Wt 730
 Prog.BW 55
 WR 95
 YR 103
 Wean Pct. 50%
 Cow Eff. 104

RAAA HerdBuilder index: 166 (Top 58% of RA breed)
 RAAA GridMaster index: 48 (Top 46% of RA breed)
 Sire Beef Tenderness: 10 'Outstanding'
 Calv.Ease BW WW YW Milk HPG Stay Maint.En.
 EPDs 19 -4.2 52 89 27 14 13 -2.0

Marb +.34 REA -.27 Bfat +.05

★★★★★ for Low Maintenance, Marbling, Calving Ease, Stayability.

129 BECKTON LIKABLE G005 A5 

1-A 100% # 4170924 Tat.: BKT9 G005

Birth: 2-12-19

Beckton Likable Y124 L3
BECKTON LIKABLE E391 N4
 Ref. L-7 Beckton Lana X466 N

Beckton Likable U130 L2
 BKT Pine Marie S802 LO
 Beckton Nebula T398 V3
 Beckton Lana T226 NB
 Beckton Accent U777 C2
 Beckton Tamara R175 CQ
 Beckton Nebula T398 V3
 Beckton Belga S026 NB

BWt 54
 WR 97
 YWt. 901
 YR 103
 Feb.ADG 3.23
 Feb.Scr. 36
 Fr. 5.0

BECKTON BELGA E678 A
 Beckton Belga Y192 N

DAM
 Age 2
 Wt 675
 Prog.BW 54
 WR 97
 YR 103
 Wean Pct. 52%
 Cow Eff. 109

RAAA HerdBuilder index: 230 (Top 1% of RA breed)
 RAAA GridMaster index: 49 (Top 24% of RA breed)
 Sire Beef Tenderness: 8 'Very Good'
 Calv.Ease BW WW YW Milk HPG Stay Maint.En.
 EPDs 16 -3.8 55 92 26 14 21 -4.0

Marb +.39 REA -.10 Bfat +.05

★★★★★ for Low Maintenance, Marbling, Calving Ease, Stayability.

132 BECKTON ACCENT G530 L3 

1-A 100% # 4170732 Tat.: BKT9 G530

Birth: 4-1-19

Beckton Cody K1 P014
BECKTON ACCENT W180 C2
 Ref. A-1 Beckton Christy R046 CQ

Beckton Cody KH M390
 Beckton Rose M126 WR
 Beckton Cherokee N N479
 Beckton Christy N740 HR
 Beckton Likable Y124 L3
 Beckton Christy W429 W
 Beckton Likable Y124 L3
 Beckton Rose M126 WR

BWt 51
 WR 92
 YWt. 912
 YR 91
 Feb.ADG 3.01
 Feb.Scr. 35
 Fr. 5.0

BECKTON ROSE D050 L
 Beckton Rose B383 L

DAM
 Age 3
 Wt 875
 Prog.BW 54
 WR 94
 YR 98
 Wean Pct. 49%
 Cow Eff. 103

RAAA HerdBuilder index: 239 (Top 1% of RA breed)
 RAAA GridMaster index: 46 (Top 77% of RA breed)
 Sire Beef Tenderness: 9 'Outstanding'
 Calv.Ease BW WW YW Milk HPG Stay Maint.En.
 EPDs 22 -7.0 49 78 25 12 22 -2.0

Marb +.35 REA -.13 Bfat +.03

★★★★★ for Low Maintenance, Marbling, Calving Ease, Stayability.

130 BECKTON LANCER G447 A2 

1-A 100% # 4171172 Tat.: BKT9 G447

Birth: 3-28-19

Redhill U199 Lancer 9B
REDHILL 9B LANCER 11E
 Ref. O-1 Redhill T189 Barmaid 190W

Buf Crk The Right Kind U199
 Buf Crk Redpride P154
 Buf Crk Nice'N Easy T189
 1BWJ Barmaid 54P
 Beckton Accent Y312 N3
 Beckton Minerva Y654 N
 Beckton Scamp A626 H3
 Beckton Susan A112 S

BWt 76
 WR 106
 YWt. 925
 YR 101
 Feb.ADG 3.01
 Feb.Scr. 32
 Fr. 5.5

BECKTON SUSAN E030 A
 Beckton Susan C047 S

DAM
 Age 2
 Wt 840
 Prog.BW 76
 WR 106
 YR 101
 Wean Pct. 49%
 Cow Eff. 104

RAAA HerdBuilder index: 164 (Top 62% of RA breed)
 RAAA GridMaster index: 48 (Top 42% of RA breed)
 Sire Beef Tenderness: 7 'Very Good'
 Calv.Ease BW WW YW Milk HPG Stay Maint.En.
 EPDs 13 -0.6 63 98 24 11 14 -5.0

Marb +.43 REA -.16 Bfat +.04

★★★★★ for Low Maintenance, Marbling, Calving Ease, Stayability.

133 BECKTON CLIFFTOP G216 L6 

1-A 100% # 4170474 Tat.: BKT9 G216

Birth: 3-16-19

Beckton Clifftop Y012 C4
BECKTON CLIFFTOP C572 N5
 Ref. C-3 BKT Pine Marie U454 NB

Beckton Clifftop W692 E3
 Beckton Lana W240 C
 Beckton Nebula P P707
 BKT Pine Marie N582 WR
 Beckton Legend S670
 Beckton Lana S669 EP
 Beckton Jet L P491
 Beckton Mona P874 WR

BWt 69
 WR 71
 YWt. 869
 YR 89
 Feb.ADG 3.44
 Feb.Scr. 34
 Fr. 5.0

BECKTON MONA B713 L
 Beckton Mona U564 JT

DAM
 Age 5
 Wt 1070
 Prog.BW 60
 WR 86
 YR 94
 Wean Pct. 33%
 Cow Eff. 70

RAAA HerdBuilder index: 198 (Top 10% of RA breed)
 RAAA GridMaster index: 49 (Top 28% of RA breed)
 Sire Beef Tenderness: 7 'Very Good'
 Calv.Ease BW WW YW Milk HPG Stay Maint.En.
 EPDs 18 -5.5 39 71 27 10 18 -9.0

Marb +.51 REA -.22 Bfat +.05

★★★★★ for Low Maintenance, Marbling, Calving Ease, Stayability.

• Bulls •

134 BECKTON DOMINOR G575 E9

1-A 100% # 4170680 Tat.: BKT9 G575

Birth: 4-5-19

Beckton Dominor A378 W7
BECKTON DOMINOR D254 N8
 Ref. D-2
 Beckton Indigo W772 N

Beckton Epic Z674 E6
BECKTON TAMARA D631 E
 Beckton Tamara A008 A

Beckton Dominor Y005 V6
 Beckton Lana Y541 W
 Beckton Nebula T398 V3
 Beckton Indigo T613 JT
 Beckton Epic U749 D5
 Beckton Indigo U504 EP
 Beckton Accent Y260 L3
 Beckton Tamara Y001 A

BWt	60
WR	95
YWt.	970
YR	101
Feb.ADG	3.39
Feb.Scr.	31
Fr.	5.5

DAM
 Age 3
 Wt 1090
 Prog.BW 60
 WR 95
 YR 101
 Wean Pct. 39%
 Cow Eff. 82

RAAA HerdBuilder index: **206** (Top 6% of RA breed)
 RAAA GridMaster index: **49** (Top 29% of RA breed)
 Sire Beef Tenderness: **10** 'Outstanding'
 Calv.Ease BW WW YW Milk HPG Stay Maint.En.
 EPDs **19 -4.6 49 85 29 12 18 -4.0**

Marb **+4.2** REA **+0.3** Bfat **+0.5**

★★★★★ for Low Maintenance, Marbling, Calving Ease, Stayability.

137 BSF ACCENT G607 L4

1-B 99% # 4171254 Tat.: BSF9 G607

Birth: 4-7-19

Beckton Accent W180 C2
BECKTON ACCENT B740 W3
 Ref. A-5
 Beckton Lana Y033 W

Beckton Legend S670
BSF JULIANNE X510 L
 BSF Julianne R707 JL

Beckton Cody K1 P014
 Beckton Christy R046 CQ
 Beckton Warrior W534 N4
 Beckton Lana W370 E
 Beckton Lancer F442 T
 Beckton Kit F468 JL
 Beckton Julian G1 J526
 BSF Regus L568 LN

BWt	75
WR	98
YWt.	1027
YR	105
Feb.ADG	3.48
Feb.Scr.	37
Fr.	5.0

DAM
 Age 9
 Wt 1085
 Prog.BW 69
 WR 106
 YR 104
 Wean Pct. 46%
 Cow Eff. 96

RAAA HerdBuilder index: **213** (Top 3% of RA breed)
 RAAA GridMaster index: **50** (Top 13% of RA breed)
 Sire Beef Tenderness: **9** 'Outstanding'
 Calv.Ease BW WW YW Milk HPG Stay Maint.En.
 EPDs **19 -4.6 57 93 25 13 18 -4.0**

Marb **+4.2** REA **+1.9** Bfat **+0.3**

★★★★★ for Low Maintenance, Growth, Marbling, Rib-eye area, Superior Cow, Calving Ease, Stayability.

135 BECKTON EPIC G068 N8

1-A 100% # 4170918 Tat.: BKT9 G068

Birth: 3-1-19

Beckton Epic Z674 E6
BECKTON EPIC E488 N7
 Ref. E-4
 Beckton Sierra Z059 N

Beckton Nebula X267 J3
BECKTON COCA E850 N
 Beckton Coca X084 N

Beckton Epic U749 D5
 Beckton Indigo U504 EP
 Beckton Nebula X096 N4
 Beckton Sierra X818 C
 Beckton Nebula T269 E2
 Beckton Indigo T613 JT
 Beckton Nebula U206 V3
 Beckton Coca U510 LN

BWt	55
WR	97
YWt.	902
YR	99
Feb.ADG	2.90
Feb.Scr.	31
Fr.	5.0

DAM
 Age 2
 Wt 790
 Prog.BW 55
 WR 97
 YR 99
 Wean Pct. 47%
 Cow Eff. 100

RAAA HerdBuilder index: **194** (Top 14% of RA breed)
 RAAA GridMaster index: **49** (Top 16% of RA breed)
 Sire Beef Tenderness: **9** 'Outstanding'
 Calv.Ease BW WW YW Milk HPG Stay Maint.En.
 EPDs **16 -2.0 60 101 25 8 17 1.0**

Marb **+3.9** REA **-0.1** Bfat **+0.4**

★★★★★ for Low Maintenance, Marbling, Calving Ease, Stayability.

138 BECKTON LEGEND G420 H5

1-A 100% # 4171166 Tat.: BKT9 G420

Birth: 3-26-19

Beckton Legend Z689 J3
BECKTON LEGEND E464 L4
 Ref. L-8
 Beckton Ucola X143 L

Beckton Heritage C477 J4
BECKTON EMERA E050 H
 Beckton Emera C459 N

Beckton Legend X561 J2
 Beckton Larkaba W868 J
 Beckton Likable U120 L2
 Beckton Ucola U709 LO
 Beckton Heritage X403 L3
 Beckton Ruth Z858 J
 Beckton Nebula P P707
 Beckton Emera Y196 W

BWt	61
WR	112
YWt.	1013
YR	111
Feb.ADG	3.37
Feb.Scr.	34
Fr.	5.5

DAM
 Age 2
 Wt 785
 Prog.BW 61
 WR 112
 YR 111
 Wean Pct. 56%
 Cow Eff. 118

RAAA HerdBuilder index: **202** (Top 7% of RA breed)
 RAAA GridMaster index: **49** (Top 18% of RA breed)
 Sire Beef Tenderness: **10** 'Outstanding'
 Calv.Ease BW WW YW Milk HPG Stay Maint.En.
 EPDs **15 -1.5 65 104 22 11 18 -4.0**

Marb **+4.1** REA **+1.0** Bfat **+0.3**

★★★★★ for Low Maintenance, Growth, Marbling, Superior Cow, High Cow Efficiency, Calving Ease, Stayability.

136 BECKTON WARRIOR G545 N7

2 100% # 4170344 Tat.: BKT9 G545

Birth: 4-2-19

Beckton Warrior Y108 E5
BECKTON WARRIOR D359 L6
 Ref. W-1
 Beckton Lana W463 L

Beckton Nebula X267 J3
BECKTON LARKEISA Z345 N
 Beckton Larkeisa W671 L

Beckton Warrior W534 N4
 Beckton Susan W058 E
 Beckton Loki CL S284
 Beckton Lana R327 EP
 Beckton Nebula T269 E2
 Beckton Indigo T613 JT
 Beckton Lancer T371 H4
 BKT Larkeisa T310 JC

BWt	61
WR	83
YWt.	861
YR	88
Feb.ADG	3.01
Feb.Scr.	33
Fr.	5.0

DAM
 Age 7
 Wt 1135
 Prog.BW 62
 WR 94
 YR 96
 Wean Pct. 37%
 Cow Eff. 78

RAAA HerdBuilder index: **174** (Top 44% of RA breed)
 RAAA GridMaster index: **45** (Top 90% of RA breed)
 Sire Beef Tenderness: **9** 'Outstanding'
 Calv.Ease BW WW YW Milk HPG Stay Maint.En.
 EPDs **20 -6.7 41 66 27 13 15 -3.0**

Marb **+2.7** REA **-0.30** Bfat **+0.4**

★★★★★ for Low Maintenance, Marbling, Calving Ease, Stayability.

139 BECKTON EPIC G786 A7

1-A 100% # 4170606 Tat.: BKT9 G786

Birth: 5-9-19

Beckton Epic X464 L5
BECKTON EPIC B310 J6
 Ref. E-2
 Beckton Minerva Y116 J

Beckton Accent Y260 L3
BECKTON LANA C375 A
 Beckton Lana W157 N

Beckton Epic K6 S569
 Beckton Lana M393 LN
 Beckton Julian W743 H5
 Beckton Minerva W081 N
 Beckton Accent W180 C2
 Beckton Lana W463 L
 Beckton Nebula L P093
 Beckton Lana M809 EP

BWt	74
WR	105
YWt.	1073
YR	103
Feb.ADG	3.26
Feb.Scr.	33
Fr.	5.5

DAM
 Age 4
 Wt 1030
 Prog.BW 73
 WR 105
 YR 101
 Wean Pct. 54%
 Cow Eff. 113

RAAA HerdBuilder index: **206** (Top 6% of RA breed)
 RAAA GridMaster index: **47** (Top 57% of RA breed)
 Sire Beef Tenderness: **10** 'Outstanding'
 Calv.Ease BW WW YW Milk HPG Stay Maint.En.
 EPDs **15 -2.3 59 91 26 12 20 -1.0**

Marb **+4.1** REA **-0.2** Bfat **+0.4**

★★★★★ for Low Maintenance, Marbling, Calving Ease, Stayability.

• Bulls •

140 BECKTON LIKABLE G769 L5

1-A 100% # 4170188 Tat.: BKT9 G769

Birth: 5-6-19

Beckton Likable U130 L2
Beckton Indigo U658 JL
Beckton Likable U120 L2
Beckton Minola U188 NB
Beckton Loki C M740
Beckton Lakme J460 LT
Beckton Epic KM M115
Beckton Lana K840 LN

Beckton Likable X445 J3
Beckton Minola X107 L

Beckton Loki CL S284
Beckton Lana R327 EP

BECKTON LIKABLE Z057 L4
Ref. L-1

BECKTON LANA W463 L

DAM
Age 10
Wt 1110
Prog.BW 72
WR 112
YR 109
Wean Pct. 53%
Cow Eff. 111

RAAA HerdBuilder index: **178** (Top 37% of RA breed)
RAAA GridMaster index: **49** (Top 18% of RA breed)
Sire Beef Tenderness: **9** 'Outstanding'
Calv.Ease BW WW YW Milk HPG Stay Maint.En.
EPDs **15 -3.9 55 95 26 11 16 -7.0**

Marb **+0.49** REA **-0.15** Bfat **+0.03**

BWt 75
WR 107
YWt. 1098
YR 106
Feb.ADG 3.32
Feb.Scr. 40
Fr. 5.5



143 BSF ACCENT G693 E4

1-B 99% # 4171574 Tat.: BSF9 G693

Birth: 4-18-19

Beckton Accent U777 C2
Beckton Susan R022 CQ
BKT Clifftop TP R288
Beckton Christy S151 NB
Beckton Epic U749 D5
Beckton Tamara U185 NB
Beckton Nebula H R233
BSF Nebulann W084 N

Beckton Cody K1 P014
Beckton Christy W779 C

Beckton Epic B376 N6
BSF Nebulann A492 N

BECKTON ACCENT B653 C3
Ref. A-4

BSF NEBULANN D682 E

DAM
Age 3
Wt 875
Prog.BW 67
WR 103
YR 103
Wean Pct. 59%
Cow Eff. 125

RAAA HerdBuilder index: **171** (Top 48% of RA breed)
RAAA GridMaster index: **48** (Top 48% of RA breed)
Sire Beef Tenderness: **10** 'Outstanding'
Calv.Ease BW WW YW Milk HPG Stay Maint.En.
EPDs **15 -2.0 58 95 23 12 16 -4.0**

Marb **+0.33** REA **-0.11** Bfat **+0.04**

BWt 78
WR 110
YWt. 1047
YR 105
Feb.ADG 3.26
Feb.Scr. 36
Fr. 5.5



★★★★★ for Low Maintenance, Growth, Marbling, Superior Cow, Calving Ease, Stayability.

★★★★★ for Low Maintenance, Marbling, High Cow Efficiency, Calving Ease, Stayability.

141 BECKTON ACCENT G096 N3

1-A 100% # 4171266 Tat.: BSF9 G096

Birth: 3-6-19

Beckton Accent U777 C2
Beckton Susan R022 CQ
Beckton Legend S670
Beckton Lana S371 DM
Beckton Nebula L P093
Beckton Minerva J615 VG
BKT Clifftop TP R288
Beckton Angel R155 CT

Beckton Cody K1 P014
Beckton Lana M809 EP
Beckton Justice CH M056
Beckton Larkaba P645 JL
Beckton Dominor Z1 R610
Beckton Mona R166 CQ
Beckton Loki CL S284
Beckton Christy R046 CQ

Beckton Nebula T398 V3
Beckton Angel T004 CT

BECKTON ACCENT B553 L2
Ref. A-3

BECKTON ANGEL X450 N

DAM
Age 9
Wt 1200
Prog.BW 67
WR 100
YR 101
Wean Pct. 35%
Cow Eff. 74

RAAA HerdBuilder index: **209** (Top 4% of RA breed)
RAAA GridMaster index: **48** (Top 38% of RA breed)
Sire Beef Tenderness: **10** 'Outstanding'
Calv.Ease BW WW YW Milk HPG Stay Maint.En.
EPDs **16 -3.6 42 73 28 12 20 -5.0**

Marb **+0.38** REA **-0.16** Bfat **+0.04**

BWt 73
WR 83
YWt. 937
YR 96
Feb.ADG 3.59
Feb.Scr. 33
Fr. 5.0



144 BECKTON NEBULA G186 D4

1-A 100% # 4171452 Tat.: BSF9 G186

Birth: 3-14-19

Beckton Nebula P P707
Beckton Nebula M045
Beckton Lana M809 EP
Beckton Justice CH M056
Beckton Larkaba T813 JC
Beckton Dominor W640 C5
Beckton Mona R166 CQ
Beckton Loki CL S284
Beckton Christy R046 CQ

Beckton Nebula M045
Beckton Lana M809 EP
Beckton Justice CH M056
Beckton Larkaba P645 JL
Beckton Dominor Z1 R610
Beckton Mona R166 CQ
Beckton Loki CL S284
Beckton Christy R046 CQ

Beckton Nebula P P707
Beckton Larkaba T813 JC

Beckton Dominor W640 C5
Beckton Christy X526 L

BECKTON NEBULA B557 J3
Ref. N-4

BECKTON CHRISTY B512 D

DAM
Age 5
Wt 1050
Prog.BW 60
WR 95
YR 102
Wean Pct. 41%
Cow Eff. 86

RAAA HerdBuilder index: **209** (Top 4% of RA breed)
RAAA GridMaster index: **49** (Top 28% of RA breed)
Sire Beef Tenderness: **6** 'Average'
Calv.Ease BW WW YW Milk HPG Stay Maint.En.
EPDs **18 -5.8 45 80 26 12 19 -5.0**

Marb **+0.46** REA **-0.03** Bfat **+0.04**

BWt 65
WR 86
YWt. 952
YR 97
Feb.ADG 3.42
Feb.Scr. 32
Fr. 5.0



★★★★★ for Low Maintenance, Marbling, Calving Ease, Stayability.

★★★★★ for Low Maintenance, Marbling, Calving Ease, Stayability.

142 BECKTON SCAMP G246 A6

1-A 100% # 4171124 Tat.: BKT9 G246

Birth: 3-17-19

Beckton Scamp B720 L4
Beckton Larkaba Y448 L
Beckton Nebula T398 V3
Beckton Belga T551 EP
Beckton Accent Y312 N3
Beckton Minerva Y654 N
Beckton New Era Y194
Beckton Lana W019 H

Beckton Scamp X458 H3
Beckton Belga W103 N

Beckton Accent C557 N4
Beckton Lana C471 N

BECKTON SCAMP E175 N5
Ref. S-2

BECKTON LANA E097 A

DAM
Age 2
Wt 725
Prog.BW 49
WR 112
YR 113
Wean Pct. 57%
Cow Eff. 121

RAAA HerdBuilder index: **188** (Top 20% of RA breed)
RAAA GridMaster index: **49** (Top 21% of RA breed)
Sire Beef Tenderness: **9** 'Outstanding'
Calv.Ease BW WW YW Milk HPG Stay Maint.En.
EPDs **18 -5.1 58 98 25 9 16 -7.0**

Marb **+0.39** REA **+0.14** Bfat **+0.04**

BWt 49
WR 112
YWt. 986
YR 113
Feb.ADG 3.42
Feb.Scr. 34
Fr. 5.5



Lot 144

★★★★★ for Low Maintenance, Growth, Marbling, Rib-eye area, Superior Cow, High Cow Efficiency, Calving Ease, Stayability.

• Bulls •

145 **BSF JULIAN G550 W9** 

1-B 99% # 4171662 Tat.: BSF9 G550

Birth: 4-3-19

Beckton Julian Z382 J7
BECKTON JULIAN E423 N8 Ref. J-5
 Beckton Belga B004 N

Beckton Julian X721 E6
 Beckton Larkaba X064 J
 Beckton Nebula Z111 N5
 Beckton Belga Z031 N
 Beckton Warrior W534 N4
 Beckton Susan W058 E
 Beckton Warrior T248 L5
 BSF Lanette P615

BWt 64
 WR 129
 YWt. 995
 YR 104
 Feb.ADG 2.45
 Feb.Scr. 35
 Fr. 5.5

BSF LANETTE D240 W
 BSF Lanette X568 W

DAM
 Age 3
 Wt 1005
 Prog.BW 64
 WR 129
 YR 104
 Wean Pct. 58%
 Cow Eff. 123

RAAA HerdBuilder index: **184** (Top 26% of RA breed)
 RAAA GridMaster index: **44** (Top 96% of RA breed)
 Sire Beef Tenderness: **9** 'Outstanding'
 Calv.Ease BW WW YW Milk HPG Stay Maint.En.
 EPDs **20 -5.8 51 77 28 13 16 -9.0**

Marb **+.37** REA **-.21** Bfat **+.04**

147 **BECKTON RANGER G328 A6** 

1-A 100% # 4170748 Tat.: BKT9 G328

Birth: 3-22-19

Beckton Ranger Z225 J4
BECKTON RANGER B006 D5 Ref. R-1
 Beckton Suffeina Z731 D

Beckton Ranger T603 H3
 Beckton Mona U564 JT
 Beckton Dominor W640 C5
 Beckton Suffeina W471 W
 Beckton Accent U777 C2
 Beckton Christy W779 C
 Beckton Julian GG B571
 Beckton Tamara W232 J

BWt 67
 WR 94
 YWt. 989
 YR 99
 Feb.ADG 3.21
 Feb.Scr. 38
 Fr. 5.5

BECKTON TAMARA D073 A
 Beckton Tamara B592 J

DAM
 Age 3
 Wt 800
 Prog.BW 64
 WR 90
 YR 99
 Wean Pct. 54%
 Cow Eff. 114

RAAA HerdBuilder index: **163** (Top 62% of RA breed)
 RAAA GridMaster index: **50** (Top 8% of RA breed)
 Sire Beef Tenderness: **7** 'Very Good'
 Calv.Ease BW WW YW Milk HPG Stay Maint.En.
 EPDs **16 -2.7 54 94 24 13 13 -8.0**

Marb **+.45** REA **+.03** Bfat **+.04**

★★★★★ for Low Maintenance, Marbling, Superior Cow, High Cow Efficiency, Calving Ease, Stayability.

★★★★★ for Low Maintenance, Marbling, Calving Ease, Stayability.

146 **BECKTON EPIC G601 A7** 

1-A 100% # 4171616 Tat.: BSF9 G601

Birth: 4-7-19

Beckton Epic U749 D5
BECKTON EPIC Z674 E6 Ref. E-1
 Beckton Indigo U504 EP

Beckton Epic K4 N795
 Beckton Denise R308 DM
 Beckton Epic K6 S569
 Beckton Indigo S016 NB
 Beckton Cody K1 P014
 Beckton Christy R046 CQ
 Beckton Justice G302
 Beckton Lana H725 CH

BWt 74
 WR 102
 YWt. 1047
 YR 105
 Feb.ADG 3.53
 Feb.Scr. 35
 Fr. 5.5

BECKTON LANA D754 A
 Beckton Accent W180 C2
 Beckton Lana N291 JC

DAM
 Age 3
 Wt 910
 Prog.BW 67
 WR 107
 YR 104
 Wean Pct. 52%
 Cow Eff. 110

RAAA HerdBuilder index: **173** (Top 44% of RA breed)
 RAAA GridMaster index: **49** (Top 28% of RA breed)
 Sire Beef Tenderness: **10** 'Outstanding'
 Calv.Ease BW WW YW Milk HPG Stay Maint.En.
 EPDs **15 -1.9 59 97 24 10 16 -3.0**

Marb **+.37** REA **+.00** Bfat **+.05**

148 **BECKTON JULIAN G151 H4** 

1-A 100% # 4171062 Tat.: BKT9 G151

Birth: 3-11-19

Beckton Julian Z382 J7
BECKTON JULIAN E423 N8 Ref. J-5
 Beckton Belga B004 N

Beckton Julian X721 E6
 Beckton Larkaba X064 J
 Beckton Nebula Z111 N5
 Beckton Belga Z031 N
 Beckton Heritage T270 J2
 Beckton Indigo H150 LN
 Beckton Nebula P P707
 Beckton Lana X234 E

BWt 65
 WR 107
 YWt. 971
 YR 106
 Feb.ADG 3.21
 Feb.Scr. 34
 Fr. 5.5

BECKTON LANA E823 H
 Beckton Heritage X403 L3
 Beckton Lana B357 N

DAM
 Age 2
 Wt 700
 Prog.BW 65
 WR 107
 YR 106
 Wean Pct. 59%
 Cow Eff. 125

RAAA HerdBuilder index: **205** (Top 6% of RA breed)
 RAAA GridMaster index: **48** (Top 45% of RA breed)
 Sire Beef Tenderness: **9** 'Outstanding'
 Calv.Ease BW WW YW Milk HPG Stay Maint.En.
 EPDs **19 -3.5 58 91 26 10 18 -7.0**

Marb **+.57** REA **-.40** Bfat **+.05**

★★★★★ for Low Maintenance, Marbling, Superior Cow, Calving Ease, Stayability.

★★★★★ for Low Maintenance, Growth, Marbling, Superior Cow, High Cow Efficiency, Calving Ease, Stayability.



Lot 146

149 **BSF EPIC G431 N7** 

1-B 99% # PENDING Tat.: BSF9 G431

Birth: 3-27-19

Beckton Epic X464 L5
BECKTON EPIC B310 J6 Ref. E-2
 Beckton Minerva Y116 J

Beckton Epic K6 S569
 Beckton Lana M393 LN
 Beckton Julian W743 H5
 Beckton Minerva W081 N
 Beckton Nebula T398 V3
 Beckton Mona X022 L
 Beckton Nebula W778 J4
 BSF Nebulann U242 NB

BWt 64
 WR 106
 YWt. 978
 YR 98
 Feb.ADG 3.26
 Feb.Scr. 33
 Fr. 5.5

BSF NEBULANN D554 N
 Beckton Nebula A773 L4
 BSF Nebulann A433 N

DAM
 Age 3
 Wt 920
 Prog.BW 68
 WR 103
 YR 96
 Wean Pct. 54%
 Cow Eff. 113

RAAA HerdBuilder index: **NA** (Top 20% of RA breed)
 RAAA GridMaster index: **0** (Top 49% of RA breed)
 Sire Beef Tenderness: **10** 'Outstanding'
 Calv.Ease BW WW YW Milk HPG Stay Maint.En.
 EPDs **14.5 -2.3 56.5 88 20.5 14 18.5 -2.5**

Marb **+.33** REA **-.05** Bfat **+.04**

★★★★★ for Low Maintenance, Marbling, Calving Ease, Stayability.

• Bulls •

150 BSF DOMINOR G368 J9 1-B 99% # 4171696 Tat.: BSF9 G368 

Birth: 3-24-19

Beckton Dominor A378 W7
BECKTON DOMINOR D254 N8 Ref. D-2
 Beckton Indigo W772 N

Beckton Dominor Y005 V6
 Beckton Lana Y541 W
 Beckton Nebula T398 V3
 Beckton Indigo T613 JT
 Beckton Julian X721 E6
 Beckton Larkaba X064 J
 Beckton Cherokee N N479
 BSF Laurel N839 LN

BSF LAUREL D235 J
 Beckton Julian Z382 J7
 BSF Laurel U202 CQ

BWt	61
WR	97
YWt.	973
YR	101
Feb.ADG	3.32
Feb.Scr.	34
Fr.	5.5

DAM
 Age 3
 Wt 990
 Prog.BW 58
 WR 102
 YR 103
 Wean Pct. 44%
 Cow Eff. 92

RAAA HerdBuilder index: **220** (Top 2% of RA breed)
 RAAA GridMaster index: **48** (Top 43% of RA breed)
 Sire Beef Tenderness: **10** 'Outstanding'
 Calv.Ease BW WW YW Milk HPG Stay Maint.En.
 EPDs **20 -5.5 45 78 28 13 19 -7.0**
 Marb **+0.37** REA **+0.09** Bfat **+0.05**

153 BECKTON JULIAN G091 N9 1-A 100% # 4171148 Tat.: BKT9 G091 

Birth: 3-6-19

Beckton Julian Z382 J7
BECKTON JULIAN E423 N8 Ref. J-5
 Beckton Belga B004 N

Beckton Julian X721 E6
 Beckton Larkaba X064 J
 Beckton Nebula Z111 N5
 Beckton Belga Z031 N
 Beckton Nebula A773 L4
 Beckton Marta A319 N
 Beckton Julian A565 J4
 Beckton Emera A250 J

BECKTON EMERA E100 N
 Beckton Nebula C067 N5
 Beckton Emera C142 J

BWt	63
WR	100
YWt.	879
YR	100
Feb.ADG	2.90
Feb.Scr.	34
Fr.	5.0

DAM
 Age 2
 Wt 780
 Prog.BW 63
 WR 100
 YR 100
 Wean Pct. 47%
 Cow Eff. 99

RAAA HerdBuilder index: **211** (Top 3% of RA breed)
 RAAA GridMaster index: **47** (Top 64% of RA breed)
 Sire Beef Tenderness: **9** 'Outstanding'
 Calv.Ease BW WW YW Milk HPG Stay Maint.En.
 EPDs **19 -4.3 53 85 25 11 19 -8.0**
 Marb **+0.39** REA **-0.25** Bfat **+0.04**

★★★★★ for Low Maintenance, Marbling, Calving Ease, Stayability.

★★★★★ for Low Maintenance, Marbling, Calving Ease, Stayability.

151 BECKTON LANCER G272 C2 1-A 100% # 4171138 Tat.: BKT9 G272 

Birth: 3-19-19

Redhill U199 Lancer 9B
REDHILL 9B LANCER 11E Ref. O-1
 Redhill T189 Barmaid 190W

Buf Crk The Right Kind U199
 Buf Crk Redpride P154
 Buf Crk Nice'N Easy T189
 1BWJ Barmaid 54P

Beckton Clifftop C201 A5
BECKTON BELGA E183 C
 Beckton Belga C743 N

Beckton Clifftop Y012 C4
 Beckton Minola X198 A
 Beckton Nebula A394 C5
 Beckton Belga A812 W

BWt	74
WR	109
YWt.	968
YR	106
Feb.ADG	2.99
Feb.Scr.	32
Fr.	6.0

DAM
 Age 2
 Wt 780
 Prog.BW 74
 WR 109
 YR 106
 Wean Pct. 55%
 Cow Eff. 116

RAAA HerdBuilder index: **145** (Top 84% of RA breed)
 RAAA GridMaster index: **48** (Top 41% of RA breed)
 Sire Beef Tenderness: **7** 'Very Good'
 Calv.Ease BW WW YW Milk HPG Stay Maint.En.
 EPDs **7 -0.4 64 99 24 12 16 -6.0**
 Marb **+0.45** REA **-0.26** Bfat **+0.04**

154 BECKTON DOMINOR G410 E8 1-A 100% # 4170700 Tat.: BKT9 G410 

Birth: 3-26-19

Beckton Dominor Y005 V6
BECKTON DOMINOR A378 W7 Ref. D-1
 Beckton Lana Y541 W

Beckton Dominor W640 C5
 Beckton Belga W108 V
 Beckton Warrior T248 L5
 Beckton Lana S074 EP
 Beckton Epic U749 D5
 Beckton Lydia S069 NB
 Beckton Legend S670
 Beckton Freyja U464 JC

BECKTON FREYJA D552 E
 Beckton Epic Y484 N6
 Beckton Freyja A425 L

BWt	66
WR	84
YWt.	949
YR	99
Feb.ADG	3.66
Feb.Scr.	33
Fr.	5.0

DAM
 Age 3
 Wt 1030
 Prog.BW 60
 WR 90
 YR 101
 Wean Pct. 36%
 Cow Eff. 75

RAAA HerdBuilder index: **185** (Top 25% of RA breed)
 RAAA GridMaster index: **50** (Top 10% of RA breed)
 Sire Beef Tenderness: **9** 'Outstanding'
 Calv.Ease BW WW YW Milk HPG Stay Maint.En.
 EPDs **18 -3.4 47 86 26 13 14 -2.0**
 Marb **+0.41** REA **+0.13** Bfat **+0.04**

★★★★★ for Low Maintenance, Growth, Marbling, Superior Cow, Calving Ease, Stayability.

★★★★★ for Low Maintenance, Marbling, Rib-eye area, Calving Ease, Stayability.

152 BECKTON LEGEND G059 E4 1-A 100% # 4171746 Tat.: BSF9 G059 

Birth: 2-27-19

Beckton Legend C313 C2
BECKTON LEGEND E049 N3 Ref. L
 Beckton Sufaina C168 N

Beckton Legend S670
 Beckton Minola W808 C
 Beckton New Era A395 L2
 Beckton Sufaina A138 N

Beckton Epic A286 E7
BECKTON INDIGO E780 E
 Beckton Indigo Y343 N

Beckton Epic Y484 N6
 Beckton Larkaba Y648 E
 Beckton Nebula T398 V3
 Beckton Indigo H150 LN

BWt	46
WR	96
YWt.	916
YR	100
Feb.ADG	3.17
Feb.Scr.	33
Fr.	5.0

DAM
 Age 2
 Wt 760
 Prog.BW 46
 WR 96
 YR 100
 Wean Pct. 49%
 Cow Eff. 102

RAAA HerdBuilder index: **207** (Top 5% of RA breed)
 RAAA GridMaster index: **48** (Top 46% of RA breed)
 Sire Beef Tenderness: **10** 'Outstanding'
 Calv.Ease BW WW YW Milk HPG Stay Maint.En.
 EPDs **18 -5.4 49 85 27 10 19 -4.0**
 Marb **+0.30** REA **-0.05** Bfat **+0.04**

155 BECKTON LIKABLE G053 L5 1-A 100% # 4170928 Tat.: BKT9 G053 

Birth: 2-26-19

Beckton Likable Y124 L3
BECKTON LIKABLE E391 N4 Ref. L-7
 Beckton Lana X466 N

Beckton Likable U130 L2
 BKT Pine Marie S802 LO
 Beckton Nebula T398 V3
 Beckton Lana T226 NB

Beckton Likable Y124 L3
BECKTON CHRISTY E538 L
 Beckton Christy Y413 N

Beckton Likable U130 L2
 BKT Pine Marie S802 LO
 Beckton Nebula U206 V3
 Beckton Christy S475 EP

BWt	45
WR	92
YWt.	875
YR	100
Feb.ADG	3.28
Feb.Scr.	32
Fr.	5.0

DAM
 Age 2
 Wt 785
 Prog.BW 45
 WR 92
 YR 100
 Wean Pct. 42%
 Cow Eff. 89

RAAA HerdBuilder index: **232** (Top 1% of RA breed)
 RAAA GridMaster index: **49** (Top 24% of RA breed)
 Sire Beef Tenderness: **8** 'Very Good'
 Calv.Ease BW WW YW Milk HPG Stay Maint.En.
 EPDs **18 -5.3 53 92 25 11 21 -2.0**
 Marb **+0.35** REA **+0.01** Bfat **+0.05**

★★★★★ for Low Maintenance, Marbling, Calving Ease, Stayability.

★★★★★ for Low Maintenance, Marbling, Calving Ease, Stayability.

• Bulls •

156 BECKTON CARDINAL G041 C3

1-A 100% # 4170998 Tat.: BKT9 G041

Birth: 2-23-19

Beckton Cardinal B074 N
 Beckton Larkaba W868 J

TR Double Eagle ZT220
 BKT Pine Marie Z250 N
 Beckton Julian G5 S107
 Beckton Larkaba S663 JE
 Beckton Clifftop Z824 C4
 Beckton Christy Z679 C
 Beckton Lancer T371 H4
 Beckton Sierra U146 LE

BWt 70
 WR 96
 YWt. 869
 YR 99
 Feb.ADG 2.69
 Feb.Scr. 33
 Fr. 5.0

BECKTON CARDINAL E381 J2
 Ref. C-5

BECKTON SIERRA E787 C
 Beckton Clifftop B079 C5
 Beckton Sierra A456 L

DAM
 Age 2
 Wt 805
 Prog.BW 70
 WR 96
 YR 99
 Wean Pct. 43%
 Cow Eff. 91

RAAA HerdBuilder index: 151 (Top 79% of RA breed)
 RAAA GridMaster index: 48 (Top 33% of RA breed)
 Sire Beef Tenderness: 7 'Very Good'
 Calv.Ease BW WW YW Milk HPG Stay Maint.En.
 EPDs 11 -1.6 55 91 20 13 14 -6.0

Marb +.33 REA -.09 Bfat +.04

★★★★★ for Low Maintenance, Marbling, Calving Ease, Stayability.

159 BSF LIKABLE G627 N6

1-B 99% # 4171600 Tat.: BSF9 G627

Birth: 4-10-19

Beckton Likable Z057 L4
 Beckton Mona Z270 C

Beckton Likable X445 J3
 Beckton Minola X107 L
 Beckton Clifftop W577 E3
 Beckton Mona U584 CD
 Beckton New Era Y194
 Beckton Minerva W901 J
 Beckton Epic X330 L6
 BSF Epique W644 N

BWt 60
 WR 96
 YWt. 930
 YR 97
 Feb.ADG 3.28
 Feb.Scr. 31
 Fr. 5.5

BECKTON LIKABLE B032 C5
 Ref. L-2

BSF EPIQUETTE D198 N
 Beckton New Era B265 J2
 BSF Epique B344 E

DAM
 Age 3
 Wt 905
 Prog.BW 63
 WR 106
 YR 103
 Wean Pct. 47%
 Cow Eff. 99

RAAA HerdBuilder index: 190 (Top 18% of RA breed)
 RAAA GridMaster index: 50 (Top 12% of RA breed)
 Sire Beef Tenderness: 7 'Very Good'
 Calv.Ease BW WW YW Milk HPG Stay Maint.En.
 EPDs 18 -5.3 48 88 26 14 16 -4.0

Marb +.52 REA -.16 Bfat +.04

★★★★★ for Low Maintenance, Marbling, Calving Ease, Stayability.

157 BECKTON EPIC G802 H7

1-A 100% # 4170688 Tat.: BKT9 G802

Birth: 5-14-19

Beckton Epic X464 L5
 Beckton Minerva Y116 J

Beckton Epic K6 S569
 Beckton Lana M393 LN
 Beckton Julian W743 H5
 Beckton Minerva W081 N
 Basin Hobo 0545
 Basin Rose 06T0
 Beckton Accent W180 C2
 Beckton Emera U675 CQ

BWt 71
 WR 112
 YWt. 1011
 YR 101
 Feb.ADG 2.58
 Feb.Scr. 32
 Fr. 5.5

BECKTON EPIC B310 J6
 Ref. E-2

BECKTON EMERA D487 B
 Bieber H Hughes W109
 Beckton Emera A186 A

DAM
 Age 3
 Wt 950
 Prog.BW 68
 WR 108
 YR 102
 Wean Pct. 55%
 Cow Eff. 116

RAAA HerdBuilder index: 204 (Top 7% of RA breed)
 RAAA GridMaster index: 47 (Top 62% of RA breed)
 Sire Beef Tenderness: 10 'Outstanding'
 Calv.Ease BW WW YW Milk HPG Stay Maint.En.
 EPDs 15 -2.0 69 103 23 14 19 -2.0

Marb +.31 REA +.05 Bfat +.03

★★★★★ for Low Maintenance, Marbling, High Cow Efficiency, Calving Ease, Stayability.

160 BSF JULIAN G257 L9

1-B 99% # 4171880 Tat.: BSF9 G257

Birth: 3-18-19

Beckton Julian Z382 J7
 Beckton Belga B004 N

Beckton Julian X721 E6
 Beckton Larkaba X064 J
 Beckton Nebula Z111 N5
 Beckton Belga Z031 N
 Beckton Likable Y124 L3
 Beckton Tara Z160 N
 Beckton Scamp X494 E3
 BSF Wendie X068 N

BWt 54
 WR 100
 YWt. 904
 YR 99
 Feb.ADG 3.01
 Feb.Scr. 32
 Fr. 5.0

BECKTON JULIAN E423 N8
 Ref. J-5

BSF WENDIE E111 L
 Beckton Likable C744 N4
 BSF Wendie C536 S

DAM
 Age 2
 Wt 825
 Prog.BW 54
 WR 100
 YR 99
 Wean Pct. 47%
 Cow Eff. 98

RAAA HerdBuilder index: 199 (Top 9% of RA breed)
 RAAA GridMaster index: 47 (Top 65% of RA breed)
 Sire Beef Tenderness: 9 'Outstanding'
 Calv.Ease BW WW YW Milk HPG Stay Maint.En.
 EPDs 20 -5.4 49 79 27 12 17 -9.0

Marb +.44 REA -.21 Bfat +.04

★★★★★ for Low Maintenance, Marbling, Calving Ease, Stayability.

158 BECKTON ORACLE G016 E2

1-A 100% # 4170898 Tat.: BKT9 G016

Birth: 2-18-19

Schuler Sudden Impact 0004X
 Sor Marlee Cmmtmt 0470X

Red Crowfoot Ole's Oscar
 SOR Duchess TS 8915U
 Brown Commitment S7206
 SOR Marlee Beef 4511P
 Beckton Epic U749 D5
 Beckton Tamara U185 NB
 Beckton Nebula T054 H3
 Beckton Firefly T003 JC

BWt 49
 WR 91
 YWt. 865
 YR 95
 Feb.ADG 2.74
 Feb.Scr. 36
 Fr. 5.0

SCHULER ORACLE-7142E
 Ref. O-2

BECKTON FIREFLY E275 E
 Beckton Epic B376 N6
 Beckton Firefly W013 N

DAM
 Age 2
 Wt 755
 Prog.BW 49
 WR 91
 YR 95
 Wean Pct. 46%
 Cow Eff. 96

RAAA HerdBuilder index: 217 (Top 2% of RA breed)
 RAAA GridMaster index: 50 (Top 13% of RA breed)
 Sire Beef Tenderness: 10 'Outstanding'
 Calv.Ease BW WW YW Milk HPG Stay Maint.En.
 EPDs 22 -5.3 52 89 24 13 18 -1.0

Marb +.66 REA +.08 Bfat +.04

★★★★★ for Low Maintenance, Marbling, Calving Ease, Stayability.

161 BECKTON ACCENT G706 L4

1-A 100% # 4170666 Tat.: BKT9 G706

Birth: 4-20-19

Beckton Accent W180 C2
 Beckton Lana Y033 W

Beckton Cody K1 P014
 Beckton Christy R046 CQ
 Beckton Warrior W534 N4
 Beckton Lana W370 E
 Mushrush Lunesta MD Y097
 Mushrush Candice JL X212
 Beckton Accent U777 C2
 Beckton Tamara R834 JC

BWt 55
 WR 99
 YWt. 928
 YR 95
 Feb.ADG 2.80
 Feb.Scr. 33
 Fr. 5.0

BECKTON ACCENT B740 W3
 Ref. A-5

BECKTON TAMARA C647 L
 Mushrush Lunesta A007
 Beckton Tamara A225 A

DAM
 Age 4
 Wt 865
 Prog.BW 57
 WR 98
 YR 98
 Wean Pct. 55%
 Cow Eff. 116

RAAA HerdBuilder index: 205 (Top 6% of RA breed)
 RAAA GridMaster index: 48 (Top 47% of RA breed)
 Sire Beef Tenderness: 9 'Outstanding'
 Calv.Ease BW WW YW Milk HPG Stay Maint.En.
 EPDs 21 -6.6 54 89 27 10 18 -3.0

Marb +.43 REA +.10 Bfat +.04

★★★★★ for Low Maintenance, Marbling, High Cow Efficiency, Calving Ease, Stayability.

• Bulls •

162 BECKTON SCAMP G853 N5
1-A 100% # 4171310 Tat.: BSF9 G853 

Birth: 6-6-19

Beckton Scamp X494 E3
BECKTON SCAMP A627 J4
Ref. S Beckton Serena R023 JC

Beckton Nebula T398 V3
BECKTON LARKABA Y156 N
Beckton Larkaba U274 JL

Beckton Scamp T A825
Beckton Lana S074 EP
Beckton Justice Cc N265
Beckton Serena N469 JC
Beckton Nebula L P093
Beckton Minerva J615 VG
Beckton Julian G3 P608
Beckton Larkaba N708 HR

BWt 89
WR 102
YWt. 1020
YR 98
Feb.ADG 2.96
Feb.Scr. 34
Fr. 5.5

DAM
Age 8
Wt 1280
Prog.BW 73
WR 104
YR 103
Wean Pct. 44%
Cow Eff. 92

RAAA HerdBuilder index: **194** (Top 14% of RA breed)
RAAA GridMaster index: **48** (Top 42% of RA breed)
Sire Beef Tenderness: **7** 'Very Good'
Calv.Ease BW WW YW Milk HPG Stay Maint.En.
EPDs **19 -5.1 52 87 28 14 16 -11.0**
Marb **+0.30** REA **-0.14** Bfat **+0.02**

165 BECKTON HUGHES G100 H4
1-A 100% # 4171162 Tat.: BKT9 G100 

Birth: 3-7-19

Beckton Hughes C350 N2
BECKTON HUGHES E113 S3
Ref. B Beckton Lana C003 S

Beckton Hughes C463 N2
BECKTON MINOLA E101 H
Beckton Minola C770 J

Bieber H Hughes W109
Beckton Kit Z049 N
Beckton Scamp A627 J4
Beckton Lana A574 N
Bieber H Hughes W109
Beckton Lakme T689 NX
Beckton Julian X465 J5
Beckton Minola Y306 N

BWt 64
WR 98
YWt. 870
YR 99
Feb.ADG 3.76
Feb.Scr. 32
Fr. 5.0

DAM
Age 2
Wt 885
Prog.BW 64
WR 98
YR 99
Wean Pct. 40%
Cow Eff. 85

RAAA HerdBuilder index: **171** (Top 49% of RA breed)
RAAA GridMaster index: **47** (Top 60% of RA breed)
Sire Beef Tenderness: **9** 'Outstanding'
Calv.Ease BW WW YW Milk HPG Stay Maint.En.
EPDs **15 -1.9 60 94 22 13 15 -2.0**
Marb **+0.31** REA **-0.12** Bfat **+0.04**

★★★★★ for Low Maintenance, Marbling, Superior Cow, Calving Ease, Stayability.

★★★★★ for Low Maintenance, Marbling, Calving Ease, Stayability.

163 BECKTON DOMINOR G281 E9
1-A 100% # 4170678 Tat.: BKT9 G281 

Birth: 3-20-19

Beckton Dominor A378 W7
BECKTON DOMINOR D254 N8
Ref. D-2 Beckton Indigo W772 N

Beckton Epic B376 N6
BECKTON LANA D315 E
Beckton Lana A003 N

Beckton Dominor Y005 V6
Beckton Lana Y541 W
Beckton Nebula T398 V3
Beckton Indigo T613 JT
Beckton Epic U749 D5
Beckton Tamara U185 NB
Beckton Nebula Y036 N4
Beckton Lana Y024 N

BWt 68
WR 88
YWt. 863
YR 86
Feb.ADG 3.01
Feb.Scr. 32
Fr. 5.0

DAM
Age 3
Wt 890
Prog.BW 59
WR 93
YR 89
Wean Pct. 45%
Cow Eff. 96

RAAA HerdBuilder index: **197** (Top 11% of RA breed)
RAAA GridMaster index: **46** (Top 77% of RA breed)
Sire Beef Tenderness: **10** 'Outstanding'
Calv.Ease BW WW YW Milk HPG Stay Maint.En.
EPDs **20 -5.1 39 66 29 12 18 -3.0**
Marb **+0.39** REA **-0.05** Bfat **+0.05**

★★★★★ for Low Maintenance, Marbling, Calving Ease, Stayability.

166 BECKTON LIKABLE G326 E5
1-A 100% # 4170874 Tat.: BKT9 G326 

Birth: 3-22-19

Beckton Likable Y124 L3
BECKTON LIKABLE E391 N4
Ref. L-7 Beckton Lana X466 N

Beckton Epic C776 J6
BECKTON LANA E443 E
Beckton Lana U840 JL

Beckton Likable U130 L2
BKT Pine Marie S802 LO
Beckton Nebula T398 V3
Beckton Lana T226 NB
Beckton Epic X464 L5
Beckton Sierra Y058 J
Beckton Julian G5 S107
Beckton Lana S827 JL

BWt 64
WR 98
YWt. 915
YR 100
Feb.ADG 3.17
Feb.Scr. 32
Fr. 5.0

DAM
Age 2
Wt 915
Prog.BW 64
WR 98
YR 100
Wean Pct. 41%
Cow Eff. 87

RAAA HerdBuilder index: **205** (Top 6% of RA breed)
RAAA GridMaster index: **50** (Top 13% of RA breed)
Sire Beef Tenderness: **8** 'Very Good'
Calv.Ease BW WW YW Milk HPG Stay Maint.En.
EPDs **14 -2.1 61 102 24 17 18 -6.0**
Marb **+0.34** REA **+0.03** Bfat **+0.05**

★★★★★ for Low Maintenance, Marbling, Calving Ease, Stayability.

164 BECKTON ACCENT G477 J7
1-A 100% # 4171142 Tat.: BKT9 G477 

Birth: 3-29-19

Beckton Accent B740 W3
BECKTON ACCENT E492 N4
Ref. A-8 BKT Pine Marie Z177 N

Beckton Julian C226 E7
BECKTON MINOLA E656 J
Beckton Minola C409 H

Beckton Accent W180 C2
Beckton Lana Y033 W
Beckton Nebula X096 N4
BKT Pine Marie X540 H
Beckton Julian A479 L6
Beckton Minerva A365 E
Beckton Heritage A767 C3
Beckton Minola A590 H

BWt 53
WR 115
YWt. 932
YR 106
Feb.ADG 3.28
Feb.Scr. 33
Fr. 5.5

DAM
Age 2
Wt 815
Prog.BW 53
WR 115
YR 106
Wean Pct. 52%
Cow Eff. 110

RAAA HerdBuilder index: **173** (Top 45% of RA breed)
RAAA GridMaster index: **48** (Top 30% of RA breed)
Sire Beef Tenderness: **6** 'Average'
Calv.Ease BW WW YW Milk HPG Stay Maint.En.
EPDs **16 -4.1 61 96 27 10 15 -3.0**
Marb **+0.47** REA **+0.14** Bfat **+0.04**

★★★★★ for Low Maintenance, Growth, Marbling, Rib-eye area, Superior Cow, Calving Ease, Stayability.

167 BECKTON LEGEND G585 A4
1-A 100% # 4171690 Tat.: BKT9 G585 

Birth: 4-6-19

Beckton Legend C313 C2
BECKTON LEGEND E032 E3
Ref. L-6 Beckton Emera C066 E

Beckton Accent W180 C2
BECKTON LANA D257 A
Beckton Lana Z832 N

Beckton Legend S670
Beckton Minola W808 C
Beckton Epic A286 E7
Beckton Emera A029 D
Beckton Cody K1 P014
Beckton Christy R046 CQ
Beckton Nebula T269 E2
Beckton Lana W113 N

BWt 72
WR 108
YWt. 1081
YR 113
Feb.ADG 3.70
Feb.Scr. 39
Fr. 5.0

DAM
Age 3
Wt 1050
Prog.BW 60
WR 108
YR 113
Wean Pct. 46%
Cow Eff. 97

RAAA HerdBuilder index: **223** (Top 1% of RA breed)
RAAA GridMaster index: **49** (Top 15% of RA breed)
Sire Beef Tenderness: **7** 'Very Good'
Calv.Ease BW WW YW Milk HPG Stay Maint.En.
EPDs **18 -3.4 59 102 24 13 20 -4.0**
Marb **+0.30** REA **+0.14** Bfat **+0.04**

★★★★★ for Low Maintenance, Growth, Marbling, Rib-eye area, Superior Cow, Calving Ease, Stayability.

• Bulls •



Lot 167

170 BSF LANCER G312 E2
 1-B 99% # 4171836 Tat.: BSF9 G312

Birth: 3-21-19

REDHILL 9B LANCER 11E
 Ref. O-1

BSF LANETTE E831 E

DAM
 Age 2
 Wt 775
 Prog.BW 77
 WR 116
 YR 113
 Wean Pct. 55%
 Cow Eff. 117

RAAA HerdBuilder index: **160** (Top 68% of RA breed)
 RAAA GridMaster index: **49** (Top 23% of RA breed)
 Sire Beef Tenderness: **7** 'Very Good'
 Calv.Ease BW WW YW Milk HPG Stay Maint.En.
 EPDs **10 -1.0 70 109 25 15 15 -5.0**
 Marb **+0.35** REA **+0.01** Bfat **+0.03**

★★★★★ for Low Maintenance, Growth, Marbling, Superior Cow, High Cow Efficiency, Calving Ease, Stayability.

168 BSF ACCENT G159 J4
 1-B 99% # 4171352 Tat.: BSF9 G159

Birth: 3-12-19

BECKTON ACCENT B653 C3
 Ref. A-4

BSF LAUREL Z268 J

DAM
 Age 7
 Wt 965
 Prog.BW 68
 WR 96
 YR 98
 Wean Pct. 51%
 Cow Eff. 106

RAAA HerdBuilder index: **191** (Top 16% of RA breed)
 RAAA GridMaster index: **47** (Top 58% of RA breed)
 Sire Beef Tenderness: **10** 'Outstanding'
 Calv.Ease BW WW YW Milk HPG Stay Maint.En.
 EPDs **19 -5.1 49 82 25 14 17 -9.0**
 Marb **+0.32** REA **-0.16** Bfat **+0.04**

★★★★★ for Low Maintenance, Marbling, Calving Ease, Stayability.

171 BECKTON ACCENT G149 C3
 1-A 100% # 4170162 Tat.: BKT9 G149

Birth: 3-11-19

BECKTON ACCENT B653 C3
 Ref. A-4

BECKTON ROSE U726 CT

DAM
 Age 11
 Wt 1015
 Prog.BW 58
 WR 93
 YR 97
 Wean Pct. 43%
 Cow Eff. 90

RAAA HerdBuilder index: **184** (Top 27% of RA breed)
 RAAA GridMaster index: **47** (Top 68% of RA breed)
 Sire Beef Tenderness: **10** 'Outstanding'
 Calv.Ease BW WW YW Milk HPG Stay Maint.En.
 EPDs **21 -6.3 40 69 26 8 16 -12.0**
 Marb **+0.46** REA **-0.18** Bfat **+0.05**

★★★★★ for Low Maintenance, Marbling, Calving Ease, Stayability.

169 BECKTON ACCENT G138 D4
 1-A 100% # 4170304 Tat.: BKT9 G138

Birth: 3-10-19

BECKTON ACCENT B653 C3
 Ref. A-4

BECKTON LARKEISA Z396 D

DAM
 Age 7
 Wt 1100
 Prog.BW 64
 WR 90
 YR 104
 Wean Pct. 37%
 Cow Eff. 78

RAAA HerdBuilder index: **185** (Top 25% of RA breed)
 RAAA GridMaster index: **47** (Top 54% of RA breed)
 Sire Beef Tenderness: **10** 'Outstanding'
 Calv.Ease BW WW YW Milk HPG Stay Maint.En.
 EPDs **20 -5.3 43 74 24 13 16 -7.0**
 Marb **+0.29** REA **-0.08** Bfat **+0.03**

★★★★★ for Low Maintenance, Marbling, Calving Ease, Stayability.



Lot 171

• Bulls •

172 BECKTON ACCENT G615 A4
1-A 100% # 4170780 Tat.: BKT9 G615 

Birth: 4-8-19

Beckton Accent W180 C2
Beckton Christy R046 CQ
Beckton Nebula T398 V3
Beckton Minerva M369 LO
Beckton Accent W180 C2
Beckton Lana R214 RA
Beckton Julian GG B571
Beckton Maiata M854 JC

BECKTON ACCENT B549 N3
Ref. A-2

BECKTON MAIATA D846 A

DAM
Age 3
Wt 950
Prog.BW 66
WR 97
YR 94
Wean Pct. 47%
Cow Eff. 100

RAAA HerdBuilder index: **205** (Top 6% of RA breed)
RAAA GridMaster index: **48** (Top 40% of RA breed)
Sire Beef Tenderness: **9** 'Outstanding'
Calv.Ease BW WW YW Milk HPG Stay Maint.En.
EPDs **14 -1.9 61 98 24 13 20 -1.0**
Marb **+0.34** REA **+0.03** Bfat **+0.04**

BWt 68
WR 97
YWt. 945
YR 94
Feb.ADG 2.61
Feb.Scr. 34
Fr. 5.5

★★★★★ for Low Maintenance, Marbling, Calving Ease, Stayability.

175 BSF ACCENT G757 A4
1-B 99% # 4171280 Tat.: BSF9 G757 

Birth: 5-2-19

Beckton Accent W180 C2
Beckton Christy R046 CQ
Beckton Nebula T398 V3
Beckton Minerva M369 LO
Beckton Cody K1 P014
Beckton Susan R022 CQ
BKT Clifftop TP R288
BSF Regus F175

BECKTON ACCENT B549 N3
Ref. A-2

BSF CLIFFTANA X100 A

DAM
Age 9
Wt 1120
Prog.BW 74
WR 109
YR 103
Wean Pct. 53%
Cow Eff. 112

RAAA HerdBuilder index: **189** (Top 19% of RA breed)
RAAA GridMaster index: **47** (Top 66% of RA breed)
Sire Beef Tenderness: **9** 'Outstanding'
Calv.Ease BW WW YW Milk HPG Stay Maint.En.
EPDs **15 -1.9 60 95 26 13 18 -3.0**
Marb **+0.33** REA **-0.03** Bfat **+0.04**

BWt 77
WR 110
YWt. 1049
YR 101
Feb.ADG 3.21
Feb.Scr. 36
Fr. 5.5

★★★★★ for Low Maintenance, Marbling, Superior Cow, Calving Ease, Stayability.

173 BECKTON LIKABLE G416 A4
1-A 100% # 4171630 Tat.: BSF9 G416 

Birth: 3-26-19

Beckton Likable U130 L2
Beckton Roman J S158
Beckton Tamara R834 JC
Beckton Accent W180 C2
Beckton Lana W463 L
Beckton Julian GJ P535
Beckton Christy P333 CH

BECKTON LIKABLE C229 R3
Ref. L-4

BECKTON CHRISTY D232 A

DAM
Age 3
Wt 910
Prog.BW 67
WR 100
YR 101
Wean Pct. 51%
Cow Eff. 107

RAAA HerdBuilder index: **195** (Top 12% of RA breed)
RAAA GridMaster index: **48** (Top 44% of RA breed)
Sire Beef Tenderness: **9** 'Outstanding'
Calv.Ease BW WW YW Milk HPG Stay Maint.En.
EPDs **15 -2.7 58 90 24 12 19 -5.0**
Marb **+0.38** REA **+0.01** Bfat **+0.05**

BWt 74
WR 99
YWt. 1014
YR 101
Feb.ADG 3.48
Feb.Scr. 33
Fr. 5.0

★★★★★ for Low Maintenance, Marbling, Calving Ease, Stayability.

176 BECKTON CARDINAL G109 L3
1-A 100% # 4171182 Tat.: BKT9 G109 

Birth: 3-8-19

Beckton Cardinal B074 N
Beckton Julian G5 S107
Beckton Larkaba W868 J
Beckton Legend Z689 J3
Beckton Larkaba W868 J
Beckton Coca X433 L
Beckton Coca T419 NB

BECKTON CARDINAL E381 J2
Ref. C-5

BECKTON COCA E889 L

DAM
Age 2
Wt 950
Prog.BW NA
WR NA
YR NA
Wean Pct. 43%
Cow Eff. 90

RAAA HerdBuilder index: **173** (Top 45% of RA breed)
RAAA GridMaster index: **47** (Top 55% of RA breed)
Sire Beef Tenderness: **7** 'Very Good'
Calv.Ease BW WW YW Milk HPG Stay Maint.En.
EPDs **16 -4.1 54 86 22 13 15 -3.0**
Marb **+0.32** REA **-0.08** Bfat **+0.04**

BWt 57
WR 110
YWt. 962
YR 110
Feb.ADG 3.32
Feb.Scr. 33
Fr. 5.5

★★★★★ for Low Maintenance, Growth, Marbling, Calving Ease, Stayability.

174 BECKTON HERITAGE G129 S5
1-A 100% # 4170682 Tat.: BKT9 G129 

Birth: 3-9-19

Beckton Heritage A767 C3
Beckton Rose W816 C
Beckton Loki CL S284
Beckton Susan S684 JJ
Beckton Scamp X494 E3
Beckton Serena R023 JC
Beckton Nebula Y002 C5
Beckton Ruth Y047 N

BECKTON HERITAGE D195 L4
Ref. H-1

BECKTON RUTH D728 S

DAM
Age 3
Wt 825
Prog.BW 54
WR 95
YR 104
Wean Pct. 52%
Cow Eff. 109

RAAA HerdBuilder index: **164** (Top 61% of RA breed)
RAAA GridMaster index: **48** (Top 40% of RA breed)
Sire Beef Tenderness: **10** 'Outstanding'
Calv.Ease BW WW YW Milk HPG Stay Maint.En.
EPDs **20 -5.4 55 93 24 12.5 13 -4.0**
Marb **+0.36** REA **-0.15** Bfat **+0.04**

BWt 60
WR 96
YWt. 942
YR 98
Feb.ADG 3.04
Feb.Scr. 32
Fr. 5.5

★★★★★ for Low Maintenance, Marbling, Calving Ease, Stayability.

177 BECKTON EPIC G258 J8
1-A 100% # 4171196 Tat.: BSF9 G258 

Birth: 3-19-19

Beckton Epic Z674 E6
Beckton Indigo U504 EP
Beckton Legend S670
Beckton Lana S371 DM
Beckton Julian GG B571
Bkt Suffeina A828 DM
Beckton Herald FJ J776
Beckton Larkaba G311 CT

BECKTON EPIC D275 L7
Ref. E-3

BECKTON LARKABA U274 JL

DAM
Age 11
Wt 955
Prog.BW 63
WR 93
YR 96
Wean Pct. 45%
Cow Eff. 94

RAAA HerdBuilder index: **193** (Top 15% of RA breed)
RAAA GridMaster index: **49** (Top 29% of RA breed)
Sire Beef Tenderness: **7** 'Very Good'
Calv.Ease BW WW YW Milk HPG Stay Maint.En.
EPDs **19 -4.8 48 77 20 12 16 -7.0**
Marb **+0.48** REA **-0.30** Bfat **+0.02**

BWt 75
WR 89
YWt. 918
YR 94
Feb.ADG 3.15
Feb.Scr. 34
Fr. 5.0

★★★★★ for Low Maintenance, Marbling, Calving Ease, Stayability.

• Bulls •

178 BSF DOMINOR G282 J9 

1-B 99% # 4171646 Tat.: BSF9 G282

Birth: 3-20-19

Beckton Dominor A378 W7 < Beckton Dominor Y005 V6
Beckton Lana Y541 W

BECKTON DOMINOR D254 N8 < Beckton Nebula T398 V3
Ref. D-2 < Beckton Indigo W772 N < Beckton Indigo T613 JT
Beckton Julian X721 E6

BSF WARRITA D524 J < Beckton Larkaba X064 J
Beckton Julian Z382 J7 < BKT Clifftop TP R288
BSF Warrita W536 C < BSF Warrita S236 WR

BWt	66
WR	93
YWt.	882
YR	88
Feb.ADG	2.45
Feb.Scr.	32
Fr.	5.5

Age	3
Wt	965
Prog.BW	61
WR	96
YR	93
Wean Pct.	45%
Cow Eff.	94

RAAA HerdBuilder index: **207** (Top 5% of RA breed)
RAAA GridMaster index: **46** (Top 76% of RA breed)
Sire Beef Tenderness: **10** 'Outstanding'
Calv.Ease BW WW YW Milk HPG Stay Maint.En.
EPDs **19 -5.4 41 66 30 13 19 -7.0**

Marb **+0.38** REA **+0.01** Bfat **+0.04**

181 BECKTON ACCENT G789 L4 

1-A 100% # 4171544 Tat.: BSF9 G789

Birth: 5-10-19

Beckton Accent W180 C2 < Beckton Cody K1 P014
Beckton Christy R046 CQ

BECKTON ACCENT B549 N3 < Beckton Nebula T398 V3
Ref. A-2 < Beckton Minerva Y654 N < Beckton Minerva M369 LO
Mushrush Lunesta MD Y097

BECKTON BARMAID C005 L < Mushrush Candice JL X212
Beckton Warrior W534 N4
Beckton Barmaid A776 W < Beckton Barmaid X819 N

BWt	85
WR	109
YWt.	969
YR	99
Feb.ADG	2.50
Feb.Scr.	33
Fr.	6.0

Age	4
Wt	1020
Prog.BW	67
WR	109
YR	94
Wean Pct.	52%
Cow Eff.	110

RAAA HerdBuilder index: **203** (Top 7% of RA breed)
RAAA GridMaster index: **47** (Top 60% of RA breed)
Sire Beef Tenderness: **9** 'Outstanding'
Calv.Ease BW WW YW Milk HPG Stay Maint.En.
EPDs **13 -1.7 60 91 25 12 20 -4.0**

Marb **+0.43** REA **-0.01** Bfat **+0.05**

★★★★★ for Low Maintenance, Marbling, Calving Ease, Stayability.

★★★★★ for Low Maintenance, Marbling, Calving Ease, Stayability.

179 BECKTON LIKABLE G682 A6 

1-A 100% # 4170752 Tat.: BKT9 G682

Birth: 4-16-19

Beckton Likable Z057 L4 < Beckton Likable X445 J3
Beckton Minola X107 L

BECKTON LIKABLE B032 C5 < Beckton Clifftop W577 E3
Ref. L-2 < Beckton Mona Z270 C < Beckton Mona U584 CD
Beckton Accent Y312 N3

BECKTON TAMARA D163 A < BKT Larkeisa U535 HS
Beckton Epic X464 L5
Beckton Tamara B700 E < Beckton Tamara Y585 N

BWt	69
WR	101
YWt.	1056
YR	106
Feb.ADG	3.70
Feb.Scr.	34
Fr.	5.5

Age	3
Wt	935
Prog.BW	71
WR	101
YR	96
Wean Pct.	51%
Cow Eff.	106

RAAA HerdBuilder index: **200** (Top 9% of RA breed)
RAAA GridMaster index: **51** (Top 5% of RA breed)
Sire Beef Tenderness: **7** 'Very Good'
Calv.Ease BW WW YW Milk HPG Stay Maint.En.
EPDs **16 -4.0 58 104 25 13 17 -4.0**

Marb **+0.52** REA **-0.02** Bfat **+0.04**

★★★★★ for Low Maintenance, Growth, Marbling, Calving Ease, Stayability.

182 BECKTON EPIC G144 C8 

1-A 100% # 4171006 Tat.: BKT9 G144

Birth: 3-11-19

Beckton Epic Z674 E6 < Beckton Epic U749 D5
Beckton Indigo U504 EP

BECKTON EPIC E670 E7 < Beckton Epic U749 D5
Ref. E-5 < Beckton Christy Z958 E < Beckton Christy W831 A
TR Ricardo DOS

BECKTON TAMARA E236 D < Beckton Lana U182 JC
Beckton Accent U777 C2
Beckton Tamara A547 A < Beckton Tamara W204 E

BWt	73
WR	107
YWt.	953
YR	104
Feb.ADG	2.88
Feb.Scr.	33
Fr.	5.5

Age	2
Wt	785
Prog.BW	73
WR	107
YR	104
Wean Pct.	53%
Cow Eff.	111

RAAA HerdBuilder index: **169** (Top 53% of RA breed)
RAAA GridMaster index: **49** (Top 27% of RA breed)
Sire Beef Tenderness: **8** 'Very Good'
Calv.Ease BW WW YW Milk HPG Stay Maint.En.
EPDs **19 -2.4 58 95 25 8 13 -4.0**

Marb **+0.38** REA **+0.04** Bfat **+0.04**

★★★★★ for Low Maintenance, Marbling, Superior Cow, Calving Ease, Stayability.

180 WCRA JULIAN G148 

1-A 100% #4149822 Tat.: WCRA9 GC14

Birth: 4-10-19

Beckton Julian X465 J5 < Beckton Julian G5 S107
Beckton Suffeina P643 JL

BECKTON JULIAN A434 N6 < Beckton Nexus L016
Ref. J-4 < Beckton Lakme M669 EP
Beckton Julian GG B571

WCRA INDIGO C105 C < HXC Conquest 4405P
Beckton Indigo A143 N < HXC Ellie May MA638
Beckton Nebula W486 D3
Beckton Indigo T613 JT

BWt	84
WR	101
YWt.	896
YR	101
Feb.ADG	2.66
Feb.Scr.	32
Fr.	5.5

Age	4
Wt	1230
Prog.BW	76
WR	95
YR	100
Wean Pct.	41%
Cow Eff.	NA

RAAA HerdBuilder index: **158** (Top 70% of RA breed)
RAAA GridMaster index: **49** (Top 22% of RA breed)
Sire Beef Tenderness: **7** 'Very Good'
Calv.Ease BW WW YW Milk HPG Stay Maint.En.
EPDs **10 -1.0 62 100 19 6.5 15 5.0**

Marb **+0.37** REA **-0.17** Bfat **+0.03**

★★★★★ for Marbling, Calving Ease, Stayability.



Lot 182

• Bulls •

183 BSF ACCENT G453 N4 

1-B 99% # 4171596 Tat.: BSF9 G453

Birth: 3-28-19

Beckton Accent W180 C2
BECKTON ACCENT B549 N3
 Ref. A-2
 Beckton Minerva Y654 N

Beckton Cody K1 P014
 Beckton Christy R046 CQ
 Beckton Nebula T398 V3
 Beckton Minerva M369 LO
 Beckton Nebula P P707
 Beckton Larkaba T813 JC
 Beckton Legend S670
 BSF Erica W053 R

BWt 56
 WR 104
 YWt. 1011
 YR 105
 Feb.ADG 3.42
 Feb.Scr. 36
 Fr. 5.0

Beckton Nebula B557 J3
BSF ERICA D089 N
 BSF Erica B207 L

DAM
 Age 3
 Wt 780
 Prog.BW 58
 WR 100
 YR 102
 Wean Pct. 60%
 Cow Eff. 126

RAAA HerdBuilder index: 217 (Top 2% of RA breed)
 RAAA GridMaster index: 49 (Top 29% of RA breed)
 Sire Beef Tenderness: 9 'Outstanding'
 Calv.Ease BW WW YW Milk HPG Stay Maint.En.
 EPDs 17 -4.8 54 93 27 12 20 -6.0
 Marb +.43 REA +.08 Bfat +.04

185 BECKTON EPIC G024 A8 

1-A 100% # 4171844 Tat.: BSF9 G024

Birth: 2-19-19

Beckton Epic Z674 E6
BECKTON EPIC E488 N7
 Ref. E-4
 Beckton Sierra Z059 N

Beckton Epic U749 D5
 Beckton Indigo U504 EP
 Beckton Nebula X096 N4
 Beckton Sierra X818 C
 Beckton Accent Y312 N3
 Beckton Minerva Y654 N
 Beckton Clifftop Y012 C4
 Beckton Lana W314 J

BWt 70
 WR 102
 YWt. 919
 YR 101
 Feb.ADG 3.04
 Feb.Scr. 34
 Fr. 5.0

Beckton Accent C557 N4
BECKTON LANA E873 A
 Beckton Lana C739 C

DAM
 Age 2
 Wt 785
 Prog.BW 70
 WR 102
 YR 101
 Wean Pct. 50%
 Cow Eff. 106

RAAA HerdBuilder index: 176 (Top 40% of RA breed)
 RAAA GridMaster index: 49 (Top 29% of RA breed)
 Sire Beef Tenderness: 9 'Outstanding'
 Calv.Ease BW WW YW Milk HPG Stay Maint.En.
 EPDs 16 -0.7 61 100 25 11 15 -4.0
 Marb +.49 REA -.19 Bfat +.05

★★★★★ for Low Maintenance, Growth, Marbling, High Cow Efficiency, Calving Ease, Stayability.

★★★★★ for Low Maintenance, Marbling, Calving Ease, Stayability.



Lot 183

186 BECKTON LIKABLE G652 J4 

1-A 100% # 4170152 Tat.: BKT9 G652

Birth: 4-13-19

Beckton Accent U777 C2
BECKTON ACCENT B653 C3
 Ref. A-4
 Beckton Christy W779 C

Beckton Cody K1 P014
 Beckton Susan R022 CQ
 BKT Clifftop TP R288
 Beckton Christy S151 NB
 Beckton Julian 7526G
 Bkt Marta 9A13 JL
 Beckton Justice G302
 Beckton Maiata C997 CB

BWt 78
 WR 97
 YWt. 977
 YR 100
 Feb.ADG 3.04
 Feb.Scr. 35
 Fr. 5.0

Beckton Julian GG B571
BECKTON MAIATA U518 JL
 Beckton Maiata M854 JC

DAM
 Age 11
 Wt 1160
 Prog.BW 74
 WR 105
 YR 104
 Wean Pct. 41%
 Cow Eff. 85

RAAA HerdBuilder index: 171 (Top 49% of RA breed)
 RAAA GridMaster index: 47 (Top 60% of RA breed)
 Sire Beef Tenderness: 10 'Outstanding'
 Calv.Ease BW WW YW Milk HPG Stay Maint.En.
 EPDs 15 -2.3 54 83 24 14 16 -5.0
 Marb +.33 REA -.22 Bfat +.04

★★★★★ for Low Maintenance, Marbling, Superior Cow, Calving Ease, Stayability.

184 BSF SCAMP G019 L6 

1-B 99% # 4171806 Tat.: BSF9 G019

Birth: 2-18-19

Beckton Scamp B720 L4
BECKTON SCAMP E175 N5
 Ref. S-2
 Beckton Belga W103 N

Beckton Scamp X458 H3
 Beckton Larkaba Y448 L
 Beckton Nebula T398 V3
 Beckton Belga T551 EP
 Beckton Likable Z057 L4
 Beckton Lana Z216 L
 Beckton Nebula W486 D3
 BSF Loketta Y361 A

BWt 49
 WR 102
 YWt. 904
 YR 103
 Feb.ADG 3.10
 Feb.Scr. 34
 Fr. 5.0

Beckton Likable B274 L5
BSF LOKETTA E483 L
 BSF Loketta B755 N

DAM
 Age 2
 Wt 805
 Prog.BW 49
 WR 102
 YR 103
 Wean Pct. 46%
 Cow Eff. 97

RAAA HerdBuilder index: 190 (Top 18% of RA breed)
 RAAA GridMaster index: 49 (Top 19% of RA breed)
 Sire Beef Tenderness: 9 'Outstanding'
 Calv.Ease BW WW YW Milk HPG Stay Maint.En.
 EPDs 18 -5.3 53 94 24 11 16 -8.0
 Marb +.33 REA +.04 Bfat +.03

★★★★★ for Low Maintenance, Marbling, Calving Ease, Stayability.

187 BECKTON HUGHES G622 C3 

1-A 100% # 4171198 Tat.: BSF9 G622

Birth: 4-10-19

Bieber H Hughes W109
BECKTON HUGHES C350 N2
 Ref. B-1
 Beckton Kit Z049 N

Basin Hobo 0545
 Basin Rose 06T0
 Beckton Nebula X353 E3
 Beckton Kit X236 L
 Beckton Clifftop T C075
 Beckton Christy K209 CO
 Beckton Dominor ZC M919
 Beckton Lana M552 WR

BWt 70
 WR 100
 YWt. 951
 YR 97
 Feb.ADG 3.26
 Feb.Scr. 35
 Fr. 5.5

BKT Clifftop TP R288
BECKTON LANA U386 CT
 Beckton Lana P026 DM

DAM
 Age 11
 Wt 1035
 Prog.BW 67
 WR 98
 YR 98
 Wean Pct. 47%
 Cow Eff. 98

RAAA HerdBuilder index: 179 (Top 34% of RA breed)
 RAAA GridMaster index: 45 (Top 91% of RA breed)
 Sire Beef Tenderness: 9 'Outstanding'
 Calv.Ease BW WW YW Milk HPG Stay Maint.En.
 EPDs 18 -4.7 46 70 25 12 16 -5.0
 Marb +.32 REA -.21 Bfat +.03

★★★★★ for Low Maintenance, Marbling, Calving Ease, Stayability.

• Bulls •

188 BECKTON ACCENT G204 L5
1-A 100% # 4171720 Tat.: BSF9 G204



Birth: 3-15-19

Beckton Accent A175 O3
Beckton Lana R214 RA
Beckton Nebula EN S347
Beckton Eola S317 LO
Beckton Likable S633
Beckton Kit S478 LN
Beckton Emperor T641 E2
Beckton Belga M050 EP

BECKTON ACCENT E333 N4
Ref. A-7

BECKTON BELGA E529 L

DAM
Age 2
Wt 765
Prog.BW 55
WR 110
YR 103
Wean Pct. 56%
Cow Eff. 118

RAAA HerdBuilder index: **193** (Top 14% of RA breed)
RAAA GridMaster index: **47** (Top 55% of RA breed)
Sire Beef Tenderness: **10** 'Outstanding'
Calv.Ease BW WW YW Milk HPG Stay Maint.En.
EPDs **19 -3.9 58 89 25 10 17 -6.0**

Marb **+0.34** REA **+0.06** Bfat **+0.04**

190 BECKTON NEBULA G722 E4
1-A 100% # 4171418 Tat.: BSF9 G722



Birth: 4-22-19

Beckton Nebula P P707
Beckton Lana M809 EP
Beckton Justice CH M056
Beckton Larkaba P645 JL
Beckton Epic K6 S569
Beckton Lana M393 LN
Beckton Dominor ZC M919
Beckton Maiata P892 JL

BECKTON NEBULA B557 J3
Ref. N-4

BECKTON MAIATA B185 E

DAM
Age 5
Wt 1050
Prog.BW 70
WR 107
YR 98
Wean Pct. 49%
Cow Eff. 104

RAAA HerdBuilder index: **207** (Top 5% of RA breed)
RAAA GridMaster index: **48** (Top 43% of RA breed)
Sire Beef Tenderness: **6** 'Average'
Calv.Ease BW WW YW Milk HPG Stay Maint.En.
EPDs **15 -3.9 48 78 29 10 20 -3.0**

Marb **+0.49** REA **-0.07** Bfat **+0.04**

★★★★★ for Low Maintenance, Marbling, Superior Cow, High Cow Efficiency, Calving Ease, Stayability.

★★★★★ for Low Maintenance, Marbling, Calving Ease, Stayability.

189 BECKTON EPIC G740 H7
1-A 100% # 4170576 Tat.: BKT9 G740



Birth: 4-26-19

Beckton Epic U749 D5
Beckton Denise R308 DM
Beckton Epic K6 S569
Beckton Indigo S016 NB
Basin Hobo 0545
Basin Rose 06T0
Beckton Epic X330 L6
Beckton Larkeisa X091 L

BECKTON EPIC Z674 E6
Ref. E-1

BECKTON LARKEISA C288 H

DAM
Age 4
Wt 1075
Prog.BW 72
WR 107
YR 103
Wean Pct. 51%
Cow Eff. 107

RAAA HerdBuilder index: **155** (Top 75% of RA breed)
RAAA GridMaster index: **47** (Top 60% of RA breed)
Sire Beef Tenderness: **10** 'Outstanding'
Calv.Ease BW WW YW Milk HPG Stay Maint.En.
EPDs **15 -2.5 59 94 25 9 14 1.0**

Marb **+0.35** REA **-0.11** Bfat **+0.05**

191 BECKTON LEGEND G064 A4
1-A 100% # 4170976 Tat.: BKT9 G064



Birth: 2-28-19

Beckton Legend C313 C2
Beckton Legend S670
Beckton Minola W808 C
Beckton Epic A286 E7
Beckton Emera C066 E
Beckton Emera A029 D
Beckton Accent W180 C2
Beckton Lana R214 RA
Beckton Epic X330 L6
Beckton Larkeisa X091 L

BECKTON LEGEND E032 E3
Ref. L-6

BECKTON LARKEISA E239 A

DAM
Age 2
Wt 855
Prog.BW 57
WR 101
YR 101
Wean Pct. 46%
Cow Eff. 96

RAAA HerdBuilder index: **188** (Top 20% of RA breed)
RAAA GridMaster index: **49** (Top 29% of RA breed)
Sire Beef Tenderness: **7** 'Very Good'
Calv.Ease BW WW YW Milk HPG Stay Maint.En.
EPDs **19 -3.9 56 93 24 10 16 -4.0**

Marb **+0.36** REA **+0.09** Bfat **+0.04**

★★★★★ for Low Maintenance, Marbling, Calving Ease, Stayability.

★★★★★ for Low Maintenance, Marbling, Calving Ease, Stayability.



Lot 189

192 BECKTON CARDINAL G716 N2
1-A 100% # PENDING Tat.: BKT9 G716



Birth: 4-21-19

TR Double Eagle ZT220
Beckton Lana U182 JC
Beckton Legend U331 E2
Beckton Larkaba T418 WA
Beckton Nebula T398 V3
Beckton Mona X022 L
Beckton Nebula W486 D3
Beckton Tara W011 N

BECKTON CARDINAL E673 L
Ref. C-6

BECKTON TARA D403 N

DAM
Age 3
Wt 1065
Prog.BW 58
WR 105
YR 100
Wean Pct. 46%
Cow Eff. 97

RAAA HerdBuilder index: **NA** (Top 3% of RA breed)
RAAA GridMaster index: **0** (Top 33% of RA breed)
Sire Beef Tenderness: **6** 'Average'
Calv.Ease BW WW YW Milk HPG Stay Maint.En.
EPDs **19.5 -5.5 51.5 82.5 20.5 14 19 -2.0**

Marb **+0.41** REA **+0.16** Bfat **+0.04**

★★★★★ for Low Maintenance, Marbling, Rib-eye area, Calving Ease, Stayability.

• Bulls •

193 BECKTON NEW ERA G489 N3
1-A 100% # 4171454 Tat.: BSF9 G489



Birth: 3-30-19

Beckton New Era Y194
BECKTON NEW ERA C209 J2
 Ref. N-5
 Beckton Minerva Y116 J

Beckton Nebula P P707
 BKT Larkeisa T310 JC
 Beckton Julian W743 H5
 Beckton Minerva W081 N
 Beckton Nebula P P707
 BKT Larkeisa T310 JC
 Beckton Legend S670
 Beckton Lana T148 NB

BWt 88
 WR 87
 YWt. 906
 YR 87
 Feb.ADG 3.10
 Feb.Scr. 33
 Fr. 5.0

Beckton New Era Y194
BECKTON LANA B418 N
 Beckton Lana X556 L

DAM
 Age 5
 Wt 1160
 Prog.BW 76
 WR 87
 YR 85
 Wean Pct. 41%
 Cow Eff. 86

RAAA HerdBuilder index: 179 (Top 35% of RA breed)
 RAAA GridMaster index: 47 (Top 70% of RA breed)
 Sire Beef Tenderness: 10 'Outstanding'
 Calv.Ease BW WW YW Milk HPG Stay Maint.En.
 EPDs 13 -1.8 52 80 22 12 19 -4.0

Marb +.39 REA -.22 Bfat +.03

★★★★★ for Low Maintenance, Marbling, Calving Ease, Stayability.

195 BSF ACCENT G070 S5
1-B 99% # 4171862 Tat.: BSF9 G070



Birth: 3-2-19

Beckton Accent B740 W3
BECKTON ACCENT E492 N4
 Ref. A-8
 BKT Pine Marie Z177 N

Beckton Accent W180 C2
 Beckton Lana Y033 W
 Beckton Nebula X096 N4
 BKT Pine Marie X540 H
 Beckton Scamp X458 H3
 Beckton Lydia W178 C
 Beckton Legend U331 E2
 BSF Justicia Z267 N

BWt 67
 WR 104
 YWt. 913
 YR 104
 Feb.ADG 3.15
 Feb.Scr. 34
 Fr. 5.5

Beckton Scamp C349 C4
BSF JUSTICIA E088 S
 BSF Justicia C281 L

DAM
 Age 2
 Wt 800
 Prog.BW 67
 WR 104
 YR 104
 Wean Pct. 48%
 Cow Eff. 101

RAAA HerdBuilder index: 178 (Top 35% of RA breed)
 RAAA GridMaster index: 48 (Top 41% of RA breed)
 Sire Beef Tenderness: 6 'Average'
 Calv.Ease BW WW YW Milk HPG Stay Maint.En.
 EPDs 17 -3.2 58 92 25 12 15 -3.0

Marb +.34 REA +.08 Bfat +.03

★★★★★ for Low Maintenance, Marbling, Superior Cow, Calving Ease, Stayability.

194 BECKTON WARRIOR G023 W8
1-A 100% # 4171094 Tat.: BKT9 G023



Birth: 2-19-19

Beckton Warrior C695 W6
BECKTON WARRIOR E215 E7
 Ref. W-2
 Beckton Suffeina C124 E

Beckton Warrior Y108 E5
 Beckton Lana Y033 W
 Beckton Emperor A165 W4
 Beckton Suffeina A439 N
 Beckton Warrior Y108 E5
 Beckton Christy T749 HT
 Beckton Scamp A627 J4
 Beckton Larkaba A751 L

BWt 49
 WR 100
 YWt. 925
 YR 101
 Feb.ADG 3.32
 Feb.Scr. 34
 Fr. 5.0

Beckton Warrior C237 H6
BECKTON LARKABA E004 W
 Beckton Larkaba C279 S

DAM
 Age 2
 Wt 890
 Prog.BW 49
 WR 100
 YR 101
 Wean Pct. 44%
 Cow Eff. 92

RAAA HerdBuilder index: 153 (Top 77% of RA breed)
 RAAA GridMaster index: 47 (Top 55% of RA breed)
 Sire Beef Tenderness: 7 'Very Good'
 Calv.Ease BW WW YW Milk HPG Stay Maint.En.
 EPDs 20 -6.5 51 85 26 12 12 -5.0

Marb +.39 REA -.20 Bfat +.04

★★★★★ for Low Maintenance, Marbling, Calving Ease.



Lot 195



Lot 194

196 BECKTON CARDINAL G255 C2
1-A 100% # 4171536 Tat.: BSF9 G255



Birth: 3-18-19

TR Double Eagle ZT220
BECKTON CARDINAL B074 N
 Ref. C-1
 BKT Pine Marie Z250 N

TR Ricardo DOS
 Beckton Lana U182 JC
 Beckton Nebula J R475
 BKT Pine Marie U621 NB
 Beckton Clifftop W692 E3
 Beckton Lana W240 C
 Beckton Jet L P491
 Beckton Lana S866 CH

BWt 64
 WR 118
 YWt. 946
 YR 97
 Feb.ADG 2.45
 Feb.Scr. 35
 Fr. 5.0

Beckton Clifftop Y012 C4
BECKTON LANA C739 C
 Beckton Lana W314 J

DAM
 Age 4
 Wt 1000
 Prog.BW 64
 WR 118
 YR 104
 Wean Pct. 58%
 Cow Eff. 121

RAAA HerdBuilder index: 185 (Top 24% of RA breed)
 RAAA GridMaster index: 46 (Top 86% of RA breed)
 Sire Beef Tenderness: 9 'Outstanding'
 Calv.Ease BW WW YW Milk HPG Stay Maint.En.
 EPDs 21 -6.7 48 73 27 10 16 -6.0

Marb +.35 REA -.07 Bfat +.04

★★★★★ for Low Maintenance, Marbling, Superior Cow, High Cow Efficiency, Calving Ease, Stayability.

• Bulls •

197 BECKTON ACCENT G162 A3
1-A 100% # 4170296 Tat.: BKT9 G162



Birth: 3-12-19

Beckton Cody K1 P014
Beckton Rose M126 WR
Beckton Cherokee N N479
Beckton Christy N740 HR
Beckton Cody K1 P014
Beckton Christy R046 CQ
Beckton Loki CL S284
Beckton Lakme M669 EP

BECKTON ACCENT W180 C2
Ref. A-1

BECKTON LAKME Y027 A

DAM
Age 8
Wt 1200
Prog.BW 61
WR 94
YR 97
Wean Pct. 42%
Cow Eff. 88

RAAA HerdBuilder index: **227** (Top 1% of RA breed)
RAAA GridMaster index: **44** (Top 98% of RA breed)
Sire Beef Tenderness: **9** 'Outstanding'
Calv.Ease BW WW YW Milk HPG Stay Maint.En.
EPDs **21 -6.6 50 71 24 13 22 -2.0**

Marb **+.28** REA **-.06** Bfat **+.03**

BWt 58
WR 99
YWt. 857
YR 88
Feb.ADG 2.55
Feb.Scr. 34
Fr. 4.5

★★★★★ for Low Maintenance, Marbling, Calving Ease, Stayability.

199 BECKTON EPIC G543 E7
2 100% # 4170166 Tat.: BKT9 G543



Birth: 4-2-19

Beckton Epic U749 D5
Beckton Denise R308 DM
Beckton Epic K6 S569
Beckton Indigo S016 NB
Beckton Epic KM M115
Beckton Sierra N703 LM
Beckton Nebula P P707
Beckton Indigo P062 NB

BECKTON EPIC Z674 E6
Ref. E-1

BECKTON INDIGO U504 EP

DAM
Age 11
Wt 1000
Prog.BW 75
WR 114
YR 110
Wean Pct. 53%
Cow Eff. 111

RAAA HerdBuilder index: **170** (Top 51% of RA breed)
RAAA GridMaster index: **47** (Top 51% of RA breed)
Sire Beef Tenderness: **10** 'Outstanding'
Calv.Ease BW WW YW Milk HPG Stay Maint.En.
EPDs **17 -4.1 51 85 29 9 15 -7.0**

Marb **+.51** REA **-.36** Bfat **+.06**

BWt 63
WR 100
YWt. 994
YR 96
Feb.ADG 2.85
Feb.Scr. 33
Fr. 5.0

★★★★★ for Low Maintenance, Marbling, Superior Cow, Calving Ease, Stayability.

198 BECKTON LIKABLE G271 L4
1-A 100% # 4170714 Tat.: BKT9 G271



Birth: 3-19-19

Beckton Likable U130 L2
Beckton Roman J S158
Beckton Tamara R834 JC
Beckton Loki CL S284
Beckton Vernice T447 HT
Beckton Nebula T398 V3
BKT Pine Marie W404 J

BECKTON LIKABLE C229 R3
Ref. L-4

BECKTON PINE MARIE D634 L

DAM
Age 3
Wt 815
Prog.BW 61
WR 101
YR 98
Wean Pct. 58%
Cow Eff. 122

RAAA HerdBuilder index: **196** (Top 11% of RA breed)
RAAA GridMaster index: **47** (Top 59% of RA breed)
Sire Beef Tenderness: **9** 'Outstanding'
Calv.Ease BW WW YW Milk HPG Stay Maint.En.
EPDs **17 -4.1 55 85 25 9 19 -6.0**

Marb **+.28** REA **+.11** Bfat **+.04**

BWt 64
WR 101
YWt. 1014
YR 101
Feb.ADG 3.33
Feb.Scr. 33
Fr. 5.0

★★★★★ for Low Maintenance, Marbling, High Cow Efficiency, Calving Ease, Stayability.

200 BECKTON NEBULA G488 W6
100% # not reg. Tat.: BSF9 G488



Birth: 3-30-19

Beckton Nebula M045
Beckton Neptune R2 K065
Beckton Belga K285 JL
Beckton Epic K F075
Bkt Pine Marie D126 JL
Beckton Warrior W534 N4
Beckton Susan W058 E
Beckton Nebula M045
Beckton Lana P073 EP

BECKTON NEBULA E P084
Ref. N-2

BECKTON LANA C819 W

DAM
Age 4
Wt 1175
Prog.BW 65
WR 100
YR 95
Wean Pct. 45%
Cow Eff. 94

RAAA HerdBuilder index: **190** (Top 18% of RA breed)
RAAA GridMaster index: **46** (Top 84% of RA breed)
Sire Beef Tenderness: **7** 'Very Good'
Calv.Ease BW WW YW Milk HPG Stay Maint.En.
EPDs **20 -7.5 43 72 27 13 17 -5.0**

Marb **+.35** REA **-.29** Bfat **+.07**

BWt 65
WR 100
YWt. 986
YR 95
Feb.ADG 2.80
Feb.Scr. 35
Fr. 5.0

★★★★★ for Low Maintenance, Marbling, Calving Ease, Stayability.



Lot 198

201 BECKTON WARRIOR G502 N7
1-A 100% # 4170328 Tat.: BKT9 G502



Birth: 3-30-19

Beckton Warrior Y108 E5
Beckton Warrior W534 N4
Beckton Susan W058 E
Beckton Loki CL S284
Beckton Lana R327 EP
Beckton Nebula M045
Beckton Larkeisa M138 JC
Beckton Vega P079
Beckton Marta K386 EP

BECKTON WARRIOR D359 L6
Ref. W-1

BECKTON MARTA Z204 N

DAM
Age 7
Wt 1175
Prog.BW 67
WR 104
YR 103
Wean Pct. 42%
Cow Eff. 89

RAAA HerdBuilder index: **186** (Top 23% of RA breed)
RAAA GridMaster index: **46** (Top 82% of RA breed)
Sire Beef Tenderness: **9** 'Outstanding'
Calv.Ease BW WW YW Milk HPG Stay Maint.En.
EPDs **20 -6.1 44 71 28 14 16 -2.0**

Marb **+.29** REA **-.11** Bfat **+.04**

BWt 57
WR 91
YWt. 960
YR 93
Feb.ADG 3.28
Feb.Scr. 37
Fr. 5.0

★★★★★ for Low Maintenance, Marbling, Calving Ease, Stayability.

• Bulls •

202 BECKTON DOMINOR G699 E8
1-A 100% # 4170180 Tat.: BKT9 G699 

Birth: 4-18-19

Beckton Dominor Y005 V6
BECKTON DOMINOR A378 W7
 Ref. D-1 Beckton Lana Y541 W

Beckton Emcee S466
BECKTON SERENA W366 E
 Beckton Serena N088 WR

Beckton Dominor W640 C5
 Beckton Belga W108 V
 Beckton Warrior T248 L5
 Beckton Lana S074 EP
 Beckton Epic K4 N795
 Beckton Larkaba H798 WR
 Beckton Warrior TD L493
 Beckton Serena L591 VG

BWt 73
 WR 104
 YWt. 1019
 YR 98
 Feb.ADG 3.01
 Feb.Scr. 37
 Fr. 5.0

DAM
 Age 10
 Wt 1045
 Prog.BW 64
 WR 107
 YR 106
 Wean Pct. 54%
 Cow Eff. 114

RAAA HerdBuilder index: 157 (Top 72% of RA breed)
 RAAA GridMaster index: 47 (Top 57% of RA breed)
 Sire Beef Tenderness: 9 'Outstanding'
 Calv.Ease BW WW YW Milk HPG Stay Maint.En.
 EPDs 19 -4.4 41 73 32 9 13 -7.0

Marb +.38 REA -.09 Bfat +.03

205 BECKTON CLIFFTOP G301 L7
1-A 100% # 4170722 Tat.: BKT9 G301 

Birth: 3-21-19

Beckton Clifftop C572 N5
BECKTON CLIFFTOP E077 L6
 Ref. C-4 Beckton Larkaba C217 L

Beckton Likable B154 W4
BECKTON TAMARA D069 L
 Beckton Tamara B188 N

Beckton Clifftop Y012 C4
 BKT Pine Marie U454 NB
 Beckton Legend S670
 Beckton Larkaba U062 CB
 Beckton Likable Y124 L3
 Beckton Christy W429 W
 Beckton Nebula W486 D3
 Beckton Tamara S729 CT

BWt 73
 WR 107
 YWt. 973
 YR 101
 Feb.ADG 3.44
 Feb.Scr. 36
 Fr. 5.0

DAM
 Age 3
 Wt 815
 Prog.BW 65
 WR 107
 YR 101
 Wean Pct. 59%
 Cow Eff. 124

RAAA HerdBuilder index: 193 (Top 15% of RA breed)
 RAAA GridMaster index: 47 (Top 55% of RA breed)
 Sire Beef Tenderness: 4 'Poor'
 Calv.Ease BW WW YW Milk HPG Stay Maint.En.
 EPDs 17 -3.5 56 88 21 14 18 -5.5

Marb +.38 REA -.06 Bfat +.04

★★★★★ for Low Maintenance, Marbling, Superior Cow, Calving Ease, Stayability.

★★★★★ for Low Maintenance, Marbling, High Cow Efficiency, Calving Ease, Stayability.

203 BECKTON ACCENT G663 S4
1-A 100% # 4170672 Tat.: BKT9 G663 

Birth: 4-14-19

Beckton Accent U777 C2
BECKTON ACCENT B653 C3
 Ref. A-4 Beckton Christy W779 C

Beckton Scamp A626 H3
BECKTON SUSAN C047 S
 Beckton Susan A112 S

Beckton Cody K1 P014
 Beckton Susan R022 CQ
 BKT Clifftop TP R288
 Beckton Christy S151 NB
 Beckton Scamp T A825
 Beckton Rose T770 HI
 Beckton Scamp X494 E3
 Beckton Susan T199 CT

BWt 57
 WR 100
 YWt. 1009
 YR 97
 Feb.ADG 3.12
 Feb.Scr. 36
 Fr. 5.5

DAM
 Age 4
 Wt 950
 Prog.BW 61
 WR 106
 YR 104
 Wean Pct. 55%
 Cow Eff. 116

RAAA HerdBuilder index: 159 (Top 70% of RA breed)
 RAAA GridMaster index: 46 (Top 84% of RA breed)
 Sire Beef Tenderness: 10 'Outstanding'
 Calv.Ease BW WW YW Milk HPG Stay Maint.En.
 EPDs 20 -5.1 46 75 28 11 14 -7.0

Marb +.28 REA -.26 Bfat +.03

★★★★★ for Low Maintenance, Marbling, Superior Cow, High Cow Efficiency, Calving Ease, Stayability.

206 BECKTON WARRIOR G497 A7
1-A 100% # 4171682 Tat.: BSF9 G497 

Birth: 3-30-19

Beckton Scamp A627 J4
BECKTON SCAMP D325 N5
 Ref. S-1 Beckton Tamara Y039 N

Beckton Accent U777 C2
BECKTON CHRISTY D793 A
 Beckton Christy Z191 N

Beckton Scamp X494 E3
 Beckton Serena R023 JC
 Beckton Nebula W065 C3
 Beckton Tamara W232 J
 Beckton Cody K1 P014
 Beckton Susan R022 CQ
 Beckton Nebula T269 E2
 Beckton Christy N626 LN

BWt 65
 WR 105
 YWt. 988
 YR 99
 Feb.ADG 3.12
 Feb.Scr. 34
 Fr. 5.0

DAM
 Age 3
 Wt 990
 Prog.BW 68
 WR 108
 YR 103
 Wean Pct. 50%
 Cow Eff. 105

RAAA HerdBuilder index: 163 (Top 63% of RA breed)
 RAAA GridMaster index: 47 (Top 58% of RA breed)
 Sire Beef Tenderness: 10 'Outstanding'
 Calv.Ease BW WW YW Milk HPG Stay Maint.En.
 EPDs 18 -5.0 52 88 28 13 13 -8.0

Marb +.24 REA -.02 Bfat +.04

★★★★★ for Low Maintenance, Marbling, Superior Cow, Calving Ease, Stayability.

204 BECKTON EPIC G695 C7
1-A 100% # 4171506 Tat.: BSF9 G695 

Birth: 4-18-19

Beckton Epic U749 D5
BECKTON EPIC Z674 E6
 Ref. E-1 Beckton Indigo U504 EP

Beckton Clifftop Y012 C4
BECKTON LARKABEL C736 C
 Beckton Larkabel Y487 A

Beckton Epic K4 N795
 Beckton Denise R308 DM
 Beckton Epic K6 S569
 Beckton Indigo S016 NB
 Beckton Clifftop W692 E3
 Beckton Lana W240 C
 Beckton Accent W180 C2
 Beckton Larkabel W557 L

BWt 68
 WR 103
 YWt. 1007
 YR 97
 Feb.ADG 3.01
 Feb.Scr. 35
 Fr. 5.5

DAM
 Age 4
 Wt 900
 Prog.BW 65
 WR 102
 YR 100
 Wean Pct. 60%
 Cow Eff. 126

RAAA HerdBuilder index: 173 (Top 46% of RA breed)
 RAAA GridMaster index: 47 (Top 70% of RA breed)
 Sire Beef Tenderness: 10 'Outstanding'
 Calv.Ease BW WW YW Milk HPG Stay Maint.En.
 EPDs 19 -4.5 50 82 27 8 15 -5.0

Marb +.36 REA -.22 Bfat +.05

★★★★★ for Low Maintenance, Marbling, High Cow Efficiency, Calving Ease, Stayability.

207 WCRA ACCENT G140
1-A 100% #4149816 Tat.: WCRA9 GC14 

Birth: 3-10-19

Beckton Cody K1 P014
BECKTON ACCENT W180 C2
 Ref. A-1 Beckton Christy R046 CQ

Beckton Warrior Y108 E5
BECKTON SIERRA C254 W
 Beckton Sierra S065 LO

Beckton Cody KH M390
 Beckton Rose M126 WR
 Beckton Cherokee N N479
 Beckton Christy N740 HR
 Beckton Warrior W534 N4
 Beckton Susan W058 E
 Beckton Lasso P741
 Beckton Sierra P027 LN

BWt 66
 WR 102
 YWt. 901
 YR 101
 Feb.ADG 3.17
 Feb.Scr. 35
 Fr. 5.0

DAM
 Age 4
 Wt 1280
 Prog.BW 68
 WR 102
 YR 104
 Wean Pct. 39%
 Cow Eff. NA

RAAA HerdBuilder index: 194 (Top 14% of RA breed)
 RAAA GridMaster index: 47 (Top 65% of RA breed)
 Sire Beef Tenderness: 9 'Outstanding'
 Calv.Ease BW WW YW Milk HPG Stay Maint.En.
 EPDs 18 -4.7 53 87 27 12 18 -2.0

Marb +.25 REA +.08 Bfat +.04

★★★★★ for Low Maintenance, Marbling, Calving Ease, Stayability.

• Bulls •

208 BECKTON ACCENT G758 N3
1-A 100% # 4170230 Tat.: BKT9 G758 

Birth: 5-2-19

Beckton Accent U777 C2
Beckton Susan R022 CQ
Beckton Legend S670
Beckton Lana S371 DM
Beckton Nebula J R475
BKT Pine Marie R401 HU
Beckton Julian G3 P608
Beckton Minola P205 JC

BECKTON ACCENT B553 L2
Ref. A-3

BECKTON MINOLA X670 N
Beckton Nebula T054 H3
Beckton Minola S103 JL

BWt	66
WR	117
YWt.	1059
YR	108
Feb.ADG	3.01
Feb.Scr.	35
Fr.	5.0

DAM
Age 9
Wt 1095
Prog.BW 66
WR 107
YR 105
Wean Pct. 54%
Cow Eff. 113

RAAA HerdBuilder index: **171** (Top 49% of RA breed)
RAAA GridMaster index: **48** (Top 32% of RA breed)
Sire Beef Tenderness: **10** 'Outstanding'
Calv.Ease BW WW YW Milk HPG Stay Maint.En.
EPDs **19 -4.1 51 85 26 12 14 -3.0**
Marb **+0.49** REA **+0.01** Bfat **+0.03**

211 BECKTON LIKABLE G773 E5
1-A 100% # 4171800 Tat.: BSF9 G773 

Birth: 5-7-19

Beckton Likable Y124 L3
Beckton Lana X466 N
Beckton Epic A587 N7
Beckton Encino B362 N
Beckton Encino X448 L

BECKTON LIKABLE E391 N4
Ref. L-7

BECKTON ENCINO E639 E

BWt	71
WR	106
YWt.	984
YR	108
Feb.ADG	3.60
Feb.Scr.	31
Fr.	5.5

DAM
Age 2
Wt 805
Prog.BW 71
WR 106
YR 108
Wean Pct. 51%
Cow Eff. 108

RAAA HerdBuilder index: **211** (Top 4% of RA breed)
RAAA GridMaster index: **49** (Top 17% of RA breed)
Sire Beef Tenderness: **8** 'Very Good'
Calv.Ease BW WW YW Milk HPG Stay Maint.En.
EPDs **13 -1.4 63 105 22 11 20 -5.0**
Marb **+0.37** REA **-0.11** Bfat **+0.04**

★★★★★ for Low Maintenance, Growth, Marbling, Superior Cow, Calving Ease, Stayability.

★★★★★ for Low Maintenance, Growth, Marbling, Superior Cow, Calving Ease, Stayability.

209 BECKTON JULIAN G565 E4
1-A 100% # 4170622 Tat.: BKT9 G565 

Birth: 4-4-19

Beckton Julian GG B571
Bkt Marta 9A13 JL
Beckton Dominor 9455
Bkt Suffeina 9493 TT
Beckton Likable U120 L2
Beckton Lana N869 LO
Beckton Likable U120 L2
Beckton Mona W093 N

BECKTON JULIAN G3 P608
Ref. J-3

BECKTON MONA C184 L
Beckton Likable A306 L3
Beckton Mona A918 L

BWt	78
WR	96
YWt.	904
YR	87
Feb.ADG	2.04
Feb.Scr.	32
Fr.	5.0

DAM
Age 4
Wt 1075
Prog.BW 70
WR 108
YR 101
Wean Pct. 47%
Cow Eff. 99

RAAA HerdBuilder index: **182** (Top 29% of RA breed)
RAAA GridMaster index: **47** (Top 63% of RA breed)
Sire Beef Tenderness: **8** 'Very Good'
Calv.Ease BW WW YW Milk HPG Stay Maint.En.
EPDs **18 -4.3 39 57 26 12 17 -8.0**
Marb **+0.55** REA **-0.33** Bfat **+0.01**

★★★★★ for Low Maintenance, Marbling, Calving Ease, Stayability.

212 BECKTON ORACLE G028 A2
1-A 100% # 4170954 Tat.: BKT9 G028 

Birth: 2-20-19

Schuler Sudden Impact 0004X
Sor Marlee Cmmtrmt 0470X
Beckton Accent W180 C2
Beckton Emera Z775 C

SCHULER ORACLE-7142E
Ref. O-2

BECKTON EMERA E232 A

BWt	52
WR	85
YWt.	843
YR	92
Feb.ADG	3.12
Feb.Scr.	37
Fr.	5.0

DAM
Age 2
Wt 835
Prog.BW 52
WR 85
YR 92
Wean Pct. 39%
Cow Eff. 81

RAAA HerdBuilder index: **249** (Top 1% of RA breed)
RAAA GridMaster index: **50** (Top 7% of RA breed)
Sire Beef Tenderness: **10** 'Outstanding'
Calv.Ease BW WW YW Milk HPG Stay Maint.En.
EPDs **19 -3.9 55 90 24 9 23 0.0**
Marb **+0.74** REA **+0.01** Bfat **+0.03**

★★★★★ for Low Maintenance, Marbling, Calving Ease, Stayability.

210 BECKTON SCAMP G126 J6
1-A 100% # 4170314 Tat.: BKT9 G126 

Birth: 3-9-19

Beckton Scamp A627 J4
Beckton Serena R023 JC
Beckton Nebula W065 C3
Beckton Tamara W232 J
Beckton Julian GG B571
Bkt Marta 9A13 JL
Beckton Dominor ZC M919
BKT Larkeisa M816 EP

BECKTON SCAMP D325 N5
Ref. S-1

BECKTON LARKEISA Z238 J
Beckton Scamp X494 E3
Beckton Nebula W065 C3
Beckton Julian GG B571
Bkt Marta 9A13 JL
Beckton Dominor ZC M919
BKT Larkeisa M816 EP

BWt	62
WR	95
YWt.	877
YR	90
Feb.ADG	2.96
Feb.Scr.	37
Fr.	5.0

DAM
Age 7
Wt 1070
Prog.BW 63
WR 94
YR 93
Wean Pct. 45%
Cow Eff. 94

RAAA HerdBuilder index: **168** (Top 55% of RA breed)
RAAA GridMaster index: **47** (Top 56% of RA breed)
Sire Beef Tenderness: **10** 'Outstanding'
Calv.Ease BW WW YW Milk HPG Stay Maint.En.
EPDs **20 -6.3 45 75 26 11 14 -8.0**
Marb **+0.28** REA **-0.11** Bfat **+0.03**

★★★★★ for Low Maintenance, Marbling, Calving Ease, Stayability.

213 BECKTON EPIC G736 N7
1-A 100% # 4171598 Tat.: BSF9 G736 

Birth: 4-25-19

Beckton Epic U749 D5
Beckton Indigo U504 EP
Beckton Nebula B046 N5
Beckton Jane B220 L

BECKTON EPIC Z674 E6
Ref. E-1

BECKTON JANE D070 N

BWt	59
WR	107
YWt.	925
YR	96
Feb.ADG	2.53
Feb.Scr.	34
Fr.	5.5

DAM
Age 3
Wt 770
Prog.BW 51
WR 106
YR 101
Wean Pct. 62%
Cow Eff. 131

RAAA HerdBuilder index: **167** (Top 55% of RA breed)
RAAA GridMaster index: **47** (Top 59% of RA breed)
Sire Beef Tenderness: **10** 'Outstanding'
Calv.Ease BW WW YW Milk HPG Stay Maint.En.
EPDs **17 -3.9 55 87 26 10 14 -4.0**
Marb **+0.38** REA **-0.08** Bfat **+0.05**

★★★★★ for Low Maintenance, Marbling, High Cow Efficiency, Calving Ease, Stayability.

• Bulls •

214 BECKTON CLIFFTOP G438 E7
1-A 100% # PENDING Tat.: BKT9 G438 

Birth: 3-27-19

Beckton Clifftop C572 N5
Beckton Larkaba C217 L

BECKTON CLIFFTOP E077 L6
Ref. C-4

Beckton Epic A286 E7
Beckton Larkaba A751 L

BECKTON LARKABA E835 E

Beckton Clifftop Y012 C4
BKT Pine Marie U454 NB
Beckton Legend S670
Beckton Larkaba U062 CB
Beckton Epic Y484 N6
Beckton Larkaba Y648 E
Beckton Legend U331 E2
Beckton Larkaba W868 J

BWt 56
WR 108
YWt. 892
YR 102
Feb.ADG 3.12
Feb.Scr. 32
Fr. 5.0

DAM
Age 2
Wt 745
Prog.BW 56
WR 108
YR 102
Wean Pct. 54%
Cow Eff. 113

RAAA HerdBuilder index: **NA** (Top 5% of RA breed)
RAAA GridMaster index: **0** (Top 32% of RA breed)
Sire Beef Tenderness: **4** 'Poor'
Calv.Ease BW WW YW Milk HPG Stay Maint.En.
EPDs **19 -4.8 49.5 82 18.5 12 18 -6.5**
Marb **+4.2** REA **-.09** Bfat **+0.6**

★★★★★ for Low Maintenance, Marbling, Calving Ease, Stayability.

217 WCRA JULIAN G154
1-A 100% #4149838 Tat.: WCRA9 GC15 

Birth: 4-26-19

Beckton Julian X465 J5
Beckton Lakme T689 NX

BECKTON JULIAN A434 N6
Ref. J-4

Beckton Nebula P P707
Beckton Sierra C254 W

Beckton Julian G5 S107
Beckton Suffeina P643 JL
Beckton Nexus L016
Beckton Lakme M669 EP
Beckton Nebula M045
Beckton Lana M809 EP
Beckton Warrior Y108 E5
Beckton Sierra S065 LO

BWt 68
WR 110
YWt. 971
YR 109
Feb.ADG 3.33
Feb.Scr. 35
Fr. 5.5

DAM
Age 2
Wt 750
Prog.BW 68
WR 110
YR 110
Wean Pct. 73%
Cow Eff. NA

RAAA HerdBuilder index: **164** (Top 61% of RA breed)
RAAA GridMaster index: **49** (Top 24% of RA breed)
Sire Beef Tenderness: **7** 'Very Good'
Calv.Ease BW WW YW Milk HPG Stay Maint.En.
EPDs **15 -2.6 61 104 23 6.5 14 -2.0**
Marb **+4.8** REA **-.12** Bfat **+0.5**

★★★★★ for Low Maintenance, Growth, Marbling, Superior Cow, Calving Ease, Stayability.

215 BECKTON ACCENT G824 J4
1-A 100% # 4170194 Tat.: BKT9 G824 

Birth: 5-23-19

Beckton Accent W180 C2
Beckton Lana Y033 W

BECKTON ACCENT B740 W3
Ref. A-5

Beckton Julian G5 S107
Beckton Larkaba S663 JE

Beckton Cody K1 P014
Beckton Christy R046 CQ
Beckton Warrior W534 N4
Beckton Lana W370 E
Beckton Julian GJ P535
Beckton Minola P826 DM
Beckton Jules L429
Beckton Larkaba K530 EP

BWt 77
WR 105
YWt. 976
YR 100
Feb.ADG 3.17
Feb.Scr. 33
Fr. 5.0

DAM
Age 10
Wt 1125
Prog.BW 69
WR 103
YR 100
Wean Pct. 47%
Cow Eff. 99

RAAA HerdBuilder index: **172** (Top 47% of RA breed)
RAAA GridMaster index: **49** (Top 21% of RA breed)
Sire Beef Tenderness: **9** 'Outstanding'
Calv.Ease BW WW YW Milk HPG Stay Maint.En.
EPDs **16 -3.3 62 102 23 14 14 -4.0**
Marb **+3.1** REA **+0.9** Bfat **+0.4**

★★★★★ for Low Maintenance, Marbling, Calving Ease, Stayability.

218 BECKTON SCAMP G751 J6
1-A 100% # 4170830 Tat.: BKT9 G751 

Birth: 4-30-19

Beckton Scamp A627 J4
Beckton Tamara Y039 N

BECKTON SCAMP D325 N5
Ref. S-1

Beckton Julian Z382 J7
Beckton Coca D488 J

Beckton Scamp X494 E3
Beckton Serena R023 JC
Beckton Nebula W065 C3
Beckton Tamara W232 J
Beckton Julian X721 E6
Beckton Larkaba X064 J
Beckton Nebula X603 J4
Beckton Coca X701 N

BWt 54
WR 101
YWt. 927
YR 97
Feb.ADG 2.90
Feb.Scr. 31
Fr. 5.0

DAM
Age 3
Wt 950
Prog.BW 54
WR 95
YR 95
Wean Pct. 47%
Cow Eff. 100

RAAA HerdBuilder index: **201** (Top 8% of RA breed)
RAAA GridMaster index: **47** (Top 65% of RA breed)
Sire Beef Tenderness: **10** 'Outstanding'
Calv.Ease BW WW YW Milk HPG Stay Maint.En.
EPDs **22 -7.3 48 77 27 13 16 -10.0**
Marb **+2.7** REA **-.09** Bfat **+0.4**

★★★★★ for Low Maintenance, Marbling, Calving Ease, Stayability.

216 BECKTON LEGEND G167 C4
1-A 100% # 4171024 Tat.: BKT9 G167 

Birth: 3-12-19

Beckton Legend C313 C2
Beckton Emera C066 E

BECKTON LEGEND E032 E3
Ref. L-6

Beckton Cardinal B074 N
Beckton Coca A120 N

Beckton Legend S670
Beckton Minola W808 C
Beckton Epic A286 E7
Beckton Emera A029 D
TR Double Eagle ZT220
BKT Pine Marie Z250 N
Beckton Nebula Y002 C5
Beckton Coca Y190 J

BWt 46
WR 97
YWt. 848
YR 93
Feb.ADG 2.53
Feb.Scr. 33
Fr. 5.0

DAM
Age 2
Wt 715
Prog.BW 46
WR 97
YR 93
Wean Pct. 52%
Cow Eff. 110

RAAA HerdBuilder index: **207** (Top 5% of RA breed)
RAAA GridMaster index: **47** (Top 52% of RA breed)
Sire Beef Tenderness: **7** 'Very Good'
Calv.Ease BW WW YW Milk HPG Stay Maint.En.
EPDs **23 -6.5 48 80 24 11 17 -6.0**
Marb **+3.8** REA **-.15** Bfat **+0.4**

★★★★★ for Low Maintenance, Marbling, Calving Ease, Stayability.

219 BECKTON CARDINAL G174 C3
1-A 100% # 4170946 Tat.: BKT9 G174 

Birth: 3-13-19

Beckton Cardinal B074 N
Beckton Larkaba W868 J

BECKTON CARDINAL E381 J2
Ref. C-5

TR Double Eagle ZT220
Beckton Minerva E287 D

TR Double Eagle ZT220
BKT Pine Marie Z250 N
Beckton Julian G5 S107
Beckton Larkaba S663 JE
TR Ricardo DOS
Beckton Lana U182 JC
Beckton Julian W743 H5
Beckton Minerva W081 N

BWt 56
WR 106
YWt. 866
YR 99
Feb.ADG 2.74
Feb.Scr. 35
Fr. 5.0

DAM
Age 2
Wt 790
Prog.BW 56
WR 106
YR 99
Wean Pct. 49%
Cow Eff. 104

RAAA HerdBuilder index: **173** (Top 45% of RA breed)
RAAA GridMaster index: **47** (Top 51% of RA breed)
Sire Beef Tenderness: **7** 'Very Good'
Calv.Ease BW WW YW Milk HPG Stay Maint.En.
EPDs **17 -4.1 54 88 25 14 15 -4.0**
Marb **+3.4** REA **-.05** Bfat **+0.4**

★★★★★ for Low Maintenance, Marbling, Calving Ease, Stayability.

• Bulls •

220 BECKTON ACCENT G771 L4 1-A 100% # 4171524 Tat.: BSF9 G771 

Birth: 5-6-19

Beckton Accent U777 C2
BECKTON ACCENT B653 C3 Ref. A-4
 Beckton Christy W779 C

Beckton Cody K1 P014
 Beckton Susan R022 CQ
 BKT Clifftop TP R288
 Beckton Christy S151 NB
 Beckton Likable U130 L2
 Beckton Tamara M515 LN
 Beckton Nebula T398 V3
 Beckton Angel T004 CT

BWt 59
 WR 93
 YWt. 908
 YR 88
 Feb.ADG 2.69
 Feb.Scr. 33
 Fr. 5.0

BECKTON ANGEL C816 L
 Beckton Likable Y362 L3
 Beckton Angel X450 N

DAM
 Age 4
 Wt 915
 Prog.BW 62
 WR 98
 YR 97
 Wean Pct. 53%
 Cow Eff. 111

RAAA HerdBuilder index: 178 (Top 36% of RA breed)
 RAAA GridMaster index: 46 (Top 77% of RA breed)
 Sire Beef Tenderness: 10 'Outstanding'
 Calv.Ease BW WW YW Milk HPG Stay Maint.En.
 EPDs 18 -5.1 45 71 27 11 17 -8.0
 Marb +.38 REA -.24 Bfat +.04

★★★★★ for Low Maintenance, Marbling, Calving Ease, Stayability.

223 BECKTON DOMINOR G778 A8 1-A 100% # 4171648 Tat.: BSF9 G778 

Birth: 5-7-19

Beckton Dominor Y005 V6
BECKTON DOMINOR A378 W7 Ref. D-1
 Beckton Lana Y541 W

Beckton Dominor W640 C5
 Beckton Belga W108 V
 Beckton Warrior T248 L5
 Beckton Lana S074 EP
 Beckton Cody K1 P014
 Beckton Christy R046 CQ
 Beckton Justice C1 R483
 Beckton Christy R434 CD

BWt 70
 WR 89
 YWt. 904
 YR 94
 Feb.ADG 3.28
 Feb.Scr. 33
 Fr. 5.0

BECKTON CHRISTY D294 A
 Beckton Accent W180 C2
 Beckton Christy W827 J

DAM
 Age 3
 Wt 790
 Prog.BW 62
 WR 102
 YR 105
 Wean Pct. 50%
 Cow Eff. 104

RAAA HerdBuilder index: 205 (Top 6% of RA breed)
 RAAA GridMaster index: 48 (Top 32% of RA breed)
 Sire Beef Tenderness: 9 'Outstanding'
 Calv.Ease BW WW YW Milk HPG Stay Maint.En.
 EPDs 20 -4.4 43 77 30 14 17 -5.0
 Marb +.39 REA +.02 Bfat +.04

★★★★★ for Low Maintenance, Marbling, Calving Ease, Stayability.

221 BECKTON ACCENT G784 A4 1-A 100% # 4171404 Tat.: BSF9 G784 

Birth: 5-8-19

Beckton Accent W180 C2
BECKTON ACCENT B740 W3 Ref. A-5
 Beckton Lana Y033 W

Beckton Cody K1 P014
 Beckton Christy R046 CQ
 Beckton Warrior W534 N4
 Beckton Lana W370 E
 Beckton Accent W180 C2
 Beckton Lana W463 L
 Beckton Accent W180 C2
 Beckton Larkabel W557 L

BWt 66
 WR 90
 YWt. 902
 YR 87
 Feb.ADG 2.80
 Feb.Scr. 33
 Fr. 5.0

BECKTON LARKABEL A015 A
 Beckton Accent Y260 L3
 Beckton Larkabel Y487 A

DAM
 Age 6
 Wt 1005
 Prog.BW 64
 WR 102
 YR 99
 Wean Pct. 49%
 Cow Eff. 102

RAAA HerdBuilder index: 226 (Top 1% of RA breed)
 RAAA GridMaster index: 48 (Top 38% of RA breed)
 Sire Beef Tenderness: 9 'Outstanding'
 Calv.Ease BW WW YW Milk HPG Stay Maint.En.
 EPDs 19 -4.9 59 95 26 12 21 -6.0
 Marb +.39 REA +.06 Bfat +.04

★★★★★ for Low Maintenance, Marbling, Calving Ease, Stayability.

224 BECKTON SCAMP G614 A6 1-A 100% # 4170604 Tat.: BKT9 G614 

Birth: 4-9-19

Beckton Scamp A627 J4
BECKTON SCAMP D325 N5 Ref. S-1
 Beckton Tamara Y039 N

Beckton Scamp X494 E3
 Beckton Serena R023 JC
 Beckton Nebula W065 C3
 Beckton Tamara W232 J
 Beckton Cody K1 P014
 Beckton Christy R046 CQ
 Beckton Nebula T398 V3
 Beckton Indigo T298 JM

BWt 66
 WR 78
 YWt. 863
 YR 83
 Feb.ADG 3.17
 Feb.Scr. 32
 Fr. 5.0

BECKTON INDIGO C212 A
 Beckton Accent W180 C2
 Beckton Indigo W165 N

DAM
 Age 4
 Wt 1040
 Prog.BW 65
 WR 97
 YR 97
 Wean Pct. 39%
 Cow Eff. 82

RAAA HerdBuilder index: 188 (Top 20% of RA breed)
 RAAA GridMaster index: 46 (Top 78% of RA breed)
 Sire Beef Tenderness: 10 'Outstanding'
 Calv.Ease BW WW YW Milk HPG Stay Maint.En.
 EPDs 18 -5.2 43 70 28 13 17 -4.0
 Marb +.21 REA -.18 Bfat +.03

★★★★★ for Low Maintenance, Marbling, Calving Ease, Stayability.

222 BECKTON ACCENT G667 A4 1-A 100% # 4171796 Tat.: BSF9 G667 

Birth: 4-14-19

Beckton Accent W180 C2
BECKTON ACCENT E172 L3 Ref. A-6
 Beckton Indigo Y406 L

Beckton Cody K1 P014
 Beckton Christy R046 CQ
 Beckton Likable U130 L2
 Beckton Indigo R745 WR
 Beckton Accent U777 C2
 Beckton Christy W779 C
 Beckton Epic U749 D5
 Beckton Coca W362 J

BWt 63
 WR 106
 YWt. 873
 YR 100
 Feb.ADG 2.85
 Feb.Scr. 32
 Fr. 5.5

BECKTON COCA E867 A
 Beckton Accent B653 C3
 Beckton Coca B405 E

DAM
 Age 2
 Wt 825
 Prog.BW 63
 WR 106
 YR 100
 Wean Pct. 47%
 Cow Eff. 100

RAAA HerdBuilder index: 188 (Top 20% of RA breed)
 RAAA GridMaster index: 47 (Top 51% of RA breed)
 Sire Beef Tenderness: 9 'Outstanding'
 Calv.Ease BW WW YW Milk HPG Stay Maint.En.
 EPDs 14 -2.9 57 92 25 11 19 -3.0
 Marb +.29 REA +.05 Bfat +.04

★★★★★ for Low Maintenance, Marbling, Calving Ease, Stayability.

225 BECKTON NEBULA G597 E4 1-A 100% # 4171642 Tat.: BSF9 G597 

Birth: 4-7-19

Beckton Nebula P P707
BECKTON NEBULA B557 J3 Ref. N-4
 Beckton Larkaba T813 JC

Beckton Nebula M045
 Beckton Lana M809 EP
 Beckton Justice CH M056
 Beckton Larkaba P645 JL
 Beckton Epic U749 D5
 Beckton Lydia S069 NB
 Beckton Nebula T252 L3
 Beckton Lana T226 NB

BWt 63
 WR 82
 YWt. 855
 YR 86
 Feb.ADG 2.58
 Feb.Scr. 33
 Fr. 5.0

BECKTON LANA D890 E
 Beckton Epic Y484 N6
 Beckton Lana W113 N

DAM
 Age 3
 Wt 915
 Prog.BW 62
 WR 91
 YR 93
 Wean Pct. 41%
 Cow Eff. 87

RAAA HerdBuilder index: 200 (Top 9% of RA breed)
 RAAA GridMaster index: 49 (Top 21% of RA breed)
 Sire Beef Tenderness: 6 'Average'
 Calv.Ease BW WW YW Milk HPG Stay Maint.En.
 EPDs 15 -4.2 47 84 25 12 18 -5.0
 Marb +.44 REA -.14 Bfat +.04

★★★★★ for Low Maintenance, Marbling, Calving Ease, Stayability.

• Bulls •

226 BECKTON DOMINOR G841 C8 1-A 100% # 4170186 Tat.: BKT9 G841 

Birth: 5-30-19

Beckton Dominor Y005 V6 < Beckton Dominor W640 C5
Beckton Belga W108 V

BECKTON DOMINOR A378 W7 Ref. D-1 < Beckton Lana Y541 W < Beckton Warrior T248 L5
Beckton Lana S074 EP

Beckton Cody K1 P014 < Beckton Cody KH M390
Beckton Rose M126 WR

BECKTON TAMARA W550 A < Beckton Cherokee N N479
Beckton Tamara R175 CQ < Beckton Tamara N765 CO

BWt	92
WR	105
YWt.	934
YR	96
Feb.ADG	2.63
Feb.Scr.	33
Fr.	5.5

Age	10
Wt	1195
Prog.BW	72
WR	110
YR	107
Wean Pct.	45%
Cow Eff.	94

RAAA HerdBuilder index: **185** (Top 24% of RA breed)
RAAA GridMaster index: **49** (Top 23% of RA breed)
Sire Beef Tenderness: **9** 'Outstanding'
Calv.Ease BW WW YW Milk HPG Stay Maint.En.
EPDs **15 -1.4 52 90 30 13 16 -7.0**
Marb **+0.42** REA **-0.04** Bfat **+0.05**

228 BECKTON EPIC G646 N7 1-A 100% # 4170182 Tat.: BKT9 G646 

Birth: 4-12-19

Beckton Epic U749 D5 < Beckton Epic K4 N795
Beckton Denise R308 DM

BECKTON EPIC Z674 E6 Ref. E-1 < Beckton Indigo U504 EP < Beckton Epic K6 S569
Beckton Indigo S016 NB

Beckton Nebula EN S347 < Beckton Nebula E P084
Beckton Eola P530 NB

BECKTON LARKABA W272 N < Beckton Herald FJ J776
Beckton Larkaba N643 HR < Beckton Larkaba J765 CH

BWt	62
WR	100
YWt.	882
YR	90
Feb.ADG	2.39
Feb.Scr.	35
Fr.	5.0

Age	10
Wt	980
Prog.BW	64
WR	106
YR	103
Wean Pct.	51%
Cow Eff.	108

RAAA HerdBuilder index: **181** (Top 31% of RA breed)
RAAA GridMaster index: **45** (Top 94% of RA breed)
Sire Beef Tenderness: **10** 'Outstanding'
Calv.Ease BW WW YW Milk HPG Stay Maint.En.
EPDs **19 -5.7 43 68 31 12 16 -6.0**
Marb **+0.37** REA **-0.23** Bfat **+0.06**

★★★★★ for Low Maintenance, Marbling, Superior Cow, Calving Ease, Stayability.

★★★★★ for Low Maintenance, Marbling, Calving Ease, Stayability.

227 BECKTON DOMINOR G464 E9 1-A 100% # 4171464 Tat.: BSF9 G464 

Birth: 3-29-19

Beckton Dominor A378 W7 < Beckton Dominor Y005 V6
Beckton Lana Y541 W

BECKTON DOMINOR D254 N8 Ref. D-2 < Beckton Nebula T398 V3
Beckton Indigo W772 N < Beckton Indigo T613 JT

Beckton Epic X816 C6 < Beckton Epic T330 L5
Beckton Mona R198 CQ

BECKTON COCA B699 E < Beckton Likable U120 L2
Beckton Coca Y399 L < Beckton Coca H051 CH

BWt	78
WR	92
YWt.	878
YR	90
Feb.ADG	3.21
Feb.Scr.	35
Fr.	5.0

Age	5
Wt	NA
Prog.BW	74
WR	102
YR	99
Wean Pct.	NA%
Cow Eff.	NA

RAAA HerdBuilder index: **194** (Top 14% of RA breed)
RAAA GridMaster index: **47** (Top 63% of RA breed)
Sire Beef Tenderness: **10** 'Outstanding'
Calv.Ease BW WW YW Milk HPG Stay Maint.En.
EPDs **17 -3.4 41 66 30 12 18 -3.0**
Marb **+0.38** REA **-0.03** Bfat **+0.04**



Lot 228

★★★★★ for Low Maintenance, Marbling, Calving Ease, Stayability.



Lot 227

229 BECKTON ACCENT G772 L3 1-A 100% # 4170326 Tat.: BKT9 G772 

Birth: 5-6-19

Beckton Accent U777 C2 < Beckton Cody K1 P014
Beckton Susan R022 CQ

BECKTON ACCENT B553 L2 Ref. A-3 < Beckton Legend S670
Beckton Lana X839 L < Beckton Lana S371 DM

Beckton Likable U120 L2 < Beckton Likable S633
Beckton Lana S718 LN

BECKTON ROSE Z290 L < Beckton Nebula PJ S543
Beckton Rose U122 NB < Beckton Rose S106 HW

BWt	85
WR	104
YWt.	903
YR	92
Feb.ADG	2.23
Feb.Scr.	34
Fr.	5.0

Age	7
Wt	1340
Prog.BW	73
WR	98
YR	97
Wean Pct.	39%
Cow Eff.	82

RAAA HerdBuilder index: **176** (Top 40% of RA breed)
RAAA GridMaster index: **47** (Top 66% of RA breed)
Sire Beef Tenderness: **10** 'Outstanding'
Calv.Ease BW WW YW Milk HPG Stay Maint.En.
EPDs **14 -0.2 55 81 20 11 18 -3.0**
Marb **+0.44** REA **-0.10** Bfat **+0.03**

★★★★★ for Low Maintenance, Marbling, Calving Ease, Stayability.

• Bulls •



Lot 229

232 BSF DOMINOR G647 S8
1-B 99% # 4171448 Tat.: BSF9 G647

Birth: 4-12-19

Beckton Dominor Y005 V6
Beckton Belga W108 V

BECKTON DOMINOR A378 W7
Ref. D-1
Beckton Lana Y541 W
Beckton Warrior T248 L5
Beckton Lana S074 EP
Beckton Scamp T A825
Beckton Lana S074 EP

Beckton Scamp X494 E3
Beckton Likable U130 L2

BSF HUSTELLE B663 S
BSF Hustelle X278 L
BSF Hustelle U447 HH

BWt	73
WR	95
YWt.	925
YR	89
Feb.ADG	2.77
Feb.Scr.	36
Fr.	5.0

RAAA HerdBuilder index: **161** (Top 66% of RA breed)
RAAA GridMaster index: **47** (Top 56% of RA breed)
Sire Beef Tenderness: **9** 'Outstanding'
Calv.Ease BW WW YW Milk HPG Stay Maint.En.
EPDs **18 -3.8 41 66 30 13 13 -8.0**

Marb **+.40** REA **-.17** Bfat **+.03**

★★★★★ for Low Maintenance, Marbling, Calving Ease, Stayability.

230 BECKTON CLIFFTOP G381 L6
1-A 100% # 4171256 Tat.: BSF9 G381

Birth: 3-24-19

Beckton Clifftop Y012 C4
Beckton Lana W240 C

BECKTON CLIFFTOP C572 N5
Ref. C-3
BKT Pine Marie U454 NB
Beckton Nebula P P707
BKT Pine Marie N582 WR
Beckton Lancer F442 T
Beckton Legend S670
Beckton Kit F468 JL

BECKTON ENCINO X448 L
Beckton Encino S059 JT
Beckton Jet L P491
Beckton Encino P871 HR

BWt	69
WR	83
YWt.	851
YR	87
Feb.ADG	3.15
Feb.Scr.	32
Fr.	5.0

RAAA HerdBuilder index: **196** (Top 11% of RA breed)
RAAA GridMaster index: **46** (Top 82% of RA breed)
Sire Beef Tenderness: **7** 'Very Good'
Calv.Ease BW WW YW Milk HPG Stay Maint.En.
EPDs **19 -5.9 35 53 29 11 18 -6.0**

Marb **+.44** REA **-.25** Bfat **+.03**

★★★★★ for Low Maintenance, Marbling, Calving Ease, Stayability.

233 BECKTON EPIC G702 N7
1-A 100% # 4171414 Tat.: BSF9 G702

Birth: 4-19-19

Beckton Epic X464 L5
Beckton Epic K6 S569
Beckton Lana M393 LN

BECKTON EPIC B310 J6
Ref. E-2
Beckton Minerva Y116 J
Beckton Julian W743 H5
Beckton Minerva W081 N
Beckton Nebula M045
Beckton Lana M809 EP

BECKTON BARMAID B475 N
Beckton Barmaid R542 JE
Beckton Jules L429
Beckton Barmaid M296 EP

BWt	58
WR	103
YWt.	920
YR	94
Feb.ADG	3.10
Feb.Scr.	36
Fr.	5.0

RAAA HerdBuilder index: **184** (Top 26% of RA breed)
RAAA GridMaster index: **45** (Top 94% of RA breed)
Sire Beef Tenderness: **10** 'Outstanding'
Calv.Ease BW WW YW Milk HPG Stay Maint.En.
EPDs **19 -6.5 44 68 28 12 17 -1.0**

Marb **+.40** REA **-.25** Bfat **+.04**

★★★★★ for Low Maintenance, Marbling, Calving Ease, Stayability.

231 BECKTON HUGHES G002 C4
1-A 100% # 4171106 Tat.: BKT9 G002

Birth: 2-9-19

Beckton Hughes C463 N2
Bieber H Hughes W109
Beckton Lakme T689 NX

BECKTON HUGHES E261 S3
Ref. B-2
Beckton Lana C073 S
Beckton Scamp A627 J4
Beckton Lana A083 A

Beckton Clifftop C201 A5
Beckton Clifftop Y012 C4
Beckton Minola X198 A

BECKTON LARKEISA E013 C
Beckton Larkeisa C799 L
Beckton Likable Y362 L3
Beckton Larkeisa Z345 N

BWt	51
WR	95
YWt.	861
YR	94
Feb.ADG	2.94
Feb.Scr.	34
Fr.	5.0

RAAA HerdBuilder index: **174** (Top 44% of RA breed)
RAAA GridMaster index: **45** (Top 88% of RA breed)
Sire Beef Tenderness: **NA** NA
Calv.Ease BW WW YW Milk HPG Stay Maint.En.
EPDs **19 -5.7 47 74 27 10 15 -3.5**

Marb **+.43** REA **-.32** Bfat **+.04**

★★★★★ for Low Maintenance, Marbling, Calving Ease, Stayability.

234 BECKTON HUGHES G392 H3
1-A 100% # 4170696 Tat.: BKT9 G392

Birth: 3-25-19

Bieber H Hughes W109
Basin Hobo 0545
Basin Rose 06T0

BECKTON HUGHES C350 N2
Ref. B-1
Beckton Kit Z049 N
Beckton Nebula X353 E3
Beckton Kit X236 L

Beckton Clifftop C201 A5
Basin Hobo 0545
Basin Rose 06T0

BECKTON INDIGO D412 B
Beckton Indigo A297 S
Beckton Scamp T A825
Beckton Indigo W772 N

BWt	57
WR	95
YWt.	883
YR	88
Feb.ADG	2.61
Feb.Scr.	34
Fr.	5.0

RAAA HerdBuilder index: **186** (Top 23% of RA breed)
RAAA GridMaster index: **44** (Top 97% of RA breed)
Sire Beef Tenderness: **9** 'Outstanding'
Calv.Ease BW WW YW Milk HPG Stay Maint.En.
EPDs **18 -5.1 53 78 26 14 17 -3.0**

Marb **+.27** REA **-.10** Bfat **+.04**

★★★★★ for Low Maintenance, Marbling, Calving Ease, Stayability.

• Bulls •



Lot 235

236 BECKTON CLIFFTOP G640 A6
1-A 100% # 4170704 Tat.: BKT9 G640



Birth: 4-11-19

Beckton Clifftop Y012 C4
 Beckton Lana W240 C
 Beckton Nebula P F707
 BKT Pine Marie U454 NB
 BKT Pine Marie N582 WR
 Beckton Accent W180 C2
 Beckton Lana W463 L

BECKTON CLIFFTOP C572 N5
Ref. C-3

Beckton Accent Y260 L3
 Beckton Lana W463 L
 Beckton Heritage X356 E2
 Beckton Lana X059 E

BECKTON LANA D413 A
Beckton Lana A785 H

DAM	
Age	3
Wt	835
Prog.BW	63
WR	106
YR	99
Wean Pct.	55%
Cow Eff.	116

BWt	60
WR	103
YWt.	910
YR	95
Feb.ADG	2.77
Feb.Scr.	35
Fr.	5.5

RAAA HerdBuilder index: **185** (Top 25% of RA breed)
 RAAA GridMaster index: **47** (Top 59% of RA breed)
 Sire Beef Tenderness: **7** 'Very Good'
 Calv.Ease BW WW YW Milk HPG Stay Maint.En.
 EPDs **18 -5.4 47 77 29 9 17 -7.0**
 Marb **+0.49** REA **-0.19** Bfat **+0.05**

★★★★★ for Low Maintenance, Marbling, High Cow Efficiency, Calving Ease, Stayability.

235 BECKTON HUGHES G047 W4
1-A 100% # 4171084 Tat.: BKT9 G047



Birth: 2-24-19

Beckton Hughes C463 N2
 Bieber H Hughes W109
 Beckton Lakme T689 NX
 Beckton Scamp A627 J4
 Beckton Lana A083 A
 Beckton Warrior W534 N4
 Beckton Susan W058 E
 Beckton Ranger Z225 J4
 Beckton Lana Z730 J

BECKTON HUGHES E261 S3
Ref. B-2

Beckton Lana C073 S
 Beckton Warrior Y108 E5
 Beckton Susan W058 E
 Beckton Ranger Z225 J4
 Beckton Lana Z730 J

BECKTON LANA E278 W
Beckton Lana B028 R

DAM	
Age	2
Wt	670
Prog.BW	54
WR	98
YR	98
Wean Pct.	56%
Cow Eff.	118

BWt	54
WR	98
YWt.	895
YR	98
Feb.ADG	3.04
Feb.Scr.	35
Fr.	5.0

RAAA HerdBuilder index: **163** (Top 62% of RA breed)
 RAAA GridMaster index: **46** (Top 87% of RA breed)
 Sire Beef Tenderness: **NA** NA
 Calv.Ease BW WW YW Milk HPG Stay Maint.En.
 EPDs **21 -5.7 50 80 26 14 13 -5.5**
 Marb **+0.34** REA **-0.28** Bfat **+0.05**

★★★★★ for Low Maintenance, Marbling, High Cow Efficiency, Calving Ease, Stayability.



Lot 234

237 BECKTON LIKABLE G739 E4
1-A 100% # 4170674 Tat.: BKT9 G739



Birth: 4-26-19

Beckton Likable U130 L2
 Beckton Likable S633
 Beckton Kit S478 LN
 Beckton Roman J S158
 Beckton Tamara R834 JC
 Beckton Epic Y484 N6
 Beckton Larkaba Y648 E
 Beckton Nebula W778 J4
 Beckton Mona T809 NB

BECKTON LIKABLE C229 R3
Ref. L-4

Beckton Tamara X447 J
 Beckton Epic A286 E7
 Beckton Larkaba Y648 E
 Beckton Nebula W778 J4
 Beckton Mona T809 NB

BECKTON MONA C740 E
Beckton Mona A055 N

DAM	
Age	4
Wt	825
Prog.BW	57
WR	97
YR	92
Wean Pct.	61%
Cow Eff.	129

BWt	59
WR	96
YWt.	937
YR	90
Feb.ADG	2.61
Feb.Scr.	33
Fr.	5.0

RAAA HerdBuilder index: **188** (Top 21% of RA breed)
 RAAA GridMaster index: **45** (Top 87% of RA breed)
 Sire Beef Tenderness: **9** 'Outstanding'
 Calv.Ease BW WW YW Milk HPG Stay Maint.En.
 EPDs **19 -5.5 49 73 23 10 17 -4.0**
 Marb **+0.32** REA **-0.09** Bfat **+0.05**

★★★★★ for Low Maintenance, Marbling, High Cow Efficiency, Calving Ease, Stayability.



Lot 237

The Yearling Heifers



Beckton females are nearly ideal for today's industry – moderately sized, efficient producers. They combine calving ease, growth, and desirable carcass traits. They are feminine, maternal and quiet, with nice udders and sound feet. All of our heifer calves trailed up with their mothers into the Bighorn Mountains to spend their first summer. They have learned the meaning of mothering ability. And they have the productive capacity to produce

the bulls that you see in our sale. The sale heifers are a select group from the top of our replacements.

If you wish, we can also keep any sale heifers through the summer and breed them in natural service to the same herd sires we use with our own replacements. There will be a charge of \$250 per heifer plus delivery at cost in the fall. Visit with Cam about this program.



Beckton is offering two straws of P707 semen or any other sire (for which we have adequate supply) to go with every heifer purchased. The buyer will only be responsible for shipping from Billings, MT and semen may be used on any animal the buyer would like.

• Heifers •

301 **BECKTON LANA G444 J**
 1-A 100% # 4170454 Tattoo: BKT9 G444

Birth: 3-27-19

Beckton Julian 7526G < Beckton Julian 6592
 Bkt Belga 6746 GS

BECKTON JULIAN GG B571 BWT **66**
 Ref. J-2 < Beckton Julian 7526G
 Bkt Marta 9A13 JL < Bkt Marta 6498 XM WR **112**

Beckton Emperor Y459 J3 < Beckton Emperor T641 E2
 Beckton Indigo S354 JT YR **110**

BECKTON LANA A040 E Fr. **Med**
 Beckton Nebula T269 E2
 Beckton Lana Y561 N < Beckton Lana T104 CT

DAM	RAAA HerdBuilder index: 177 (Top 38% of RA breed)
Age 6	RAAA GridMaster index: 48 (Top 30% of RA breed)
Wt 1200	Sire Beef Tenderness: 8 'Very Good'
Prog.BW 78	Calv.Ease BW WW YW Milk HPG Stay Maint.En.
WR 114	EPDs 18 -4.8 54 83 24 12 15 -5.0
YR 111	Marb +0.38 REA -0.12 Bfat +0.04
Cow Eff. 90	



Lot 301 is an AI daughter of the great Beckton Julian B571 (Ref. sire J-2). ★★★★★ for Low Maintenance, Growth, Marbling, Superior Cow, Calving Ease, Stayability.

302 **BECKTON MINOLA G181 S**
 1-A 100% # 4171222 Tattoo: BSF9 G181

Birth: 3-13-19

Beckton Scamp A627 J4 < Beckton Scamp X494 E3
 Beckton Serena R023 JC

BECKTON SCAMP D325 N5 BWT **56**
 Ref. S-1 < Beckton Nebula W065 C3
 Beckton Tamara Y039 N < Beckton Tamara W232 J WR **106**

Beckton Dominor Z1 R610 < Beckton Dominor ZC M919 YR **107**
 Beckton Sierra K557 LO

BECKTON MINOLA W150 D Fr. **Med**
 Beckton Julian G1 J526
 Beckton Minola P611 JL < Beckton Minola K428 HD

DAM	RAAA HerdBuilder index: 187 (Top 22% of RA breed)
Age 10	RAAA GridMaster index: 47 (Top 63% of RA breed)
Wt 1200	Sire Beef Tenderness: 10 'Outstanding'
Prog.BW 69	Calv.Ease BW WW YW Milk HPG Stay Maint.En.
WR 106	EPDs 20 -6.2 50 82 27 13 16 -7.0
YR 103	Marb +0.24 REA -0.08 Bfat +0.04
Cow Eff. 85	

★★★★★ for Low Maintenance, Growth, Marbling, Superior Cow, Calving Ease, Stayability.

303 **BECKTON ENCINO G413 N**
 1-A 100% # 4171362 Tattoo: BSF9 G413

Birth: 3-26-19

Beckton New Era Y194 < Beckton Nebula P P707
 BKT Larkeisa T310 JC

BECKTON NEW ERA D478 C2 BWT **78**
 Ref. N-6 < Beckton Cherokee T450 L3
 Beckton Coca X734 C < Beckton Coca T080 NB WR **123**

Beckton Legend X561 J2 < Beckton Legend S670 YR **120**
 Beckton Lana T279 JO

BECKTON ENCINO Z514 L Fr. **Med**
 Beckton Nebula L P093
 Beckton Encino W287 N < Beckton Encino S303 LO

DAM	RAAA HerdBuilder index: 201 (Top 8% of RA breed)
Age 7	RAAA GridMaster index: 48 (Top 42% of RA breed)
Wt 1380	Sire Beef Tenderness: 10 'Outstanding'
Prog.BW 75	Calv.Ease BW WW YW Milk HPG Stay Maint.En.
WR 123	EPDs 13 -0.9 67 105 25 12 20 2.0
YR 115	Marb +0.35 REA -0.05 Bfat +0.04
Cow Eff. 86	

★★★★★ for Low Maintenance, Growth, Marbling, Superior Cow, Calving Ease, Stayability.



304 **BECKTON MINOLA G252 A**
 1-A 100% # 4171312 Tattoo: BSF9 G252

Birth: 3-18-19

Beckton Accent U777 C2 < Beckton Cody K1 P014
 Beckton Susan R022 CQ

BECKTON ACCENT B653 C3 BWT **86**
 Ref. A-4 < BKT Clifftop TP R288
 Beckton Christy W779 C < Beckton Christy S151 NB WR **111**

Beckton Nebula X096 N4 < Beckton Nebula U206 V3 YR **108**
 Beckton Tamara U185 NB

BECKTON MINOLA Z219 N Fr. **Med**
 Beckton Hasten U108 J3
 Beckton Minola X015 H < Beckton Minola U630 NB

DAM	RAAA HerdBuilder index: 175 (Top 41% of RA breed)
Age 7	RAAA GridMaster index: 48 (Top 36% of RA breed)
Wt 1096	Sire Beef Tenderness: 10 'Outstanding'
Prog.BW 73	Calv.Ease BW WW YW Milk HPG Stay Maint.En.
WR 106	EPDs 12 -0.6 64 103 24 12 17 -5.0
YR 103	Marb +0.31 REA -0.11 Bfat +0.04
Cow Eff. 88	

★★★★★ for Low Maintenance, Growth, Marbling, Superior Cow, Calving Ease, Stayability.

• Heifers •

305 **BECKTON ENCINO G142 A**
1-A 100% # 4171228 Tattoo: BSF9 G142

Birth: 3-10-19
 Beckton Accent U777 C2 < Beckton Cody K1 P014
 Beckton Susan R022 CQ
BECKTON ACCENT B653 C3
 Ref. A-4 < Beckton Christy W779 C < BKT Clifftop TP R288
 Beckton Christy S151 NB
 BWT **73**
 WR **106**
 YR **111**
 Fr. **Med**
 Beckton Hasten H S462 < Beckton Hasten P292
 Beckton Lakme G128 HD
BECKTON ENCINO W675 H
 Beckton Encino S090 JT < Beckton Jet L P491
 Beckton Encino P300 LN

DAM	RAAA HerdBuilder index: 185 (Top 24% of RA breed)									
Age 10	RAAA GridMaster index: 47 (Top 65% of RA breed)									
Wt 1025	Sire Beef Tenderness: 10 'Outstanding'									
Prog.BW 71	Calv.Ease	BW	WW	YW	Milk	HPG	Stay	Maint.En.		
WR 99	EPDs 16	-3.0	56	87	24	13	17	-9.0		
YR 98	Marb +0.27		REA -0.12		Bfat +0.03					
Cow Eff. 100										

★★★★★ for Low Maintenance, Growth, Marbling, Calving Ease, Stayability.

307 **BECKTON SIERRA G473 E**
1-A 100% # 4170264 Tattoo: BKT9 G473

Birth: 3-29-19
 Beckton Epic U749 D5 < Beckton Epic K4 N795
 Beckton Denise R308 DM
BECKTON EPIC Z674 E6
 Ref. E-1 < Beckton Indigo U504 EP < Beckton Epic K6 S569
 Beckton Indigo S016 NB
 BWT **69**
 WR **124**
 YR **118**
 Fr. **Med**
 Beckton Nebula T269 E2 < Beckton Nebula M045
 Beckton Ruth M967 EP
BECKTON SIERRA Y441 N
 Beckton Hawk P248
 Beckton Sierra S120 HW < Beckton Sierra P348 JO

DAM	RAAA HerdBuilder index: 167 (Top 56% of RA breed)									
Age 8	RAAA GridMaster index: 48 (Top 49% of RA breed)									
Wt 1085	Sire Beef Tenderness: 10 'Outstanding'									
Prog.BW 66	Calv.Ease	BW	WW	YW	Milk	HPG	Stay	Maint.En.		
WR 108	EPDs 15	-3.2	59	95	28	10	15	-5.0		
YR 102	Marb +0.34		REA -0.14		Bfat +0.05					
Cow Eff. 110										

★★★★★ for Low Maintenance, Growth, Marbling, Calving Ease, Stayability.



308 **BECKTON COCA G276 N**
1-A 100% # 4171508 Tattoo: BSF9 G276

Birth: 3-19-19
 Beckton New Era Y194 < Beckton Nebula P P707
 BKT Larkeisa T310 JC
BECKTON NEW ERA A908 A2
 Ref. N-3 < Beckton Lana U612 CD < Beckton Cody K1 P014
 Beckton Lana R327 EP
 BWT **67**
 WR **113**
 YR **107**
 Fr. **Med**
 Beckton Nebula X096 N4 < Beckton Nebula U206 V3
 Beckton Tamara U185 NB
BECKTON COCA C411 N
 Beckton Coca Y399 L < Beckton Likable U120 L2
 Beckton Coca H051 CH

DAM	RAAA HerdBuilder index: 199 (Top 9% of RA breed)									
Age 4	RAAA GridMaster index: 46 (Top 72% of RA breed)									
Wt 1184	Sire Beef Tenderness: 10 'Outstanding'									
Prog.BW 64	Calv.Ease	BW	WW	YW	Milk	HPG	Stay	Maint.En.		
WR 104	EPDs 14	-2.0	59	94	29	9	21	-4.0		
YR 104	Marb +0.34		REA -0.17		Bfat +0.03					
Cow Eff. 89										

★★★★★ for Low Maintenance, Growth, Marbling, Superior Cow, Calving Ease, Stayability.

306 **BECKTON BARMAID G359 N**
1-A 100% # 4171388 Tattoo: BSF9 G359

Birth: 3-23-19
 Beckton New Era Y194 < Beckton Nebula P P707
 BKT Larkeisa T310 JC
BECKTON NEW ERA C209 J2
 Ref. N-5 < Beckton Julian W743 H5 < Beckton Julian W743 H5
 Beckton Minerva Y116 J < Beckton Minerva W081 N
 BWT **84**
 WR **127**
 YR **122**
 Fr. **Lar**
 Beckton Janus X799 L2 < Beckton Roman J S158
 Beckton Sierra K557 LO
BECKTON BARMAID A123 O
 Beckton Nebula T398 V3
 Beckton Barmaid X654 N < Beckton Barmaid S758 DM

DAM	RAAA HerdBuilder index: 179 (Top 34% of RA breed)									
Age 6	RAAA GridMaster index: 49 (Top 25% of RA breed)									
Wt 1474	Sire Beef Tenderness: 10 'Outstanding'									
Prog.BW 63	Calv.Ease	BW	WW	YW	Milk	HPG	Stay	Maint.En.		
WR 108	EPDs 11	-0.5	67	110	23	11	19	4.0		
YR 107	Marb +0.34		REA +0.01		Bfat +0.04					
Cow Eff. 83										

★★★★★ for Low Maintenance, Growth, Marbling, Superior Cow, Calving Ease, Stayability.



• Heifers •



Not for sale

311 **BECKTON LANA G123 S**
1-A 100% # 4170190 Tattoo: BKT9 G123

Birth: 3-9-19	Beckton Scamp A627 J4	Beckton Scamp X494 E3	
		Beckton Serena R023 JC	
BECKTON SCAMP D325 N5	Ref. S-1	Beckton Nebula W065 C3	BWt 73
		Beckton Tamara W232 J	WR 105
		Beckton Nebula M045	YR 103
BECKTON LANA W696 N		Beckton Marta M021 LN	Fr. Med
		Beckton Loki C M740	
		Beckton Lana M372 WR	

DAM	RAAA HerdBuilder index: 178 (Top 36% of RA breed)									
Age 10	RAAA GridMaster index: 48 (Top 46% of RA breed)									
Wt 1000	Sire Beef Tenderness: 10 'Outstanding'									
Prog.BW 75	Calv.Ease	BW	WW	YW	Milk	HPG	Stay	Maint.En.		
WR 104	EPDs 15	-2.9	57	93	23	13	16	-9.0		
YR 101	Marb +0.20		REA -0.08		Bfat +0.03					
Cow Eff. 101										

★★★★★ for Low Maintenance, Marbling, Calving Ease, Stayability.

309 **BECKTON FIREFLY G172 A**
1-A 100% # 4171492 Tattoo: BSF9 G172

Birth: 3-13-19	Beckton Accent U777 C2	Beckton Cody K1 P014	
		Beckton Susan R022 CQ	
BECKTON ACCENT B653 C3	Ref. A-4	BKT Clifftop TP R288	BWt 70
		Beckton Christy S151 NB	WR 95
		Beckton Cody K1 P014	YR 104
BECKTON FIREFLY C599 A		Beckton Christy R046 CQ	Fr. Med
		TR Julian RT561	
		Beckton Firefly J650 CD	

DAM	RAAA HerdBuilder index: 187 (Top 22% of RA breed)									
Age 4	RAAA GridMaster index: 47 (Top 65% of RA breed)									
Wt 1010	Sire Beef Tenderness: 10 'Outstanding'									
Prog.BW 70	Calv.Ease	BW	WW	YW	Milk	HPG	Stay	Maint.En.		
WR 98	EPDs 16	-2.5	51	82	24	12	18	-4.0		
YR 103	Marb +0.31		REA -0.18		Bfat +0.04					
Cow Eff. 87										

★★★★★ for Low Maintenance, Marbling, Calving Ease, Stayability.



310 **BECKTON TARA G609 A**
1-A 100% # 4171294 Tattoo: BSF9 G609

Birth: 4-7-19	Beckton Accent U777 C2	Beckton Cody K1 P014	
		Beckton Susan R022 CQ	
BECKTON ACCENT B553 L2	Ref. A-3	Beckton Legend S670	BWt 72
		Beckton Lana S371 DM	WR 115
		Beckton Julian G5 S107	YR 117
BECKTON TARA Y111 J		Beckton Christy J743 JL	Fr. Med
		Beckton Loki CL S284	
		Beckton Tara R609 JC	

DAM	RAAA HerdBuilder index: 171 (Top 49% of RA breed)									
Age 8	RAAA GridMaster index: 48 (Top 36% of RA breed)									
Wt 1145	Sire Beef Tenderness: 10 'Outstanding'									
Prog.BW 70	Calv.Ease	BW	WW	YW	Milk	HPG	Stay	Maint.En.		
WR 106	EPDs 15	-2.5	56	92	25	14	15	-3.0		
YR 105	Marb +0.36		REA -0.07		Bfat +0.05					
Cow Eff. 97										

★★★★★ for Low Maintenance, Growth, Marbling, Superior Cow, Calving Ease, Stayability.

312 **BECKTON LARKABA G419 J**
1-A 100% # 4170556 Tattoo: BKT9 G419

Birth: 3-26-19	Beckton Javelin 6587	Beckton Trojan 5253	
		Beckton Ileximka -3	
BKT JAVELIN 7466 R	Ref. J-1	Beckton Raza 2308-N	BWt 69
		Bkt Baya Rose 5195	WR 113
		Beckton Julian GG B571	YR 106
BECKTON LARKABA B903 J		Beckton Ruth U325 WR	Fr. Med
		Beckton Nebula W022 D3	
		Beckton Larkaba U498 EP	

DAM	RAAA HerdBuilder index: 172 (Top 46% of RA breed)									
Age 5	RAAA GridMaster index: 47 (Top 69% of RA breed)									
Wt 1110	Sire Beef Tenderness: 6 'Average'									
Prog.BW 71	Calv.Ease	BW	WW	YW	Milk	HPG	Stay	Maint.En.		
WR 119	EPDs 16	-3.5	48	72	25	13	15	-7.0		
YR 111	Marb +0.29		REA -0.23		Bfat +0.02					
Cow Eff. 98										

★★★★★ for Low Maintenance, Growth, Marbling, Superior Cow, Calving Ease, Stayability.

• Heifers •



315 **BECKTON INDIGO G568 E**
1-A 100% # 4170422 Tattoo: BKT9 G568

Birth: 4-4-19	Beckton Epic U749 D5	Beckton Epic K4 N795	
		Beckton Denise R308 DM	
BECKTON EPIC Z674 E6			BWt 71
Ref. E-1	Beckton Indigo U504 EP	Beckton Epic K6 S569	WR 113
		Beckton Indigo S016 NB	YR 113
	Beckton Scamp T A825	Beckton Scamp 8954	Fr. Med
BECKTON INDIGO A297 S		BKT Encino 8459 TJ	
	Beckton Indigo W772 N	Beckton Nebula T398 V3	
		Beckton Indigo T613 JT	

DAM	RAAA HerdBuilder index: 166 (Top 58% of RA breed)
Age 6	RAAA GridMaster index: 48 (Top 42% of RA breed)
Wt 1065	Sire Beef Tenderness: 10 'Outstanding'
Prog.BW 66	Calv.Ease BW WW YW Milk HPG Stay Maint.En.
WR 108	EPDs 16 -2.8 55 91 27 11 14 -5.0
YR 107	Marb +0.32 REA -0.06 Bfat +0.05
Cow Eff. 102	

★★★★★ for Low Maintenance, Growth, Marbling, Superior Cow, Calving Ease, Stayability.

313 **BECKTON COCA G307 C**
1-A 100% # 4170200 Tattoo: BKT9 G307

Birth: 3-21-19	Beckton Clifftop Y012 C4	Beckton Clifftop W692 E3	
		Beckton Lana W240 C	
BECKTON CLIFFTOP C572 N5			BWt 71
Ref. C-3	BKT Pine Marie U454 NB	Beckton Nebula P P707	WR 101
		BKT Pine Marie N582 WR	YR 104
	Beckton Nebula T269 E2	Beckton Nebula M045	Fr. Med
BECKTON COCA W061 N		Beckton Ruth M967 EP	
	Beckton Coca T168 NB	Beckton Nebula M045	
		Beckton Coca H256 JL	

DAM	RAAA HerdBuilder index: 186 (Top 23% of RA breed)
Age 10	RAAA GridMaster index: 47 (Top 61% of RA breed)
Wt 958	Sire Beef Tenderness: 7 'Very Good'
Prog.BW 71	Calv.Ease BW WW YW Milk HPG Stay Maint.En.
WR 104	EPDs 15 -3.7 48 79 28 12 18 -7.0
YR 103	Marb +0.39 REA -0.28 Bfat +0.06
Cow Eff. 101	

★★★★★ for Low Maintenance, Marbling, Superior Cow, Calving Ease, Stayability.

316 **BECKTON MINOLA G132 H**
1-A 100% # 4171412 Tattoo: BSF9 G132

Birth: 3-10-19	Beckton Heritage A767 C3	Beckton Heritage X356 E2	
		Beckton Rose W816 C	
BECKTON HERITAGE D195 L4			BWt 69
Ref. H-1	Beckton Susan W846 L	Beckton Loki CL S284	WR 99
		Beckton Susan S684 JJ	YR 102
	Beckton New Era Y194	Beckton Nebula P P707	Fr. Sma
BECKTON MINOLA B292 N		BKT Larkeisa T310 JC	
	Beckton Minola N751 JL	Beckton Julian G1 J526	
		Beckton Minola J091 JL	

DAM	RAAA HerdBuilder index: 180 (Top 32% of RA breed)
Age 5	RAAA GridMaster index: 48 (Top 47% of RA breed)
Wt 1032	Sire Beef Tenderness: 10 'Outstanding'
Prog.BW 67	Calv.Ease BW WW YW Milk HPG Stay Maint.En.
WR 101	EPDs 16 -3.6 59 96 23 9 17 -3.0
YR 101	Marb +0.38 REA -0.16 Bfat +0.04
Cow Eff. 93	

★★★★★ for Low Maintenance, Marbling, Calving Ease, Stayability.

314 **BECKTON LARKEISA G688 N**
2 100% # 4170500 Tattoo: BKT9 G688

Birth: 4-17-19	Beckton New Era Y194	Beckton Nebula P P707	
		BKT Larkeisa T310 JC	
BECKTON NEW ERA C209 J2			BWt 76
Ref. N-5	Beckton Minerva Y116 J	Beckton Julian W743 H5	WR 104
		Beckton Minerva W081 N	YR 107
	Beckton Nebula W486 D3	Beckton Nebula L P093	Fr. Med
BECKTON LARKEISA B552 N		Beckton Belga R716 DM	
	Beckton Larkeisa X126 N	Beckton Nebula U060 N4	
		BKT Larkeisa U458 NB	

DAM	RAAA HerdBuilder index: 181 (Top 31% of RA breed)
Age 5	RAAA GridMaster index: 48 (Top 30% of RA breed)
Wt 1156	Sire Beef Tenderness: 10 'Outstanding'
Prog.BW 68	Calv.Ease BW WW YW Milk HPG Stay Maint.En.
WR 100	EPDs 14 -2.5 59 96 21 12 18 1.0
YR 103	Marb +0.44 REA -0.12 Bfat +0.04
Cow Eff. 87	

★★★★★ for Low Maintenance, Growth, Marbling, Calving Ease, Stayability.



• Heifers •

317 **BSF DOMINIQUE G130 W**
1-B 99% # 4171394 Tattoo: BSF9 G130

Birth: 3-9-19
 Beckton Warrior Y108 E5 < Beckton Warrior W534 N4
 Beckton Susan W058 E
BECKTON WARRIOR D359 L6
 Ref. W-1 < Beckton Lana W463 L
 Beckton Loki CL S284
 Beckton Lana R327 EP
 BWT **64**
 WR **100**
 YR **96**
 Fr. **Med**

DAM	RAAA HerdBuilder index: 193 (Top 15% of RA breed)
Age 6	RAAA GridMaster index: 46 (Top 77% of RA breed)
Wt 1110	Sire Beef Tenderness: 9 'Outstanding'
Prog.BW 65	Calv.Ease BW WW YW Milk HPG Stay Maint.En.
WR 93	EPDs 19 -4.8 55 85 22 11 18 -1.0
YR 98	Marb +0.30 REA -0.15 Bfat +0.04
Cow Eff. 86	

★★★★★ for Low Maintenance, Marbling, Calving Ease, Stayability.

319 **BECKTON ROSE G361 J**
1-A 100% # 4170580 Tattoo: BKT9 G361

Birth: 3-23-19
 Beckton Javelin 6587 < Beckton Trojan 5253
 Beckton Ileximka -3
BKT JAVELIN 7466 R
 Ref. J-1 < Beckton Raza 2308-N
 Bkt Baya Rose 5195
 WR **103**
 YR **98**
 Fr. **Sma**

DAM	RAAA HerdBuilder index: 180 (Top 32% of RA breed)
Age 4	RAAA GridMaster index: 46 (Top 86% of RA breed)
Wt 1098	Sire Beef Tenderness: 6 'Average'
Prog.BW 58	Calv.Ease BW WW YW Milk HPG Stay Maint.En.
WR 103	EPDs 19 -6.3 38 56 24 11 16 -10.0
YR 98	Marb +0.38 REA -0.35 Bfat +0.02
Cow Eff. 87	

★★★★★ for Low Maintenance, Marbling, Calving Ease, Stayability.



320 **BSF DOMINIQUE G532 L**
1-B 99% # 4171670 Tattoo: BSF9 G532

Birth: 4-1-19
 Redhill U199 Lancer 9B < Buf Crk The Right Kind U199
 Buf Crk Redpride P154
REDHILL 9B LANCER 11E
 Ref. O-1 < Buf Crk Nice N Easy T189
 Redhill T189 Barmaid 190W < 1BWW Barmaid 54P
 WR **108**
 YR **103**
 Fr. **Med**

DAM	RAAA HerdBuilder index: 194 (Top 13% of RA breed)
Age 3	RAAA GridMaster index: 48 (Top 46% of RA breed)
Wt 1016	Sire Beef Tenderness: 7 'Very Good'
Prog.BW 59	Calv.Ease BW WW YW Milk HPG Stay Maint.En.
WR 108	EPDs 12 -2.0 64 97 25 13 19 -1.0
YR 103	Marb +0.47 REA -0.14 Bfat +0.04
Cow Eff. 90	

★★★★★ for Low Maintenance, Marbling, Superior Cow, Calving Ease, Stayability.

318 **BECKTON BELGA G439 C**
1-A 100% # 4170588 Tattoo: BKT9 G439

Birth: 3-27-19
 Beckton Clifftop Z824 C4 < Beckton Clifftop W577 E3
 Beckton Tamara R175 CQ
BECKTON CLIFFTOP B079 C5
 Ref. C-2 < Beckton Clifftop W577 E3
 Beckton Christy Z679 C < Beckton Christy W280 J
 WR **107**
 YR **107**
 Fr. **Med**

DAM	RAAA HerdBuilder index: 175 (Top 42% of RA breed)
Age 4	RAAA GridMaster index: 47 (Top 51% of RA breed)
Wt 910	Sire Beef Tenderness: 10 'Outstanding'
Prog.BW 71	Calv.Ease BW WW YW Milk HPG Stay Maint.En.
WR 106	EPDs 12 -1.4 50 80 25 12 17 -7.0
YR 103	Marb +0.32 REA -0.10 Bfat +0.04
Cow Eff. 109	

★★★★★ for Low Maintenance, Growth, Marbling, Calving Ease, Stayability.

351 **PEN OF 12 COMMERCIAL HEIFERS**

This lot contains 12 high-percentage Beckton Red Angus yearling heifers

352 **PEN OF 11 COMMERCIAL HEIFERS**

This lot contains 11 high-percentage Beckton Red Angus yearling heifers

Reference Sire Lot Index

<u>Lot</u>	<u>ID</u>	<u>Lot</u>	<u>ID</u>	<u>Lot</u>	<u>ID</u>	<u>Lot</u>	<u>ID</u>	<u>Lot</u>	<u>ID</u>	<u>Lot</u>	<u>ID</u>		
<u>Accent D806 (A)</u>		62.	G339	<u>Clifftop E077 (C-4)</u>		<u>Epic B310 (E-2)</u>		<u>Julian E423 (J-5)</u>		<u>Likable E391 (L-7)</u>		<u>Oracle ES142 (O-2)</u>	
68.	G538	94.	G603	205. . . .	G301	5.	G454	145. . . .	G550	27.	G280	63.	G114
<u>Accent W180 (A-1)</u>		137. . . .	G607	214. . . .	G438	58.	G590	148. . . .	G151	129. . . .	G005	158. . . .	G016
54.	G380	161. . . .	G706	<u>Cardinal E381 (C-5)</u>		76.	G681	153. . . .	G091	155. . . .	G053	212. . . .	G028
80.	G207	215. . . .	G824	156. . . .	G041	104. . . .	G337	160. . . .	G257	166. . . .	G326	<u>Ranger B006 (R-1)</u>	
118. . . .	G244	221. . . .	G784	176. . . .	G109	123. . . .	G781	<u>Legend E049 (L)</u>		211. . . .	G773	51.	G299
119. . . .	GC142	<u>Accent E172 (A-6)</u>		219. . . .	G174	139. . . .	G786	152. . . .	G059	<u>Legend E464 (L-8)</u>		53.	G632
132. . . .	G530	22.	G333	<u>Cardinal E673 (C-6)</u>		149. . . .	G431	<u>Legend Z689 (L)</u>		56.	G014	57.	G639
197. . . .	G162	110. . . .	G107	90.	G043	157. . . .	G802	75.	G482	138. . . .	G420	82.	G475
207. . . .	GC140	222. . . .	G667	112. . . .	G056	233. . . .	G702	<u>Nebula S347 (N)</u>		<u>Nebula X096 (N)</u>		88.	G621
<u>Accent B549 (A-2)</u>		<u>Accent E333 (A-7)</u>		122. . . .	G602	<u>Epic D275 (E-3)</u>		<u>Likable Z057 (L-1)</u>		2.	G422	120. . . .	G599
34.	G485	131. . . .	G035	127. . . .	G554	7.	G145	1.	G269	<u>Nebula P084 (N-2)</u>		147. . . .	G328
89.	G163	188. . . .	G204	192. . . .	G716	32.	G116	3.	G253	<u>Scamp A627 (S)</u>			
124. . . .	G752	<u>Accent E492 (A-8)</u>		<u>Dominator A378 (D-1)</u>		35.	G250	23.	G456	106. . . .	G519	162. . . .	G853
172. . . .	G615	41.	G559	10.	G217	42.	G516	24.	G511	<u>Scamp C349 (S)</u>			
175. . . .	G757	164. . . .	G477	38.	G580	43.	G110	46.	G442	19.	G469		
181. . . .	G789	195. . . .	G070	48.	G342	77.	G498	69.	G509	<u>Scamp D325 (S-1)</u>			
183. . . .	G453	<u>Hughes E090 (B)</u>		72.	G461	97.	G666	71.	G517	16.	G166		
<u>Accent B553 (A-3)</u>		31.	G033	74.	G343	98.	G311	140. . . .	G769	40.	G481	44.	G150
6.	G146	<u>Hughes E113 (B)</u>		99.	G650	115. . . .	G156	<u>Likable B032 (L-2)</u>		55.	G409	111. . . .	G660
13.	G134	165. . . .	G100	128. . . .	G412	177. . . .	G258	21.	G435	308. . . .	G276(H)	206. . . .	G497
67.	G691	<u>Hughes C350 (B-1)</u>		154. . . .	G410	<u>Epic E488 (E-4)</u>		25.	G288	<u>Nebula B557 (N-4)</u>		210. . . .	G126
102. . . .	G679	37.	G588	202. . . .	G699	135. . . .	G068	26.	G358	9.	G249	218. . . .	G751
126. . . .	G656	114. . . .	G610	223. . . .	G778	185. . . .	G024	28.	G398	12.	G225	224. . . .	G614
141. . . .	G096	187. . . .	G622	226. . . .	G841	<u>Epic E670 (E-5)</u>		60.	G673	18.	G484	302. . . .	G181(H)
208. . . .	G758	234. . . .	G392	232. . . .	G647	108. . . .	G483	100. . . .	G424	39.	G310	311. . . .	G123(H)
229. . . .	G772	<u>Dominator D254 (D-2)</u>		50.	G604	182. . . .	G144	101. . . .	G544	83.	G206	<u>Scamp E175 (S-2)</u>	
310. . . .	G609(H)	125. . . .	G644	<u>Heritage D195 (H-1)</u>		<u>Jet P491 (J)</u>		159. . . .	G627	95.	G529	61.	G084
<u>Accent B653 (A-4)</u>		134. . . .	G575	11.	G245	91.	G441	179. . . .	G682	116. . . .	G535	142. . . .	G246
8.	G427	150. . . .	G368	52.	G197	<u>Javelin 7466 (J-1)</u>		<u>Likable B274 (L-3)</u>		144. . . .	G186	184. . . .	G019
29.	G721	163. . . .	G281	174. . . .	G129	312. . . .	G419(H)	103. . . .	G470	190. . . .	G722	<u>Warrior D359 (W-1)</u>	
47.	G300	178. . . .	G282	316. . . .	G132(H)	319. . . .	G361(H)	105. . . .	G468	225. . . .	G597	15.	G562
81.	G500	227. . . .	G464	<u>Jet P491 (J)</u>		<u>Julian B571 (J-2)</u>		<u>Likable C229 (L-4)</u>		<u>New Era C209 (N-5)</u>		17.	G582
87.	G212	50.	G604	91.	G441	301. . . .	G444(H)	4.	G168	193. . . .	G489	59.	G290
96.	G370	125. . . .	G644	<u>Epic Z674 (E-1)</u>		<u>Julian P608 (J-3)</u>		30.	G620	306. . . .	G359(H)	109. . . .	G630
143. . . .	G693	134. . . .	G575	92.	G471	<u>Javelin 7466 (J-1)</u>		49.	G726	<u>New Era D478 (N-6)</u>		121. . . .	G214
168. . . .	G159	150. . . .	G368	93.	G533	312. . . .	G419(H)	66.	G182	65.	G387	136. . . .	G545
169. . . .	G138	163. . . .	G281	117. . . .	G295	319. . . .	G361(H)	86.	G154	303. . . .	G413(H)	201. . . .	G502
171. . . .	G149	178. . . .	G282	146. . . .	G601	<u>Julian B571 (J-2)</u>		173. . . .	G416	<u>RHLancer ERH11 (O-1)</u>		317. . . .	G130(H)
186. . . .	G652	227. . . .	G464	189. . . .	G740	301. . . .	G444(H)	198. . . .	G271	84.	G050	<u>Warrior E215 (W-2)</u>	
203. . . .	G663	50.	G604	199. . . .	G543	<u>Julian P608 (J-3)</u>		237. . . .	G739	130. . . .	G447	79.	G372
220. . . .	G771	134. . . .	G575	204. . . .	G695	<u>Julian A434 (J-4)</u>		<u>Legend C313 (L-5)</u>		151. . . .	G272	194. . . .	G023
304. . . .	G252(H)	178. . . .	G282	213. . . .	G736	113. . . .	GC149	45.	G140	170. . . .	G312		
305. . . .	G142(H)	227. . . .	G464	228. . . .	G646	180. . . .	GC148	64.	G155	320. . . .	G532(H)		
309. . . .	G172(H)	50.	G604	307. . . .	G473(H)	217. . . .	GC154	<u>Legend E032 (L-6)</u>					
<u>Accent B740 (A-5)</u>		134. . . .	G575	315. . . .	G568(H)			167. . . .	G585				
14.	G635	150. . . .	G368					191. . . .	G064				
20.	G480	163. . . .	G281					216. . . .	G167				
33.	G377	178. . . .	G282										

Reference Sires

The goal for Beckton's program has always been to develop breeding seedstock which offer increased levels of performance for the commercial cattleman. Increased performance does not mean maximizing weight and size, which have already reached the upper limit of economic

value for the packer and consumer. It does, however, mean increasing performance related to calving percentage and weaning percentage; and increasing performance related to cow maintenance requirements and "pounds of calf per acre" efficiency.



Beckton Julian B571 (Ref. Sire J-2)

• Reference Sires •

A-1 BECKTON ACCENT W180 C2
1-A 100% # 1331776 Tattoo: BKB9 W180

Birth: 3-12-09	Beckton Cody KH M390	Beckton Cody K G701	BWt	77
	Beckton Rose M126 WR	Beckton Tamara J124 HR	WR	116
BECKTON CODY K1 P014	Ref. A	Beckton Warrior T C371	ADG	4.23
	Beckton Cherokee N N479	Beckton Rose D741 LN	YR	114
BECKTON CHRISTY R046 CQ		BFCk Cherokee Cnyn 4912	Scr.	39
	Beckton Christy N740 HR	Beckton Dinah C440 NM	Fr.	5.5
		Beckton Herald FJ J776		
		Beckton Christy K141 VG		

RAAA HerdBuilder index: **258** (Top 1% of RA breed)

RAAA GridMaster index: **47** (Top 57% of RA breed)

DAM	
Age	4
Wt	1140
Wean Pct.	57%
Cow Eff.	121

Calv.Ease	BW	WW	YW	Milk	HPG	Stay	Maint.En.
EPDs	20	-4.7	60	95	25	14	24
Acc.	(.64)	(.85)	(.81)	(.82)	(.68)	(.49)	(.43)
Marb	+.29	(.46)	REA	+.10	(.57)	Bfat	+.04
							(.34)



Accent W180 (A-1)

★★★★★ for Low Maintenance, Growth, Gainability, Marbling, High Cow Efficiency, Calving Ease, Stayability.

A-2 BECKTON ACCENT B549 N3
1-A 100% # 1705673 Tattoo: BKB4 B549

Birth: 3-31-14	Beckton Cody K1 P014	Beckton Cody KH M390	BWt	75
	Beckton Rose M126 WR	Beckton Rose M126 WR	WR	119
BECKTON ACCENT W180 C2	Ref. A-1	Beckton Cherokee N N479	ADG	4.77
	Beckton Christy R046 CQ	Beckton Christy N740 HR	YR	122
BECKTON MINERVA Y654 N		Beckton Nebula L P093	Scr.	39
	Beckton Nebula T398 V3	Beckton Minerva J615 VG	Fr.	6.0
	Beckton Minerva M369 LO	Beckton Loki F251		
		Beckton Minerva H403 LN		

RAAA HerdBuilder index: **225** (Top 2% of RA breed)

RAAA GridMaster index: **49** (Top 21% of RA breed)

DAM	
Age	3
Wt	1046
Wean Pct.	54%
Cow Eff.	114

Calv.Ease	BW	WW	YW	Milk	HPG	Stay	Maint.En.
EPDs	14	-1.8	65	110	25	13	21
Acc.	(.45)	(.69)	(.63)	(.63)	(.43)	(.10)	(.21)
Marb	+.36	(.27)	REA	+.25	(.46)	Bfat	+.04
							(.20)

★★★★★ for Low Maintenance, Growth, Gainability, Marbling, Rib-eye area, Calving Ease, Stayability.

A-4 BECKTON ACCENT B653 C3
1-A 100% # 1705555 Tattoo: BSF4 B653

Birth: 4-8-14	Beckton Cody K1 P014	Beckton Cody KH M390	BWt	77
	Beckton Rose M126 WR	Beckton Rose M126 WR	WR	108
BECKTON ACCENT U777 C2	Ref. A	Beckton Cherokee N N479	ADG	3.98
	Beckton Susan R022 CQ	Beckton Susan N023 JE	YR	108
BECKTON CHRISTY W779 C		BKT Clifftop TP R288	Scr.	39
	Beckton Clifftop T C075	Beckton Christy K209 CO	Fr.	5.5
	Beckton Christy S151 NB	Beckton Nebula E P084		
		Beckton Christy P333 CH		

RAAA HerdBuilder index: **162** (Top 61% of RA breed)

RAAA GridMaster index: **47** (Top 66% of RA breed)

DAM	
Age	5
Wt	1040
Wean Pct.	58%
Cow Eff.	123

Calv.Ease	BW	WW	YW	Milk	HPG	Stay	Maint.En.
EPDs	16	-2.5	53	87	27	12	15
Acc.	(.47)	(.71)	(.66)	(.65)	(.45)	(.10)	(.20)
Marb	+.30	(.22)	REA	-1.17	(.44)	Bfat	+.04
							(.19)

★★★★★ for Low Maintenance, Growth, Marbling, High Cow Efficiency, Calving Ease, Stayability.

A-3 BECKTON ACCENT B553 L2
1-A 100% # 1706080 Tattoo: BKT4 B553

Birth: 3-31-14	Beckton Cody K1 P014	Beckton Cody KH M390	BWt	80
	Beckton Rose M126 WR	Beckton Rose M126 WR	WR	102
BECKTON ACCENT U777 C2	Ref. A	Beckton Cherokee N N479	ADG	4.49
	Beckton Susan R022 CQ	Beckton Susan N023 JE	YR	108
BECKTON LANA X839 L		Beckton Lancer F442 T	Scr.	36
	Beckton Legend S670	Beckton Kit F468 JL	Fr.	5.5
	Beckton Lana S371 DM	Beckton Dominor ZC M919		
		Beckton Lana L367 LN		

RAAA HerdBuilder index: **176** (Top 38% of RA breed)

RAAA GridMaster index: **49** (Top 32% of RA breed)

DAM	
Age	4
Wt	1260
Wean Pct.	49%
Cow Eff.	104

Calv.Ease	BW	WW	YW	Milk	HPG	Stay	Maint.En.
EPDs	14	-1.3	53	85	24	12	16
Acc.	(.39)	(.66)	(.59)	(.58)	(.37)	(.10)	(.18)
Marb	+.50	(.27)	REA	-1.10	(.39)	Bfat	+.04
							(.24)

★★★★★ for Low Maintenance, Growth, Gainability, Marbling, Calving Ease, Stayability.

A-5 BECKTON ACCENT B740 W3
1-A 100% # 1705638 Tattoo: BKT4 B740

Birth: 4-16-14	Beckton Cody K1 P014	Beckton Cody KH M390	BWt	71
	Beckton Rose M126 WR	Beckton Rose M126 WR	WR	104
BECKTON ACCENT W180 C2	Ref. A-1	Beckton Cherokee N N479	ADG	3.93
	Beckton Christy R046 CQ	Beckton Christy N740 HR	YR	104
BECKTON LANA Y033 W		Beckton Warrior W534 N4	Scr.	35
	Beckton BKT Larkeisa S055 NB	Beckton Epic K4 N795	Fr.	5.5
	Beckton Lana W370 E	Beckton Lana P520 LN		

RAAA HerdBuilder index: **199** (Top 13% of RA breed)

RAAA GridMaster index: **49** (Top 27% of RA breed)

DAM	
Age	3
Wt	982
Wean Pct.	50%
Cow Eff.	105

Calv.Ease	BW	WW	YW	Milk	HPG	Stay	Maint.En.
EPDs	21	-5.0	64	103	23	12	16
Acc.	(.32)	(.56)	(.51)	(.49)	(.31)	(.10)	(.18)
Marb	+.36	(.23)	REA	+.25	(.34)	Bfat	+.04
							(.16)

★★★★★ for Low Maintenance, Marbling, Rib-eye area, Calving Ease, Stayability.

• Reference Sires •

A-6 BECKTON ACCENT E172 L3
1-A 100% # 3777901 Tattoo: BKB7 E172

Birth: 3-7-17	Beckton Cody K1 P014	Beckton Cody KH M390	BWt	81
		Beckton Rose M126 WR	WR	112
BECKTON ACCENT W180 C2	Beckton Cherokee N N479	Beckton Christy N740 HR	ADG	3.67
Ref. A-1	Beckton Christy R046 CQ		YR	116
	Beckton Likable U130 L2	Beckton Likable S633	Scr.	39
BECKTON INDIGO Y406 L	Beckton Kit S478 LN	Beckton Warrior CL M686	Fr.	6.0
	Beckton Indigo R745 WR	Beckton Indigo M514 CH		

RAAA HerdBuilder index: **233** (Top 1% of RA breed)

RAAA GridMaster index: **48** (Top 43% of RA breed)

DAM	Calv.Ease	BW	WW	YW	Milk	HPG	Stay	Maint.En.
Age 6	EPDs 16	-3.2	60	96	23	13	23	-4.0
Wt 1095	Acc. (.34)	(.49)	(.42)	(.41)	(.27)	(.10)	(.19)	(.04)
Wean Pct. 58%	Marb +.27	(.24)	REA +.19	(.30)	Bfat +.03	(.20)		
Cow Eff. 121								

★★★★★ for Low Maintenance, Growth, Marbling, Rib-eye area, High Cow Efficiency, Calving Ease, Stayability.

B-1 BECKTON HUGHES C350 N2
1-A 100% # 3487199 Tattoo: BKT5 C350

Birth: 3-22-15	Basin Hobo 0545	Basin Hobo 79E	BWt	72
		Basin Erica 330E	WR	104
BIEBER H HUGHES W109	Red Brylor New Trend 22	Basin Rose F521	ADG	3
Ref. B	Basin Rose 06T0		YR	107
	Beckton Nebula X353 E3	Beckton Nebula G S237	Scr.	37
BECKTON KIT Z049 N	Beckton Lana R058 EP	Bkt Javelin 7466 R	Fr.	5.5
	Beckton Kit X236 L	Beckton Kit S545 LN		

RAAA HerdBuilder index: **183** (Top 28% of RA breed)

RAAA GridMaster index: **46** (Top 70% of RA breed)

DAM	Calv.Ease	BW	WW	YW	Milk	HPG	Stay	Maint.En.
Age 3	EPDs 18	-4.0	63	99	24	11	16	0.0
Wt 1055	Acc. (.36)	(.55)	(.49)	(.49)	(.33)	(.12)	(.16)	(.53)
Wean Pct. 53%	Marb +.23	(.25)	REA +.05	(.35)	Bfat +.04	(.20)		
Cow Eff. 112								

★★★★★ for Low Maintenance, Growth, Marbling, Calving Ease, Stayability.

A-7 BECKTON ACCENT E333 N4
1-A 100% # 3776427 Tattoo: BKT7 E333

Birth: 3-20-17	Beckton Accent W180 C2	Beckton Cody K1 P014	BWt	85
		Beckton Christy R046 CQ	WR	123
BECKTON ACCENT A175 O3	TR Romeo NT379	Beckton Lana N664 JL	ADG	2.78
Ref. A	Beckton Lana R214 RA		YR	114
	Beckton Nebula EN S347	Beckton Nebula E P084	Scr.	39
BECKTON EOLA U027 NB	Beckton Eola P530 NB	Beckton Loki C M740	Fr.	6.0
	Beckton Eola S317 LO	Beckton Eola J454 JL		

RAAA HerdBuilder index: **185** (Top 27% of RA breed)

RAAA GridMaster index: **48** (Top 45% of RA breed)

DAM	Calv.Ease	BW	WW	YW	Milk	HPG	Stay	Maint.En.
Age 9	EPDs 16	-2.4	64	100	28	12	17	-2.0
Wt 1025	Acc. (.33)	(.51)	(.43)	(.43)	(.25)	(.09)	(.16)	(.19)
Wean Pct. 67%	Marb +.33	(.24)	REA -.06	(.30)	Bfat +.05	(.19)		
Cow Eff. 142								

★★★★★ for Low Maintenance, Growth, Marbling, High Cow Efficiency, Calving Ease, Stayability.

B-2 BECKTON HUGHES E261 S3
1-A 100% # 3778225 Tattoo: BSF7 E261

Birth: 3-16-17	Bieber H Hughes W109	Basin Hobo 0545	BWt	63
		Basin Rose 06T0	WR	106
BECKTON HUGHES C463 N2	Beckton Nexus L016	Beckton Lakme M669 EP	ADG	3.61
Ref. B	Beckton Lakme T689 NX		YR	110
	Beckton Scamp A627 J4	Beckton Scamp X494 E3	Scr.	34
BECKTON LANA C073 S	Beckton Serena R023 JC	Beckton Accent Y260 L3	Fr.	5.0
	Beckton Lana A083 A	Beckton Lana Y130 N		

RAAA HerdBuilder index: **194** (Top 17% of RA breed)

RAAA GridMaster index: **47** (Top 63% of RA breed)

DAM	Calv.Ease	BW	WW	YW	Milk	HPG	Stay	Maint.En.
Age 2	EPDs 18	-5.7	57	93	28	16	17	-7.0
Wt 815	Acc. (.26)	(.46)	(.39)	(.38)	(.18)	(.04)	(.09)	(.02)
Wean Pct. 55%	Marb +.32	(.19)	REA +.00	(.26)	Bfat +.04	(.16)		
Cow Eff. 116								

★★★★★ for Low Maintenance, Growth, Marbling, High Cow Efficiency, Calving Ease, Stayability.

A-8 BECKTON ACCENT E492 N4
1-A 100% # 3776759 Tattoo: BKT7 E492

Birth: 3-27-17	Beckton Accent W180 C2	Beckton Cody K1 P014	BWt	70
		Beckton Christy R046 CQ	WR	107
BECKTON ACCENT B740 W3	Beckton Warrior W534 N4	Beckton Lana W370 E	ADG	3
Ref. A-5	Beckton Lana Y033 W		YR	103
	Beckton Nebula X096 N4	Beckton Nebula U206 V3	Scr.	36
BKT PINE MARIE Z177 N	Beckton Tamara U185 NB	Beckton Heritage T270 J2	Fr.	5.5
	BKT Pine Marie X540 H	BKT Pine Marie R246 JE		

RAAA HerdBuilder index: **201** (Top 11% of RA breed)

RAAA GridMaster index: **48** (Top 35% of RA breed)

DAM	Calv.Ease	BW	WW	YW	Milk	HPG	Stay	Maint.En.
Age 5	EPDs 19	-4.8	63	98	27	12	18	-1.0
Wt 1290	Acc. (.28)	(.48)	(.42)	(.41)	(.20)	(.04)	(.14)	(.03)
Wean Pct. 47%	Marb +.45	(.19)	REA +.10	(.27)	Bfat +.05	(.16)		
Cow Eff. 98								

★★★★★ for Low Maintenance, Marbling, Calving Ease, Stayability.

C-1 BECKTON CARDINAL B074 N
1-A 100% # 1706184 Tattoo: BKT4 B074

Birth: 2-24-14	TR Ricardo DOS	BFCk Cherokee Cnyn 4912	BWt	57
		TR Dyna LT111	WR	102
TR DOUBLE EAGLE ZT220	Beckton Justice C1 R483	Beckton Lana H544 WR	ADG	4.38
Ref. C	Beckton Lana U182 JC		YR	109
	Beckton Nebula J R475	Beckton Nebula M045	Scr.	36
BKT PINE MARIE Z250 N	Beckton Larkeisa M138 JC	Beckton Nebula P P707	Fr.	5.5
	BKT Pine Marie U621 NB	BKT Pine Marie P475 LN		

RAAA HerdBuilder index: **216** (Top 4% of RA breed)

RAAA GridMaster index: **48** (Top 33% of RA breed)

DAM	Calv.Ease	BW	WW	YW	Milk	HPG	Stay	Maint.En.
Age 2	EPDs 23	-8.3	48	85	27	13	17	-4.0
Wt 834	Acc. (.46)	(.65)	(.60)	(.61)	(.41)	(.08)	(.19)	(.62)
Wean Pct. 49%	Marb +.36	(.22)	REA +.03	(.42)	Bfat +.04	(.20)		
Cow Eff. 103								

★★★★★ for Low Maintenance, Growth, Gainability, Marbling, Calving Ease, Stayability.

• Reference Sires •

C-2 BECKTON CLIFFTOP B079 C5
1-A 100% # 1706254 Tattoo: BKT4 B079

Birth: 2-25-14	Beckton Clifftop W577 E3	< BKT Clifftop TP R288	BWt 75
		< BKT Pine Marie R213 EP	WR 107
BECKTON CLIFFTOP Z824 C4	Ref. C	Beckton Cherokee N N479	ADG 3.47
	Beckton Tamara R175 CQ	< Beckton Tamara N765 CO	YR 104
		< BKT Clifftop TP R288	Scr. 36
BECKTON CHRISTY Z679 C	Beckton Clifftop W577 E3	< BKT Pine Marie R213 EP	Fr. 5.5
	Beckton Christy W280 J	< Beckton Justice C1 R483	
		< Beckton Christy K101 CD	

RAAA HerdBuilder index: **158** (Top **67%** of RA breed)
RAAA GridMaster index: **47** (Top **58%** of RA breed)

Calv.Ease	BW	WW	YW	Milk	HPG	Stay	Maint.En.
EPDs 12	-1.6	42	69	22	13	16	-8.0
Acc. (.40)	(.65)	(.60)	(.59)	(.38)	(.06)	(.11)	(.63)
Marb +.40	(.24)	REA -.14	(.39)	Bfat +.05	(.17)		

DAM

Age	2
Wt	894
Wean Pct.	53%
Cow Eff.	111

★★★★★ for Low Maintenance, Marbling, Calving Ease, Stayability.

C-5 BECKTON CARDINAL E381 J2
1-A 100% # 3776481 Tattoo: BKT7 E381

Birth: 3-22-17	TR Double Eagle ZT220	< TR Ricardo DOS	BWt 72
		< Beckton Lana U182 JC	WR 102
BECKTON CARDINAL B074 N	Ref. C-1	Beckton Nebula J R475	ADG 3.39
	BKT Pine Marie Z250 N	< BKT Pine Marie U621 NB	YR 109
		< Beckton Julian GJ P535	Scr. 37
BECKTON LARKABA W868 J	Beckton Julian G5 S107	< Beckton Minola P826 DM	Fr. 5.5
	Beckton Larkaba S663 JE	< Beckton Jules L429	
		< Beckton Larkaba K530 EP	

RAAA HerdBuilder index: **175** (Top **40%** of RA breed)
RAAA GridMaster index: **50** (Top **18%** of RA breed)

Calv.Ease	BW	WW	YW	Milk	HPG	Stay	Maint.En.
EPDs 14	-4.3	56	98	25	14	15	-4.0
Acc. (.34)	(.52)	(.44)	(.43)	(.25)	(.03)	(.15)	(.18)
Marb +.26	(.20)	REA +.06	(.30)	Bfat +.04	(.18)		

DAM

Age	8
Wt	1170
Wean Pct.	49%
Cow Eff.	103

★★★★★ for Low Maintenance, Growth, Marbling, Calving Ease, Stayability.

C-3 BECKTON CLIFFTOP C572 N5
1-A 100% # 3487361 Tattoo: BKT5 C572

Birth: 4-1-15	Beckton Clifftop W692 E3	< BKT Clifftop TP R288	BWt 77
		< Beckton Lydia S274 EP	WR 107
BECKTON CLIFFTOP Y012 C4	Ref. C	BKT Clifftop TP R288	ADG 4.43
	Beckton Lana W240 C	< Beckton Lana L923 CD	YR 113
		< Beckton Nebula M045	Scr. 36
BKT PINE MARIE U454 NB	Beckton Nebula P P707	< Beckton Lana M809 EP	Fr. 5.5
	BKT Pine Marie N582 WR	< Beckton Warrior TD L493	
		< BKT Pine Marie L650 EP	

RAAA HerdBuilder index: **181** (Top **32%** of RA breed)
RAAA GridMaster index: **48** (Top **40%** of RA breed)

Calv.Ease	BW	WW	YW	Milk	HPG	Stay	Maint.En.
EPDs 16	-4.0	47	82	30	9	17	-5.0
Acc. (.38)	(.68)	(.61)	(.59)	(.35)	(.07)	(.19)	(.47)
Marb +.44	(.23)	REA -.16	(.34)	Bfat +.05	(.18)		

DAM

Age	7
Wt	1240
Wean Pct.	51%
Cow Eff.	108

★★★★★ for Low Maintenance, Growth, Gainability, Marbling, Calving Ease, Stayability.

C-6 BECKTON CARDINAL E673 L
1-A 100% # 3776785 Tattoo: BKT7 E673

Birth: 4-12-17	TR Ricardo DOS	< BFCK Cherokee Cnyn 4912	BWt 51
		< TR Dyna LT111	WR 104
TR DOUBLE EAGLE ZT220	Ref. C	Beckton Justice C1 R483	ADG 2.69
	Beckton Lana U182 JC	< Beckton Lana H544 WR	YR 97
		< Beckton Legend S670	Scr. 33
BECKTON LARKABA A911 L	Beckton Legend U331 E2	< Beckton Lana S669 EP	Fr. 5.0
	Beckton Larkaba T418 WA	< Beckton Warhawk N560	
		< Beckton Larkaba P783 JL	

RAAA HerdBuilder index: **223** (Top **3%** of RA breed)
RAAA GridMaster index: **49** (Top **25%** of RA breed)

Calv.Ease	BW	WW	YW	Milk	HPG	Stay	Maint.En.
EPDs 23	-6.3	59	90	21	13	18	-3.0
Acc. (.29)	(.47)	(.40)	(.40)	(.22)	(.06)	(.14)	(.04)
Marb +.48	(.19)	REA +.21	(.28)	Bfat +.04	(.18)		

DAM

Age	4
Wt	1035
Wean Pct.	51%
Cow Eff.	108

★★★★★ for Low Maintenance, Marbling, Rib-eye area, Calving Ease, Stayability.

C-4 BECKTON CLIFFTOP E077 L6
1-A 100% # 3778137 Tattoo: BSF7 E077

Birth: 2-23-17	Beckton Clifftop Y012 C4	< Beckton Clifftop W692 E3	BWt 69
		< Beckton Lana W240 C	WR 121
BECKTON CLIFFTOP C572 N5	Ref. C-3	Beckton Nebula P P707	ADG 3.44
	BKT Pine Marie U454 NB	< BKT Pine Marie N582 WR	YR 112
		< Beckton Lancer F442 T	Scr. 36
BECKTON LARKABA C217 L	Beckton Legend S670	< Beckton Kit F468 JL	Fr. 5.5
	Beckton Larkaba U062 CB	< Beckton Cobalt S029	
		< Beckton Larkaba S374 NB	

RAAA HerdBuilder index: **197** (Top **14%** of RA breed)
RAAA GridMaster index: **48** (Top **34%** of RA breed)

Calv.Ease	BW	WW	YW	Milk	HPG	Stay	Maint.En.
EPDs 16	-3.3	59	93	24	15	18	-10.0
Acc. (.27)	(.47)	(.39)	(.39)	(.20)	(.08)	(.14)	(.02)
Marb +.43	(.18)	REA +.07	(.29)	Bfat +.05	(.16)		

DAM

Age	2
Wt	785
Wean Pct.	63%
Cow Eff.	133

★★★★★ for Low Maintenance, Growth, Marbling, High Cow Efficiency, Calving Ease, Stayability.

D-1 BECKTON DOMINOR A378 W7
1-A 100% # 1626650 Tattoo: BKT3 A378

Birth: 3-26-13	Beckton Dominor W640 C5	< Beckton Dominor Z1 R610	BWt 64
		< Beckton Mona R166 CQ	WR 100
BECKTON DOMINOR Y005 V6	Ref. D	Beckton Vega P079	ADG 3.43
	Beckton Belga W108 V	< Beckton Belga K476 JL	YR 104
		< Beckton Warrior N645 T1	Scr. 34
BECKTON LANA Y541 W	Beckton Warrior T248 L5	< Beckton Kit R503 LN	Fr. 5.5
	Beckton Lana S074 EP	< Beckton Epic KH P678	
		< Beckton Lana P317 JL	

RAAA HerdBuilder index: **173** (Top **44%** of RA breed)
RAAA GridMaster index: **50** (Top **14%** of RA breed)

Calv.Ease	BW	WW	YW	Milk	HPG	Stay	Maint.En.
EPDs 20	-3.7	42	78	29	14	12	-8.0
Acc. (.47)	(.75)	(.70)	(.70)	(.48)	(.30)	(.18)	(.64)
Marb +.51	(.33)	REA +.15	(.45)	Bfat +.05	(.33)		

DAM

Age	2
Wt	885
Wean Pct.	50%
Cow Eff.	106

★★★★★ for Low Maintenance, Marbling, Rib-eye area, Calving Ease.

• Reference Sires •

D-2 BECKTON DOMINOR D254 N8
1-A 100% # 3551799 Tattoo: BKT6 D254

Birth: 3-15-16	Beckton Dominor Y005 V6	Beckton Dominor W640 C5	BWt 67
		Beckton Belga W108 V	WR 101
BECKTON DOMINOR A378 W7	Ref. D-1	Beckton Warrior T248 L5	ADG 4.72
	Beckton Lana Y541 W	Beckton Lana S074 EP	YR 110
	Beckton Nebula T398 V3	Beckton Nebula L P093	Scr. 41
BECKTON INDIGO W772 N		Beckton Minerva J615 VG	Fr. 5.5
	Beckton Indigo T613 JT	TR Julian LT151	
		Beckton Indigo N467 LO	

RAAA HerdBuilder index: **222** (Top 3% of RA breed)

RAAA GridMaster index: **49** (Top 30% of RA breed)

DAM	Age 7	Wt 1090	Wean Pct. 50%	Cow Eff. 106				
	Calv.Ease	BW	WW	YW	Milk	HPG	Stay	Maint.En.
	EPDs 20	-5.2	41	77	31	14	19	-5.0
	Acc. (.31)	(.60)	(.53)	(.53)	(.29)	(.15)	(.15)	(.19)
	Marb +0.36	(.23)	REA +0.20	(.34)	Bfat +0.05	(.20)		

★★★★★ for Low Maintenance, Growth, Gainability, Marbling, Rib-eye area, Calving Ease, Stayability.

E-3 BECKTON EPIC D275 L7
1-A 100% # 3551843 Tattoo: BKT6 D275

Birth: 3-16-16	Beckton Epic U749 D5	Beckton Epic K4 N795	BWt 71
		Beckton Denise R308 DM	WR 102
BECKTON EPIC Z674 E6	Ref. E-1	Beckton Epic K6 S569	ADG 3.94
	Beckton Indigo U504 EP	Beckton Indigo S016 NB	YR 105
	Beckton Legend S670	Beckton Lancer F442 T	Scr. 34
BECKTON LANA X839 L		Beckton Kit F468 JL	Fr. 5.5
	Beckton Lana S371 DM	Beckton Dominor ZC M919	
		Beckton Lana L367 LN	

RAAA HerdBuilder index: **185** (Top 27% of RA breed)

RAAA GridMaster index: **49** (Top 20% of RA breed)

DAM	Age 6	Wt 1075	Wean Pct. 52%	Cow Eff. 110				
	Calv.Ease	BW	WW	YW	Milk	HPG	Stay	Maint.En.
	EPDs 19	-4.4	57	92	21	13	15	-5.0
	Acc. (.35)	(.63)	(.57)	(.56)	(.32)	(.05)	(.17)	(.19)
	Marb +0.53	(.21)	REA -0.10	(.34)	Bfat +0.04	(.18)		

★★★★★ for Low Maintenance, Marbling, Calving Ease, Stayability.

E-1 BECKTON EPIC Z674 E6
2 100% # 1544788 Tattoo: BKT2 Z674

Birth: 4-2-12	Beckton Epic K4 N795	Beckton Epic KJ J722	BWt 80
		Beckton Sierra J789 EP	WR 115
BECKTON EPIC U749 D5	Ref. E	Beckton Dominor ZC M919	ADG 3.75
	Beckton Denise R308 DM	Beckton Denise L639 JL	YR 114
	Beckton Epic K6 S569	Beckton Epic KM M115	Scr. 32
BECKTON INDIGO U504 EP		Beckton Sierra N703 LM	Fr. 5.5
	Beckton Indigo S016 NB	Beckton Nebula P P707	
		Beckton Indigo P062 NB	

RAAA HerdBuilder index: **143** (Top 83% of RA breed)

RAAA GridMaster index: **49** (Top 23% of RA breed)

DAM	Age 4	Wt 825	Wean Pct. 81%	Cow Eff. 170				
	Calv.Ease	BW	WW	YW	Milk	HPG	Stay	Maint.En.
	EPDs 16	-2.2	60	102	25	7	11	-2.0
	Acc. (.55)	(.79)	(.75)	(.75)	(.52)	(.09)	(.23)	(.66)
	Marb +0.42	(.31)	REA -0.06	(.48)	Bfat +0.06	(.22)		

★★★★★ for Low Maintenance, Growth, Marbling, High Cow Efficiency, Calving Ease.

E-4 BECKTON EPIC E488 N7
1-A 100% # 3776767 Tattoo: BKT7 E488

Birth: 3-27-17	Beckton Epic U749 D5	Beckton Epic K4 N795	BWt 94
		Beckton Denise R308 DM	WR 114
BECKTON EPIC Z674 E6	Ref. E-1	Beckton Epic K6 S569	ADG 3.56
	Beckton Indigo U504 EP	Beckton Indigo S016 NB	YR 115
	Beckton Nebula X096 N4	Beckton Nebula U206 V3	Scr. 38
BECKTON SIERRA Z059 N		Beckton Tamara U185 NB	Fr. 5.5
	Beckton Sierra X818 C	Beckton Cherokee T450 L3	
		Beckton Sierra G615 WR	

RAAA HerdBuilder index: **179** (Top 34% of RA breed)

RAAA GridMaster index: **51** (Top 10% of RA breed)

DAM	Age 5	Wt 1270	Wean Pct. 50%	Cow Eff. 106				
	Calv.Ease	BW	WW	YW	Milk	HPG	Stay	Maint.En.
	EPDs 14	0.6	68	117	24	10	15	1.0
	Acc. (.32)	(.50)	(.42)	(.42)	(.24)	(.04)	(.14)	(.19)
	Marb +0.45	(.21)	REA -0.05	(.29)	Bfat +0.05	(.18)		

★★★★★ for Low Maintenance, Growth, Marbling, Calving Ease, Stayability.

E-2 BECKTON EPIC B310 J6
1-A 100% # 1706097 Tattoo: BKT4 B310

Birth: 3-21-14	Beckton Epic K6 S569	Beckton Epic KM M115	BWt 66
		Beckton Sierra N703 LM	WR 121
BECKTON EPIC X464 L5	Ref. E	Beckton Lancer T3 J396	ADG 3.92
	Beckton Lana M393 LN	Beckton Lana F081 LN	YR 112
	Beckton Julian W743 H5	Beckton Julian G5 S107	Scr. 37
BECKTON MINERVA Y116 J		Beckton Kit L399 HR	Fr. 6.0
	Beckton Minerva W081 N	Beckton Nebula G S237	
		Beckton Minerva F495 CH	

RAAA HerdBuilder index: **180** (Top 32% of RA breed)

RAAA GridMaster index: **48** (Top 42% of RA breed)

DAM	Age 3	Wt 1125	Wean Pct. 57%	Cow Eff. 120				
	Calv.Ease	BW	WW	YW	Milk	HPG	Stay	Maint.En.
	EPDs 14	-1.6	66	104	24	13	16	-1.0
	Acc. (.46)	(.70)	(.66)	(.66)	(.41)	(.07)	(.15)	(.45)
	Marb +0.31	(.25)	REA +0.09	(.43)	Bfat +0.03	(.19)		

★★★★★ for Low Maintenance, Growth, Marbling, High Cow Efficiency, Calving Ease, Stayability.

E-5 BECKTON EPIC E670 E7
1-A 100% # 3777661 Tattoo: BSF7 E670

Birth: 4-11-17	Beckton Epic U749 D5	Beckton Epic K4 N795	BWt 69
		Beckton Denise R308 DM	WR 103
BECKTON EPIC Z674 E6	Ref. E-1	Beckton Epic K6 S569	ADG 3.35
	Beckton Indigo U504 EP	Beckton Indigo S016 NB	YR 107
	Beckton Epic U749 D5	Beckton Epic K4 N795	Scr. 35
BECKTON CHRISTY Z958 E		Beckton Denise R308 DM	Fr. 5.5
	Beckton Christy W831 A	Beckton Cody K1 P014	
		Beckton Christy M362 WR	

RAAA HerdBuilder index: **155** (Top 70% of RA breed)

RAAA GridMaster index: **50** (Top 15% of RA breed)

DAM	Age 5	Wt 1190	Wean Pct. 49%	Cow Eff. 103				
	Calv.Ease	BW	WW	YW	Milk	HPG	Stay	Maint.En.
	EPDs 19	-3.6	59	102	26	11	12	0.0
	Acc. (.30)	(.48)	(.42)	(.42)	(.27)	(.04)	(.12)	(.18)
	Marb +0.40	(.21)	REA +0.08	(.32)	Bfat +0.05	(.17)		

★★★★★ for Low Maintenance, Growth, Marbling, Calving Ease.

• Reference Sires •

H-1 BECKTON HERITAGE D195 L4

1-A 100% # 3551804 Tattoo: BKT6 D195

Birth: 3-10-16

Beckton Heritage X356 E2	Beckton Heritage N013	BWt	82
	Beckton Lana S489 EP	WR	128
BECKTON HERITAGE A767 C3	BKT Clifftop TP R288	ADG	4.06
Ref. H	Beckton Rose W816 C	YR	118
	Beckton Rose S487 LN	Scr.	37
	Beckton Loki C M740	Fr.	5.5
	Beckton Lakme J460 LT		
BECKTON SUSAN W846 L	Beckton Juno N493		
	Beckton Susan M144 CH		

RAAA HerdBuilder index: **145** (Top **81%** of RA breed)
 RAAA GridMaster index: **49** (Top **29%** of RA breed)

	Calv.Ease	BW	WW	YW	Milk	HPG	Stay	Maint.En.
EPDs	15	-2.2	66	109	23	10	12	-2.0
Acc.	(.33)	(.59)	(.53)	(.53)	(.31)	(.07)	(.13)	(.18)
Marb	+0.40	(.22)	REA	-0.04	(.35)	Bfat	+0.04	(.16)

DAM

Age	7
Wt	1150
Wean Pct.	62%
Cow Eff.	130

★★★★★ for Low Maintenance, Growth, Gainability, Marbling, High Cow Efficiency, Calving Ease.

J-3 BECKTON JULIAN G3 P608

1-A 100% # 978932 Tattoo: WF4 P608

Birth: 3-27-04

Beckton Julian 7526G	Beckton Julian 6592	BWt	72
	Bkt Belga 6746 GS	WR	106
BECKTON JULIAN GG B571	Beckton Julian 7526G	ADG	3.87
Ref. J-2	Bkt Marta 6498 XM	YR	111
	Beckton Dorado 8411V	Scr.	35
	Bkt Firefly 8734 DR	Fr.	5.0
BKT SUFFEINA A828 DM	Beckton Titan 7965		
	Bch Rch Claudia 2140		

RAAA HerdBuilder index: **180** (Top **42%** of RA breed)
 RAAA GridMaster index: **51** (Top **13%** of RA breed)

	Calv.Ease	BW	WW	YW	Milk	HPG	Stay	Maint.En.
EPDs	22	-6.6	40	63	22	14	13	-12.0
Acc.	(.55)	(.80)	(.76)	(.78)	(.68)	(.66)	(.47)	(.68)
Marb	+0.68	(.51)	REA	-0.37	(.58)	Bfat	+0.00	(.48)

DAM

Age	13
Wt	NA
Wean Pct.	NA
Cow Eff.	NA

★★★★★ for Low Maintenance, Growth, Marbling, Calving Ease, Stayability.

J-1 BECKTON JAVELIN 7466 R

1-A 100% # 173533 Tattoo: WF4 7466

Birth: 3-17-84

Beckton Trojan 5253	Beckton Dito 4374	BWt	66
	Bkt Mana Anexa 4473	WR	107
BECKTON JAVELIN 6587	Bkt Ry Mtn 1195	ADG	3.56
Ref.	Beckton Lsa 1632 96	YR	114
	Choctaw Chief 373	Scr.	NA
	Bkt Osalaxi -L	Fr.	NA
	Beckton Jiba 1067-C		
BECKTON ROSE 6807 RZ	Bkt Ximi Rose 4218		
	Bkt Baya Rose 5195		

RAAA HerdBuilder index: **176** (Top **48%** of RA breed)
 RAAA GridMaster index: **44** (Top **98%** of RA breed)

	Calv.Ease	BW	WW	YW	Milk	HPG	Stay	Maint.En.
EPDs	21	-7.4	21	26	22	14	14	-18.0
Acc.	(.27)	(.75)	(.69)	(.71)	(.54)	(.52)	(.33)	(.65)
Marb	+0.23	(.22)	REA	-0.46	(.39)	Bfat	+0.01	(.17)

DAM

Age	2
Wt	791
Wean Pct.	56%
Cow Eff.	112

★★★★★ for Low Maintenance, Marbling, Calving Ease, Stayability.

J-4 BECKTON JULIAN A434 N6

1-A 100% # 1626302 Tattoo: BKT3 A434

Birth: 3-27-13

Beckton Julian G5 S107	Beckton Julian GJ P535	BWt	75
	Beckton Minola P826 DM	WR	112
BECKTON JULIAN X465 J5	Beckton Julian GG B571	ADG	4.16
Ref. J	Bkt Suffeina A828 DM	YR	112
	Beckton Neptune R1 J245	Scr.	33
	Beckton Coca J276 CL	Fr.	6.0
BECKTON LAKME T689 NX	Beckton Epic K F075		
	Beckton Lakme F560 TP		

RAAA HerdBuilder index: **172** (Top **45%** of RA breed)
 RAAA GridMaster index: **49** (Top **30%** of RA breed)

	Calv.Ease	BW	WW	YW	Milk	HPG	Stay	Maint.En.
EPDs	10	-1.2	64	104	19	12	17	-2.0
Acc.	(.47)	(.56)	(.53)	(.53)	(.46)	(.25)	(.25)	(.49)
Marb	+0.37	(.36)	REA	-0.11	(.43)	Bfat	+0.03	(.34)

DAM

Age	6
Wt	1085
Wean Pct.	57%
Cow Eff.	121

★★★★★ for Low Maintenance, Growth, Gainability, Marbling, High Cow Efficiency, Calving Ease, Stayability.

J-2 BECKTON JULIAN GG B571

1-A 100% # 387580 Tattoo: WF2 B571

Birth: 3-27-92

Beckton Julian 6592	Beckton Trojan 5253	BWt	65
	Lchmn Christy 2339	WR	113
BECKTON JULIAN 7526G	Beckton Gisa 4454	ADG	3.18
Ref.	Beckton Lalaxigu -2	YR	112
	Beckton Julian 6592	Scr.	NA
	Bkt Belga 6746 GS	Fr.	5.0
	Beckton Xime 4736		
BKT MARTA 9A13 JL	Beckton Marwa -K		
	Bkt Marta 6498 XM		

RAAA HerdBuilder index: **191** (Top **25%** of RA breed)
 RAAA GridMaster index: **51** (Top **19%** of RA breed)

	Calv.Ease	BW	WW	YW	Milk	HPG	Stay	Maint.En.
EPDs	20	-6.6	50	77	23	15	15	-6.0
Acc.	(.87)	(.94)	(.92)	(.92)	(.90)	(.90)	(.77)	(.70)
Marb	+0.42	(.73)	REA	-0.12	(.81)	Bfat	+0.05	(.72)

DAM

Age	3
Wt	1015
Wean Pct.	56%
Cow Eff.	118

★★★★★ for Low Maintenance, Growth, Marbling, High Cow Efficiency, Calving Ease, Stayability.

J-5 BECKTON JULIAN E423 N8

1-A 100% # 3777967 Tattoo: BSF7 E423

Birth: 3-24-17

Beckton Julian X721 E6	Beckton Julian U699 L5	BWt	53
	Beckton Lana U329 EP	WR	106
BECKTON JULIAN Z382 J7	Beckton Julian U699 L5	ADG	2.97
Ref. J	Beckton Larkaba X064 J	YR	105
	Beckton Nebula X096 N4	Scr.	37
	Beckton Minola X670 N	Fr.	5.0
BECKTON BELGA B004 N	Beckton Nebula X096 N4		
	Beckton Belga Z031 N		
	Beckton Belga X736 E		

RAAA HerdBuilder index: **217** (Top **4%** of RA breed)
 RAAA GridMaster index: **48** (Top **44%** of RA breed)

	Calv.Ease	BW	WW	YW	Milk	HPG	Stay	Maint.En.
EPDs	21	-5.6	53	87	28	11	19	-4.0
Acc.	(.32)	(.51)	(.44)	(.43)	(.27)	(.07)	(.16)	(.04)
Marb	+0.51	(.23)	REA	-0.17	(.30)	Bfat	+0.05	(.21)

DAM

Age	3
Wt	1010
Wean Pct.	52%
Cow Eff.	109

★★★★★ for Low Maintenance, Growth, Marbling, Calving Ease, Stayability.

• Reference Sires •

L-1 BECKTON LIKABLE Z057 L4
1-A 100% # 1544436 Tattoo: BKT2 Z057

Birth: 2-18-12	Beckton Likable U130 L2	Beckton Likable S633	BWt	54
		Beckton Kit S478 LN	WR	99
BECKTON LIKABLE X445 J3	Beckton Julian GJ P535	Beckton Indigo U658 JL	ADG	3.87
Ref. L	Beckton Indigo U658 JL	Beckton Indigo R567 WA	YR	113
	Beckton Likable U120 L2	Beckton Likable S633	Scr.	37
BECKTON MINOLA X107 L	Beckton Lana S718 LN	Beckton Nebula P P707	Fr.	5.0
	Beckton Minola U188 NB	Beckton Minola N729 JL		

RAAA HerdBuilder index: **178** (Top **35%** of RA breed)
RAAA GridMaster index: **51** (Top **7%** of RA breed)

	Calv.Ease	BW	WW	YW	Milk	HPG	Stay	Maint.En.
EPDs	17	-5.7	50	93	23	13	15	-12.0
Acc.	(.52)	(.78)	(.74)	(.73)	(.53)	(.08)	(.20)	(.66)
Marb	+0.59	(.34)	REA	+0.03	(.46)	Bfat	+0.02	(.29)

DAM

Age	2
Wt	700
Wean Pct.	67%
Cow Eff.	140

★★★★★ for Low Maintenance, Growth, Marbling, High Cow Efficiency, Calving Ease, Stayability.

L-4 BECKTON LIKABLE C229 R3
1-A 100% # 3487279 Tattoo: BKT5 C229

Birth: 3-16-15	Beckton Likable S633	Beckton Lancer F442 T	BWt	84
		Beckton Kit F468 JL	WR	119
BECKTON LIKABLE U130 L2	Beckton Lancer F442 T	Beckton Kit F468 JL	ADG	3.91
Ref. L	Beckton Kit S478 LN	Beckton Kit F468 JL	YR	117
	Beckton Roman J S158	TR Romeo NT379	Scr.	37
BECKTON TAMARA X447 J	Beckton Belga K285 JL	Beckton Justice CH M056	Fr.	5.0
	Beckton Tamara R834 JC	Beckton Tamara J229 NP		

RAAA HerdBuilder index: **192** (Top **18%** of RA breed)
RAAA GridMaster index: **49** (Top **28%** of RA breed)

	Calv.Ease	BW	WW	YW	Milk	HPG	Stay	Maint.En.
EPDs	14	-1.8	62	100	22	10	18	-2.0
Acc.	(.38)	(.62)	(.56)	(.55)	(.38)	(.09)	(.20)	(.45)
Marb	+0.34	(.30)	REA	+0.18	(.40)	Bfat	+0.04	(.26)

DAM

Age	5
Wt	1240
Wean Pct.	57%
Cow Eff.	120

★★★★★ for Low Maintenance, Growth, Marbling, Rib-eye area, High Cow Efficiency, Calving Ease, Stayability.

L-2 BECKTON LIKABLE B032 C5
1-A 100% # 1705725 Tattoo: BKB4 B032

Birth: 2-17-14	Beckton Likable X445 J3	Beckton Likable U130 L2	BWt	63
		Beckton Indigo U658 JL	WR	110
BECKTON LIKABLE Z057 L4	Beckton Likable U120 L2	Beckton Minola U188 NB	ADG	4.72
Ref. L-1	Beckton Minola X107 L	BKT Clifftop TP R288	YR	119
	Beckton Clifftop W577 E3	BKT Pine Marie R213 EP	Scr.	35
BECKTON MONA Z270 C	Beckton Cody K2 R168	Beckton Mona P539 CH	Fr.	6.0
	Beckton Mona U584 CD			

RAAA HerdBuilder index: **209** (Top **6%** of RA breed)
RAAA GridMaster index: **50** (Top **12%** of RA breed)

	Calv.Ease	BW	WW	YW	Milk	HPG	Stay	Maint.En.
EPDs	19	-5.9	49	94	26	14	18	-3.0
Acc.	(.45)	(.69)	(.65)	(.64)	(.41)	(.02)	(.17)	(.47)
Marb	+0.59	(.20)	REA	-0.10	(.39)	Bfat	+0.04	(.19)

DAM

Age	2
Wt	884
Wean Pct.	50%
Cow Eff.	106

★★★★★ for Low Maintenance, Growth, Gainability, Marbling, Calving Ease, Stayability.



Likeable B032 (L-2)

L-3 BECKTON LIKABLE B274 L5
1-A 100% # 1706177 Tattoo: BKT4 B274

Birth: 3-19-14	Beckton Likable X445 J3	Beckton Likable U130 L2	BWt	75
		Beckton Indigo U658 JL	WR	112
BECKTON LIKABLE Z057 L4	Beckton Likable U120 L2	Beckton Minola U188 NB	ADG	4.09
Ref. L-1	Beckton Minola X107 L	Beckton Loki CL S284	YR	108
	Beckton Loki X833 H4	Beckton Vernice T447 HT	Scr.	36
BECKTON LANA Z216 L	Beckton Likable U120 L2	Beckton Lana U775 NB	Fr.	5.0
	Beckton Lana X157 L			

RAAA HerdBuilder index: **168** (Top **52%** of RA breed)
RAAA GridMaster index: **50** (Top **19%** of RA breed)

	Calv.Ease	BW	WW	YW	Milk	HPG	Stay	Maint.En.
EPDs	15	-3.3	59	98	22	14	15	-7.0
Acc.	(.30)	(.47)	(.41)	(.42)	(.30)	(.05)	(.15)	(.38)
Marb	+0.48	(.24)	REA	-0.04	(.33)	Bfat	+0.03	(.21)

DAM

Age	2
Wt	1060
Wean Pct.	43%
Cow Eff.	91

★★★★★ for Low Maintenance, Growth, Gainability, Marbling, Calving Ease, Stayability.

L-5 BECKTON LEGEND C313 C2
1-A 100% # 3487801 Tattoo: BKB5 C313

Birth: 3-21-15	Beckton Lancer F442 T	Beckton Lancer T A664	BWt	78
		Bkt Suffeina A828 DM	WR	112
BECKTON LEGEND S670	Beckton Julian GG B571	Beckton Kit A517 NP	ADG	3.68
Ref. L	Beckton Kit F468 JL	Beckton Clifftop T C075	YR	110
	BKT Clifftop TP R288	Beckton Christy K209 CO	Scr.	38
BECKTON MINOLA W808 C	Beckton Cody KH M390	Beckton Minola M310 CD	Fr.	5.0
	Beckton Minola R604 CD			

RAAA HerdBuilder index: **195** (Top **16%** of RA breed)
RAAA GridMaster index: **49** (Top **29%** of RA breed)

	Calv.Ease	BW	WW	YW	Milk	HPG	Stay	Maint.En.
EPDs	15	-1.7	53	85	23	12	18	-6.0
Acc.	(.36)	(.55)	(.49)	(.50)	(.32)	(.09)	(.17)	(.48)
Marb	+0.36	(.23)	REA	+0.10	(.35)	Bfat	+0.02	(.23)

DAM

Age	6
Wt	1245
Wean Pct.	53%
Cow Eff.	113

★★★★★ for Low Maintenance, Growth, Marbling, Calving Ease, Stayability.

• Reference Sires •

L-6 BECKTON LEGEND E032 E3
1-A 100% # 3777405 Tattoo: BKT7 E032

Birth: 2-16-17	Beckton Legend S670	Beckton Lancer F442 T	BWt 62
		Beckton Kit F468 JL	WR 108
BECKTON LEGEND C313 C2	Ref. L-5	BKT Clifftop TP R288	ADG 3.30
	Beckton Minola W808 C	Beckton Minola R604 CD	YR 112
	Beckton Epic A286 E7	Beckton Epic Y484 N6	Scr. 35
BECKTON EMERA C066 E		Beckton Larkaba Y648 E	Fr. 5.0
	Beckton Emera A029 D	Beckton Dominor Y005 V6	
		Beckton Emera Y009 D	

RAAA HerdBuilder index: **206** (Top 8% of RA breed)

RAAA GridMaster index: **50** (Top 12% of RA breed)

DAM	
Age	2
Wt	710
Wean Pct.	62%
Cow Eff.	130

Calv.Ease	BW	WW	YW	Milk	HPG	Stay	Maint.En.	
EPDs	21	-3.6	57	96	24	11	-5.0	
Acc.	(.33)	(.52)	(.44)	(.43)	(.21)	(.12)	(.02)	
Marb	+0.36	(.19)	REA	+0.15	(.28)	Bfat	+0.04	(.17)

★★★★★ for Low Maintenance, Growth, Marbling, Rib-eye area, High Cow Efficiency, Calving Ease, Stayability.

L-8 BECKTON LEGEND E464 L4
1-A 100% # 3776589 Tattoo: BKT7 E464

Birth: 3-26-17	Beckton Legend X561 J2	Beckton Legend S670	BWt 85
		Beckton Lana T279 JO	WR 103
BECKTON LEGEND Z689 J3	Ref. L	Beckton Julian G5 S107	ADG 3.61
	Beckton Larkaba W868 J	Beckton Larkaba S663 JE	YR 108
	Beckton Likable U120 L2	Beckton Likable S633	Scr. 34
BECKTON UCOLA X143 L		Beckton Lana S718 LN	Fr. 6.0
	Beckton Ucola U709 LO	Beckton Loki CL S284	
		Beckton Ucola S513 HU	

RAAA HerdBuilder index: **188** (Top 23% of RA breed)

RAAA GridMaster index: **50** (Top 17% of RA breed)

DAM	
Age	7
Wt	1220
Wean Pct.	47%
Cow Eff.	100

Calv.Ease	BW	WW	YW	Milk	HPG	Stay	Maint.En.	
EPDs	16	-0.9	62	100	21	11	17	0.0
Acc.	(.31)	(.51)	(.44)	(.43)	(.24)	(.02)	(.16)	(.18)
Marb	+0.36	(.20)	REA	+0.08	(.30)	Bfat	+0.03	(.18)

★★★★★ for Low Maintenance, Growth, Marbling, Calving Ease, Stayability.



Nebula P707 (N-1)

N-1 BECKTON NEBULA P P707
1-A 100% # 979031 Tattoo: BKT4 P707

Birth: 4-1-04	Beckton Neptune R2 K065	Beckton Neptune RR B284	BWt 68
		Beckton Lana C735 TP	WR 127
BECKTON NEBULA M045	Ref. N	Beckton Julian GG B571	ADG 3.85
	Beckton Belga K285 JL	Beckton Belga G493 HR	YR 122
	Beckton Epic K1 K863	Beckton Epic KN H110	Scr. 37
BECKTON LANA M809 EP		Beckton Rose H019 SC	Fr. 5.0
	Beckton Lana K253 DM	Beckton Dominor ZJ H657	
		Beckton Lana HA34 DM	

RAAA HerdBuilder index: **198** (Top 17% of RA breed)

RAAA GridMaster index: **49** (Top 37% of RA breed)

DAM	
Age	2
Wt	890
Wean Pct.	71%
Cow Eff.	150

Calv.Ease	BW	WW	YW	Milk	HPG	Stay	Maint.En.	
EPDs	16	-5.8	53	93	24	12	18	-5.0
Acc.	(.83)	(.91)	(.90)	(.90)	(.86)	(.84)	(.70)	(.70)
Marb	+0.70	(.70)	REA	-0.32	(.76)	Bfat	+0.06	(.68)

★★★★★ for Low Maintenance, Growth, Marbling, High Cow Efficiency, Calving Ease, Stayability.

L-7 BECKTON LIKABLE E391 N4
1-A 100% # 3777591 Tattoo: BKB7 E391

Birth: 3-23-17	Beckton Likable U130 L2	Beckton Likable S633	BWt 83
		Beckton Kit S478 LN	WR 115
BECKTON LIKABLE Y124 L3	Ref. L	Beckton Lasso P741	ADG 3.44
	BKT Pine Marie S802 LO	BKT Pine Marie P475 LN	YR 115
	Beckton Nebula T398 V3	Beckton Nebula L P093	Scr. 37
BECKTON LANA X466 N		Beckton Minerva J615 VG	Fr. 6.0
	Beckton Lana T226 NB	Beckton Nebula E P084	
		Beckton Lana P026 DM	

RAAA HerdBuilder index: **230** (Top 1% of RA breed)

RAAA GridMaster index: **49** (Top 20% of RA breed)

DAM	
Age	7
Wt	1220
Wean Pct.	53%
Cow Eff.	111

Calv.Ease	BW	WW	YW	Milk	HPG	Stay	Maint.En.	
EPDs	14	-2.7	61	100	24	12	22	-1.0
Acc.	(.33)	(.53)	(.46)	(.45)	(.26)	(.07)	(.14)	(.18)
Marb	+0.41	(.20)	REA	-0.07	(.32)	Bfat	+0.06	(.19)

★★★★★ for Low Maintenance, Growth, Marbling, Calving Ease, Stayability.

N-2 BECKTON NEBULA E P084
1-A 100% # 978410 Tattoo: BKT4 P084

Birth: 2-27-04	Beckton Neptune R2 K065	Beckton Neptune RR B284	BWt 54
		Beckton Lana C735 TP	WR 100
BECKTON NEBULA M045	Ref. N	Beckton Julian GG B571	ADG 3.34
	Beckton Belga K285 JL	Beckton Belga G493 HR	YR 100
	Beckton Epic K F075	Beckton Epic D404	Scr. 33
BKT PINE MARIE M119 EP		Beckton Belga D483 KR	Fr. 4.0
	Bkt Pine Marie D126 JL	Beckton Julian GG B571	
		Bkt Pine Marie B849 JL	

RAAA HerdBuilder index: **218** (Top 5% of RA breed)

RAAA GridMaster index: **47** (Top 72% of RA breed)

DAM	
Age	2
Wt	885
Wean Pct.	55%
Cow Eff.	116

Calv.Ease	BW	WW	YW	Milk	HPG	Stay	Maint.En.	
EPDs	20	-7.9	40	65	26	13	19	-7.0
Acc.	(.45)	(.74)	(.69)	(.70)	(.55)	(.51)	(.37)	(.66)
Marb	+0.42	(.34)	REA	-0.38	(.46)	Bfat	+0.08	(.30)

★★★★★ for Low Maintenance, Marbling, Calving Ease, Stayability.

• Reference Sires •

N-3 BECKTON NEW ERA A908 A2
1-A 100% # 1626362 Tattoo: BKT3 A908

Birth: 5-7-13

Beckton Nebula P P707	Beckton Nebula M045	BWt	82	
	Beckton Lana M809 EP	WR	114	
BECKTON NEW ERA Y194	Beckton Justice C1 R483	ADG	4.08	
Ref. N	BKT Larkeisa T310 JC	BKT Larkeisa R775 JC	YR	115
	Beckton Cody KH M390	Scr.	NA	
Beckton Cody K1 P014	Beckton Rose M126 WR	Fr.	5.0	
BECKTON LANA U612 CD	Beckton Epic KM M115			
	Beckton Lana K840 LN			

RAAA HerdBuilder index: **191** (Top 20% of RA breed)
RAAA GridMaster index: **47** (Top 57% of RA breed)

DAM	Calv.Ease	BW	WW	YW	Milk	HPG	Stay	Maint.En.
Age 5	EPDs 12	-0.4	64	108	29	9	20	1.0
Wt 1070	Acc. (.24)	(.44)	(.39)	(.40)	(.26)	(.10)	(.21)	(.19)
Wean Pct. 57%								
Cow Eff. 120	Marb +.28	(.24)	REA -.25	(.29)	Bfat +.04	(.20)		



New Era A908 (N-3)

★★★★★ for Low Maintenance, Growth, Gainability, Marbling, High Cow Efficiency, Calving Ease, Stayability.

N-4 BECKTON NEBULA B557 J3
1-A 100% # 1705884 Tattoo: BKT4 B557

Birth: 4-1-14

Beckton Nebula M045	Beckton Neptune R2 K065	BWt	80
	Beckton Belga K285 JL	WR	111
BECKTON NEBULA P P707	Beckton Epic K1 K863	ADG	3.81
Ref. N-1	Beckton Lana K253 DM	YR	105
	Beckton Justice C K449	Scr.	38
Beckton Justice CH M056	Beckton Ruth K802 HD	Fr.	5.0
BECKTON LARKABA T813 JC	Beckton Julian GG B571		
	Beckton Larkaba L312 LN		

RAAA HerdBuilder index: **213** (Top 5% of RA breed)
RAAA GridMaster index: **51** (Top 9% of RA breed)

DAM	Calv.Ease	BW	WW	YW	Milk	HPG	Stay	Maint.En.
Age 7	EPDs 14	-4.6	53	95	28	11	20	-7.0
Wt 1166	Acc. (.48)	(.69)	(.65)	(.64)	(.45)	(.22)	(.24)	(.45)
Wean Pct. 50%								
Cow Eff. 105	Marb +.59	(.28)	REA +.06	(.44)	Bfat +.04	(.27)		

★★★★★ for Low Maintenance, Growth, Marbling, Calving Ease, Stayability.

N-6 BECKTON NEW ERA D478 C2
1-A 100% # 3551239 Tattoo: BSF6 D478

Birth: 3-24-16

Beckton Nebula P P707	Beckton Nebula M045	BWt	76	
	Beckton Lana M809 EP	WR	117	
BECKTON NEW ERA Y194	Beckton Justice C1 R483	ADG	3.67	
Ref. N	BKT Larkeisa T310 JC	BKT Larkeisa R775 JC	YR	107
	Beckton Cherokee N N479	Scr.	36	
Beckton Cherokee T450 L3	Beckton Annie M337 LN	Fr.	5.5	
BECKTON COCA X734 C	Beckton Nebula N R573			
	Beckton Coca R375 WR			

RAAA HerdBuilder index: **196** (Top 15% of RA breed)
RAAA GridMaster index: **47** (Top 67% of RA breed)

DAM	Calv.Ease	BW	WW	YW	Milk	HPG	Stay	Maint.En.
Age 6	EPDs 17	-4.5	54	90	25	12	19	-4.0
Wt 1025	Acc. (.38)	(.54)	(.49)	(.50)	(.36)	(.18)	(.18)	(.19)
Wean Pct. 62%								
Cow Eff. 130	Marb +.36	(.25)	REA -.23	(.38)	Bfat +.05	(.23)		

★★★★★ for Low Maintenance, Growth, Marbling, High Cow Efficiency, Calving Ease, Stayability.

N-5 BECKTON NEW ERA C209 J2
1-A 100% # 3487198 Tattoo: BKT5 C209

Birth: 3-14-15

Beckton Nebula P P707	Beckton Nebula M045	BWt	78	
	Beckton Lana M809 EP	WR	119	
BECKTON NEW ERA Y194	Beckton Justice C1 R483	ADG	4.31	
Ref. N	BKT Larkeisa T310 JC	BKT Larkeisa R775 JC	YR	115
	Beckton Julian G5 S107	Scr.	33	
Beckton Julian W743 H5	Beckton Kit L399 HR	Fr.	5.0	
BECKTON MINERVA Y116 J	Beckton Nebula G S237			
	Beckton Minerva F495 CH			

RAAA HerdBuilder index: **166** (Top 53% of RA breed)
RAAA GridMaster index: **49** (Top 29% of RA breed)

DAM	Calv.Ease	BW	WW	YW	Milk	HPG	Stay	Maint.En.
Age 4	EPDs 11	-0.9	64	105	23	12	17	-3.0
Wt 1125	Acc. (.37)	(.55)	(.51)	(.51)	(.36)	(.10)	(.17)	(.56)
Wean Pct. 61%								
Cow Eff. 128	Marb +.40	(.27)	REA -.12	(.38)	Bfat +.03	(.24)		

★★★★★ for Low Maintenance, Growth, Gainability, Marbling, High Cow Efficiency, Calving Ease, Stayability.

O-1 REDHILL 9B LANCER 11E
1-A 100% # 3627551 Tattoo: BKB7 ERH11

Birth: 1-3-17

Buf Crk The Right Kind U199	Buf Crk Lancer R017	BWt	85
	Buf Crk Shoshone R353	WR	NA
REDHILL U199 LANCER 9B	Beckton Julian GG B571	ADG	NA
Ref.	MRM 832 8664 9005	YR	NA
	Buf Crk Medallion N328	Scr.	NA
Buf Crk Nice'N Easy T189	Buf Crk Redpride P154	Fr.	NA
REDHILL T189 BARMAID 190W	BFCK Cherokee Cynn 4912		
	Beckton Barmaid M554 CH		

RAAA HerdBuilder index: **144** (Top 81% of RA breed)
RAAA GridMaster index: **46** (Top 70% of RA breed)

DAM	Calv.Ease	BW	WW	YW	Milk	HPG	Stay	Maint.En.
Age 8	EPDs 8	-1.6	61	92	23	15	15	-2.0
Wt NA	Acc. (.50)	(.58)	(.55)	(.54)	(.46)	(.32)	(.33)	(.19)
Wean Pct. NA%								
Cow Eff. NA	Marb +.48	(.39)	REA -.25	(.47)	Bfat +.04	(.33)		

★★★★★ for Low Maintenance, Marbling, Calving Ease, Stayability.

• Reference Sires •

O-2 SCHULER ORACLE-7142E

1-A 100% # 3778379 Tattoo: BKB7 ES142

Birth: 3-10-17

Red Crowfoot Ole's Oscar < Milk Crk Cub 722
Red Crowfoot Omega 9179J

SCHULER SUDDEN IMPACT 0004X
Ref. SOR Duchess TS 8915U < Basin Trend Setter 6074
SOR Duchess BC 4425P

Brown Commitment S7206 < LJC Lancer 806
Brown MS Shazzam P7940

SOR MARLEE CMMTMNT 0470X
SOR Marlee Beef 4511P < Lonerock Beefstake 0024
Sor Marlee Bur 0019K

BWt	76
WR	98
ADG	NA
YR	98
Scr.	37
Fr.	5.5

RAAA HerdBuilder index: **237** (Top 1% of RA breed)
RAAA GridMaster index: **52** (Top 5% of RA breed)

DAM		Calv.Ease	BW	WW	YW	Milk	HPG	Stay	Maint.En.	
Age	5	EPDs	18	-2.4	67	106	22	8	21	3.0
Wt	NA	Acc.	(.35)	(.51)	(.46)	(.45)	(.23)	(.20)	(.12)	(.08)
Wean Pct.	NA	Marb	+.81 (.27)		REA	+.25 (.33)		Bfat	+.02 (.24)	
Cow Eff.	NA									

S-2 BECKTON SCAMP E175 N5

1-A 100% # 3776509 Tattoo: BKT7 E175

Birth: 3-7-17

Beckton Scamp X458 H3 < Beckton Scamp T A825
BKT Pine Marie R401 HU

BECKTON SCAMP B720 L4
Ref. S Beckton Larkaba Y448 L < Beckton Likable U130 L2
Beckton Larkaba T655 NB

Beckton Nebula T398 V3 < Beckton Nebula L P093
Beckton Minerva J615 VG

BECKTON BELGA W103 N
Beckton Belga T551 EP < Beckton Epic K3 M606
Beckton Belga K285 JL

BWt	78
WR	106
ADG	4.06
YR	114
Scr.	41
Fr.	5.5

RAAA HerdBuilder index: **191** (Top 19% of RA breed)
RAAA GridMaster index: **50** (Top 16% of RA breed)

DAM		Calv.Ease	BW	WW	YW	Milk	HPG	Stay	Maint.En.	
Age	8	EPDs	18	-5.2	54	96	25	10	16	-10.0
Wt	1015	Acc.	(.32)	(.51)	(.43)	(.43)	(.24)	(.04)	(.15)	(.17)
Wean Pct.	55%	Marb	+.31 (.22)		REA	+.09 (.30)		Bfat	+.03 (.17)	
Cow Eff.	116									

★★★★★ for Low Maintenance, Marbling, Rib-eye area, Calving Ease, Stayability.

★★★★★ for Low Maintenance, Growth, Gainability, Marbling, High Cow Efficiency, Calving Ease, Stayability.

R-1 BECKTON RANGER B006 D5

1-A 100% # 1705764 Tattoo: BSF4 B006

Birth: 2-11-14

Beckton Ranger T603 H3 < Beckton Ranger 9479R
Beckton Rose N044 HU

BECKTON RANGER Z225 J4
Ref. R Beckton Mona U564 JT < Beckton Jet L P491
Beckton Mona P874 WR

Beckton Dominor W640 C5 < Beckton Dominor Z1 R610
Beckton Mona R166 CQ

BECKTON SUFFEINA Z731 D
Beckton Suffeina W471 W < Beckton Warrior N645 T1
Beckton Suffeina P671 LN

BWt	69
WR	113
ADG	4.03
YR	109
Scr.	35
Fr.	6.0

RAAA HerdBuilder index: **139** (Top 86% of RA breed)
RAAA GridMaster index: **49** (Top 24% of RA breed)

DAM		Calv.Ease	BW	WW	YW	Milk	HPG	Stay	Maint.En.	
Age	2	EPDs	15	-2.0	55	91	24	11	11	-7.0
Wt	918	Acc.	(.40)	(.66)	(.61)	(.60)	(.39)	(.07)	(.16)	(.51)
Wean Pct.	54%	Marb	+.54 (.21)		REA	+.08 (.38)		Bfat	+.04 (.19)	
Cow Eff.	114									

★★★★★ for Low Maintenance, Growth, Gainability, Marbling, Calving Ease.

W-1 BECKTON WARRIOR D359 L6

1-A 100% # 3551786 Tattoo: BKT6 D359

Birth: 3-20-16

Beckton Warrior W534 N4 < Beckton Warrior C1 S337
BKT Larkeisa S055 NB

BECKTON WARRIOR Y108 E5
Ref. W Beckton Susan W058 E < Beckton Epic T330 L5
Beckton Susan T048 NB

Beckton Loki CL S284 < Beckton Loki C M740
Beckton Lakme J460 LT

BECKTON LANA W463 L
Beckton Lana R327 EP < Beckton Epic KM M115
Beckton Lana K840 LN

BWt	78
WR	117
ADG	3.94
YR	113
Scr.	39
Fr.	5.5

RAAA HerdBuilder index: **154** (Top 71% of RA breed)
RAAA GridMaster index: **46** (Top 72% of RA breed)

DAM		Calv.Ease	BW	WW	YW	Milk	HPG	Stay	Maint.En.	
Age	7	EPDs	18	-4.1	55	89	27	11	13	-4.0
Wt	1135	Acc.	(.35)	(.64)	(.58)	(.56)	(.32)	(.08)	(.17)	(.19)
Wean Pct.	56%	Marb	+.22 (.21)		REA	-.12 (.34)		Bfat	+.05 (.20)	
Cow Eff.	118									

★★★★★ for Low Maintenance, Growth, Marbling, High Cow Efficiency, Calving Ease, Stayability.

S-1 BECKTON SCAMP D325 N5

1-A 100% # 3551849 Tattoo: BKT6 D325

Birth: 3-18-16

Beckton Scamp X494 E3 < Beckton Scamp T A825
Beckton Lana S074 EP

BECKTON SCAMP A627 J4
Ref. S Beckton Serena R023 JC < Beckton Justice Cc N265
Beckton Serena N469 JC

Beckton Nebula W065 C3 < Beckton Nebula T269 E2
Beckton Lana T104 CT

BECKTON TAMARA Y039 N
Beckton Tamara W232 J < Beckton Julian GG B571
Beckton Tamara S025 EP

BWt	72
WR	107
ADG	4.22
YR	109
Scr.	36
Fr.	5.5

RAAA HerdBuilder index: **152** (Top 74% of RA breed)
RAAA GridMaster index: **49** (Top 30% of RA breed)

DAM		Calv.Ease	BW	WW	YW	Milk	HPG	Stay	Maint.En.	
Age	5	EPDs	19	-5.7	52	93	29	15	11	-12.0
Wt	1045	Acc.	(.35)	(.62)	(.57)	(.56)	(.33)	(.05)	(.14)	(.18)
Wean Pct.	57%	Marb	+.21 (.20)		REA	+.04 (.36)		Bfat	+.03 (.15)	
Cow Eff.	119									

★★★★★ for Low Maintenance, Growth, Gainability, Marbling, High Cow Efficiency, Calving Ease.

W-2 BECKTON WARRIOR E215 E7

1-A 100% # 3778187 Tattoo: BSF7 E215

Birth: 3-12-17

Beckton Warrior Y108 E5 < Beckton Warrior W534 N4
Beckton Susan W058 E

BECKTON WARRIOR C695 W6
Ref. W Beckton Lana Y033 W < Beckton Warrior W534 N4
Beckton Lana W370 E

Beckton Emperor A165 W4 < Beckton Emperor Y459 J3
Beckton Minola Y634 W

BECKTON SUFFEINA C124 E
Beckton Suffeina A439 N < Beckton Nebula E P084
Beckton Suffeina W294 D

BWt	48
WR	108
ADG	3.56
YR	111
Scr.	34
Fr.	5.5

RAAA HerdBuilder index: **158** (Top 67% of RA breed)
RAAA GridMaster index: **48** (Top 46% of RA breed)

DAM		Calv.Ease	BW	WW	YW	Milk	HPG	Stay	Maint.En.	
Age	2	EPDs	21	-8.1	50	86	26	14	12	-10.0
Wt	870	Acc.	(.31)	(.49)	(.40)	(.40)	(.22)	(.01)	(.10)	(.03)
Wean Pct.	53%	Marb	+.44 (.19)		REA	-.11 (.29)		Bfat	+.05 (.16)	
Cow Eff.	111									

★★★★★ for Low Maintenance, Growth, Marbling, Calving Ease.

Sale Terms and Conditions

Except for those stated in the terms and conditions below, there are no warranties, either expressed or implied, as to the merchantability or fitness for a particular purpose with respect to the cattle being sold at this auction. The warranties and guarantees set forth in the "Terms and Conditions" are in lieu of all other warranties, either expressed or implied, and the remedies provided therein shall be the sole and exclusive remedy for the Buyer, or any party claiming through Buyer, for any breach of warranty or guarantee therein provided, and all other obligations or liabilities.

The information in the catalog is believed to be accurate, and the information seller believes to be most representative. It is the nature of seller's business that the seller engages in a continual process of collecting new data and information. Therefore, any information presented at the time of sale is always subject to revision, correction or update.

I. BIDDING

The Auctioneer in charge will settle any disputes as to bids, and his decision on such matters shall be final.

II. TERMS

Terms of sale are cash or personal check unless satisfactory credit arrangements have been made with vendor prior to sale.

III. PURCHASER'S RISK

Each animal becomes the risk of the purchaser as soon as sold, but it shall be the obligation of the Seller to see that animals are fed and cared for free of charge to purchaser, until loaded for shipment or until the expiration of 48 hours after the sale, whichever occurs sooner.

IV. DELIVERY

For any animals for which seller's arrange delivery, the following terms shall apply. Each animal becomes the risk of the purchaser as soon as sold, and through the time of delivery. The seller will arrange transportation and delivery schedules, and may combine animals from one or more purchasers for convenience and to reduce costs. If delivery is arranged, seller assumes no other liability. Once the purchaser has been notified of the date and approximate time of delivery (morning, afternoon, evening, etc.), it is the responsibility of the purchaser to arrange adequate and agreeable location and facilities for unloading each animal. When unloaded at the agreed upon location, all care and management of the animal is the responsibility of the purchaser.

V. CERTIFICATE OF REGISTRY

A transferred certificate of registry will be furnished to the purchaser for each animal for which a Registration number is listed.

VI. HEALTH

All animals are eligible for interstate shipment, except as otherwise announced. Interstate health papers will be furnished for each animal requiring T.B, Bang's, and trich tests in accordance with federal and state regulations.

VII. DIVISIBILITY

The percentage of ownership interest received by the buyer, whether it is 100% or 2/3 or otherwise as defined in the catalog or by the auctioneer, may not be subsequently divided without the express written consent of the seller.

VIII. ANNOUNCEMENTS

Any changes from information of any kind in this catalog will be announced from the auction box and such announcements shall take precedence.

IX. BREEDING GUARANTEE

Any female that has had a calf prior to the date of sale shall be considered a breeder without further guarantee. All females sold as 'bred' or 'pregnant' have been pregnancy checked by a licensed veterinarian and are guaranteed bred on the day of sale. The purchaser may elect to have any female so listed rechecked at their cost within 30 days of delivery by a licensed veterinarian of their choice. Any such female determined open by this recheck may be returned to the seller for a full refund. Due to conditions out of seller's control, once a female leaves seller's possession, this is the only guarantee offered.

All bulls are sold as guaranteed breeders. Each bull has been officially fertility tested as "Satisfactory Breeder" prior to the sale. However, seller cannot guarantee against physical injury or illness following the sale. But if within 8 months following the sale, the buyer has evidence that the animal is not a breeder, the buyer may obtain a statement signed by a licensed veterinarian to that effect, such statement also indicating that there has been no injury or illness to the animal following the sale, and return the bull to the farm of the seller for adjustment. If the seller cannot then prove the animal to be a breeder, an adjustment will be made by the seller, either by substituting an animal of equal value, or by the refund of the full purchase price. Such adjustment shall be considered full settlement and satisfaction of all claims. No guarantees apply to animals which are shown following the sale.

X. GENETIC DEFECT GUARANTEE AND PARENTAGE

All parentage and pedigrees presented in the catalog are believed accurate based upon the breeding and DNA information we have available. However, parentage and pedigree information cannot be guaranteed 100%, because it is always possible that new information or new DNA technology and testing might show that there have been inadvertent errors.

Osteopetrosis: The Red Angus Association along with animal scientists have developed a DNA marker test for osteopetrosis (OS), a genetic disorder which in rare instances can cause the loss of a calf at birth. Since the test was developed, Beckton has tested every sire being used in our breeding program. Only one sire, from outside our program, tested positive as a carrier of the gene. Every sire bred and raised at Beckton has tested 'Free'. All of our major semen sires have also been tested 'Free'. We guarantee every sale animal to be OS Free, and if you have a concern, we will have any sale animal tested on request. If an animal were to test positive, we would replace the animal or refund the purchase price. The testing we have done shows no incidence of occurrence in any Beckton bloodlines for the past 30 years, and so we believe there is no safer herd than ours.

XI. RETAINED INTEREST AND SEMEN RIGHTS:

Beckton is selling full possession and one half semen interest in all the bulls in the catalog. Seller is retaining one half interest in all bulls in the catalog. This is done so we can use some of the bulls in herd and reserve the right to collect and market semen on these bulls. Any collection on our behalf would be at our expense and could be done during the off-season and at the convenience of the buyer. The buyer would have the option to share in the collection and retain semen for the buyer's use also. If semen is marketed by either party, Seller receives one half royalty interest on gross semen sales, and buyer receives one half interest. Regardless of semen collection and marketing, the buyer retains full possession, full pasture use rights, and full salvage value in these bulls.

XII. RIGHTS AND OBLIGATIONS

A. The above terms and conditions of sale shall constitute a contract between the Buyer and Seller of each animal and shall be equally binding upon both. Each sale or resale of an animal constitutes a separate transaction.

B. Neither the sale manager, the owner, nor any other person connected with the management of the sale, assumes any liability, legal or otherwise.

RAAA Herd EPD Tables

Proven and Genetic Opportunity Sires (Spring 2020)

	HB	GM	CED	BW	WW	YW	ADG	DMI	MILK	ME	HPG	CEM	STAY	MARB	YG	CW	REA	FAT
Min.	-54	32	-2	-12.5	-15	-44	-.18	-0.83	0	-24	-6	-7	-2	-.88	-1.34	-77	-1.01	-.26
Avg.	168	48	12	-1.3	59	93	.21	1.32	23	-1	11	7	16	.40	.10	21	.05	.02
Max.	275	64	25	8.7	104	175	.47	3.31	48	22	27	17	27	1.49	.48	94	2.54	.13
1%	229	54	20	-6.0	83	133	.33	0.02	34	-13	18	12	22	.91	-.36	52	.85	-.08
2%	223	53	19	-5.5	80	129	.32	0.23	33	-13	18	12	21	.84	-.16	48	.67	-.03
3%	217	52	19	-5.2	78	125	.31	0.34	32	-13	17	11	21	.79	-.08	45	.57	-.01
4%	214	52	18	-4.9	76	123	.30	0.43	31	-13	16	11	21	.76	-.05	44	.50	-.01
5%	211	52	18	-4.7	75	121	.30	0.51	31	-12	16	11	21	.74	-.04	42	.45	-.01
10%	202	50	17	-3.9	71	115	.28	0.72	29	-10	15	10	19	.65	.01	37	.32	.00
15%	195	50	16	-3.4	69	110	.27	0.85	28	-8	14	9	19	.60	.03	33	.25	.01
20%	190	49	15	-3.0	67	107	.26	0.95	27	-6	14	9	18	.55	.05	31	.20	.01
25%	186	49	15	-2.6	65	104	.25	1.03	26	-4	13	8	18	.51	.06	29	.16	.01
30%	182	49	14	-2.3	63	101	.24	1.10	26	-3	13	8	17	.48	.07	27	.12	.02
35%	178	48	14	-2.0	62	99	.23	1.17	25	-3	12	8	17	.45	.08	25	.09	.02
40%	175	48	13	-1.8	61	97	.23	1.23	24	-2	12	8	17	.43	.09	24	.07	.02
45%	172	48	13	-1.5	60	95	.22	1.29	24	-1	11	7	16	.40	.10	22	.04	.02
50%	168	47	12	-1.2	59	93	.22	1.35	23	0	11	7	16	.38	.11	21	.01	.03
55%	165	47	12	-1.0	58	91	.21	1.40	23	0	11	7	15	.35	.12	19	-.02	.03
60%	162	47	11	-0.7	56	89	.20	1.46	22	1	10	6	15	.33	.13	18	-.05	.03
65%	159	47	11	-0.5	55	87	.20	1.51	21	2	10	6	15	.31	.14	16	-.07	.03
70%	155	46	11	-0.2	54	84	.19	1.58	21	3	10	6	14	.29	.15	14	-.09	.04
75%	150	46	10	0.1	52	82	.18	1.64	20	3	9	6	14	.27	.16	13	-.12	.04
80%	145	46	10	0.5	50	79	.17	1.72	19	4	9	5	13	.24	.17	11	-.15	.04
85%	139	45	9	0.8	48	75	.16	1.81	18	5	8	5	12	.21	.19	9	-.19	.05
90%	131	45	8	1.3	46	70	.15	1.92	17	6	8	4	11	.17	.21	6	-.23	.05
95%	116	44	7	2.2	40	62	.12	2.10	14	7	6	3	9	.11	.24	1	-.30	.06

Active Cows (Spring 2020)

	HB	GM	CED	BW	WW	YW	ADG	DMI	MILK	ME	HPG	CEM	STAY	MARB	YG	CW	REA	FAT
Min.	-48	34	-3	-10.8	0	0	-.03	-0.86	-3	-24	-1	-9	-5	-.38	-.98	-25	-.61	-.20
Avg.	172	47	12	-1.1	56	88	.20	1.26	24	1	11	7	17	.36	.10	17	-.02	.02
Max.	280	56	25	8.7	95	158	.47	3.67	49	28	25	15	29	1.39	.43	69	2.00	.10
1%	226	51	18	-5.5	74	119	.29	0.30	34	-12	18	11	23	.77	-.09	40	.44	-.02
2%	220	51	18	-5.0	73	116	.28	0.40	33	-10	17	11	23	.71	-.05	37	.37	-.01
3%	216	50	17	-4.7	71	114	.28	0.47	32	-9	16	10	22	.68	-.03	36	.32	-.01
4%	214	50	17	-4.5	70	112	.27	0.52	32	-8	16	10	22	.66	-.01	35	.29	.00
5%	211	50	17	-4.3	69	111	.27	0.57	31	-7	15	10	21	.63	-.01	34	.27	.00
10%	203	49	16	-3.6	67	106	.25	0.74	30	-5	14	9	21	.56	.02	30	.19	.00
15%	197	49	15	-3.1	65	103	.24	0.85	28	-4	13	9	20	.51	.04	27	.14	.01
20%	192	48	14	-2.7	63	100	.24	0.93	28	-3	13	8	19	.47	.05	25	.11	.01
25%	188	48	14	-2.3	62	98	.23	1.01	27	-2	12	8	19	.44	.06	24	.08	.01
30%	185	48	13	-2.1	60	96	.22	1.07	26	-1	12	8	18	.42	.07	22	.05	.02
35%	181	47	13	-1.8	59	94	.22	1.13	26	0	12	8	18	.39	.08	21	.03	.02
40%	178	47	13	-1.5	58	92	.21	1.18	25	0	11	7	18	.37	.09	20	-.01	.02
45%	175	47	12	-1.3	57	90	.21	1.23	24	1	11	7	17	.35	.10	18	-.03	.02
50%	172	47	12	-1.1	56	88	.20	1.28	24	1	11	7	17	.34	.10	17	-.04	.02
55%	169	46	11	-0.8	55	86	.19	1.33	23	2	10	7	16	.32	.11	16	-.06	.02
60%	166	46	11	-0.6	54	84	.19	1.38	23	3	10	6	16	.30	.12	15	-.08	.03
65%	163	46	11	-0.4	53	82	.18	1.43	22	3	10	6	16	.28	.13	13	-.11	.03
70%	159	46	10	-0.1	52	80	.18	1.48	21	4	10	6	15	.27	.13	12	-.12	.03
75%	155	45	10	0.3	50	78	.17	1.54	21	4	9	6	15	.25	.14	11	-.15	.03
80%	151	45	10	0.6	49	75	.16	1.60	20	5	9	5	14	.23	.15	9	-.18	.04
85%	145	45	9	0.9	47	72	.15	1.68	19	6	8	5	14	.20	.17	7	-.20	.04
90%	138	44	8	1.3	44	68	.14	1.78	18	6	8	4	13	.18	.18	5	-.24	.04
95%	127	44	7	2.1	40	61	.12	1.92	15	8	7	3	12	.14	.21	1	-.29	.05

Non-Parents (Spring 2020)

	HB	GM	CED	BW	WW	YW	ADG	DMI	MILK	ME	HPG	CEM	STAY	MARB	YG	CW	REA	FAT
Min.	-65	31	-5	-11.1	0	0	-0.02	-1.20	-1	-18	-6	-6	0	-.71	-1.06	-35	-.70	-.20
Avg.	169	48	12	-1.4	58	91	.21	1.29	23	-1	11	7	16	.40	.10	20	.03	.02
Max.	290	59	26	9.7	102	164	.47	3.31	44	18	38	16	28	1.37	.45	71	2.15	.14
1%	221	52	19	-5.5	77	123	.30	0.11	31	-11	17	11	22	.79	-.11	43	.49	-.02
2%	215	52	18	-5.1	75	120	.29	0.28	30	-10	16	11	21	.74	-.07	40	.43	-.02
3%	211	51	18	-4.7	73	118	.29	0.38	30	-9	16	10	21	.71	-.06	39	.38	-.01
4%	208	51	17	-4.5	72	116	.28	0.45	29	-8	15	10	20	.69	-.04	37	.35	-.01
5%	206	51	17	-4.3	72	115	.28	0.50	29	-8	15	10	20	.67	-.03	36	.32	-.01
10%	198	50	16	-3.7	69	110	.27	0.70	28	-6	14	9	19	.61	.01	33	.24	.00
15%	192	49	15	-3.2	67	107	.26	0.84	27	-5	13	9	19	.56	.03	30	.20	.01
20%	188	49	15	-2.9	65	104	.25	0.95	26	-4	13	8	18	.53	.05	28	.16	.01
25%	184	49	14	-2.6	64	102	.24	1.04	26	-3	12	8	18	.50	.06	27	.13	.01
30%	181	48	14	-2.3	62	99	.23	1.11	25	-3	12	8	17	.47	.07	25	.10	.02
35%	178	48	13	-2.0	61	97	.23	1.18	25	-2	12	8	17	.44	.08	24	.08	.02
40%	176	48	13	-1.8	60	96	.22	1.23	24	-1	11	7	17	.42	.09	22	.05	.02
45%	173	48	13	-1.6	59	94	.22	1.29	24	-1	11	7	16	.40	.10	21	.03	.02
50%	170	47	12	-1.4	58	92	.21	1.34	23	0	11	7	16	.38	.10	20	.01	.02
55%	167	47	12	-1.1	57	90	.21	1.39	23	0	11	7	16	.36	.11	19	-.01	.03
60%	164	47	12	-0.9	56	88	.20	1.44	23	1	10	7	15	.34	.12	18	-.03	.03
65%	161	47	11	-0.7	55	86	.19	1.49	22	1	10	6	15	.32	.13	17	-.05	.03
70%	158	46	11	-0.4	53	84	.19	1.54	21	2	10	6	15	.31	.14	15	-.07	.03
75%	154	46	11	-0.2	52	82	.18	1.60	21	3	10	6	14	.29	.14	14	-.09	.03
80%	150	46	10	0.1	50	79	.17	1.66	20	3	9	6	14	.27	.15	12	-.11	.04
85%	144	46	10	0.4	49	76	.16	1.74	19	4	9	5	13	.25	.17	10	-.14	.04
90%	136	45	9	0.9	46	71	.15	1.83	18	5	8	5	12	.22	.18	8	-.18	.04
95%	123	45	8	1.6	42	64	.13	1.98	16	6	7	4	10	.18	.21	4	-.24	.05

EPD Accuracies and Possible Change

EPDs are predictions, not true values, and we can therefore expect that EPDs will change from sire evaluation, as more information (i.e. progeny data) is included. A possible change value is an estimate of the amount of change (in trait units) that can be expected for a given EPD.

Technically, there is a 68% chance that the real genetic value (an EPD with a accuracy of 1.0) for any trait lies between its EPD plus its possible change value and its EPD minus its possible change value. For example, if a sire has a weaning EPD of +25 lb. and a possible change value of 10 lb., we can expect the true genetic value to be between +15 lb. (25 - 10) and +35 lb. (25 + 10) 68% of the time. We should not be surprised if his EPD in next year's evaluation is as high as +35 or as low as +15. If next year's EPD should happen to be slightly outside of this

range, keep in mind there is nearly a one-in-three chance of that happening; however, significantly larger deviations can occur.

Possible change is simply another way of expressing accuracy of an EPD. High accuracy sires will have small possible changes and vice versa. Many breeders feel that possible change values complement accuracies and help them determine just how thoroughly an animal has been evaluated. The accuracy/possible change chart lists possible changes in EPDs that can be expected with different levels of accuracy for the various traits.

For more information on possible change values, please see the article by Dr. Bob Hough titled "Understanding EPD Accuracies and Possible Change". This article can be downloaded from the Red Angus Association of America website at www.redangus.org.

Accuracy	CED	BW	WW	YW	DMI	MILK	ME	HPG	CEM	STAY	MARB	YG	CW	REA	FAT
0.0	7.8	3.0	16.3	25.7	.92	11.9	3	11	7.9	7.1	.26	.20	19.3	.43	.04
0.1	7.0	2.7	14.7	23.1	.82	10.7	2	10	7.1	6.4	.23	.18	17.4	.39	.04
0.2	6.2	2.4	13.0	20.6	.73	9.5	2	9	6.3	5.7	.21	.16	15.4	.34	.03
0.3	5.4	2.1	11.4	18.0	.64	8.3	2	8	5.5	4.9	.18	.14	13.5	.30	.03
0.4	4.7	1.8	9.8	15.5	.55	7.1	2	7	4.7	4.2	.16	.12	11.6	.26	.02
0.5	3.9	1.5	8.2	12.9	.46	6.0	1	6	3.9	3.5	.13	.10	9.7	.22	.02
0.6	3.1	1.2	6.5	10.3	.37	4.8	1	4	3.1	2.8	.10	.08	7.7	.17	.02
0.7	2.3	0.9	4.9	7.7	.27	3.6	1	3	2.4	2.1	.08	.06	5.8	.13	.01
0.8	1.6	0.6	3.3	5.1	.18	2.4	1	2	1.6	1.4	.05	.04	3.9	.09	.01
0.9	0.8	0.3	1.6	2.6	.09	1.2	0	1	0.8	0.7	.03	.02	1.9	.04	.00
1.0	0.0	0.0	0.0	0.0	.00	0.0	0	0	0.0	0.0	.00	.00	0.0	.00	.00

Sire Bloodline Charts

Name Family

- Accent A
- Cardinal C
- Cherokee C
- Clifftop C
- Clipper A
- Cody A
- Dominor D
- Epic E
- Hasten H
- Herald H
- Heritage H
- Hughes B
- Hustler H
- Javelin J
- Jet J
- Julian J
- Lancer L
- RH Lancer O
- Legend L
- Likable L
- Nebula N
- New Era N
- Nomad V
- Oracle O
- Ranger R
- Roosevelt B
- Scamp S
- Warrior W

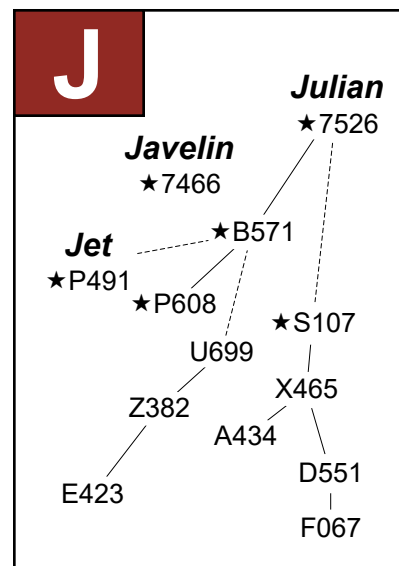
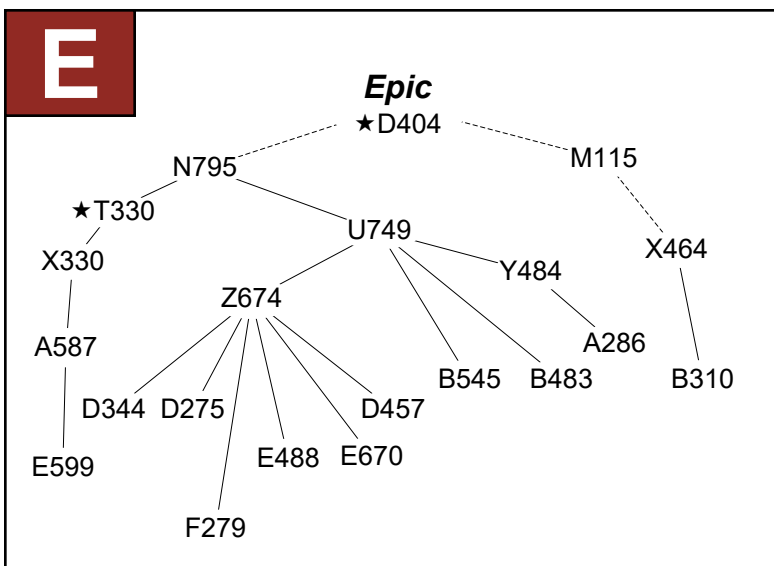
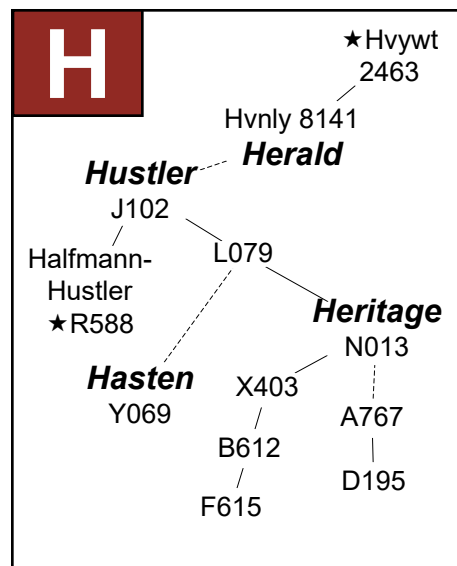
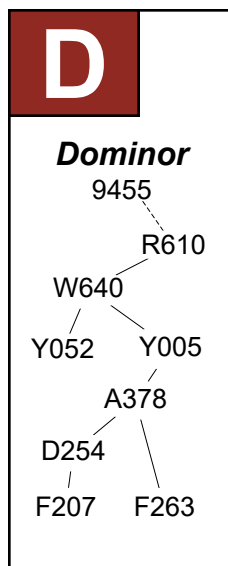
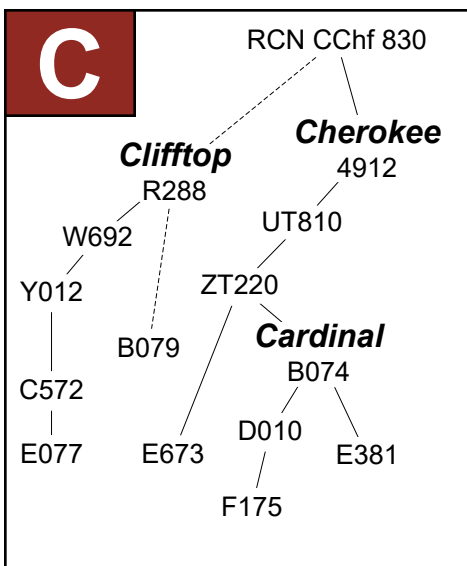
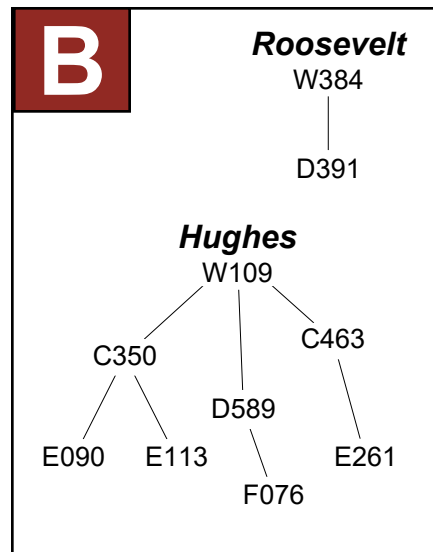
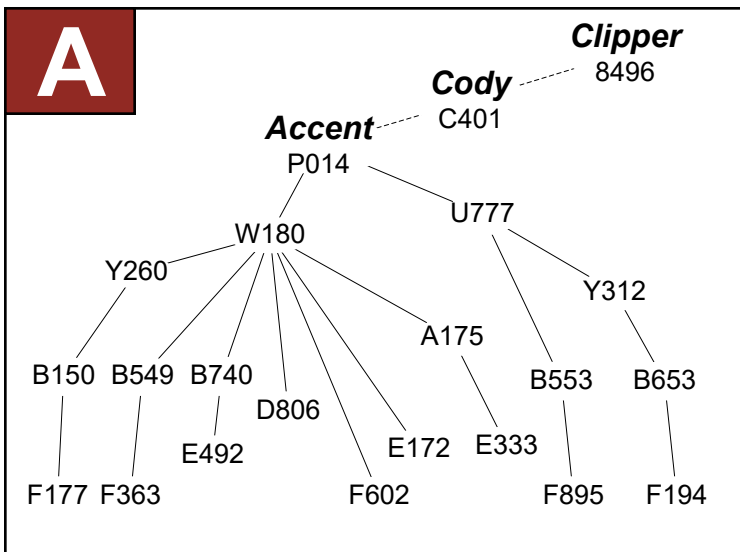

★ Red Angus Trait Leader

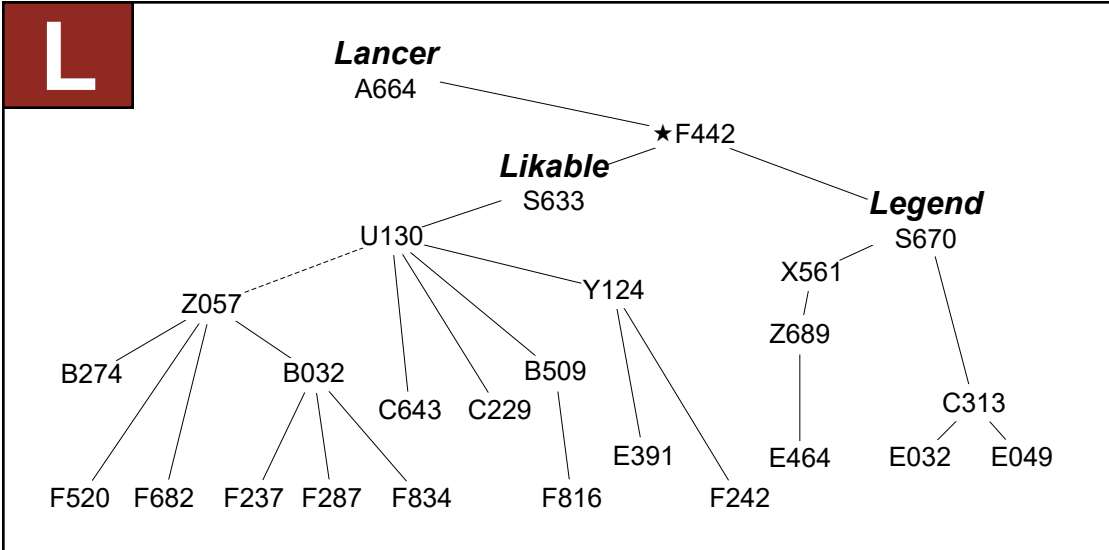

Name	Tag	Family
Accent	D806	A
Accent	W180	A-1
Accent	B549	A-2
Accent	B553	A-3
Accent	B653	A-4
Accent	B740	A-5
Accent	E172	A-6
Accent	E333	A-7
Accent	E492	A-8
Hughes	E090	B
Hughes	E113	B
Hughes	C350	B-1
Hughes	E261	B-2
Cardinal	B074	C-1
Clifftop	B079	C-2
Clifftop	C572	C-3
Clifftop	E077	C-4
Cardinal	E381	C-5
Cardinal	E673	C-6
Dominor	A378	D-1
Dominor	D254	D-2
Epic	Z674	E-1
Epic	B310	E-2
Epic	D275	E-3
Epic	E488	E-4
Epic	E670	E-5
Heritage	D195	H-1
Jet	P491	J
Javelin	7466	J-1
Julian	B571	J-2
Julian	P608	J-3
Julian	A434	J-4
Julian	E423	J-5
Legend	E049	L
Legend	Z689	L
Likable	Z057	L-1
Likable	B032	L-2
Likable	B274	L-3
Likable	C229	L-4
Legend	C313	L-5
Legend	E032	L-6
Likable	E391	L-7
Legend	E464	L-8
Nebula	S347	N
Nebula	X096	N
Nebula	P707	N-1
Nebula	P084	N-2
New Era	A908	N-3
Nebula	B557	N-4
New Era	C209	N-5
New Era	D478	N-6
Lancer	ERH11	O-1
Oracle	ES142	O-2
Ranger	B006	R-1
Scamp	A627	S
Scamp	C349	S
Scamp	D325	S-1
Scamp	E175	S-2
Warrior	D359	W-1
Warrior	E215	W-2

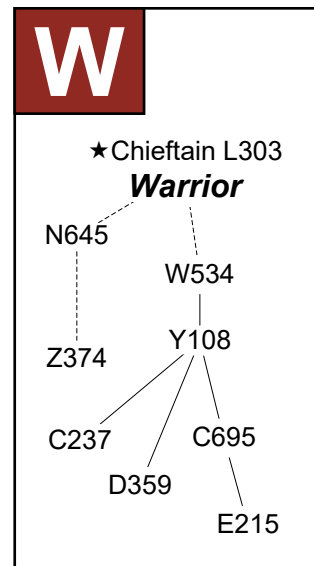
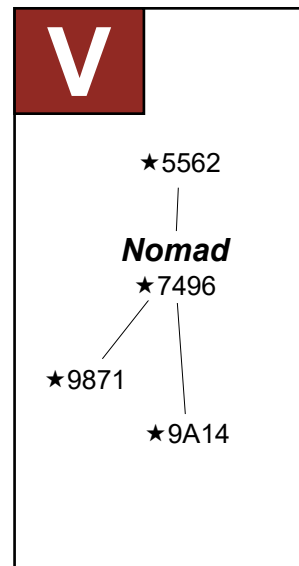
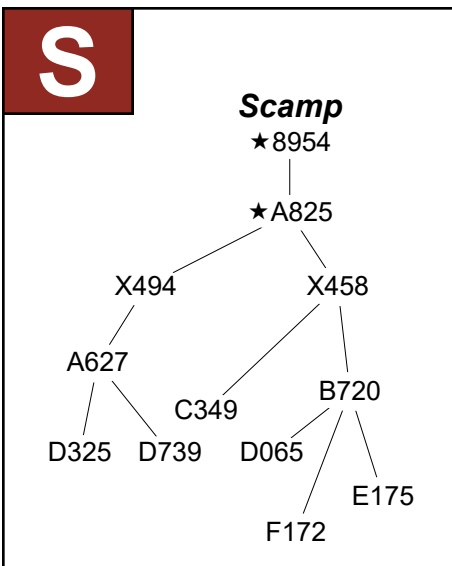
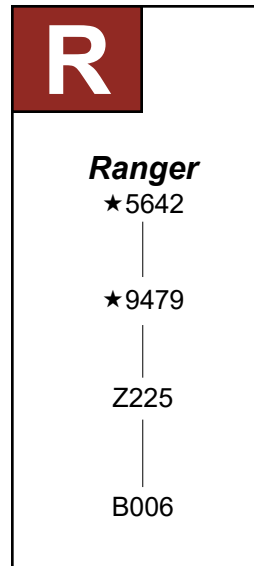
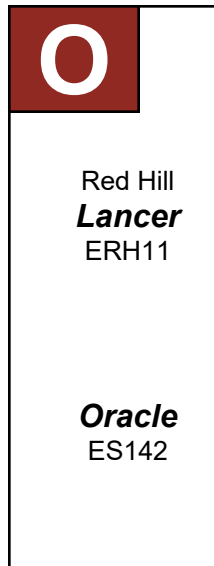
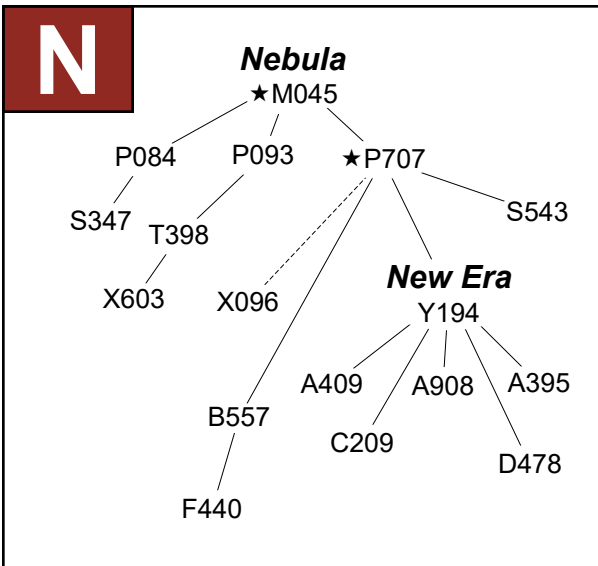

Lot-Tag Cross Reference

ID	Lot	ID	Lot	ID	Lot	ID	Lot	ID	Lot	ID	Lot	ID	Lot	
<i>Bulls</i>								<i>Heifers</i>				<i>Ref. Sires</i>		
G002 ... 231	G186 ... 144	G409 ... 55	G544 ... 101	G706 ... 161	G123 ... 311	7466 ... J-1		G005 ... 129	G197 ... 52	G410 ... 154	G545 ... 136	G716 ... 192	G130 ... 317	A378 ... D-1
G014 ... 56	G204 ... 188	G412 ... 128	G550 ... 145	G721 ... 29	G132 ... 316	A434 ... J-4		G016 ... 158	G206 ... 83	G416 ... 173	G554 ... 127	G722 ... 190	G142 ... 305	A908 ... N-3
G019 ... 184	G207 ... 80	G420 ... 138	G559 ... 41	G726 ... 49	G172 ... 309	B006 ... R-1		G023 ... 194	G212 ... 87	G422 ... 2	G562 ... 15	G736 ... 213	G181 ... 302	B032 ... L-2
G024 ... 185	G214 ... 121	G424 ... 100	G565 ... 209	G739 ... 237	G252 ... 304	B074 ... C-1		G028 ... 212	G216 ... 133	G427 ... 8	G574 ... 85	G740 ... 189	G276 ... 308	B079 ... C-2
G033 ... 31	G217 ... 10	G431 ... 149	G575 ... 134	G751 ... 218	G307 ... 314	B274 ... L-3		G035 ... 131	G225 ... 12	G435 ... 21	G580 ... 38	G752 ... 124	G359 ... 306	B310 ... E-2
G041 ... 156	G244 ... 118	G438 ... 214	G582 ... 17	G757 ... 175	G361 ... 319	B549 ... A-2		G043 ... 90	G245 ... 11	G440 ... 78	G585 ... 167	G758 ... 208	G413 ... 303	B553 ... A-3
G047 ... 235	G246 ... 142	G441 ... 91	G588 ... 37	G769 ... 140	G419 ... 312	B557 ... N-4		G050 ... 84	G249 ... 9	G442 ... 46	G590 ... 58	G771 ... 220	G439 ... 318	B571 ... J-2
G053 ... 155	G250 ... 35	G447 ... 130	G597 ... 225	G772 ... 229	G444 ... 301	B653 ... A-4		G056 ... 112	G251 ... 36	G453 ... 183	G599 ... 120	G773 ... 211	G473 ... 307	B740 ... A-5
G059 ... 152	G253 ... 3	G454 ... 5	G601 ... 146	G778 ... 223	G473 ... 307	B740 ... A-5		G064 ... 191	G255 ... 196	G456 ... 23	G602 ... 122	G781 ... 123	G532 ... 320	C209 ... N-5
G068 ... 135	G257 ... 160	G461 ... 72	G603 ... 94	G784 ... 221	G568 ... 315	C229 ... L-4		G070 ... 195	G258 ... 177	G464 ... 227	G604 ... 50	G786 ... 139	G609 ... 310	C313 ... L-5
G084 ... 61	G269 ... 1	G468 ... 105	G607 ... 137	G789 ... 181	G609 ... 310	C313 ... L-5		G091 ... 153	G271 ... 198	G469 ... 19	G610 ... 114	G802 ... 157	G725 ... 313	C350 ... B-1
G096 ... 141	G272 ... 151	G470 ... 103	G614 ... 224	G824 ... 215	G725 ... 313	C350 ... B-1		G100 ... 165	G277 ... 151	G471 ... 92	G615 ... 172	G841 ... 226		C572 ... C-3
G107 ... 110	G280 ... 27	G475 ... 82	G620 ... 30	G853 ... 162				G109 ... 176	G281 ... 163	G477 ... 164	G621 ... 88	GC140 ... 207		D195 ... H-1
G110 ... 43	G282 ... 178	G480 ... 20	G622 ... 187	GC142 ... 119				G114 ... 63	G288 ... 25	G481 ... 40	G627 ... 159	GC148 ... 180		D254 ... D-2
G116 ... 32	G290 ... 59	G482 ... 75	G630 ... 109	GC149 ... 113				G126 ... 210	G295 ... 117	G483 ... 108	G632 ... 53	GC154 ... 217		D275 ... E-3
G129 ... 174	G300 ... 47	G484 ... 18	G635 ... 14					G134 ... 13	G299 ... 51	G485 ... 34	G639 ... 57			D325 ... S-1
G138 ... 169	G301 ... 205	G488 ... 200	G640 ... 236					G140 ... 45	G310 ... 39	G489 ... 193	G644 ... 125			D359 ... W-1
G144 ... 182	G311 ... 98	G496 ... 73	G646 ... 228					G145 ... 7	G312 ... 170	G497 ... 206	G647 ... 232			D478 ... N-6
G146 ... 6	G326 ... 166	G498 ... 77	G650 ... 99					G149 ... 171	G328 ... 147	G499 ... 70	G652 ... 186			E032 ... L-6
G150 ... 44	G333 ... 22	G499 ... 70	G656 ... 126					G151 ... 148	G337 ... 104	G500 ... 81	G656 ... 126			E077 ... C-4
G155 ... 64	G339 ... 62	G500 ... 81	G660 ... 111					G156 ... 115	G342 ... 48	G502 ... 201	G660 ... 111			E172 ... A-6
G156 ... 115	G343 ... 74	G509 ... 69	G663 ... 203					G159 ... 168	G347 ... 74	G510 ... 107	G663 ... 203			E175 ... S-2
G162 ... 197	G358 ... 26	G511 ... 24	G666 ... 97					G163 ... 89	G358 ... 26	G516 ... 42	G666 ... 97			E215 ... W-2
G166 ... 16	G368 ... 150	G516 ... 42	G667 ... 222					G167 ... 216	G368 ... 150	G517 ... 71	G667 ... 222			E261 ... B-2
G168 ... 4	G370 ... 96	G517 ... 71	G673 ... 60					G174 ... 219	G370 ... 96	G519 ... 106	G673 ... 60			E333 ... A-7
G182 ... 66	G372 ... 79	G519 ... 106	G679 ... 102					G182 ... 66	G372 ... 79	G529 ... 95	G679 ... 102			E381 ... C-5
	G377 ... 33	G529 ... 95	G681 ... 76						G377 ... 33	G530 ... 132	G681 ... 76			E391 ... L-7
	G380 ... 54	G530 ... 132	G682 ... 179						G380 ... 54	G533 ... 93	G682 ... 179			E423 ... J-5
	G381 ... 230	G533 ... 93	G691 ... 67						G381 ... 230	G535 ... 116	G691 ... 67			E464 ... L-8
	G387 ... 65	G535 ... 116	G693 ... 143						G387 ... 65	G538 ... 68	G693 ... 143			E488 ... E-4
	G392 ... 234	G538 ... 68	G695 ... 204						G392 ... 234	G543 ... 199	G695 ... 204			E492 ... A-8
	G398 ... 28	G543 ... 199	G699 ... 202						G398 ... 28		G699 ... 202			E670 ... E-5
			G702 ... 233								G702 ... 233			E673 ... C-6
														ERH11 ... O-1
														ES142 ... O-2
														P084 ... N-2
														P608 ... J-3
														P707 ... N-1
														W180 ... A-1
														Z057 ... L-1
														Z674 ... E-1

Family who help us in many ways over the course of the year



Ellen, Julia, Sarah, and Jeff Durkin



Alison Brody and Don Bingham with Kate



*Julia Forbes and Ed Waddington
(with Tazmin and Flinder)*



Doug Foster and Sarah Forbes



Elfie Forbes and Ruth Sylvester



Sheila and Doug Bingham



*Stephen Forbes and
Morgan Baldwin*



*Jason Brown and Shelley Forbes
with Nolan*



*Tallie Forbes and Justin Lee
with Ryan and Claire*

Beckton Stock Farm

Cam Forbes

37 Beckton Drive

Sheridan, WY 82801

Tel.: 307.674.6095, 674.8162 (evening)

Fax: 307.672.7281

Email: becktonwyo@gmail.com

Web: www.BecktonRedAngus.com

Video of Sale Bulls available on our Website

FIRST CLASS



Lot 237. Great bulls – right to the end !!

Bulls to Build a Herd and more!!!

17 of the top 20 highest ranking sires in the Red Angus breed (and 43 of the top 50) for Herd Builder profitability are Beckton sires or descended from Beckton sires. Just the average Beckton bull in our sale is in the top 20% of the breed.

HERD STAYABILITY – Beckton is the #1 Herd in the breed for Stayability, and has been for many years. **7 of the top 10 sires in the breed for Stayability EPD are Beckton sires or descended from Beckton sires.**

LOW MAINTENANCE ENERGY – Beckton has also been the #1 Herd for Low Maintenance Energy requirements for many years, with more of the top 10 sires than any other herd.

EASY CALVING – The #1 Herd in the breed for easy calving, with the best average Calving Ease EPD of any major herd. **18 of the top 20 sires in the breed for best Calving Ease EPD are Beckton sires or descended from Beckton sires.** If you are breeding heifers, these are your top choice.

GROWTH RATE from Birth to Market – Here is the best volume of bulls combining this high calving ease with high growth rate to early market weight, together with fertility, good feet and udders, range and altitude adaptability, and good disposition.

These are the bulls and heifers that will build you the best possible cow herd, with cows that will stay in your herd for many years.



Superior Productions will provide internet and representative bidding services for buyers who can't make it to the sale. Please see page 3 for more information.

Free Delivery
anywhere in the Continental US