

76th Anniversary Production Sale

Tuesday April 13th, 2021

Industry Leader for
Low Maintenance, Maternal Traits



**1 Beckton
Red Angus**

Foundation Herd of the Red Angus Breed

1 Beckton Red Angus

37 Beckton Drive • Sheridan, WY 82801 • becktonwyo@gmail.com
Office: 307.674.6095 • Evenings: 674.8162 • Fax: 672.7281

Dear Friends and Cattlemen,

2021 is looking to be a good year for all of us in the beef business, with both domestic and export demand looking strong. In February, Trish and I made two trips to Nebraska where we winter our bulls, to pick and then photograph the bulls for the sale. The bulls are looking great!! Even after coming off the driest summer and fall that I can remember, weights are up from any of the past few years. I take all the photos you see on the cover and throughout the catalog, and I could have spent a week taking pictures of them all. I photo them in a large pen, so they are never 'posed', or even cleaned up, and you see them the way they really are. We are equally proud of the heifers that we picked for our sale.

Two other comments are worth making. Randy Zier and I spend time in a small pen while Trish, Mitch Ziebull, and Eric Geving weigh and ultrasound the next bull. Among other things, Randy evaluates their feet while I observe disposition as to how the bulls behave when all alone in a small 20 x 20 pen with us. Even handling nearly 400 bulls in such a small pen, there was not a single bull that made either of us think of climbing the fence. You will also notice that we have added a "Feet" score for each bull. While foot problems can develop later in life, as of today all 245 bulls in the sale are rated "Good". There were a couple of bulls that didn't rate "Good", but any bull that didn't rate "Good" for his feet, didn't go in the sale.

You will also notice we have added an "Udder" score for the Dam of each bull. For several decades now we have culled for poor udders. We use a rancher-simple 1 to 4 scale, but this translates into "Very Good", "Good", "Fair" or "Poor", which is listed in the catalog. After decades of selection and culling, we rarely see a "Poor" even in our oldest cows, and very few that are only "Fair". Our cowherd is very important to us, and many of our customers use our bulls to produce and sell commercial replacement quality heifers.

Another change you will see in our catalog is de-emphasis of the HerdBuilder or other Indexes. Just this past fall the Red Angus Association totally revised the formula for the HerdBuilder Index, taking out the post-weaning revenue traits like ADG and marbling. More explanation is provided on page 9, but the new HerdBuilder Index no longer fits our program, nor do either of the other two new Indexes.

This is actually a good thing. When the original HerdBuilder Index came out, Beckton cattle performed spectacularly well. Over 80% of the top animals on the Index were Beckton cattle or from Beckton bloodlines. The reason was not because we had been selecting for the Index, because the Index hadn't existed. It was because we had been selecting for the individual traits that we believed make for profitable cattle. Those same traits will still lead to more profitable cattle, so we can keep doing what we have been doing.

On behalf of everyone here at Beckton, we welcome you to join us for our sale here in Sheridan, or participate from home using one of the methods described on page 3. A video will be out soon and posted on our web-site. If you can make the sale in person, you will see a great set of bulls and some beautiful heifers.

Sincerely,

Cam Forbes



Cam and Trish Forbes

Tenderness Scores:

Outstanding	9-10
Very Good	7-8
Average	5-6
Poor	3-4
Very Poor	1-2

Beckton Red Angus • Since 1945
The Foundation Herd of the Red Angus Breed

Sale Information

Beckton Ranch

9½ miles West of Sheridan

Phone: 307.674.6095

Please join us for a complimentary dinner after the sale at the Holiday Inn.

Tuesday, April 13th, 2021

1 o'clock pm (Lunch at noon)

245 Bulls • 40 Heifers

Selling in catalog order, heifers sell following the bulls



Some Facts about the Beckton Herd

Beckton has long been one of America's premier breeders recognized for genetics which combine a genuine balance of desirable traits - calving ease, maternal traits, and rapid growth to yearling age. They are a leading choice for commercial replacement females and for building a great cow herd. And the lower birth weights make them a first choice for breeding heifers.

MATERNAL FOCUS: The HerdBuilder Index has been completely revised as of last fall, with a new formula which no longer includes post-weaning revenue traits like ADG, Yearling weight, or Marbling. Because the new HerdBuilder no longer tries to measure overall herd "profitability", it is not an Index that we would select for, or recommend our customers select for. However HerdBuilder does provide a barometer of some traditional "maternal" traits, and Beckton bloodlines still perform very well on it. **33 of the top 50 sires in the breed for HerdBuilder are Beckton sires or descended from Beckton sires.**

MODERATE MATURE SIZE: One characteristic of Beckton cattle which makes them ideal for producing replacement females and building a low cost, efficient cowherd, is the **moderate mature size**. We list the mature weight of the Dam of every Beckton sale bull. Page 5 shows the results of decades of genetic selection. We believe we have the best genetics for **Efficiency** that can be found anywhere.

EASY CALVING: The #1 Herd in the breed for easy calving. **47 of the top 50 sires in the Red Angus breed for Calving Ease are Beckton sires or descended from Beckton sires.** Producers all over the western United States use our bulls year after year for breeding their heifers. However unlike some heifer bulls that are simply sold off the low end, we have always selected for growth traits as well, so you can find a large number of calving ease bulls which offer more growth and marbling as well. If you are breeding heifers, these are your top choice.

Sale Details

Site-Unseen Purchase

If you are unable to attend the sale, we can help you select the bulls or heifers to fit your needs. Give us a call, letter, fax or email, and we can handle bidding for you according to your directions. Satisfaction is guaranteed on all animals purchased "sight-unseen". Over a quarter of our bulls sell this way, mostly to long-time and repeat customers. To provide adequate time to assist you, please contact us before actual sale day.

Internet Bidding via Superior Productions

Internet bidding and phone bidding are now available with Superior Productions. See more information on page 3.

Conference Call Bidding

Conference call bidding will be available with Bill Pelton, Pelton Livestock. See more information on page 3.

Payments

Payments can be made with cash, check payable to Beckton Stock Farm, Inc. or Visa/Mastercard on sale day.

All Bulls "Trich" Tested

In all the years we have been selling and delivering bulls, Beckton has never had a bull test positive for "trich". But because an increasing number of states require testing of yearling bulls, and to avoid any delay in delivery time, we will have all the sale bulls tested negative for "trich" prior to the sale. Customers from any state may also come to the sale with their trailer and load out directly after the sale.

Free Delivery

We provide free delivery for all bulls throughout the continental U.S. If you bring a trailer to haul your own, \$200 will be deducted from the price of each bull. Heifers will be delivered free within 400 miles, and at cost for additional miles. Most of the sale cattle will be delivered from 1 to 3 weeks after the sale, although we will try to accommodate if you need your bulls right away. Although there occasionally are limitations, in most cases we can deliver the cattle directly to your ranch.

Accommodations

Holiday Inn

307-672-8931, I-90, Exit 25
Ask for special Beckton Sale rate of \$79 per room

Best Western Sheridan Center

307-674-7421, 612 N. Main Street

Days Inn

307-672-2888, 1104 Brundage Lane

Super 8 Motel

307-672-9725, 2435 N. Main Street

Transportation

United / United Express

Daily CRJ200 flights between Denver and Sheridan
www.united.com

Avis Car Rental

307-672-2226, Sheridan Airport



Auctioneer Roger Jacobs
406-698-7686



Bob Hough
817-296-0976



Alan Sears
Western Ag Reporter
970-454-3986



Curt Cox
Wyoming Livestock
Roundup
307-630-4604



Matt Wznick
Tri-State Livestock
406-489-2414



Pete Crow
Western Livestock
Journal
303-722-7600



Devin Murnin
Western Livestock
Journal
406-696-1502

Additional Sale Information

- ▶ The animals sell in catalog order. We will have a conference call available for telephone bidding. You must register in advance, and conference number and instructions will be available then.
- ▶ All bulls have passed a rigorous fertility exam that included live semen evaluation, scrotal measurements, and reproductive tract examinations.
- ▶ Beckton has a comprehensive herd-wide health program which includes vaccinations for 7-Way, IBR, BVD, PI3, BRSV, Lepto, and ivermectin. The heifers are also vaccinated for bangs and vibrio.
- ▶ When a genetic test was developed by RAAA for osteopetrosis (OS), Beckton tested every sire in use in our program, as well as our major AI sires. Every Beckton bred sire (nearly 80 in total) tested OS Free.
- ▶ We plan to have semen collected on some of the bulls before the sale. We will also work with the buyer to collect bulls after the sale.
- ▶ Buyer receives full possession and one half semen interest in all the bulls in the catalog. Seller is retaining one half interest in all bulls in the catalog. This is done so we can use some of the bulls in herd and reserve the right to collect and market semen on these bulls. Any collection on our behalf would be at our expense and could be done during the off-season and at the convenience of the buyer. The buyer would have the option to share in the collection and retain semen for the buyer's use also. If semen is marketed by either party, Seller receives one half royalty interest on gross semen sales, and buyer receives one half interest. Regardless of semen collection and marketing, the buyer retains full possession, full pasture use rights, and full salvage value in these bulls.
- ▶ Payments can be made with cash, check payable to Beckton Stock Farm, Inc. or Visa/Mastercard on sale day.

Table of Contents

The Beckton Program	4
The Bulls	10
The Yearling Heifers	60
Ref. Sire Cross Reference. . .	64
Reference Sires.	67
Sale Terms & Conditions . . .	75
RAAA Herd EPD Tables	76
Sire Bloodline Charts.	78
Lot-Tag Cross Reference. . . .	80



Serving our customers for 76 years with industry leading genetics and the highest quality cattle.



BECKTON BULL AND HEIFER WARRANTY

Optional protection against injury or death, plus Pregnancy coverage for heifers

BULLS: Injury or loss protection coverage - If your bull is permanently injured or dies any time up to 5 months after purchase, you will receive a credit toward purchase of another bull in the amount of the original purchase price minus salvage. The cost is 5% of the purchase price paid at settlement (eg. \$150 for a \$3,000 bull).

HEIFERS: Injury or loss protection plus Pregnancy Guarantee – likewise good for 5 months after purchase. If your heifer fails to become pregnant when exposed to a bull who settles 75% of the other heifers in the same pasture; or in the event your heifer is permanently injured or dies, you will receive a credit toward purchase of another heifer in the amount of the original purchase price minus any salvage. The cost is 10% of the purchase price paid at settlement (eg. \$200 for a \$2,000 heifer).

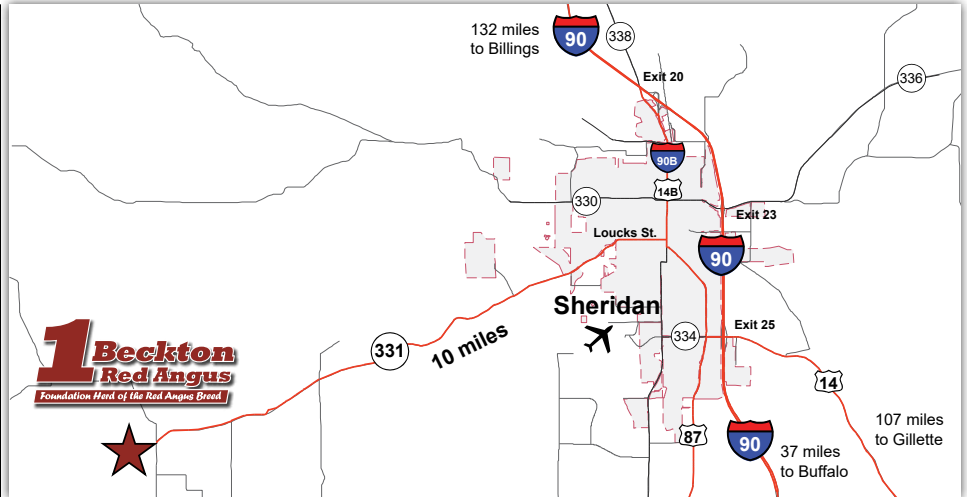

How to Participate as an Absentee Bidder: 1, 2, or 3

1. Site-Unseen Purchase

If you are unable to attend the sale, we can help you select the bulls or heifers to fit your needs. Give us a call, letter, fax or email, and we can handle bidding for you according to your directions. Satisfaction is guaranteed on all animals purchased "sight-unseen". Over a quarter of our bulls sell this way, mostly to long-time and repeat customers. To provide adequate time to assist you, please contact us before actual sale day.

2. Superior Livestock Productions

Turn in Bids Over the Phone. To get started simply go online to www.superiorlivestock.com and click on the tab titled "Register for a Buyer Number". Select the registration form for Superior Productions and print the registration form, fill it out and fax it in to Superior Productions at (817) 378-3380 with a signature on it, or scan and email the form to info@superiorauction.com. You can also mail it in to the address provided on the form. Upon receipt of this information Superior will call you with a buyer's number and the bid line phone number that you will use on sale day to place bids over the phone. **Important: If you plan to bid by phone through Superior Livestock or 'Click-to-Bid', you must register at www.superiorlivestock.com prior to bidding.**

Click-To-Bid. This is Superior's online bidding platform for cattle buying. Please note that high speed internet is required – this is not for dial-up or satellite internet. Registration is free, but you must become a member of www.superiorclicktobid.com to sign up. Becoming a member is easy - just go to the homepage of www.superiorclicktobid.com and follow the out-lined steps to get started. Input your information and select a username and password. You will receive an e-mail confirming you are a member. From that point forward you just have to sign in and select the sale you would like to register for and once approved you will receive an e-mail confirming which sale you are now registered for.

3. Sale Day Conference Call

Our goal is to have you in the seats but if you can't make it on sale day, we're fixin' to get you "on the line!"

Easy as 1~2~3
Call BILL PELTON in Advance to...

1. Pre-Register for your buyer number
2. Receive the toll-free Call in Number & Pin
3. Get last minute instructions for the call

Pelton Livestock
Marketing & Consulting
www.billpelton.com | 406-671-5100



Buyers purchasing via Superior or Pelton Livestock can mail a check after the sale with brief delivery instructions and an approximate date you would like delivery by. If you would like to pay with a credit card, please call the office the day after the sale

The Beckton Program

Cow Size

The goal for Beckton's program has always been to develop breeding seedstock which offer increased levels of performance for the commercial cattleman. Increased performance does not mean maximizing weight and size, which have already reached the upper limit of economic value for the packer and consumer. It does, however, mean increasing performance related to calving percentage and weaning percentage; and increasing performance related to cow maintenance requirements and "pounds of calf per acre" efficiency.

Size Matters

Beckton cattle are already big enough for the consumer and the packer. Using yearling weight EPD as the best available indicator of market size, the average for our sale bulls is +90, close to the same as the Red Angus breed average, so for market size our cattle are directly comparable.

The big difference with Beckton's program is that we select for additional weaning and yearling weight, but with the restriction that we have maintained the same cow size over time. In contrast, the industry has allowed cow size to increase at the same rate as calf size. Cow size is the largest factor determining maintenance requirements. Our goal has been to increase efficiency, not size. No other seedstock breeding program has had such a goal and maintained it for so long.

Beckton Cow Weight Average (lb.)

Year	1978	1986	1994	2002	2010	2018	2020
Weight	1,126	1,064	1,067	1,104	1,068	1,074	1,051

(mature lactating cows taken at weaning)

Cow weights vary from year to year depending on grass, weather or other short term factors. But overall our cow size has stayed fairly constant over time.

The Industry Problem

As shown on the graph on the next page, industry-wide cow size has increased substantially, 31% since 1978. Hay use per cow has increased even more, from 1.43 tons per animal to 1.91 tons.

Why does hay use increase at a faster rate than cow size or production per cow? Hay and grain are supplements to the cow's main diet, which is grass, and grass supply is relatively fixed by environment. Each increase in cow feed requirement must be met entirely by supplements, or by a combination of supplement and reduced stocking rate. A small increase in cow feed requirement leads to a reduction in stocking rate or a large increase in higher-cost, supplemental feed needs.

Any gains achieved in the feedlot sector due to increased animal growth, have been overwhelmed by increased cost of production in the cow-calf sector.



The Beckton Crew...



Randy Zier



Alan Sanders



Roger Zier



Shelby MacMillan

Efficiency

The graphic at right shows how, for the U.S. cattle industry overall, the increase in average calf weights, as measured by steer slaughter weights, has been directly matched by an increase in average cow weights. (Percentages are based on USDA slaughter weight data for steers and cows respectively, using 1978 as a base year. Data for heifers slaughtered shows an identical trend.) Over 40 years, there has been minimal change in overall cowherd efficiency.

This graph shows the failure of cross-breeding and composite breeding to do little more than simply increase general cattle size. In the promotion of composites, the impact of retained heterosis on mature weight is too often ignored. Crossbreeding and composites are sold as a free lunch, but they aren't free.

The graphic shows Beckton cowherd data over the same time period.

1. Beckton cow size has shown no significant change over the past 40 years, while the industry has experienced a substantial increase in cow size.

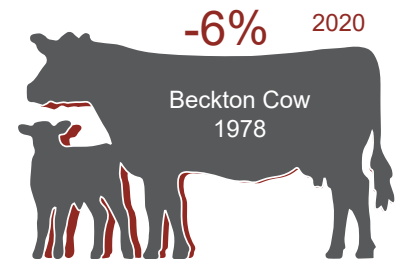
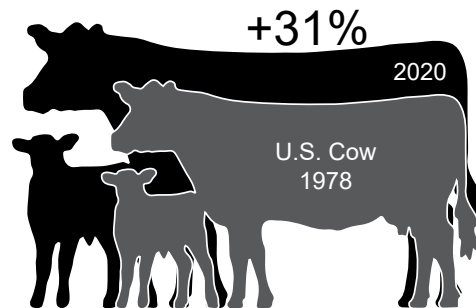
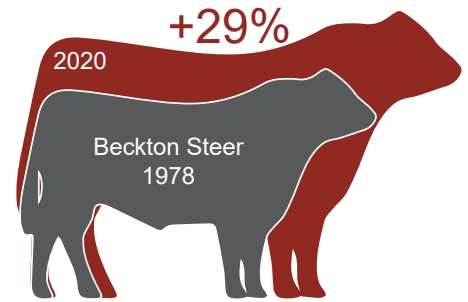
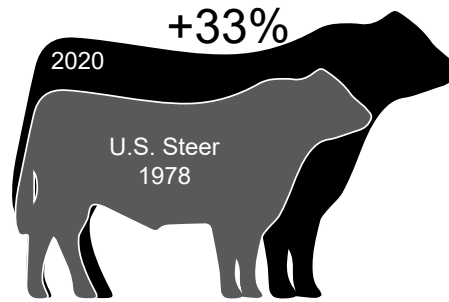

2. Even without increasing cow size, we have raised the rate of early growth in Beckton cattle, using intense genetic selection and generation turnover.
3. The net change in efficiency as measured simply by "calf weight divided by cow weight" is significantly higher with Beckton's genetic program, compared to mainstream cross-breeding based on retained heterosis.

We have accomplished this by selecting for growth, restricting birth weight and cow size creep, and multiplying each incremental change rapidly throughout our entire cowherd and all of our bloodlines. Usually this has meant working within our own bloodlines rather than introducing out-crosses, because the outside genetics for the direction we wanted to go haven't been available. The overall key to success is simply that we have been making small progress in multiple traits, but doing it consistently over a very long period of time.

... making the Beckton Program work!



Morgan Armstrong



Matt Zier



Allison Natzel



Braxton Rosalez

Management

One Bull – the Simple Solution is the Best Solution

Many cattlemen use Beckton bulls for their heifers because of their low birth weights and high calving ease. Our bulls are even better when used on cows, because replacement heifers tend to be selected from calves out of older cows. **Keeping replacement heifers sired by Beckton bulls is the quickest way to limit cow size creep and to moderate cow size for the future.** In our own program we use the same bulls on both heifers and cows. Every bull is used his first year with heifers to evaluate calving ease, and used in future years with older cows. We get calving ease, growth, and moderate-sized replacements, all with the same bull.

Quietness and Ease of Handling

The necessity of record keeping means that our cattle will be handled much more than commercial cows. **This benefits our seedstock customers because our cattle will be quieter and easier to handle.** Good disposition is one of our most valued traits.

Selection for Industry Requirements

In order to make selection decisions appropriate to the commercial beef industry, seedstock cattle need to be managed and measured under conditions which will approximate the commercial industry. **Our cows are run entirely on grass, with hay only if weather conditions require it, because that is how the commercial industry runs cows.** However, almost all commercial calves go into feedlots before slaughter, so feedlot performance and efficiency is an important trait for calves. **Simply put, a producer needs to know how his cows perform on grass, and how his calves perform with feed.**

Our bulls are run on a performance test designed to provide the fairest basis of comparison among them, and

this requires a compromise. Our bulls receive a “growing” ration high in roughage and protein and not as high in energy as a steer would receive. **We want to get a good measure of gainability with which to compare bulls, but we don’t want the bulls fat.**

Mitch Ziebell, Craig Uden of Darr, NE

Since 1979 all of our bulls have been performance tested at a facility owned and managed by the Kugler family near Cozad, Nebraska. In the fall of 2005, Lane Kugler retired and the operation was bought by a neighboring operation – Darr Feeders. The overall operation is managed by Craig Uden, president of the NCBA, with the bulls under the daily management of Mitch Ziebell. **We have been very impressed with the conscientious care with which Mitch oversees all aspects of the bull management.**



Mitch Ziebell, Darr Feeders

Contributing to the success of the Beckton Program...



*Sarah Schreiber
Our vet*



*Janet Drake
Health Permit Expert*



*Cody Cunningham
Brand Inspector*



*Fracky & Howard
Assistant Office Admins*

Additional Facts about the Beckton Program

- Birth weight**
- ▶ Every sire entering our own program is used first on our own heifers, then on our cows.
 - ▶ We have never used high birth weight sires in any part of our program, so big birth weights are rare.
 - ▶ We get the pay weight, but with lower birth weights and greater calving ease.
 - ▶ Full production from heifers. We use the same bulls on heifers and cows.

- Growth**
- ▶ Weaning efficiency, and rate of gain to slaughter weight second to none.
 - ▶ Growth traits must be consistent with maintaining maternal qualities.
 - ▶ Beckton cattle are ideally sized for today's packer demand.

- Hardiness**
- ▶ Every cow in the herd has spent part of her life in the Big Horn Mountain summer range, at elevations from 7000 to 10,500 feet.
 - ▶ In 2001 we PAP tested all of our herd sires. The herd average PAP score was 32.5 at 4000', equivalent to a herd average PAP of 39 at 8000' (excellent scores).
 - ▶ By the time she is 5, our average cow will have been trailed over 80 miles, above and beyond normal pasture rotation.

- Efficiency**
- ▶ The typical dam of our bulls weans over 50% of her body weight in 205 days, under range conditions, with no creep-feeding.
 - ▶ The average dam produces over 100% of her own body weight in a year.

- Fertility**
- ▶ Every bull in our program is used in natural service, with 30-50 heifers/cows.
 - ▶ Every cow in our program must cycle naturally and breed early under range conditions.

- Value**
- ▶ Beckton Red Angus produce more growth without high birth weights.
 - ▶ They are the one-bull solution that can be used on both heifers and cows.
 - ▶ Carcass quality is an extra benefit.

- Reliability**
- ▶ Beckton has been genetically improving Red Angus since 1945, a 30-60 year lead time over other producers.
 - ▶ It is a complete, genetically sound breeding program, which demands whole-herd performance.



Lorna Tucker
Helping out in many ways
throughout the year



Chuck Overturf
Friend and neighbor - helps us
every year



Sherry Kobielus
Always here to help even after
retirement



Cody and Chad Halfmann, Halfmann Red Angus

Beckton History



Young Sal Forbes up on the mountain.



Waldo Forbes - 1st President of the Red Angus Association.



Beckton house/office before being moved in 1905 to its current location. This house was built in the 1880s by George Beck, the original homesteader. The antlers are still on the porch, and it is one of the oldest buildings in Sheridan County.



*The Waldo Forbes family in 1959:
Ellen, Julia, Sal, Sarah, Cherry, Spike, and Cam & Elfie in front.*



1960s Beckton Sale with Berdon's broadcast van.



*Beckton Larkabeau O "220" in 1959 -
the 1st Red Angus Bull at ABS*



Mrs. Waldo (Sal) Forbes was honored as the first woman inducted into the Saddle and Sirloin Club's portrait gallery in Louisville, KY.

Re-thinking Indexes

It often seems as if the entire beef industry has been in a race to create and implement new EPD's and Indexes. When the Red Angus Association created its original HerdBuilder and GridMaster Indexes some years ago, they looked like a good idea to help producers assimilate and simplify the proliferation of new EPD's. In the fall of 2020 RAA substantially changed the original HerdBuilder (HB) and GridMaster (GM), and created a new ProS Index which weights HB and GM equally and adds them together.

Unfortunately, these new indexes do not fit our goals in cattle selection. The new HerdBuilder (HB) has no post-weaning growth or carcass traits in it, so it runs contrary to our goal of balanced cattle performance. The new GridMaster (GM), which is a terminal cross index with no maternal traits at all, is even further from our goals. We could not use either index as a selection tool by itself. We have de-emphasized these Indexes in our catalog format.

The ProS Index combines HB and GM with equal weight. Unfortunately, carcass and growth traits make up a disproportionate amount of the ProS Index. This is contrary to what agricultural economists have been telling ranchers for decades – which is that growth and carcass traits are much less important to profitability than maternal traits.

ProS has a second problem – the positive weighting for growth traits (weaning weight, ADG and carcass weight) is much heavier than the negative weighting for mature weight. Selection for ProS will lead to steadily and rapidly increasing cow size. The costs associated with increasing cow size fall entirely on the cow-calf producer, but the overweighting of carcass traits gives a disproportionate amount of additional income to the packing industry. I do not foresee the highly concentrated and monopolistic packing industry giving more than a tiny share of any additional income back to the cow-calf producer in the form of higher grid premiums. Therefore I am concerned that selection for ProS over time will reduce cow-calf profitability, not increase it.

Lastly, the ProS Index suffers from the same weakness as that of any Index. An Index is a rigid “one size fits all” formula that may or may not fit your operation. For example, if you sell calves at weaning, ProS will over-select for carcass traits that you never get paid for. No one knows your operation better than you do. We think it is better to select for the specific traits that are most likely to benefit your specific operation.

Cow Efficiency

We present two indicators of efficiency. The first is Weaning Percent, a simple percentage of calf 205 day weight divided by the dam's actual weight at weaning. The second is PRI Cow Efficiency. This also measures calf weaning weight, but relative to the cow's metabolic weight, and is expressed as an index above or below 100.

These efficiency measures are best used as indicators of where an animal is relative to others, rather than directly for selection. For example, if we see an animal with a low efficiency, we would look at the actual calf and cow weights to decide if the calf is too small, or the cow too big for the environment. That in turn will suggest corrective actions. In general, select for the traits you need to change to make cattle more efficient, and efficiency will be the result.

Beckton has been performance tested selection since 1945, and we believe our cattle today are the most efficient in the industry.

Maintenance EPD

This EPD predicts the relative feed energy requirement for maintenance, for cows produced by a sire or female. A bull with an ME of -3 (minus 3) is expected to sire replacement daughters which will need 10 fewer mcals of energy per month than a bull with an ME of +7.

We believe this is an important EPD because feed costs, both direct and indirect through ranch overhead, make up by far the largest proportion of operating costs. It can have much more direct impact on ranch profitability than Marbling or Ribeye EPD for example.

The Beckton herd has been one of the breed's top herd for low maintenance energy requirements for many years.

Dam Information

A major difference with our catalog is the greater amount of information about the dams we provide. Weaning percent and Cow Efficiency are explained above. In addition, with each sale animal we give the dam's age when this calf was born, and the dam's actual weight when the calf was weaned the previous fall. We also provide her progeny averages – the average birth weight, weaning ratio, and yearling ratio – of her calves.

The Bulls

Our bulls are managed in a manner to gain important performance data and information, and equally importantly, to develop and provide our customers with many years of productive service. We have been testing breeding bulls over 50 years, longer than almost any other producer. Our own breeding is based primarily on natural service, not AI, so we see how our bulls work in the pasture. We use bulls raised and managed just this way, with our own cows and heifers, on every kind of terrain, and high in the Bighorn Mountains.

For the first twenty years our bulls were tested at home here in Wyoming. They received some grain, but otherwise grass pasture and dry hay. In 1979 we moved our test to a facility managed by the Kugler family in Cozad, Nebraska, where the bulls got a ration including silage, corn and protein. When we brought our first bulls home from Kuglers' and used them with our own cowherd, we discovered a dramatic increase in libido and breeding performance. The effect of proper nutrition was apparent, and the bulls would maintain condition and hold up better through the entire breeding season. We have continued managing our bulls at the same facility ever since (now managed by Craig Uden), and we continue to see the same benefits.



Lot 51

We have since used over 500 of these bulls natural service in our own breeding program, on dry range and in the mountains, and have never had a bull fall out of our program early due to his feeding or testing management. Beckton Julian B571, Lancer F442, Nebula M045, Nebula P707, and all of our other great sires were fed and managed in Cozad. Every year we see the results and success of our bull management program, and we serve many satisfied customers.



• Bulls •

1 BECKTON HERITAGE H314 J5
1-A 100% # 4377207 Tat: BKT0 H314



Birth: 3-23-20
 Beckton Heritage X403 L3 < Beckton Heritage T270 J2
 Beckton Indigo H150 LN
BECKTON HERITAGE C477 J4
 Ref. H-1 < Beckton Julian U699 L5
 Beckton Ruth Z858 J < Beckton Ruth U557 JT
 Beckton Julian X721 E6 < Beckton Julian U699 L5
BECKTON CHRISTY Z125 J
 Beckton Christy X354 N < Beckton Lana U329 EP
 Beckton Nebula M045
 Beckton Christy T444 JL

BWt	77
WR	125
YWt.	1269
YR	124
Feb.ADG	3.94
Feb.Scr.	40
Frame	5.5
Feet	Good

DAM									
Age	8								
Wt	1140								
Prog. BW	71								
WR	111								
YR	108								
Udder	Very Good								
Calv.Ease	BW	WW	YW	Milk	HPG	Stay	Maint.En.		
EPDs	14	-1.8	70	116	31	12	17	-3.0	
Marb	+.31		REA	+.15		Bfat	+.04		
Beef Tenderness	→		DNA:	'Outstanding'		Scan:	Tender		
Wean Pct.	59%	Cow Eff.	123	HB	95	GM	48	ProS	143

★★★★★ for Low Maintenance, Growth, Gainability, Marbling, Rib-eye area, Superior Cow, High Cow Efficiency, Calving Ease.



Lot 1



Lot 3

3 BECKTON ACCENT H412 A5
1-A 100% # 4378005 Tat: BSF0 H412



Birth: 3-28-20
 Beckton Accent Y260 L3 < Beckton Accent W180 C2
 Beckton Lana W463 L
BECKTON ACCENT D326 N4
 Ref. A < Beckton Nebula P P707
 Beckton Lydia S069 NB < Beckton Lydia P583 WR
 Beckton Accent W180 C2 < Beckton Cody K1 P014
BECKTON MINERVA B452 A
 Beckton Minerva Y520 J < Beckton Christy R046 CQ
 Beckton Julian U742 W5
 Beckton Minerva U586 CT

BWt	90
WR	124
YWt.	1198
YR	117
Feb.ADG	3.67
Feb.Scr.	38
Frame	6.0
Feet	Good

DAM									
Age	6								
Wt	960								
Prog. BW	74								
WR	100								
YR	104								
Udder	Very Good								
Calv.Ease	BW	WW	YW	Milk	HPG	Stay	Maint.En.		
EPDs	13	-1.3	67	108	24	12	21	-3.0	
Marb	+.45		REA	+.04		Bfat	+.03		
Beef Tenderness	→		DNA:	'Outstanding'		Scan:	Tender		
Wean Pct.	69%	Cow Eff.	145	HB	102	GM	42	ProS	144

★★★★★ for Low Maintenance, Growth, Gainability, Marbling, High Cow Efficiency, Calving Ease.

2 BECKTON LIKABLE H409 L6
1-A 100% # 4377089 Tat: BKT0 H409



Birth: 3-28-20
 Beckton Likable Z057 L4 < Beckton Likable X445 J3
 Beckton Minola X107 L
BECKTON LIKABLE B032 C5
 Ref. L-2 < Beckton Clifftop W577 E3
 Beckton Mona Z270 C < Beckton Mona U584 CD
 Beckton Likable B154 W4 < Beckton Likable Y124 L3
BECKTON SUSAN D158 L
 Beckton Susan B781 N < Beckton Christy W429 W
 Beckton Nebula P P707
 Beckton Susan W058 E

BWt	68
WR	115
YWt.	1248
YR	122
Feb.ADG	4.38
Feb.Scr.	37
Frame	6.0
Feet	Good

DAM									
Age	4								
Wt	1055								
Prog. BW	65								
WR	117								
YR	115								
Udder	Very Good								
Calv.Ease	BW	WW	YW	Milk	HPG	Stay	Maint.En.		
EPDs	18	-4.9	65	123	27	14	18	7.0	
Marb	+.47		REA	+.14		Bfat	+.03		
Beef Tenderness	→		DNA:	'Average'		Scan:	Tender		
Wean Pct.	56%	Cow Eff.	119	HB	89	GM	80	ProS	169

★★★★★ for Growth, Gainability, Marbling, Rib-eye area, Superior Cow, High Cow Efficiency, Calving Ease.



Lot 2

• Bulls •

4 BECKTON NEBULA H393 E5
1-A 100% # 4378021 Tat: BSF0 H393



Birth: 3-27-20

Beckton Nebula T398 V3
Beckton Minerva J615 VG
Beckton Likable U130 L2
Beckton Lana U584 CD
Beckton Emperor T641 E2
Beckton Lana U789 NB
Beckton Nebula W130 D3
Beckton Minola N751 JL

BECKTON NEBULA A773 L4
Ref. N-3

BECKTON MINOLA B063 E

DAM	
Age	6
Wt	1075
Prog. BW	63
WR	104
YR	104
Udder	Very Good

Calv.Ease	BW	WW	YW	Milk	HPG	Stay	Maint.En.
EPDs 15	-3.7	66	109	28	12	21	-1.0
Marb +.30	REA -.02	Bfat +.03					
Beef Tenderness →	DNA: 'Outstanding'	Scan: Tender					
Wean Pct. 56%	Cow Eff. 118	HB 116	GM 42	ProS 158			

BWt 76
WR 113
YWt. 1200
YR 117
Feb.ADG 3.85
Feb.Scr. 38
Frame 5.5
Feet Good

★★★★★ for Low Maintenance, Growth, Gainability, Marbling, Superior Cow, High Cow Efficiency, Calving Ease.



Lot 4

6 BECKTON LIKABLE H397 A5
1-A 100% # 4377103 Tat: BKT0 H397



Birth: 3-27-20

Beckton Likable Y124 L3
BKT Pine Marie S802 LO
Beckton Nebula T398 V3
Beckton Lana T226 NB
Beckton Cody K1 P014
Beckton Christy R046 CQ
Beckton Cherokee N N479
Beckton Emera P378 LN

BECKTON LIKABLE E391 N4
Ref. L-4

BECKTON EMERA A186 A

DAM	
Age	7
Wt	1045
Prog. BW	70
WR	101
YR	102
Udder	Very Good

Calv.Ease	BW	WW	YW	Milk	HPG	Stay	Maint.En.
EPDs 15	-3.0	71	113	25	13	22	-2.0
Marb +.44	REA -.09	Bfat +.04					
Beef Tenderness →	DNA: 'Outstanding'	Scan: Tender					
Wean Pct. 58%	Cow Eff. 122	HB 124	GM 59	ProS 183			

BWt 71
WR 114
YWt. 1201
YR 117
Feb.ADG 3.98
Feb.Scr. 37
Frame 6.0
Feet Good

★★★★★ for Low Maintenance, Growth, Gainability, Marbling, High Cow Efficiency, Calving Ease.

7 WCRA LIKABLE H162
1-A 100% # 4305901 Tat: WCRA0 HC16



Birth: 3-16-20

Beckton Likable Z057 L4
Beckton Minola X107 L
Beckton Clifftop W577 E3
Beckton Mona U584 CD
Beckton Julian GG B571
HXC Ellie May MA638
Beckton Nebula W486 D3
Beckton Indigo T613 JT

BECKTON LIKABLE B032 C5
Ref. L-2

WCRA INDIGO C 105 C

DAM	
Age	5
Wt	1275
Prog. BW	76
WR	99
YR	105
Udder	Very Good

Calv.Ease	BW	WW	YW	Milk	HPG	Stay	Maint.En.
EPDs 15	-3.6	58	105	24	11	17	10.0
Marb +.49	REA -.04	Bfat +.03					
Beef Tenderness →	DNA: NA	Scan: Tender					
Wean Pct. 46%	Cow Eff. NA	HB 70	GM 60	ProS 130			

BWt 76
WR 110
YWt. 1089
YR 110
Feb.ADG 4.20
Feb.Scr. 36
Frame 6.0
Feet Good

★★★★★ for Growth, Gainability, Marbling, Calving Ease.

5 BECKTON NEW ERA H246 A2
1-A 100% # 4378119 Tat: BSF0 H246



Birth: 3-20-20

Beckton Nebula P P707
Beckton Nebula M045
Beckton Lana M809 EP
Beckton Justice C1 R483
BKT Larkeisa R775 JC
Beckton Cody K1 P014
Beckton Susan R022 CQ
Beckton Warrior N645 T1
Beckton Belga P119 EP

BECKTON NEW ERA Y194
Ref. N-2

BECKTON BELGA B556 A

DAM	
Age	6
Wt	1110
Prog. BW	70
WR	108
YR	107
Udder	Very Good

Calv.Ease	BW	WW	YW	Milk	HPG	Stay	Maint.En.
EPDs 15	-3.2	68	114	27	13	16	1.0
Marb +.36	REA -.06	Bfat +.04					
Beef Tenderness →	DNA: 'Outstanding'	Scan: Tender					
Wean Pct. 58%	Cow Eff. 123	HB 79	GM 49	ProS 128			

BWt 74
WR 121
YWt. 1249
YR 122
Feb.ADG 4.07
Feb.Scr. 39
Frame 5.5
Feet Good

★★★★★ for Growth, Gainability, Marbling, Superior Cow, High Cow Efficiency, Calving Ease.



Lot 5

• Bulls •

8 **BECKTON JULIAN H384 E9**  1-A 100% # 4377117 Tat: BKT0 H384

Birth: 3-27-20

Beckton Julian Z382 J7 < Beckton Julian X721 E6
Beckton Larkaba X064 J

BECKTON JULIAN E423 N8
Ref. J-4 < Beckton Belga B004 N < Beckton Nebula Z111 N5
Beckton Belga Z031 N

Beckton Emperor Y459 J3 < Beckton Emperor T641 E2
Beckton Indigo S354 JT

BECKTON LANA A040 E
Beckton Lana Y561 N < Beckton Nebula T269 E2
Beckton Lana T104 CT

BWt	64
WR	123
YWt.	1244
YR	122
Feb.ADG	3.94
Feb.Scr.	39
Frame	5.5
Feet	Good

DAM											
Age	7	Calv.Ease	BW	WW	YW	Milk	HPG	Stay	Maint.En.		
Wt	1155	EPDs	20	-6.0	64	104	30	10	16	0.0	
Prog. BW	74	Marb	+.44		REA	-.09		Bfat	+.03		
WR	117	Beef Tenderness	→		DNA: 'Outstanding'	Scan: Tender					
YR	115	Wean Pct.	57%	Cow Eff.	120	HB	83	GM	37	ProS	120
Udder	Good										

★★★★★ for Low Maintenance, Growth, Gainability, Marbling, Superior Cow, High Cow Efficiency, Calving Ease.



Lot 8

10 **BECKTON NEW ERA H106 L3**  1-A 100% # Tat: BKT0 H106

Birth: 3-4-20

Beckton New Era Y194 < Beckton Nebula P P707
BKT Larkeisa T310 JC

BECKTON NEW ERA C209 J2
Ref. N-4 < Beckton Julian W743 H5
Beckton Minerva W081 N

Beckton Likable U120 L2 < Beckton Likable S633
Beckton Lana S718 LN

BECKTON LARKABA X054 L
Beckton Larkaba U153 LE < Beckton Legend S670
Beckton Larkaba S299 EP

BWt	77
WR	108
YWt.	1135
YR	111
Feb.ADG	3.85
Feb.Scr.	36
Frame	5.5
Feet	Good

DAM											
Age	10	Calv.Ease	BW	WW	YW	Milk	HPG	Stay	Maint.En.		
Wt	1070	EPDs	9	-1.4	22	30	12	4	9	-4.0	
Prog. BW	72	Marb	+.24		REA	-.08		Bfat	+.01		
WR	102	Beef Tenderness	→		DNA: 'Outstanding'	Scan: Tender					
YR	96	Wean Pct.	54%	Cow Eff.	113	HB	NA	GM	NA	ProS	NA
Udder	Fair										

★★★★★ for Low Maintenance, Gainability, Marbling.

11 **BECKTON JULIAN H420 N9**  1-A 100% # 4378001 Tat: BSF0 H420

Birth: 3-28-20

Beckton Julian Z382 J7 < Beckton Julian X721 E6
Beckton Larkaba X064 J

BECKTON JULIAN E423 N8
Ref. J-4 < Beckton Nebula Z111 N5
Beckton Belga B004 N < Beckton Belga Z031 N

Beckton Nebula W486 D3 < Beckton Nebula L P093
Beckton Belga R716 DM

BECKTON COCA A341 N
Beckton Coca U616 EP < Beckton Epic K4 N795
Beckton Coca P713 NP

BWt	68
WR	120
YWt.	1141
YR	111
Feb.ADG	3.45
Feb.Scr.	38
Frame	5.5
Feet	Good

DAM											
Age	7	Calv.Ease	BW	WW	YW	Milk	HPG	Stay	Maint.En.		
Wt	1195	EPDs	18	-4.9	61	97	30	10	18	1.0	
Prog. BW	74	Marb	+.44		REA	-.13		Bfat	+.05		
WR	116	Beef Tenderness	→		DNA: 'Very Good'	Scan: Tender					
YR	110	Wean Pct.	54%	Cow Eff.	113	HB	87	GM	25	ProS	112
Udder	Very Good										

★★★★★ for Growth, Marbling, Superior Cow, Calving Ease.

9 **BECKTON SCAMP H156 W6**  1-A 100% # 4377391 Tat: BKT0 H156

Birth: 3-11-20

Beckton Scamp B720 L4 < Beckton Scamp X458 H3
Beckton Larkaba Y448 L

BECKTON SCAMP E175 N5
Ref. S-1 < Beckton Nebula T398 V3
Beckton Belga T551 EP

Beckton Warrior Y108 E5 < Beckton Warrior Y108 E5
Beckton Lana Y033 W

BECKTON MINERVA E078 W
Beckton Minerva C549 W < Beckton Warrior Y108 E5
Beckton Minerva Y385 N

BWt	63
WR	114
YWt.	1218
YR	123
Feb.ADG	4.34
Feb.Scr.	36
Frame	5.5
Feet	Good

DAM											
Age	3	Calv.Ease	BW	WW	YW	Milk	HPG	Stay	Maint.En.		
Wt	805	EPDs	21	-6.6	54	104	29	10	17	-4.0	
Prog. BW	49	Marb	+.36		REA	+.03		Bfat	+.04		
WR	114	Beef Tenderness	→		DNA: 'Outstanding'	Scan: Tender					
YR	123	Wean Pct.	66%	Cow Eff.	139	HB	92	GM	68	ProS	160
Udder	Very Good										

★★★★★ for Low Maintenance, Growth, Gainability, Marbling, Superior Cow, High Cow Efficiency, Calving Ease.



Lot 9

• Bulls •



Lot 11

13 BECKTON DOMINOR H295 N9
1-A 100% # 4378089 Tat: BSF0 H295



Birth: 3-22-20

Beckton Dominor A378 W7 < Beckton Dominor Y005 V6
Beckton Lana Y541 W

BECKTON DOMINOR D254 N8
Ref. D-2 < Beckton Nebula T398 V3
Beckton Indigo W772 N < Beckton Indigo T613 JT

Beckton Nebula P P707 < Beckton Nebula M045
Beckton Lana M809 EP

BECKTON BARMAID B475 N
Beckton Barmaid R542 JE < Beckton Jules L429
Beckton Barmaid M296 EP

DAM										
Age	6	Calv.Ease	BW	WW	YW	Milk	HPG	Stay	Maint.En.	
Wt	1025	EPDs	18	-5.4	46	82	29	14	18	-1.0
Prog. BW	63	Marb	+.51		REA	-.01		Bfat	+.05	
WR	99	Beef Tenderness	→		DNA:	'Outstanding'		Scan:	Tender	
YR	92	Wean Pct.	55%	Cow Eff.	116	HB	95	GM	55	ProS
Udder	Very Good									

★★★★★ for Low Maintenance, Growth, Gainability, Marbling, High Cow Efficiency, Calving Ease.

12 BECKTON EPIC H216 E8
1-A 100% # 4377325 Tat: BKT0 H216



Birth: 3-17-20

Beckton Epic B483 N6 < Beckton Epic U749 D5
BKT Pine Marie X339 N

BECKTON EPIC D001 L7
Ref. E-1 < Beckton Legend U331 E2
Beckton Mona B713 L < Beckton Mona U564 JT

Beckton Epic B545 N7 < Beckton Epic Y484 N6
Beckton Serena X338 N

BECKTON PINE MARIE D098 E
Beckton Pine Marie B170 L < Beckton Likable U130 L2
BKT Pine Marie W102 C

DAM										
Age	4	Calv.Ease	BW	WW	YW	Milk	HPG	Stay	Maint.En.	
Wt	1045	EPDs	17	-5.4	58	102	27	13	17	1.0
Prog. BW	58	Marb	+.37		REA	+.26		Bfat	+.04	
WR	107	Beef Tenderness	→		DNA:	'Outstanding'		Scan:	Tender	
YR	106	Wean Pct.	56%	Cow Eff.	117	HB	87	GM	46	ProS
Udder	Very Good									

★★★★★ for Growth, Marbling, Rib-eye area, Superior Cow, High Cow Efficiency, Calving Ease.



Lot 13



Lot 12

14 BECKTON LIKABLE H136 E4
1-A 100% # 4378213 Tat: BSF0 H136



Birth: 3-9-20

Beckton Likable U130 L2 < Beckton Likable S633
Beckton Kit S478 LN

BECKTON LIKABLE D432 N3
Ref. L-3 < Beckton Nebula T054 H3
Beckton Firefly T003 JC

Beckton Epic U749 D5 < Beckton Epic K4 N795
Beckton Denise R308 DM

BECKTON COCA B405 E
Beckton Coca W362 J < Beckton Justice C1 R483
Beckton Coca P440 JL

DAM										
Age	6	Calv.Ease	BW	WW	YW	Milk	HPG	Stay	Maint.En.	
Wt	1220	EPDs	19	-4.4	47	82	27	10	15	2.0
Prog. BW	61	Marb	+.35		REA	+.11		Bfat	+.03	
WR	107	Beef Tenderness	→		DNA:	'Outstanding'		Scan:	Tender	
YR	103	Wean Pct.	45%	Cow Eff.	96	HB	67	GM	39	ProS
Udder	Good									

★★★★★ for Growth, Marbling, Superior Cow, Calving Ease.

• Bulls •

15 BECKTON NEW ERA H194 J3

1-A 100% # 4377347 Tat: BKT0 H194

Birth: 3-16-20

Beckton New Era Y194
 Beckton Julian GG B571
 Beckton Minerva Y116 J
 Beckton Julian W743 H5
 Beckton Minerva W081 N
 Beckton Julian 7526G
 Bkt Marta 9A13 JL
 Beckton Nebula T398 V3
 Beckton Coca P602 JL

BWt	86
WR	109
YWt	1104
YR	108
Feb.ADG	3.67
Feb.Scr.	33
Frame	5.5
Feet	Good

DAM	
Age	6
Wt	1010
Prog. BW	72
WR	102
YR	107
Udder	Very Good

Calv.Ease	BW	WW	YW	Milk	HPG	Stay	Maint.En.
EPDs	12	-0.8	64	103	25	14	18 -3.0
Marb	+0.40		REA -.05		Bfat +0.03		
Beef Tenderness	→		DNA: 'Outstanding'		Scan: Tender		
Wean Pct.	58%	Cow Eff.	121	HB	76	GM	35 ProS 111

18 BECKTON DOMINOR H442 A10

1-A 100% # 4377975 Tat: BKB0 H442

Birth: 3-29-20

Beckton Dominor C052 E8
 Beckton Dominor A378 W7
 Beckton Scarlett A406 E
 Beckton Dominor A378 W7
 Beckton Christy C149 D
 Beckton Christy A234 N
 Beckton Cody K1 P014
 Beckton Susan R022 CQ
 Beckton Loki F251
 Beckton Indigo E370 RN

BWt	77
WR	108
YWt	1159
YR	113
Feb.ADG	3.85
Feb.Scr.	34
Frame	5.5
Feet	Good

DAM	
Age	4
Wt	960
Prog. BW	73
WR	116
YR	117
Udder	Good

Calv.Ease	BW	WW	YW	Milk	HPG	Stay	Maint.En.
EPDs	17	-3.4	52	92	34	11	16 -2.0
Marb	+0.56		REA +0.01		Bfat +0.04		
Beef Tenderness	→		DNA: 'Outstanding'		Scan: Tender		
Wean Pct.	58%	Cow Eff.	122	HB	80	GM	61 ProS 141

★★★★★ for Low Maintenance, Growth, Gainability, Marbling, High Cow Efficiency, Calving Ease.

★★★★★ for Low Maintenance, Growth, Gainability, Marbling, Superior Cow, High Cow Efficiency, Calving Ease.

16 BECKTON JULIAN H465 L9

1-A 100% # 4377953 Tat: BSF0 H465

Birth: 3-31-20

Beckton Julian Z382 J7
 Beckton Julian E423 N8
 Beckton Belga B004 N
 Beckton Legend X561 J2
 Beckton Legend S670
 Beckton Lana T279 JO
 Beckton Nebula Z111 N5
 Beckton Belga Z031 N
 Beckton Nebula L P093
 Beckton Encino W287 N
 Beckton Encino S303 LO

BWt	84
WR	115
YWt	1148
YR	112
Feb.ADG	3.85
Feb.Scr.	37
Frame	5.5
Feet	Good

DAM	
Age	8
Wt	1380
Prog. BW	76
WR	121
YR	114
Udder	Fair

Calv.Ease	BW	WW	YW	Milk	HPG	Stay	Maint.En.
EPDs	15	-2.3	62	96	31	12	19 5.0
Marb	+0.46		REA -.13		Bfat +0.04		
Beef Tenderness	→		DNA: 'Outstanding'		Scan: Tender		
Wean Pct.	44%	Cow Eff.	94	HB	96	GM	29 ProS 125

★★★★★ for Growth, Gainability, Marbling, Superior Cow, Calving Ease.



Lot 18

17 BECKTON DOMINOR H334 A9

1-A 100% # 4377183 Tat: BKT0 H334

Birth: 3-24-20

Beckton Dominor A378 W7
 Beckton Dominor D254 N8
 Beckton Indigo W772 N
 Beckton Accent U777 C2
 Beckton Accent U777 C2
 Beckton Susan R022 CQ
 Beckton Epic R350 K
 Beckton Lana Y541 W
 Beckton Nebula T398 V3
 Beckton Indigo T613 JT
 Beckton Cody K1 P014
 Beckton Larkaba R336 CK

BWt	66
WR	108
YWt	1144
YR	112
Feb.ADG	3.98
Feb.Scr.	36
Frame	5.5
Feet	Good

DAM	
Age	9
Wt	1130
Prog. BW	75
WR	105
YR	108
Udder	Very Good

Calv.Ease	BW	WW	YW	Milk	HPG	Stay	Maint.En.
EPDs	17	-3.7	60	104	31	14	18 0.0
Marb	+0.43		REA +0.07		Bfat +0.04		
Beef Tenderness	→		DNA: 'Outstanding'		Scan: Tender		
Wean Pct.	51%	Cow Eff.	107	HB	105	GM	59 ProS 164

★★★★★ for Low Maintenance, Growth, Gainability, Marbling, Superior Cow, Calving Ease.

19 BECKTON LIKABLE H620 W4

1-A 100% # 4376857 Tat: BKT0 H620

Birth: 4-13-20

Beckton Likable U130 L2
 Beckton Likable Y124 L3
 BKT Pine Marie S802 LO
 Beckton Warrior W534 N4
 Beckton Lana Z276 W
 Beckton Lana U297 VA
 Beckton Likable S633
 Beckton Kit S478 LN
 Beckton Lasso P741
 BKT Pine Marie P475 LN
 Beckton Warrior C1 S337
 BKT Larkeisa S055 NB
 Beckton Vega P079
 Beckton Lana P317 JL

BWt	71
WR	115
YWt	1188
YR	116
Feb.ADG	3.89
Feb.Scr.	38
Frame	5.5
Feet	Good

DAM	
Age	8
Wt	1170
Prog. BW	67
WR	110
YR	105
Udder	Good

Calv.Ease	BW	WW	YW	Milk	HPG	Stay	Maint.En.
EPDs	20	-5.7	52	86	30	14	15 -3.0
Marb	+0.41		REA -.01		Bfat +0.04		
Beef Tenderness	→		DNA: 'Outstanding'		Scan: Tender		
Wean Pct.	52%	Cow Eff.	110	HB	88	GM	44 ProS 132

★★★★★ for Low Maintenance, Growth, Gainability, Marbling, Superior Cow, Calving Ease.

• Bulls •



Lot 19

22 BECKTON LIKABLE H112 E7
1-A 100% # 4377443 Tat: BKT0 H112

Birth: 3-5-20

Beckton Likable B032 C5
Beckton Likable Z057 L4
Beckton Mona Z270 C

BECKTON LIKABLE F287 J6
Ref. L-7
Beckton Larkaba X064 J
Beckton Julian U699 L5
Beckton Larkaba U475 CT

Beckton Epic D002 E8
Beckton Epic B545 N7
Beckton Christy B701 E

BECKTON KIT F412 E
Beckton Kit C839 A
Beckton Accent W180 C2
Beckton Kit Z181 D

DAM	Age	2	Calv.Ease	BW	WW	YW	Milk	HPG	Stay	Maint.En.		
	Wt	855	EPDs	21	-5.7	56	99	27	12	21	-3.0	
	Prog. BW	66	Marb	+.50		REA +.10		Bfat +.04				
	WR	114	Beef Tenderness	→		DNA: 'Average'		Scan: Tender				
	YR	110	Wean Pct.	59%	Cow Eff.	124	HB	118	GM	53	ProS	171
	Udder	Very Good										

BWT 66
WR 114
YWt. 1118
YR 110
Feb.ADG 3.72
Feb.Scr. 33
Frame 6.0
Feet Good

★★★★★ for Low Maintenance, Growth, Gainability, Marbling, Superior Cow, High Cow Efficiency, Calving Ease.

20 BECKTON ACCENT H223 N5
1-A 100% # 4378135 Tat: BSF0 H223

Birth: 3-18-20

Beckton Accent Y312 N3
Beckton Accent U777 C2
BKT Larkeisa S055 NB

BECKTON ACCENT C557 N4
Ref. A-4
Beckton Minerva Y654 N
Beckton Nebula T398 V3
Beckton Minerva M369 L0

Beckton New Era Y194
Beckton Nebula P P707
BKT Larkeisa T310 JC

BECKTON LARKABEL E817 N
Beckton Larkabel A015 A
Beckton Accent Y260 L3
Beckton Larkabel Y487 A

DAM	Age	3	Calv.Ease	BW	WW	YW	Milk	HPG	Stay	Maint.En.		
	Wt	905	EPDs	15	-2.7	68	110	27	14	18	2.0	
	Prog. BW	74	Marb	+.47		REA -.07		Bfat +.05				
	WR	120	Beef Tenderness	→		DNA: 'Outstanding'		Scan: Tender				
	YR	116	Wean Pct.	62%	Cow Eff.	130	HB	95	GM	45	ProS	140
	Udder	Good										

BWT 74
WR 120
YWt. 1149
YR 116
Feb.ADG 3.76
Feb.Scr. 38
Frame 5.5
Feet Good

★★★★★ for Growth, Gainability, Marbling, Superior Cow, High Cow Efficiency, Calving Ease.



Lot 22

21 BECKTON DOMINOR H449 A9
1-A 100% # 4377049 Tat: BKT0 H449

Birth: 3-30-20

Beckton Dominor A378 W7
Beckton Dominor Y005 V6
Beckton Lana Y541 W

BECKTON DOMINOR D495 W8
Ref. D-3
Beckton Encino X642 W
Beckton Warrior T248 L5
Beckton Encino S090 JT

Beckton Accent Y260 L3
Beckton Accent W180 C2
Beckton Lana W463 L

BECKTON ROSE C681 A
Beckton Rose W283 J
Beckton Jet L P491
Beckton Rose P016 LN

DAM	Age	5	Calv.Ease	BW	WW	YW	Milk	HPG	Stay	Maint.En.		
	Wt	1150	EPDs	16	-3.1	59	96	27	12	19	-2.0	
	Prog. BW	70	Marb	+.57		REA -.02		Bfat +.04				
	WR	108	Beef Tenderness	→		DNA: 'Outstanding'		Scan: Tender				
	YR	111	Wean Pct.	50%	Cow Eff.	105	HB	105	GM	50	ProS	155
	Udder	Very Good										

BWT 70
WR 108
YWt. 1132
YR 111
Feb.ADG 3.76
Feb.Scr. 35
Frame 5.5
Feet Good

★★★★★ for Low Maintenance, Growth, Gainability, Marbling, Superior Cow, Calving Ease.

23 BECKTON DOMINOR H423 N9
1-A 100% # 4377997 Tat: BSF0 H423

Birth: 3-28-20

Beckton Dominor A378 W7
Beckton Dominor Y005 V6
Beckton Lana Y541 W

BECKTON DOMINOR D254 N8
Ref. D-2
Beckton Indigo W772 N
Beckton Nebula T398 V3
Beckton Indigo T613 JT

Beckton Nebula W022 D3
Beckton Nebula T269 E2
Beckton Eola T070 DM

BECKTON LANA Y130 N
Beckton Lana W525 D
Beckton Dominor Z1 R610
Beckton Lana S520 JO

DAM	Age	9	Calv.Ease	BW	WW	YW	Milk	HPG	Stay	Maint.En.		
	Wt	1115	EPDs	18	-5.5	49	83	30	14	19	-1.0	
	Prog. BW	68	Marb	+.43		REA -.05		Bfat +.04				
	WR	105	Beef Tenderness	→		DNA: 'Outstanding'		Scan: Tender				
	YR	106	Wean Pct.	50%	Cow Eff.	105	HB	109	GM	45	ProS	154
	Udder	Very Good										

BWT 66
WR 105
YWt. 1089
YR 106
Feb.ADG 3.58
Feb.Scr. 36
Frame 6.0
Feet Good

★★★★★ for Low Maintenance, Growth, Gainability, Marbling, Superior Cow, Calving Ease.

• Bulls •

24 BECKTON ACCENT H391 N4

1-A 100% # 4378023 Tat: BSF0 H391

Birth: 3-27-20

BECKTON ACCENT B549 N3
Ref. A-2

BECKTON MINERVA A470 N

Beckton Cody K1 P014
Beckton Christy R046 CQ

Beckton Nebula T398 V3
Beckton Minerva M369 LO

Beckton Nebula W065 C3
Beckton Rose W402 N

Beckton Julian U742 W5
Beckton Minerva U586 CT

BWt 65
WR 111
YWt. 1095
YR 107
Feb.ADG 3.58
Feb.Scr. 36
Frame 5.5
Feet Good

DAM		Calv.Ease	BW	WW	YW	Milk	HPG	Stay	Maint.En.		
Age	7										
Wt	1045	EPDs	15	-2.9	59	97	23	12	19	-2.0	
Prog. BW	72	Marb	+.41		REA	+.06		Bfat	+.02		
WR	104	Beef Tenderness	→		DNA:	'Outstanding'		Scan:	Tender		
YR	105	Wean Pct.	57%	Cow Eff.	119	HB	92	GM	36	ProS	128
Udder	Very Good										

★★★★★ for Low Maintenance, Growth, Gainability, Marbling, Superior Cow, High Cow Efficiency, Calving Ease.

27 BSF ACCENT H226 H4

1-B 99% # 4378131 Tat: BSF0 H226

Birth: 3-18-20

BECKTON ACCENT E172 L3
Ref. A-5

BSF JUSTICIA X006 H

Beckton Cody K1 P014
Beckton Christy R046 CQ

Beckton Likable U130 L2
Beckton Indigo R745 WR

Beckton Hasten H S462
Beckton Encino S456 JC

Beckton Justice C1 R483
BSF Regus K326 WH

BWt 70
WR 113
YWt. 1175
YR 115
Feb.ADG 3.82
Feb.Scr. 37
Frame 5.5
Feet Good

DAM		Calv.Ease	BW	WW	YW	Milk	HPG	Stay	Maint.En.		
Age	10										
Wt	1005	EPDs	15	-3.9	57	95	27	12	19	-4.0	
Prog. BW	70	Marb	+.30		REA	-.06		Bfat	+.02		
WR	108	Beef Tenderness	→		DNA:	'Outstanding'		Scan:	Tender		
YR	105	Wean Pct.	60%	Cow Eff.	126	HB	99	GM	33	ProS	132
Udder	Very Good										

★★★★★ for Low Maintenance, Growth, Gainability, Marbling, Superior Cow, High Cow Efficiency, Calving Ease.

25 BECKTON GENETICS H438

1-B 99% # 4377981 Tat: BSF0 H438

Birth: 3-29-20

BECKTON GENETICS MULTI SIRE
Ref.

BECKTON CHRISTY Z083 J

Beckton Julian X721 E6
Beckton Julian U699 L5
Beckton Lana U329 EP

Beckton Dominor Z1 R610
Beckton Christy J743 JL

BWt 84
WR 127
YWt. 1194
YR 117
Feb.ADG 3.50
Feb.Scr. 37
Frame 6.0
Feet Good

DAM		Calv.Ease	BW	WW	YW	Milk	HPG	Stay	Maint.En.		
Age	8										
Wt	1120	EPDs	12	-0.5	59	86	27	7	11	-3.0	
Prog. BW	74	Marb	+.45		REA	+.32		Bfat	+.04		
WR	115	Beef Tenderness	→		DNA:	'Outstanding'		Scan:	Tender		
YR	106	Wean Pct.	60%	Cow Eff.	127	HB	45	GM	57	ProS	102
Udder	Very Good										

★★★★★ for Low Maintenance, Growth, Marbling, Rib-eye area, Superior Cow, High Cow Efficiency, Calving Ease.

28 BSF HERITAGE H402 J5

1-B 99% # 4378013 Tat: BSF0 H402

Birth: 3-27-20

BECKTON HERITAGE C477 J4
Ref. H-1

BSF JUSTICIA Z119 J

Beckton Heritage X403 L3
Beckton Indigo H150 LN

Beckton Julian U699 L5
Beckton Ruth U557 JT

Beckton Julian U699 L5
Beckton Lana U329 EP

Beckton Jet U473 L2
BSF Justicia U855 JC

BWt 81
WR 115
YWt. 1144
YR 112
Feb.ADG 3.77
Feb.Scr. 33
Frame 5.5
Feet Good

DAM		Calv.Ease	BW	WW	YW	Milk	HPG	Stay	Maint.En.		
Age	8										
Wt	1105	EPDs	15	-2.0	61	98	34	12	16	-2.0	
Prog. BW	68	Marb	+.40		REA	+.13		Bfat	+.04		
WR	114	Beef Tenderness	→		DNA:	'Outstanding'		Scan:	Tender		
YR	107	Wean Pct.	56%	Cow Eff.	117	HB	88	GM	46	ProS	134
Udder	Very Good										

★★★★★ for Low Maintenance, Growth, Gainability, Marbling, Rib-eye area, Superior Cow, High Cow Efficiency, Calving Ease.

26 BECKTON GENETICS H183

1-B 99% # 4378177 Tat: BSF0 H183

Birth: 3-15-20

BECKTON GENETICS MULTI SIRE
Ref.

BECKTON TARA W482 L

Beckton Loki C M740
Beckton Lakme J460 LT

Beckton Justice CH M056
Beckton Tara M635 JL

BWt 63
WR 102
YWt. 1121
YR 110
Feb.ADG 3.85
Feb.Scr. 37
Frame 5.5
Feet Good

DAM		Calv.Ease	BW	WW	YW	Milk	HPG	Stay	Maint.En.		
Age	11										
Wt	1100	EPDs	18	-5.1	39	65	24	6	9	-2.0	
Prog. BW	67	Marb	+.39		REA	+.05		Bfat	+.03		
WR	107	Beef Tenderness	→		DNA:	'Outstanding'		Scan:	Tender		
YR	107	Wean Pct.	48%	Cow Eff.	100	HB	25	GM	72	ProS	97
Udder	Very Good										

★★★★★ for Low Maintenance, Growth, Gainability, Marbling, Superior Cow, Calving Ease.



Lot 25

• Bulls •

29 **BSF LIKABLE H004 A7**  1-B 99% # 4378303 Tat: BSF0 H004

Birth: 2-13-20

BECKTON LIKABLE F287 J6  Ref. L-7

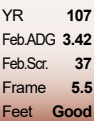
BSF JULIANNE F138 A 

Age	2	Calv.Ease	BW	WW	YW	Milk	HPG	Stay	Maint.En.	
Wt	695	EPDs	20	-6.7	54	96	24	12	21	-2.0
Prog. BW	54	Marb	+.71		REA	-.14		Bfat	+.05	
WR	107	Beef Tenderness	→		DNA: 'Outstanding'			Scan:	Tender	
YR	107	Wean Pct.	67%		Cow Eff.	141		HB	109	
Udder	Good							GM	60	
								ProS	169	

★★★★★ for Low Maintenance, Growth, Marbling, Superior Cow, High Cow Efficiency, Calving Ease.

32 **BSF CARDINAL H309 N2**  1-B 99% # 4378081 Tat: BSF0 H309

Birth: 3-23-20

BECKTON CARDINAL E673 L  Ref. C-1

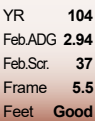
BSF JUSTICIA Z267 N 

Age	8	Calv.Ease	BW	WW	YW	Milk	HPG	Stay	Maint.En.	
Wt	1190	EPDs	21	-6.3	54	87	27	14	16	-1.0
Prog. BW	67	Marb	+.40		REA	+.25		Bfat	+.04	
WR	101	Beef Tenderness	→		DNA: 'Average'			Scan:	Tender	
YR	101	Wean Pct.	50%		Cow Eff.	104		HB	92	
Udder	Very Good							GM	33	
								ProS	125	

★★★★★ for Low Maintenance, Marbling, Rib-eye area, Calving Ease.

30 **BSF ACCENT H567 E3**  1-B 99% # 4377871 Tat: BSF0 H567

Birth: 4-8-20

BECKTON ACCENT B553 L2  Ref. A-3

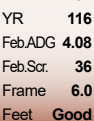
BSF NEBULANN D682 E 

Age	4	Calv.Ease	BW	WW	YW	Milk	HPG	Stay	Maint.En.	
Wt	930	EPDs	13	-0.8	64	110	25	13	16	-1.0
Prog. BW	74	Marb	+.35		REA	+.06		Bfat	+.03	
WR	106	Beef Tenderness	→		DNA: 'Outstanding'			Scan:	Tender	
YR	107	Wean Pct.	62%		Cow Eff.	130		HB	71	
Udder	Very Good							GM	55	
								ProS	126	

★★★★★ for Low Maintenance, Growth, Gainability, Marbling, Superior Cow, High Cow Efficiency, Calving Ease.

33 **BSF ACCENT H346 S5**  1-B 99% # 4378049 Tat: BSF0 H346

Birth: 3-25-20

BECKTON ACCENT C557 N4  Ref. A-4

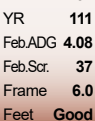
BSF WARRITA C219 S 

Age	5	Calv.Ease	BW	WW	YW	Milk	HPG	Stay	Maint.En.	
Wt	1010	EPDs	17	-4.7	54	89	30	13	14	0.0
Prog. BW	64	Marb	+.50		REA	-.04		Bfat	+.04	
WR	106	Beef Tenderness	→		DNA: 'Outstanding'			Scan:	Tender	
YR	98	Wean Pct.	55%		Cow Eff.	116		HB	75	
Udder	Good							GM	54	
								ProS	129	

★★★★★ for Low Maintenance, Growth, Gainability, Marbling, High Cow Efficiency, Calving Ease.

31 **BSF RANGER H547 C6**  1-B 99% # 4377883 Tat: BSF0 H547

Birth: 4-6-20

BECKTON RANGER B006 D5  Ref. R-1

BSF CHERISE D053 C 

Age	4	Calv.Ease	BW	WW	YW	Milk	HPG	Stay	Maint.En.	
Wt	975	EPDs	18	-5.2	58	103	27	12	13	0.0
Prog. BW	59	Marb	+.46		REA	+.14		Bfat	+.03	
WR	107	Beef Tenderness	→		DNA: 'Outstanding'			Scan:	Tender	
YR	106	Wean Pct.	59%		Cow Eff.	123		HB	72	
Udder	Very Good							GM	66	
								ProS	138	

★★★★★ for Low Maintenance, Growth, Gainability, Marbling, Rib-eye area, Superior Cow, High Cow Efficiency, Calving Ease.

34 **BSF ACCENT H400 A4**  1-B 99% # 4378015 Tat: BSF0 H400

Birth: 3-27-20

BECKTON ACCENT B549 N3  Ref. A-2

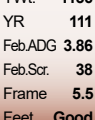
BSF DOMINIQUE Y109 A 

Age	9	Calv.Ease	BW	WW	YW	Milk	HPG	Stay	Maint.En.	
Wt	1240	EPDs	14	-2.5	66	111	20	12	21	6.0
Prog. BW	74	Marb	+.44		REA	+.05		Bfat	+.04	
WR	106	Beef Tenderness	→		DNA: 'Outstanding'			Scan:	Tender	
YR	109	Wean Pct.	44%		Cow Eff.	92		HB	100	
Udder	Good							GM	49	
								ProS	149	

★★★★★ for Growth, Gainability, Marbling, Superior Cow, Calving Ease.

• Bulls •

35 BECKTON HUGHES H173 R4 1-A 100% # 4377371 Tat: BKT0 H173



Birth: 3-14-20

Beckton Hughes D589 S2 < Bieber H Hughes W109
Beckton Sierra Z353 S

BECKTON HUGHES F076 H3
Ref. B-2 < Beckton Emera D487 B < Bieber H Hughes W109
Beckton Emera A186 A

Beckton Ranger B006 D5 < Beckton Ranger Z225 J4
Beckton Suffeina Z731 D

BECKTON TAMARA F774 R
Beckton Tamara R175 CQ < Beckton Cherokee N N479
Beckton Tamara N765 CO

DAM	
Age	2
Wt	810
Prog. BW	64
WR	112
YR	113
Udder	Very Good

Calv.Ease	BW	WW	YW	Milk	HPG	Stay	Maint.En.	
EPDs	17	-2.8	67	109	28	12	14	-3.0
Marb	+0.38		REA +0.10		Bfat +0.05			
Beef Tenderness	→		DNA: 'Outstanding'		Scan: NA			
Wean Pct.	61%	Cow Eff.	127	HB	87	GM	45	ProS 132

★★★★★ for Low Maintenance, Growth, Gainability, Marbling, Superior Cow, High Cow Efficiency, Calving Ease.

38 BECKTON CARDINAL H060 E4 1-A 100% # 4377505 Tat: BKT0 H060



Birth: 2-24-20

Beckton Cardinal D010 W2 < Beckton Cardinal B074 N
Beckton Firefly B052 W

BECKTON CARDINAL F175 L3
Ref. C-2 < Beckton Larkaba B428 L < Beckton Likable U130 L2
Beckton Larkaba X064 J

Beckton Epic B545 N7 < Beckton Epic Y484 N6
Beckton Serena X338 N

BECKTON LANA F259 E
Beckton Lana Y024 N < Beckton Nebula W065 C3
Beckton Lana W277 A

DAM	
Age	2
Wt	995
Prog. BW	60
WR	108
YR	114
Udder	-

Calv.Ease	BW	WW	YW	Milk	HPG	Stay	Maint.En.	
EPDs	21	-5.1	59	103	28	13	16	-3.0
Marb	+0.36		REA +0.05		Bfat +0.03			
Beef Tenderness	→		DNA: 'Outstanding'		Scan: Tender			
Wean Pct.	47%	Cow Eff.	100	HB	95	GM	56	ProS 151

★★★★★ for Low Maintenance, Growth, Gainability, Marbling, Superior Cow, Calving Ease.

36 BSF LIKABLE H212 R5 1-B 99% # 4378147 Tat: BSF0 H212



Birth: 3-17-20

Beckton Likable B509 J3 < Beckton Likable U130 L2
Beckton Coca T363 JL

BECKTON LIKABLE F816 A4
Ref. L-10 < Beckton Accent Y312 N3
Beckton Barmaid B366 A < Beckton Barmaid X819 N

Beckton Roosevelt D305 C2 < Bieber Roosevelt W384
Beckton Lana W277 A

BSF CODETTE F077 R
BSF Codette D107 R < Beckton Ranger B006 D5
BSF Codette B734 D

DAM	
Age	2
Wt	865
Prog. BW	75
WR	111
YR	110
Udder	Very Good

Calv.Ease	BW	WW	YW	Milk	HPG	Stay	Maint.En.	
EPDs	14	-0.9	67	109	28	12	15	-4.0
Marb	+0.33		REA +0.11		Bfat +0.04			
Beef Tenderness	→		DNA: 'Outstanding'		Scan: Tender			
Wean Pct.	57%	Cow Eff.	119	HB	85	GM	40	ProS 125

★★★★★ for Low Maintenance, Growth, Gainability, Marbling, Superior Cow, High Cow Efficiency, Calving Ease.

39 BECKTON LIKABLE H200 A6 1-A 100% # 4377341 Tat: BKT0 H200



Birth: 3-16-20

Beckton Likable Z057 L4 < Beckton Likable X445 J3
Beckton Minola X107 L

BECKTON LIKABLE B032 C5
Ref. L-2 < Beckton Clifftop W577 E3
Beckton Mona Z270 C < Beckton Mona U584 CD

Beckton Accent W180 C2 < Beckton Cody K1 P014
Beckton Christy R046 CQ

BECKTON MAIATA Y201 A
Beckton Maiata W189 J < Beckton Julian G3 P608
Beckton Maiata P892 JL

DAM	
Age	9
Wt	1035
Prog. BW	66
WR	101
YR	99
Udder	Very Good

Calv.Ease	BW	WW	YW	Milk	HPG	Stay	Maint.En.	
EPDs	18	-4.7	54	99	25	13	20	-1.0
Marb	+0.47		REA +0.09		Bfat +0.02			
Beef Tenderness	→		DNA: 'Very Good'		Scan: Tender			
Wean Pct.	51%	Cow Eff.	107	HB	98	GM	62	ProS 160

★★★★★ for Low Maintenance, Growth, Gainability, Marbling, Superior Cow, Calving Ease.

37 BSF NEW ERA H395 A2 1-B 99% # 4378019 Tat: BSF0 H395



Birth: 3-27-20

Beckton Nebula P P707 < Beckton Nebula M045
Beckton Lana M809 EP

BECKTON NEW ERA Y194
Ref. N-2 < BKT Larkeisa T310 JC < Beckton Justice C1 R483
BKT Larkeisa R775 JC

Beckton Accent U777 C2 < Beckton Cody K1 P014
Beckton Susan R022 CQ

BSF CLIFFTANA X100 A
BSF Clifftana U177 CT < BKT Clifftop TP R288
BSF Regus F175

DAM	
Age	10
Wt	1105
Prog. BW	75
WR	110
YR	105
Udder	Fair

Calv.Ease	BW	WW	YW	Milk	HPG	Stay	Maint.En.	
EPDs	14	-1.8	66	106	28	12	16	1.0
Marb	+0.40		REA -.14		Bfat +0.03			
Beef Tenderness	→		DNA: 'Outstanding'		Scan: Tender			
Wean Pct.	56%	Cow Eff.	118	HB	68	GM	40	ProS 108

★★★★★ for Growth, Gainability, Marbling, Superior Cow, High Cow Efficiency, Calving Ease.



Lot 39

• Bulls •

40 BECKTON LIKABLE H164 N6 1-A 100% # 4378189 Tat: BSF0 H164 

Birth: 3-12-20

Beckton Likable Z057 L4 < Beckton Likable X445 J3
Beckton Minola X107 L

BECKTON LIKABLE B032 C5 Ref. L-2
Beckton Mona Z270 C < Beckton Clifftop W577 E3
Beckton Mona U584 CD

Beckton Nebula T398 V3 < Beckton Nebula L P093
Beckton Minerva J615 VG

BECKTON BARMAID X654 N
Beckton Barmaid S758 DM < Beckton Dominor ZC M919
Beckton Barmaid K080 CH

BWt	75
WR	90
YWt.	1095
YR	107
Feb.ADG	4.43
Feb.Scr.	35
Frame	5.5
Feet	Good

DAM											
Age	10	Calv.Ease	BW	WW	YW	Milk	HPG	Stay	Maint.En.		
Wt	1220	EPDs	15	-4.3	49	97	26	12	22	4.0	
Prog. BW	67	Marb	+.48		REA	+.00		Bfat	+.03		
WR	99	Beef Tenderness	→		DNA:	'Average'		Scan:	Tender		
YR	102	Wean Pct.	39%	Cow Eff.	82	HB	98	GM	75	ProS	173
Udder	Good										

★★★★★ for Growth, Gainability, Marbling, Calving Ease.

43 BECKTON LIKABLE H123 N4 1-A 100% # 4377429 Tat: BKT0 H123 

Birth: 3-7-20

Beckton Likable U130 L2 < Beckton Likable S633
Beckton Kit S478 LN

BECKTON LIKABLE D432 N3 Ref. L-3
Beckton Firefly W013 N < Beckton Nebula T054 H3
Beckton Firefly T003 JC

Beckton New Era Y194 < Beckton Nebula P P707
BKT Larkeisa T310 JC

BECKTON MINERVA C388 N
Beckton Minerva W901 J < Beckton Julian G3 P608
Beckton Minerva L344 CH

BWt	68
WR	94
YWt.	1048
YR	102
Feb.ADG	3.81
Feb.Scr.	36
Frame	5.5
Feet	Good

DAM											
Age	5	Calv.Ease	BW	WW	YW	Milk	HPG	Stay	Maint.En.		
Wt	1075	EPDs	18	-4.8	48	80	25	12	18	-7.0	
Prog. BW	56	Marb	+.33		REA	+.02		Bfat	+.02		
WR	97	Beef Tenderness	→		DNA:	'Outstanding'		Scan:	Tender		
YR	98	Wean Pct.	47%	Cow Eff.	98	HB	92	GM	32	ProS	124
Udder	Very Good										

★★★★★ for Low Maintenance, Gainability, Marbling, Calving Ease.

41 BECKTON JULIAN H428 A8 1-A 100% # 4377991 Tat: BSF0 H428 

Birth: 3-28-20

Beckton Julian X721 E6 < Beckton Julian U699 L5
Beckton Lana U329 EP

BECKTON JULIAN Z382 J7 Ref. J-2
Beckton Larkaba X064 J < Beckton Julian U699 L5
Beckton Larkaba U475 CT

Beckton Accent A175 O3 < Beckton Accent W180 C2
Beckton Lana R214 RA

BECKTON CHRISTY E813 A
Beckton Christy B512 D < Beckton Dominor W640 C5
Beckton Christy X526 L

BWt	61
WR	119
YWt.	1150
YR	116
Feb.ADG	3.54
Feb.Scr.	33
Frame	5.5
Feet	Good

DAM											
Age	3	Calv.Ease	BW	WW	YW	Milk	HPG	Stay	Maint.En.		
Wt	1075	EPDs	21	-6.8	64	101	28	11	21	-2.0	
Prog. BW	61	Marb	+.41		REA	-.01		Bfat	+.05		
WR	119	Beef Tenderness	→		DNA:	'Very Good'		Scan:	Tender		
YR	116	Wean Pct.	51%	Cow Eff.	108	HB	116	GM	38	ProS	154
Udder	Very Good										

★★★★★ for Low Maintenance, Growth, Gainability, Marbling, Superior Cow, Calving Ease.

44 BECKTON EPIC H163 L8 1-A 100% # 4377383 Tat: BKT0 H163 

Birth: 3-12-20

Beckton Epic Z674 E6 < Beckton Epic U749 D5
Beckton Indigo U504 EP

BECKTON EPIC F279 A7 Ref. E-2
Beckton Firefly B511 A < Beckton Accent W180 C2
Beckton Firefly X336 H

Beckton Likable D063 N4 < Beckton Likable Y124 L3
Beckton Serena W738 N

BECKTON LANA F306 L
Beckton Lana D453 L < Beckton Likable Y124 L3
Beckton Lana A200 N

BWt	64
WR	112
YWt.	1103
YR	109
Feb.ADG	3.81
Feb.Scr.	42
Frame	6.0
Feet	Good

DAM											
Age	2	Calv.Ease	BW	WW	YW	Milk	HPG	Stay	Maint.En.		
Wt	755	EPDs	19	-4.0	67	110	30	11	14	2.0	
Prog. BW	64	Marb	+.48		REA	+.02		Bfat	+.05		
WR	112	Beef Tenderness	→		DNA:	'Outstanding'		Scan:	Tender		
YR	109	Wean Pct.	66%	Cow Eff.	138	HB	78	GM	47	ProS	125
Udder	Very Good										

★★★★★ for Growth, Gainability, Marbling, Superior Cow, High Cow Efficiency, Calving Ease.

42 BECKTON DOMINOR H481 A10 1-A 100% # 4377019 Tat: BKT0 H481 

Birth: 4-1-20

Beckton Dominor C052 E8 < Beckton Dominor A378 W7
Beckton Scarlett A406 E

BECKTON DOMINOR E693 D9 Ref. D-4
Beckton Christy C149 D < Beckton Dominor A378 W7
Beckton Christy A234 N

Beckton Accent W180 C2 < Beckton Cody K1 P014
Beckton Christy R046 CQ

BECKTON LAKME Y027 A
Beckton Lakme W267 L < Beckton Loki CL S284
Beckton Lakme M669 EP

BWt	50
WR	101
YWt.	1101
YR	108
Feb.ADG	3.76
Feb.Scr.	35
Frame	5.5
Feet	Good

DAM											
Age	9	Calv.Ease	BW	WW	YW	Milk	HPG	Stay	Maint.En.		
Wt	1075	EPDs	21	-6.7	55	93	29	12	17	-2.0	
Prog. BW	60	Marb	+.55		REA	+.02		Bfat	+.04		
WR	95	Beef Tenderness	→		DNA:	'Very Good'		Scan:	Tender		
YR	98	Wean Pct.	50%	Cow Eff.	106	HB	95	GM	63	ProS	158
Udder	Good										

★★★★★ for Low Maintenance, Growth, Gainability, Marbling, Calving Ease.



Lot 44

• Bulls •

45 BECKTON ACCENT H699 N5
1-A 100% # 4376771 Tat: BKT0 H699 

Birth: 4-25-20

Beckton Accent Y312 N3
Beckton Accent U777 C2
BKT Larkeisa S055 NB

BECKTON ACCENT C557 N4
Ref. A-4
Beckton Minerva Y654 N
Beckton Nebula T398 V3
Beckton Minerva M369 LO

Beckton Nebula X603 J4
Beckton Nebula T398 V3
Beckton Firefly T003 JC

BECKTON ENCINO Z033 N
Beckton Encino X243 H
Beckton Hasten H S462
Beckton Encino G238 BR

BWt	66
WR	115
YWt.	1128
YR	110
Feb.ADG	3.63
Feb.Scr.	34
Frame	6.0
Feet	Good

DAM											
Age	8	Calv.Ease	BW	WW	YW	Milk	HPG	Stay	Maint.En.		
Wt	915	EPDs	17	-5.5	56	90	29	13	17	-2.0	
Prog. BW	64	Marb	+.38		REA	-.02		Bfat	+.04		
WR	109	Beef Tenderness	→		DNA:	'Outstanding'		Scan:	Tender		
YR	104	Wean Pct.	67%	Cow Eff.	141	HB	99	GM	37	ProS	136
Udder	Very Good										

★★★★★ for Low Maintenance, Growth, Gainability, Marbling, Superior Cow, High Cow Efficiency, Calving Ease.

48 BECKTON ACCENT H289 J4
1-A 100% # 4377231 Tat: BKT0 H289 

Birth: 3-22-20

Beckton Accent W180 C2
Beckton Cody K1 P014
Beckton Christy R046 CQ

BECKTON ACCENT B549 N3
Ref. A-2
Beckton Minerva Y654 N
Beckton Nebula T398 V3
Beckton Minerva M369 LO

Beckton Janus X799 L2
Beckton Roman J S158
Beckton Sierra K557 LO

BECKTON ROSE Z078 J
Beckton Rose X573 N
Beckton Nebula T054 H3
Beckton Rose T142 HI

BWt	71
WR	110
YWt.	1100
YR	107
Feb.ADG	3.50
Feb.Scr.	39
Frame	5.5
Feet	Good

DAM											
Age	8	Calv.Ease	BW	WW	YW	Milk	HPG	Stay	Maint.En.		
Wt	1180	EPDs	15	-1.8	63	106	23	10	18	3.0	
Prog. BW	79	Marb	+.37		REA	+.07		Bfat	+.03		
WR	107	Beef Tenderness	→		DNA:	'Very Good'		Scan:	Tender		
YR	102	Wean Pct.	50%	Cow Eff.	104	HB	78	GM	35	ProS	113
Udder	Very Good										

★★★★★ for Growth, Marbling, Calving Ease.

46 BECKTON CARDINAL H147 L3
1-A 100% # 4377399 Tat: BKT0 H147 

Birth: 3-10-20

Beckton Cardinal B074 N
TR Double Eagle ZT220
BKT Pine Marie Z250 N

BECKTON CARDINAL D010 W2
Ref. C
Beckton Firefly B052 W
Beckton Warrior Z936 N6
Beckton Firefly Z663 N

Beckton Likable Z057 L4
Beckton Likable X445 J3
Beckton Minola X107 L

BECKTON INDIGO C269 L
Beckton Indigo W772 N
Beckton Nebula T398 V3
Beckton Indigo T613 JT

BWt	68
WR	92
YWt.	1036
YR	101
Feb.ADG	3.94
Feb.Scr.	36
Frame	5.5
Feet	Good

DAM											
Age	5	Calv.Ease	BW	WW	YW	Milk	HPG	Stay	Maint.En.		
Wt	1000	EPDs	17	-6.1	49	89	27	13	20	-3.0	
Prog. BW	64	Marb	+.48		REA	-.01		Bfat	+.03		
WR	103	Beef Tenderness	→		DNA:	'Outstanding'		Scan:	Tender		
YR	103	Wean Pct.	49%	Cow Eff.	103	HB	101	GM	59	ProS	160
Udder	Fair										

★★★★★ for Low Maintenance, Gainability, Marbling, Superior Cow, Calving Ease.

49 BECKTON LIKABLE H189 A4
1-A 100% # 4377353 Tat: BKT0 H189 

Birth: 3-16-20

Beckton Likable U130 L2
Beckton Likable S633
Beckton Kit S478 LN

BECKTON LIKABLE D432 N3
Ref. L-3
Beckton Firefly W013 N
Beckton Nebula T054 H3
Beckton Firefly T003 JC

Beckton Accent Y260 L3
Beckton Accent W180 C2
Beckton Lana W463 L

BECKTON SUFFEINA A190 A
Beckton Suffeina Y242 N
Beckton Nebula P P707
BKT Suffeina T110 EM

BWt	65
WR	111
YWt.	1069
YR	104
Feb.ADG	3.32
Feb.Scr.	37
Frame	5.5
Feet	Good

DAM											
Age	7	Calv.Ease	BW	WW	YW	Milk	HPG	Stay	Maint.En.		
Wt	1220	EPDs	15	-3.6	57	90	26	11	21	0.0	
Prog. BW	78	Marb	+.44		REA	+.01		Bfat	+.04		
WR	113	Beef Tenderness	→		DNA:	'Outstanding'		Scan:	Tender		
YR	111	Wean Pct.	49%	Cow Eff.	102	HB	103	GM	31	ProS	134
Udder	Very Good										

★★★★★ for Low Maintenance, Marbling, Superior Cow, Calving Ease.

47 BECKTON ACCENT H677 E4
1-A 100% # 4377775 Tat: BSF0 H677 

Birth: 4-21-20

Beckton Accent W180 C2
Beckton Cody K1 P014
Beckton Christy R046 CQ

BECKTON ACCENT E172 L3
Ref. A-5
Beckton Indigo Y406 L
Beckton Likable U130 L2
Beckton Indigo R745 WR

Beckton Epic B376 N6
Beckton Epic U749 D5
Beckton Tamara U185 NB

BECKTON MINOLA D511 E
Beckton Minola A534 L
Beckton Likable Y124 L3
Beckton Minola Y592 N

BWt	78
WR	107
YWt.	1151
YR	112
Feb.ADG	3.81
Feb.Scr.	37
Frame	6.0
Feet	Good

DAM											
Age	4	Calv.Ease	BW	WW	YW	Milk	HPG	Stay	Maint.En.		
Wt	1130	EPDs	15	-3.2	58	98	27	11	18	3.0	
Prog. BW	65	Marb	+.34		REA	+.11		Bfat	+.03		
WR	110	Beef Tenderness	→		DNA:	'Very Good'		Scan:	Tender		
YR	112	Wean Pct.	49%	Cow Eff.	103	HB	84	GM	39	ProS	123
Udder	Very Good										

★★★★★ for Growth, Gainability, Marbling, Superior Cow, Calving Ease.

50 BECKTON LIKABLE H527 N6
1-A 100% # 4376963 Tat: BKT0 H527 

Birth: 4-5-20

Beckton Likable Z057 L4
Beckton Likable X445 J3
Beckton Minola X107 L

BECKTON LIKABLE B032 C5
Ref. L-2
Beckton Mona Z270 C
Beckton Clifftop W577 E3
Beckton Mona U584 CD

Beckton New Era Y194
Beckton Minerva W901 J

BECKTON COCA D081 N
Beckton Warrior W534 N4
Beckton Coca T419 NB

BWt	67
WR	119
YWt.	1172
YR	114
Feb.ADG	3.72
Feb.Scr.	34
Frame	5.5
Feet	Good

DAM											
Age	4	Calv.Ease	BW	WW	YW	Milk	HPG	Stay	Maint.En.		
Wt	905	EPDs	17	-5.5	59	107	25	15	16	0.0	
Prog. BW	57	Marb	+.46		REA	-.06		Bfat	+.03		
WR	109	Beef Tenderness	→		DNA:	'Outstanding'		Scan:	Tender		
YR	104	Wean Pct.	68%	Cow Eff.	143	HB	74	GM	62	ProS	136
Udder	Very Good										

★★★★★ for Low Maintenance, Growth, Gainability, Marbling, Superior Cow, High Cow Efficiency, Calving Ease.

• Bulls •

51 BECKTON ACCENT H355 N4
1-A 100% # 4377157 Tat: BKT0 H355



Birth: 3-25-20

Beckton Accent W180 C2
Beckton Christy R046 CQ
Beckton Nebula T398 V3
Beckton Minerva M369 LO
Beckton Nebula U206 V3
Beckton Minerva J615 VG
Beckton Epic K4 N795
Beckton Christy L654 JL

BECKTON ACCENT B549 N3
Ref. A-2

BECKTON CHRISTY Y413 N

DAM	
Age	9
Wt	1105
Prog. BW	64
WR	105
YR	104
Udder	Good

Calv.Ease	BW	WW	YW	Milk	HPG	Stay	Maint.En.	
EPDs	14	-3.0	61	104	24	11	20	2.0
Marb	+0.35		REA +0.13		Bfat +0.03			
Beef Tenderness	→		DNA: 'Outstanding'		Scan: Tender			
Wean Pct.	51%	Cow Eff.	108	HB	94	GM	38	ProS 132

BWt 74
WR 106
YWt. 1092
YR 107
Feb.ADG 3.54
Feb.Scr. 37
Frame 5.5
Feet Good



Lot 54

★★★★★ for Growth, Gainability, Marbling, Rib-eye area, Superior Cow, Calving Ease.

52 BECKTON LIKABLE H508 J6
1-A 100% # 4377917 Tat: BSF0 H508



Birth: 4-3-20

Beckton Likable Z057 L4
Beckton Minola X107 L
Beckton Cliffot W577 E3
Beckton Mona U584 CD
Beckton Roman J S158
Beckton Sierra K557 LO
Beckton Nebula T398 V3
Beckton Barmaid S758 DM

BECKTON LIKABLE B032 C5
Ref. L-2

BECKTON BARMAID A123 O

DAM	
Age	7
Wt	1350
Prog. BW	66
WR	111
YR	106
Udder	Very Good

Calv.Ease	BW	WW	YW	Milk	HPG	Stay	Maint.En.	
EPDs	15	-3.6	54	97	27	11	20	10.0
Marb	+0.39		REA +0.01		Bfat +0.03			
Beef Tenderness	→		DNA: 'Outstanding'		Scan: Tender			
Wean Pct.	47%	Cow Eff.	100	HB	77	GM	48	ProS 125

BWt 78
WR 120
YWt. 1068
YR 104
Feb.ADG 2.74
Feb.Scr. 34
Frame 5.5
Feet Good

★★★★★ for Marbling, Superior Cow, Calving Ease.

54 BECKTON CARDINAL H180 N2
1-A 100% # 4377361 Tat: BKT0 H180



Birth: 3-14-20

TR Double Eagle ZT220
TR Ricardo DOS
Beckton Lana U182 JC
Beckton Legend U331 E2
Beckton Larkaba T418 WA
Beckton Nebula M045
Beckton Larkeisa M138 JC
Beckton Nebula P P707
BKT Pine Marie P475 LN

BECKTON CARDINAL E673 L
Ref. C-1

BKT PINE MARIE Z250 N

DAM	
Age	8
Wt	1060
Prog. BW	63
WR	105
YR	104
Udder	Very Good

Calv.Ease	BW	WW	YW	Milk	HPG	Stay	Maint.En.	
EPDs	21	-7.4	57	95	26	13	19	-1.0
Marb	+0.52		REA +0.11		Bfat +0.04			
Beef Tenderness	→		DNA: 'Very Good'		Scan: Tender			
Wean Pct.	56%	Cow Eff.	117	HB	104	GM	45	ProS 149

BWt 63
WR 111
YWt. 1076
YR 105
Feb.ADG 3.45
Feb.Scr. 32
Frame 5.0
Feet Good

★★★★★ for Low Maintenance, Growth, Marbling, Superior Cow, High Cow Efficiency, Calving Ease.

53 BECKTON RANGER H377 J6
1-A 100% # 4378029 Tat: BSF0 H377



Birth: 3-26-20

Beckton Ranger Z225 J4
Beckton T603 H3
Beckton Mona U564 JT
Beckton Dominor W640 C5
Beckton Suffeina W471 W
Beckton Julian GJ P535
Beckton Minola P826 DM
Beckton Lancer F442 T
Beckton Marta C314 JL

BECKTON RANGER B006 D5
Ref. R-1

BECKTON MARTA W883 J

DAM	
Age	11
Wt	1270
Prog. BW	72
WR	105
YR	101
Udder	Fair

Calv.Ease	BW	WW	YW	Milk	HPG	Stay	Maint.En.	
EPDs	15	-2.3	57	94	26	13	10	0.0
Marb	+0.42		REA -.13		Bfat +0.03			
Beef Tenderness	→		DNA: 'Outstanding'		Scan: Tender			
Wean Pct.	44%	Cow Eff.	94	HB	45	GM	46	ProS 91

BWt 74
WR 110
YWt. 1103
YR 108
Feb.ADG 3.32
Feb.Scr. 33
Frame 5.5
Feet Good

★★★★★ for Low Maintenance, Growth, Marbling, Calving Ease.



Lot 53

• Bulls •

55 BECKTON ORACLE H227 E2 1-A 100% # 4377317 Tat: BKT0 H227 

Birth: 3-18-20

Schuler Sudden Impact 0004X Red Crowfoot Ole's Oscar
SOR Duchess TS 8915U

SCHULER ORACLE-7142E
Ref. O-3 Sor Marlee Cmmtmnt 0470X SOR Marlee Beef 4511P

Beckton Emcee S466 Beckton Epic K4 N795
Beckton Larkaba H798 WR

BECKTON ROSE W346 E
Beckton Rose L083 LN Beckton Lancer T4 J536
Beckton Rose J152 LN

BWt	61
WR	110
YWt.	1084
YR	106
Feb.ADG	3.45
Feb.Scr.	35
Frame	5.5
Feet	Good

DAM	
Age	11
Wt	1045
Prog. BW	66
WR	97
YR	97
Udder	Good

Calv.Ease	BW	WW	YW	Milk	HPG	Stay	Maint.En.		
EPDs	19	-5.7	56	89	27	10	18	3.0	
Marb	+.69		REA +.09		Bfat +.03				
Beef Tenderness	→		DNA: 'Outstanding'		Scan: Tender				
Wean Pct.	54%	Cow Eff.	114	HB	95	GM	63	ProS	158

★★★★★ for Growth, Marbling, Calving Ease.

57 BECKTON JULIAN H258 N9 1-A 100% # 4377275 Tat: BKT0 H258 

Birth: 3-20-20

Beckton Julian Z382 J7 Beckton Julian X721 E6
Beckton Larkaba X064 J

BECKTON JULIAN E423 N8
Ref. J-4 Beckton Belga B004 N Beckton Nebula Z111 N5
Beckton Belga Z031 N

Beckton Nebula X096 N4 Beckton Nebula U206 V3
Beckton Tamara U185 NB

BECKTON EOLA C230 N
Beckton Eola U562 CQ Beckton Cherokee N N479
Beckton Eola R030 JJ

BWt	66
WR	102
YWt.	1076
YR	105
Feb.ADG	3.58
Feb.Scr.	37
Frame	5.0
Feet	Good

DAM	
Age	5
Wt	1230
Prog. BW	65
WR	103
YR	100
Udder	Very Good

Calv.Ease	BW	WW	YW	Milk	HPG	Stay	Maint.En.		
EPDs	16	-5.1	57	88	29	14	18	-1.0	
Marb	+.52		REA -.22		Bfat +.03				
Beef Tenderness	→		DNA: 'Outstanding'		Scan: Tender				
Wean Pct.	44%	Cow Eff.	93	HB	97	GM	29	ProS	126

★★★★★ for Low Maintenance, Growth, Gainability, Marbling, Calving Ease.

56 BECKTON LIKABLE H317 W5 1-A 100% # 4377203 Tat: BKT0 H317 

Birth: 3-23-20

Beckton Likable Y124 L3 Beckton Likable U130 L2
BKT Pine Marie S802 LO

BECKTON LIKABLE E391 N4
Ref. L-4 Beckton Nebula T398 V3
Beckton Lana X466 N Beckton Lana T226 NB

Beckton Warrior Y108 E5 Beckton Warrior W534 N4
Beckton Susan W058 E

BECKTON MINERVA C549 W
Beckton Minerva Y385 N Beckton Nebula T398 V3
Beckton Minerva U310 LO

BWt	64
WR	114
YWt.	1041
YR	102
Feb.ADG	2.74
Feb.Scr.	33
Frame	5.5
Feet	Good

DAM	
Age	5
Wt	1025
Prog. BW	62
WR	107
YR	104
Udder	Very Good

Calv.Ease	BW	WW	YW	Milk	HPG	Stay	Maint.En.		
EPDs	17	-5.1	56	85	30	12	20	-2.0	
Marb	+.34		REA -.18		Bfat +.04				
Beef Tenderness	→		DNA: 'Very Good'		Scan: Tender				
Wean Pct.	59%	Cow Eff.	125	HB	108	GM	32	ProS	140

★★★★★ for Low Maintenance, Marbling, Superior Cow, High Cow Efficiency, Calving Ease.



Lot 57



Lot 56

58 BECKTON DOMINOR H207 N9 1-A 100% # 4378153 Tat: BSF0 H207 

Birth: 3-17-20

Beckton Dominor A378 W7 Beckton Dominor Y005 V6
Beckton Lana Y541 W

BECKTON DOMINOR D254 N8
Ref. D-2 Beckton Nebula T398 V3
Beckton Indigo T613 JT

Beckton New Era Y194 Beckton Nebula P P707
BKT Larkeisa T310 JC

BECKTON LARKABA B277 N
Beckton Larkaba U062 CB Beckton Cobalt S029
Beckton Larkaba S374 NB

BWt	65
WR	100
YWt.	1079
YR	105
Feb.ADG	3.67
Feb.Scr.	36
Frame	5.0
Feet	Good

DAM	
Age	6
Wt	1140
Prog. BW	66
WR	100
YR	108
Udder	Very Good

Calv.Ease	BW	WW	YW	Milk	HPG	Stay	Maint.En.		
EPDs	20	-6.4	49	86	26	13	20	-1.0	
Marb	+.41		REA +.01		Bfat +.04				
Beef Tenderness	→		DNA: 'Average'		Scan: Tender				
Wean Pct.	47%	Cow Eff.	98	HB	108	GM	48	ProS	156

★★★★★ for Low Maintenance, Growth, Gainability, Marbling, Calving Ease.

• Bulls •



Lot 58

60 BECKTON JULIAN H095 E8
1-A 100% # 4377463 Tat: BKT0 H095



Birth: 3-1-20

Beckton Julian D551 C6
Beckton Julian X465 J5
Beckton Tamara W550 A

BECKTON JULIAN F067 L7
Ref. J-5
Beckton Indigo D786 L
Beckton Likable Z057 L4
Beckton Indigo Y026 N

Beckton Epic B483 N6
Beckton Epic U749 D5
BKT Pine Marie X339 N

BECKTON LANA F434 E
Beckton Lana A172 A
Beckton Accent W180 C2
Beckton Lana T646 EP

DAM																				
Age	2	Calv.Ease	BW	WW	YW	Milk	HPG	Stay	Maint.En.											
Wt	770	EPDs	17	-3.8	69	123	30	12	14	4.0										
Prog. BW	57	Marb	+.42		REA		+.19		Bfat		+.05									
WR	118	Beef Tenderness	→		DNA: 'Very Good'		Scan: Tender													
YR	114	Wean Pct.	68%		Cow Eff.		142		HB		70		GM		57		ProS		127	
Udder	Very Good																			

★ ★ ★ ★ ★ for Growth, Gainability, Marbling, Rib-eye area, Superior Cow, High Cow Efficiency, Calving Ease.

59 BECKTON HERITAGE H318 J5
1-A 100% # 4377201 Tat: BKT0 H318



Birth: 3-23-20

Beckton Heritage X403 L3
Beckton Heritage T270 J2
Beckton Indigo H150 LN

BECKTON HERITAGE C477 J4
Ref. H-1
Beckton Ruth Z858 J
Beckton Julian U699 L5
Beckton Ruth U557 JT

Beckton Julian G3 P608
Beckton Julian GG B571
Bkt Suffeina A828 DM

BECKTON MINERVA W901 J
Beckton Minerva L344 CH
Beckton Champ R3 H338
Beckton Minerva E932 JL

DAM																				
Age	11	Calv.Ease	BW	WW	YW	Milk	HPG	Stay	Maint.En.											
Wt	1035	EPDs	17	-4.2	56	92	28	12	14	-9.0										
Prog. BW	66	Marb	+.45		REA		+.04		Bfat		+.02									
WR	96	Beef Tenderness	→		DNA: 'Outstanding'		Scan: Tender													
YR	100	Wean Pct.	56%		Cow Eff.		119		HB		76		GM		55		ProS		131	
Udder	Good																			

★ ★ ★ ★ ★ for Low Maintenance, Growth, Gainability, Marbling, High Cow Efficiency, Calving Ease.

61 BECKTON LIKABLE H300 L4
1-A 100% # 4377221 Tat: BKT0 H300



Birth: 3-23-20

Beckton Likable U130 L2
Beckton Likable S633
Beckton Kit S478 LN

BECKTON LIKABLE Y124 L3
Ref. L-2
BKT Pine Marie S802 LO
Beckton Lasso P741
BKT Pine Marie P475 LN

Beckton Likable Y124 L3
Beckton Likable U130 L2
BKT Pine Marie S802 LO

BECKTON LANA B316 L
Beckton Lana W748 D
Beckton Dominor Z1 R610
Beckton Lana S858 JL

DAM																				
Age	6	Calv.Ease	BW	WW	YW	Milk	HPG	Stay	Maint.En.											
Wt	1120	EPDs	23	-7.6	51	83	30	11	20	0.0										
Prog. BW	64	Marb	+.51		REA		-.15		Bfat		+.06									
WR	109	Beef Tenderness	→		DNA: 'Outstanding'		Scan: Tender													
YR	108	Wean Pct.	53%		Cow Eff.		112		HB		113		GM		46		ProS		159	
Udder	Very Good																			

★ ★ ★ ★ ★ for Low Maintenance, Growth, Gainability, Marbling, Superior Cow, Calving Ease.



Lot 59

62 BECKTON NEW ERA H198 N3
1-A 100% # 4378163 Tat: BSF0 H198



Birth: 3-16-20

Beckton New Era Y194
Beckton Nebula P P707
BKT Larkeisa T310 JC

BECKTON NEW ERA C209 J2
Ref. N-4
Beckton Minerva Y116 J
Beckton Julian W743 H5
Beckton Minerva W081 N

Beckton New Era Y194
Beckton Nebula P P707
BKT Larkeisa T310 JC

BECKTON LARKABEL A361 N
Beckton Larkabel X676 N
Beckton Nebula T269 E2
BKT Larkabel R038 WA

DAM																				
Age	7	Calv.Ease	BW	WW	YW	Milk	HPG	Stay	Maint.En.											
Wt	1075	EPDs	13	-1.5	63	98	26	14	18	0.0										
Prog. BW	69	Marb	+.32		REA		-.08		Bfat		+.02									
WR	106	Beef Tenderness	→		DNA: 'Very Good'		Scan: Tender													
YR	98	Wean Pct.	56%		Cow Eff.		119		HB		74		GM		21		ProS		95	
Udder	Good																			

★ ★ ★ ★ ★ for Low Maintenance, Growth, Gainability, Marbling, High Cow Efficiency, Calving Ease.

• Bulls •

63 BECKTON JULIAN H324 L8 1-A 100% # 4377195 Tat: BKT0 H324 

Birth: 3-24-20

Beckton Julian X721 E6 < Beckton Julian U699 L5
Beckton Lana U329 EP

BECKTON JULIAN Z382 J7
Ref. J-2 < Beckton Larkaba X064 J < Beckton Julian U699 L5
Beckton Larkaba U475 CT

Beckton Likable Z057 L4 < Beckton Likable X445 J3
Beckton Minola X107 L

BECKTON MINERVA D567 L
Beckton Minerva A244 E < Beckton Epic Y484 N6
Beckton Minerva Y385 N

BWt	55
WR	115
YWt.	1168
YR	114
Feb.ADG	3.76
Feb.Scr.	29
Frame	5.0
Feet	Good

DAM	
Age	4
Wt	1160
Prog. BW	60
WR	109
YR	110
Udder	Very Good

Calv.Ease	BW	WW	YW	Milk	HPG	Stay	Maint.En.		
EPDs	20	-6.9	62	106	27	12	19	-3.0	
Marb	+0.41		REA +0.14		Bfat +0.04				
Beef Tenderness	→		DNA: 'Outstanding'		Scan: Tender				
Wean Pct.	51%	Cow Eff.	107	HB	106	GM	47	ProS	153

65 BECKTON LIKABLE H458 N6 1-A 100% # 4377043 Tat: BKT0 H458 

Birth: 3-30-20

Beckton Likable Z057 L4 < Beckton Likable X445 J3
Beckton Minola X107 L

BECKTON LIKABLE B032 C5
Ref. L-2 < Beckton Mona Z270 C < Beckton Clifftop W577 E3
Beckton Mona U584 CD

Beckton Nebula P P707 < Beckton Nebula M045
Beckton Lana M809 EP

BKT PINE MARIE U454 NB
BKT Pine Marie N582 WR < Beckton Warrior TD L493
BKT Pine Marie L650 EP

BWt	73
WR	108
YWt.	1102
YR	108
Feb.ADG	3.76
Feb.Scr.	38
Frame	5.5
Feet	Good

DAM	
Age	12
Wt	1200
Prog. BW	73
WR	102
YR	104
Udder	Very Good

Calv.Ease	BW	WW	YW	Milk	HPG	Stay	Maint.En.		
EPDs	15	-3.9	54	102	26	13	19	4.0	
Marb	+0.53		REA -0.01		Bfat +0.03				
Beef Tenderness	→		DNA: 'Very Good'		Scan: Tender				
Wean Pct.	46%	Cow Eff.	97	HB	86	GM	67	ProS	153

★★★★★ for Low Maintenance, Growth, Gainability, Marbling, Rib-eye area, Superior Cow, Calving Ease.

★★★★★ for Growth, Gainability, Marbling, Calving Ease.



Lot 63

66 BECKTON DOMINOR H327 A10 1-A 100% # 4377193 Tat: BKT0 H327 

Birth: 3-24-20

Beckton Dominor C052 E8 < Beckton Dominor A378 W7
Beckton Scarlett A406 E

BECKTON DOMINOR E693 D9
Ref. D-4 < Beckton Christy C149 D < Beckton Dominor A378 W7
Beckton Christy A234 N

Beckton Accent W180 C2 < Beckton Cody K1 P014
Beckton Christy R046 CQ

BECKTON LANA Z916 A
Beckton Lana N664 JL < Beckton Julian G1 J526
Beckton Lana H533 LN

BWt	65
WR	100
YWt.	1064
YR	104
Feb.ADG	3.41
Feb.Scr.	38
Frame	5.5
Feet	Good

DAM	
Age	8
Wt	1140
Prog. BW	69
WR	106
YR	102
Udder	Good

Calv.Ease	BW	WW	YW	Milk	HPG	Stay	Maint.En.		
EPDs	18	-4.0	55	90	29	11	21	-3.0	
Marb	+0.50		REA +0.03		Bfat +0.04				
Beef Tenderness	→		DNA: NA		Scan: Tender				
Wean Pct.	47%	Cow Eff.	98	HB	110	GM	40	ProS	150

★★★★★ for Low Maintenance, Marbling, Calving Ease.

64 BECKTON SCAMP H342 L6 1-A 100% # 4377177 Tat: BKT0 H342 

Birth: 3-25-20

Beckton Scamp B720 L4 < Beckton Scamp X458 H3
Beckton Larkaba Y448 L

BECKTON SCAMP E175 N5
Ref. S-1 < Beckton Nebula T398 V3
Beckton Belga T551 EP

Beckton Likable Y124 L3 < Beckton Likable U130 L2
BKT Pine Marie S802 LO

BECKTON SUSAN D621 L
Beckton Susan A839 L < Beckton Likable U120 L2
Beckton Susan N023 JE

BWt	60
WR	104
YWt.	1095
YR	107
Feb.ADG	3.50
Feb.Scr.	36
Frame	5.5
Feet	Good

DAM	
Age	4
Wt	915
Prog. BW	50
WR	100
YR	100
Udder	Good

Calv.Ease	BW	WW	YW	Milk	HPG	Stay	Maint.En.		
EPDs	22	-7.3	52	96	27	10	19	-4.0	
Marb	+0.39		REA +0.16		Bfat +0.03				
Beef Tenderness	→		DNA: 'Outstanding'		Scan: Tender				
Wean Pct.	59%	Cow Eff.	123	HB	105	GM	61	ProS	166

★★★★★ for Low Maintenance, Growth, Marbling, Rib-eye area, High Cow Efficiency, Calving Ease.



Lot 66

• Bulls •

67 BECKTON LIKABLE H381 N5 1-A 100% # 4377123 Tat: BKT0 H381 

Birth: 3-27-20

Beckton Likable Y124 L3
BECKTON LIKABLE E391 N4 Ref. L-4
 Beckton Lana X466 N

Beckton U130 L2
 BKT Pine Marie S802 LO
 Beckton Nebula T398 V3
 Beckton Lana T226 NB
 Beckton Nebula P P707
 BKT Larkeisa T310 JC
 Beckton Warrior T248 L5
 BKT Suffeina T500 EP

BWt 54
 WR 102
 YWt. 1071
 YR 105
 Feb.ADG 3.45
 Feb.Scr. 32
 Frame 5.5
 Feet Good

Beckton New Era Y194
BECKTON SUFFEINA A138 N
 Beckton Suffeina W489 W

DAM		Calv.Ease	BW	WW	YW	Milk	HPG	Stay	Maint.En.	
Age	7	EPDs	17	-5.8	60	98	29	10	20	1.0
Wt	1035	Marb	+.42		REA	-.14		Bfat	+.04	
Prog. BW	64	Beef Tenderness	→		DNA: 'Outstanding'	Scan:		Tender		
WR	103	Wean Pct.	52%		Cow Eff.	110		HB	103	
YR	103							GM	45	
Udder	Very Good							ProS	148	

★★★★★ for Marbling, Superior Cow, Calving Ease.

69 BECKTON LIKABLE H498 H6 1-A 100% # 4376999 Tat: BKT0 H498 

Birth: 4-2-20

Beckton Likable Z057 L4
BECKTON LIKABLE B032 C5 Ref. L-2
 Beckton Mona Z270 C

Beckton Likable X445 J3
 Beckton Minola X107 L
 Beckton Cliffot W577 E3
 Beckton Mona U584 CD
 Beckton Hasten P292
 Beckton Lakme G128 HD
 Beckton Hasten P292
 BKT Larkeisa J800 LN

BWt 62
 WR 106
 YWt. 1089
 YR 106
 Feb.ADG 3.85
 Feb.Scr. 36
 Frame 5.5
 Feet Good

Beckton Hasten H S462
BKT LARKEISA U535 HS
 BKT Larkeisa S637 HS

DAM		Calv.Ease	BW	WW	YW	Milk	HPG	Stay	Maint.En.	
Age	12	EPDs	17	-5.5	55	97	24	11	18	1.0
Wt	1090	Marb	+.42		REA	+.03		Bfat	+.02	
Prog. BW	69	Beef Tenderness	→		DNA: 'Outstanding'	Scan:		Tender		
WR	105	Wean Pct.	50%		Cow Eff.	105		HB	86	
YR	101							GM	52	
Udder	Good							ProS	138	

★★★★★ for Growth, Gainability, Marbling, Calving Ease.

68 BECKTON ACCENT H493 A4 1-A 100% # 4377005 Tat: BKT0 H493 

Birth: 4-2-20

Beckton Accent W180 C2
BECKTON ACCENT E172 L3 Ref. A-5
 Beckton Indigo Y406 L

Beckton K1 P014
 Beckton Christy R046 CQ
 Beckton Likable U130 L2
 Beckton Indigo R745 WR
 Beckton Cody K1 P014
 Beckton Christy R046 CQ
 Beckton Dominor W640 C5
 Beckton Kit R503 LN

BWt 72
 WR 102
 YWt. 1069
 YR 104
 Feb.ADG 3.72
 Feb.Scr. 37
 Frame 5.5
 Feet Good

Beckton Accent W180 C2
BECKTON KIT C839 A
 Beckton Kit Z181 D

DAM		Calv.Ease	BW	WW	YW	Milk	HPG	Stay	Maint.En.	
Age	5	EPDs	17	-4.3	55	87	25	12	21	-4.0
Wt	1035	Marb	+.33		REA	+.07		Bfat	+.03	
Prog. BW	62	Beef Tenderness	→		DNA: 'Outstanding'	Scan:		Tender		
WR	101	Wean Pct.	52%		Cow Eff.	110		HB	113	
YR	101							GM	32	
Udder	Very Good							ProS	145	

★★★★★ for Low Maintenance, Gainability, Marbling, Calving Ease.



Lot 69



Lot 68

70 BECKTON SCAMP H079 A6 1-A 100% # 4377485 Tat: BKT0 H079 

Birth: 2-27-20

Beckton Scamp B720 L4
BECKTON SCAMP E175 N5 Ref. S-1
 Beckton Belga W103 N

Beckton Scamp X458 H3
 Beckton Larkaba Y448 L
 Beckton Nebula T398 V3
 Beckton Belga T551 EP
 Beckton Accent W180 C2
 Beckton Minerva Y654 N
 Beckton Epic X330 L6
 Beckton Lana Y032 W

BWt 62
 WR 97
 YWt. 1084
 YR 107
 Feb.ADG 4.03
 Feb.Scr. 36
 Frame 5.5
 Feet Good

Beckton Accent B549 N3
BECKTON LANA F498 A
 Beckton Lana C856 E

DAM		Calv.Ease	BW	WW	YW	Milk	HPG	Stay	Maint.En.	
Age	2	EPDs	18	-4.8	57	108	23	10	15	0.0
Wt	810	Marb	+.42		REA	+.02		Bfat	+.03	
Prog. BW	62	Beef Tenderness	→		DNA: 'Outstanding'	Scan:		Tender		
WR	97	Wean Pct.	52%		Cow Eff.	109		HB	74	
YR	107							GM	58	
Udder	Very Good							ProS	132	

★★★★★ for Low Maintenance, Growth, Gainability, Marbling, Calving Ease.

• Bulls •

71 BECKTON ORACLE H279 A1 1-A 100% # 4377245 Tat: BKT0 H279 

Birth: 3-22-20
 Schuler Sudden Impact 0004X Red Crowfoot Ole's Oscar
SCHULER ORACLE-7142E SOR Duchess TS 8915U
 Ref. O-3 Sor Marlee Cmmtmnt 0470X SOR Marlee Beef 4511P
 Beckton Accent U777 C2 Beckton Cody K1 P014
BECKTON PINE MARIE A513 A Beckton Susan R022 CQ
 BKT Pine Marie X424 H Beckton Hasten U108 J3
 BKT Pine Marie U481 NM

DAM		Calv.Ease	BW	WW	YW	Milk	HPG	Stay	Maint.En.	
Age	7	EPDs	20	-5.8	57	95	23	12	17	0.0
Wt	1065	Marb	+.56		REA	+.21		Bfat	+.02	
Prog. BW	70	Beef Tenderness	→		DNA: 'Outstanding'	Scan: Tender				
WR	99	Wean Pct.	51%		Cow Eff.	107		HB	96	
YR	100							GM	52	
Udder	Very Good							ProS	148	

★★★★★ for Low Maintenance, Marbling, Rib-eye area, Calving Ease.

74 BSF ACCENT H274 N4 1-B 99% # 4378105 Tat: BSF0 H274 

Birth: 3-21-20
 Beckton Accent W180 C2 Beckton Cody K1 P014
BECKTON ACCENT B549 N3 Beckton Christy R046 CQ
 Ref. A-2 Beckton Minerva Y654 N Beckton Nebula T398 V3
 Beckton Minerva M369 LO
 Beckton Nebula B557 J3 Beckton Nebula P P707
BSF ERICA D089 N Beckton Larkaba T813 JC
 BSF Erica B207 L Beckton Legend S670
 BSF Erica W053 R

DAM		Calv.Ease	BW	WW	YW	Milk	HPG	Stay	Maint.En.	
Age	4	EPDs	18	-6.3	58	103	25	12	20	-1.0
Wt	840	Marb	+.39		REA	+.15		Bfat	+.03	
Prog. BW	56	Beef Tenderness	→		DNA: 'Very Good'	Scan: Tender				
WR	101	Wean Pct.	63%		Cow Eff.	132		HB	106	
YR	105							GM	52	
Udder	Very Good							ProS	158	

★★★★★ for Low Maintenance, Growth, Gainability, Marbling, Rib-eye area, High Cow Efficiency, Calving Ease.

72 BECKTON RANGER H598 J6 1-A 100% # 4376887 Tat: BKT0 H598 

Birth: 4-11-20
 Beckton Ranger Z225 J4 Beckton Ranger T603 H3
BECKTON RANGER B006 D5 Beckton Mona U564 JT
 Ref. R-1 Beckton Dominor W640 C5
 Beckton Suffeina Z731 D Beckton Suffeina W471 W
 Beckton Julian G5 S107 Beckton Julian GJ P535
BECKTON LARKABA W868 J Beckton Minola P826 DM
 Beckton Larkaba S663 JE Beckton Jules L429
 Beckton Larkaba K530 EP

DAM		Calv.Ease	BW	WW	YW	Milk	HPG	Stay	Maint.En.	
Age	11	EPDs	15	-3.1	61	103	26	13	10	-2.0
Wt	1145	Marb	+.44		REA	+.04		Bfat	+.04	
Prog. BW	69	Beef Tenderness	→		DNA: 'Very Good'	Scan: Tender				
WR	104	Wean Pct.	50%		Cow Eff.	105		HB	49	
YR	101							GM	44	
Udder	Very Good							ProS	93	

★★★★★ for Low Maintenance, Growth, Marbling, Calving Ease.

75 BSF LIKABLE H013 R5 1-B 99% # 4378293 Tat: BSF0 H013 

Birth: 2-16-20
 Beckton Likable Y124 L3 Beckton Likable U130 L2
BECKTON LIKABLE F242 D4 BKT Pine Marie S802 LO
 Ref. L-6 Beckton Dominor W640 C5
 Beckton Firefly A022 D Beckton Firefly U801 NB
 Beckton Roosevelt D305 C2 Bieber Roosevelt W384
BSF JULIANNE F120 R Beckton Lana W277 A
 BSF Julianne D131 L Beckton Likable B154 W4
 BSF Julianne B007 M8

DAM		Calv.Ease	BW	WW	YW	Milk	HPG	Stay	Maint.En.	
Age	2	EPDs	22	-6.9	51	79	27	11	17	0.0
Wt	840	Marb	+.29		REA	-.06		Bfat	+.03	
Prog. BW	54	Beef Tenderness	→		DNA: 'Outstanding'	Scan: Tender				
WR	104	Wean Pct.	54%		Cow Eff.	114		HB	96	
YR	101							GM	21	
Udder	Good							ProS	117	

★★★★★ for Low Maintenance, Gainability, Marbling, Calving Ease.

73 BECKTON LIKABLE H016 S5 1-A 100% # 4377559 Tat: BKT0 H016 

Birth: 2-17-20
 Beckton Likable Y124 L3 Beckton Likable U130 L2
BECKTON LIKABLE F242 D4 BKT Pine Marie S802 LO
 Ref. L-6 Beckton Dominor W640 C5
 Beckton Firefly A022 D Beckton Firefly U801 NB
 Beckton Scamp C349 C4 Beckton Scamp X458 H3
BECKTON COCA F285 S Beckton Lydia W178 C
 Beckton Coca X084 N Beckton Nebula U206 V3
 Beckton Coca U510 LN

DAM		Calv.Ease	BW	WW	YW	Milk	HPG	Stay	Maint.En.	
Age	2	EPDs	20	-5.4	49	80	27	10	16	0.0
Wt	900	Marb	+.30		REA	-.03		Bfat	+.03	
Prog. BW	54	Beef Tenderness	→		DNA: 'Outstanding'	Scan: Tender				
WR	96	Wean Pct.	46%		Cow Eff.	97		HB	84	
YR	97							GM	28	
Udder	Very Good							ProS	112	

★★★★★ for Low Maintenance, Marbling, Calving Ease.

76 BSF LIKABLE H286 N5 1-B 99% # 4378099 Tat: BSF0 H286 

Birth: 3-22-20
 Beckton Likable Y124 L3 Beckton Likable U130 L2
BECKTON LIKABLE E391 N4 BKT Pine Marie S802 LO
 Ref. L-4 Beckton Nebula T398 V3
 Beckton Lana X466 N Beckton Lana T226 NB
 Beckton Nebula W778 J4 Beckton Nebula PJ S543
BSF JUSTICIA A684 N Beckton Lana S197 JT
 BSF Justicia U855 JC Beckton Justice C1 R483
 BSF Regus M638 WR

DAM		Calv.Ease	BW	WW	YW	Milk	HPG	Stay	Maint.En.	
Age	7	EPDs	17	-5.2	55	83	27	13	20	4.0
Wt	1175	Marb	+.44		REA	-.17		Bfat	+.04	
Prog. BW	64	Beef Tenderness	→		DNA: 'Very Good'	Scan: Tender				
WR	107	Wean Pct.	48%		Cow Eff.	100		HB	101	
YR	104							GM	33	
Udder	Very Good							ProS	134	

★★★★★ for Marbling, Superior Cow, Calving Ease.

• Bulls •

77 BSF ORACLE H446 N2 

1-B 99% # 4377971 Tat: BSF0 H446
 Birth: 3-30-20
 Schuler Sudden Impact 0004X Red Crowfoot Ole's Oscar
SCHULER ORACLE-7142E SOR Duchess TS 8915U
 Ref. O-3 Sor Marlee Cmmtmnt 0470X Brown Commitment S7206
 SOR Marlee Beef 4511P
 Beckton New Era A409 N2 Beckton New Era Y194
BSF HUSTLE C852 N Beckton Eola W796 N
 BSF Hustle P748 Beckton Hustler CN J102
 WF Regus H107

BWt	69
WR	114
YWt.	1063
YR	104
Feb.ADG	3.25
Feb.Scr.	37
Frame	5.5
Feet	Good

DAM											
Age	5	Calv.Ease	BW	WW	YW	Milk	HPG	Stay	Maint.En.		
Wt	1210	EPDs	17	-4.1	60	99	26	11	17	5.0	
Prog. BW	70	Marb	+.51		REA	+.18		Bfat	+.01		
WR	110	Beef Tenderness	→		DNA:	'Outstanding'		Scan:	Tender		
YR	106	Wean Pct.	50%	Cow Eff.	106	HB	87	GM	54	ProS	141
Udder	Good										

★★★★★ for Marbling, Rib-eye area, Superior Cow, Calving Ease.

80 BECKTON ACCENT H065 N4 

1-A 100% # 4378259 Tat: BSF0 H065
 Birth: 2-25-20
 Beckton Accent W180 C2 Beckton Cody K1 P014
BECKTON ACCENT F602 L3 Beckton Christy R046 CQ
 Ref. A Beckton Lana B670 L Beckton Likable U130 L2
 Beckton Lana Y541 W
 Beckton New Era D478 C2 Beckton New Era Y194
BECKTON CHRISTY F123 N Beckton Coca X734 C
 Beckton Christy D459 W Beckton Warrior Y108 E5
 Beckton Christy Z958 E

BWt	67
WR	95
YWt.	1072
YR	106
Feb.ADG	4.04
Feb.Scr.	34
Frame	5.5
Feet	Good

DAM											
Age	2	Calv.Ease	BW	WW	YW	Milk	HPG	Stay	Maint.En.		
Wt	780	EPDs	16	-4.4	54	94	25	12	18	-3.0	
Prog. BW	67	Marb	+.43		REA	+.07		Bfat	+.04		
WR	95	Beef Tenderness	→		DNA:	'Poor'		Scan:	Tender		
YR	106	Wean Pct.	52%	Cow Eff.	110	HB	85	GM	47	ProS	132
Udder	Very Good										

★★★★★ for Low Maintenance, Growth, Gainability, Marbling, Calving Ease.

78 BECKTON HUGHES H501 A3 

1-A 100% # 4376995 Tat: BKT0 H501
 Birth: 4-2-20
 Bieber H Hughes W109 Basin Hobo 0545
BECKTON HUGHES C463 N2 Basin Rose 06T0
 Ref. B-1 Beckton Nexus L016
 Beckton Lakme T689 NX Beckton Lakme M669 EP
 Beckton Accent Z506 J3 Beckton Accent W180 C2
BECKTON ANGEL B070 A Beckton Susan P857 JO
 Beckton Angel Z818 N Beckton Nebula U206 V3
 Beckton Angel T652 NB

BWt	68
WR	101
YWt.	1199
YR	100
Feb.ADG	2.98
Feb.Scr.	36
Frame	5.5
Feet	Good

DAM											
Age	6	Calv.Ease	BW	WW	YW	Milk	HPG	Stay	Maint.En.		
Wt	1200	EPDs	15	-3.6	59	91	24	13	21	2.0	
Prog. BW	60	Marb	+.44		REA	-.02		Bfat	+.04		
WR	95	Beef Tenderness	→		DNA:	'Outstanding'		Scan:	Tender		
YR	99	Wean Pct.	37%	Cow Eff.	78	HB	113	GM	25	ProS	138
Udder	Good										

★★★★★ for Marbling, Calving Ease.

81 BSF ACCENT H709 L4 

1-B 99% # 4377751 Tat: BSF0 H709
 Birth: 4-26-20
 Beckton Accent W180 C2 Beckton Cody K1 P014
BECKTON ACCENT B549 N3 Beckton Christy R046 CQ
 Ref. A-2 Beckton Nebula T398 V3
 Beckton Minerva Y654 N Beckton Minerva M369 LO
 Beckton Lancer F442 T
 Beckton Legend S670 Beckton Kit F468 JL
BSF NEPTALA C607 L Beckton Juniper P381
 BSF Neptala S006 JP BSF Neptala P236

BWt	83
WR	115
YWt.	1147
YR	112
Feb.ADG	3.60
Feb.Scr.	40
Frame	5.5
Feet	Good

DAM											
Age	5	Calv.Ease	BW	WW	YW	Milk	HPG	Stay	Maint.En.		
Wt	1130	EPDs	13	-1.1	66	108	24	12	21	1.0	
Prog. BW	86	Marb	+.39		REA	+.09		Bfat	+.03		
WR	109	Beef Tenderness	→		DNA:	'Outstanding'		Scan:	Tender		
YR	109	Wean Pct.	54%	Cow Eff.	114	HB	102	GM	43	ProS	145
Udder	Very Good										

★★★★★ for Growth, Gainability, Marbling, Superior Cow, Calving Ease.

79 BSF HERITAGE H210 N5 

1-B 99% # 4378151 Tat: BSF0 H210
 Birth: 3-17-20
 Beckton Heritage X403 L3 Beckton Heritage T270 J2
BECKTON HERITAGE C477 J4 Beckton Indigo H150 LN
 Ref. H-1 Beckton Julian U699 L5
 Beckton Ruth Z858 J Beckton Ruth U557 JT
 Beckton Nebula W778 J4
BSF DOMINIQUE A092 N BKT Pine Marie W102 C
 Beckton Nebula Y002 C5 Beckton Accent W180 C2
 BSF Dominique Y109 A BSF Dominique W352 J

BWt	71
WR	105
YWt.	1023
YR	100
Feb.ADG	3.29
Feb.Scr.	35
Frame	5.0
Feet	Good

DAM											
Age	7	Calv.Ease	BW	WW	YW	Milk	HPG	Stay	Maint.En.		
Wt	1130	EPDs	17	-3.8	61	96	24	11	19	0.0	
Prog. BW	66	Marb	+.50		REA	+.03		Bfat	+.05		
WR	95	Beef Tenderness	→		DNA:	'Outstanding'		Scan:	Tender		
YR	98	Wean Pct.	49%	Cow Eff.	104	HB	96	GM	47	ProS	143
Udder	Very Good										

★★★★★ for Low Maintenance, Marbling, Calving Ease.

82 BSF ACCENT H741 N3 

1-B 99% # 4377731 Tat: BSF0 H741
 Birth: 5-2-20
 Beckton Accent U777 C2 Beckton Cody K1 P014
BECKTON ACCENT B553 L2 Beckton Susan R022 CQ
 Ref. A-3 Beckton Lana X839 L Beckton Legend S670
 Beckton Lana S371 DM
 Beckton New Era Y194 Beckton Nebula P P707
BSF LANETTE D395 N BKT Larkeisa T310 JC
 Beckton Janus X799 L2
 BSF Lanette A272 O BSF Lanette W106 N

BWt	75
WR	111
YWt.	1159
YR	113
Feb.ADG	3.73
Feb.Scr.	33
Frame	6.0
Feet	Good

DAM											
Age	4	Calv.Ease	BW	WW	YW	Milk	HPG	Stay	Maint.En.		
Wt	995	EPDs	15	-2.4	61	105	28	13	16	0.0	
Prog. BW	66	Marb	+.33		REA	+.02		Bfat	+.03		
WR	116	Beef Tenderness	→		DNA:	'Outstanding'		Scan:	Tender		
YR	111	Wean Pct.	57%	Cow Eff.	121	HB	72	GM	47	ProS	119
Udder	-										

★★★★★ for Low Maintenance, Growth, Gainability, Marbling, Superior Cow, High Cow Efficiency, Calving Ease.

• Bulls •

83 BECKTON GENETICS H625 1-B 99% # 4376851 Tat: BKT0 H625 

Birth: 4-13-20

BECKTON GENETICS MULTI SIRE
Ref.

BECKTON LARKABA D449 A
Beckton Accent U777 C2
Beckton Larkaba U475 CT

Beckton Cody K1 P014
Beckton Susan R022 CQ
BKT Clifftop TP R288
Beckton Larkaba R809 NB

BWt	48
WR	101
YWt.	1013
YR	99
Feb.ADG	3.03
Feb.Scr.	37
Frame	6.0
Feet	Good

DAM											
Age	4	Calv.Ease	BW	WW	YW	Milk	HPG	Stay	Maint.En.		
Wt	905	EPDs	22	-8.9	35	56	25	7	11	-5.0	
Prog. BW	51	Marb	+.57		REA	-.01		Bfat	+.05		
WR	102	Beef Tenderness	→		DNA: 'Outstanding'			Scan:	Tender		
YR	100	Wean Pct.	58%	Cow Eff.	121	HB	40	GM	69	ProS	109
Udder	Very Good										

★★★★★ for Low Maintenance, Marbling, High Cow Efficiency, Calving Ease.

86 BECKTON DOMINOR H349 L9 1-A 100% # 4377165 Tat: BKT0 H349 

Birth: 3-25-20

BECKTON DOMINOR D254 N8
Ref. D-2

BECKTON SIERRA C324 L
Mushrush Lunesta A007
Beckton Sierra A245 L

Beckton Dominor A378 W7
Beckton Lana Y541 W
Beckton Nebula T398 V3
Beckton Indigo W772 N
Mushrush Lunesta MD Y097
Mushrush Candice JL X212
Beckton Likable Y124 L3
Beckton Sierra Y188 N

BWt	59
WR	92
YWt.	1030
YR	101
Feb.ADG	3.58
Feb.Scr.	37
Frame	5.5
Feet	Good

DAM											
Age	5	Calv.Ease	BW	WW	YW	Milk	HPG	Stay	Maint.En.		
Wt	1025	EPDs	19	-6.6	45	78	32	11	20	1.0	
Prog. BW	59	Marb	+.46		REA	+.08		Bfat	+.04		
WR	101	Beef Tenderness	→		DNA: 'Very Good'			Scan:	Tender		
YR	103	Wean Pct.	48%	Cow Eff.	101	HB	102	GM	46	ProS	148
Udder	Very Good										

★★★★★ for Gainability, Marbling, Calving Ease.

84 BECKTON HERITAGE H456 S5 1-A 100% # 4377959 Tat: BSF0 H456 

Birth: 3-30-20

BECKTON HERITAGE C477 J4
Ref. H-1

BECKTON LANA C003 S
Beckton Scamp A627 J4
Beckton Lana A574 N

Beckton Heritage X403 L3
Beckton Ruth Z858 J
Beckton Heritage T270 J2
Beckton Indigo H150 LN
Beckton Julian U699 L5
Beckton Ruth U557 JT
Beckton Scamp X494 E3
Beckton Serena R023 JC
Beckton Nebula W486 D3
Beckton Lana X391 E

BWt	88
WR	102
YWt.	1100
YR	107
Feb.ADG	3.67
Feb.Scr.	36
Frame	5.0
Feet	Good

DAM											
Age	5	Calv.Ease	BW	WW	YW	Milk	HPG	Stay	Maint.En.		
Wt	965	EPDs	13	-1.1	59	99	28	11	14	-6.0	
Prog. BW	73	Marb	+.39		REA	+.08		Bfat	+.03		
WR	106	Beef Tenderness	→		DNA: 'Outstanding'			Scan:	Tender		
YR	108	Wean Pct.	56%	Cow Eff.	118	HB	73	GM	43	ProS	116
Udder	Very Good										

★★★★★ for Low Maintenance, Growth, Gainability, Marbling, Superior Cow, High Cow Efficiency, Calving Ease.

87 BECKTON RANGER H524 H6 1-A 100% # 4376967 Tat: BKT0 H524 

Birth: 4-5-20

BECKTON RANGER B006 D5
Ref. R-1

BECKTON MINOLA E101 H
Beckton Hughes C463 N2
Beckton Minola C770 J

Beckton Ranger Z225 J4
Beckton Suffeina Z731 D
Beckton Ranger T603 H3
Beckton Mona U564 JT
Beckton Dominor W640 C5
Beckton Suffeina W471 W
Bieber H Hughes W109
Beckton Lakme T689 NX
Beckton Julian X465 J5
Beckton Minola Y306 N

BWt	78
WR	114
YWt.	1099
YR	111
Feb.ADG	3.67
Feb.Scr.	35
Frame	5.5
Feet	Good

DAM											
Age	3	Calv.Ease	BW	WW	YW	Milk	HPG	Stay	Maint.En.		
Wt	935	EPDs	13	-0.6	66	109	24	12	13	0.0	
Prog. BW	71	Marb	+.49		REA	+.04		Bfat	+.04		
WR	106	Beef Tenderness	→		DNA: 'Outstanding'			Scan:	Tender		
YR	105	Wean Pct.	56%	Cow Eff.	119	HB	69	GM	48	ProS	117
Udder	Very Good										

★★★★★ for Low Maintenance, Growth, Gainability, Marbling, Superior Cow, High Cow Efficiency, Calving Ease.

85 BECKTON LIKABLE H041 L7 1-A 100% # 4377527 Tat: BKT0 H041 

Birth: 2-21-20

BECKTON LIKABLE F237 E6
Ref. L-5

BECKTON BELGA F305 L
Beckton Likable B032 C5
Beckton Eola Y412 E

Beckton Likable B032 C5
Beckton Belga Y192 N

Beckton Likable Z057 L4
Beckton Mona Z270 C
Beckton Epic U749 D5
Beckton Eola T435 NB
Beckton Likable Z057 L4
Beckton Mona Z270 C
Beckton Nebula T398 V3
Beckton Belga S026 NB

BWt	60
WR	98
YWt.	1079
YR	107
Feb.ADG	4.34
Feb.Scr.	33
Frame	5.5
Feet	Good

DAM											
Age	2	Calv.Ease	BW	WW	YW	Milk	HPG	Stay	Maint.En.		
Wt	925	EPDs	19	-5.2	58	109	24	13	20	4.0	
Prog. BW	60	Marb	+.35		REA	+.12		Bfat	+.03		
WR	98	Beef Tenderness	→		DNA: 'Outstanding'			Scan:	Tender		
YR	107	Wean Pct.	46%	Cow Eff.	96	HB	103	GM	66	ProS	169
Udder	Good										

★★★★★ for Growth, Gainability, Marbling, Calving Ease.



Lot 85

• Bulls •

88 BECKTON LIKABLE H185 N4
1-A 100% # 4377355 Tat: BKT0 H185



Birth: 3-15-20

Beckton Likable U130 L2
Beckton Kit S478 LN

BECKTON LIKABLE D432 N3
Ref. L-3

Beckton Nebula T054 H3
Beckton Firefly T003 JC

Beckton Nebula U206 V3
Beckton Minerva J615 VG

BECKTON COCA Z713 N
Beckton Coca W107 A
Beckton Action T061 D1
Beckton Coca T499 SC

BWt	62
WR	97
YWt	1024
YR	100
Feb.ADG	3.10
Feb.Scr.	31
Frame	5.0
Feet	Good

DAM	
Age	8
Wt	1105
Prog. BW	60
WR	104
YR	100
Udder	Very Good

Calv.Ease	BW	WW	YW	Milk	HPG	Stay	Maint.En.		
EPDs	19	-6.4	45	74	25	13	20	-9.0	
Marb	+.30		REA +.06		Bfat +.02				
Beef Tenderness	→		DNA: 'Very Good'		Scan: Tender				
Wean Pct.	47%	Cow Eff.	99	HB	115	GM	28	ProS	143

★★★★★ for Low Maintenance, Marbling, Calving Ease.

90 BECKTON DOMINOR H141 E10
1-A 100% # 4377409 Tat: BKT0 H141



Birth: 3-10-20

Beckton Dominor D254 N8
Beckton Indigo W772 N

BECKTON DOMINOR F207 A9
Ref. D-5

Beckton Larkaba D014 A
Beckton Larkaba B352 A

Beckton Epic D344 N7
Beckton Epic Z674 E6
Beckton Larkaba Y083 N

BECKTON SCARLETT F167 E
Beckton Scarlett D331 E
Beckton Epic Y484 N6
Beckton Scarlett W497 J

BWt	67
WR	103
YWt	1081
YR	107
Feb.ADG	3.76
Feb.Scr.	36
Frame	5.5
Feet	Good

DAM	
Age	2
Wt	885
Prog. BW	67
WR	103
YR	107
Udder	Good

Calv.Ease	BW	WW	YW	Milk	HPG	Stay	Maint.En.		
EPDs	10	-2.1	64	108	30	12	16	2.0	
Marb	+.38		REA +.07		Bfat +.04				
Beef Tenderness	→		DNA: 'Outstanding'		Scan: NA				
Wean Pct.	51%	Cow Eff.	107	HB	60	GM	44	ProS	104

★★★★★ for Growth, Gainability, Marbling, Superior Cow, Calving Ease.

89 BECKTON ORACLE H383 E2
1-A 100% # 4377119 Tat: BKT0 H383



Birth: 3-27-20

Schuler Sudden Impact 0004X
Red Crowfoot Ole's Oscar
SOR Duchess TS 8915U

SCHULER ORACLE-7142E
Ref. O-3

Sor Marlee Cmmtmnt 0470X
Brown Commitment S7206
SOR Marlee Beef 4511P

Beckton Epic B310 J6
Beckton Epic X464 L5
Beckton Minerva Y116 J

BECKTON VERNICE D043 E
Beckton Vernice B484 E
Beckton Epic X330 L6
Beckton Vernice Y434 H

BWt	56
WR	98
YWt	1021
YR	100
Feb.ADG	3.36
Feb.Scr.	34
Frame	5.5
Feet	Good

DAM	
Age	4
Wt	980
Prog. BW	57
WR	105
YR	104
Udder	Good

Calv.Ease	BW	WW	YW	Milk	HPG	Stay	Maint.En.		
EPDs	19	-5.4	59	97	25	11	16	5.0	
Marb	+.73		REA +.16		Bfat +.02				
Beef Tenderness	→		DNA: 'Outstanding'		Scan: Tender				
Wean Pct.	51%	Cow Eff.	108	HB	85	GM	65	ProS	150

★★★★★ for Marbling, Rib-eye area, Superior Cow, Calving Ease.



Lot 91



Lot 89

91 BECKTON ACCENT H667 E5
1-A 100% # 4377787 Tat: BSF0 H667



Birth: 4-18-20

Beckton Accent Y312 N3
Beckton Accent U777 C2
BKT Larkeisa S055 NB

BECKTON ACCENT C557 N4
Ref. A-4

Beckton Minerva Y654 N
Beckton Nebula T398 V3
Beckton Minerva M369 LO

Beckton Emperor Y459 J3
Beckton Indigo S354 JT

BECKTON COCA A056 E
Beckton Coca Y399 L
Beckton Likable U120 L2
Beckton Coca H051 CH

BWt	75
WR	109
YWt	1102
YR	108
Feb.ADG	3.41
Feb.Scr.	32
Frame	5.5
Feet	Good

DAM	
Age	7
Wt	1190
Prog. BW	70
WR	111
YR	105
Udder	Good

Calv.Ease	BW	WW	YW	Milk	HPG	Stay	Maint.En.		
EPDs	15	-3.4	56	89	30	11	15	3.0	
Marb	+.50		REA -.04		Bfat +.03				
Beef Tenderness	→		DNA: 'Outstanding'		Scan: Tender				
Wean Pct.	49%	Cow Eff.	102	HB	74	GM	40	ProS	114

★★★★★ for Growth, Marbling, Superior Cow, Calving Ease.

• Bulls •

92 BECKTON SCAMP H252 H6
1-A 100% # 4377283 Tat: BKT0 H252



Birth: 3-20-20

Beckton Scamp B720 L4
Beckton Larkaba Y448 L

BECKTON SCAMP E175 N5
Ref. S-1

Beckton Nebula T398 V3
Beckton Belga T551 EP

Beckton Julian X465 J5
Beckton Julian G5 S107

BECKTON PINE MARIE B248 J
Beckton Suffeina P643 JL

BKT Pine Marie P351 EP
Beckton Epic KJ J722

BKT Pine Marie L002 HR

BWt	63
WR	92
YWt.	1028
YR	100
Feb.ADG	3.67
Feb.Scr.	36
Frame	5.0
Feet	Good

DAM											
Age	6	Calv.Ease	BW	WW	YW	Milk	HPG	Stay	Maint.En.		
Wt	1180	EPDs	17	-5.0	56	100	25	11	16	-1.0	
Prog. BW	64	Marb	+.40		REA	-.01		Bfat	+.03		
WR	102	Beef Tenderness	→		DNA:	'Outstanding'		Scan:	Tender		
YR	101	Wean Pct.	41%	Cow Eff.	87	HB	78	GM	55	ProS	133
Udder	Very Good										

★★★★★ for Low Maintenance, Gainability, Marbling, Calving Ease.

95 BECKTON LIKABLE H086 L5
1-A 100% # 4377473 Tat: BKT0 H086



Birth: 2-29-20

Beckton Likable Y124 L3
Beckton Likable U130 L2
BKT Pine Marie S802 LO

BECKTON LIKABLE F242 D4
Ref. L-6

Beckton Dominor W640 C5
Beckton Firefly U801 NB

Beckton Firefly A022 D

Beckton Likable B509 J3
Beckton Likable U130 L2
Beckton Coca T363 JL

BECKTON SERENA F299 L
Beckton Emcee S466
Beckton Serena N088 WR

BWt	60
WR	116
YWt.	1072
YR	106
Feb.ADG	3.50
Feb.Scr.	35
Frame	5.5
Feet	Good

DAM											
Age	2	Calv.Ease	BW	WW	YW	Milk	HPG	Stay	Maint.En.		
Wt	805	EPDs	20	-5.7	55	83	32	10	13	-2.0	
Prog. BW	60	Marb	+.30		REA	+.15		Bfat	+.03		
WR	116	Beef Tenderness	→		DNA:	'Very Good'		Scan:	Tender		
YR	106	Wean Pct.	63%	Cow Eff.	133	HB	71	GM	24	ProS	95
Udder	Very Good										

★★★★★ for Low Maintenance, Growth, Marbling, Rib-eye area, Superior Cow, High Cow Efficiency, Calving Ease.

93 BECKTON ACCENT H090 S5
1-A 100% # 4378241 Tat: BSF0 H090



Birth: 2-29-20

Beckton Accent B549 N3
Beckton Accent W180 C2
Beckton Minerva Y654 N

BECKTON ACCENT F363 L4
Ref. A

Beckton Likable Z057 L4
Beckton Coca Z037 J

Beckton Coca B062 L

Beckton Scamp D325 N5
Beckton Scamp A627 J4
Beckton Tamara Y039 N

BECKTON MINOLA F134 S
Beckton New Era Y194
Beckton Minola N751 JL

BWt	68
WR	102
YWt.	1028
YR	102
Feb.ADG	3.54
Feb.Scr.	35
Frame	5.5
Feet	Good

DAM											
Age	2	Calv.Ease	BW	WW	YW	Milk	HPG	Stay	Maint.En.		
Wt	870	EPDs	19	-3.9	62	111	23	11	18	-1.0	
Prog. BW	68	Marb	+.43		REA	+.03		Bfat	+.03		
WR	102	Beef Tenderness	→		DNA:	'Outstanding'		Scan:	Tender		
YR	102	Wean Pct.	51%	Cow Eff.	107	HB	93	GM	49	ProS	142
Udder	Very Good										

★★★★★ for Low Maintenance, Gainability, Marbling, Calving Ease.

96 BECKTON NOMAD H359 L2
1-A 100% # 4377155 Tat: BKT0 H359



Birth: 3-25-20

Beckton Nomad 7496
Beckton Neva 5562
Bkt Bolt Tamrck 3913

BECKTON NOMAD V 9871
Ref. V

Bkt Lahrogno-3
Beckton Varo 5642

Bkt Barmmaid 6986 VR

Beckton Likable Y124 L3
Beckton Likable U130 L2
BKT Pine Marie S802 LO

BECKTON TAMARA D313 L
Beckton Legend S670
Beckton Tamara P243 JO

BWt	59
WR	113
YWt.	1081
YR	106
Feb.ADG	3.05
Feb.Scr.	33
Frame	5.5
Feet	Good

DAM											
Age	4	Calv.Ease	BW	WW	YW	Milk	HPG	Stay	Maint.En.		
Wt	1140	EPDs	20	-6.5	44	58	26	9	13	-16.0	
Prog. BW	59	Marb	+.37		REA	-.15		Bfat	+.03		
WR	113	Beef Tenderness	→		DNA:	'Average'		Scan:	Tender		
YR	106	Wean Pct.	51%	Cow Eff.	107	HB	72	GM	16	ProS	88
Udder	Very Good										

★★★★★ for Low Maintenance, Marbling, Superior Cow, Calving Ease.

94 BECKTON ACCENT H531 E5
1-A 100% # 4376959 Tat: BKT0 H531



Birth: 4-5-20

Beckton Accent Y312 N3
Beckton Accent U777 C2
BKT Larkeisa S055 NB

BECKTON ACCENT C557 N4
Ref. A-4

Beckton Nebula T398 V3
Beckton Minerva M369 LO

Beckton Minerva Y654 N

Beckton Epic Y484 N6
Beckton Epic U749 D5
Beckton Lydia S069 NB

BECKTON MINERVA A885 E
Beckton Nebula T398 V3
Beckton Minerva T864 CK

BWt	70
WR	110
YWt.	1114
YR	109
Feb.ADG	3.58
Feb.Scr.	38
Frame	5.5
Feet	Good

DAM											
Age	7	Calv.Ease	BW	WW	YW	Milk	HPG	Stay	Maint.En.		
Wt	1025	EPDs	16	-3.6	61	102	30	14	16	3.0	
Prog. BW	64	Marb	+.31		REA	+.06		Bfat	+.03		
WR	109	Beef Tenderness	→		DNA:	'Outstanding'		Scan:	Tender		
YR	105	Wean Pct.	57%	Cow Eff.	120	HB	88	GM	35	ProS	123
Udder	Very Good										

★★★★★ for Growth, Gainability, Marbling, Superior Cow, High Cow Efficiency, Calving Ease.



Lot 94

• Bulls •



Lot 96

99 BECKTON LEGEND H288 D3
1-A 100% # 4377233 Tat: BKT0 H288

Birth: 3-22-20

Beckton Legend S670
Beckton Lancer F442 T
Beckton Kit F468 JL

BECKTON LEGEND C313 C2
Ref. L Beckton Minola W808 C
BKT Clifftop TP R288
Beckton Minola R604 CD

Beckton Dominor A378 W7
Beckton Dominor Y005 V6
Beckton Lana Y541 W

BECKTON COCA D301 D
Beckton Coca X701 N
Beckton Nebula T398 V3
Beckton Coca T499 SC

BWt	70
WR	109
YWt.	1032
YR	101
Feb.ADG	3.10
Feb.Scr.	37
Frame	5.5
Feet	Good

DAM	
Age	4
Wt	990
Prog. BW	59
WR	95
YR	101
Udder	Fair

Calv.Ease	BW	WW	YW	Milk	HPG	Stay	Maint.En.
EPDs 17	-3.4	53	81	26	12	20	-5.0
Marb	+0.37	REA	+0.13	Bfat	+0.02		
Beef Tenderness	→		DNA: 'Outstanding'	Scan:	Tender		
Wean Pct.	57%	Cow Eff.	119	HB	111	GM	31
ProS	142						

★★★★★ for Low Maintenance, Marbling, Rib-eye area, High Cow Efficiency, Calving Ease.

97 BECKTON NOMAD H321 N2
1-A 100% # 4378069 Tat: BSF0 H321

Birth: 3-24-20

Beckton Nomad 7496
Beckton Neva 5562
Bkt Bolt Tamrck 3913

BECKTON NOMAD V 9871
Ref. V Bkt Barmaid 6986 VR
Beckton Varo 5642
Bkt Lahrogno-3

Beckton Nebula T398 V3
Beckton Nebula L P093
Beckton Minerva J615 VG

BECKTON ENCINO X785 N
Beckton Encino S456 JC
Beckton Justice G302
Beckton Encino J431 DM

BWt	75
WR	103
YWt.	1019
YR	100
Feb.ADG	3.23
Feb.Scr.	37
Frame	5.0
Feet	Good

DAM	
Age	10
Wt	1250
Prog. BW	73
WR	109
YR	110
Udder	Good

Calv.Ease	BW	WW	YW	Milk	HPG	Stay	Maint.En.
EPDs 15	-4.1	46	62	24	10	13	-15.0
Marb	+0.28	REA	-0.27	Bfat	+0.02		
Beef Tenderness	→		DNA: 'Poor'	Scan:	Tender		
Wean Pct.	44%	Cow Eff.	92	HB	65	GM	7
ProS	72						

★★★★★ for Low Maintenance, Marbling, Superior Cow, Calving Ease.



Lot 99

98 BECKTON ALLEGIANT H190 N2
1-A 100% # 4378169 Tat: BSF0 H190

Birth: 3-16-20

Halfmann Divergent C249
LSF Takeover 9943W
Beckton Eola U101 NB

HALFMANN ALLEGIANT E835
Ref. O-1 Halfmann Chief RK C258
Buf Crk The Right Kind U199
Halfmann Chief DV Z707

Beckton Nebula T398 V3
Beckton Nebula L P093
Beckton Minerva J615 VG

BECKTON ANGEL X450 N
Beckton Angel T004 CT
BKT Clifftop TP R288
Beckton Angel R155 CT

BWt	64
WR	109
YWt.	1058
YR	103
Feb.ADG	3.10
Feb.Scr.	37
Frame	5.0
Feet	Good

DAM	
Age	10
Wt	1150
Prog. BW	67
WR	101
YR	101
Udder	Very Good

Calv.Ease	BW	WW	YW	Milk	HPG	Stay	Maint.En.
EPDs 17	-5.4	46	70	28	11	19	-3.0
Marb	+0.44	REA	-0.14	Bfat	+0.04		
Beef Tenderness	→		DNA: 'Very Good'	Scan:	Tender		
Wean Pct.	51%	Cow Eff.	107	HB	98	GM	21
ProS	119						

★★★★★ for Low Maintenance, Marbling, Calving Ease.

100 BECKTON LIKABLE H124 E6
1-A 100% # 4378221 Tat: BSF0 H124

Birth: 3-8-20

Beckton Likable Z057 L4
Beckton Likable X445 J3
Beckton Minola X107 L

BECKTON LIKABLE F520 N5
Ref. L-8 Beckton Sierra A836 N
Beckton New Era Y194
Beckton Sierra S847 WR

Beckton Epic D344 N7
Beckton Epic Z674 E6
Beckton Larkaba Y083 N

BECKTON LANA F129 E
Beckton Lana D724 L
Beckton Likable Z057 L4
Beckton Lana W370 E

BWt	62
WR	115
YWt.	1069
YR	106
Feb.ADG	3.41
Feb.Scr.	37
Frame	5.5
Feet	Good

DAM	
Age	2
Wt	870
Prog. BW	62
WR	115
YR	106
Udder	Very Good

Calv.Ease	BW	WW	YW	Milk	HPG	Stay	Maint.En.
EPDs 13	-2.5	68	118	23	11	13	2.0
Marb	+0.39	REA	+0.26	Bfat	+0.03		
Beef Tenderness	→		DNA: 'Very Good'	Scan:	Tender		
Wean Pct.	58%	Cow Eff.	123	HB	55	GM	50
ProS	105						

★★★★★ for Growth, Marbling, Rib-eye area, Superior Cow, High Cow Efficiency, Calving Ease.

• Bulls •

101 BECKTON JULIAN H109 J8
1-A 100% # 4377447 Tat: BKT0 H109



Birth: 3-4-20

Beckton Julian D551 C6
Beckton Julian X465 J5
Beckton Tamara W550 A

BECKTON JULIAN F067 L7
Ref. J-5
Beckton Indigo D786 L
Beckton Likable Z057 L4
Beckton Indigo Y026 N

Beckton Julian D551 C6
Beckton Julian X465 J5
Beckton Tamara W550 A

BECKTON PINE MARIE F024 J
Beckton Pine Marie D705 E
Beckton Epic Y484 N6
Beckton Pine Marie A446 L

BWt	73
WR	113
YWt.	1037
YR	102
Feb.ADG	3.63
Feb.Scr.	35
Frame	5.5
Feet	Good

DAM	
Age	2
Wt	740
Prog. BW	73
WR	113
YR	102
Udder	Good

Calv.Ease	BW	WW	YW	Milk	HPG	Stay	Maint.En.		
EPDs	12	-1.4	71	119	27	12	14	2.0	
Marb	+.47		REA -.04		Bfat +.04				
Beef Tenderness	→		DNA: 'Outstanding'		Scan: Tender				
Wean Pct.	67%	Cow Eff.	141	HB	44	GM	48	ProS	92

103 BECKTON ACCENT H313 L4
1-A 100% # 4377209 Tat: BKT0 H313



Birth: 3-23-20

Beckton Accent W180 C2
Beckton Cody K1 P014
Beckton Christy R046 CQ

BECKTON ACCENT B549 N3
Ref. A-2
Beckton Minerva Y654 N
Beckton Nebula T398 V3
Beckton Minerva M369 LO

Beckton Likable U120 L2
Beckton Likable S633
Beckton Lana S718 LN

BECKTON SUSAN A839 L
Beckton Susan N023 JE
Beckton Jules L429
Beckton Susan L258 LR

BWt	73
WR	102
YWt.	1046
YR	102
Feb.ADG	3.63
Feb.Scr.	36
Frame	5.5
Feet	Good

DAM	
Age	7
Wt	965
Prog. BW	66
WR	94
YR	99
Udder	Very Good

Calv.Ease	BW	WW	YW	Milk	HPG	Stay	Maint.En.		
EPDs	16	-3.5	57	94	25	12	20	-2.0	
Marb	+.35		REA +.23		Bfat +.02				
Beef Tenderness	→		DNA: 'Outstanding'		Scan: Tender				
Wean Pct.	56%	Cow Eff.	119	HB	101	GM	35	ProS	136

★★★★★ for Gainability, Marbling, High Cow Efficiency, Calving Ease.

★★★★★ for Low Maintenance, Gainability, Marbling, Rib-eye area, High Cow Efficiency, Calving Ease.

102 BECKTON ACCENT H273 L4
1-A 100% # 4378107 Tat: BSF0 H273



Birth: 3-21-20

Beckton Accent W180 C2
Beckton Cody K1 P014
Beckton Christy R046 CQ

BECKTON ACCENT A175 O3
Ref. A
Beckton Lana R214 RA
TR Romeo NT379
Beckton Lana N664 JL

Beckton Legend S670
Beckton Lancer F442 T
Beckton Kit F468 JL

BECKTON MINOLA D778 L
Beckton Minola Z796 J
Beckton Julian U699 L5
Beckton Minola K527 CO

BWt	64
WR	106
YWt.	1077
YR	105
Feb.ADG	3.50
Feb.Scr.	32
Frame	5.5
Feet	Good

DAM	
Age	4
Wt	930
Prog. BW	58
WR	106
YR	105
Udder	-

Calv.Ease	BW	WW	YW	Milk	HPG	Stay	Maint.En.		
EPDs	18	-5.1	53	80	26	11	21	-5.0	
Marb	+.44		REA +.05		Bfat +.03				
Beef Tenderness	→		DNA: 'Outstanding'		Scan: Tender				
Wean Pct.	58%	Cow Eff.	123	HB	108	GM	31	ProS	139



Lot 103

★★★★★ for Low Maintenance, Growth, Marbling, Superior Cow, High Cow Efficiency, Calving Ease.



Lot 100

104 BECKTON ACCENT H366 E3
1-A 100% # 4377147 Tat: BKT0 H366



Birth: 3-26-20

Beckton Accent U777 C2
Beckton Cody K1 P014
Beckton Susan R022 CQ

BECKTON ACCENT B553 L2
Ref. A-3
Beckton Lana X839 L
Beckton Legend S670
Beckton Lana S371 DM

Beckton Epic K6 S569
Beckton Sierra N703 LM

BECKTON INDIGO U504 EP
Beckton Indigo S016 NB
Beckton Nebula P P707
Beckton Indigo P062 NB

BWt	57
WR	108
YWt.	1072
YR	105
Feb.ADG	3.45
Feb.Scr.	36
Frame	5.5
Feet	Good

DAM	
Age	12
Wt	1030
Prog. BW	73
WR	113
YR	109
Udder	Very Good

Calv.Ease	BW	WW	YW	Milk	HPG	Stay	Maint.En.		
EPDs	17	-4.7	54	91	30	12	16	-6.0	
Marb	+.52		REA -.14		Bfat +.04				
Beef Tenderness	→		DNA: 'Outstanding'		Scan: Tender				
Wean Pct.	54%	Cow Eff.	113	HB	83	GM	40	ProS	123

★★★★★ for Low Maintenance, Marbling, Superior Cow, Calving Ease.

• Bulls •

105 WCRA JULIAN H166  2 100% # 4305883 Tat: WCRA0 HC16

Birth: 4-9-20

Beckton Julian X465 J5
Beckton Sufteina P643 JL

BECKTON JULIAN A434 N6
Ref. J-3

Beckton Lakme T689 NX
Beckton Nexus L016
Beckton Lakme M669 EP

Beckton Warrior U636 J5
Beckton Warrior N645 T1
Beckton Lydia H159 JL

BKT PINE MARIE Z513 W
Beckton Warrior TD L493
BKT Pine Marie L650 EP

BWt	74
WR	107
YWt	983
YR	99
Feb.ADG	3.10
Feb.Scr.	34
Frame	5.5
Feet	Good

DAM	
Age	8
Wt	1190
Prog. BW	77
WR	107
YR	109
Udder	Very Good

Calv.Ease	BW	WW	YW	Milk	HPG	Stay	Maint.En.
EPDs	11	-1.7	64	103	24	14	0.0
Marb	+0.47		REA	+0.04		Bfat	+0.02
Beef Tenderness	→		DNA:	NA		Scan:	Tender
Wean Pct.	59%	Cow Eff.	NA	HB	71	GM	44
ProS	115						

★★★★★ for Low Maintenance, Marbling, Superior Cow.

108 BECKTON CARDINAL H084 D4  1-A 100% # 4377477 Tat: BKT0 H084

Birth: 2-29-20

Beckton Cardinal D010 W2
Beckton Firefly B052 W

BECKTON CARDINAL F175 L3
Ref. C-2

Beckton Larkaba B428 L
Beckton Likable U130 L2
Beckton Larkaba X064 J

TR Double Eagle ZT220
TR Ricardo DOS
Beckton Lana U182 JC

BECKTON PINE MARIE F390 D
Beckton Pine Marie A446 L
Beckton Likable U120 L2
BKT Pine Marie U481 NM

BWt	53
WR	105
YWt	1055
YR	104
Feb.ADG	3.45
Feb.Scr.	36
Frame	5.0
Feet	Good

DAM	
Age	2
Wt	890
Prog. BW	53
WR	105
YR	104
Udder	-

Calv.Ease	BW	WW	YW	Milk	HPG	Stay	Maint.En.
EPDs	22	-7.1	48	80	26	11	-5.0
Marb	+0.46		REA	+0.13		Bfat	+0.03
Beef Tenderness	→		DNA:	'Very Good'		Scan:	Tender
Wean Pct.	51%	Cow Eff.	108	HB	95	GM	42
ProS	137						

★★★★★ for Low Maintenance, Marbling, Rib-eye area, Superior Cow, Calving Ease.

106 BECKTON HUGHES H374 N3  1-A 100% # 4377135 Tat: BKT0 H374

Birth: 3-26-20

Bieber H Hughes W109
Basin Hobo 0545
Basin Rose 06T0

BECKTON HUGHES C463 N2
Ref. B-1

Beckton Lakme T689 NX
Beckton Nexus L016
Beckton Lakme M669 EP

Beckton New Era Y194
Beckton Nebula P P707
BKT Larkeisa T310 JC

BECKTON TAMARA B394 N
Beckton Tamara Y612 L
Beckton Likable U130 L2
Beckton Tamara T201 CT

BWt	70
WR	109
YWt	974
YR	95
Feb.ADG	2.26
Feb.Scr.	34
Frame	5.0
Feet	Good

DAM	
Age	6
Wt	1185
Prog. BW	73
WR	105
YR	102
Udder	Very Good

Calv.Ease	BW	WW	YW	Milk	HPG	Stay	Maint.En.
EPDs	15	-3.0	63	88	25	12	3.0
Marb	+0.37		REA	+0.01		Bfat	+0.03
Beef Tenderness	→		DNA:	'Very Good'		Scan:	Tender
Wean Pct.	49%	Cow Eff.	103	HB	98	GM	5
ProS	103						

★★★★★ for Marbling, Calving Ease.



Lot 108

107 BECKTON JULIAN H351 E8  1-A 100% # 4378047 Tat: BSF0 H351

Birth: 3-25-20

Beckton Julian X721 E6
Beckton Lana U329 EP

BECKTON JULIAN Z382 J7
Ref. J-2

Beckton Larkaba X064 J
Beckton Julian U699 L5
Beckton Larkaba U475 CT

Beckton Epic Z674 E6
Beckton Epic U749 D5
Beckton Indigo U504 EP

BECKTON CHRISTY E736 E
Beckton Accent W180 C2
Beckton Christy Y364 N

BWt	63
WR	114
YWt	1100
YR	111
Feb.ADG	3.41
Feb.Scr.	34
Frame	5.5
Feet	Good

DAM	
Age	3
Wt	1110
Prog. BW	63
WR	114
YR	111
Udder	-

Calv.Ease	BW	WW	YW	Milk	HPG	Stay	Maint.En.
EPDs	20	-6.4	57	90	29	13	-4.0
Marb	+0.42		REA	+0.02		Bfat	+0.05
Beef Tenderness	→		DNA:	'Very Good'		Scan:	Tender
Wean Pct.	48%	Cow Eff.	101	HB	96	GM	22
ProS	118						

★★★★★ for Low Maintenance, Growth, Marbling, Superior Cow, Calving Ease.

109 BECKTON DOMINOR H322 A7  1-A 100% # 4377199 Tat: BKT0 H322

Birth: 3-24-20

Beckton Dominor W640 C5
Beckton Dominor Z1 R610
Beckton Mona R166 CQ

BECKTON DOMINOR Y052 N6
Ref. D-1

Beckton Indigo W772 N
Beckton Nebula T398 V3
Beckton Indigo T613 JT

Beckton Accent A175 O3
Beckton Accent W180 C2
Beckton Lana R214 RA

BECKTON LARKEISA E638 A
Beckton Jet L P491
Beckton Larkeisa X659 C

BWt	70
WR	107
YWt	1077
YR	109
Feb.ADG	3.63
Feb.Scr.	36
Frame	5.5
Feet	Good

DAM	
Age	3
Wt	945
Prog. BW	70
WR	107
YR	109
Udder	Very Good

Calv.Ease	BW	WW	YW	Milk	HPG	Stay	Maint.En.
EPDs	15	-2.4	53	87	24	11	-1.0
Marb	+0.31		REA	+0.02		Bfat	+0.04
Beef Tenderness	→		DNA:	'Outstanding'		Scan:	Tender
Wean Pct.	52%	Cow Eff.	110	HB	87	GM	32
ProS	119						

★★★★★ for Low Maintenance, Growth, Gainability, Marbling, Superior Cow, Calving Ease.

• Bulls •

110 BECKTON HERITAGE H299 N5

1-A 100% # 4377223 Tat: BKT0 H299 

Birth: 3-23-20

Beckton Heritage X403 L3 < Beckton Heritage T270 J2
Beckton Indigo H150 LN

BECKTON HERITAGE C477 J4
Ref. H-1 < Beckton Ruth Z858 J < Beckton Julian U699 L5
Beckton Ruth U557 JT

Beckton Nebula P P707 < Beckton Nebula M045
Beckton Lana M809 EP

BECKTON CHRISTY B401 N
Beckton Christy T444 JL < Beckton Julian G2 M345
Beckton Christy L654 JL

BWt	63
WR	90
YWt.	1029
YR	101
Feb.ADG	3.72
Feb.Scr.	33
Frame	5.0
Feet	Good

DAM	
Age	6
Wt	1075
Prog. BW	64
WR	98
YR	102
Udder	Very Good

Calv.Ease	BW	WW	YW	Milk	HPG	Stay	Maint.En.
EPDs	16	-4.3	52	92	27	13	17 -5.0
Marb	+.46		REA +.07		Bfat +.04		
Beef Tenderness	→		DNA: 'Outstanding'		Scan: Tender		
Wean Pct.	44%	Cow Eff.	93	HB	91	GM	51 ProS 142

★★★★★ for Low Maintenance, Gainability, Marbling, Calving Ease.

113 BECKTON DOMINOR H329 N7

1-A 100% # 4377191 Tat: BKT0 H329 

Birth: 3-24-20

Beckton Dominor W640 C5 < Beckton Dominor Z1 R610
Beckton Mona R166 CQ

BECKTON DOMINOR Y052 N6
Ref. D-1 < Beckton Nebula T398 V3
Beckton Indigo W772 N < Beckton Indigo T613 JT

Beckton Nebula B046 N5 < Beckton Nebula Z180 H4
Beckton Tamara U151 NB

BECKTON CHRISTY E410 N
Beckton Christy A231 L < Beckton Likable Y675 E3
Beckton Christy Y413 N

BWt	55
WR	115
YWt.	1084
YR	110
Feb.ADG	3.54
Feb.Scr.	40
Frame	5.0
Feet	Good

DAM	
Age	3
Wt	905
Prog. BW	55
WR	115
YR	110
Udder	Good

Calv.Ease	BW	WW	YW	Milk	HPG	Stay	Maint.En.
EPDs	18	-5.8	48	76	27	12	19 -2.0
Marb	+.31		REA -.05		Bfat +.04		
Beef Tenderness	→		DNA: 'Outstanding'		Scan: Tender		
Wean Pct.	59%	Cow Eff.	124	HB	98	GM	20 ProS 118

★★★★★ for Low Maintenance, Growth, Gainability, Marbling, Superior Cow, High Cow Efficiency, Calving Ease.

111 BECKTON ACCENT H536 E5

1-A 100% # 4376951 Tat: BKT0 H536 

Birth: 4-5-20

Beckton Accent Y312 N3 < Beckton Accent U777 C2
BKT Larkeisa S055 NB

BECKTON ACCENT C557 N4
Ref. A-4 < Beckton Nebula T398 V3
Beckton Minerva Y654 N < Beckton Minerva M369 LO

Beckton Emcee W526 J2 < Beckton Emcee S466
Beckton Larkaba P645 JL

BECKTON LARKABA B651 E
Beckton Larkaba W050 E < Beckton Epic T330 L5
Beckton Larkaba T184 NB

BWt	60
WR	99
YWt.	1028
YR	100
Feb.ADG	3.23
Feb.Scr.	38
Frame	5.5
Feet	Good

DAM	
Age	6
Wt	1080
Prog. BW	65
WR	103
YR	101
Udder	Very Good

Calv.Ease	BW	WW	YW	Milk	HPG	Stay	Maint.En.
EPDs	18	-6.3	48	79	30	11	14 2.0
Marb	+.43		REA -.02		Bfat +.04		
Beef Tenderness	→		DNA: 'Outstanding'		Scan: Tender		
Wean Pct.	49%	Cow Eff.	103	HB	70	GM	35 ProS 105

★★★★★ for Marbling, Calving Ease.

114 BECKTON JULIAN H298 L9

1-A 100% # 4377225 Tat: BKT0 H298 

Birth: 3-23-20

Beckton Julian Z382 J7 < Beckton Julian X721 E6
Beckton Larkaba X064 J

BECKTON JULIAN E423 N8
Ref. J-4 < Beckton Nebula Z111 N5
Beckton Belga B004 N < Beckton Belga Z031 N

Beckton Likable U130 L2 < Beckton Likable S633
Beckton Kit S478 LN

BECKTON LANA B670 L
Beckton Lana Y541 W < Beckton Warrior T248 L5
Beckton Lana S074 EP

BWt	59
WR	93
YWt.	1034
YR	101
Feb.ADG	3.67
Feb.Scr.	35
Frame	5.0
Feet	Good

DAM	
Age	6
Wt	900
Prog. BW	63
WR	98
YR	101
Udder	Very Good

Calv.Ease	BW	WW	YW	Milk	HPG	Stay	Maint.En.
EPDs	20	-6.7	50	80	28	12	17 -6.0
Marb	+.46		REA -.02		Bfat +.04		
Beef Tenderness	→		DNA: 'Outstanding'		Scan: Tender		
Wean Pct.	55%	Cow Eff.	116	HB	101	GM	38 ProS 139

★★★★★ for Low Maintenance, Gainability, Marbling, High Cow Efficiency, Calving Ease.

112 BECKTON LIKABLE H028 L5

1-A 100% # 4377541 Tat: BKT0 H028 

Birth: 2-18-20

Beckton Likable B509 J3 < Beckton Likable U130 L2
Beckton Coca T363 JL

BECKTON LIKABLE F816 A4
Ref. L-10 < Beckton Accent Y312 N3
Beckton Barmaid X819 N

Beckton Likable B509 J3 < Beckton Likable U130 L2
Beckton Coca T363 JL

BECKTON CHRISTY F429 L
Beckton Christy B401 N < Beckton Nebula P P707
Beckton Christy T444 JL

BWt	59
WR	97
YWt.	1006
YR	99
Feb.ADG	3.72
Feb.Scr.	34
Frame	5.0
Feet	Good

DAM	
Age	2
Wt	915
Prog. BW	59
WR	97
YR	99
Udder	Very Good

Calv.Ease	BW	WW	YW	Milk	HPG	Stay	Maint.En.
EPDs	14	-3.0	55	91	28	12	14 -5.0
Marb	+.44		REA +.05		Bfat +.03		
Beef Tenderness	→		DNA: 'Outstanding'		Scan: Tender		
Wean Pct.	46%	Cow Eff.	96	HB	77	GM	42 ProS 119

★★★★★ for Low Maintenance, Gainability, Marbling, Calving Ease.

115 BECKTON LIKABLE H247 N6

1-A 100% # 4377291 Tat: BKT0 H247 

Birth: 3-20-20

Beckton Likable Z057 L4 < Beckton Likable X445 J3
Beckton Minola X107 L

BECKTON LIKABLE B032 C5
Ref. L-2 < Beckton Clifftop W577 E3
Beckton Mona U584 CD

Beckton New Era Y194 < Beckton Nebula P P707
BKT Larkeisa T310 JC

BECKTON LANA C389 N
Beckton Lana Y420 W < Beckton Warrior T248 L5
Beckton Lana T211 JL

BWt	69
WR	99
YWt.	1010
YR	99
Feb.ADG	3.27
Feb.Scr.	34
Frame	5.0
Feet	Good

DAM	
Age	5
Wt	1060
Prog. BW	62
WR	104
YR	106
Udder	Very Good

Calv.Ease	BW	WW	YW	Milk	HPG	Stay	Maint.En.
EPDs	18	-6.1	50	94	25	13	20 1.0
Marb	+.44		REA -.02		Bfat +.03		
Beef Tenderness	→		DNA: 'Outstanding'		Scan: Tender		
Wean Pct.	50%	Cow Eff.	105	HB	94	GM	57 ProS 151

★★★★★ for Marbling, Superior Cow, Calving Ease.

• Bulls •

116 BECKTON ORACLE H411 N2

1-A 100% # 4377087 Tat: BKT0 H411

Birth: 3-28-20

Schuler Sudden Impact 0004X Red Crowfoot Ole's Oscar
 Sor Marlee Cmmtmnt 0470X SOR Duchess TS 8915U

SCHULER ORACLE-7142E
 Ref. O-3

Beckton Nebula W486 D3 Beckton Nebula L P093
 Beckton Larkeisa X126 N Beckton Belga R716 DM
 Beckton Nebula U060 N4
 BKT Larkeisa U458 NB

BECKTON LARKEISA B552 N

DAM											
Age	6	Calv.Ease	BW	WW	YW	Milk	HPG	Stay	Maint.En.		
Wt	1230	EPDs	19	-5.2	55	91	22	12	19	6.0	
Prog. BW	68	Marb	+.69		REA	+.16		Bfat	+.02		
WR	100	Beef Tenderness	→		DNA: 'Outstanding'	Scan: Tender					
YR	102	Wean Pct.	43%	Cow Eff.	91	HB	94	GM	59	ProS	153
Udder	Very Good										

Feb.AD.G 3.32
 Feb.Scr. 36
 Frame 5.0
 Feet Good

★★★★★ for Marbling, Rib-eye area, Calving Ease.

119 BSF NEBULA H254 N5

1-B 99% # 4378115 Tat: BSF0 H254

Birth: 3-20-20

Beckton Nebula T398 V3 Beckton Nebula L P093
 Beckton Minerva J615 VG

BECKTON NEBULA A773 L4
 Ref. N-3

Beckton Mona X022 L Beckton Likable U130 L2
 Beckton Mona U584 CD

Beckton Nomad X290 N3 Beckton Nomad V 9871
 Beckton Birdie S110 NB

BSF NEBULANN Z158 N
 BSF Nebulann X483 J BSF Nebulann R163 NB

DAM											
Age	8	Calv.Ease	BW	WW	YW	Milk	HPG	Stay	Maint.En.		
Wt	1130	EPDs	17	-5.2	54	81	29	12	19	-4.0	
Prog. BW	65	Marb	+.35		REA	-.01		Bfat	+.03		
WR	103	Beef Tenderness	→		DNA: 'Very Good'	Scan: Tender					
YR	102	Wean Pct.	51%	Cow Eff.	108	HB	101	GM	19	ProS	120
Udder	Very Good										

Feb.AD.G 3.07
 Feb.Scr. 38
 Frame 5.0
 Feet Good

★★★★★ for Low Maintenance, Marbling, Calving Ease.

117 BECKTON CARDINAL H263 N2

1-A 100% # 4377267 Tat: BKT0 H263

Birth: 3-21-20

TR Double Eagle ZT220 TR Ricardo DOS
 Beckton Lana U182 JC

BECKTON CARDINAL E673 L
 Ref. C-1

Beckton Larkaba A911 L Beckton Legend U331 E2
 Beckton Larkaba T418 WA

Beckton Nebula X096 N4 Beckton Nebula U206 V3
 Beckton Tamara U185 NB

BECKTON SIERRA Z059 N
 Beckton Sierra X818 C Beckton Cherokee T450 L3
 Beckton Sierra G615 WR

DAM											
Age	8	Calv.Ease	BW	WW	YW	Milk	HPG	Stay	Maint.En.		
Wt	1290	EPDs	17	-3.0	61	103	25	13	18	5.0	
Prog. BW	87	Marb	+.45		REA	+.10		Bfat	+.02		
WR	110	Beef Tenderness	→		DNA: 'Very Good'	Scan: Tender					
YR	112	Wean Pct.	38%	Cow Eff.	81	HB	92	GM	44	ProS	136
Udder	Good										

Feb.AD.G 3.63
 Feb.Scr. 35
 Frame 5.0
 Feet Good

★★★★★ for Gainability, Marbling, Superior Cow, Calving Ease.

120 BECKTON GENETICS H386

1-B 99% # Tat: BKT0 H386

Birth: 3-27-20

BECKTON GENETICS MULTI SIRE
 Ref.

Beckton Clifftop W692 E3 BKT Clifftop TP R288
 Beckton Lydia S274 EP

BECKTON KIT E519 C
 Beckton Kit B224 A Beckton Accent U777 C2
 Beckton Kit S424 EP

DAM											
Age	3	Calv.Ease	BW	WW	YW	Milk	HPG	Stay	Maint.En.		
Wt	9750	EPDs	9	-2.3	24	41	12	5	9	-4.0	
Prog. BW	78	Marb	+.24		REA	-.09		Bfat	+.02		
WR	106	Beef Tenderness	→		DNA: 'Outstanding'	Scan: Tender					
YR	103	Wean Pct.	6%	Cow Eff.	12	HB	NA	GM	NA	ProS	NA
Udder	Very Good										

Feb.AD.G 3.42
 Feb.Scr. 37
 Frame 5.5
 Feet Good

★★★★★ for Low Maintenance, Marbling, Superior Cow, Calving Ease.

118 BECKTON LIKABLE H336 L6

1-A 100% # 4378059 Tat: BSF0 H336

Birth: 3-24-20

Beckton Likable Z057 L4 Beckton Likable X445 J3
 Beckton Minola X107 L

BECKTON LIKABLE F682 S5
 Ref. L-9

Beckton Lana C073 S Beckton Scamp A627 J4
 Beckton Lana A083 A

Beckton Legend S670 Beckton Lancer F442 T
 Beckton Kit F468 JL

BECKTON LANA B283 L
 Beckton Lana W125 A Beckton Action T061 D1
 Beckton Lana T674 JL

DAM											
Age	6	Calv.Ease	BW	WW	YW	Milk	HPG	Stay	Maint.En.		
Wt	1110	EPDs	21	-8.6	47	80	24	13	19	-6.0	
Prog. BW	53	Marb	+.40		REA	+.08		Bfat	+.02		
WR	94	Beef Tenderness	→		DNA: 'Very Good'	Scan: Tender					
YR	98	Wean Pct.	48%	Cow Eff.	102	HB	107	GM	44	ProS	151
Udder	Very Good										

Feb.AD.G 3.41
 Feb.Scr. 37
 Frame 5.0
 Feet Good

★★★★★ for Low Maintenance, Marbling, Calving Ease.

121 BSF EPIC H326 L8

1-B 99% # 4378065 Tat: BSF0 H326

Birth: 3-24-20

Beckton Epic B483 N6 Beckton Epic U749 D5
 BKT Pine Marie X339 N

BECKTON EPIC D001 L7
 Ref. E-1

Beckton Mona B713 L Beckton Legend U331 E2
 Beckton Mona U564 JT

Beckton Legend S670 Beckton Lancer F442 T
 Beckton Kit F468 JL

BSF CLIFFTANA A563 L
 BSF Cliftana U655 CT Beckton Clifftop T3 N800
 BSF Regus L479 CH

DAM											
Age	7	Calv.Ease	BW	WW	YW	Milk	HPG	Stay	Maint.En.		
Wt	1170	EPDs	18	-5.7	48	82	26	10	18	-2.0	
Prog. BW	65	Marb	+.38		REA	+.24		Bfat	+.03		
WR	103	Beef Tenderness	→		DNA: 'Very Good'	Scan: Tender					
YR	102	Wean Pct.	46%	Cow Eff.	97	HB	91	GM	33	ProS	124
Udder	Very Good										

Feb.AD.G 3.33
 Feb.Scr. 34
 Frame 5.0
 Feet Good

★★★★★ for Low Maintenance, Marbling, Rib-eye area, Calving Ease.

• Bulls •

122 BKB LIKABLE H017 L6 

1-B 99% # 4378327 Tat: BKB0 H017
 Birth: 2-17-20
 Beckton Likable Z057 L4 < Beckton Likable X445 J3
 Beckton Minola X107 L
BECKTON LIKABLE F682 S5
 Ref. L-9 < Beckton Scamp A627 J4
 Beckton Lana C073 S < Beckton Lana A083 A
 Beckton Likable Z057 L4 < Beckton Likable X445 J3
BSF DOMINIQUE F213 L
 < Beckton Minola X107 L
 BSF Dominique A770 J < Beckton Julian X465 J5
 BSF Dominique X492 D

DAM		Calv.Ease	BW	WW	YW	Milk	HPG	Stay	Maint.En.	
Age	2	EPDs	17	-4.5	57	106	23	13	17	-5.0
Wt	900	Marb	+.45		REA	+.06		Bfat	+.02	
Prog. BW	62	Beef Tenderness	→		DNA: 'Very Good'	Scan: Tender				
WR	91	Wean Pct.	43%		Cow Eff.	91		HB	85	
YR	102							GM	65	
Udder	-							ProS	150	

★★★★★ for Low Maintenance, Gainability, Marbling, Calving Ease.

125 BECKTON ACCENT H091 A6 

1-A 100% # 4377467 Tat: BKT0 H091
 Birth: 2-29-20
 Beckton Accent B150 N4 < Beckton Accent Y260 L3
 BKT Larkeisa S055 NB
BECKTON ACCENT F177 L5
 Ref. A < Beckton Likable Y124 L3
 Beckton Vernice C782 L < Beckton Vernice X754 L
 Beckton Accent B549 N3 < Beckton Accent W180 C2
BECKTON INDIGO F248 A
 < Beckton Minerva Y654 N
 Beckton Indigo A462 J < Beckton Julian X465 J5
 Beckton Indigo W706 N

DAM		Calv.Ease	BW	WW	YW	Milk	HPG	Stay	Maint.En.	
Age	2	EPDs	13	-2.8	62	100	23	14	20	2.0
Wt	815	Marb	+.57		REA	-.04		Bfat	+.04	
Prog. BW	63	Beef Tenderness	→		DNA: 'Outstanding'	Scan: Tender				
WR	94	Wean Pct.	50%		Cow Eff.	105		HB	91	
YR	98							GM	47	
Udder	Very Good							ProS	138	

★★★★★ for Marbling, Calving Ease.

123 BECKTON ORACLE H371 C2 

1-A 100% # 4377141 Tat: BKT0 H371
 Birth: 3-26-20
 Schuler Sudden Impact 0004X < Red Crowfoot Ole's Oscar
 SOR Duchess TS 8915U
SCHULER ORACLE-7142E
 Ref. O-3 < Brown Commitment S7206
 Sor Marlee Cmmmtnt 0470X < SOR Marlee Beef 4511P
 Beckton Cardinal B074 N < TR Double Eagle ZT220
 BKT Pine Marie Z250 N
BECKTON BELGA E329 C
 Beckton Belga Y254 N < Beckton Nebula P P707
 Beckton Belga S747 EP

DAM		Calv.Ease	BW	WW	YW	Milk	HPG	Stay	Maint.En.	
Age	3	EPDs	21	-7.0	52	93	24	9	20	2.0
Wt	835	Marb	+.62		REA	+.13		Bfat	+.03	
Prog. BW	53	Beef Tenderness	→		DNA: 'Outstanding'	Scan: Tender				
WR	108	Wean Pct.	57%		Cow Eff.	121		HB	100	
YR	110							GM	60	
Udder	-							ProS	160	

★★★★★ for Growth, Gainability, Marbling, Rib-eye area, Superior Cow, High Cow Efficiency, Calving Ease.

126 BECKTON ACCENT H347 N3 

1-A 100% # 4377169 Tat: BKT0 H347
 Birth: 3-25-20
 Beckton Cody K1 P014 < Beckton Cody KH M390
 Beckton Rose M126 WR
BECKTON ACCENT W180 C2
 Ref. A-1 < Beckton Cherokee N N479
 Beckton Christy R046 CQ < Beckton Christy N740 HR
 Beckton Nebula X267 J3 < Beckton Nebula T269 E2
BECKTON EMERA E628 N
 < Beckton Indigo T613 JT
 Beckton Emera X106 E < Beckton Epic U126 J5
 Beckton Emera U675 CQ

DAM		Calv.Ease	BW	WW	YW	Milk	HPG	Stay	Maint.En.	
Age	3	EPDs	18	-4.6	49	81	26	13	21	-6.0
Wt	960	Marb	+.28		REA	+.10		Bfat	+.03	
Prog. BW	56	Beef Tenderness	→		DNA: 'Outstanding'	Scan: Tender				
WR	104	Wean Pct.	50%		Cow Eff.	105		HB	111	
YR	102							GM	23	
Udder	Very Good							ProS	134	

★★★★★ for Low Maintenance, Marbling, Calving Ease.

124 BSF LIKABLE H577 E4 

1-B 99% # 4377859 Tat: BSF0 H577
 Birth: 4-9-20
 Beckton Likable U130 L2 < Beckton Likable S633
 Beckton Kit S478 LN
BECKTON LIKABLE D432 N3
 Ref. L-3 < Beckton Nebula T054 H3
 Beckton Firefly W013 N < Beckton Firefly T003 JC
 Beckton Epic X330 L6 < Beckton Epic T330 L5
BSF JEWEL Z159 E
 < Beckton Kit R503 LN
 BSF Jewel X572 L < Beckton Loki CL S284
 BSF Jewel T380 JL

DAM		Calv.Ease	BW	WW	YW	Milk	HPG	Stay	Maint.En.	
Age	8	EPDs	17	-4.1	57	90	27	10	14	-3.0
Wt	1050	Marb	+.42		REA	+.07		Bfat	+.03	
Prog. BW	70	Beef Tenderness	→		DNA: 'Very Good'	Scan: Tender				
WR	111	Wean Pct.	61%		Cow Eff.	128		HB	71	
YR	107							GM	32	
Udder	Good							ProS	103	

★★★★★ for Low Maintenance, Marbling, Superior Cow, High Cow Efficiency, Calving Ease.

127 BECKTON SCAMP H651 D6 

1-A 100% # 4376825 Tat: BKT0 H651
 Birth: 4-17-20
 Beckton Scamp B720 L4 < Beckton Scamp X458 H3
 Beckton Larkaba Y448 L
BECKTON SCAMP E175 N5
 Ref. S-1 < Beckton Nebula T398 V3
 Beckton Belga W103 N < Beckton Belga T551 EP
 Beckton Dominor Y005 V6 < Beckton Dominor W640 C5
BECKTON EMERA A029 D
 < Beckton Belga W108 V
 Beckton Emera Y009 D < Beckton Dominor W640 C5
 Beckton Emera W092 N

DAM		Calv.Ease	BW	WW	YW	Milk	HPG	Stay	Maint.En.	
Age	7	EPDs	22	-7.0	49	90	25	11	19	-2.0
Wt	1115	Marb	+.43		REA	+.08		Bfat	+.03	
Prog. BW	60	Beef Tenderness	→		DNA: 'Outstanding'	Scan: Tender				
WR	100	Wean Pct.	46%		Cow Eff.	96		HB	102	
YR	99							GM	64	
Udder	Very Good							ProS	166	

★★★★★ for Low Maintenance, Marbling, Calving Ease.

• Bulls •

128 BSF SCAMP H362 L6  1-B 99% # 4378035 Tat: BSF0 H362

Birth: 3-26-20

Beckton Scamp B720 L4
Beckton Larkaba Y448 L

BECKTON SCAMP E175 N5
Ref. S-1

Beckton Nebula T398 V3
Beckton Belga T551 EP

Beckton Likable U130 L2
Beckton Kit S478 LN

BSF HUSTELLE X278 L
BSF Hustelle U447 HH

Beckton Likable S633
Beckton HalfmannHustler R588
BSF Regus G191

BWt	62
WR	91
YWt.	970
YR	95
Feb.ADG	3.42
Feb.Scr.	35
Frame	5.5
Feet	Good

DAM									
Age	10								
Wt	915								
Prog. BW	68								
WR	107								
YR	102								
Udder	Good								
Calv.Ease	BW	WW	YW	Milk	HPG	Stay	Maint.En.		
EPDs	18	-5.6	50	86	26	11	19	-7.0	
Marb	+.43		REA	+.02		Bfat	+.03		
Beef Tenderness	→		DNA:	'Outstanding'		Scan:	Tender		
Wean Pct.	53%	Cow Eff.	111	HB	103	GM	43	ProS	146

★★★★★ for Low Maintenance, Marbling, Calving Ease.

131 BECKTON CARDINAL H421 A2  1-A 100% # 4377073 Tat: BKT0 H421

Birth: 3-28-20

TR Double Eagle ZT220
Beckton Lana U182 JC

BECKTON CARDINAL E673 L
Ref. C-1

Beckton Legend U331 E2
Beckton Larkaba T418 WA

Beckton Accent W180 C2
Beckton Christy R046 CQ

BECKTON SUFFEINA C515 A
Beckton Suffeina Y489 C

Beckton Cliffot W577 E3
Beckton Suffeina W369 N

BWt	71
WR	85
YWt.	998
YR	98
Feb.ADG	3.86
Feb.Scr.	36
Frame	5.0
Feet	Good

DAM									
Age	5								
Wt	1140								
Prog. BW	70								
WR	98								
YR	99								
Udder	Very Good								
Calv.Ease	BW	WW	YW	Milk	HPG	Stay	Maint.En.		
EPDs	18	-4.4	55	93	24	12	19	-3.0	
Marb	+.50		REA	+.06		Bfat	+.03		
Beef Tenderness	→		DNA:	'Very Good'		Scan:	Tender		
Wean Pct.	40%	Cow Eff.	84	HB	99	GM	51	ProS	150

★★★★★ for Low Maintenance, Gainability, Marbling, Calving Ease.

129 BECKTON RANGER H809 A6  1-A 100% # 4377677 Tat: BSF0 H809

Birth: 5-16-20

Beckton Ranger Z225 J4
Beckton Mona U564 JT

BECKTON RANGER B006 D5
Ref. R-1

Beckton Dominor W640 C5
Beckton Suffeina W471 W

Beckton Accent W180 C2
Beckton Cody K1 P014
Beckton Christy R046 CQ

BECKTON INDIGO Y041 A
Beckton Indigo W419 J

Beckton Jules L429
Beckton Indigo N754 HR

BWt	85
WR	113
YWt.	1128
YR	110
Feb.ADG	3.68
Feb.Scr.	37
Frame	5.5
Feet	Good

DAM									
Age	9								
Wt	1115								
Prog. BW	72								
WR	107								
YR	108								
Udder	Very Good								
Calv.Ease	BW	WW	YW	Milk	HPG	Stay	Maint.En.		
EPDs	13	-1.5	62	105	26	12	14	1.0	
Marb	+.45		REA	-.01		Bfat	+.04		
Beef Tenderness	→		DNA:	'Very Good'		Scan:	Tender		
Wean Pct.	54%	Cow Eff.	114	HB	66	GM	51	ProS	117

★★★★★ for Growth, Gainability, Marbling, Superior Cow, Calving Ease.

132 BSF DOMINOR H107 A10  1-B 99% # 4391775 Tat: BSF0 H107

Birth: 3-4-20

Beckton Dominor D254 N8
Beckton Indigo W772 N

BECKTON DOMINOR F207 A9
Ref. D-5

Beckton Larkaba D014 A
Beckton Larkaba B352 A

Beckton Accent D115 N3
Beckton Larkaba W272 N

BSF LAUREL F227 A
BSF Laurel D235 J

Beckton Julian Z382 J7
BSF Laurel U202 CQ

BWt	59
WR	98
YWt.	967
YR	96
Feb.ADG	3.11
Feb.Scr.	32
Frame	5.5
Feet	Good

DAM									
Age	2								
Wt	835								
Prog. BW	59								
WR	98								
YR	96								
Udder	Very Good								
Calv.Ease	BW	WW	YW	Milk	HPG	Stay	Maint.En.		
EPDs	18	-3.0	60	98	28	11	21	-1.0	
Marb	+.46		REA	+.11		Bfat	+.05		
Beef Tenderness	→		DNA:	'Very Good'		Scan:	Tender		
Wean Pct.	51%	Cow Eff.	107	HB	112	GM	45	ProS	157

★★★★★ for Low Maintenance, Marbling, Calving Ease.

130 BECKTON ACCENT H249 A3  1-A 100% # 4377287 Tat: BKT0 H249

Birth: 3-20-20

Beckton Cody K1 P014
Beckton Rose M126 WR

BECKTON ACCENT W180 C2
Ref. A-1

Beckton Cherokee N N479
Beckton Christy N740 HR

Beckton Accent A175 O3
Beckton Lana R214 RA

BECKTON INDIGO E653 A
Beckton Indigo A297 S

Beckton Scamp T A825
Beckton Indigo W772 N

BWt	60
WR	96
YWt.	1049
YR	106
Feb.ADG	3.99
Feb.Scr.	33
Frame	5.5
Feet	Good

DAM									
Age	3								
Wt	1105								
Prog. BW	60								
WR	96								
YR	106								
Udder	Very Good								
Calv.Ease	BW	WW	YW	Milk	HPG	Stay	Maint.En.		
EPDs	18	-4.7	62	101	27	9	22	-2.0	
Marb	+.24		REA	+.16		Bfat	+.03		
Beef Tenderness	→		DNA:	'Outstanding'		Scan:	Tender		
Wean Pct.	40%	Cow Eff.	84	HB	110	GM	29	ProS	139

★★★★★ for Low Maintenance, Growth, Gainability, Marbling, Rib-eye area, Calving Ease.

133 BSF ALLEGIANT H495 A2  1-B 99% # 4377925 Tat: BSF0 H495

Birth: 4-2-20

Halfmann Divergent C249
LSF Takeover 9943W
Beckton Eola U101 NB

HALFMANN ALLEGIANT E835
Ref. O-1

Buf Crk The Right Kind U199
Halfmann Chief DV Z707

Beckton Accent W180 C2
Beckton Cody K1 P014
Beckton Christy R046 CQ

BSF HELENA C180 A
BSF Helena X529 N

Beckton Nebula T398 V3
BSF Helena T014 JD

BWt	74
WR	94
YWt.	1024
YR	100
Feb.ADG	3.68
Feb.Scr.	34
Frame	5.0
Feet	Good

DAM									
Age	5								
Wt	1155								
Prog. BW	69								
WR	88								
YR	93								
Udder	Good								
Calv.Ease	BW	WW	YW	Milk	HPG	Stay	Maint.En.		
EPDs	15	-2.8	57	90	21	12	20	-4.0	
Marb	+.42		REA	+.01		Bfat	+.04		
Beef Tenderness	→		DNA:	'Very Good'		Scan:	Tender		
Wean Pct.	43%	Cow Eff.	91	HB	104	GM	33	ProS	137

★★★★★ for Low Maintenance, Gainability, Marbling, Calving Ease.

• Bulls •

134 BSF EPIC H027 E8 

1-B 99% # 4378287 Tat: BSF0 H027

Birth: 2-18-20

Beckton Epic Z674 E6
BECKTON EPIC F279 A7
 Ref. E-2
 Beckton Firefly B511 A

Beckton Epic U749 D5
 Beckton Indigo U504 EP

BWt 56
 WR 104
 YWt. 1026
 YR 101
 Feb.ADG 3.25
 Feb.Scr. 33
 Frame 5.0
 Feet Good

Beckton Epic Z674 E6
BSF NEBULANN F245 E
 BSF Nebulann B195 L

Beckton Epic U749 D5
 Beckton Indigo U504 EP
 Beckton Legend S670
 BSF Nebulann Y217 N

DAM		Calv.Ease	BW	WW	YW	Milk	HPG	Stay	Maint.En.	
Age	2	EPDs	18	-3.9	56	94	29	10	14	0.0
Wt	815	Marb	+.38		REA	+.05		Bfat	+.04	
Prog. BW	56	Beef Tenderness	→		DNA: 'Very Good'	Scan: Tender				
WR	104	Wean Pct.	56%		Cow Eff.	117		HB	68	
YR	101							GM	20	
Udder	Very Good							ProS	88	

★★★★★ for Low Maintenance, Marbling, High Cow Efficiency, Calving Ease.

137 BSF ACCENT H560 E3 

1-B 99% # 4377877 Tat: BSF0 H560

Birth: 4-7-20

Beckton Accent U777 C2
BECKTON ACCENT B553 L2
 Ref. A-3
 Beckton Lana X839 L

Beckton Cody K1 P014
 Beckton Susan R022 CQ

BWt 68
 WR 103
 YWt. 1089
 YR 106
 Feb.ADG 3.64
 Feb.Scr. 36
 Frame 5.0
 Feet Good

Beckton Epic A587 N7
BSF DOMINIQUE C410 E
 BSF Dominique A092 N

Beckton Epic X330 L6
 Beckton Lana W113 N
 Beckton Nebula Y002 C5
 BSF Dominique Y109 A

DAM		Calv.Ease	BW	WW	YW	Milk	HPG	Stay	Maint.En.	
Age	5	EPDs	15	-2.9	59	100	24	12	18	2.0
Wt	1100	Marb	+.40		REA	+.09		Bfat	+.03	
Prog. BW	69	Beef Tenderness	→		DNA: 'Outstanding'	Scan: Tender				
WR	100	Wean Pct.	50%		Cow Eff.	105		HB	81	
YR	104							GM	40	
Udder	Very Good							ProS	121	

★★★★★ for Growth, Gainability, Marbling, Calving Ease.

135 BECKTON ACCENT H055 A4 

1-A 100% # 4377511 Tat: BKT0 H055

Birth: 2-23-20

Beckton Accent B553 L2
BECKTON ACCENT F895 E3
 Ref. A
 Beckton Indigo U504 EP

Beckton Accent U777 C2
 Beckton Lana X839 L

BWt 52
 WR 92
 YWt. 1026
 YR 101
 Feb.ADG 3.90
 Feb.Scr. 35
 Frame 5.0
 Feet Good

Beckton Epic K6 S569
 Beckton Indigo S016 NB

Beckton Accent B150 N4
BECKTON SIERRA F882 A
 Beckton Sierra Z353 S

Beckton Accent Y260 L3
 BKT Larkeisa S055 NB
 Beckton Scamp X494 E3
 Beckton Sierra X555 N

DAM		Calv.Ease	BW	WW	YW	Milk	HPG	Stay	Maint.En.	
Age	2	EPDs	20	-6.1	52	86	28	10	16	-5.0
Wt	750	Marb	+.43		REA	-.12		Bfat	+.04	
Prog. BW	52	Beef Tenderness	→		DNA: 'Outstanding'	Scan: Tender				
WR	92	Wean Pct.	53%		Cow Eff.	111		HB	83	
YR	101							GM	36	
Udder	Good							ProS	119	

★★★★★ for Low Maintenance, Gainability, Marbling, Calving Ease.

138 BECKTON SCAMP H403 J6 

1-A 100% # 4377097 Tat: BKT0 H403

Birth: 3-27-20

Beckton Scamp B720 L4
BECKTON SCAMP E175 N5
 Ref. S-1
 Beckton Belga W103 N

Beckton Scamp X458 H3
 Beckton Larkaba Y448 L

BWt 60
 WR 85
 YWt. 1030
 YR 101
 Feb.ADG 3.95
 Feb.Scr. 41
 Frame 5.0
 Feet Good

Beckton Nebula T398 V3
 Beckton Belga T551 EP

Beckton Julian A565 J4
BECKTON BELGA C183 J
 Beckton Belga A382 N

Beckton Julian GG B571
 Beckton Belga X379 L
 Beckton Nebula P P707
 Beckton Belga K285 JL

DAM		Calv.Ease	BW	WW	YW	Milk	HPG	Stay	Maint.En.	
Age	5	EPDs	20	-8.0	45	90	24	12	17	-9.0
Wt	850	Marb	+.52		REA	-.13		Bfat	+.03	
Prog. BW	55	Beef Tenderness	→		DNA: 'Outstanding'	Scan: Tender				
WR	90	Wean Pct.	53%		Cow Eff.	112		HB	95	
YR	100							GM	68	
Udder	Very Good							ProS	163	

★★★★★ for Low Maintenance, Gainability, Marbling, Calving Ease.

136 BKB HERITAGE H135 E6 

1-B 99% # 4378329 Tat: BKB0 H135

Birth: 3-9-20

Beckton Heritage B612 J4
BECKTON HERITAGE F615 L5
 Ref. H-2
 Beckton Mona X022 L

Beckton Heritage X403 L3
 Beckton Lana N291 JC

BWt 60
 WR 112
 YWt. 1008
 YR 100
 Feb.ADG 3.11
 Feb.Scr. 34
 Frame 5.0
 Feet Good

Beckton Likable U130 L2
 Beckton Mona U584 CD

Beckton Epic A286 E7
BSF BAYBERRY F608 E
 BSF Bayberry C630 E

Beckton Epic Y484 N6
 Beckton Larkaba Y648 E
 Beckton Epic X330 L6
 BSF Bayberry Z494 W

DAM		Calv.Ease	BW	WW	YW	Milk	HPG	Stay	Maint.En.	
Age	2	EPDs	13	-4.4	64	94	26	10	13	0.0
Wt	810	Marb	+.42		REA	+.05		Bfat	+.04	
Prog. BW	60	Beef Tenderness	→		DNA: 'Outstanding'	Scan: Tender				
WR	112	Wean Pct.	61%		Cow Eff.	128		HB	53	
YR	100							GM	15	
Udder	Very Good							ProS	68	

★★★★★ for Low Maintenance, Marbling, High Cow Efficiency, Calving Ease.

139 BSF LIKABLE H561 A6 

1-B 99% # 4377875 Tat: BSF0 H561

Birth: 4-7-20

Beckton Likable Z057 L4
BECKTON LIKABLE F682 S5
 Ref. L-9
 Beckton Lana C073 S

Beckton Likable X445 J3
 Beckton Minola X107 L

BWt 68
 WR 117
 YWt. 1115
 YR 110
 Feb.ADG 3.82
 Feb.Scr. 36
 Frame 5.5
 Feet Good

Beckton Scamp A627 J4
 Beckton Lana A083 A

Beckton Accent W180 C2
BSF LANETTE F260 A
 BSF Lanette Y054 J

Beckton Cody K1 P014
 Beckton Christy R046 CQ
 Beckton Julian W743 H5
 BSF Lanette W106 N

DAM		Calv.Ease	BW	WW	YW	Milk	HPG	Stay	Maint.En.	
Age	2	EPDs	14	-3.2	68	115	25	12	20	-3.0
Wt	910	Marb	+.40		REA	+.20		Bfat	+.03	
Prog. BW	68	Beef Tenderness	→		DNA: 'Average'	Scan: Tender				
WR	117	Wean Pct.	57%		Cow Eff.	120		HB	94	
YR	110							GM	53	
Udder	-							ProS	147	

★★★★★ for Low Maintenance, Growth, Gainability, Marbling, Rib-eye area, Superior Cow, High Cow Efficiency, Calving Ease.

• Bulls •

140 BECKTON ACCENT H307 J4 1-B 99% # 4378319 Tat: BKB0 H307 

Birth: 3-23-20

Beckton Accent U777 C2
BECKTON ACCENT B818 W3 Ref. A
 Beckton Lana Y032 W

Beckton Cody K1 P014
 Beckton Susan R022 CQ
 Beckton Warrior W534 N4
 Beckton Lana W031 E

Beckton Julian Z382 J7
BSF HUSTELLE D853 J
 BSF Hustelle A787 N

Beckton Julian X721 E6
 Beckton Larkaba X064 J
 Beckton Nebula W486 D3
 BSF Hustelle W076 W

BWt	62
WR	99
YWt	1018
YR	99
Feb.ADG	3.47
Feb.Scr.	33
Frame	5.0
Feet	Good

DAM									
Age	4	Calv.Ease	BW	WW	YW	Milk	HPG	Stay	Maint.En.
Wt	1075	EPDs	18	-4.8	55	87	27	13	-3.0
Prog. BW	61	Marb	+.37		REA	-.20		Bfat	+.04
WR	103	Beef Tenderness	→		DNA: 'Outstanding'	Scan:		Tender	
YR	100	Wean Pct.	47%	Cow Eff.	99	HB	71	GM	26
Udder	Very Good	ProS	97						

★★★★★ for Low Maintenance, Marbling, Calving Ease.

143 BSF CARDINAL H489 N2 1-B 99% # 4377929 Tat: BSF0 H489 

Birth: 4-1-20

TR Double Eagle ZT220
BECKTON CARDINAL E673 L Ref. C-1
 Beckton Larkaba A911 L

TR Ricardo DOS
 Beckton Lana U182 JC
 Beckton Legend U331 E2
 Beckton Larkaba T418 WA

Beckton Nebula X096 N4
BSF CODETTE C556 N
 BSF Codette Z044 N

Beckton Nebula U206 V3
 Beckton Tamara U185 NB
 Beckton Nebula X353 E3
 BSF Codette X384 E

BWt	55
WR	107
YWt	1028
YR	100
Feb.ADG	2.94
Feb.Scr.	32
Frame	5.0
Feet	Good

DAM									
Age	5	Calv.Ease	BW	WW	YW	Milk	HPG	Stay	Maint.En.
Wt	1190	EPDs	21	-7.4	56	88	29	12	1.0
Prog. BW	58	Marb	+.55		REA	+.15		Bfat	+.03
WR	101	Beef Tenderness	→		DNA: 'Very Good'	Scan:		Tender	
YR	93	Wean Pct.	48%	Cow Eff.	101	HB	99	GM	35
Udder	Very Good	ProS	134						

★★★★★ for Marbling, Rib-eye area, Calving Ease.

141 BSF ACCENT H353 N5 1-B 99% # 4378305 Tat: BKB0 H353 

Birth: 3-25-20

Beckton Accent Y312 N3
BECKTON ACCENT C557 N4 Ref. A-4
 Beckton Minerva Y654 N

Beckton Accent U777 C2
 BKT Larkeisa S055 NB
 Beckton Nebula T398 V3
 Beckton Minerva M369 LO

Beckton Nebula T398 V3
BSF LANETTE X808 N
 BSF Lanette T717 JL

Beckton Nebula L P093
 Beckton Minerva J615 VG
 Beckton Julian G3 P608
 BSF Lanette P754

BWt	49
WR	102
YWt	992
YR	97
Feb.ADG	2.94
Feb.Scr.	39
Frame	5.0
Feet	Good

DAM									
Age	10	Calv.Ease	BW	WW	YW	Milk	HPG	Stay	Maint.En.
Wt	970	EPDs	20	-7.2	49	77	29	16	-2.0
Prog. BW	58	Marb	+.46		REA	-.06		Bfat	+.04
WR	111	Beef Tenderness	→		DNA: 'Very Good'	Scan:		Tender	
YR	103	Wean Pct.	56%	Cow Eff.	118	HB	109	GM	30
Udder	Very Good	ProS	139						

★★★★★ for Low Maintenance, Marbling, High Cow Efficiency, Calving Ease.

144 BECKTON ORACLE H188 D2 1-A 100% # 4378171 Tat: BSF0 H188 

Birth: 3-15-20

Schuler Sudden Impact 0004X
SCHULER ORACLE-7142E Ref. O-3
 Sor Marlee Cmmmtnt 0470X

Red Crowfoot Ole's Oscar
 SOR Duchess TS 8915U
 Brown Commitment S7206
 SOR Marlee Beef 4511P

Beckton Dominor A378 W7
BECKTON INDIGO D568 D
 Beckton Indigo Y041 A

Beckton Dominor Y005 V6
 Beckton Lana Y541 W
 Beckton Accent W180 C2
 Beckton Indigo W419 J

BWt	66
WR	86
YWt	980
YR	96
Feb.ADG	3.47
Feb.Scr.	35
Frame	5.0
Feet	Good

DAM									
Age	4	Calv.Ease	BW	WW	YW	Milk	HPG	Stay	Maint.En.
Wt	1270	EPDs	19	-4.1	52	92	21	12	6.0
Prog. BW	69	Marb	+.62		REA	+.21		Bfat	+.02
WR	82	Beef Tenderness	→		DNA: 'Outstanding'	Scan:		Tender	
YR	96	Wean Pct.	35%	Cow Eff.	73	HB	95	GM	66
Udder	Fair	ProS	161						

★★★★★ for Marbling, Rib-eye area, Calving Ease.

142 BSF ACCENT H100 A4 1-B 99% # 4378325 Tat: BKB0 H100 

Birth: 3-3-20

Beckton Accent U777 C2
BECKTON ACCENT B653 C3 Ref. A
 Beckton Christy W779 C

Beckton Cody K1 P014
 Beckton Susan R022 CQ
 BKT Clifftop TP R288
 Beckton Christy S151 NB

Beckton Accent B653 C3
BSF LANETTE F316 A
 BSF Lanette X808 N

Beckton Accent U777 C2
 Beckton Christy W779 C
 Beckton Nebula T398 V3
 BSF Lanette T717 JL

BWt	64
WR	100
YWt	971
YR	96
Feb.ADG	3.11
Feb.Scr.	35
Frame	5.0
Feet	Good

DAM									
Age	2	Calv.Ease	BW	WW	YW	Milk	HPG	Stay	Maint.En.
Wt	770	EPDs	16	-4.4	48	77	30	12	-5.0
Prog. BW	64	Marb	+.38		REA	-.16		Bfat	+.03
WR	100	Beef Tenderness	→		DNA: 'Outstanding'	Scan:		Tender	
YR	96	Wean Pct.	56%	Cow Eff.	118	HB	81	GM	25
Udder	Very Good	ProS	106						

★★★★★ for Low Maintenance, Marbling, High Cow Efficiency, Calving Ease.

145 BSF LIKABLE H572 L6 1-B 99% # 4377865 Tat: BSF0 H572 

Birth: 4-9-20

Beckton Likable Z057 L4
BECKTON LIKABLE B032 C5 Ref. L-2
 Beckton Mona Z270 C

Beckton Likable X445 J3
 Beckton Minola X107 L
 Beckton Clifftop W577 E3
 Beckton Mona U584 CD

Beckton Likable U120 L2
BSF CRUSITA X071 L
 BSF Crusita U036 NB

Beckton Likable S633
 Beckton Lana S718 LN
 Beckton Nebula EN S347
 BSF Crusita S081 EP

BWt	63
WR	102
YWt	1058
YR	103
Feb.ADG	3.20
Feb.Scr.	37
Frame	5.0
Feet	Good

DAM									
Age	10	Calv.Ease	BW	WW	YW	Milk	HPG	Stay	Maint.En.
Wt	920	EPDs	19	-6.3	48	90	26	12	0.0
Prog. BW	61	Marb	+.49		REA	+.06		Bfat	+.03
WR	100	Beef Tenderness	→		DNA: 'Average'	Scan:		Tender	
YR	99	Wean Pct.	59%	Cow Eff.	124	HB	88	GM	58
Udder	Very Good	ProS	146						

★★★★★ for Low Maintenance, Marbling, High Cow Efficiency, Calving Ease.

• Bulls •

146 BECKTON SCAMP H110 A6

1-A 100% # 4391767 Tat: BKT0 H110 

Birth: 3-4-20

Beckton Scamp B720 L4 < Beckton Scamp X458 H3
Beckton Larkaba Y448 L

BECKTON SCAMP F172 N5
Ref. S-2 < Beckton Nebula T398 V3
Beckton Angel X450 N < Beckton Angel T004 CT

Beckton Accent D115 N3 < Beckton Accent W180 C2
Beckton Larkaba W272 N

BECKTON VERNICE F355 A
Beckton Vernice D043 E < Beckton Epic B310 J6
Beckton Vernice B484 E

BWt	43
WR	100
YWt.	952
YR	94
Feb.ADG	2.94
Feb.Scr.	33
Frame	5.0
Feet	Good

DAM											
Age	2	Calv.Ease	BW	WW	YW	Milk	HPG	Stay	Maint.En.		
Wt	825	EPDs	19	-5.0	57	95	27	11	16	-1.0	
Prog. BW	43	Marb	+.35		REA	+.12		Bfat	+.03		
WR	100	Beef Tenderness	→		DNA:	'Outstanding'		Scan:	Tender		
YR	94	Wean Pct.	52%	Cow Eff.	110	HB	88	GM	35	ProS	123
Udder	Very Good										

★★★★★ for Low Maintenance, Marbling, Calving Ease.

149 BECKTON DOMINOR H552 J9

1-A 100% # 4376931 Tat: BKT0 H552 

Birth: 4-7-20

Beckton Dominor A378 W7 < Beckton Dominor Y005 V6
Beckton Lana Y541 W

BECKTON DOMINOR D495 W8
Ref. D-3 < Beckton Warrior T248 L5
Beckton Encino X642 W < Beckton Encino S090 JT

Beckton Julian Z382 J7 < Beckton Julian X721 E6
Beckton Larkaba X064 J

BECKTON LARKEISA D709 J
Beckton Larkeisa Z556 E < Beckton Epic X330 L6
Beckton Larkeisa X091 L

BWt	67
WR	105
YWt.	1044
YR	102
Feb.ADG	3.14
Feb.Scr.	35
Frame	5.5
Feet	Good

DAM											
Age	4	Calv.Ease	BW	WW	YW	Milk	HPG	Stay	Maint.En.		
Wt	1010	EPDs	19	-5.5	53	86	28	12	16	-1.0	
Prog. BW	65	Marb	+.39		REA	+.13		Bfat	+.03		
WR	112	Beef Tenderness	→		DNA:	'Very Good'		Scan:	Tender		
YR	107	Wean Pct.	54%	Cow Eff.	113	HB	90	GM	30	ProS	120
Udder	Very Good										

★★★★★ for Low Maintenance, Marbling, Rib-eye area, Superior Cow, Calving Ease.

147 BECKTON LIKABLE H127 A6

1-A 100% # 4377425 Tat: BKT0 H127 

Birth: 3-8-20

Beckton Likable Z057 L4 < Beckton Likable X445 J3
Beckton Minola X107 L

BECKTON LIKABLE F520 N5
Ref. L-8 < Beckton New Era Y194
Beckton Sierra A836 N < Beckton Sierra S847 WR

Beckton Accent B653 C3 < Beckton Accent U777 C2
Beckton Christy W779 C

BECKTON MONA F161 A
Beckton Mona B713 L < Beckton Legend U331 E2
Beckton Mona U564 JT

BWt	50
WR	99
YWt.	957
YR	95
Feb.ADG	3.20
Feb.Scr.	33
Frame	5.0
Feet	Good

DAM											
Age	2	Calv.Ease	BW	WW	YW	Milk	HPG	Stay	Maint.En.		
Wt	765	EPDs	16	-4.7	55	92	22	12	17	-3.0	
Prog. BW	50	Marb	+.38		REA	+.14		Bfat	+.03		
WR	99	Beef Tenderness	→		DNA:	'Outstanding'		Scan:	Tender		
YR	95	Wean Pct.	56%	Cow Eff.	118	HB	78	GM	38	ProS	116
Udder	-										

★★★★★ for Low Maintenance, Marbling, Rib-eye area, High Cow Efficiency, Calving Ease.

150 BECKTON HERITAGE H229 A6

1-A 100% # 4391765 Tat: BKT0 H229 

Birth: 3-18-20

Beckton Heritage B612 J4 < Beckton Heritage X403 L3
Beckton Lana N291 JC

BECKTON HERITAGE F615 L5
Ref. H-2 < Beckton Likable U130 L2
Beckton Mona X022 L < Beckton Mona U584 CD

Beckton Accent D115 N3 < Beckton Accent W180 C2
Beckton Larkaba W272 N

BECKTON LANA F883 A
Beckton Lana D458 N < Beckton Nebula P P707
Beckton Lana Y024 N

BWt	62
WR	113
YWt.	1026
YR	101
Feb.ADG	2.88
Feb.Scr.	35
Frame	5.5
Feet	Good

DAM											
Age	2	Calv.Ease	BW	WW	YW	Milk	HPG	Stay	Maint.En.		
Wt	795	EPDs	12	-4.0	58	87	28	11	17	-2.0	
Prog. BW	62	Marb	+.44		REA	-.04		Bfat	+.03		
WR	113	Beef Tenderness	→		DNA:	'Outstanding'		Scan:	Tender		
YR	101	Wean Pct.	62%	Cow Eff.	131	HB	77	GM	23	ProS	100
Udder	Very Good										

★★★★★ for Low Maintenance, Marbling, High Cow Efficiency, Calving Ease.

148 BECKTON JULIAN H617 A8

1-A 100% # 4391763 Tat: BKT0 H617 

Birth: 4-13-20

Beckton Julian D551 C6 < Beckton Julian X465 J5
Beckton Tamara W550 A

BECKTON JULIAN F067 L7
Ref. J-5 < Beckton Likable Z057 L4
Beckton Indigo D786 L < Beckton Indigo Y026 N

Beckton Accent D174 N3 < Beckton Accent U777 C2
BKT Larkeisa S055 NB

BECKTON COCA F035 A
Beckton Coca D139 A < Beckton Accent U777 C2
Beckton Coca Z529 A

BWt	58
WR	115
YWt.	1069
YR	106
Feb.ADG	3.55
Feb.Scr.	36
Frame	5.5
Feet	Good

DAM											
Age	2	Calv.Ease	BW	WW	YW	Milk	HPG	Stay	Maint.En.		
Wt	960	EPDs	17	-4.0	66	112	29	12	19	1.0	
Prog. BW	58	Marb	+.46		REA	-.03		Bfat	+.04		
WR	115	Beef Tenderness	→		DNA:	'Outstanding'		Scan:	Tender		
YR	106	Wean Pct.	53%	Cow Eff.	111	HB	88	GM	50	ProS	138
Udder	Very Good										

★★★★★ for Growth, Gainability, Marbling, Superior Cow, Calving Ease.



Lot 150

• Bulls •

151 BECKTON ACCENT H115 H5

1-A 100% # 4377439 Tat: BKT0 H115 

Birth: 3-5-20

Beckton Accent B653 C3
Beckton Christy W779 C

BECKTON ACCENT F194 A4
Ref. A-6

Beckton Suffeina A190 A
Beckton Suffeina Y242 N

Beckton Heritage D195 L4
Beckton Heritage A767 C3
Beckton Susan W846 L

BECKTON ROSE F509 H
Beckton Rose C681 A
Beckton Accent Y260 L3
Beckton Rose W283 J

BWt	80
WR	104
YWt	1026
YR	101
Feb.ADG	3.58
Feb.Scr.	34
Frame	5.5
Feet	Good

DAM										
Age	2	Calv.Ease	BW	WW	YW	Milk	HPG	Stay	Maint.En.	
Wt	980	EPDs	7	1.4	71	112	28	10	18	3.0
Prog. BW	80	Marb	+.47		REA	-.18		Bfat	+.04	
WR	104	Beef Tenderness	→		DNA:	'Outstanding'		Scan:	Tender	
YR	101	Wean Pct.	46%		Cow Eff.	98		HB	62	
Udder	Very Good	GM	32		ProS	94				

★★★★★ for Gainability, Marbling.

154 BECKTON DOMINOR H695 J9

1-A 100% # 4377761 Tat: BSF0 H695 

Birth: 4-24-20

Beckton Dominor A378 W7
Beckton Lana Y541 W

BECKTON DOMINOR D254 N8
Ref. D-2

Beckton Indigo W772 N
Beckton Indigo T613 JT

Beckton Justice C1 R483
Beckton Justice CH M056
Beckton Tamara J124 HR

BECKTON CHRISTY W827 J
Beckton Christy R434 CD
Beckton Cody KH M390
Beckton Christy M362 WR

BWt	59
WR	112
YWt	1092
YR	107
Feb.ADG	3.32
Feb.Scr.	36
Frame	5.5
Feet	Good

DAM										
Age	11	Calv.Ease	BW	WW	YW	Milk	HPG	Stay	Maint.En.	
Wt	1085	EPDs	22	-7.1	46	77	31	14	18	0.0
Prog. BW	62	Marb	+.44		REA	+.15		Bfat	+.04	
WR	105	Beef Tenderness	→		DNA:	'Outstanding'		Scan:	Tender	
YR	101	Wean Pct.	53%		Cow Eff.	112		HB	102	
Udder	Very Good	GM	38		ProS	140				

★★★★★ for Low Maintenance, Growth, Marbling, Rib-eye area, Calving Ease.

152 BECKTON SCAMP H399 J6

1-A 100% # 4378017 Tat: BSF0 H399 

Birth: 3-27-20

Beckton Scamp B720 L4
Beckton Larkaba Y448 L

BECKTON SCAMP E175 N5
Ref. S-1

Beckton Nebula T398 V3
Beckton Belga W103 N
Beckton Belga T551 EP

Beckton Julian W841 J5
Beckton Julian G5 S107
Beckton Christy J743 JL

BECKTON TARA Y111 J
Beckton Tara W482 L
Beckton Loki CL S284
Beckton Tara R609 JC

BWt	54
WR	100
YWt	1003
YR	98
Feb.ADG	3.19
Feb.Scr.	36
Frame	5.0
Feet	Good

DAM										
Age	9	Calv.Ease	BW	WW	YW	Milk	HPG	Stay	Maint.En.	
Wt	1100	EPDs	21	-7.9	46	83	26	13	15	-1.0
Prog. BW	68	Marb	+.36		REA	-.08		Bfat	+.04	
WR	105	Beef Tenderness	→		DNA:	'Outstanding'		Scan:	Tender	
YR	104	Wean Pct.	48%		Cow Eff.	101		HB	74	
Udder	Very Good	GM	45		ProS	119				

★★★★★ for Low Maintenance, Marbling, Superior Cow, Calving Ease.

155 BECKTON LIKABLE H330 N4

1-A 100% # 4377189 Tat: BKT0 H330 

Birth: 3-24-20

Beckton Likable U130 L2
Beckton Likable S633
Beckton Kit S478 LN

BECKTON LIKABLE D432 N3
Ref. L-3

Beckton Nebula T054 H3
Beckton Firefly W013 N
Beckton Firefly T003 JC

Beckton Nebula E P084
Beckton Nebula M045
BKT Pine Marie M119 EP

BECKTON TAMARA B443 N
Beckton Tamara Y580 E
Beckton Epic T330 L5
Beckton Tamara F658 TP

BWt	60
WR	98
YWt	987
YR	96
Feb.ADG	3.01
Feb.Scr.	33
Frame	5.5
Feet	Good

DAM										
Age	6	Calv.Ease	BW	WW	YW	Milk	HPG	Stay	Maint.En.	
Wt	1100	EPDs	19	-5.6	46	73	26	10	18	-6.0
Prog. BW	62	Marb	+.28		REA	+.05		Bfat	+.03	
WR	98	Beef Tenderness	→		DNA:	'Very Good'		Scan:	Tender	
YR	93	Wean Pct.	48%		Cow Eff.	100		HB	92	
Udder	Very Good	GM	15		ProS	107				

★★★★★ for Low Maintenance, Marbling, Calving Ease.

153 BECKTON HUGHES H663 N3

1-A 100% # 4376811 Tat: BKT0 H663 

Birth: 4-17-20

Bieber H Hughes W109
Basin Hobo 0545
Basin Rose 06T0

BECKTON HUGHES C463 N2
Ref. B-1

Beckton Lakme T689 NX
Beckton Nexus L016
Beckton Lakme M669 EP

Beckton Nebula T269 E2
Beckton Ruth M967 EP

BECKTON LAKME Z405 N
Beckton Lakme T692 EP
Beckton Epic KM M115
Beckton Lakme P513 EP

BWt	72
WR	112
YWt	1065
YR	104
Feb.ADG	3.05
Feb.Scr.	36
Frame	5.5
Feet	Good

DAM										
Age	8	Calv.Ease	BW	WW	YW	Milk	HPG	Stay	Maint.En.	
Wt	1310	EPDs	13	-2.8	60	91	28	12	18	1.0
Prog. BW	72	Marb	+.27		REA	-.04		Bfat	+.04	
WR	108	Beef Tenderness	→		DNA:	'Average'		Scan:	Tender	
YR	106	Wean Pct.	46%		Cow Eff.	96		HB	99	
Udder	Very Good	GM	6		ProS	105				

★★★★★ for Marbling, Superior Cow, Calving Ease.

156 BECKTON LIKABLE H231 D6

1-A 100% # 4377313 Tat: BKT0 H231 

Birth: 3-18-20

Beckton Likable Z057 L4
Beckton Likable X445 J3
Beckton Minola X107 L

BECKTON LIKABLE F520 N5
Ref. L-8

Beckton Sierra A836 N
Beckton New Era Y194
Beckton Sierra S847 WR

Beckton Dominor C052 E8
Beckton Dominor A378 W7
Beckton Scarlett A406 E

BECKTON CHRISTY F466 D
Beckton Christy T749 HT
Beckton Heritage N013
Beckton Christy N542 JC

BWt	60
WR	115
YWt	1069
YR	106
Feb.ADG	3.58
Feb.Scr.	36
Frame	5.5
Feet	Good

DAM										
Age	2	Calv.Ease	BW	WW	YW	Milk	HPG	Stay	Maint.En.	
Wt	900	EPDs	12	-1.8	68	111	27	10	14	1.0
Prog. BW	60	Marb	+.38		REA	+.17		Bfat	+.02	
WR	115	Beef Tenderness	→		DNA:	'Very Good'		Scan:	Tender	
YR	106	Wean Pct.	56%		Cow Eff.	118		HB	63	
Udder	Very Good	GM	45		ProS	108				

★★★★★ for Growth, Gainability, Marbling, Rib-eye area, Superior Cow, High Cow Efficiency, Calving Ease.

• Bulls •

157 BECKTON EPIC H098 E8

1-A 100% # 4377457 Tat: BKT0 H098 

Birth: 3-2-20

Beckton Epic Z674 E6
BECKTON EPIC F279 A7
 Ref. E-2 Beckton Firefly B511 A

Beckton Epic U749 D5
 Beckton Indigo U504 EP

BWt 64
 WR 106
 YWt. 1020
 YR 101
 Feb.ADG 3.27
 Feb.Scr. 32
 Frame 5.5
 Feet Good

Beckton Epic B545 N7
BECKTON EOLA F277 E
 Beckton Eola T070 DM

Beckton Epic Y484 N6
 Beckton Serena X338 N

Beckton Dominor Z1 R610
 Beckton Eola R708 DM

DAM		Calv.Ease	BW	WW	YW	Milk	HPG	Stay	Maint.En.
Age	2	EPDs	14	-0.8	68	110	28	11	13 4.0
Wt	1090	Marb	+0.40		REA	+0.34		Bfat	+0.04
Prog. BW	64	Beef Tenderness	→		DNA: 'Outstanding'	Scan:		Tender	
WR	106	Wean Pct.	43%	Cow Eff.	90	HB	59	GM	41 ProS 100
YR	101								
Udder	-								

★★★★★ for Marbling, Rib-eye area, Calving Ease.

160 BECKTON SCAMP H052 E6

1-A 100% # 4377515 Tat: BKT0 H052 

Birth: 2-23-20

Beckton Scamp B720 L4
BECKTON SCAMP F172 N5
 Ref. S-2 Beckton Angel X450 N

Beckton Scamp X458 H3
 Beckton Larkaba Y448 L

BWt 50
 WR 106
 YWt. 984
 YR 97
 Feb.ADG 3.36
 Feb.Scr. 33
 Frame 5.5
 Feet Good

Beckton Epic D344 N7
BECKTON EMERA F551 E
 Beckton Emera C142 J

Beckton Epic Z674 E6
 Beckton Larkaba Y083 N

Beckton Julian A565 J4
 Beckton Emera A250 J

DAM		Calv.Ease	BW	WW	YW	Milk	HPG	Stay	Maint.En.
Age	2	EPDs	21	-6.0	52	84	25	11	17 -2.0
Wt	805	Marb	+0.34		REA	-0.08		Bfat	+0.03
Prog. BW	50	Beef Tenderness	→		DNA: 'Outstanding'	Scan:		Tender	
WR	106	Wean Pct.	57%	Cow Eff.	121	HB	90	GM	21 ProS 111
YR	97								
Udder	Very Good								

★★★★★ for Low Maintenance, Marbling, High Cow Efficiency, Calving Ease.

158 BECKTON CARDINAL H680 N2

1-A 100% # 4376795 Tat: BKT0 H680 

Birth: 4-21-20

TR Double Eagle ZT220
BECKTON CARDINAL E673 L
 Ref. C-1 Beckton Larkaba A911 L

TR Ricardo DOS
 Beckton Lana U182 JC

BWt 64
 WR 108
 YWt. 1086
 YR 106
 Feb.ADG 3.41
 Feb.Scr. 35
 Frame 5.0
 Feet Good

Beckton Nebula A394 C5
BECKTON RUTH C165 N
 Beckton Ruth A324 D

Beckton Nebula W778 J4
 Beckton Lana T104 CT

Beckton Dominor W640 C5
 Beckton Ruth U325 WR

DAM		Calv.Ease	BW	WW	YW	Milk	HPG	Stay	Maint.En.
Age	5	EPDs	20	-6.0	63	100	25	13	18 -6.0
Wt	945	Marb	+0.55		REA	+0.26		Bfat	+0.03
Prog. BW	61	Beef Tenderness	→		DNA: 'Very Good'	Scan:		Tender	
WR	99	Wean Pct.	61%	Cow Eff.	129	HB	105	GM	50 ProS 155
YR	98								
Udder	Very Good								

★★★★★ for Low Maintenance, Growth, Marbling, Rib-eye area, High Cow Efficiency, Calving Ease.

161 BECKTON SCAMP H196 E6

1-A 100% # 4377343 Tat: BKT0 H196 

Birth: 3-16-20

Beckton Scamp B720 L4
BECKTON SCAMP E175 N5
 Ref. S-1 Beckton Belga W103 N

Beckton Scamp X458 H3
 Beckton Larkaba Y448 L

BWt 54
 WR 97
 YWt. 974
 YR 95
 Feb.ADG 3.23
 Feb.Scr. 35
 Frame 5.0
 Feet Good

Beckton Epic U749 D5
BECKTON EOLA Y412 E
 Beckton Eola T435 NB

Beckton Epic K4 N795
 Beckton Denise R308 DM

Beckton Nebula L P093
 Beckton Eola P336 CE

DAM		Calv.Ease	BW	WW	YW	Milk	HPG	Stay	Maint.En.
Age	9	EPDs	22	-8.4	42	78	25	10	16 0.0
Wt	1145	Marb	+0.29		REA	+0.07		Bfat	+0.03
Prog. BW	58	Beef Tenderness	→		DNA: 'Outstanding'	Scan:		Tender	
WR	101	Wean Pct.	45%	Cow Eff.	95	HB	77	GM	38 ProS 115
YR	98								
Udder	Very Good								

★★★★★ for Low Maintenance, Marbling, Calving Ease.

159 BECKTON DOMINOR H451 E9

1-A 100% # 4377967 Tat: BSF0 H451 

Birth: 3-30-20

Beckton Dominor A378 W7
BECKTON DOMINOR D495 W8
 Ref. D-3 Beckton Encino X642 W

Beckton Dominor Y005 V6
 Beckton Lana Y541 W

BWt 76
 WR 107
 YWt. 1032
 YR 101
 Feb.ADG 2.70
 Feb.Scr. 40
 Frame 5.5
 Feet Good

Beckton Epic B545 N7
BECKTON MINERVA D154 E
 Beckton Minerva B452 A

Beckton Epic Y484 N6
 Beckton Serena X338 N

Beckton Accent W180 C2
 Beckton Minerva Y520 J

DAM		Calv.Ease	BW	WW	YW	Milk	HPG	Stay	Maint.En.
Age	4	EPDs	16	-2.6	55	89	26	13	17 2.0
Wt	985	Marb	+0.39		REA	+0.24		Bfat	+0.03
Prog. BW	66	Beef Tenderness	→		DNA: 'Outstanding'	Scan:		Tender	
WR	106	Wean Pct.	56%	Cow Eff.	118	HB	88	GM	30 ProS 118
YR	102								
Udder	Good								

★★★★★ for Marbling, Rib-eye area, High Cow Efficiency, Calving Ease.

162 BECKTON JULIAN H331 N8

1-A 100% # 4377187 Tat: BKT0 H331 

Birth: 3-24-20

Beckton Julian X721 E6
BECKTON JULIAN Z382 J7
 Ref. J-2 Beckton Larkaba X064 J

Beckton Julian U699 L5
 Beckton Lana U329 EP

BWt 59
 WR 115
 YWt. 1018
 YR 103
 Feb.ADG 3.05
 Feb.Scr. 37
 Frame 5.5
 Feet Good

Beckton Nebula P P707
BECKTON LANA E392 N
 Beckton Lana W240 C

Beckton Nebula U699 L5
 Beckton Larkaba U475 CT

Beckton Nebula M045
 Beckton Lana M809 EP

BKT Clifftop TP R288
 Beckton Lana L923 CD

DAM		Calv.Ease	BW	WW	YW	Milk	HPG	Stay	Maint.En.
Age	3	EPDs	20	-7.2	53	79	31	11	17 -6.0
Wt	885	Marb	+0.46		REA	-0.40		Bfat	+0.05
Prog. BW	52	Beef Tenderness	→		DNA: 'Outstanding'	Scan:		Tender	
WR	115	Wean Pct.	60%	Cow Eff.	127	HB	98	GM	14 ProS 112
YR	103								
Udder	Very Good								

★★★★★ for Low Maintenance, Marbling, High Cow Efficiency, Calving Ease.

• Bulls •

163 BECKTON ACCENT H278 A4 1-A 100% # 4377247 Tat: BKT0 H278 

Birth: 3-22-20
 Beckton Accent W180 C2 < Beckton Cody K1 P014
BECKTON ACCENT E172 L3 < Beckton Christy R046 CQ
 Ref. A-5 < Beckton Likable U130 L2
 < Beckton Indigo Y406 L < Beckton Indigo R745 WR
 Beckton Accent Y260 L3 < Beckton Accent W180 C2
BECKTON LANA D614 A < Beckton Lana W463 L
 < Beckton Lana U025 LO < Beckton Loki CL S284
 < Beckton Lana S482 CT

DAM		Calv.Ease	BW	WW	YW	Milk	HPG	Stay	Maint.En.	
Age	4	EPDs	15	-3.8	53	81	25	10	21	0.0
Wt	1115	Marb	+.39		REA	+.02		Bfat	+.03	
Prog. BW	68	Beef Tenderness	→		DNA: 'Outstanding'	Scan:		Tender		
WR	98	Wean Pct.	46%		Cow Eff.	96		HB	97	
YR	99							GM	19	
Udder	Very Good							ProS	116	

★★★★★ for Low Maintenance, Marbling, Calving Ease.

166 BECKTON JULIAN H711 E8 1-A 100% # 4376755 Tat: BKT0 H711 

Birth: 4-26-20
 Beckton Julian D551 C6 < Beckton Julian X465 J5
BECKTON JULIAN F067 L7 < Beckton Tamara W550 A
 Ref. J-5 < Beckton Likable Z057 L4
 < Beckton Indigo D786 L < Beckton Indigo Y026 N
 Beckton Epic B483 N6 < Beckton Epic U749 D5
BECKTON MINERVA F424 E < BKT Pine Marie X339 N
 < Beckton Minerva W901 J < Beckton Julian G3 P608
 < Beckton Minerva L344 CH

DAM		Calv.Ease	BW	WW	YW	Milk	HPG	Stay	Maint.En.	
Age	2	EPDs	18	-3.8	66	121	30	13	13	1.0
Wt	925	Marb	+.48		REA	+.09		Bfat	+.03	
Prog. BW	57	Beef Tenderness	→		DNA: 'Outstanding'	Scan:		NA		
WR	111	Wean Pct.	53%		Cow Eff.	111		HB	68	
YR	112							GM	76	
Udder	-							ProS	144	

★★★★★ for Growth, Gainability, Marbling, Superior Cow, Calving Ease.

164 BECKTON DOMINOR H228 A10 1-A 100% # 4378129 Tat: BSF0 H228 

Birth: 3-18-20
 Beckton Dominor D254 N8 < Beckton Dominor A378 W7
BECKTON DOMINOR F207 A9 < Beckton Indigo W772 N
 Ref. D-5 < Beckton Accent B150 N4
 < Beckton Larkaba D014 A < Beckton Larkaba B352 A
 Beckton Accent B549 N3 < Beckton Accent W180 C2
BECKTON MINOLA F380 A < Beckton Minerva Y654 N
 < Beckton Minola C198 A < Beckton Accent A485 C3
 < Beckton Minola A330 S

DAM		Calv.Ease	BW	WW	YW	Milk	HPG	Stay	Maint.En.	
Age	2	EPDs	18	-3.7	59	102	26	14	20	1.0
Wt	855	Marb	+.38		REA	+.20		Bfat	+.05	
Prog. BW	60	Beef Tenderness	→		DNA: 'Outstanding'	Scan:		NA		
WR	94	Wean Pct.	47%		Cow Eff.	100		HB	112	
YR	105							GM	48	
Udder	-							ProS	160	

★★★★★ for Growth, Gainability, Marbling, Rib-eye area, Calving Ease.

167 WCRA ACCENT H161 1-A 100% # 4305921 Tat: WCRA0 HC16 

Birth: 3-15-20
 Beckton Cody K1 P014 < Beckton Cody KH M390
BECKTON ACCENT W180 C2 < Beckton Rose M126 WR
 Ref. A-1 < Beckton Cherokee N N479
 < Beckton Christy R046 CQ < Beckton Christy N740 HR
 Beckton Julian A434 N6 < Beckton Julian X465 J5
WCRA INDIGO F130 J < Beckton Lakme T689 NX
 < WCRA Indigo C 105 C < HXC Conquest 4405P
 < Beckton Indigo A143 N

DAM		Calv.Ease	BW	WW	YW	Milk	HPG	Stay	Maint.En.	
Age	2	EPDs	16	-4.1	57	88	23	12	19	3.0
Wt	848	Marb	+.43		REA	-.13		Bfat	+.03	
Prog. BW	62	Beef Tenderness	→		DNA: NA	Scan:		NA		
WR	94	Wean Pct.	59%		Cow Eff.	NA		HB	91	
YR	104							GM	21	
Udder	Very Good							ProS	112	

★★★★★ for Gainability, Marbling, Calving Ease.

165 BECKTON DOMINOR H422 R10 1-A 100% # 4377999 Tat: BSF0 H422 

Birth: 3-28-20
 Beckton Dominor D254 N8 < Beckton Dominor A378 W7
BECKTON DOMINOR F207 A9 < Beckton Indigo W772 N
 Ref. D-5 < Beckton Accent B150 N4
 < Beckton Larkaba D014 A < Beckton Larkaba B352 A
 Beckton Ranger B006 D5 < Beckton Ranger Z225 J4
BECKTON COCA F846 R < Beckton Suffeina Z731 D
 < Beckton Coca B699 E < Beckton Epic X816 C6
 < Beckton Coca Y399 L

DAM		Calv.Ease	BW	WW	YW	Milk	HPG	Stay	Maint.En.	
Age	2	EPDs	16	-2.0	57	102	27	10	16	0.0
Wt	845	Marb	+.59		REA	+.14		Bfat	+.03	
Prog. BW	66	Beef Tenderness	→		DNA: 'Outstanding'	Scan:		NA		
WR	96	Wean Pct.	49%		Cow Eff.	103		HB	80	
YR	108							GM	72	
Udder	-							ProS	152	

★★★★★ for Low Maintenance, Growth, Gainability, Marbling, Rib-eye area, Calving Ease.

168 BECKTON EPIC H238 R8 1-A 100% # 4377299 Tat: BKT0 H238 

Birth: 3-19-20
 Beckton Epic Z674 E6 < Beckton Epic U749 D5
BECKTON EPIC F279 A7 < Beckton Indigo U504 EP
 Ref. E-2 < Beckton Accent W180 C2
 < Beckton Firefly B511 A < Beckton Firefly X336 H
 Beckton Roosevelt D391 L2 < Bieber Roosevelt W384
BECKTON LANA F019 R < Beckton Indigo Y406 L
 < Beckton Lana D315 E < Beckton Epic B376 N6
 < Beckton Lana A003 N

DAM		Calv.Ease	BW	WW	YW	Milk	HPG	Stay	Maint.En.	
Age	2	EPDs	20	-4.6	54	93	27	10	15	0.0
Wt	735	Marb	+.32		REA	+.12		Bfat	+.03	
Prog. BW	52	Beef Tenderness	→		DNA: 'Outstanding'	Scan:		NA		
WR	92	Wean Pct.	54%		Cow Eff.	113		HB	75	
YR	99							GM	38	
Udder	Good							ProS	113	

★★★★★ for Low Maintenance, Gainability, Marbling, Calving Ease.

• Bulls •

169 **BECKTON SCAMP H008 L6** 

1-A 100% # 4378295 Tat: BSF0 H008
 Birth: 2-14-20
 Beckton Scamp B720 L4 < Beckton Scamp X458 H3
 Beckton Larkaba Y448 L
BECKTON SCAMP F172 N5
 Ref. S-2 < Beckton Nebula T398 V3
 Beckton Angel X450 N < Beckton Angel T004 CT
 Beckton Likable D432 N3 < Beckton Likable U130 L2
BECKTON LANA F099 L
 Beckton Lana D890 E < Beckton Firefly W013 N
 Beckton Epic Y484 N6
 Beckton Lana W113 N

BWt	54
WR	86
YWt.	969
YR	96
Feb.ADG	3.86
Feb.Scr.	32
Frame	5.0
Feet	Good

DAM		Calv.Ease	BW	WW	YW	Milk	HPG	Stay	Maint.En.		
Age	2	EPDs	20	-5.8	44	78	22	9	17	-3.0	
Wt	860	Marb	+.27		REA	-.10		Bfat	+.02		
Prog. BW	54	Beef Tenderness	→		DNA: 'Very Good'			Scan:	NA		
WR	86	Wean Pct.	42%	Cow Eff.	89	HB	87	GM	28	ProS	115
YR	96										
Udder	-										

★★★★★ for Low Maintenance, Gainability, Marbling, Calving Ease.



Lot 169



Lot 168

171 **BSF ACCENT H630 D4** 

1-B 99% # 4377817 Tat: BSF0 H630
 Birth: 4-14-20
 Beckton Accent W180 C2 < Beckton Cody K1 P014
 Beckton Christy R046 CQ
BECKTON ACCENT B549 N3
 Ref. A-2 < Beckton Nebula T398 V3
 Beckton Minerva Y654 N < Beckton Minerva M369 LO
 Beckton Dominor A378 W7 < Beckton Dominor Y005 V6
BSF LOKETTA D440 D
 Beckton Lana Y541 W
 BSF Loketta A119 N < Beckton Nebula Y002 C5
 BSF Loketta Y361 A

BWt	74
WR	91
YWt.	1004
YR	98
Feb.ADG	3.60
Feb.Scr.	36
Frame	5.0
Feet	Good

DAM		Calv.Ease	BW	WW	YW	Milk	HPG	Stay	Maint.En.		
Age	4	EPDs	17	-3.6	52	91	21	12	19	1.0	
Wt	960	Marb	+.43		REA	+.11		Bfat	+.04		
Prog. BW	70	Beef Tenderness	→		DNA: 'Very Good'			Scan:	NA		
WR	93	Wean Pct.	48%	Cow Eff.	102	HB	95	GM	45	ProS	140
YR	93										
Udder	Fair										

★★★★★ for Gainability, Marbling, Calving Ease.

170 **BECKTON LIKABLE H672 J6** 

1-A 100% # 4377781 Tat: BSF0 H672
 Birth: 4-19-20
 Beckton Likable Z057 L4 < Beckton Likable X445 J3
 Beckton Minola X107 L
BECKTON LIKABLE B032 C5
 Ref. L-2 < Beckton Clifftop W577 E3
 Beckton Mona Z270 C < Beckton Mona U584 CD
 Beckton Jet L P491 < TR Julian LT151
BECKTON ENCINO S059 JT
 Beckton Minerva L278 LN
 Beckton Herald FV J537
 Beckton Encino P871 HR < Beckton Encino G341 NP

BWt	50
WR	98
YWt.	1008
YR	98
Feb.ADG	3.29
Feb.Scr.	34
Frame	5.0
Feet	Good

DAM		Calv.Ease	BW	WW	YW	Milk	HPG	Stay	Maint.En.		
Age	14	EPDs	22	-9.0	38	68	28	12	19	1.0	
Wt	1080	Marb	+.43		REA	-.11		Bfat	+.02		
Prog. BW	60	Beef Tenderness	→		DNA: 'Very Good'			Scan:	NA		
WR	102	Wean Pct.	47%	Cow Eff.	98	HB	94	GM	36	ProS	130
YR	94										
Udder	Fair										

★★★★★ for Marbling, Calving Ease.

172 **BECKTON ACCENT H142 E5** 

1-A 100% # 4377407 Tat: BKT0 H142
 Birth: 3-10-20
 Beckton Accent B653 C3 < Beckton Accent U777 C2
 Beckton Christy W779 C
BECKTON ACCENT F194 A4
 Ref. A-6 < Beckton Accent Y260 L3
 Beckton Suffeina A190 A < Beckton Suffeina Y242 N
 Beckton Epic KM M115 < Beckton Epic K F075
BECKTON MINERVA F220 E
 Beckton Minerva F495 CH
 Beckton Accent W180 C2
 Beckton Minerva L324 LN

BWt	74
WR	85
YWt.	955
YR	94
Feb.ADG	3.64
Feb.Scr.	34
Frame	5.5
Feet	Good

DAM		Calv.Ease	BW	WW	YW	Milk	HPG	Stay	Maint.En.		
Age	2	EPDs	12	-0.9	57	91	29	10	20	4.0	
Wt	915	Marb	+.35		REA	-.23		Bfat	+.04		
Prog. BW	74	Beef Tenderness	→		DNA: 'Outstanding'			Scan:	Tender		
WR	85	Wean Pct.	39%	Cow Eff.	83	HB	87	GM	21	ProS	108
YR	94										
Udder	Good										

★★★★★ for Gainability, Marbling, Calving Ease.

• Bulls •

173 BECKTON ORACLE H267 A2 1-A 100% # 4377261 Tat: BSF0 H267



Birth: 3-21-20
 Schuler Sudden Impact 0004X Red Crowfoot Ole's Oscar
SCHULER ORACLE-7142E SOR Duchess TS 8915U
 Ref. O-3 Sor Marlee Cmmtmnt 0470X Brown Commitment S7206
 SOR Marlee Beef 4511P
 Beckton Accent W180 C2 Beckton Cody K1 P014
BECKTON LARKABA B232 A Beckton Christy R046 CQ
 Beckton Larkaba P645 JL Beckton Julian GG B571
 Beckton Larkaba L312 LN

BWt	61
WR	76
YWt.	906
YR	88
Feb.ADG	3.33
Feb.Scr.	37
Frame	5.0
Feet	Good

DAM		Calv.Ease	BW	WW	YW	Milk	HPG	Stay	Maint.En.	
Age	6	EPDs	21	-6.7	48	81	21	11	20	0.0
Wt	1165	Marb	+.66		REA	+.19		Bfat	+.02	
Prog. BW	65	Beef Tenderness	→		DNA: 'Outstanding'	Scan: NA				
WR	85	Wean Pct.	35%		Cow Eff.	73		HB	105	
YR	86							GM	62	
Udder	-							ProS	167	

★★★★★ for Low Maintenance, Marbling, Rib-eye area, Calving Ease.

176 BECKTON GENETICS H463 1-B 99% # 4377035 Tat: BKT0 H463



Birth: 3-30-20
BECKTON GENETICS MULTI SIRE
 Ref.
 Beckton Epic Y484 N6 Beckton Epic U749 D5
BECKTON SIERRA C338 E Beckton Lydia S069 NB
 Beckton Sierra W049 N Beckton Nebula T269 E2
 Beckton Sierra T224 NB

BWt	70
WR	94
YWt.	986
YR	96
Feb.ADG	3.36
Feb.Scr.	34
Frame	5.0
Feet	Good

DAM		Calv.Ease	BW	WW	YW	Milk	HPG	Stay	Maint.En.	
Age	5	EPDs	15	-2.6	45	68	22	6	11	0.5
Wt	1350	Marb	+.47		REA	+.15		Bfat	+.04	
Prog. BW	64	Beef Tenderness	→		DNA: 'Outstanding'	Scan: Tender				
WR	93	Wean Pct.	37%		Cow Eff.	78		HB	38	
YR	100							GM	68	
Udder	Very Good							ProS	106	

★★★★★ for Marbling, Rib-eye area, Calving Ease.

174 BECKTON ACCENT H293 L4 1-A 100% # 4378355 Tat: BSF0 H293



Birth: 3-22-20
 Beckton Accent W180 C2 Beckton Cody K1 P014
BECKTON ACCENT B549 N3 Beckton Christy R046 CQ
 Ref. A-2 Beckton Nebula T398 V3
 Beckton Minerva Y654 N Beckton Minerva M369 L0
 Beckton Legend S670 Beckton Lancer F442 T
BECKTON ENCINO X448 L Beckton Kit F468 JL
 Beckton Encino S059 JT Beckton Jet L P491
 Beckton Encino P871 HR

BWt	46
WR	86
YWt.	938
YR	96
Feb.ADG	3.38
Feb.Scr.	35
Frame	5.0
Feet	Good

DAM		Calv.Ease	BW	WW	YW	Milk	HPG	Stay	Maint.En.	
Age	10	EPDs	18	-4.9	53	80	23	12	21	-2.0
Wt	1200	Marb	+.39		REA	+.06		Bfat	+.02	
Prog. BW	56	Beef Tenderness	→		DNA: 'Outstanding'	Scan: NA				
WR	95	Wean Pct.	36%		Cow Eff.	75		HB	114	
YR	94							GM	19	
Udder	Very Good							ProS	133	

★★★★★ for Low Maintenance, Marbling, Calving Ease.

177 BECKTON LIKABLE H610 J4 1-A 100% # 4376871 Tat: BKT0 H610



Birth: 4-12-20
 Beckton Likable U130 L2 Beckton Likable S633
BECKTON LIKABLE D432 N3 Beckton Kit S478 LN
 Ref. L-3 Beckton Nebula T054 H3
 Beckton Firefly W013 N Beckton Firefly T003 JC
 Beckton Jet L P491 TR Julian Lt151
BECKTON ROSE C777 J Beckton Minerva L278 LN
 Beckton Rose Z247 N Beckton Nebula P P707
 Beckton Rose R507 CT

BWt	67
WR	100
YWt.	1008
YR	98
Feb.ADG	3.10
Feb.Scr.	35
Frame	5.0
Feet	Good

DAM		Calv.Ease	BW	WW	YW	Milk	HPG	Stay	Maint.En.	
Age	5	EPDs	17	-4.6	49	78	26	10	18	-5.0
Wt	1095	Marb	+.40		REA	-.01		Bfat	+.02	
Prog. BW	61	Beef Tenderness	→		DNA: 'Outstanding'	Scan: Tender				
WR	101	Wean Pct.	48%		Cow Eff.	102		HB	93	
YR	98							GM	25	
Udder	Very Good							ProS	118	

★★★★★ for Low Maintenance, Marbling, Calving Ease.

175 BECKTON NEW ERA H471 A2 1-A 100% # 4377029 Tat: BKT0 H471



Birth: 3-31-20
 Beckton Nebula P P707 Beckton Nebula M045
BECKTON NEW ERA Y194 Beckton Lana M809 EP
 Ref. N-2 BKT Larkeisa T310 JC Beckton Justice C1 R483
 BKT Larkeisa R775 JC
 Beckton Accent U777 C2 Beckton Accent B653 C3
BECKTON SUSAN D040 A Beckton Christy W779 C
 Beckton Susan B246 N Beckton New Era Y194
 Beckton Susan R022 CQ

BWt	68
WR	104
YWt.	1048
YR	102
Feb.ADG	3.50
Feb.Scr.	36
Frame	5.0
Feet	Good

DAM		Calv.Ease	BW	WW	YW	Milk	HPG	Stay	Maint.En.	
Age	4	EPDs	17	-4.0	57	91	28	13	19	-1.0
Wt	825	Marb	+.47		REA	-.13		Bfat	+.03	
Prog. BW	63	Beef Tenderness	→		DNA: 'Outstanding'	Scan: Tender				
WR	108	Wean Pct.	65%		Cow Eff.	137		HB	79	
YR	97							GM	41	
Udder	Very Good							ProS	120	

★★★★★ for Low Maintenance, Marbling, High Cow Efficiency, Calving Ease.



Lot 175

• Bulls •

178 BECKTON NEW ERA H474 E2 1-A 100% # 4377025 Tat: BKT0 H474 

Birth: 3-31-20

Beckton Nebula P P707
Beckton Lana M809 EP

BECKTON NEW ERA Y194
Ref. N-2 BKT Larkeisa T310 JC

Beckton Justice C1 R483
BKT Larkeisa R775 JC

Beckton Epic Y484 N6
Beckton Epic U749 D5

BECKTON SCARLETT D331 E
Beckton Lydia S069 NB

Beckton Jet L P491
Beckton Scarlett R808 NB

BWt	65
WR	105
YWt.	1010
YR	99
Feb.ADG	2.92
Feb.Scr.	37
Frame	5.5
Feet	Good

DAM	
Age	4
Wt	1100
Prog. BW	62
WR	113
YR	109
Udder	Very Good

Calv.Ease	BW	WW	YW	Milk	HPG	Stay	Maint.En.		
EPDs	15	-3.9	54	89	30	11	16	1.0	
Marb	+0.35		REA	-.13		Bfat		+0.03	
Beef Tenderness	→		DNA:	NA		Scan:		Tender	
Wean Pct.	49%	Cow Eff.	104	HB	63	GM	26	ProS	89

★★★★★ for Marbling, Superior Cow, Calving Ease.



Lot 178

180 BECKTON SCAMP H237 L6 1-A 100% # 4377301 Tat: BKT0 H237 

Birth: 3-19-20

Beckton Scamp B720 L4
Beckton Larkaba Y448 L

BECKTON SCAMP E175 N5
Ref. S-1 Beckton Belga W103 N

Beckton Nebula T398 V3
Beckton Belga T551 EP

Beckton Likable Z057 L4
Beckton Likable X445 J3

BECKTON MINERVA E204 L
Beckton Minola X107 L

Beckton Epic Y484 N6
Beckton Minerva Y324 N

BWt	45
WR	101
YWt.	1004
YR	101
Feb.ADG	3.41
Feb.Scr.	34
Frame	5.5
Feet	Good

DAM	
Age	3
Wt	845
Prog. BW	47
WR	94
YR	97
Udder	Very Good

Calv.Ease	BW	WW	YW	Milk	HPG	Stay	Maint.En.		
EPDs	21	-8.2	51	96	24	10	19	-3.0	
Marb	+0.34		REA	+0.09		Bfat		+0.02	
Beef Tenderness	→		DNA:	'Outstanding'		Scan:		Tender	
Wean Pct.	55%	Cow Eff.	116	HB	96	GM	57	ProS	153

★★★★★ for Low Maintenance, Marbling, High Cow Efficiency, Calving Ease.



Lot 180

179 BECKTON NEW ERA H407 N2 1-A 100% # 4377093 Tat: BKT0 H407 

Birth: 3-28-20

Beckton Nebula P P707
Beckton Lana M809 EP

BECKTON NEW ERA Y194
Ref. N-2 BKT Larkeisa T310 JC

Beckton Justice C1 R483
BKT Larkeisa R775 JC

Beckton Nebula W778 J4
Beckton Lana T104 CT

BECKTON RUTH C356 N
Beckton Nebula Y002 C5

Beckton Ruth A010 N
Beckton Ruth Y047 N

BWt	53
WR	101
YWt.	996
YR	97
Feb.ADG	3.01
Feb.Scr.	32
Frame	5.0
Feet	Good

DAM	
Age	5
Wt	930
Prog. BW	56
WR	100
YR	101
Udder	Very Good

Calv.Ease	BW	WW	YW	Milk	HPG	Stay	Maint.En.		
EPDs	20	-7.4	53	84	25	11	20	-3.0	
Marb	+0.37		REA	-.11		Bfat		+0.03	
Beef Tenderness	→		DNA:	'Outstanding'		Scan:		Tender	
Wean Pct.	58%	Cow Eff.	122	HB	90	GM	26	ProS	116

★★★★★ for Low Maintenance, Marbling, High Cow Efficiency, Calving Ease.

181 BECKTON LIKABLE H012 E5 1-A 100% # 4377563 Tat: BKT0 H012 

Birth: 2-16-20

Beckton Likable B509 J3
Beckton Likable U130 L2

BECKTON LIKABLE F816 A4
Ref. L-10 Beckton Barmaid B366 A

Beckton Coca T363 JL
Beckton Accent Y312 N3

Beckton Epic B310 J6
Beckton Epic X464 L5

BECKTON SUFFEINA F435 E
Beckton Minerva Y116 J

Beckton New Era Y194
Beckton Suffeina W489 W

BWt	57
WR	96
YWt.	959
YR	95
Feb.ADG	3.05
Feb.Scr.	34
Frame	5.5
Feet	Good

DAM	
Age	2
Wt	950
Prog. BW	57
WR	96
YR	95
Udder	Very Good

Calv.Ease	BW	WW	YW	Milk	HPG	Stay	Maint.En.		
EPDs	15	-4.0	56	90	28	12	14	-3.0	
Marb	+0.42		REA	-.11		Bfat		+0.03	
Beef Tenderness	→		DNA:	'Outstanding'		Scan:		Tender	
Wean Pct.	43%	Cow Eff.	91	HB	74	GM	33	ProS	107

★★★★★ for Low Maintenance, Marbling, Calving Ease.

• Bulls •

182 BECKTON LIKABLE H143 A7

1-A 100% # 4378207 Tat: BSF0 H143

Birth: 3-10-20

Beckton Likable B032 C5
BECKTON LIKABLE F834 L6
 Ref. L Beckton Firefly Z112 L

Beckton Likable Z057 L4
 Beckton Mona Z270 C

Beckton Lancer X250 L5
 Beckton Firefly X453 D

Beckton Accent W180 C2
BECKTON LANA F672 A
 Beckton Lana C218 S

Beckton Cody K1 P014
 Beckton Christy R046 CQ

Beckton Scamp X494 E3
 Beckton Lana S417 LN

BWt	54
WR	107
YWt.	995
YR	98
Feb.ADG	2.97
Feb.Scr.	35
Frame	5.0
Feet	Good

DAM	
Age	2
Wt	815
Prog. BW	54
WR	107
YR	98
Udder	-

Calv.Ease	BW	WW	YW	Milk	HPG	Stay	Maint.En.
EPDs	17	-5.8	51	84	27	11	18 -1.0
Marb	+.34		REA -.03		Bfat +.02		
Beef Tenderness	→		DNA: 'Outstanding'		Scan: Tender		
Wean Pct.	58%	Cow Eff.	121	HB	76	GM	30 ProS 106

185 BECKTON JULIAN H594 N9

1-A 100% # 4376889 Tat: BKT0 H594

Birth: 4-10-20

Beckton Julian Z382 J7
BECKTON JULIAN E423 N8
 Ref. J-4 Beckton Belga B004 N

Beckton Julian X721 E6
 Beckton Larkaba X064 J

Beckton Nebula Z111 N5
 Beckton Belga Z031 N

Beckton Nebula U206 V3
BECKTON COCA X084 N
 Beckton Coca U510 LN

Beckton Nebula P P707
 Beckton Minerva J615 VG

Beckton Lancer F442 T
 Beckton Coca H745 CS

BWt	60
WR	103
YWt.	1008
YR	98
Feb.ADG	3.05
Feb.Scr.	37
Frame	5.5
Feet	Good

DAM	
Age	10
Wt	1270
Prog. BW	70
WR	111
YR	105
Udder	Very Good

Calv.Ease	BW	WW	YW	Milk	HPG	Stay	Maint.En.
EPDs	18	-5.4	57	88	28	11	19 1.0
Marb	+.44		REA -.08		Bfat +.02		
Beef Tenderness	→		DNA: 'Outstanding'		Scan: Tender		
Wean Pct.	43%	Cow Eff.	91	HB	97	GM	27 ProS 124

★★★★★ for Low Maintenance, Marbling, High Cow Efficiency, Calving Ease.

★★★★★ for Marbling, Superior Cow, Calving Ease.

183 BECKTON LIKABLE H488 A4

1-A 100% # 4377011 Tat: BKT0 H488

Birth: 4-1-20

Beckton Likable U130 L2
BECKTON LIKABLE C643 L3
 Ref. L Beckton Minola X107 L

Beckton Likable S633
 Beckton Kit S478 LN

Beckton Likable U120 L2
 Beckton Minola U188 NB

Beckton Accent C557 N4
BECKTON INDIGO E705 A
 Beckton Indigo C261 E

Beckton Accent Y312 N3
 Beckton Minerva Y654 N

Beckton Epic Y484 N6
 Beckton Indigo U504 EP

BWt	66
WR	111
YWt.	1018
YR	103
Feb.ADG	3.01
Feb.Scr.	40
Frame	5.5
Feet	Good

DAM	
Age	3
Wt	935
Prog. BW	66
WR	111
YR	103
Udder	-

Calv.Ease	BW	WW	YW	Milk	HPG	Stay	Maint.En.
EPDs	13	-3.1	56	88	31	10	15 -2.0
Marb	+.69		REA +.03		Bfat +.04		
Beef Tenderness	→		DNA: 'Outstanding'		Scan: Tender		
Wean Pct.	55%	Cow Eff.	116	HB	69	GM	44 ProS 113

★★★★★ for Low Maintenance, Marbling, Calving Ease.

186 BECKTON NEBULA H494 A4

1-A 100% # 4377003 Tat: BKT0 H494

Birth: 4-2-20

Beckton Nebula E P084
BECKTON NEBULA EN S347
 Ref. N Beckton Eola P530 NB

Beckton Nebula M045
 BKT Pine Marie M119 EP

Beckton Nebula M045
 Beckton Eola M663 EP

Beckton Accent C418 L4
BECKTON LANA E188 A
 Beckton Lana C676 A

Beckton Accent Y260 L3
 Beckton Kit S545 LN

Beckton Accent Y260 L3
 Beckton Lana Z724 A

BWt	74
WR	107
YWt.	1016
YR	103
Feb.ADG	3.45
Feb.Scr.	36
Frame	5.5
Feet	Good

DAM	
Age	3
Wt	1065
Prog. BW	66
WR	107
YR	103
Udder	Good

Calv.Ease	BW	WW	YW	Milk	HPG	Stay	Maint.En.
EPDs	15	-4.5	51	75	34	11	21 -8.0
Marb	+.59		REA -.39		Bfat +.05		
Beef Tenderness	→		DNA: 'Very Good'		Scan: Tender		
Wean Pct.	46%	Cow Eff.	98	HB	99	GM	23 ProS 122

★★★★★ for Low Maintenance, Marbling, Calving Ease.

184 BECKTON ACCENT H659 N3

1-A 100% # 4377793 Tat: BSF0 H659

Birth: 4-17-20

Beckton Accent U777 C2
BECKTON ACCENT B553 L2
 Ref. A-3 Beckton Lana X839 L

Beckton Cody K1 P014
 Beckton Susan R022 CQ

Beckton Legend S670
 Beckton Lana S371 DM

Beckton Nebula T269 E2
BECKTON BARMAID X231 N
 Beckton Barmaid G565 LN

Beckton Nebula M045
 Beckton Ruth M967 EP

Beckton Lancer TA664
 Bkt Barmaid 9517 RN

BWt	62
WR	102
YWt.	1024
YR	100
Feb.ADG	3.23
Feb.Scr.	34
Frame	5.5
Feet	Good

DAM	
Age	10
Wt	980
Prog. BW	65
WR	102
YR	99
Udder	Very Good

Calv.Ease	BW	WW	YW	Milk	HPG	Stay	Maint.En.
EPDs	18	-5.9	40	67	29	11	16 -5.0
Marb	+.42		REA -.04		Bfat +.03		
Beef Tenderness	→		DNA: 'Very Good'		Scan: Tender		
Wean Pct.	55%	Cow Eff.	116	HB	73	GM	31 ProS 104

★★★★★ for Low Maintenance, Marbling, High Cow Efficiency, Calving Ease.

187 BECKTON LEGEND H425 A2

1-A 100% # 4377071 Tat: BKT0 H425

Birth: 3-28-20

Beckton Lancer F442 T
BECKTON LEGEND S670
 Ref. L Beckton Kit F468 JL

Beckton Lancer TA664
 Bkt Sufeina A828 DM

Beckton Julian GG B571
 Beckton Kit A517 NP

Beckton Accent A485 C3
BECKTON RUTH E689 A
 Beckton Ruth X041 J

Beckton Accent U777 C2
 Beckton Tamara R175 CQ

Beckton Jet U473 L2
 Beckton Ruth U557 JT

BWt	69
WR	110
YWt.	1002
YR	101
Feb.ADG	2.92
Feb.Scr.	34
Frame	5.5
Feet	Good

DAM	
Age	3
Wt	845
Prog. BW	69
WR	110
YR	101
Udder	Very Good

Calv.Ease	BW	WW	YW	Milk	HPG	Stay	Maint.En.
EPDs	15	-2.1	53	76	26	10	15 -6.0
Marb	+.47		REA +.16		Bfat +.01		
Beef Tenderness	→		DNA: 'Very Good'		Scan: Tender		
Wean Pct.	60%	Cow Eff.	127	HB	73	GM	25 ProS 98

★★★★★ for Low Maintenance, Marbling, Rib-eye area, High Cow Efficiency, Calving Ease.

• Bulls •

188 BECKTON NEBULA H521 A5 1-A 100% # 4376969 Tat: BKT0 H521 

Birth: 4-4-20

Beckton Nebula T398 V3 < Beckton Nebula L P093
Beckton Minerva J615 VQ

BECKTON NEBULA A773 L4 Ref. N-3 < Beckton Likable U130 L2
Beckton Mona X022 L < Beckton Mona U584 CD

Beckton Accent Y260 L3 < Beckton Accent W180 C2
BECKTON LANA C375 A < Beckton Lana W463 L
Beckton Lana W157 N < Beckton Nebula L P093
Beckton Lana M809 EP

BWt	75
WR	91
YWt.	988
YR	97
Feb.ADG	2.97
Feb.Scr.	41
Frame	5.5
Feet	Good

DAM	
Age	5
Wt	1090
Prog. BW	74
WR	101
YR	100
Udder	-

Calv.Ease	BW	WW	YW	Milk	HPG	Stay	Maint.En.		
EPDs	13	-2.3	61	94	28	13	25	0.0	
Marb	+.41		REA -.02		Bfat +.04				
Beef Tenderness →	DNA: 'Outstanding'		Scan: Tender						
Wean Pct.	44%	Cow Eff.	93	HB	133	GM	34	ProS	167

★★★★★ for Low Maintenance, Marbling, Calving Ease.

190 BECKTON EPIC H693 N8 1-A 100% # 4376779 Tat: BKT0 H693 

Birth: 4-23-20

Beckton Epic B483 N6 < Beckton Epic U749 D5
BKT Pine Marie X339 N

BECKTON EPIC D001 L7 Ref. E-1 < Beckton Legend U331 E2
Beckton Mona B713 L < Beckton Mona U564 JT

Beckton Nebula J R475 < Beckton Nebula M045
BECKTON ANNIE Z331 N < Beckton Larkeisa M138 JC
Beckton Annie L680 JL < Beckton Julian GG B571
Beckton Annie H113 LN

BWt	68
WR	99
YWt.	1034
YR	101
Feb.ADG	3.25
Feb.Scr.	34
Frame	5.5
Feet	Good

DAM	
Age	8
Wt	1085
Prog. BW	74
WR	103
YR	107
Udder	Very Good

Calv.Ease	BW	WW	YW	Milk	HPG	Stay	Maint.En.		
EPDs	17	-5.0	52	96	22	12	16	-5.0	
Marb	+.34		REA +.08		Bfat +.04				
Beef Tenderness →	DNA: 'Very Good'		Scan: Tender						
Wean Pct.	49%	Cow Eff.	103	HB	81	GM	42	ProS	123

★★★★★ for Low Maintenance, Marbling, Superior Cow, Calving Ease.



Lot 187

191 BSF NEW ERA H277 A2 1-B 99% # 4378103 Tat: BSF0 H277 

Birth: 3-22-20

Beckton Nebula P P707 < Beckton Nebula M045
Beckton Lana M809 EP

BECKTON NEW ERA Y194 Ref. N-2 < Beckton Justice C1 R483
BKT Larkeisa T310 JC < BKT Larkeisa R775 JC

Beckton Accent A485 C3 < Beckton Accent U777 C2
BSF HELENA C102 A < Beckton Tamara R175 CQ
BSF Helena A161 N < Beckton Nebula T269 E2
BSF Helena N151 HU

BWt	66
WR	104
YWt.	926
YR	90
Feb.ADG	2.68
Feb.Scr.	33
Frame	5.0
Feet	Good

DAM	
Age	5
Wt	905
Prog. BW	62
WR	100
YR	92
Udder	Fair

Calv.Ease	BW	WW	YW	Milk	HPG	Stay	Maint.En.		
EPDs	18	-5.3	47	69	27	12	16	-3.0	
Marb	+.40		REA -.18		Bfat +.03				
Beef Tenderness →	DNA: 'Outstanding'		Scan: Tender						
Wean Pct.	61%	Cow Eff.	129	HB	73	GM	13	ProS	86

★★★★★ for Low Maintenance, Marbling, High Cow Efficiency, Calving Ease.

189 BECKTON LIKABLE H568 N5 1-A 100% # 4377869 Tat: BSF0 H568 

Birth: 4-8-20

Beckton Likable Y124 L3 < Beckton Likable U130 L2
BKT Pine Marie S802 LO

BECKTON LIKABLE E391 N4 Ref. L-4 < Beckton Nebula T398 V3
Beckton Lana X466 N < Beckton Lana T226 NB

Beckton Nebula B046 N5 < Beckton Nebula Z180 H4
BECKTON JANE D070 N < Beckton Tamara U151 NB
Beckton Jane B220 L < Beckton Legend S670
Beckton Jane P410 NP

BWt	68
WR	104
YWt.	1006
YR	98
Feb.ADG	3.10
Feb.Scr.	32
Frame	5.5
Feet	Good

DAM	
Age	4
Wt	805
Prog. BW	56
WR	105
YR	100
Udder	Very Good

Calv.Ease	BW	WW	YW	Milk	HPG	Stay	Maint.En.		
EPDs	15	-3.6	58	84	29	12	21	-1.0	
Marb	+.39		REA -.21		Bfat +.04				
Beef Tenderness →	DNA: 'Outstanding'		Scan: Tender						
Wean Pct.	66%	Cow Eff.	139	HB	112	GM	20	ProS	132

★★★★★ for Low Maintenance, Marbling, High Cow Efficiency, Calving Ease.



Lot 189

• Bulls •

192 BECKTON CARDINAL H669 L2
1-A 100% # 4376803 Tat: BKT0 H669



Birth: 4-18-20
 TR Double Eagle ZT220
BECKTON CARDINAL E673 L
 Ref. C-1
 Beckton Larkaba A911 L
 Beckton Legend U331 E2
 Beckton Larkaba T418 WA
 Beckton Likable Y124 L3
BECKTON ROSE E499 L
 Beckton Rose X389 E
 Beckton Epic K6 S569
 Beckton Rose P015 LN

BWt	62
WR	118
YWt.	1030
YR	104
Feb.ADG	2.98
Feb.Scr.	35
Frame	5.5
Feet	Good

DAM		Calv.Ease	BW	WW	YW	Milk	HPG	Stay	Maint.En.
Age	3								
Wt	855	EPDs	21	-6.8	55	84	27	11	18 -1.0
Prog. BW	61	Marb	+.55		REA	+.17		Bfat	+0.04
WR	101	Beef Tenderness	→		DNA:	'Very Good'		Scan:	Tender
YR	104	Wean Pct.	64%	Cow Eff.	134	HB	104	GM	34 ProS 138
Udder	Very Good								

★★★★★ for Low Maintenance, Marbling, Rib-eye area, High Cow Efficiency, Calving Ease.

195 BECKTON EPIC H234 C7
1-A 100% # 4377307 Tat: BKT0 H234



Birth: 3-19-20
 Beckton Epic U749 D5
BECKTON EPIC B483 N6
 Ref. E
 BKT Pine Marie X339 N
 Beckton Epic K4 N795
 Beckton Denise R308 DM
 Beckton Nebula T269 E2
 BKT Pine Marie S467 JE
 Beckton Clifftop C201 A5
BECKTON LANA E014 C
 Beckton Lana C795 N
 Beckton Nebula P P707
 Beckton Lana Z941 W

BWt	64
WR	97
YWt.	980
YR	99
Feb.ADG	3.29
Feb.Scr.	35
Frame	5.5
Feet	Good

DAM		Calv.Ease	BW	WW	YW	Milk	HPG	Stay	Maint.En.
Age	3								
Wt	1050	EPDs	11	-2.7	55	103	31	10	13 5.0
Prog. BW	64	Marb	+.45		REA	-.12		Bfat	+0.04
WR	97	Beef Tenderness	→		DNA:	'Very Good'		Scan:	Tender
YR	99	Wean Pct.	42%	Cow Eff.	89	HB	48	GM	58 ProS 106
Udder	Fair								

★★★★★ for Marbling, Calving Ease.

193 BECKTON ACCENT H681 A4
1-A 100% # 4377771 Tat: BSF0 H681



Birth: 4-22-20
 Beckton Accent W180 C2
BECKTON ACCENT E172 L3
 Ref. A-5
 Beckton Indigo Y406 L
 Beckton Cody K1 P014
 Beckton Christy R046 CQ
 Beckton Likable U130 L2
 Beckton Indigo R745 WR
 Beckton Accent Y260 L3
BECKTON BARMAID D218 A
 Beckton Barmaid P323 HR
 Beckton Herald FV J537
 Beckton Barmaid J012 CO

BWt	60
WR	101
YWt.	1052
YR	103
Feb.ADG	3.64
Feb.Scr.	34
Frame	5.5
Feet	Good

DAM		Calv.Ease	BW	WW	YW	Milk	HPG	Stay	Maint.En.
Age	4								
Wt	1045	EPDs	16	-4.8	48	77	28	12	22 -3.0
Prog. BW	65	Marb	+.46		REA	+.01		Bfat	+0.04
WR	112	Beef Tenderness	→		DNA:	'Outstanding'		Scan:	Tender
YR	110	Wean Pct.	50%	Cow Eff.	104	HB	111	GM	29 ProS 140
Udder	Very Good								

★★★★★ for Low Maintenance, Gainability, Marbling, Superior Cow, Calving Ease.

196 BECKTON LIKABLE H032 E7
1-A 100% # 4377537 Tat: BKT0 H032



Birth: 2-19-20
 Beckton Likable B032 C5
BECKTON LIKABLE F237 E6
 Ref. L-5
 Beckton Eola Y412 E
 Beckton Likable Z057 L4
 Beckton Mona Z270 C
 Beckton Epic U749 D5
 Beckton Eola T435 NB
 Beckton Epic D002 E8
BECKTON EOLA F146 E
 Beckton Eola B014 L
 Beckton Epic B545 N7
 Beckton Christy B701 E
 Beckton Legend Z689 J3
 Beckton Eola Z574 N

BWt	55
WR	91
YWt.	943
YR	93
Feb.ADG	3.47
Feb.Scr.	34
Frame	5.0
Feet	Good

DAM		Calv.Ease	BW	WW	YW	Milk	HPG	Stay	Maint.En.
Age	2								
Wt	945	EPDs	18	-5.0	52	89	27	13	15 3.0
Prog. BW	55	Marb	+.47		REA	+.09		Bfat	+0.03
WR	91	Beef Tenderness	→		DNA:	'Very Good'		Scan:	Tender
YR	93	Wean Pct.	41%	Cow Eff.	87	HB	74	GM	52 ProS 126
Udder	-								

★★★★★ for Marbling, Calving Ease.

194 BECKTON JULIAN H372 N5
1-A 100% # 4377139 Tat: BKT0 H372



Birth: 3-26-20
 Beckton Julian GG B571
BECKTON JULIAN G3 P608
 Ref. J
 Bkt Suffeina A828 DM
 Beckton Julian 7526G
 Bkt Marta 9A13 JL
 Beckton Dominor 9455
 Bkt Suffeina 9493 TT
 Beckton Nebula C067 N5
BECKTON LARKABA E084 N
 Beckton Larkaba C061 N
 Beckton New Era A773 L4
 Beckton Marta A319 N
 Beckton New Era A395 L2
 Beckton Larkaba A804 N

BWt	64
WR	101
YWt.	999
YR	101
Feb.ADG	3.20
Feb.Scr.	35
Frame	5.5
Feet	Good

DAM		Calv.Ease	BW	WW	YW	Milk	HPG	Stay	Maint.En.
Age	3								
Wt	985	EPDs	19	-5.1	44	75	25	11	17 -5.0
Prog. BW	64	Marb	+.58		REA	-.13		Bfat	+0.02
WR	101	Beef Tenderness	→		DNA:	'Poor'		Scan:	Tender
YR	101	Wean Pct.	47%	Cow Eff.	99	HB	79	GM	44 ProS 123
Udder	Very Good								

★★★★★ for Low Maintenance, Marbling, Calving Ease.

197 BSF LIKABLE H103 H5
1-B 99% # 4378233 Tat: BSF0 H103



Birth: 3-3-20
 Beckton Likable Y124 L3
BECKTON LIKABLE F242 D4
 Ref. L-6
 Beckton Firefly A022 D
 Beckton Likable U130 L2
 BKT Pine Marie S802 LO
 Beckton Dominor W640 C5
 Beckton Firefly U801 NB
 Beckton Heritage B612 J4
BSF JUSTICIA F605 H
 BSF Justicia X006 H
 Beckton Heritage X403 L3
 Beckton Lana N291 JC
 Beckton Hasten U108 J3
 BSF Justicia U290 JC

BWt	61
WR	98
YWt.	961
YR	95
Feb.ADG	3.11
Feb.Scr.	31
Frame	5.5
Feet	Good

DAM		Calv.Ease	BW	WW	YW	Milk	HPG	Stay	Maint.En.
Age	2								
Wt	915	EPDs	18	-5.0	53	77	26	12	16 -1.0
Prog. BW	61	Marb	+.34		REA	-.09		Bfat	+0.03
WR	98	Beef Tenderness	→		DNA:	'Outstanding'		Scan:	Tender
YR	95	Wean Pct.	46%	Cow Eff.	98	HB	84	GM	7 ProS 91
Udder	-								

★★★★★ for Low Maintenance, Marbling, Calving Ease.

• Bulls •

198 BSF DOMINOR H519 S9

1-B 99% # 4377909 Tat: BSF0 H519 

Birth: 4-4-20

Beckton Dominor A378 W7 < Beckton Dominor Y005 V6
Beckton Lana Y541 W

BECKTON DOMINOR D254 N8
Ref. D-2 < Beckton Nebula T398 V3
Beckton Indigo W772 N < Beckton Indigo T613 JT

Beckton Scamp A627 J4 < Beckton Scamp X494 E3
Beckton Serena R023 JC

BSF JULESTE D584 S
Beckton Epic U749 D5
BSF Juleste Z478 E < BSF Juleste U662 CD

BWt	61
WR	95
YWt.	987
YR	96
Feb.ADG	3.03
Feb.Scr.	34
Frame	5.5
Feet	Good

DAM									
Age	4	Calv.Ease	BW	WW	YW	Milk	HPG	Stay	Maint.En.
Wt	940	EPDs	21	-6.5	42	72	28	12	16 -6.0
Prog. BW	63	Marb	+.38		REA	+.10		Bfat	+.03
WR	98	Beef Tenderness	→		DNA: 'Outstanding'	Scan:		Tender	
YR	94	Wean Pct.	52%	Cow Eff.	109	HB	88	GM	30 ProS 118
Udder	Very Good								

★★★★★ for Low Maintenance, Marbling, Calving Ease.

201 WCRA JULIAN H169

1-A 100% # 4305911 Tat: WCRA0 HC16 

Birth: 4-21-20

Beckton Julian X465 J5 < Beckton Julian G5 S107
Beckton Suffeina P643 JL

BECKTON JULIAN A434 N6
Ref. J-3 < Beckton Nexus L016
Beckton Lakme T689 NX < Beckton Lakme M669 EP

Carpenter Nebula B002 N < Beckton Nebula P P707
Beckton Rose Z266 E

WCRA PINE MARIE E122 N
WCRA Pine Marie C 108 C < HXC Conquest 4405P
BKT Pine Marie Z513 W

BWt	57
WR	108
YWt.	1000
YR	101
Feb.ADG	3.16
Feb.Scr.	35
Frame	5.5
Feet	Good

DAM									
Age	3	Calv.Ease	BW	WW	YW	Milk	HPG	Stay	Maint.En.
Wt	778	EPDs	17	-5.3	58	91	27	12	15 -1.0
Prog. BW	60	Marb	+.45		REA	-.14		Bfat	+.03
WR	98	Beef Tenderness	→		DNA: NA	Scan:		Tender	
YR	101	Wean Pct.	74%	Cow Eff.	NA	HB	72	GM	28 ProS 100
Udder	Very Good								

★★★★★ for Low Maintenance, Marbling, Calving Ease.

199 BECKTON NEBULA H529 L5

1-A 100% # 4377897 Tat: BSF0 H529 

Birth: 4-5-20

Beckton Nebula T398 V3 < Beckton Nebula L P093
Beckton Minerva J615 VG

BECKTON NEBULA A773 L4
Ref. N-3 < Beckton Likable U130 L2
Beckton Mona X022 L < Beckton Mona U584 CD

Beckton Likable Y362 L3 < Beckton Likable U130 L2
Beckton Tamara M515 LN

BECKTON ANGEL C816 L
Beckton Nebula T398 V3
Beckton Angel X450 N < Beckton Angel T004 CT

BWt	61
WR	95
YWt.	972
YR	95
Feb.ADG	2.98
Feb.Scr.	35
Frame	5.0
Feet	Good

DAM									
Age	5	Calv.Ease	BW	WW	YW	Milk	HPG	Stay	Maint.En.
Wt	940	EPDs	16	-5.3	47	73	27	11	21 -4.0
Prog. BW	62	Marb	+.38		REA	+.00		Bfat	+.03
WR	97	Beef Tenderness	→		DNA: 'Outstanding'	Scan:		Tender	
YR	97	Wean Pct.	54%	Cow Eff.	113	HB	112	GM	27 ProS 139
Udder	Very Good								

★★★★★ for Low Maintenance, Marbling, Calving Ease.

202 BECKTON ORACLE H165 A2

1-A 100% # 4377381 Tat: BKT0 H165 

Birth: 3-12-20

Schuler Sudden Impact 0004X < Red Crowfoot Ole's Oscar
SOR Duchess TS 8915U

SCHULER ORACLE-7142E
Ref. O-3 < Brown Commitment S7206
Sor Marlee Cmmmtnt 0470X < SOR Marlee Beef 4511P

Beckton Accent Y260 L3 < Beckton Accent W180 C2
Beckton Lana W463 L

BECKTON PINE MARIE D268 A
Beckton Nebula P P707
BKT Pine Marie U621 NB < BKT Pine Marie P475 LN

BWt	65
WR	82
YWt.	910
YR	89
Feb.ADG	3.03
Feb.Scr.	36
Frame	5.0
Feet	Good

DAM									
Age	4	Calv.Ease	BW	WW	YW	Milk	HPG	Stay	Maint.En.
Wt	1250	EPDs	18	-5.1	52	89	23	11	22 5.0
Prog. BW	63	Marb	+.68		REA	+.04		Bfat	+.03
WR	95	Beef Tenderness	→		DNA: 'Outstanding'	Scan:		Tender	
YR	99	Wean Pct.	33%	Cow Eff.	70	HB	106	GM	64 ProS 170
Udder	Very Good								

★★★★★ for Marbling, Calving Ease.

200 BSF LIKABLE H595 L7

1-B 99% # 4377843 Tat: BSF0 H595 

Birth: 4-10-20

Beckton Likable B032 C5 < Beckton Likable Z057 L4
Beckton Mona Z270 C

BECKTON LIKABLE F834 L6
Ref. L < Beckton Lancer X250 L5
Beckton Firefly Z112 L < Beckton Firefly X453 D

Beckton Likable B509 J3 < Beckton Likable U130 L2
Beckton Coca T363 JL

BSF JUSTICIA F849 L
Beckton Julian X721 E6
BSF Justicia Z119 J < BSF Justicia X113 J

BWt	55
WR	109
YWt.	1042
YR	103
Feb.ADG	3.55
Feb.Scr.	34
Frame	5.5
Feet	Good

DAM									
Age	2	Calv.Ease	BW	WW	YW	Milk	HPG	Stay	Maint.En.
Wt	775	EPDs	19	-5.7	52	90	29	11	18 0.0
Prog. BW	55	Marb	+.34		REA	-.01		Bfat	+.02
WR	109	Beef Tenderness	→		DNA: 'Outstanding'	Scan:		Tender	
YR	103	Wean Pct.	62%	Cow Eff.	130	HB	94	GM	39 ProS 133
Udder	Very Good								

★★★★★ for Low Maintenance, Gainability, Marbling, High Cow Efficiency, Calving Ease.

203 BECKTON HUGHES H398 E4

1-A 100% # 4377101 Tat: BKT0 H398 

Birth: 3-27-20

Beckton Hughes D589 S2 < Bieber H Hughes W109
Beckton Sierra Z353 S

BECKTON HUGHES F076 H3
Ref. B-2 < Bieber H Hughes W109
Beckton Emera D487 B < Beckton Emera A186 A

Beckton Epic A286 E7 < Beckton Epic Y484 N6
Beckton Larkaba Y648 E

BECKTON BELGA F678 E
Beckton Dominor W640 C5
Beckton Belga A562 D < Beckton Belga W405 L

BWt	56
WR	106
YWt.	1021
YR	101
Feb.ADG	3.55
Feb.Scr.	35
Frame	5.5
Feet	Good

DAM									
Age	2	Calv.Ease	BW	WW	YW	Milk	HPG	Stay	Maint.En.
Wt	785	EPDs	21	-5.6	56	94	28	10	14 -1.0
Prog. BW	56	Marb	+.36		REA	-.17		Bfat	+.04
WR	106	Beef Tenderness	→		DNA: 'Outstanding'	Scan:		Tender	
YR	101	Wean Pct.	59%	Cow Eff.	124	HB	81	GM	35 ProS 116
Udder	Very Good								

★★★★★ for Low Maintenance, Gainability, Marbling, High Cow Efficiency, Calving Ease.

• Bulls •

204 BECKTON ACCENT H791 A4 

Birth: 5-12-20
 2 100% # 4376655 Tat: BKT0 H791

Beckton Accent W180 C2 < Beckton Cody K1 P014
 Beckton Christy R046 CQ

BECKTON ACCENT D115 N3
 Ref. A < Beckton Nebula EN S347
 Beckton Larkaba W272 N < Beckton Larkaba N643 HR

Beckton Accent U777 C2 < Beckton Cody K1 P014
 Beckton Susan R022 CQ

BECKTON VERNICE D777 A
 Beckton Vernice L382 LN < Beckton Lancer TZ D525
 Beckton Vernice G373 WR

BWt	80
WR	97
YWt.	1021
YR	100
Feb.ADG	3.42
Feb.Scr.	37
Frame	5.5
Feet	Good

DAM											
Age	4	Calv.Ease	BW	WW	YW	Milk	HPG	Stay	Maint.En.		
Wt	1010	EPDs	16	-2.5	51	85	30	14	19	-4.0	
Prog. BW	68	Marb	+.33		REA	+.00		Bfat	+.04		
WR	99	Beef Tenderness	→		DNA: 'Outstanding'			Scan:	NA		
YR	107	Wean Pct.	49%	Cow Eff.	104	HB	96	GM	32	ProS	128
Udder	Very Good										

★★★★★ for Low Maintenance, Marbling, Calving Ease.

206 BECKTON SCAMP H701 W6 

Birth: 4-25-20
 1-A 100% # 4376767 Tat: BKT0 H701

Beckton Scamp B720 L4 < Beckton Scamp X458 H3
 Beckton Larkaba Y448 L

BECKTON SCAMP E175 N5
 Ref. S-1 < Beckton Nebula T398 V3
 Beckton Belga W103 N < Beckton Belga T551 EP

Beckton Warrior Y108 E5 < Beckton Warrior W534 N4
 Beckton Susan W058 E

BECKTON LANA D226 W
 Beckton Lana Z941 W < Beckton Warrior U636 J5
 Beckton Lana W208 N

BWt	70
WR	93
YWt.	957
YR	94
Feb.ADG	3.07
Feb.Scr.	34
Frame	5.0
Feet	Good

DAM											
Age	4	Calv.Ease	BW	WW	YW	Milk	HPG	Stay	Maint.En.		
Wt	1035	EPDs	18	-5.0	54	98	24	12	15	-1.0	
Prog. BW	73	Marb	+.37		REA	-.01		Bfat	+.03		
WR	104	Beef Tenderness	→		DNA: 'Outstanding'			Scan:	NA		
YR	99	Wean Pct.	46%	Cow Eff.	97	HB	76	GM	50	ProS	126
Udder	Very Good										

★★★★★ for Low Maintenance, Marbling, Calving Ease.



Lot 204

207 BECKTON ALLEGIANT H661 E2 

Birth: 4-17-20
 1-A 100% # 4377789 Tat: BSF0 H661

Halfmann Divergent C249 < LSF Takeover 9943W
 Beckton Eola U101 NB

HALFMANN ALLEGIANT E835
 Ref. O-1 < Buf Crk The Right Kind U199
 Halfmann Chief RK C258 < Halfmann Chief DV Z707

Beckton Epic X816 C6 < Beckton Epic T330 L5
 Beckton Mona R198 CQ

BECKTON INDIGO B662 E
 Beckton Indigo Y343 N < Beckton Nebula T398 V3
 Beckton Indigo H150 LN

BWt	66
WR	88
YWt.	963
YR	94
Feb.ADG	2.98
Feb.Scr.	34
Frame	5.0
Feet	Good

DAM											
Age	6	Calv.Ease	BW	WW	YW	Milk	HPG	Stay	Maint.En.		
Wt	1230	EPDs	15	-4.4	42	66	26	12	16	-2.0	
Prog. BW	73	Marb	+.43		REA	-.11		Bfat	+.04		
WR	94	Beef Tenderness	→		DNA: 'Average'			Scan:	NA		
YR	94	Wean Pct.	38%	Cow Eff.	81	HB	76	GM	24	ProS	100
Udder	Very Good										

★★★★★ for Low Maintenance, Marbling, Calving Ease.

205 BSF JULIAN H472 C9 

Birth: 3-31-20
 1-B 99% # 4377945 Tat: BSF0 H472

Beckton Julian Z382 J7 < Beckton Julian X721 E6
 Beckton Larkaba X064 J

BECKTON JULIAN E423 N8
 Ref. J-4 < Beckton Nebula Z111 N5
 Beckton Belga B004 N < Beckton Belga Z031 N

Beckton Cherokee N N479 < BFCK Cherokee Cnyn 4912
 Beckton Dinah C440 NM

BSF CHERISE T387 CQ
 BSF Regus G191 < Beckton Caesar M D023
 BSF Regus Z112

BWt	65
WR	87
YWt.	924
YR	90
Feb.ADG	3.11
Feb.Scr.	34
Frame	5.0
Feet	Good

DAM											
Age	13	Calv.Ease	BW	WW	YW	Milk	HPG	Stay	Maint.En.		
Wt	1130	EPDs	19	-6.4	44	66	28	13	16	-4.0	
Prog. BW	71	Marb	+.46		REA	-.28		Bfat	+.04		
WR	102	Beef Tenderness	→		DNA: 'Average'			Scan:	NA		
YR	102	Wean Pct.	39%	Cow Eff.	83	HB	83	GM	12	ProS	95
Udder	Good										

★★★★★ for Low Maintenance, Marbling, Calving Ease.

208 BECKTON JULIAN H290 A8 

Birth: 3-22-20
 1-A 100% # 4378095 Tat: BKT0 H290

Beckton Julian X721 E6 < Beckton Julian U699 L5
 Beckton Lana U329 EP

BECKTON JULIAN Z382 J7
 Ref. J-2 < Beckton Julian U699 L5
 Beckton Larkaba X064 J < Beckton Larkaba U475 CT

Beckton Accent A175 O3 < Beckton Accent W180 C2
 Beckton Lana R214 RA

BECKTON LANA E218 A
 Beckton Lana Z832 N < Beckton Nebula T269 E2
 Beckton Lana W113 N

BWt	58
WR	93
YWt.	945
YR	96
Feb.ADG	3.20
Feb.Scr.	34
Frame	5.0
Feet	Good

DAM											
Age	3	Calv.Ease	BW	WW	YW	Milk	HPG	Stay	Maint.En.		
Wt	1120	EPDs	20	-7.4	48	77	26	10	19	-2.0	
Prog. BW	58	Marb	+.37		REA	-.21		Bfat	+.05		
WR	93	Beef Tenderness	→		DNA: 'Outstanding'			Scan:	NA		
YR	96	Wean Pct.	38%	Cow Eff.	80	HB	100	GM	13	ProS	113
Udder	Very Good										

★★★★★ for Low Maintenance, Marbling, Calving Ease.

• Bulls •

209 BECKTON LIKABLE H696 L5
1-A 100% # 4376775 Tat: BKT0 H696



Birth: 4-24-20

Beckton Likable U130 L2
BKT Pine Marie S802 LO

BECKTON LIKABLE E391 N4
Ref. L-4

Beckton Nebula T398 V3
Beckton Lana T226 NB

Beckton Likable Y124 L3
Beckton Lana X466 N

BECKTON MINERVA D379 L

Beckton Likable Z057 L4
Beckton Minola X107 L

Beckton Minerva W662 E
Beckton Epic T330 L5
Beckton Minerva T318 JC

BWt	81
WR	98
YWt.	996
YR	97
Feb.ADG	3.03
Feb.Scr.	34
Frame	5.5
Feet	Good

DAM	
Age	4
Wt	1040
Prog. BW	67
WR	96
YR	97
Udder	Very Good

Calv.Ease	BW	WW	YW	Milk	HPG	Stay	Maint.En.	
EPDs	13	-2.2	59	98	26	11	19	1.0
Marb	+.48		REA -.08		Bfat +.03			
Beef Tenderness	→		DNA: 'Outstanding'		Scan: NA			
Wean Pct.	49%	Cow Eff.	102	HB	87	GM	55	ProS 142

★★★★★ for Marbling, Calving Ease.

212 BECKTON DOMINOR H776 L10
1-A 100% # 4377705 Tat: BSF0 H776



Birth: 5-9-20

Beckton Dominor C052 E8
Beckton Scarlett A406 E

BECKTON DOMINOR E693 D9
Ref. D-4

Beckton Dominor A378 W7
Beckton Christy C149 D

Beckton Legend S670
Beckton Lancer F442 T

BECKTON COCA C518 L

Beckton Kit F468 JL
Beckton Cherokee T450 L3
Beckton Coca T080 NB

BWt	75
WR	95
YWt.	1020
YR	100
Feb.ADG	3.51
Feb.Scr.	37
Frame	5.5
Feet	Good

DAM	
Age	5
Wt	1040
Prog. BW	63
WR	104
YR	104
Udder	-

Calv.Ease	BW	WW	YW	Milk	HPG	Stay	Maint.En.	
EPDs	18	-4.7	46	78	32	13	18	-5.0
Marb	+.57		REA +.03		Bfat +.04			
Beef Tenderness	→		DNA: 'Average'		Scan: NA			
Wean Pct.	49%	Cow Eff.	103	HB	91	GM	50	ProS 141

★★★★★ for Low Maintenance, Gainability, Marbling, Superior Cow, Calving Ease.

210 BECKTON ACCENT H621 J4
1-A 100% # 4377827 Tat: BSF0 H621



Birth: 4-13-20

Beckton Accent W180 C2
Beckton Cody K1 P014
Beckton Christy R046 CQ

BECKTON ACCENT B549 N3
Ref. A-2

Beckton Nebula T398 V3
Beckton Minerva M369 LO

Beckton Minerva Y654 N

Beckton Julian G3 P608
Beckton Julian GG B571
Bkt Suffeina A828 DM

BECKTON LARKABA U274 JL

Beckton Herald FJ J776
Beckton Larkaba G311 CT

Beckton Larkaba N708 HR

BWt	59
WR	82
YWt.	936
YR	91
Feb.ADG	3.42
Feb.Scr.	35
Frame	5.0
Feet	Good

DAM	
Age	12
Wt	975
Prog. BW	63
WR	92
YR	95
Udder	Very Good

Calv.Ease	BW	WW	YW	Milk	HPG	Stay	Maint.En.	
EPDs	18	-5.9	48	80	19	14	19	-2.0
Marb	+.42		REA -.15		Bfat +.02			
Beef Tenderness	→		DNA: 'Very Good'		Scan: NA			
Wean Pct.	43%	Cow Eff.	90	HB	91	GM	31	ProS 122

★★★★★ for Low Maintenance, Marbling, Calving Ease.

213 BECKTON CARDINAL H418 L4
1-A 100% # 4377077 Tat: BKT0 H418



Birth: 3-28-20

Beckton Cardinal D010 W2
Beckton Cardinal B074 N
Beckton Firefly B052 W

BECKTON CARDINAL F175 L3
Ref. C-2

Beckton Likable U130 L2
Beckton Larkaba X064 J

Beckton Larkaba B428 L

Beckton Likable B509 J3
Beckton Likable U130 L2
Beckton Coca T363 JL

BECKTON COCA F826 L

Beckton Julian GG B571
Beckton Coca X787 N

BWt	51
WR	94
YWt.	962
YR	95
Feb.ADG	3.42
Feb.Scr.	33
Frame	5.5
Feet	Good

DAM	
Age	2
Wt	800
Prog. BW	51
WR	94
YR	95
Udder	Very Good

Calv.Ease	BW	WW	YW	Milk	HPG	Stay	Maint.En.	
EPDs	20	-6.5	51	86	26	12	18	-7.0
Marb	+.40		REA +.10		Bfat +.03			
Beef Tenderness	→		DNA: 'Outstanding'		Scan: NA			
Wean Pct.	50%	Cow Eff.	106	HB	107	GM	41	ProS 148

★★★★★ for Low Maintenance, Marbling, Calving Ease.

211 BECKTON NEBULA H275 W2
1-A 100% # 4377251 Tat: BKT0 H275



Birth: 3-21-20

Beckton Neptune R2 K065
Beckton Belga K285 JL

BECKTON NEBULA P P707
Ref. N-1

Beckton Epic K1 K863
Beckton Lana K253 DM

Beckton Lana M809 EP

Beckton Warrior T248 L5
Beckton Kit R503 LN

BECKTON LANA Y420 W

Beckton Julian G2 M345
Beckton Lana G592 LN

Beckton Lana T211 JL

BWt	74
WR	77
YWt.	902
YR	88
Feb.ADG	3.42
Feb.Scr.	33
Frame	5.0
Feet	Good

DAM	
Age	9
Wt	1220
Prog. BW	55
WR	92
YR	98
Udder	Poor

Calv.Ease	BW	WW	YW	Milk	HPG	Stay	Maint.En.	
EPDs	17	-6.2	42	77	25	13	18	-6.0
Marb	+.56		REA -.31		Bfat +.04			
Beef Tenderness	→		DNA: 'Very Good'		Scan: NA			
Wean Pct.	34%	Cow Eff.	71	HB	97	GM	48	ProS 145

★★★★★ for Low Maintenance, Marbling, Calving Ease.



Lot 213

• Bulls •

214 BECKTON ACCENT H719 L5 1-A 100% # 4376745 Tat: BKT0 H719 

Birth: 4-27-20

Beckton Accent Y312 N3
BECKTON ACCENT C557 N4 Ref. A-4
 Beckton Minerva Y654 N
 Beckton Legend S670
BECKTON LANA X839 L
 Beckton Lana S371 DM

Beckton Accent U777 C2
 BKT Larkeisa S055 NB
 Beckton Nebula T398 V3
 Beckton Minerva M369 LO
 Beckton Lancer F442 T
 Beckton Kit F468 JL
 Beckton Dominor ZC M919
 Beckton Lana L367 LN

BWt	70
WR	91
YWt.	973
YR	95
Feb.ADG	3.20
Feb.Scr.	33
Frame	5.0
Feet	Good

DAM											
Age	10	Calv.Ease	BW	WW	YW	Milk	HPG	Stay	Maint.En.		
Wt	1055	EPDs	16	-3.6	56	91	23	13	16	-2.0	
Prog. BW	73	Marb	+.54		REA	+.11		Bfat	+.03		
WR	96	Beef Tenderness	→		DNA: 'Outstanding'			Scan:	NA		
YR	103	Wean Pct.	46%	Cow Eff.	96	HB	85	GM	55	ProS	140
Udder	Very Good										

★★★★★ for Low Maintenance, Marbling, Calving Ease.

217 BECKTON NEBULA H715 A5 1-A 100% # 4376751 Tat: BKT0 H715 

Birth: 4-27-20

Beckton Nebula T398 V3
BECKTON NEBULA A773 L4 Ref. N-3
 Beckton Mona X022 L
 Beckton Accent A175 O3
BECKTON LARKEISA E239 A
 Beckton Larkeisa Z556 E

Beckton Nebula L P093
 Beckton Minerva J615 VG
 Beckton Likable U130 L2
 Beckton Mona U584 CD
 Beckton Accent W180 C2
 Beckton Lana R214 RA
 Beckton Epic X330 L6
 Beckton Larkeisa X091 L

BWt	64
WR	103
YWt.	1007
YR	102
Feb.ADG	3.25
Feb.Scr.	35
Frame	5.5
Feet	Good

DAM											
Age	3	Calv.Ease	BW	WW	YW	Milk	HPG	Stay	Maint.En.		
Wt	930	EPDs	15	-4.1	59	94	27	11	21	1.0	
Prog. BW	61	Marb	+.35		REA	+.13		Bfat	+.03		
WR	102	Beef Tenderness	→		DNA: 'Outstanding'			Scan:	NA		
YR	101	Wean Pct.	51%	Cow Eff.	107	HB	109	GM	40	ProS	149
Udder	Very Good										

★★★★★ for Marbling, Rib-eye area, Calving Ease.

215 BECKTON ACCENT H636 L4 1-A 100% # 4376839 Tat: BKT0 H636 

Birth: 4-15-20

Beckton Accent W180 C2
BECKTON ACCENT E172 L3 Ref. A-5
 Beckton Indigo Y406 L
 Beckton Legend Z689 J3
BECKTON COCA E889 L
 Beckton Coca X433 L

Beckton Cody K1 P014
 Beckton Christy R046 CQ
 Beckton Likable U130 L2
 Beckton Indigo R745 WR
 Beckton Legend X561 J2
 Beckton Larkaba W868 J
 Beckton Loki CL S284
 Beckton Coca T419 NB

BWt	65
WR	106
YWt.	998
YR	101
Feb.ADG	3.25
Feb.Scr.	32
Frame	5.5
Feet	Good

DAM											
Age	3	Calv.Ease	BW	WW	YW	Milk	HPG	Stay	Maint.En.		
Wt	1095	EPDs	15	-3.0	57	88	24	12	18	1.0	
Prog. BW	NA	Marb	+.33		REA	+.06		Bfat	+.03		
WR	NA	Beef Tenderness	→		DNA: 'Outstanding'			Scan:	NA		
YR	NA	Wean Pct.	45%	Cow Eff.	94	HB	89	GM	20	ProS	109
Udder	-										

★★★★★ for Marbling, Calving Ease.

218 WCRA JULIAN H175 1-B 99% # 4305907 Tat: WCRA0 HC17 

Birth: 5-23-20

Beckton Julian X465 J5
BECKTON JULIAN A434 N6 Ref. J-3
 Beckton Lakme T689 NX
 Beckton New Era Y194
BSF NEBULANN E244 N
 BSF Nebulann B084 R

Beckton Julian G5 S107
 Beckton Suffeina P643 JL
 Beckton Nexus L016
 Beckton Lakme M669 EP
 Beckton Nebula P P707
 BKT Larkeisa T310 JC
 Beckton Ranger Z225 J4
 BSF Nebulann Z158 N

BWt	75
WR	86
YWt.	NA
YR	NA
Feb.ADG	3.68
Feb.Scr.	34
Frame	5.5
Feet	Good

DAM											
Age	3	Calv.Ease	BW	WW	YW	Milk	HPG	Stay	Maint.En.		
Wt	936	EPDs	14	-2.5	61	99	22	13	15	-2.0	
Prog. BW	68	Marb	+.43		REA	-.20		Bfat	+.03		
WR	83	Beef Tenderness	→		DNA: NA			Scan:	Tender		
YR	85	Wean Pct.	49%	Cow Eff.	NA	HB	74	GM	31	ProS	105
Udder	Very Good										

★★★★★ for Low Maintenance, Gainability, Marbling, Calving Ease.

216 BSF DOMINOR H360 W10 1-B 99% # 4378039 Tat: BSF0 H360 

Birth: 3-26-20

Beckton Dominor C052 E8
BECKTON DOMINOR E693 D9 Ref. D-4
 Beckton Christy C149 D
 Beckton Warrior Y108 E5
BSF LANETTE D240 W
 BSF Lanette X568 W

Beckton Dominor A378 W7
 Beckton Scarlett A406 E
 Beckton Dominor A378 W7
 Beckton Christy A234 N
 Beckton Warrior W534 N4
 Beckton Susan W058 E
 Beckton Warrior T248 L5
 BSF Lanette P615

BWt	51
WR	86
YWt.	927
YR	91
Feb.ADG	3.07
Feb.Scr.	37
Frame	5.0
Feet	Good

DAM											
Age	4	Calv.Ease	BW	WW	YW	Milk	HPG	Stay	Maint.En.		
Wt	1025	EPDs	21	-7.1	40	69	33	14	14	0.0	
Prog. BW	58	Marb	+.47		REA	-.12		Bfat	+.03		
WR	107	Beef Tenderness	→		DNA: 'Outstanding'			Scan:	NA		
YR	97	Wean Pct.	43%	Cow Eff.	90	HB	72	GM	39	ProS	111
Udder	Good										

★★★★★ for Low Maintenance, Marbling, Calving Ease.

219 BECKTON HUGHES H545 N3 1-A 100% # 4376943 Tat: BKT0 H545 

Birth: 4-6-20

Bieber H Hughes W109
BECKTON HUGHES C463 N2 Ref. B-1
 Beckton Lakme T689 NX
 Beckton Nebula P P707
BECKTON EMERA C459 N
 Beckton Emera Y196 W

Basin Hobo 0545
 Basin Rose 06T0
 Beckton Nexus L016
 Beckton Lakme M669 EP
 Beckton Nebula M045
 Beckton Lana M809 EP
 Beckton Warrior T248 L5
 Beckton Emera P378 LN

BWt	53
WR	95
YWt.	982
YR	96
Feb.ADG	3.16
Feb.Scr.	34
Frame	4.5
Feet	Good

DAM											
Age	5	Calv.Ease	BW	WW	YW	Milk	HPG	Stay	Maint.En.		
Wt	1090	EPDs	17	-6.0	55	88	24	14	18	-1.0	
Prog. BW	61	Marb	+.42		REA	-.09		Bfat	+.04		
WR	99	Beef Tenderness	→		DNA: 'Outstanding'			Scan:	Tender		
YR	101	Wean Pct.	46%	Cow Eff.	97	HB	107	GM	29	ProS	136
Udder	Very Good										

★★★★★ for Low Maintenance, Marbling, Calving Ease.

• Bulls •

220 BECKTON EPIC H724 H8

1-A 100% # 4377739 Tat: BSF0 H724 

Birth: 4-28-20

Beckton Epic B483 N6
BECKTON EPIC D001 L7
 Ref. E-1
 Beckton Mona B713 L

Beckton Epic U749 D5
 BKT Pine Marie X339 N

Beckton Legend U331 E2
 Beckton Mona U564 JT

Beckton Hasten H S462
BECKTON ENCINO W675 H
 Beckton Encino S090 JT

Beckton Hasten P292
 Beckton Lakme G128 HD
 Beckton Jet L P491
 Beckton Encino P300 LN

BWt	74
WR	110
YWt.	1033
YR	101
Feb.ADG	2.76
Feb.Scr.	33
Frame	5.5
Feet	Good

DAM										
Age	11	Calv.Ease	BW	WW	YW	Milk	HPG	Stay	Maint.En.	
Wt	1040	EPDs	16	-4.8	53	86	27	12	17	-4.0
Prog. BW	71	Marb	+.29		REA	+.09		Bfat	+.03	
WR	100	Beef Tenderness	→		DNA: 'Outstanding'			Scan:	Tender	
YR	99	Wean Pct.	55%		Cow Eff.	115		HB	93	
Udder	Very Good	GM	17		ProS	110				

★★★★★ for Low Maintenance, Marbling, Calving Ease.

223 BECKTON ACCENT H712 L5

1-A 100% # 4377749 Tat: BSF0 H712 

Birth: 4-26-20

Beckton Accent Y312 N3
BECKTON ACCENT C557 N4
 Ref. A-4
 Beckton Minerva Y654 N

Beckton Accent U777 C2
 BKT Larkeisa S055 NB

Beckton Nebula T398 V3
 Beckton Minerva M369 LO

Beckton Likable U130 L2
BECKTON LANA D689 L
 Beckton Lana X122 L

Beckton Likable S633
 Beckton Kit S478 LN
 Beckton Likable U130 L2
 Beckton Lana U748 JL

BWt	62
WR	102
YWt.	1021
YR	100
Feb.ADG	3.29
Feb.Scr.	36
Frame	5.0
Feet	Good

DAM										
Age	4	Calv.Ease	BW	WW	YW	Milk	HPG	Stay	Maint.En.	
Wt	1040	EPDs	17	-4.9	56	87	25	14	16	-3.0
Prog. BW	60	Marb	+.52		REA	+.19		Bfat	+.04	
WR	98	Beef Tenderness	→		DNA: 'Outstanding'			Scan:	Tender	
YR	98	Wean Pct.	51%		Cow Eff.	106		HB	96	
Udder	Very Good	GM	42		ProS	138				

★★★★★ for Low Maintenance, Marbling, Rib-eye area, Calving Ease.

221 BECKTON RANGER H706 J6

1-A 100% # 4376761 Tat: BKT0 H706 

Birth: 4-26-20

Beckton Ranger Z225 J4
BECKTON RANGER B006 D5
 Ref. R-1
 Beckton Suffeina Z731 D

Beckton Ranger T603 H3
 Beckton Mona U564 JT

Beckton Dominor W640 C5
 Beckton Suffeina W471 W

Beckton Julian GG B571
BECKTON SUSAN A251 J
 Beckton Susan X199 L

Beckton Julian 7526G
 Bkt Marta 9A13 JL
 Beckton Loki CL S284
 Beckton Susan R022 CQ

BWt	57
WR	106
YWt.	1014
YR	99
Feb.ADG	3.07
Feb.Scr.	36
Frame	5.5
Feet	Good

DAM										
Age	7	Calv.Ease	BW	WW	YW	Milk	HPG	Stay	Maint.En.	
Wt	1140	EPDs	19	-5.8	53	88	28	12	13	-2.0
Prog. BW	64	Marb	+.47		REA	+.04		Bfat	+.03	
WR	95	Beef Tenderness	→		DNA: 'Outstanding'			Scan:	Tender	
YR	101	Wean Pct.	50%		Cow Eff.	105		HB	63	
Udder	Very Good	GM	46		ProS	109				

★★★★★ for Low Maintenance, Marbling, Calving Ease.

224 BECKTON LIKABLE H687 D4

1-A 100% # 4377765 Tat: BSF0 H687 

Birth: 4-22-20

Beckton Likable U130 L2
BECKTON LIKABLE D432 N3
 Ref. L-3
 Beckton Firefly W013 N

Beckton Likable S633
 Beckton Kit S478 LN

Beckton Nebula T054 H3
 Beckton Firefly T003 JC

Beckton Dominor A378 W7
BECKTON LARKABEL D646 D
 Beckton Larkabel A015 A

Beckton Dominor Y005 V6
 Beckton Lana Y541 W
 Beckton Accent Y260 L3
 Beckton Larkabel Y487 A

BWt	59
WR	103
YWt.	1007
YR	98
Feb.ADG	2.85
Feb.Scr.	37
Frame	5.0
Feet	Good

DAM										
Age	4	Calv.Ease	BW	WW	YW	Milk	HPG	Stay	Maint.En.	
Wt	905	EPDs	20	-5.8	46	77	28	12	19	-7.0
Prog. BW	58	Marb	+.41		REA	+.08		Bfat	+.04	
WR	106	Beef Tenderness	→		DNA: 'Very Good'			Scan:	Tender	
YR	104	Wean Pct.	58%		Cow Eff.	123		HB	111	
Udder	Very Good	GM	40		ProS	151				

★★★★★ for Low Maintenance, Marbling, Superior Cow, High Cow Efficiency, Calving Ease.

222 BECKTON GENETICS H591

1-B 99% # 4376891 Tat: BKT0 H591 

Birth: 4-10-20

Beckton Genetics Multi Sire
 Ref.

Beckton Legend S670
BECKTON FREYJA A425 L
 Beckton Freyja U464 JC

Beckton Lancer F442 T
 Beckton Kit F468 JL

Beckton Justice C1 R483
 Beckton Freyja M659 WR

BWt	57
WR	97
YWt.	961
YR	94
Feb.ADG	3.11
Feb.Scr.	36
Frame	5.0
Feet	Good

DAM										
Age	7	Calv.Ease	BW	WW	YW	Milk	HPG	Stay	Maint.En.	
Wt	1160	EPDs	18	-5.3	41	59	20	8	13	-2.5
Prog. BW	62	Marb	+.45		REA	+.27		Bfat	+.03	
WR	98	Beef Tenderness	→		DNA: 'Very Good'			Scan:	Tender	
YR	102	Wean Pct.	44%		Cow Eff.	93		HB	51	
Udder	Very Good	GM	54		ProS	105				

★★★★★ for Low Maintenance, Marbling, Rib-eye area, Calving Ease.

225 BECKTON CARDINAL H540 S2

1-A 100% # 4376945 Tat: BKT0 H540 

Birth: 4-5-20

TR Double Eagle ZT220
BECKTON CARDINAL E673 L
 Ref. C-1
 Beckton Larkaba A911 L

TR Ricardo DOS
 Beckton Lana U182 JC

Beckton Legend U331 E2
 Beckton Larkaba T418 WA

Beckton Scamp A626 H3
BECKTON COCA C492 S
 Beckton Coca A559 E

Beckton Rose T770 HI
 Beckton Epic X330 L6
 Beckton Coca W061 N

BWt	48
WR	94
YWt.	960
YR	94
Feb.ADG	3.20
Feb.Scr.	32
Frame	5.0
Feet	Good

DAM										
Age	5	Calv.Ease	BW	WW	YW	Milk	HPG	Stay	Maint.En.	
Wt	990	EPDs	22	-8.5	52	87	27	11	16	-1.0
Prog. BW	57	Marb	+.45		REA	+.15		Bfat	+.04	
WR	100	Beef Tenderness	→		DNA: 'Outstanding'			Scan:	Tender	
YR	103	Wean Pct.	51%		Cow Eff.	107		HB	87	
Udder	Very Good	GM	38		ProS	125				

★★★★★ for Low Maintenance, Marbling, Rib-eye area, Calving Ease.

• Bulls •

226 BECKTON ORACLE H345 L2 1-A 100% # 4377171 Tat: BKT0 H345 

Birth: 3-25-20

SCHULER ORACLE-7142E
Ref. O-3

Beckton Legend S670
Beckton Belga K285 JL

Red Crowfoot Ole's Oscar
SOR Duchess TS 8915U
Brown Commitment S7206
SOR Marlee Beef 4511P

Beckton Lancer F442 T
Beckton Kit F468 JL
Beckton Julian GG B571
Beckton Belga G493 HR

BWt	59
WR	91
YWt.	942
YR	92
Feb.ADG	2.94
Feb.Scr.	34
Frame	5.0
Feet	Good

DAM	
Age	4
Wt	985
Prog. BW	57
WR	93
YR	91
Udder	Very Good

Calv.Ease	BW	WW	YW	Milk	HPG	Stay	Maint.En.
EPDs	20	-6.2	47	75	24	12	21 -1.0
Marb	+.60		REA +.19		Bfat +.02		
Beef Tenderness	→		DNA: 'Outstanding'		Scan: Tender		
Wean Pct.	47%	Cow Eff.	99	HB	111	GM	48 ProS 159

★★★★★ for Low Maintenance, Marbling, Rib-eye area, Calving Ease.

229 BECKTON LIKABLE H120 E7 1-A 100% # 4377433 Tat: BKT0 H120 

Birth: 3-7-20

BECKTON LIKABLE F834 L6
Ref. L

Beckton Epic B545 N7
Beckton Rose Z419 J

Beckton Likable B032 C5
Beckton Mona Z270 C
Beckton Lancer X250 L5
Beckton Firefly Z112 L
Beckton Epic Y484 N6
Beckton Serena X338 N
Beckton Julian GG B571
Beckton Rose W833 N

BWt	70
WR	98
YWt.	959
YR	95
Feb.ADG	3.33
Feb.Scr.	32
Frame	5.5
Feet	Good

DAM	
Age	2
Wt	865
Prog. BW	70
WR	98
YR	95
Udder	Very Good

Calv.Ease	BW	WW	YW	Milk	HPG	Stay	Maint.En.
EPDs	11	-3.3	55	98	24	12	14 1.0
Marb	+.31		REA +.09		Bfat +.02		
Beef Tenderness	→		DNA: 'Outstanding'		Scan: Tender		
Wean Pct.	49%	Cow Eff.	103	HB	44	GM	35 ProS 79

★★★★★ for Marbling, Calving Ease.

227 BECKTON ACCENT H413 A3 1-A 100% # 4377085 Tat: BKT0 H413 

Birth: 3-28-20

BECKTON ACCENT B553 L2
Ref. A-3

Beckton Accent U777 C2
Beckton Firefly W021 H

Beckton Cody K1 P014
Beckton Susan R022 CQ
Beckton Legend S670
Beckton Lana S371 DM
Beckton Cody K1 P014
Beckton Susan R022 CQ
Beckton Heritage T270 J2
Beckton Firefly T028 JR

BWt	70
WR	92
YWt.	912
YR	89
Feb.ADG	2.72
Feb.Scr.	32
Frame	5.0
Feet	Good

DAM	
Age	4
Wt	1095
Prog. BW	71
WR	99
YR	95
Udder	Very Good

Calv.Ease	BW	WW	YW	Milk	HPG	Stay	Maint.En.
EPDs	14	-2.3	53	83	27	13	15 -1.0
Marb	+.43		REA +.02		Bfat +.03		
Beef Tenderness	→		DNA: 'Very Good'		Scan: Tender		
Wean Pct.	43%	Cow Eff.	90	HB	65	GM	27 ProS 92

★★★★★ for Low Maintenance, Marbling, Calving Ease.

230 BECKTON HUGHES H700 H3 1-A 100% # 4376769 Tat: BKT0 H700 

Birth: 4-25-20

BECKTON HUGHES C463 N2
Ref. B-1

Beckton Heritage X403 L3
Beckton Indigo W165 N

Bieber H Hughes W109
Beckton Lakme T689 NX
Beckton Nexus L016
Beckton Lakme M669 EP
Beckton Heritage T270 J2
Beckton Indigo H150 LN
Beckton Nebula T398 V3
Beckton Indigo T298 JM

BWt	68
WR	104
YWt.	938
YR	92
Feb.ADG	2.54
Feb.Scr.	37
Frame	5.0
Feet	Good

DAM	
Age	8
Wt	1130
Prog. BW	66
WR	106
YR	96
Udder	Good

Calv.Ease	BW	WW	YW	Milk	HPG	Stay	Maint.En.
EPDs	15	-4.5	58	81	27	12	16 -1.0
Marb	+.34		REA -.05		Bfat +.04		
Beef Tenderness	→		DNA: 'Very Good'		Scan: Tender		
Wean Pct.	49%	Cow Eff.	103	HB	91	GM	4 ProS 95

★★★★★ for Low Maintenance, Marbling, Calving Ease.

228 BECKTON LIKABLE H320 J6 1-A 100% # 4378071 Tat: BSF0 H320 

Birth: 3-24-20

BECKTON LIKABLE B032 C5
Ref. L-2

Beckton Janus X799 L2
Beckton Encino W675 H

Beckton Likable X445 J3
Beckton Minola X107 L
Beckton Clifftop W577 E3
Beckton Mona U584 CD
Beckton Roman J S158
Beckton Sierra K557 LO
Beckton Hasten H S462
Beckton Encino S090 JT

BWt	40
WR	90
YWt.	900
YR	92
Feb.ADG	3.11
Feb.Scr.	34
Frame	5.0
Feet	Good

DAM	
Age	5
Wt	NA
Prog. BW	53
WR	99
YR	96
Udder	Good

Calv.Ease	BW	WW	YW	Milk	HPG	Stay	Maint.En.
EPDs	17	-5.4	48	90	25	12	19 1.0
Marb	+.39		REA -.03		Bfat +.02		
Beef Tenderness	→		DNA: 'Outstanding'		Scan: Tender		
Wean Pct.	NA%	Cow Eff.	NA	HB	83	GM	50 ProS 133

★★★★★ for Marbling, Calving Ease.

231 BECKTON RANGER H573 D6 1-A 100% # 4376911 Tat: BKT0 H573 

Birth: 4-9-20

BECKTON RANGER B006 D5
Ref. R-1

Beckton Dominor C052 E8
Beckton Maiata C893 N

Beckton Ranger Z225 J4
Beckton Suffeina Z731 D
Beckton Ranger T603 H3
Beckton Mona U564 JT
Beckton Dominor W640 C5
Beckton Suffeina W471 W
Beckton Dominor A378 W7
Beckton Scarlett A406 E
Beckton Nebula X096 N4
Beckton Maiata U518 JL

BWt	64
WR	107
YWt.	965
YR	98
Feb.ADG	3.07
Feb.Scr.	32
Frame	5.5
Feet	Good

DAM	
Age	3
Wt	755
Prog. BW	54
WR	107
YR	98
Udder	Very Good

Calv.Ease	BW	WW	YW	Milk	HPG	Stay	Maint.En.
EPDs	16	-4.2	52	85	29	12	13 -1.0
Marb	+.56		REA -.09		Bfat +.04		
Beef Tenderness	→		DNA: 'Poor'		Scan: Tender		
Wean Pct.	66%	Cow Eff.	138	HB	60	GM	52 ProS 112

★★★★★ for Low Maintenance, Marbling, High Cow Efficiency, Calving Ease.

• Bulls •

232 BECKTON NEBULA H769 J5 1-A 100% # 4376677 Tat: BKT0 H769 

Birth: 5-6-20
 Beckton Nebula T398 V3 < Beckton Nebula L P093
 Beckton Minerva J615 VG
BECKTON NEBULA A773 L4
 Ref. N-3 < Beckton Mona X022 L < Beckton Likable U130 L2
 Beckton Mona U584 CD
BECKTON LARKABA B903 J
 Beckton Julian Z360 W4 < Beckton Julian GG B571
 Beckton Ruth U325 WR
 Beckton Larkaba Z948 N < Beckton Nebula W022 D3
 Beckton Larkaba U498 EP

BWt	67
WR	109
YWt.	980
YR	96
Feb.ADG	2.63
Feb.Scr.	33
Frame	5.0
Feet	Good

DAM	
Age	6
Wt	1075
Prog. BW	70
WR	115
YR	106
Udder	Very Good
Calv.Ease	
EPDs	13 -2.4 61 94 30 13 21 4.0
Marb	+0.29
Beef Tenderness	→
Wean Pct.	54%
Cow Eff.	113
HB	111
GM	18
ProS	129
RE A	+0.15
DNA	'Very Good'
Scan	Tender
Bfat	+0.03

★★★★★ for Marbling, Rib-eye area, Superior Cow, Calving Ease.

234 BECKTON SCAMP H125 N6 1-A 100% # 4378219 Tat: BSF0 H125 

Birth: 3-8-20
 Beckton Scamp B720 L4 < Beckton Scamp X458 H3
 Beckton Larkaba Y448 L
BECKTON SCAMP F172 N5
 Ref. S-2 < Beckton Nebula T398 V3
 Beckton Angel T004 CT
 Beckton Angel X450 N < Beckton New Era Y194
 Beckton New Era D478 C2 < Beckton Coca X734 C
BECKTON MINOLA F010 N
 Beckton Minola D350 A < Beckton Accent U777 C2
 Beckton Minola S464 EP

BWt	62
WR	112
YWt.	986
YR	97
Feb.ADG	2.88
Feb.Scr.	35
Frame	5.0
Feet	Good

DAM	
Age	2
Wt	855
Prog. BW	62
WR	112
YR	97
Udder	Very Good
Calv.Ease	
EPDs	19 -4.8 55 89 27 10 17 -1.0
Marb	+0.37
Beef Tenderness	→
Wean Pct.	58%
Cow Eff.	121
HB	86
GM	27
ProS	113
RE A	-0.08
DNA	'Outstanding'
Scan	Tender
Bfat	+0.03

★★★★★ for Low Maintenance, Marbling, High Cow Efficiency, Calving Ease.

233 BECKTON LIKABLE H192 S6 1-A 100% # 4378167 Tat: BSF0 H192 

Birth: 3-16-20
 Beckton Likable Z057 L4 < Beckton Likable X445 J3
 Beckton Minola X107 L
BECKTON LIKABLE F682 S5
 Ref. L-9 < Beckton Scamp A627 J4
 Beckton Lana C073 S < Beckton Lana A083 A
BECKTON MINOLA F732 S
 Beckton Scamp A627 J4 < Beckton Scamp X494 E3
 Beckton Serena R023 JC
 Beckton Minola W150 D < Beckton Dominor Z1 R610
 Beckton Minola P611 JL

BWt	54
WR	111
YWt.	1011
YR	100
Feb.ADG	3.32
Feb.Scr.	36
Frame	5.0
Feet	Good

DAM	
Age	2
Wt	795
Prog. BW	54
WR	111
YR	100
Udder	Very Good
Calv.Ease	
EPDs	21 -6.9 55 93 28 12 17 -8.0
Marb	+0.46
Beef Tenderness	→
Wean Pct.	62%
Cow Eff.	130
HB	99
GM	36
ProS	135
RE A	-0.14
DNA	'Outstanding'
Scan	Tender
Bfat	+0.03

★★★★★ for Low Maintenance, Marbling, High Cow Efficiency, Calving Ease.



Lot 235



Lot 233

235 BECKTON ACCENT H599 L3 1-A 100% # 4377839 Tat: BSF0 H599 

Birth: 4-11-20
 Beckton Accent U777 C2 < Beckton Cody K1 P014
 Beckton Susan R022 CQ
BECKTON ACCENT B553 L2
 Ref. A-3 < Beckton Legend S670
 Beckton Lana S371 DM
 Beckton Lana X839 L < Beckton Lancer F442 T
 Beckton Kit F468 JL
BECKTON BELGA B647 L
 Beckton Legend S670 < Beckton Justice C1 R483
 Beckton Belga U103 JC < Beckton Belga M883 DM

BWt	64
WR	102
YWt.	1012
YR	99
Feb.ADG	3.01
Feb.Scr.	32
Frame	5.0
Feet	Good

DAM	
Age	6
Wt	1080
Prog. BW	62
WR	96
YR	99
Udder	Very Good
Calv.Ease	
EPDs	17 -4.5 47 77 26 14 18 -5.0
Marb	+0.49
Beef Tenderness	→
Wean Pct.	50%
Cow Eff.	106
HB	91
GM	42
ProS	133
RE A	+0.16
DNA	'Very Good'
Scan	Tender
Bfat	+0.02

★★★★★ for Low Maintenance, Marbling, Rib-eye area, Calving Ease.

• Bulls •

236 BECKTON NEBULA H652 N5 2 100% # 4377797 Tat: BSF0 H652 

Birth: 4-17-20
 Beckton Nebula T398 V3 < Beckton Nebula L P093
 Beckton Minerva J615 VG
BECKTON NEBULA A773 L4
 Ref. N-3 Beckton Mona X022 L < Beckton Likable U130 L2
 Beckton Mona U584 CD
 Beckton Nebula P P707 < Beckton Nebula M045
 Beckton Lana M809 EP
BECKTON CHRISTY B411 N
 Beckton Christy X694 E < Beckton Epic T524 L5
 Beckton Christy U702 RA

DAM		Calv.Ease	BW	WW	YW	Milk	HPG	Stay	Maint.En.
Age	6	EPDs	15	-4.7	54	83	27	13	22 -2.0
Wt	1035	Marb	+.54		REA	-.14		Bfat	+0.04
Prog. BW	66	Beef Tenderness	→		DNA: 'Very Good'	Scan:		Tender	
WR	96	Wean Pct.	54%	Cow Eff.	113	HB	118	GM	40
YR	98	ProS	158						
Udder	Very Good								

★★★★★ for Low Maintenance, Marbling, Calving Ease.

239 BECKTON DOMINOR H618 C9 1-A 100% # 4376861 Tat: BKT0 H618 

Birth: 4-13-20
 Beckton Dominor A378 W7 < Beckton Dominor Y005 V6
 Beckton Lana Y541 W
BECKTON DOMINOR D254 N8
 Ref. D-2 Beckton Indigo W772 N < Beckton Nebula T398 V3
 Beckton Indigo T613 JT
 BKT Clifftop TP R288 < Beckton Clifftop T C075
 Beckton Christy K209 CO
BECKTON ROSE W816 C
 Beckton Rose S487 LN < Beckton Lancer T9 N586
 Beckton Rose L083 LN

DAM		Calv.Ease	BW	WW	YW	Milk	HPG	Stay	Maint.En.
Age	11	EPDs	17	-4.1	44	68	30	13	17 -4.0
Wt	1080	Marb	+.38		REA	+.06		Bfat	+0.03
Prog. BW	71	Beef Tenderness	→		DNA: 'Outstanding'	Scan:		Tender	
WR	101	Wean Pct.	51%	Cow Eff.	108	HB	89	GM	28
YR	105	ProS	117						
Udder	Very Good								

★★★★★ for Low Maintenance, Marbling, Calving Ease.

237 BECKTON RANGER H579 N6 1-A 100% # 4376905 Tat: BKT0 H579 

Birth: 4-9-20
 Beckton Ranger Z225 J4 < Beckton Ranger T603 H3
 Beckton Mona U564 JT
BECKTON RANGER B006 D5
 Ref. R-1 Beckton Suffeina Z731 D < Beckton Dominor W640 C5
 Beckton Suffeina W471 W
 Beckton Nebula EN S347 < Beckton Nebula E P084
 Beckton Eola P530 NB
BECKTON LARKABA W272 N
 Beckton Larkaba N643 HR < Beckton Herald FJ J776
 Beckton Larkaba J765 CH

DAM		Calv.Ease	BW	WW	YW	Milk	HPG	Stay	Maint.En.
Age	11	EPDs	22	-7.7	45	74	31	14	14 -5.0
Wt	960	Marb	+.43		REA	-.03		Bfat	+0.04
Prog. BW	62	Beef Tenderness	→		DNA: 'Very Good'	Scan:		Tender	
WR	105	Wean Pct.	54%	Cow Eff.	114	HB	82	GM	41
YR	102	ProS	123						
Udder	Fair								

★★★★★ for Low Maintenance, Marbling, Calving Ease.



Lot 239

238 BECKTON ORACLE H486 N2 1-A 100% # 4377931 Tat: BSF0 H486 

Birth: 4-1-20
 Schuler Sudden Impact 0004X < Red Crowfoot Ole's Oscar
 SOR Duchess TS 8915U
SCHULER ORACLE-7142E
 Ref. O-3 Sor Marlee Cmmtmt 0470X < Brown Commitment S7206
 SOR Marlee Beef 4511P
 Beckton Nebula T252 L3 < Beckton Nebula L P093
 Beckton Vernice L382 LN
BECKTON LANA W113 N
 Beckton Lana T226 NB < Beckton Nebula E P084
 Beckton Lana P026 DM

DAM		Calv.Ease	BW	WW	YW	Milk	HPG	Stay	Maint.En.
Age	11	EPDs	18	-4.9	51	89	21	12	20 0.0
Wt	955	Marb	+.60		REA	-.03		Bfat	+0.01
Prog. BW	70	Beef Tenderness	→		DNA: 'Very Good'	Scan:		Tender	
WR	95	Wean Pct.	47%	Cow Eff.	100	HB	110	GM	58
YR	102	ProS	168						
Udder	Good								

★★★★★ for Low Maintenance, Growth, Marbling, Calving Ease.

240 BECKTON LIKABLE H025 A5 1-A 100% # 4377545 Tat: BKT0 H025 

Birth: 2-18-20
 Beckton Likable Y124 L3 < Beckton Likable U130 L2
 BKT Pine Marie S802 LO
BECKTON LIKABLE F242 D4
 Ref. L-6 Beckton Firefly A022 D < Beckton Dominor W640 C5
 Beckton Firefly U801 NB
 Beckton Accent W180 C2 < Beckton Cody K1 P014
 Beckton Christy R046 CQ
BECKTON LANA F171 A
 Beckton Lana C178 E < Beckton Epic X330 L6
 Beckton Lana U025 LO

DAM		Calv.Ease	BW	WW	YW	Milk	HPG	Stay	Maint.En.
Age	2	EPDs	19	-4.6	58	87	25	11	18 1.0
Wt	835	Marb	+.35		REA	-.07		Bfat	+0.04
Prog. BW	63	Beef Tenderness	→		DNA: 'Outstanding'	Scan:		Tender	
WR	102	Wean Pct.	53%	Cow Eff.	112	HB	92	GM	16
YR	92	ProS	108						
Udder	Very Good								

★★★★★ for Marbling, Calving Ease.

• Bulls •

241 BECKTON NEW ERA H603 N2 1-A 100% # 4376879 Tat: BKT0 H603 

Birth: 4-11-20

Beckton Nebula P P707
Beckton Lana M809 EP

BECKTON NEW ERA Y194
Ref. N-2 BKT Larkeisa T310 JC

Beckton Justice C1 R483
BKT Larkeisa R775 JC

Beckton New Era A395 L2
Beckton Minerva X612 L

BECKTON SUFFEINA C168 N
Beckton Suffeina A138 N
Beckton New Era Y194
Beckton Suffeina W489 W

BWt	59
WR	106
YWt.	952
YR	93
Feb.ADG	2.52
Feb.Scr.	33
Frame	5.0
Feet	Good

DAM										
Age	5	Calv.Ease	BW	WW	YW	Milk	HPG	Stay	Maint.En.	
Wt	1140	EPDs	16	-4.8	55	85	30	11	19	2.0
Prog. BW	71	Marb	+.46		REA	-.12		Bfat	+.03	
WR	114	Beef Tenderness	→		DNA: 'Outstanding'			Scan:	Tender	
YR	105	Wean Pct.	50%		Cow Eff.	104		HB	81	
Udder	Very Good							GM	27	
								ProS	108	

★★★★★ for Marbling, Superior Cow, Calving Ease.

243 BECKTON DOMINOR H548 E10 1-A 100% # 4376939 Tat: BKT0 H548 

Birth: 4-6-20

Beckton Dominor C052 E8
Beckton Scarlett A406 E

BECKTON DOMINOR E693 D9
Ref. D-4 Beckton Christy C149 D

Beckton Dominor A378 W7
Beckton Christy A234 N

Beckton Epic X464 L5
Beckton Epic K6 S569

BECKTON CHRISTY C559 E
Beckton Christy Z125 J
Beckton Lana M393 LN
Beckton Julian X721 E6
Beckton Christy X354 N

BWt	88
WR	98
YWt.	947
YR	92
Feb.ADG	2.70
Feb.Scr.	34
Frame	5.0
Feet	Good

DAM										
Age	5	Calv.Ease	BW	WW	YW	Milk	HPG	Stay	Maint.En.	
Wt	1120	EPDs	13	-0.6	56	92	34	12	17	0.0
Prog. BW	72	Marb	+.52		REA	-.06		Bfat	+.04	
WR	108	Beef Tenderness	→		DNA: 'Outstanding'			Scan:	Tender	
YR	107	Wean Pct.	47%		Cow Eff.	98		HB	89	
Udder	Good							GM	44	
								ProS	133	

★★★★★ for Low Maintenance, Marbling, Superior Cow, Calving Ease.

242 BECKTON ALLEGIANT H604 N2 1-A 100% # 4376877 Tat: BKT0 H604 

Birth: 4-11-20

Halfmann Divergent C249
LSF Takeover 9943W
Beckton Eola U101 NB

HALFMANN ALLEGIANT E835
Ref. O-1 Halfmann Chief RK C258

Buf Crk The Right Kind U199
Halfmann Chief DV Z707

Beckton New Era A395 L2
Beckton Minerva X612 L

BECKTON LARKABA C061 N
Beckton Larkaba A804 N
Beckton Nebula T269 E2
Beckton Larkaba W693 N

BWt	68
WR	106
YWt.	972
YR	95
Feb.ADG	2.61
Feb.Scr.	35
Frame	5.0
Feet	Good

DAM										
Age	5	Calv.Ease	BW	WW	YW	Milk	HPG	Stay	Maint.En.	
Wt	980	EPDs	15	-4.1	47	73	29	13	17	0.0
Prog. BW	58	Marb	+.59		REA	-.06		Bfat	+.04	
WR	104	Beef Tenderness	→		DNA: 'Average'			Scan:	Tender	
YR	103	Wean Pct.	58%		Cow Eff.	121		HB	83	
Udder	Very Good							GM	32	
								ProS	115	

★★★★★ for Low Maintenance, Marbling, Superior Cow, High Cow Efficiency, Calving Ease.

244 BECKTON HERITAGE H039 H6 1-A 100% # 4378277 Tat: BSF0 H039 

Birth: 2-20-20

Beckton Heritage B612 J4
Beckton Heritage X403 L3
Beckton Lana N291 JC

BECKTON HERITAGE F615 L5
Ref. H-2 Beckton Mona X022 L

Beckton Likable U130 L2
Beckton Mona U584 CD

Beckton Heritage B612 J4
Beckton Heritage X403 L3
Beckton Lana N291 JC

BECKTON ENCINO F087 H
Beckton Encino X448 L
Beckton Legend S670
Beckton Encino S059 JT

BWt	65
WR	118
YWt.	905
YR	89
Feb.ADG	2.12
Feb.Scr.	33
Frame	5.0
Feet	Good

DAM										
Age	2	Calv.Ease	BW	WW	YW	Milk	HPG	Stay	Maint.En.	
Wt	805	EPDs	14	-3.5	64	78	25	12	15	-3.0
Prog. BW	65	Marb	+.43		REA	-.02		Bfat	+.03	
WR	118	Beef Tenderness	→		DNA: 'Outstanding'			Scan:	Tender	
YR	89	Wean Pct.	65%		Cow Eff.	137		HB	78	
Udder	Good							GM	13	
								ProS	91	

★★★★★ for Low Maintenance, Marbling, High Cow Efficiency, Calving Ease.



Lot 242

245 BECKTON LIKABLE H537 L5 1-A 100% # 4376949 Tat: BKT0 H537 

Birth: 4-5-20

Beckton Likable Y124 L3
Beckton Likable U130 L2
BKT Pine Marie S802 LO

BECKTON LIKABLE E391 N4
Ref. L-4 Beckton Lana X466 N

Beckton Nebula T398 V3
Beckton Lana T226 NB

Beckton Likable Y124 L3
Beckton Likable U130 L2
BKT Pine Marie S802 LO

BECKTON COCA C840 L
Beckton Coca Z239 N
Beckton Nebula X603 J4
Beckton Coca X701 N

BWt	61
WR	112
YWt.	924
YR	90
Feb.ADG	1.81
Feb.Scr.	33
Frame	5.5
Feet	Good

DAM										
Age	5	Calv.Ease	BW	WW	YW	Milk	HPG	Stay	Maint.En.	
Wt	1080	EPDs	18	-5.3	53	72	28	12	23	0.0
Prog. BW	60	Marb	+.41		REA	-.21		Bfat	+.04	
WR	100	Beef Tenderness	→		DNA: 'Outstanding'			Scan:	Tender	
YR	90	Wean Pct.	55%		Cow Eff.	116		HB	125	
Udder	Good							GM	14	
								ProS	139	

★★★★★ for Low Maintenance, Marbling, High Cow Efficiency, Calving Ease.

The Yearling Heifers



Beckton females are nearly ideal for today's industry – moderately sized, efficient producers. They combine calving ease, growth, and desirable carcass traits. They are feminine, maternal and quiet, with nice udders and sound feet. All of our heifer calves trailed up with their mothers into the Bighorn Mountains to spend their first summer. They have learned the meaning of mothering ability. And they have the productive capacity to produce

the bulls that you see in our sale. The sale heifers are a select group from the top of our replacements.

If you wish, we can also keep any sale heifers through the summer and breed them in natural service to the same herd sires we use with our own replacements. There will be a charge of \$250 per heifer plus delivery at cost in the fall. Visit with Cam about this program.



Beckton is offering two straws of P707 semen or any other sire (for which we have adequate supply) to go with every heifer purchased. The buyer will only be responsible for shipping from Billings, MT and semen may be used on any animal the buyer would like.

• Heifers •

301 BECKTON BARMAID H499 L
1-A 100% # 4377921 Tattoo: BSF0 H499

Birth: 4-2-20

Beckton Likable Y124 L3 < Beckton Likable U130 L2
BKT Pine Marie S802 LO

BECKTON LIKABLE E391 N4 BWT **79**
Ref. L-4 < Beckton Nebula T398 V3
Beckton Lana X466 N < Beckton Lana T226 NB WR **111**

Beckton New Era Y194 < Beckton Nebula P P707
BKT Larkeisa T310 JC YR **115**

BECKTON BARMAID C194 N Fr. **Med**
Beckton Barmaid X654 N < Beckton Nebula T398 V3
Beckton Barmaid S758 DM

DAM		Calv.Ease	BW	WW	YW	Milk	HPG	Stay	Maint.En.	
Age	5	EPDs	11	-1.5	67	107	28	11	22	3.0
Wt	1070	Marb	+.42		REA	-.01		Bfat +.04		
Prog.BW	68	Beef Tenderness: 8 'Very Good'								
WR	107	Cow Eff.	.96		CEM	4		HB 3%		
YR	115									
Udder	Very Good									



★★★★★ for Growth, Marbling, Superior Cow, Stayability.

302 BECKTON TAMARA H585 L
1-A 100% # 4376897 Tattoo: BKT0 H585

Birth: 4-9-20

Beckton Likable Y124 L3 < Beckton Likable U130 L2
BKT Pine Marie S802 LO

BECKTON LIKABLE E391 N4 BWT **57**
Ref. L-4 < Beckton Nebula T398 V3
Beckton Lana X466 N < Beckton Lana T226 NB WR **114**

Beckton Cody K1 P014 < Beckton Cody KH M390
Beckton Rose M126 WR YR **123**

BECKTON TAMARA W550 A Fr. **Med**
Beckton Tamara R175 CQ < Beckton Cherokee N N479
Beckton Tamara N765 CO

DAM		Calv.Ease	BW	WW	YW	Milk	HPG	Stay	Maint.En.	
Age	11	EPDs	16	-4.5	60	94	31	12	20	0.0
Wt	1150	Marb	+.42		REA	-.18		Bfat +.05		
Prog.BW	71	Beef Tenderness: 8 'Very Good'								
WR	110	Cow Eff.	.88		CEM	7		HB 7%		
YR	109									
Udder	Very Good									

303 BECKTON PINE MARIE H487 L
1-A 100% # 4377013 Tattoo: BKT0 H487

Birth: 4-1-20

Beckton Likable U130 L2 < Beckton Likable S633
Beckton Kit S478 LN

BECKTON LIKABLE D432 N3 BWT **72**
Ref. L-3 < Beckton Nebula T054 H3
Beckton Firefly W013 N < Beckton Firefly T003 JC WR **123**

Beckton Nebula X096 N4 < Beckton Nebula U206 V3
Beckton Tamara U185 NB YR **116**

BKT PINE MARIE Z177 N Fr. **Med**
BKT Pine Marie X540 H < Beckton Heritage T270 J2
BKT Pine Marie R246 JE

DAM		Calv.Ease	BW	WW	YW	Milk	HPG	Stay	Maint.En.	
Age	8	EPDs	14	-2.5	61	94	29	12	18	-1.0
Wt	1190	Marb	+.40		REA	+.06		Bfat +.03		
Prog.BW	74	Beef Tenderness: 8 'Very Good'								
WR	119	Cow Eff.	.95		CEM	6		HB 20%		
YR	108									
Udder	Very Good									

★★★★★ for Low Maintenance, Growth, Marbling, Superior Cow, Calving Ease, Stayability.

★★★★★ for Low Maintenance, Growth, Marbling, Superior Cow, Calving Ease, Stayability.



304 BECKTON LARKEISA H469
1-A 100% # 4377031 Tattoo: BKT0 H469

Birth: 3-31-20

Beckton Julian Z382 J7 < Beckton Julian X721 E6
Beckton Larkaba X064 J

BECKTON JULIAN E423 N8 BWT **61**
Ref. J-4 < Beckton Nebula Z111 N5
Beckton Belga B004 N < Beckton Belga Z031 N WR **122**

Beckton Emcee Z619 J3 < Beckton Emcee W526 J2
Beckton Tamara U591 JL YR **115**

BECKTON LARKEISA B885 J4 Fr. **Med**
Beckton Larkeisa Z892 J < Beckton Julian U699 L5
BKT Larkeisa W186 J

DAM		Calv.Ease	BW	WW	YW	Milk	HPG	Stay	Maint.En.	
Age	6	EPDs	21	-7.6	57	84	31	12	16	-6.0
Wt	970	Marb	+.46		REA	-.12		Bfat +.04		
Prog.BW	59	Beef Tenderness: 9 'Outstanding'								
WR	112	Cow Eff.	.117		CEM	8		HB 34%		
YR	104									
Udder	Very Good									

★★★★★ for Low Maintenance, Growth, Marbling, Superior Cow, High Cow Efficiency, Calving Ease, Stayability.

• Heifers •

305 BECKTON BELGA H305 A
1-A 100% # 4377217 Tattoo: BKT0 H305

Birth: 3-23-20

Beckton Accent W180 C2 < Beckton Cody K1 P014
Beckton Christy R046 CQ

BECKTON ACCENT D678 E3 BWT **71**
Ref. A < Beckton Epic K6 S569
Beckton Lana U329 EP < Beckton Lana S477 LN WR **120**

Beckton Nebula A394 C5 < Beckton Nebula W778 J4
Beckton Lana T104 CT < Beckton Lana T104 CT YR **112**

BECKTON BELGA C059 N Fr. **Med**
Beckton Accent W180 C2
Beckton Belga A160 A < Beckton Belga W103 N

DAM		Calv.Ease	BW	WW	YW	Milk	HPG	Stay	Maint.En.	
Age	5	EPDs	18	-3.7	70	105	29	10	21	-1.0
Wt	1070	Marb	+0.33		REA +0.16		Bfat +0.04			
Prog.BW	60	Beef Tenderness: 7 'Very Good'								
WR	108	Cow Eff.	104		CEM 7		HB 2%			
YR	96									
Udder	Very Good									

307 BECKTON LANA H082 N
1-A 100% # 4378245 Tattoo: BSF0 H082

Birth: 2-29-20

Beckton Nebula B557 J3 < Beckton Nebula P P707
Beckton Larkaba T813 JC

BECKTON NEBULA F440 H4 BWT **57**
Ref. N < Beckton Hasten H S462
Beckton Minola X638 H < Beckton Minola N751 JL WR **110**

Beckton Nebula B557 J3 < Beckton Nebula P P707
Beckton Larkaba T813 JC < Beckton Larkaba T813 JC YR **110**

BECKTON LANA F474 N Fr. **Med**
Beckton Nebula W022 D3
Beckton Lana Y130 N < Beckton Lana W525 D

DAM		Calv.Ease	BW	WW	YW	Milk	HPG	Stay	Maint.En.	
Age	2	EPDs	15	-4.9	56	88	28	11	20	-2.0
Wt	815	Marb	+0.50		REA -0.14		Bfat +0.04			
Prog.BW	57	Beef Tenderness: 9 'Outstanding'								
WR	110	Cow Eff.	106		CEM 7		HB 8%			
YR	110									
Udder	Very Good									

★★★★★ for Low Maintenance, Growth, Marbling, Rib-eye area, Calving Ease, Stayability.

★★★★★ for Low Maintenance, Growth, Marbling, Superior Cow, Calving Ease, Stayability.



308 BECKTON MINERVA H306 N
1-A 100% # 4377215 Tattoo: BKT0 H306

Birth: 3-23-20

Beckton Neva 5562 < Beckton Pine 2778-8
Bkt Mona 1634-1549

BECKTON NOMAD 7496 BWT **68**
Ref. V < Thunderbolt
Bkt Bolt Tamrck 3913 < MD 373 RC 523 WR **110**

Beckton Nebula T398 V3 < Beckton Nebula L P093
Beckton Minerva J615 VG < Beckton Minerva J615 VG YR **101**

BECKTON MINERVA Y324 N Fr. **Med**
Beckton Minerva T864 CK < Beckton Colt K M609
Beckton Minerva M179 LN

DAM		Calv.Ease	BW	WW	YW	Milk	HPG	Stay	Maint.En.	
Age	9	EPDs	19	-5.7	46	66	24	12	16	-9.0
Wt	1100	Marb	+0.27		REA -0.43		Bfat +0.02			
Prog.BW	64	Beef Tenderness: 4 'Poor'								
WR	111	Cow Eff.	93		CEM 10		HB 20%			
YR	107									
Udder	Fair									

★★★★★ for Low Maintenance, Marbling, Superior Cow, Calving Ease, Stayability.

306 BECKTON LANA H134 L
1-A 100% # 4377415 Tattoo: BKT0 H134

Birth: 3-9-20

Beckton Likable Z057 L4 < Beckton Likable X445 J3
Beckton Minola X107 L

BECKTON LIKABLE B032 C5 BWT **64**
Ref. L-2 < Beckton Clifftop W577 E3
Beckton Mona Z270 C < Beckton Mona U584 CD WR **92**

Beckton Accent Y260 L3 < Beckton Accent W180 C2
Beckton Lana W463 L < Beckton Lana W463 L YR **102**

BECKTON LANA C676 A Fr. **Med**
Beckton Accent W180 C2
Beckton Lana Z724 A < Beckton Lana R205 EP

DAM		Calv.Ease	BW	WW	YW	Milk	HPG	Stay	Maint.En.
Age	5	EPDs	17	-5.6	47	89	11	21	-2.0
Wt	880	Marb	+0.51		REA -0.15		Bfat +0.03		
Prog.BW	60	Beef Tenderness: 7 'Very Good'							
WR	104	Cow Eff.	97		CEM 6		HB 15%		
YR	102								
Udder	Very Good								



★★★★★ for Low Maintenance, Marbling, Calving Ease, Stayability.

• Heifers •



Not for sale

311 **BECKTON INDIGO H066 A**
 1-A 100% # 4378257 Tattoo: BSF0 H066

Birth: 2-25-20
 Beckton Accent B150 N4 < Beckton Accent Y260 L3
 BKT Larkeisa S055 NB

BECKTON ACCENT F177 L5
 Ref. A < Beckton Vernice C782 L < Beckton Likable Y124 L3
 Beckton Vernice X754 L

Beckton Nebula B557 J3 < Beckton Nebula P P707
 Beckton Larkaba T813 JC

BECKTON INDIGO F637 N
 Beckton Indigo C858 C < Beckton Clifftop Y012 C4
 Beckton Indigo W381 E

DAM	Age	2	Calv.Ease	BW	WW	YW	Milk	HPG	Stay	Maint.En.	
	Wt	815	EPDs	15	-2.9	59	92	30	8	16	0.0
	Prog.BW	63	Marb	+.54		REA	-.14		Bfat +.04		
	WR	113	Beef Tenderness: 9 'Outstanding'								
	YR	114	Cow Eff.	109		CEM	7		HB 57%		
	Udder	Good									

BWt **63**
 WR **113**
 YR **114**
 Fr. **Med**

★★★★★ for Low Maintenance, Growth, Marbling, Superior Cow, Calving Ease, Stayability.

309 **BSF VIOLET H187 N**
 1-B 99% # 4378173 Tattoo: BSF0 H187

Birth: 3-15-20
 Beckton Nebula T398 V3 < Beckton Nebula L P093
 Beckton Minerva J615 VG

BECKTON NEBULA A773 L4
 Ref. N-3 < Beckton Likable U130 L2
 Beckton Mona X022 L < Beckton Mona U584 CD

Beckton Legend S670 < Beckton Lancer F442 T
 Beckton Kit F468 JL

BSF VIOLET X528 L
 BSF Violet N382 VG < Beckton Vegas S1 K316
 BSF Red H119

DAM	Age	10	Calv.Ease	BW	WW	YW	Milk	HPG	Stay	Maint.En.	
	Wt	1105	EPDs	14	-2.8	62	93	27	12	21	-2.0
	Prog.BW	68	Marb	+.32		REA	+.13		Bfat +.02		
	WR	103	Beef Tenderness: 10 'Outstanding'								
	YR	100	Cow Eff.	90		CEM	7		HB 1%		
	Udder	Very Good									

BWt **67**
 WR **107**
 YR **107**
 Fr. **Med**



Roping calves

★★★★★ for Low Maintenance, Growth, Marbling, Rib-eye area, Calving Ease, Stayability.

310 **BECKTON ROSE H195 J**
 1-A 100% # 4377345 Tattoo: BKT0 H195

Birth: 3-16-20
 Beckton Julian Z382 J7 < Beckton Julian X721 E6
 Beckton Larkaba X064 J

BECKTON JULIAN E423 N8
 Ref. J-4 < Beckton Nebula Z111 N5
 Beckton Belga B004 N < Beckton Belga Z031 N

Beckton Accent Y260 L3 < Beckton Accent W180 C2
 Beckton Lana W463 L

BECKTON ROSE D464 A
 Beckton Rose Z078 J < Beckton Janus X799 L2
 Beckton Rose X573 N

DAM	Age	4	Calv.Ease	BW	WW	YW	Milk	HPG	Stay	Maint.En.	
	Wt	1120	EPDs	18	-4.3	52	83	27	10	19	0.0
	Prog.BW	66	Marb	+.52		REA	-.25		Bfat +.04		
	WR	100	Beef Tenderness: 9 'Outstanding'								
	YR	98	Cow Eff.	79		CEM	7		HB 27%		
	Udder	Very Good									

BWt **65**
 WR **99**
 YR **105**
 Fr. **Med**

312 **BECKTON LANA H466 L**
 1-A 100% # 4377951 Tattoo: BKT0 H466

Birth: 3-31-20
 Beckton Likable Y124 L3 < Beckton Likable U130 L2
 BKT Pine Marie S802 LO

BECKTON LIKABLE E391 N4
 Ref. L-4 < Beckton Nebula T398 V3
 Beckton Lana X466 N < Beckton Lana T226 NB

Beckton Accent W180 C2 < Beckton Cody K1 P014
 Beckton Christy R046 CQ

BECKTON LANA D257 A
 Beckton Lana Z832 N < Beckton Nebula T269 E2
 Beckton Lana W113 N

DAM	Age	4	Calv.Ease	BW	WW	YW	Milk	HPG	Stay	Maint.En.	
	Wt	1080	EPDs	14	-2.6	64	102	27	13	22	3.0
	Prog.BW	64	Marb	+.37		REA	-.08		Bfat +.04		
	WR	107	Beef Tenderness: 8 'Very Good'								
	YR	109	Cow Eff.	87		CEM	6		HB 2%		
	Udder	Very Good									

BWt **72**
 WR **106**
 YR **106**
 Fr. **Med**

★★★★★ for Low Maintenance, Growth, Marbling, Calving Ease, Stayability.

★★★★★ for Growth, Marbling, Superior Cow, Calving Ease, Stayability.

• Heifers •



315 BECKTON LARKEISA H057 J
1-A 100% # 4377507 Tattoo: BKT0 H057

Birth: 2-23-20
 Beckton Julian D551 C6 < Beckton Julian X465 J5
 Beckton Tamara W550 A

BECKTON JULIAN F067 L7
Ref. J-5
 Beckton Indigo D786 L < Beckton Likable Z057 L4
 Beckton Indigo Y026 N

Beckton Epic B310 J6 < Beckton Epic X464 L5
 Beckton Minerva Y116 J

BECKTON LARKEISA F258 E
 Beckton Larkeisa Z238 J < Beckton Julian GG B571
 BKT Larkeisa R676 DM

DAM		Calv.Ease	BW	WW	YW	Milk	HPG	Stay	Maint.En.	
Age	2	EPDs	16	-2.5	68	115	28	11	16	1.0
Wt	800	Marb	+.47		REA	+.05		Bfat +.03		
Prog.BW	60	Beef Tenderness: 9 'Outstanding'								
WR	113	Cow Eff.		110	CEM	6	HB 49%			
YR	111									
Udder	Very Good									

BWt **60**
WR **113**
YR **111**
Fr. **Med**

★★★★★ for Growth, Marbling, Superior Cow, Calving Ease, Stayability.

313 BECKTON COCA H224 L
1-A 100% # 4378133 Tattoo: BSF0 H224

Birth: 3-18-20
 Beckton Likable X445 J3 < Beckton Likable X445 J3
 Beckton Minola X107 L

BECKTON LIKABLE B032 C5
Ref. L-2
 Beckton Cliffot W577 E3 < Beckton Cliffot W577 E3
 Beckton Mona U584 CD

Beckton Nebula X096 N4 < Beckton Nebula U206 V3
 Beckton Tamara U185 NB

BECKTON COCA C411 N
 Beckton Coca Y399 L < Beckton Likable U120 L2
 Beckton Coca H051 CH

DAM		Calv.Ease	BW	WW	YW	Milk	HPG	Stay	Maint.En.	
Age	5	EPDs	16	-4.2	52	95	27	11	20	4.0
Wt	1062	Marb	+.47		REA	-.04		Bfat +.02		
Prog.BW	65	Beef Tenderness: 7 'Very Good'								
WR	106	Cow Eff.		85	CEM	5	HB 30%			
YR	105									
Udder	Good									

BWt **67**
WR **109**
YR **108**
Fr. **Med**

★★★★★ for Growth, Marbling, Superior Cow, Calving Ease, Stayability.

316 BECKTON LANA H522 H
1-A 100% # 4377905 Tattoo: BKT0 H522

Birth: 4-5-20
 Bieber H Hughes W109 < Basin Hobo 0545
 Basin Rose 06T0

BECKTON HUGHES C463 N2
Ref. B-1
 Beckton Nexus L016 < Beckton Nexus L016
 Beckton Lakme T689 NX

Beckton Nebula T269 E2 < Beckton Nebula M045
 Beckton Ruth M967 EP

BECKTON LANA Z832 N
 Beckton Lana W113 N < Beckton Nebula T252 L3
 Beckton Lana T226 NB

DAM		Calv.Ease	BW	WW	YW	Milk	HPG	Stay	Maint.En.	
Age	8	EPDs	15	-4.6	55	84	25	15	19	1.0
Wt	1115	Marb	+.28		REA	-.11		Bfat +.04		
Prog.BW	66	Beef Tenderness: 7 'Very Good'								
WR	97	Cow Eff.		84	CEM	9	HB 4%			
YR	102									
Udder	Very Good									

BWt **55**
WR **101**
YR **97**
Fr. **Med**

★★★★★ for Marbling, Calving Ease, Stayability.

314 BECKTON LARKABA H241 J
2 100% # 4377295 Tattoo: BKT0 H241

Birth: 3-19-20
 Beckton Julian Z382 J7 < Beckton Julian X721 E6
 Beckton Larkaba X064 J

BECKTON JULIAN E423 N8
Ref. J-4
 Beckton Nebula Z111 N5 < Beckton Nebula Z111 N5
 Beckton Belga B004 N

Beckton Legend U331 E2 < Beckton Legend S670
 Beckton Lana S669 EP

BECKTON LARKABA A751 L
 Beckton Larkaba W868 J < Beckton Julian G5 S107
 Beckton Larkaba S663 JE

DAM		Calv.Ease	BW	WW	YW	Milk	HPG	Stay	Maint.En.
Age	7	EPDs	20	-6.5	54	87	12	17	-1.0
Wt	940	Marb	+.48		REA	-.16		Bfat +.04	
Prog.BW	68	Beef Tenderness: 9 'Outstanding'							
WR	102	Cow Eff.		98	CEM	9	HB 27%		
YR	102								
Udder	Very Good								

BWt **61**
WR **99**
YR **104**
Fr. **Med**

★★★★★ for Low Maintenance, Marbling, Calving Ease, Stayability.



• Heifers •

317 BECKTON ROSE H378 S
1-A 100% # 4377129 Tattoo: BKT0 H378

Birth: 3-26-20

Beckton Scamp X494 E3 < Beckton Scamp T A825
Beckton Lana S074 EP

BECKTON SCAMP A627 J4
Ref. S < Beckton Justice Cc N265
Beckton Serena R023 JC < Beckton Serena N469 JC

Beckton Legend S670 < Beckton Lancer F442 T
Beckton Kit F468 JL

BECKTON ROSE X802 L
Beckton Lancer T7 M089
Beckton Rose R353 LN < Beckton Rose L083 LN

DAM	
Age	10
Wt	1160
Prog.BW	65
WR	100
YR	99
Udder	Very Good

Calv.Ease	BW	WW	YW	Milk	HPG	Stay	Maint.En.	
EPDs	19	-5.1	51	78	28	13	15	-11.0
Marb	+0.34		REA	-0.06		Bfat		+0.01
Beef Tenderness: 7 'Very Good'								
Cow Eff.	82	CEM	10	HB		12%		

319 BECKTON LAKME H054 H
1-A 100% # 4377513 Tattoo: BKT0 H054

Birth: 2-23-20

Beckton Hughes D589 S2 < Bieber H Hughes W109
Beckton Sierra Z353 S

BECKTON HUGHES F076 H3
Ref. B-2 < Beckton Emera D487 B < Beckton Emera A186 A

Beckton New Era A395 L2 < Beckton New Era Y194
Beckton Minerva X612 L

BECKTON LAKME F312 N
Beckton Nebula T269 E2
Beckton Lakme Z405 N < Beckton Lakme T692 EP

DAM	
Age	2
Wt	805
Prog.BW	57
WR	99
YR	101
Udder	Very Good

Calv.Ease	BW	WW	YW	Milk	HPG	Stay	Maint.En.	
EPDs	15	-3.1	57	90	28	13	18	1.0
Marb	+0.29		REA	-0.07		Bfat		+0.03
Beef Tenderness: 9 'Outstanding'								
Cow Eff.	95	CEM	9	HB		12%		

★★★★★ for Low Maintenance, Growth, Marbling, Calving Ease, Stayability.

★★★★★ for Marbling, Calving Ease, Stayability.



320 BECKTON CHRISTY H266 N
1-A 100% # 4377263 Tattoo: BKT0 H266

Birth: 3-21-20

Beckton Nebula E P084 < Beckton Nebula M045
BKT Pine Marie M119 EP

BECKTON NEBULA EN S347
Ref. N < Beckton Eola P530 NB < Beckton Eola M663 EP

Beckton Nebula X603 J4 < Beckton Nebula T398 V3
Beckton Firefly T003 JC

BECKTON CHRISTY Z229 N
Beckton Christy X457 N < Beckton Nebula T054 HC
Beckton Christy S475 EP

DAM	
Age	8
Wt	1005
Prog.BW	69
WR	106
YR	100
Udder	Very Good

Calv.Ease	BW	WW	YW	Milk	HPG	Stay	Maint.En.	
EPDs	19	-6.6	50	75	33	14	19	-7.0
Marb	+0.47		REA	-0.27		Bfat		+0.05
Beef Tenderness: 8 'Very Good'								
Cow Eff.	94	CEM	9	HB		5%		

★★★★★ for Low Maintenance, Marbling, Calving Ease, Stayability.

318 BSF JUSTICIA H287 D
1-B 99% # 4378097 Tattoo: BSF0 H287

Birth: 3-22-20

Beckton Dominor W640 C5 < Beckton Dominor Z1 R610
Beckton Mona R166 CQ

BECKTON DOMINOR Y052 N6
Ref. D-1 < Beckton Nebula T398 V3
Beckton Indigo W772 N < Beckton Indigo T613 JT

Beckton Nebula T269 E2 < Beckton Nebula M045
Beckton Ruth M967 EP

BSF JUSTICIA Y672 N
BSF Justicia R553 JC < Beckton Justice C K449
BSF Regus L104 LN

DAM	
Age	9
Wt	1196
Prog.BW	72
WR	107
YR	102
Udder	Good

Calv.Ease	BW	WW	YW	Milk	HPG	Stay	Maint.En.	
EPDs	15	-3.3	53	85	25	14	17	-2.0
Marb	+0.30		REA	-0.04		Bfat		+0.04
Beef Tenderness: 9 'Outstanding'								
Cow Eff.	75	CEM	7	HB		22%		

★★★★★ for Low Maintenance, Growth, Marbling, Calving Ease, Stayability.

351 PEN OF 10 COMMERCIAL HEIFERS
This lot contains 10 high-percentage Beckton Red Angus yearling heifers.

352 PEN OF 10 COMMERCIAL HEIFERS
This lot contains 10 high-percentage Beckton Red Angus yearling heifers.

Reference Sire Lot Index

<u>Lot</u>	<u>ID</u>	<u>Lot</u>	<u>ID</u>	<u>Lot</u>	<u>ID</u>	<u>Lot</u>	<u>ID</u>	<u>Lot</u>	<u>ID</u>	<u>Lot</u>	<u>ID</u>	
<u>Accent A175 (A)</u>		<u>Accent C557 (A-4)</u>		<u>Dominor D254 (D-2)</u>		<u>Julian P608 (J)</u>		<u>Likable B032 (L-2)</u>		<u>Likable F520 (L-8)</u>		<u>RedHill Lancer</u>
102. . . .	H273	20.	H223	13.	H295	194. . . .	H372	2.	H409	100. . . .	H124	<u>ERH11 (O-2)</u>
<u>Accent B563 (A)</u>		33.	H346	17.	H334	<u>Julian Z382 (J-2)</u>		7.	HC162	147. . . .	H127	55.
142. . . .	H100	45.	H699	23.	H423	41.	H428	39.	H200	156. . . .	H231	71.
<u>Accent B818 (A)</u>		91.	H667	58.	H207	63.	H324	40.	H164	<u>Likable F682 (L-9)</u>		77.
140. . . .	H307	94.	H531	86.	H349	107. . . .	H351	50.	H527	118. . . .	H336	89.
<u>Accent D115 (A)</u>		111. . . .	H536	154. . . .	H695	162. . . .	H331	52.	H508	122. . . .	H017	116. . . .
204. . . .	H791	141. . . .	H353	198. . . .	H519	208. . . .	H290	65.	H458	139. . . .	H561	123. . . .
<u>Accent D326 (A)</u>		214. . . .	H719	239. . . .	H618	<u>Julian A434 (J-3)</u>		69.	H498	233. . . .	H192	144. . . .
3.	H412	223. . . .	H712	<u>Dominor D495 (D-3)</u>		105. . . .	HC166	115. . . .	H247	<u>Likable F816 (L-10)</u>		173. . . .
<u>Accent D678 (A)</u>		<u>Accent E172 (A-5)</u>		21.	H449	201. . . .	HC169	145. . . .	H572	36.	H212	202. . . .
305. . . .	H305(H)	27.	H226	149. . . .	H552	218. . . .	HC175	170. . . .	H672	112. . . .	H028	226. . . .
<u>Accent F177 (A)</u>		47.	H677	159. . . .	H451	<u>Julian E423 (J-4)</u>		228. . . .	H320	181. . . .	H012	238. . . .
125. . . .	H091	68.	H493	<u>Dominor E693 (D-4)</u>		8.	H384	306. . . .	H134(H)	<u>Ranger B006 (R-1)</u>		31.
311. . . .	H066(H)	163. . . .	H278	18.	H442	11.	H420	313. . . .	H224(H)	<u>Nebula S347 (N)</u>		53.
<u>Accent F363 (A)</u>		193. . . .	H681	42.	H481	16.	H465	<u>Likable D432 (L-3)</u>		186. . . .	H494	72.
93.	H090	215. . . .	H636	66.	H327	57.	H258	14.	H136	320. . . .	H266(H)	87.
<u>Accent F602 (A)</u>		<u>Accent F194 (A-6)</u>		212. . . .	H776	114. . . .	H298	43.	H123	<u>Nebula F440 (N)</u>		129. . . .
80.	H065	151. . . .	H115	216. . . .	H360	185. . . .	H594	49.	H189	307. . . .	H082(H)	221. . . .
<u>Accent F895 (A)</u>		172. . . .	H142	243. . . .	H548	205. . . .	H472	88.	H185	<u>Nebula P707 (N-1)</u>		231. . . .
135. . . .	H055	<u>Hughes C463 (B-1)</u>		<u>Dominor F207 (D-5)</u>		304. . . .	H469(H)	124. . . .	H577	211. . . .	H275	237. . . .
<u>Accent W180 (A-1)</u>		78.	H501	90.	H141	310. . . .	H195(H)	155. . . .	H330	<u>New Era Y194 (N-2)</u>		<u>Scamp A627 (S)</u>
126. . . .	H347	106. . . .	H374	132. . . .	H107	314. . . .	H241(H)	177. . . .	H610	5.	H246	317. . . .
130. . . .	H249	153. . . .	H663	164. . . .	H228	<u>Julian F067 (J-5)</u>		224. . . .	H687	37.	H395	<u>Scamp E175 (S-1)</u>
167. . . .	HC161	219. . . .	H545	165. . . .	H422	60.	H095	303. . . .	H487(H)	175. . . .	H471	9.
<u>Accent B549 (A-2)</u>		230. . . .	H700	<u>Epic B483 (E)</u>		101. . . .	H109	<u>Likable E391 (L-4)</u>		178. . . .	H474	64.
24.	H391	316. . . .	H522(H)	195. . . .	H234	148. . . .	H617	6.	H397	179. . . .	H407	70.
34.	H400	<u>Hughes F076 (B-2)</u>		<u>Epic D001 (E-1)</u>		166. . . .	H711	56.	H317	191. . . .	H277	92.
48.	H289	35.	H173	12.	H216	315. . . .	H057(H)	67.	H381	241. . . .	H603	127. . . .
51.	H355	203. . . .	H398	121. . . .	H326	<u>Legend S670 (L)</u>		76.	H286	<u>Nebula A773 (N-2)</u>		128. . . .
74.	H274	319. . . .	H054(H)	190. . . .	H693	187. . . .	H425	189. . . .	H568	4.	H393	138. . . .
81.	H709	<u>Cardinal D010 (C)</u>		220. . . .	H724	<u>Legend C313 (L)</u>		209. . . .	H696	119. . . .	H254	152. . . .
103. . . .	H313	46.	H147	<u>Epic F279 (E-2)</u>		99.	H288	245. . . .	H537	188. . . .	H521	161. . . .
171. . . .	H630	<u>Cardinal E673 (C-1)</u>		44.	H163	<u>Likable C643 (L)</u>		301. . . .	H499(H)	199. . . .	H529	180. . . .
174. . . .	H293	32.	H309	134. . . .	H027	183. . . .	H488	302. . . .	H585(H)	217. . . .	H715	206. . . .
210. . . .	H621	54.	H180	157. . . .	H098	<u>Likable F834 (L)</u>		312. . . .	H466(H)	232. . . .	H769	<u>Scamp F172 (S-2)</u>
<u>Accent B553 (A-3)</u>		117. . . .	H263	168. . . .	H238	182. . . .	H143	<u>Likable F237 (L-5)</u>		236. . . .	H652	146. . . .
30.	H567	131. . . .	H421	<u>Heritage C477 (H-1)</u>		200. . . .	H595	85.	H041	309. . . .	H187(H)	160. . . .
82.	H741	143. . . .	H489	1.	H314	229. . . .	H120	196. . . .	H032	<u>New Era C209 (N-3)</u>		169. . . .
104. . . .	H366	158. . . .	H680	28.	H402	<u>Likable Y124 (L-1)</u>		<u>Likable F242 (L-6)</u>		10.	H106	234. . . .
137. . . .	H560	192. . . .	H669	59.	H318	19.	H620	73.	H016	15.	H194	<u>Nomad 7496 (V)</u>
184. . . .	H659	225. . . .	H540	79.	H210	61.	H300	75.	H013	62.	H198	308. . . .
227. . . .	H413	<u>Cardinal F175 (C-2)</u>		84.	H456	<u>Likable C643 (L)</u>		95.	H086	<u>Allegiant EH835 (O-1)</u>		<u>Nomad 9871 (V)</u>
235. . . .	H599	38.	H060	110. . . .	H299	183. . . .	H488	197. . . .	H103	98.	H190	96.
<u>Dominor Y052 (D-1)</u>		108. . . .	H084	<u>Heritage F615 (H-2)</u>		<u>Likable F834 (L)</u>		240. . . .	H025	133. . . .	H495	97.
113. . . .	H329	213. . . .	H418	136. . . .	H135	182. . . .	H143	<u>Likable F242 (L-6)</u>		207. . . .	H661	
318. . . .	H287(H)	<u>Dominor Y052 (D-1)</u>		150. . . .	H229	200. . . .	H595	77.	H016	242. . . .	H604	
		109. . . .	H322	244. . . .	H039	229. . . .	H120	75.	H013			
		113. . . .	H329			<u>Likable Y124 (L-1)</u>		95.	H086			
		318. . . .	H287(H)			19.	H620	197. . . .	H103			
						61.	H300	240. . . .	H025			
						<u>Likable F287 (L-7)</u>		22.	H112			
						29.	H004	29.	H004			

Reference Sires



Julian B571 (J-2)

The goal for Beckton's program has always been to develop breeding seedstock which offer increased levels of performance for the commercial cattleman. Increased performance does not mean maximizing weight and size, which have already reached the upper limit of economic value for the packer and consumer. It does, however, mean increasing performance related to calving percentage and weaning percentage; and increasing performance related to cow maintenance requirements and "pounds of calf per acre" efficiency.



Accent W180 (A-1)



Nebula P707 (N-1)

A-1 BECKTON ACCENT W180 C2										
1-A 100% # 1331776 Tattoo: BKB9 W180										
Birth: 3-12-09										
Beckton Cody KH M390		Beckton Cody K G701		BWT		77				
Beckton Warrior T C371		Beckton Tamara J124 HR		WR		116				
BECKTON CODY K1 P014		Beckton Rose D741 LN		ADG		4.23				
Ref. A		Beckton Rose M126 WR		YR		114				
Beckton Cherokee N N479		BFCK Cherokee Cnyn 4912		Scr.		39				
BECKTON CHRISTY R046 CQ		Beckton Dinah C440 NM		Fr.		5.5				
Beckton Christy N740 HR		Beckton Herald FJ J776								
Beckton Christy K141 VG										
DAM		Calv.Ease	BW	WW	YW	Milk	HPG	Stay	Maint.En.	
Age	4	EPDs	19	-4.9	61	96	26	12	23	-2.0
Wt	1140	Acc.	(.67)	(.85)	(.81)	(.82)	(.68)	(.49)	(.53)	(.68)
Wean Pct.	57%	Marb	+.34 (.46)		REA	+.13 (.55)		Bfat	+.04 (.38)	
Cow Eff.	121									

★★★★★ for Low Maintenance, Growth, Gainability, Marbling, Rib-eye area, High Cow Efficiency, Calving Ease.

A-2 BECKTON ACCENT B549 N3										
1-A 100% # 1705673 Tattoo: BKB4 B549										
Birth: 3-31-14										
Beckton Cody K1 P014		Beckton Cody KH M390		BWT		75				
Beckton Cherokee N N479		Beckton Rose M126 WR		WR		119				
BECKTON ACCENT W180 C2		Beckton Christy R046 CQ		ADG		4.77				
Ref. A-1		Beckton Nebula T398 V3		YR		122				
Beckton Nebula L P093		Beckton Minerva J615 VG		Scr.		39				
BECKTON MINERVA Y654 N		Beckton Loki F251		Fr.		6.0				
Beckton Minerva M369 LO		Beckton Minerva H403 LN								
DAM		Calv.Ease	BW	WW	YW	Milk	HPG	Stay	Maint.En.	
Age	3	EPDs	14	-2.5	66	115	20	12	21	5.0
Wt	1046	Acc.	(.46)	(.71)	(.66)	(.67)	(.33)	(.10)	(.24)	(.65)
Wean Pct.	54%	Marb	+.38 (.27)		REA	+.20 (.46)		Bfat	+.04 (.23)	
Cow Eff.	114									

★★★★★ for Growth, Gainability, Marbling, Rib-eye area, Calving Ease.

• Reference Sires •

A-3 BECKTON ACCENT B553 L2
1-A 100% # 1706080 Tattoo: BKT4 B553

Birth: 3-31-14

Beckton Cody K1 P014 < Beckton Cody KH M390
Beckton Rose M126 WR

BECKTON ACCENT U777 C2
Ref. A < Beckton Cherokee N N479
Beckton Susan R022 CQ < Beckton Susan N023 JE

Beckton Legend S670 < Beckton Lancer F442 T
Beckton Kit F468 JL

BECKTON LANA X839 L
Beckton Lana S371 DM < Beckton Dominor ZC M919
Beckton Lana L367 LN

BWt	80
WR	102
ADG	4.49
YR	108
Scr.	36
Fr.	5.5

DAM	
Age	4
Wt	1260
Wean Pct.	49%
Cow Eff.	104

Calv.Ease	BW	WW	YW	Milk	HPG	Stay	Maint.En.
EPDs	15	-1.9	56	96	27	13	-2.0
Acc.	(.40)	(.69)	(.63)	(.64)	(.27)	(.10)	(.21)
Marb	+.45 (.26)		REA +.15 (.41)		Bfat +.03 (.26)		

A-6 BECKTON ACCENT F194 A4
1-A 100% # 3987872 Tattoo: BKT8 F194

Birth: 3-10-18

Beckton Accent U777 C2 < Beckton Cody K1 P014
Beckton Susan R022 CQ

BECKTON ACCENT B653 C3
Ref. A < BKT Clifftop TP R288
Beckton Christy W779 C < Beckton Christy S151 NB

Beckton Accent Y260 L3 < Beckton Accent W180 C2
Beckton Lana W463 L

BECKTON SUFFEINA A190 A
Beckton Nebula P P707
Beckton Suffeina Y242 N < BKT Suffeina T110 EM

BWt	97
WR	117
ADG	4.56
YR	118
Scr.	40
Fr.	5.5

DAM	
Age	5
Wt	1220
Wean Pct.	55%
Cow Eff.	115

Calv.Ease	BW	WW	YW	Milk	HPG	Stay	Maint.En.
EPDs	8	0.7	67	109	29	11	21
Acc.	(.29)	(.45)	(.40)	(.41)	(.21)	(.04)	(.15)
Marb	+.50 (.17)		REA -.09 (.29)		Bfat +.04 (.18)		

★★★★★ for Low Maintenance, Growth, Gainability, Marbling, Rib-eye area, Calving Ease.

★★★★★ for Growth, Gainability, Marbling.

A-4 BECKTON ACCENT C557 N4
1-A 100% # 3487734 Tattoo: BKB5 C557

Birth: 3-31-15

Beckton Accent U777 C2 < Beckton Cody K1 P014
Beckton Susan R022 CQ

BECKTON ACCENT Y312 N3
Ref. A < Beckton Nebula P P707
BKT Larkeisa S055 NB < Beckton Larkeisa P688 CH

Beckton Nebula T398 V3 < Beckton Nebula L P093
Beckton Minerva J615 VG

BECKTON MINERVA Y654 N
Beckton Minerva M369 LO < Beckton Loki F251
Beckton Minerva H403 LN

BWt	72
WR	109
ADG	3.97
YR	108
Scr.	37
Fr.	5.0

DAM	
Age	4
Wt	1170
Wean Pct.	53%
Cow Eff.	112

Calv.Ease	BW	WW	YW	Milk	HPG	Stay	Maint.En.
EPDs	16	-4.5	58	98	27	16	4.0
Acc.	(.44)	(.65)	(.60)	(.59)	(.33)	(.10)	(.27)
Marb	+.54 (.28)		REA +.02 (.43)		Bfat +.05 (.22)		

★★★★★ for Growth, Gainability, Marbling, Calving Ease.

B-1 BECKTON HUGHES C463 N2
1-A 100% # 3487375 Tattoo: BKT5 C463

Birth: 3-25-15

Basin Hobo 0545 < Basin Hobo 79E
Basin Erica 330E

BIEBER H HUGHES W109
Ref. B < Red Brylor New Trend 22
Basin Rose 06T0 < Basin Rose F521

Beckton Nexus L016 < Beckton Neptune R1 J245
Beckton Coca J276 CL

BECKTON LAKME T689 NX
Beckton Lakme M669 EP < Beckton Epic K F075
Beckton Lakme F560 TP

BWt	80
WR	111
ADG	3.79
YR	106
Scr.	36
Fr.	5.0

DAM	
Age	8
Wt	1340
Wean Pct.	51%
Cow Eff.	108

Calv.Ease	BW	WW	YW	Milk	HPG	Stay	Maint.En.
EPDs	14	-2.5	68	97	24	14	17
Acc.	(.33)	(.59)	(.55)	(.55)	(.26)	(.12)	(.21)
Marb	+.32 (.26)		REA +.09 (.35)		Bfat +.04 (.22)		

★★★★★ for Growth, Gainability, Marbling, Calving Ease.

A-5 BECKTON ACCENT E172 L3
1-A 100% # 3777901 Tattoo: BKB7 E172

Birth: 3-7-17

Beckton Cody K1 P014 < Beckton Cody KH M390
Beckton Rose M126 WR

BECKTON ACCENT W180 C2
Ref. A-1 < Beckton Cherokee N N479
Beckton Christy R046 CQ < Beckton Christy N740 HR

Beckton Likable U130 L2 < Beckton Likable S633
Beckton Kit S478 LN

BECKTON INDIGO Y406 L
Beckton Indigo R745 WR < Beckton Warrior CL M686
Beckton Indigo M514 CH

BWt	81
WR	112
ADG	3.67
YR	116
Scr.	39
Fr.	6.0

DAM	
Age	6
Wt	1095
Wean Pct.	58%
Cow Eff.	121

Calv.Ease	BW	WW	YW	Milk	HPG	Stay	Maint.En.
EPDs	15	-4.1	55	88	26	12	22
Acc.	(.35)	(.59)	(.52)	(.52)	(.22)	(.10)	(.22)
Marb	+.28 (.24)		REA +.20 (.34)		Bfat +.02 (.24)		

★★★★★ for Low Maintenance, Growth, Gainability, Marbling, Rib-eye area, High Cow Efficiency, Calving Ease.

B-2 BECKTON HUGHES F076 H3
1-A 100% # 3987998 Tattoo: BKT8 F076

Birth: 2-25-18

Bieber H Hughes W109 < Basin Hobo 0545
Basin Rose 06T0

BECKTON HUGHES D589 S2
Ref. B < Beckton Scamp X494 E3
Beckton Sierra Z353 S < Beckton Sierra X555 N

Bieber H Hughes W109 < Basin Hobo 0545
Basin Rose 06T0

BECKTON EMERA D487 B
Beckton Emera A186 A < Beckton Accent W180 C2
Beckton Emera U675 CQ

BWt	64
WR	103
ADG	2.98
YR	103
Scr.	32
Fr.	5.5

DAM	
Age	2
Wt	930
Wean Pct.	51%
Cow Eff.	106

Calv.Ease	BW	WW	YW	Milk	HPG	Stay	Maint.En.
EPDs	18	-3.7	65	103	26	16	16
Acc.	(.29)	(.43)	(.40)	(.40)	(.18)	(.06)	(.13)
Marb	+.30 (.23)		REA +.05 (.27)		Bfat +.04 (.18)		

★★★★★ for Low Maintenance, Marbling, Calving Ease.

• Reference Sires •

C-1 BECKTON CARDINAL E673 L
1-A 100% # 3776785 Tattoo: BKT7 E673

Birth: 4-12-17

TR DOUBLE EAGLE ZT220
Ref. C

BECKTON LARKABA A911 L

TR Ricardo DOS
Beckton Lana U182 JC

BFCK Cherokee Cnyn 4912
TR Dyna LT111

Beckton Justice C1 R483
Beckton Lana H544 WR

Beckton Legend S670
Beckton Lana S669 EP

Beckton Warhawk N560
Beckton Larkaba P783 JL

BWt 51
WR 104
ADG 2.69
YR 97
Scr. 33
Fr. 5.0

DAM		Calv.Ease	BW	WW	YW	Milk	HPG	Stay	Maint.En.
Age	4	EPDs 23	-7.4	60	96	27	13	17	0.0
Wt	1035	Acc. (.30)	(.58)	(.53)	(.55)	(.20)	(.06)	(.16)	(.24)
Wean Pct.	51%	Marb +.58 (.21)		REA +.38 (.30)		Bfat +.04 (.17)			
Cow Eff.	108								

D-2 BECKTON DOMINOR D254 N8
1-A 100% # 3551799 Tattoo: BKT6 D254

Birth: 3-15-16

BECKTON DOMINOR A378 W7
Ref. D

BECKTON INDIGO W772 N

Beckton Dominor Y005 V6
Beckton Lana Y541 W

Beckton Dominor W640 C5
Beckton Belga W108 V

Beckton Warrior T248 L5
Beckton Lana S074 EP

Beckton Nebula T398 V3
Beckton Minerva J615 VG

TR Julian LT151
Beckton Indigo N467 LO

BWt 67
WR 101
ADG 4.72
YR 110
Scr. 41
Fr. 5.5

DAM		Calv.Ease	BW	WW	YW	Milk	HPG	Stay	Maint.En.
Age	7	EPDs 20	-5.7	46	81	30	14	20	-1.0
Wt	1090	Acc. (.34)	(.64)	(.58)	(.60)	(.19)	(.08)	(.17)	(.63)
Wean Pct.	50%	Marb +.45 (.21)		REA +.24 (.36)		Bfat +.04 (.21)			
Cow Eff.	106								

★★★★★ for Low Maintenance, Marbling, Rib-eye area, Calving Ease.

★★★★★ for Low Maintenance, Growth, Gainability, Marbling, Rib-eye area, Calving Ease.

C-2 BECKTON CARDINAL F175 L3
1-A 100% # 3987898 Tattoo: BKT8 F175

Birth: 3-9-18

BECKTON CARDINAL D010 W2
Ref. C

BECKTON LARKABA B428 L

Beckton Cardinal B074 N
Beckton Firefly B052 W

TR Double Eagle ZT220
BKT Pine Marie Z250 N

Beckton Warrior Z936 N6
Beckton Firefly Z663 N

Beckton Likable U130 L2
Beckton Kit S478 LN

Beckton Julian U699 L5
Beckton Larkaba U475 CT

BWt 60
WR 104
ADG 2.83
YR 103
Scr. 34
Fr. 5.0

DAM		Calv.Ease	BW	WW	YW	Milk	HPG	Stay	Maint.En.
Age	4	EPDs 23	-8.5	50	87	23	14	18	-8.0
Wt	990	Acc. (.30)	(.46)	(.41)	(.43)	(.18)	(.04)	(.17)	(.44)
Wean Pct.	54%	Marb +.47 (.20)		REA +.02 (.28)		Bfat +.04 (.17)			
Cow Eff.	114								

★★★★★ for Low Maintenance, Marbling, Calving Ease.

D-3 BECKTON DOMINOR D495 W8
1-A 100% # 3551236 Tattoo: BSF6 D495

Birth: 3-25-16

BECKTON DOMINOR A378 W7
Ref. D

BECKTON ENCINO X642 W

Beckton Dominor Y005 V6
Beckton Lana Y541 W

Beckton Dominor W640 C5
Beckton Belga W108 V

Beckton Warrior T248 L5
Beckton Lana S074 EP

Beckton Warrior N645 T1
Beckton Kit R503 LN

Beckton Warrior T248 L5
Beckton Encino S090 JT

Beckton Jet L P491
Beckton Encino P300 LN

BWt 62
WR 102
ADG 3.67
YR 104
Scr. 35
Fr. 5.0

DAM		Calv.Ease	BW	WW	YW	Milk	HPG	Stay	Maint.En.
Age	6	EPDs 20	-6.0	45	76	27	14	16	-3.0
Wt	1030	Acc. (.33)	(.57)	(.51)	(.51)	(.23)	(.07)	(.15)	(.58)
Wean Pct.	55%	Marb +.47 (.26)		REA +.16 (.35)		Bfat +.04 (.20)			
Cow Eff.	115								

★★★★★ for Low Maintenance, Gainability, Marbling, Rib-eye area, Calving Ease.

D-1 BECKTON DOMINOR Y052 N6
1-A 100% # 1451544 Tattoo: BKT1 Y052

Birth: 3-3-11

BECKTON DOMINOR W640 C5
Ref. D

BECKTON INDIGO W772 N

Beckton Dominor Z1 R610
Beckton Sierra K557 LO

Beckton Cherokee N N479
Beckton Mona N342 HU

Beckton Nebula T398 V3
Beckton Minerva J615 VG

Beckton Dominor A378 W7
Beckton Indigo T613 JT

Beckton Dominor ZC M919
Beckton Sierra K557 LO

Beckton Nebula L P093
Beckton Minerva J615 VG

TR Julian LT151
Beckton Indigo N467 LO

BWt 62
WR 106
ADG 3.80
YR 110
Scr. 34
Fr. 5.5

DAM		Calv.Ease	BW	WW	YW	Milk	HPG	Stay	Maint.En.
Age	2	EPDs 17	-4.0	48	84	22	16	17	-1.0
Wt	700	Acc. (.34)	(.54)	(.49)	(.49)	(.32)	(.34)	(.23)	(.59)
Wean Pct.	77%	Marb +.34 (.28)		REA +.04 (.35)		Bfat +.05 (.25)			
Cow Eff.	163								

★★★★★ for Low Maintenance, Growth, Gainability, Marbling, High Cow Efficiency, Calving Ease.

D-4 BECKTON DOMINOR E693 D9
1-A 100% # 3778029 Tattoo: BKB7 E693

Birth: 4-14-17

BECKTON DOMINOR C052 E8
Ref. D

BECKTON CHRISTY C149 D

Beckton Dominor A378 W7
Beckton Scarlett A406 E

Beckton Dominor Y005 V6
Beckton Lana Y541 W

Beckton Dominor Z1 R610
Beckton Sierra K557 LO

Beckton Epic T330 L5
Beckton Scarlett W497 J

Beckton Dominor A378 W7
Beckton Lana Y541 W

Beckton Dominor Y005 V6
Beckton Lana Y541 W

Beckton Nebula P P707
Beckton Christy A234 N

Beckton Dominor Y005 V6
Beckton Lana Y541 W

Beckton Nebula P P707
Beckton Christy X526 L

BWt 67
WR 109
ADG 2.86
YR 105
Scr. 35
Fr. 5.0

DAM		Calv.Ease	BW	WW	YW	Milk	HPG	Stay	Maint.En.
Age	2	EPDs 17	-3.4	53	95	35	14	16	-1.0
Wt	732	Acc. (.25)	(.52)	(.47)	(.47)	(.18)	(.03)	(.05)	(.49)
Wean Pct.	60%	Marb +.68 (.23)		REA +.09 (.29)		Bfat +.04 (.17)			
Cow Eff.	126								

★★★★★ for Low Maintenance, Marbling, High Cow Efficiency, Calving Ease.

• Reference Sires •

D-5 BECKTON DOMINOR F207 A9

1-A 100% # 3988710 Tattoo: BSF8 F207

Birth: 3-12-18

Beckton Dominor A378 W7 < Beckton Dominor Y005 V6
Beckton Lana Y541 W

BECKTON DOMINOR D254 N8
Ref. D-2 < Beckton Nebula T398 V3
Beckton Indigo W772 N < Beckton Indigo T613 JT

Beckton Accent B150 N4 < Beckton Accent Y260 L3
Beckton LARKEISA S055 NB

BECKTON LARKABA D014 A
Beckton Larkaba B352 A < Beckton Accent Y260 L3
Beckton Larkaba Y156 N

BWt	85
WR	110
ADG	3.88
YR	115
Scr.	34
Fr.	6.0

DAM		Calv.Ease	BW	WW	YW	Milk	HPG	Stay	Maint.En.	
Age	2	EPDs	16	-2.1	62	104	29	13	20	3.0
Wt	865	Acc.	(.30)	(.45)	(.40)	(.40)	(.16)	(.02)	(.09)	(.44)
Wean Pct.	58%	Marb	+.53 (.17)		REA	+.07 (.27)		Bfat	+.05 (.17)	
Cow Eff.	122									

H-1 BECKTON HERITAGE C477 J4

1-A 100% # 3487214 Tattoo: BKT5 C477

Birth: 3-28-15

Beckton Heritage T270 J2 < Beckton Heritage N013
Beckton Coca P602 JL

BECKTON HERITAGE X403 L3
Ref. H < Beckton Lancer TE F363
Beckton Indigo H150 LN < Beckton Indigo F376 CT

Beckton Julian U699 L5 < Beckton Julian G1 J526
Beckton Ruth Z858 J < Beckton Rose L311 LN

Beckton Jet L P491
Beckton Ruth U557 JT < Beckton Ruth P591 LN

BWt	77
WR	103
ADG	4.25
YR	111
Scr.	41
Fr.	5.0

DAM		Calv.Ease	BW	WW	YW	Milk	HPG	Stay	Maint.En.	
Age	3	EPDs	14	-2.3	58	97	31	11	15	-3.0
Wt	1025	Acc.	(.41)	(.63)	(.58)	(.57)	(.27)	(.08)	(.24)	(.61)
Wean Pct.	54%	Marb	+.45 (.27)		REA	+.27 (.40)		Bfat	+.04 (.21)	
Cow Eff.	113									

★★★★★ for Growth, Gainability, Marbling, High Cow Efficiency, Calving Ease.

★★★★★ for Low Maintenance, Growth, Gainability, Marbling, Rib-eye area, Calving Ease.

E-1 BECKTON EPIC D001 L7

1-A 100% # 3551655 Tattoo: BKT6 D001

Birth: 2-4-16

Beckton Epic U749 D5 < Beckton Epic K4 N795
Beckton Denise R308 DM

BECKTON EPIC B483 N6
Ref. E < Beckton Nebula T269 E2
BKT Pine Marie X339 N < BKT Pine Marie S467 JE

Beckton Legend U331 E2 < Beckton Legend S670
Beckton MONA B713 L < Beckton Lana S669 EP

Beckton Jet L P491
Beckton Mona U564 JT < Beckton Mona P874 WR

BWt	63
WR	109
ADG	4.78
YR	119
Scr.	34
Fr.	5.5

DAM		Calv.Ease	BW	WW	YW	Milk	HPG	Stay	Maint.En.	
Age	2	EPDs	17	-5.8	51	98	27	11	15	2.0
Wt	770	Acc.	(.27)	(.57)	(.53)	(.52)	(.17)	(.07)	(.17)	(.56)
Wean Pct.	57%	Marb	+.39 (.20)		REA	+.15 (.32)		Bfat	+.04 (.17)	
Cow Eff.	120									

★★★★★ for Growth, Gainability, Marbling, Rib-eye area, High Cow Efficiency, Calving Ease.

H-2 BECKTON HERITAGE F615 L5

1-A 100% # 3988420 Tattoo: BSF8 F615

Birth: 4-4-18

Beckton Heritage T270 J2 < Beckton Heritage X403 L3
Beckton Indigo H150 LN

BECKTON HERITAGE B612 J4
Ref. H < Beckton Justice G302
Beckton Lana N291 JC < Beckton Lana H725 CH

Beckton Likable U130 L2 < Beckton Likable S633
Beckton MONA X022 L < Beckton Kit S478 LN

Beckton Cody K2 R168
Beckton Mona U584 CD < Beckton Mona P539 CH

BWt	76
WR	119
ADG	3.50
YR	114
Scr.	35
Fr.	5.5

DAM		Calv.Ease	BW	WW	YW	Milk	HPG	Stay	Maint.En.	
Age	8	EPDs	8	-2.5	67	92	24	13	16	0.0
Wt	1105	Acc.	(.32)	(.46)	(.41)	(.42)	(.20)	(.05)	(.15)	(.45)
Wean Pct.	58%	Marb	+.41 (.20)		REA	+.08 (.30)		Bfat	+.04 (.19)	
Cow Eff.	121									

★★★★★ for Low Maintenance, Growth, Gainability, Marbling, High Cow Efficiency, Calving Ease.

E-2 BECKTON EPIC F279 A7

1-A 100% # 3987780 Tattoo: BKT8 F279

Birth: 3-16-18

Beckton Epic U749 D5 < Beckton Epic K4 N795
Beckton Denise R308 DM

BECKTON EPIC Z674 E6
Ref. E < Beckton Epic K6 S569
Beckton Indigo U504 EP < Beckton Indigo S016 NB

Beckton Accent W180 C2 < Beckton Cody K1 P014
Beckton FIREFLY B511 A < Beckton Christy R046 CQ

Beckton Hasten U108 J3
Beckton Firefly X336 H < Beckton Firefly U337 HH

BWt	80
WR	123
ADG	3.44
YR	119
Scr.	36
Fr.	6.0

DAM		Calv.Ease	BW	WW	YW	Milk	HPG	Stay	Maint.En.	
Age	4	EPDs	18	-3.1	67	113	29	11	14	3.0
Wt	1200	Acc.	(.31)	(.47)	(.43)	(.44)	(.20)	(.04)	(.16)	(.44)
Wean Pct.	53%	Marb	+.37 (.23)		REA	+.16 (.30)		Bfat	+.05 (.19)	
Cow Eff.	112									

★★★★★ for Growth, Marbling, Rib-eye area, Calving Ease.

J-1 BECKTON JULIAN GG B571

1-A 100% # 387580 Tattoo: WF2 B571

Birth: 3-27-92

Beckton Julian 6592 < Beckton Trojan 5253
Lchmn Christy 2339

BECKTON JULIAN 7526G
Ref. < Beckton Gisa 4454
Bkt Belga 6746 GS < Beckton Lalaxigu -2

Beckton Julian 7526G < Beckton Julian 6592
Bkt Belga 6746 GS < Bkt Belga 6746 GS

BKT MARTA 9A13 JL < Beckton Xime 4736
Bkt Marta 6498 XM < Beckton Marwa -K

BWt	65
WR	113
ADG	3.18
YR	112
Scr.	NA
Fr.	5.0

DAM		Calv.Ease	BW	WW	YW	Milk	HPG	Stay	Maint.En.	
Age	3	EPDs	20	-6.6	50	77	23	15	15	-6.0
Wt	1015	Acc.	(.87)	(.94)	(.92)	(.92)	(.90)	(.90)	(.77)	(.70)
Wean Pct.	56%	Marb	+.42 (.73)		REA	-.12 (.81)		Bfat	+.05 (.72)	
Cow Eff.	118									

★★★★★ for Low Maintenance, Growth, Marbling, High Cow Efficiency, Calving Ease.

• Reference Sires •

J-2 BECKTON JULIAN Z382 J7
1-A 100% # 1544962 Tattoo: BKT2 Z382

Birth: 3-20-12

Beckton Julian U699 L5 < Beckton Julian G1 J526
Beckton Rose L311 LN

BECKTON JULIAN X721 E6
Ref. J < Beckton Epic K6 S569
Beckton Lana U329 EP < Beckton Lana S477 LN

Beckton Julian U699 L5 < Beckton Julian G1 J526
Beckton Rose L311 LN

BECKTON LARKABA X064 J
Beckton Larkaba U475 CT < BKT Clifftop TP R288
Beckton Larkaba R809 NB

BWt	47
WR	125
ADG	2.99
YR	113
Scr.	33
Fr.	5.0

DAM	
Age	2
Wt	755
Wean Pct.	80%
Cow Eff.	168

Calv.Ease	BW	WW	YW	Milk	HPG	Stay	Maint.En.
EPDs	23	-8.6	56	88	28	12	-5.0
Acc.	(.48)	(.70)	(.66)	(.67)	(.44)	(.31)	(.64)
Marb	+.44 (.36)		REA -.08 (.46)		Bfat +.05 (.31)		

★★★★★ for Low Maintenance, Growth, Marbling, High Cow Efficiency, Calving Ease.

J-5 BECKTON JULIAN F067 L7
1-A 100% # 3988836 Tattoo: BSF8 F067

Birth: 2-23-18

Beckton Julian X465 J5 < Beckton Julian G5 S107
Beckton Suffeina P643 JL

BECKTON JULIAN D551 C6
Ref. J < Beckton Cody K1 P014
Beckton Tamara W550 A < Beckton Tamara R175 CQ

Beckton Likable Z057 L4 < Beckton Likable X445 J3
Beckton Minola X107 L < Beckton Minola X107 L

BECKTON INDIGO D786 L
Beckton Indigo Y026 N < Beckton Nebula W065 C3
Beckton Indigo W866 A

BWt	53
WR	113
ADG	4.28
YR	120
Scr.	34
Fr.	6.0

DAM	
Age	2
Wt	800
Wean Pct.	61%
Cow Eff.	128

Calv.Ease	BW	WW	YW	Milk	HPG	Stay	Maint.En.
EPDs	18	-2.9	78	141	28	15	3.0
Acc.	(.31)	(.45)	(.40)	(.41)	(.19)	(.02)	(.43)
Marb	+.51 (.19)		REA +.08 (.29)		Bfat +.04 (.16)		

★★★★★ for Growth, Gainability, Marbling, High Cow Efficiency, Calving Ease.

J-3 BECKTON JULIAN A434 N6
1-A 100% # 1626302 Tattoo: BKT3 A434

Birth: 3-27-13

Beckton Julian G5 S107 < Beckton Julian GJ P535
Beckton Minola P826 DM

BECKTON JULIAN X465 J5
Ref. J < Beckton Julian GG B571
Beckton Suffeina P643 JL < Bkt Suffeina A828 DM

Beckton Nexus L016 < Beckton Neptune R1 J245
Beckton Coca J276 CL

BECKTON LAKME T689 NX
Beckton Lakme M669 EP < Beckton Epic K F075
Beckton Lakme F560 TP

BWt	75
WR	112
ADG	4.16
YR	112
Scr.	33
Fr.	6.0

DAM	
Age	6
Wt	1085
Wean Pct.	57%
Cow Eff.	121

Calv.Ease	BW	WW	YW	Milk	HPG	Stay	Maint.En.
EPDs	11	-0.9	70	112	22	12	3.0
Acc.	(.48)	(.57)	(.54)	(.55)	(.31)	(.25)	(.33)
Marb	+.47 (.37)		REA -.14 (.46)		Bfat +.03 (.30)		

★★★★★ for Growth, Gainability, Marbling, High Cow Efficiency.

L-1 BECKTON LIKABLE Y124 L3
1-A 100% # 1451666 Tattoo: BSF1 Y124

Birth: 3-15-11

Beckton Likable S633 < Beckton Lancer F442 T
Beckton Kit F468 JL

BECKTON LIKABLE U130 L2
Ref. L < Beckton Lancer F442 T
Beckton Kit S478 LN < Beckton Kit F468 JL

Beckton Lasso P741 < Beckton Lancer T1 H080
Beckton Ruth G534 NP

BKT PINE MARIE S802 LO
BKT Pine Marie P475 LN < Beckton Lancer T4 J536
Bkt Pine Marie LC30 CD

BWt	72
WR	109
ADG	3.50
YR	112
Scr.	38
Fr.	5.5

DAM	
Age	5
Wt	1080
Wean Pct.	58%
Cow Eff.	121

Calv.Ease	BW	WW	YW	Milk	HPG	Stay	Maint.En.
EPDs	22	-6.4	47	76	27	11	0.0
Acc.	(.51)	(.74)	(.69)	(.70)	(.50)	(.36)	(.35)
Marb	+.45 (.35)		REA -.18 (.50)		Bfat +.05 (.26)		

★★★★★ for Low Maintenance, Growth, Gainability, Marbling, High Cow Efficiency, Calving Ease.

J-4 BECKTON JULIAN E423 N8
1-A 100% # 3777967 Tattoo: BSF7 E423

Birth: 3-24-17

Beckton Julian X721 E6 < Beckton Julian U699 L5
Beckton Lana U329 EP

BECKTON JULIAN Z382 J7
Ref. J-2 < Beckton Julian U699 L5
Beckton Larkaba X064 J < Beckton Larkaba U475 CT

Beckton Nebula Z111 N5 < Beckton Nebula X096 N4
Beckton Minola X670 N

BECKTON BELGA B004 N
Beckton Belga Z031 N < Beckton Nebula X096 N4
Beckton Belga X736 E

BWt	53
WR	106
ADG	2.97
YR	105
Scr.	37
Fr.	5.0

DAM	
Age	3
Wt	1010
Wean Pct.	52%
Cow Eff.	109

Calv.Ease	BW	WW	YW	Milk	HPG	Stay	Maint.En.
EPDs	23	-8.9	50	79	29	12	0.0
Acc.	(.35)	(.62)	(.57)	(.57)	(.25)	(.17)	(.61)
Marb	+.55 (.24)		REA -.33 (.33)		Bfat +.04 (.23)		

★★★★★ for Low Maintenance, Growth, Marbling, Calving Ease.

L-2 BECKTON LIKABLE B032 C5
1-A 100% # 1705725 Tattoo: BKB4 B032

Birth: 2-17-14

Beckton Likable X445 J3 < Beckton Likable U130 L2
Beckton Indigo U658 JL

BECKTON LIKABLE Z057 L4
Ref. L < Beckton Likable U120 L2
Beckton Minola X107 L < Beckton Minola U188 NB

Beckton Clifftop W577 E3 < BKT Clifftop TP R288
BKT Pine Marie R213 EP

BECKTON MONA Z270 C
Beckton Mona U584 CD < Beckton Cody K2 R168
Beckton Mona P539 CH

BWt	63
WR	110
ADG	4.72
YR	119
Scr.	35
Fr.	6.0

DAM	
Age	2
Wt	884
Wean Pct.	50%
Cow Eff.	106

Calv.Ease	BW	WW	YW	Milk	HPG	Stay	Maint.En.
EPDs	18	-5.9	52	109	22	14	20
Acc.	(.51)	(.74)	(.69)	(.70)	(.33)	(.02)	(.19)
Marb	+.55 (.33)		REA +.07 (.43)		Bfat +.03 (.23)		

★★★★★ for Growth, Gainability, Marbling, Calving Ease.

• Reference Sires •

L-3 BECKTON LIKABLE D432 N3
1-A 100% # 3551764 Tattoo: BKT6 D432

Birth: 3-23-16
 Beckton Likable S633
BECKTON LIKABLE U130 L2
 Ref. L Beckton Kit S478 LN
 Beckton Lancer F442 T
 Beckton Kit F468 JL
 Beckton Lancer F442 T
 Beckton Kit F468 JL
 Beckton Nebula T054 H3
BECKTON FIREFLY W013 N
 Beckton Firefly T003 JC
 Beckton Pine Marie R401 HU
 Beckton Justice C1 R483
 Beckton Firefly R064 NW

BWt	75
WR	94
ADG	4.05
YR	105
Scr.	36
Fr.	5.5

DAM	
Age	7
Wt	890
Wean Pct.	59%
Cow Eff.	123

Calv.Ease	BW	WW	YW	Milk	HPG	Stay	Maint.En.
EPDs	18	-3.8	51	84	23	11	-8.0
Acc.	(.39)	(.61)	(.58)	(.58)	(.29)	(.17)	(.61)
Marb	+.34 (.25)		REA +.21 (.39)		Bfat +.03 (.24)		

L-6 BECKTON LIKABLE F242 D4
1-A 100% # 3987814 Tattoo: BKT8 F242

Birth: 3-14-18
 Beckton Likable U130 L2
BECKTON LIKABLE Y124 L3
 Ref. L-2 BKT Pine Marie S802 LO
 Beckton Lasso P741
 BKT Pine Marie P475 LN
 Beckton Dominor W640 C5
BECKTON FIREFLY A022 D
 Beckton Firefly U801 NB
 Beckton Nebula N R573
 Beckton Firefly K180 CH

BWt	52
WR	112
ADG	2.94
YR	106
Scr.	35
Fr.	5.0

DAM	
Age	5
Wt	1200
Wean Pct.	53%
Cow Eff.	112

Calv.Ease	BW	WW	YW	Milk	HPG	Stay	Maint.En.
EPDs	23	-8.0	49	74	28	12	17
Acc.	(.31)	(.47)	(.41)	(.43)	(.21)	(.08)	(.13)
Marb	+.31 (.21)		REA -.07 (.28)		Bfat +.04 (.17)		

★★★★★ for Low Maintenance, Gainability, Marbling, Rib-eye area, High Cow Efficiency, Calving Ease.

★★★★★ for Growth, Marbling, Calving Ease.

L-4 BECKTON LIKABLE E391 N4
1-A 100% # 3777591 Tattoo: BKB7 E391

Birth: 3-23-17
 Beckton Likable U130 L2
BECKTON LIKABLE Y124 L3
 Ref. L-2 BKT Pine Marie S802 LO
 Beckton Nebula T398 V3
BECKTON LANA X466 N
 Beckton Lana T226 NB
 Beckton Likable S633
 Beckton Kit S478 LN
 Beckton Lasso P741
 BKT Pine Marie P475 LN
 Beckton Nebula L P093
 Beckton Minerva J615 V3
 Beckton Nebula E P084
 Beckton Lana P026 DM

BWt	83
WR	115
ADG	3.44
YR	115
Scr.	37
Fr.	6.0

DAM	
Age	7
Wt	1220
Wean Pct.	53%
Cow Eff.	111

Calv.Ease	BW	WW	YW	Milk	HPG	Stay	Maint.En.
EPDs	13	-2.7	67	104	28	12	21
Acc.	(.34)	(.62)	(.56)	(.56)	(.22)	(.08)	(.17)
Marb	+.44 (.24)		REA -.14 (.32)		Bfat +.05 (.20)		

★★★★★ for Growth, Marbling, Calving Ease.

L-7 BECKTON LIKABLE F287 J6
1-A 100% # 3987766 Tattoo: BKT8 F287

Birth: 3-16-18
 Beckton Likable Z057 L4
BECKTON LIKABLE B032 C5
 Ref. L-2 Beckton Mona Z270 C
 Beckton Julian U699 L5
BECKTON LARKABA X064 J
 Beckton Larkaba U475 CT
 Beckton Likable X445 J3
 Beckton Minola X107 L
 Beckton Clifftop W577 E3
 Beckton Mona U584 CD
 Beckton Julian G1 J526
 Beckton Rose L311 LN
 BKT Clifftop TP R288
 Beckton Larkaba R809 NB

BWt	56
WR	102
ADG	3.56
YR	108
Scr.	35
Fr.	5.5

DAM	
Age	8
Wt	915
Wean Pct.	60%
Cow Eff.	126

Calv.Ease	BW	WW	YW	Milk	HPG	Stay	Maint.En.
EPDs	22	-9.4	47	91	24	13	20
Acc.	(.30)	(.44)	(.41)	(.42)	(.22)	(.07)	(.14)
Marb	+.61 (.23)		REA -.12 (.29)		Bfat +.05 (.18)		

★★★★★ for Low Maintenance, Growth, Gainability, Marbling, High Cow Efficiency, Calving Ease.

L-5 BECKTON LIKABLE F237 E6
1-A 100% # 3987820 Tattoo: BKT8 F237

Birth: 3-14-18
 Beckton Likable Z057 L4
BECKTON LIKABLE B032 C5
 Ref. L-2 Beckton Mona Z270 C
 Beckton Epic U749 D5
BECKTON EOLA Y412 E
 Beckton Eola T435 NB
 Beckton Likable X445 J3
 Beckton Minola X107 L
 Beckton Clifftop W577 E3
 Beckton Mona U584 CD
 Beckton Epic K4 N795
 Beckton Denise R308 DM
 Beckton Nebula L P093
 Beckton Eola P336 CE

BWt	64
WR	106
ADG	3.22
YR	106
Scr.	35
Fr.	5.5

DAM	
Age	7
Wt	1185
Wean Pct.	51%
Cow Eff.	107

Calv.Ease	BW	WW	YW	Milk	HPG	Stay	Maint.En.
EPDs	21	-7.7	46	88	25	13	17
Acc.	(.30)	(.46)	(.41)	(.42)	(.21)	(.11)	(.45)
Marb	+.43 (.22)		REA -.02 (.29)		Bfat +.04 (.19)		

★★★★★ for Growth, Marbling, Calving Ease.

L-8 BECKTON LIKABLE F520 N5
1-A 100% # 3987476 Tattoo: BKT8 F520

Birth: 3-27-18
 Beckton Likable X445 J3
BECKTON LIKABLE Z057 L4
 Ref. L Beckton Minola X107 L
 Beckton New Era Y194
BECKTON SIERRA A836 N
 Beckton Sierra S847 WR
 Beckton Likable U130 L2
 Beckton Indigo U658 JL
 Beckton Likable U120 L2
 Beckton Minola U188 NB
 Beckton Nebula P P707
 BKT Larkeisa T310 JC
 Beckton Warrior T1 H281
 Beckton Sierra N766 HR

BWt	86
WR	118
ADG	3.50
YR	121
Scr.	39
Fr.	5.5

DAM	
Age	5
Wt	1290
Wean Pct.	52%
Cow Eff.	110

Calv.Ease	BW	WW	YW	Milk	HPG	Stay	Maint.En.
EPDs	7	-0.2	76	132	19	14	17
Acc.	(.33)	(.48)	(.44)	(.45)	(.23)	(.02)	(.18)
Marb	+.41 (.25)		REA +.24 (.31)		Bfat +.02 (.19)		

★★★★★ for Growth, Gainability, Marbling, Rib-eye area.

• Reference Sires •

L-9 BECKTON LIKABLE F682 S5

1-A 100% # 3988358 Tattoo: BSF8 F682

Birth: 4-10-18

Beckton Likable X445 J3 < Beckton Likable U130 L2
Beckton Indigo U658 JL

BECKTON LIKABLE Z057 L4
Ref. L < Beckton Likable U120 L2
Beckton Minola X107 L < Beckton Minola U188 NB

Beckton Scamp A627 J4 < Beckton Scamp X494 E3
Beckton Serena R023 JC

BECKTON LANA C073 S
Beckton Lana A083 A < Beckton Accent Y260 L3
Beckton Lana Y130 N

BWt	60
WR	114
ADG	3.33
YR	122
Scr.	36
Fr.	5.5

DAM	
Age	3
Wt	850
Wean Pct.	60%
Cow Eff.	126

Calv.Ease	BW	WW	YW	Milk	HPG	Stay	Maint.En.	
EPDs	18	-5.9	62	110	25	8	18	-8.0
Acc.	(.32)	(.48)	(.43)	(.44)	(.21)	(.01)	(.17)	(.44)
Marb	+.48 (.21)		REA	+.16 (.30)		Bfat	+.02 (.18)	

★★★★★ for Low Maintenance, Growth, Marbling, Rib-eye area, High Cow Efficiency, Calving Ease.

N-2 BECKTON NEW ERA Y194

1-A 100% # 1451309 Tattoo: BKB1 Y194

Birth: 3-20-11

Beckton Nebula M045 < Beckton Neptune R2 K065
Beckton Belga K285 JL

BECKTON NEBULA P P707
Ref. N-1 < Beckton Epic K1 K863
Beckton Lana M809 EP < Beckton Lana K253 DM

Beckton Justice C1 R483 < Beckton Justice CH M056
Beckton Tamara J124 HR

BKT LARKEISA T310 JC
BKT Larkeisa R775 JC < Beckton Justice C K449
BKT Larkeisa L149 CK

BWt	67
WR	132
ADG	3.50
YR	121
Scr.	36
Fr.	5.5

DAM	
Age	4
Wt	950
Wean Pct.	82%
Cow Eff.	174

Calv.Ease	BW	WW	YW	Milk	HPG	Stay	Maint.En.	
EPDs	16	-3.5	59	97	26	12	18	3.0
Acc.	(.67)	(.84)	(.81)	(.82)	(.68)	(.62)	(.47)	(.67)
Marb	+.42 (.55)		REA	-.15 (.59)		Bfat	+.03 (.42)	

★★★★★ for Growth, Gainability, Marbling, High Cow Efficiency, Calving Ease.

L-10 BECKTON LIKABLE F816 A4

1-A 100% # 3988238 Tattoo: BSF8 F816

Birth: 4-28-18

Beckton Likable U130 L2 < Beckton Likable S633
Beckton Kit S478 LN

BECKTON LIKABLE B509 J3
Ref. L < Beckton Julian G2 M345
Beckton Coca T363 JL < Beckton Coca P435 CH

Beckton Accent Y312 N3 < Beckton Accent U777 C2
BKT Larkeisa S055 NB

BECKTON BARMAID B366 A
Beckton Barmaid X819 N < Beckton Nebula T398 V3
Beckton Barmaid R542 JE

BWt	79
WR	123
ADG	3.48
YR	117
Scr.	34
Fr.	6.0

DAM	
Age	4
Wt	1085
Wean Pct.	59%
Cow Eff.	123

Calv.Ease	BW	WW	YW	Milk	HPG	Stay	Maint.En.	
EPDs	11	-2.7	56	87	30	14	14	-6.0
Acc.	(.31)	(.47)	(.42)	(.41)	(.20)	(.04)	(.15)	(.45)
Marb	+.36 (.20)		REA	+.13 (.28)		Bfat	+.04 (.17)	

★★★★★ for Low Maintenance, Growth, Marbling, Rib-eye area, High Cow Efficiency, Calving Ease.

N-3 BECKTON NEBULA A773 L4

1-A 100% # 1625980 Tattoo: BKB3 A773

Birth: 4-13-13

Beckton Nebula L P093 < Beckton Nebula M045
Beckton Marta M021 LN

BECKTON NEBULA T398 V3
Ref. N < Beckton Vegas PK F485
Beckton Minerva J615 VG < Beckton Minerva F433 VG

Beckton Likable U130 L2 < Beckton Likable S633
Beckton Kit S478 LN

BECKTON MONA X022 L
Beckton Mona U584 CD < Beckton Cody K2 R168
Beckton Mona P539 CH

BWt	66
WR	118
ADG	3.54
YR	109
Scr.	36
Fr.	5.5

DAM	
Age	3
Wt	955
Wean Pct.	61%
Cow Eff.	128

Calv.Ease	BW	WW	YW	Milk	HPG	Stay	Maint.En.	
EPDs	13	-2.6	64	98	28	13	26	0.0
Acc.	(.40)	(.65)	(.62)	(.62)	(.36)	(.11)	(.29)	(.63)
Marb	+.30 (.24)		REA	+.11 (.40)		Bfat	+.03 (.21)	

★★★★★ for Low Maintenance, Growth, Gainability, Marbling, High Cow Efficiency, Calving Ease.

N-1 BECKTON NEBULA P P707

1-A 100% # 979031 Tattoo: BKT4 P707

Birth: 4-1-04

Beckton Neptune R2 K065 < Beckton Neptune RR B284
Beckton Lana C735 TP

BECKTON NEBULA M045
Ref. N < Beckton Julian GG B571
Beckton Belga K285 JL < Beckton Belga G493 HR

Beckton Epic K1 K863 < Beckton Epic KN H110
Beckton Rose H019 SC

BECKTON LANA M809 EP
Beckton Lana K253 DM < Beckton Dominor ZJ H657
Beckton Lana HA34 DM

BWt	68
WR	127
ADG	3.85
YR	122
Scr.	37
Fr.	5.0

DAM	
Age	2
Wt	890
Wean Pct.	71%
Cow Eff.	150

Calv.Ease	BW	WW	YW	Milk	HPG	Stay	Maint.En.	
EPDs	16	-5.8	53	93	24	12	18	-5.0
Acc.	(.83)	(.91)	(.90)	(.90)	(.86)	(.84)	(.70)	(.70)
Marb	+.70 (.70)		REA	-.32 (.76)		Bfat	+.06 (.68)	

★★★★★ for Low Maintenance, Growth, Gainability, Marbling, High Cow Efficiency, Calving Ease.

N-4 BECKTON NEW ERA C209 J2

1-A 100% # 3487198 Tattoo: BKT5 C209

Birth: 3-14-15

Beckton Nebula P P707 < Beckton Nebula M045
Beckton Lana M809 EP

BECKTON NEW ERA Y194
Ref. N-2 < Beckton Justice C1 R483
BKT Larkeisa T310 JC < BKT Larkeisa R775 JC

Beckton Julian W743 H5 < Beckton Julian G5 S107
Beckton Kit L399 HR

BECKTON MINERVA Y116 J
Beckton Minerva W081 N < Beckton Nebula G S237
Beckton Minerva F495 CH

BWt	78
WR	119
ADG	4.31
YR	115
Scr.	33
Fr.	5.0

DAM	
Age	4
Wt	1125
Wean Pct.	61%
Cow Eff.	128

Calv.Ease	BW	WW	YW	Milk	HPG	Stay	Maint.En.	
EPDs	11	-0.2	65	106	23	13	15	1.0
Acc.	(.39)	(.57)	(.52)	(.53)	(.28)	(.11)	(.24)	(.62)
Marb	+.44 (.27)		REA	-.09 (.40)		Bfat	+.02 (.25)	

★★★★★ for Growth, Gainability, Marbling, High Cow Efficiency.

• Reference Sires •

O-1 HALFMANN ALLEGIANT E835
1-A 100% # 3716947 Tattoo: BKB7 EH835

Birth: 2-22-17

LSF Takeover 9943W	<	HXC Conquest 4405P	BWt	67
LSF Wideload R5014 U8061	<	LSF Wideload R5014 U8061	WR	107
HALFMANN DIVERGENT C249	<	Beckton Nebula EN S347	ADG	NA
Ref. Beckton Eola U101 NB	<	Beckton Eola S011 NB	YR	105
Buf Crk The Right Kind U199	<	Buf Crk Lancer R017	Scr.	NA
HALFMANN CHIEF RK C258	<	Buf Crk Shoshone R353	Fr.	NA
Halfmann Chief DV Z707	<	Halfmann Dividend U398		
	<	Halfmann Chief S506		

DAM	Calv.Ease	BW	WW	YW	Milk	HPG	Stay	Maint.En.
Age 2	EPDs 14	-3.8	45	69	27	12	16	-3.0
Wt NA	Acc. (.31)	(.50)	(.45)	(.44)	(.19)	(.18)	(.45)	
Wean Pct. NA	Marb +0.55	(.28)	REA -0.05	(.36)	Bfat +0.04	(.24)		
Cow Eff. NA								

★★★★★ for Low Maintenance, Growth, Marbling, Calving Ease.

R-1 BECKTON RANGER B006 D5
1-A 100% # 1705764 Tattoo: BSF4 B006

Birth: 2-11-14

Beckton Ranger T603 H3	<	Beckton Ranger 9479R	BWt	69
Beckton Rose N044 HU	<	Beckton Rose N044 HU	WR	113
BECKTON RANGER Z225 J4	<	Beckton Jet L P491	ADG	4.03
Ref. R Beckton Mona U564 JT	<	Beckton Mona P874 WR	YR	109
Beckton Dominor W640 C5	<	Beckton Dominor Z1 R610	Scr.	35
BECKTON SUFFEINA Z731 D	<	Beckton Mona R166 CQ	Fr.	6.0
Beckton Suffeina W471 W	<	Beckton Warrior N645 T1		
	<	Beckton Suffeina P671 LN		

DAM	Calv.Ease	BW	WW	YW	Milk	HPG	Stay	Maint.En.
Age 2	EPDs 16	-2.6	60	105	26	11	9	-1.0
Wt 918	Acc. (.42)	(.69)	(.64)	(.65)	(.32)	(.07)	(.17)	(.65)
Wean Pct. 54%	Marb +0.57	(.19)	REA +0.08	(.39)	Bfat +0.03	(.17)		
Cow Eff. 114								

★★★★★ for Low Maintenance, Growth, Gainability, Marbling, Calving Ease.

O-2 REDHILL 9B LANCER 11E
1-A 100% # 3627551 Tattoo: BKB7 ERH11

Birth: 1-3-17

Buf Crk The Right Kind U199	<	Buf Crk Lancer R017	BWt	85
Buf Crk Shoshone R353	<	Buf Crk Shoshone R353	WR	NA
REDHILL U199 LANCER 9B	<	Beckton Julian GG B571	ADG	NA
Ref. Buf Crk Redpride P154	<	MRM 832 8664 9005	YR	NA
Buf Crk Nice'N Easy T189	<	Buf Crk Medallion N328	Scr.	NA
REDHILL T189 BARMAID 190W	<	Buf Crk Redpride P154	Fr.	NA
1BWJ Barmaid 54P	<	BFCK Cherokee Cnyn 4912		
	<	Beckton Barmaid M554 CH		

DAM	Calv.Ease	BW	WW	YW	Milk	HPG	Stay	Maint.En.
Age 8	EPDs 8	-0.3	75	113	29	14	14	2.0
Wt NA	Acc. (.52)	(.55)	(.53)	(.54)	(.26)	(.32)	(.35)	(.60)
Wean Pct. NA	Marb +0.44	(.42)	REA -0.02	(.49)	Bfat +0.03	(.39)		
Cow Eff. NA								

★★★★★ for Marbling.

S-1 BECKTON SCAMP E175 N5
1-A 100% # 3776509 Tattoo: BKT7 E175

Birth: 3-7-17

Beckton Scamp X458 H3	<	Beckton Scamp T A825	BWt	78
BKT Pine Marie R401 HU	<	BKT Pine Marie R401 HU	WR	106
BECKTON SCAMP B720 L4	<	Beckton Likable U130 L2	ADG	4.06
Ref. S Beckton Larkaba Y448 L	<	Beckton Larkaba T655 NB	YR	114
Beckton Nebula T398 V3	<	Beckton Nebula L P093	Scr.	41
BECKTON BELGA W103 N	<	Beckton Minerva J615 VG	Fr.	5.5
Beckton Belga T551 EP	<	Beckton Epic K3 M606		
	<	Beckton Belga K285 JL		

DAM	Calv.Ease	BW	WW	YW	Milk	HPG	Stay	Maint.En.
Age 8	EPDs 21	-7.9	54	107	24	10	18	-4.0
Wt 1015	Acc. (.35)	(.62)	(.58)	(.59)	(.22)	(.04)	(.18)	(.25)
Wean Pct. 55%	Marb +0.37	(.22)	REA +0.15	(.34)	Bfat +0.03	(.18)		
Cow Eff. 116								

★★★★★ for Low Maintenance, Growth, Gainability, Marbling, Rib-eye area, High Cow Efficiency, Calving Ease.

O-3 SCHULER ORACLE-7142E
1-A 100% # 3778379 Tattoo: BKB7 ES142

Birth: 3-10-17

Red Crowfoot Ole's Oscar	<	Mlk Crk Cub 722	BWt	76
Red Crowfoot Omega 9179J	<	Red Crowfoot Omega 9179J	WR	98
SCHULER SUDDEN IMPACT 0004X	<	Basin Trend Setter 6074	ADG	NA
Ref. SOR Duchess TS 8915U	<	SOR Duchess BC 4425P	YR	98
Brown Commitment S7206	<	LJC Lancer 806	Scr.	37
SOR MARLEE CMMTMNT 0470X	<	Brown MS Shazzam P7940	Fr.	5.5
SOR Marlee Beef 4511P	<	Lonerock Beefstake 0024		
	<	Sor Marlee Bur 0019K		

DAM	Calv.Ease	BW	WW	YW	Milk	HPG	Stay	Maint.En.
Age 5	EPDs 20	-4.9	60	102	23	10	19	6.0
Wt NA	Acc. (.36)	(.63)	(.59)	(.59)	(.20)	(.20)	(.13)	(.63)
Wean Pct. NA	Marb +0.91	(.30)	REA +0.35	(.34)	Bfat +0.01	(.25)		
Cow Eff. NA								

★★★★★ for Marbling, Rib-eye area, Calving Ease.

S-2 BECKTON SCAMP F172 N5
1-A 100% # 3988736 Tattoo: BSF8 F172

Birth: 3-9-18

Beckton Scamp X458 H3	<	Beckton Scamp T A825	BWt	66
BKT Pine Marie R401 HU	<	BKT Pine Marie R401 HU	WR	101
BECKTON SCAMP B720 L4	<	Beckton Likable U130 L2	ADG	3.06
Ref. S Beckton Larkaba Y448 L	<	Beckton Larkaba T655 NB	YR	104
Beckton Nebula T398 V3	<	Beckton Nebula L P093	Scr.	37
BECKTON ANGEL X450 N	<	Beckton Minerva J615 VG	Fr.	5.5
Beckton Angel T004 CT	<	BKT Clifftop TP R288		
	<	Beckton Angel R155 CT		

DAM	Calv.Ease	BW	WW	YW	Milk	HPG	Stay	Maint.En.
Age 8	EPDs 22	-5.8	52	89	24	14	18	-2.0
Wt 1140	Acc. (.30)	(.46)	(.39)	(.41)	(.18)	(.06)	(.13)	(.45)
Wean Pct. 51%	Marb +0.32	(.22)	REA +0.01	(.29)	Bfat +0.02	(.18)		
Cow Eff. 106								

★★★★★ for Low Maintenance, Marbling, Calving Ease.

Sale Terms and Conditions

Except for those stated in the terms and conditions below, there are no warranties, either expressed or implied, as to the merchantability or fitness for a particular purpose with respect to the cattle being sold at this auction. The warranties and guarantees set forth in the "Terms and Conditions" are in lieu of all other warranties, either expressed or implied, and the remedies provided therein shall be the sole and exclusive remedy for the Buyer, or any party claiming through Buyer, for any breach of warranty or guarantee therein provided, and all other obligations or liabilities.

The information in the catalog is believed to be accurate, and the information seller believes to be most representative. It is the nature of seller's business that the seller engages in a continual process of collecting new data and information. Therefore, any information presented at the time of sale is always subject to revision, correction or update.

I. BIDDING

The Auctioneer in charge will settle any disputes as to bids, and his decision on such matters shall be final.

II. TERMS

Terms of sale are cash or personal check unless satisfactory credit arrangements have been made with vendor prior to sale.

III. PURCHASER'S RISK

Each animal becomes the risk of the purchaser as soon as sold, but it shall be the obligation of the Seller to see that animals are fed and cared for free of charge to purchaser, until loaded for shipment or until the expiration of 48 hours after the sale, whichever occurs sooner.

IV. DELIVERY

For any animals for which seller's arrange delivery, the following terms shall apply. Each animal becomes the risk of the purchaser as soon as sold, and through the time of delivery. The seller will arrange transportation and delivery schedules, and may combine animals from one or more purchasers for convenience and to reduce costs. If delivery is arranged, seller assumes no other liability. Once the purchaser has been notified of the date and approximate time of delivery (morning, afternoon, evening, etc.), it is the responsibility of the purchaser to arrange adequate and agreeable location and facilities for unloading each animal. When unloaded at the agreed upon location, all care and management of the animal is the responsibility of the purchaser.

V. CERTIFICATE OF REGISTRY

A transferred certificate of registry will be furnished to the purchaser for each animal for which a Registration number is listed.

VI. HEALTH

All animals are eligible for interstate shipment, except as otherwise announced. Interstate health papers will be furnished for each animal requiring T.B, Bang's, and trich tests in accordance with federal and state regulations.

VII. DIVISIBILITY

The percentage of ownership interest received by the buyer, whether it is 100% or 2/3 or otherwise as defined in the catalog or by the auctioneer, may not be subsequently divided without the express written consent of the seller.

VIII. ANNOUNCEMENTS

Any changes from information of any kind in this catalog will be announced from the auction box and such announcements shall take precedence.

IX. BREEDING GUARANTEE

Any female that has had a calf prior to the date of sale shall be considered a breeder without further guarantee. All females sold as 'bred' or 'pregnant' have been pregnancy checked by a licensed veterinarian and are guaranteed bred on the day of sale. The purchaser may elect to have any female so listed rechecked at their cost within 30 days of delivery by a licensed veterinarian of their choice. Any such female determined open by this recheck may be returned to the seller for a full refund. Due to conditions out of seller's control, once a female leaves seller's possession, this is the only guarantee offered.

All bulls are sold as guaranteed breeders. Each bull has been officially fertility tested as "Satisfactory Breeder" prior to the sale. However, seller cannot guarantee against physical injury or illness following the sale. But if within 8 months following the sale, the buyer has evidence that the animal is not a breeder, the buyer may obtain a statement signed by a licensed veterinarian to that effect, such statement also indicating that there has been no injury or illness to the animal following the sale, and return the bull to the farm of the seller for adjustment. If the seller cannot then prove the animal to be a breeder, an adjustment will be made by the seller, either by substituting an animal of equal value, or by the refund of the full purchase price. Such adjustment shall be considered full settlement and satisfaction of all claims. No guarantees apply to animals which are shown following the sale.

X. GENETIC DEFECT GUARANTEE AND PARENTAGE

All parentage and pedigrees presented in the catalog are believed accurate based upon the breeding and DNA information we have available. However, parentage and pedigree information cannot be guaranteed 100%, because it is always possible that new information or new DNA technology and testing might show that there have been inadvertent errors.

Osteopetrosis: The Red Angus Association along with animal scientists have developed a DNA marker test for osteopetrosis (OS), a genetic disorder which in rare instances can cause the loss of a calf at birth. Since the test was developed, Beckton has tested every sire being used in our breeding program. Only one sire, from outside our program, tested positive as a carrier of the gene. Every sire bred and raised at Beckton has tested 'Free'. All of our major semen sires have also been tested 'Free'. We guarantee every sale animal to be OS Free, and if you have a concern, we will have any sale animal tested on request. If an animal were to test positive, we would replace the animal or refund the purchase price. The testing we have done shows no incidence of occurrence in any Beckton bloodlines for the past 30 years, and so we believe there is no safer herd than ours.

XI. RETAINED INTEREST AND SEMEN RIGHTS:

Beckton is selling full possession and one half semen interest in all the bulls in the catalog. Seller is retaining one half interest in all bulls in the catalog. This is done so we can use some of the bulls in herd and reserve the right to collect and market semen on these bulls. Any collection on our behalf would be at our expense and could be done during the off-season and at the convenience of the buyer. The buyer would have the option to share in the collection and retain semen for the buyer's use also. If semen is marketed by either party, Seller receives one half royalty interest on gross semen sales, and buyer receives one half interest. Regardless of semen collection and marketing, the buyer retains full possession, full pasture use rights, and full salvage value in these bulls.

XII. RIGHTS AND OBLIGATIONS

A. The above terms and conditions of sale shall constitute a contract between the Buyer and Seller of each animal and shall be equally binding upon both. Each sale or resale of an animal constitutes a separate transaction.

B. Neither the sale manager, the owner, nor any other person connected with the management of the sale, assumes any liability, legal or otherwise.

Non-Parents (Spring 2021)

	ProS	HB	GM	CED	BW	WW	YW	ADG	DMI	MILK	ME	HPG	CEM	STAY	MARB	YG	CW	REA	FAT
Min.	-119	-97	-56	-5	-11.8	0	0	-.02	-0.51	0	-21	-3	-7	0	-.88	-.81	-39	-.68	-.17
Avg.	116	77	39	12	-1.8	59	94	.22	1.37	25	0	11	7	15	.41	.05	20	.11	.02
Max.	233	168	130	26	9.4	118	177	.47	3.37	43	23	38	16	28	1.39	.39	86	1.63	.10
1%	168	113	80	19	-6.3	82	133	.34	0.30	34	-12	18	11	21	.80	-.14	44	.57	-.02
2%	163	110	76	18	-5.9	79	129	.32	0.43	33	-11	17	11	20	.75	-.11	41	.51	-.02
3%	159	107	73	17	-5.5	78	126	.31	0.51	32	-10	16	10	20	.72	-.09	39	.47	-.02
4%	156	105	70	17	-5.2	76	124	.31	0.57	32	-9	16	10	20	.70	-.08	38	.44	-.01
5%	154	104	68	17	-5.1	75	122	.30	0.62	31	-9	15	10	19	.68	-.07	37	.41	-.01
10%	145	98	61	16	-4.3	72	116	.29	0.80	30	-7	14	9	19	.62	-.03	33	.33	-.01
15%	139	94	57	15	-3.8	69	112	.27	0.93	29	-5	13	9	18	.57	-.01	30	.28	.00
20%	135	91	53	15	-3.4	67	109	.26	1.04	28	-4	13	8	18	.54	.00	28	.24	.00
25%	131	89	50	14	-3.1	66	106	.26	1.12	28	-3	12	8	17	.51	.01	26	.21	.01
30%	128	86	47	14	-2.8	64	104	.25	1.19	27	-2	12	8	17	.48	.02	25	.18	.01
35%	125	84	45	13	-2.5	63	101	.24	1.26	26	-1	12	8	16	.46	.03	23	.16	.01
40%	122	82	43	13	-2.2	62	99	.24	1.31	26	0	12	7	16	.43	.04	22	.13	.01
45%	119	80	40	13	-2.0	61	97	.23	1.36	25	0	11	7	16	.41	.05	21	.11	.01
50%	116	78	38	12	-1.7	59	95	.22	1.42	25	1	11	7	15	.39	.06	19	.09	.02
55%	113	76	36	12	-1.5	58	93	.22	1.47	24	2	11	7	15	.37	.06	18	.07	.02
60%	110	74	34	12	-1.2	57	91	.21	1.51	24	2	11	6	15	.35	.07	17	.05	.02
65%	107	71	32	11	-1.0	56	88	.20	1.56	23	3	10	6	14	.33	.08	16	.03	.02
70%	104	69	29	11	-0.7	54	86	.19	1.62	23	3	10	6	14	.31	.09	14	.01	.02
75%	101	66	27	11	-0.4	52	83	.19	1.67	22	4	10	6	13	.29	.10	13	-.02	.03
80%	97	63	24	10	-0.1	51	80	.18	1.74	22	5	9	5	13	.27	.11	11	-.04	.03
85%	92	59	21	10	0.3	48	75	.16	1.81	21	5	9	5	12	.25	.12	9	-.07	.03
90%	87	54	17	9	0.7	45	70	.15	1.90	20	6	8	4	11	.22	.14	7	-.11	.04
95%	79	46	11	8	1.5	40	61	.12	2.05	18	8	8	3	10	.18	.17	3	-.17	.04

EPD Accuracies and Possible Change

EPDs are predictions, not true values, and we can therefore expect that EPDs will change from sire evaluation, as more information (i.e. progeny data) is included. A possible change value is an estimate of the amount of change (in trait units) that can be expected for a given EPD.

Technically, there is a 68% chance that the real genetic value (an EPD with a accuracy of 1.0) for any trait lies between its EPD plus its possible change value and its EPD minus its possible change value. For example, if a sire has a weaning EPD of +25 lb. and a possible change value of 10 lb., we can expect the true genetic value to be between +15 lb. (25 - 10) and +35 lb. (25 + 10) 68% of the time. We should not be surprised if his EPD in next year's evaluation is as high as +35 or as low as +15. If next year's EPD should happen to be slightly outside of this

range, keep in mind there is nearly a one-in-three chance of that happening; however, significantly larger deviations can occur.

Possible change is simply another way of expressing accuracy of an EPD. High accuracy sires will have small possible changes and vice versa. Many breeders feel that possible change values complement accuracies and help them determine just how thoroughly an animal has been evaluated. The accuracy/possible change chart lists possible changes in EPDs that can be expected with different levels of accuracy for the various traits.

For more information on possible change values, please see the article by Dr. Bob Hough titled "Understanding EPD Accuracies and Possible Change". This article can be downloaded from the Red Angus Association of America website at www.redangus.org.

Accuracy	CED	BW	WW	YW	DMI	MILK	ME	HPG	CEM	STAY	MARB	YG	CW	REA	FAT
0.0	7.8	3.0	16.3	25.7	.92	11.9	3	11	7.9	7.1	.26	.20	19.3	.43	.04
0.1	7.0	2.7	14.7	23.1	.82	10.7	2	10	7.1	6.4	.23	.18	17.4	.39	.04
0.2	6.2	2.4	13.0	20.6	.73	9.5	2	9	6.3	5.7	.21	.16	15.4	.34	.03
0.3	5.4	2.1	11.4	18.0	.64	8.3	2	8	5.5	4.9	.18	.14	13.5	.30	.03
0.4	4.7	1.8	9.8	15.5	.55	7.1	2	7	4.7	4.2	.16	.12	11.6	.26	.02
0.5	3.9	1.5	8.2	12.9	.46	6.0	1	6	3.9	3.5	.13	.10	9.7	.22	.02
0.6	3.1	1.2	6.5	10.3	.37	4.8	1	4	3.1	2.8	.10	.08	7.7	.17	.02
0.7	2.3	0.9	4.9	7.7	.27	3.6	1	3	2.4	2.1	.08	.06	5.8	.13	.01
0.8	1.6	0.6	3.3	5.1	.18	2.4	1	2	1.6	1.4	.05	.04	3.9	.09	.01
0.9	0.8	0.3	1.6	2.6	.09	1.2	0	1	0.8	0.7	.03	.02	1.9	.04	.00
1.0	0.0	0.0	0.0	0.0	.00	0.0	0	0	0.0	0.0	.00	.00	0.0	.00	.00

Sire Bloodline Charts

Name Family

- Accent A
- Allegiant O
- Cadinal C
- Cherokee C
- Clifftop C
- Clipper A
- Cody A
- Dominor D
- Epic E
- Hasten H
- Herald H
- Heritage H
- Hughes B
- Hustler H
- Javelin J
- Jet J
- Julian J
- Lancer L
- RH Lancer O
- Legend L
- Likable L
- Nebula N
- New Era N
- Nomad V
- Oracle O
- Ranger R
- Roosevelt B
- Scamp S
- Warrior W

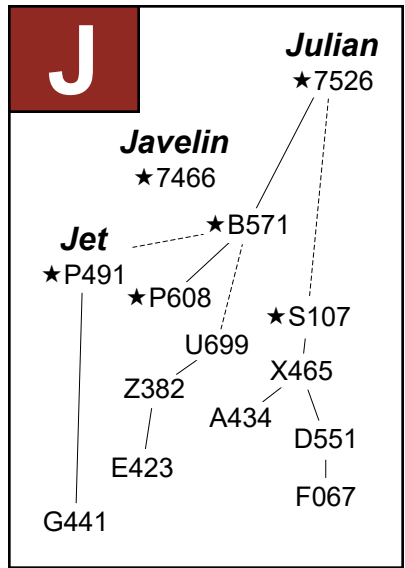
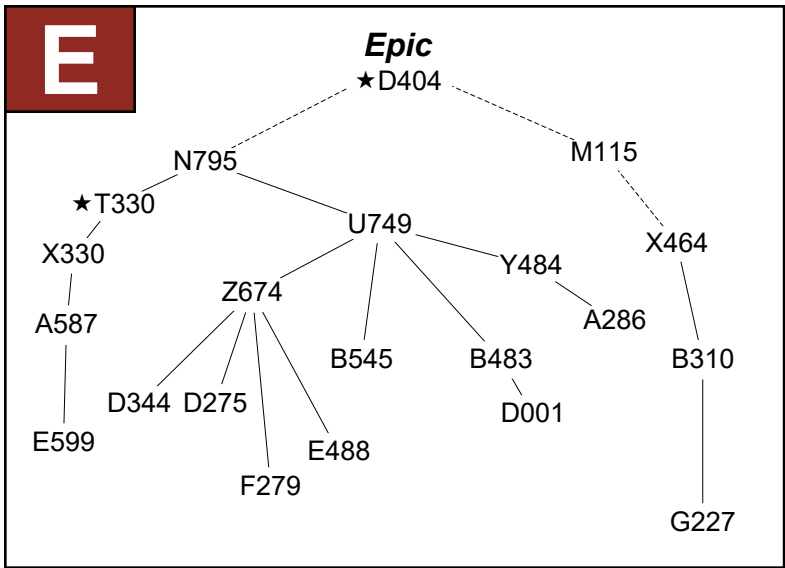
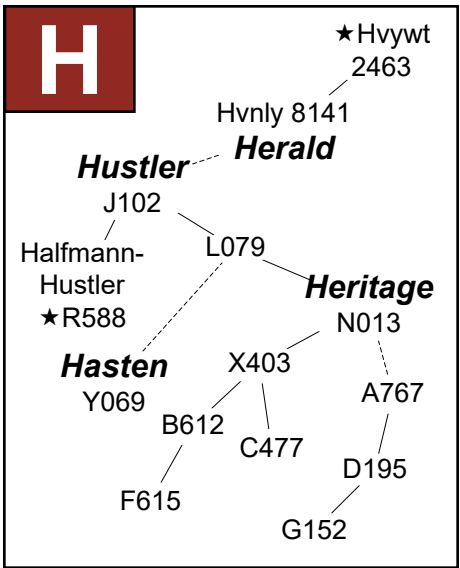
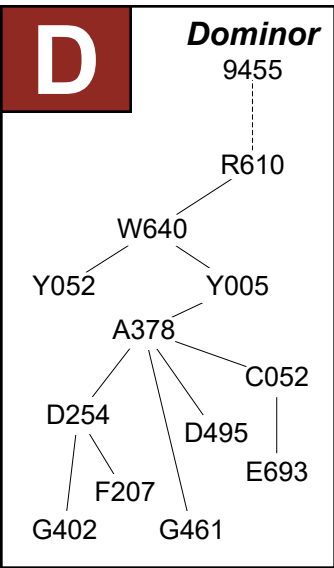
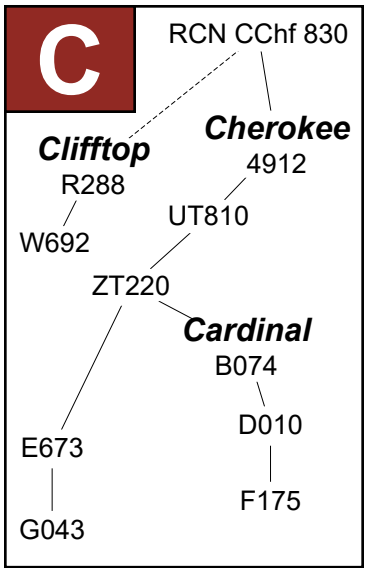
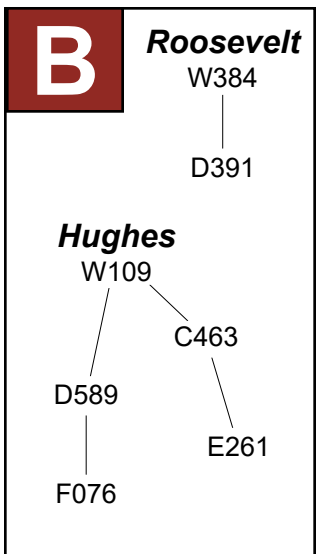
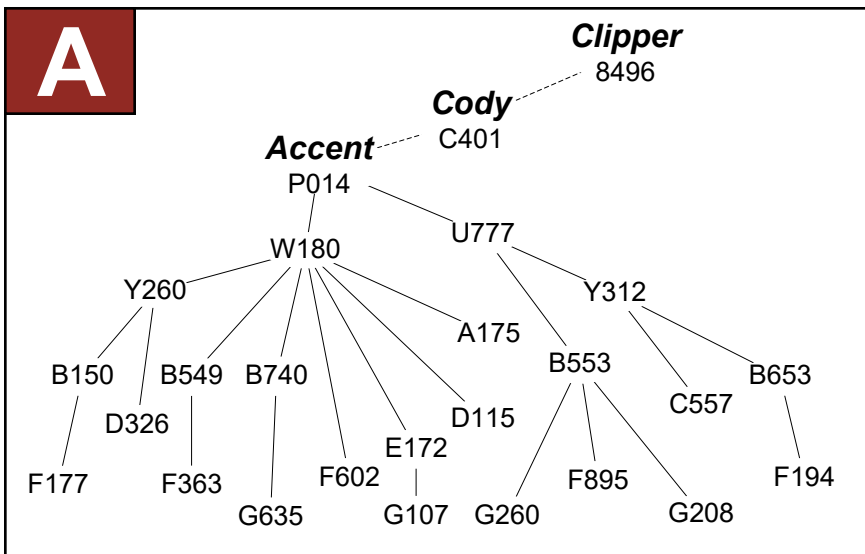

★ Red Angus Trait Leader

L

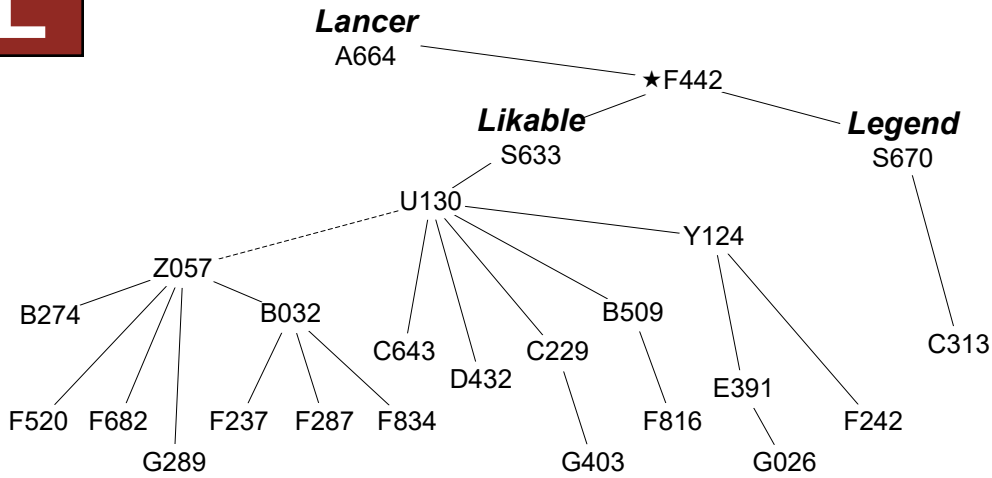

N

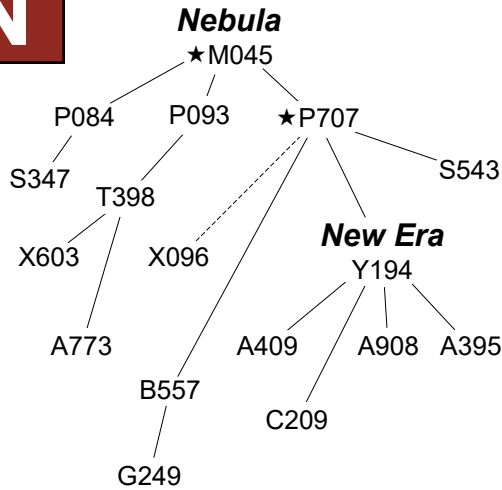

O



R

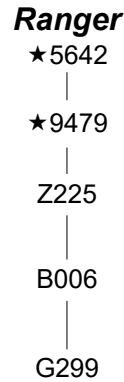

S

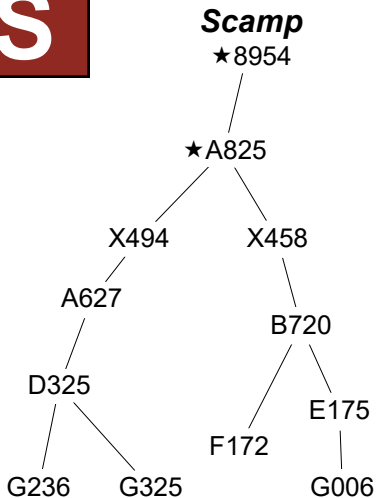

V

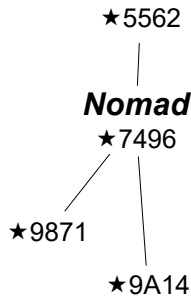

W

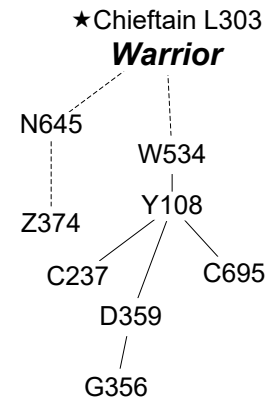

Name	Tag	Family
Nomad	7496	V
Nomad	9871	V
Accent	A175	A
Julian	A434	J-3
Scamp	A627	S
Nebula	A773	N-3
Ranger	B006	R-1
Likable	B032	L-2
Epic	B483	E
Accent	B549	A-2
Accent	B553	A-3
Julian	B571	J-1
Accent	B653	A
Accent	B818	A
New Era	C209	N-4
Legend	C313	L
Hughes	C463	B-1
Heritage	C477	H-1
Accent	C557	A-4
Likable	C643	L
Epic	D001	E-1
Cardinal	D010	C
Accent	D115	A
Dominor	D254	D-2
Accent	D326	A
Likable	D432	L-3
Dominor	D495	D-3
Accent	D678	A
Accent	E172	A-5
Scamp	E175	S-1
Likable	E391	L-4
Julian	E423	J-4
Cardinal	E673	C-1
Dominor	E693	D-4
Allegiant	EH835	O-1
Lancer	ERH11	O-2
Oracle	ES142	O-3
Julian	F067	J-5
Hughes	F076	B-2
Scamp	F172	S-2
Cardinal	F175	C-2
Accent	F177	A
Accent	F194	A-6
Dominor	F207	D-5
Likable	F237	L-5
Likable	F242	L-6
Epic	F279	E-2
Likable	F287	L-7
Accent	F363	A
Nebula	F440	N
Likable	F520	L-8
Accent	F602	A
Heritage	F615	H-2
Likable	F682	L-9
Likable	F816	L-10
Likable	F834	L
Accent	F895	A
Julian	P608	J
Nebula	P707	N-1
Nebula	S347	N
Legend	S670	L
Accent	W180	A-1
Dominor	Y052	D-1
Likable	Y124	L-1
New Era	Y194	N-2
Julian	Z382	J-2

Lot-Tag Cross Reference

ID	Lot	ID	Lot	ID	Lot	ID	Lot	ID	Lot	ID	Lot	ID	Lot		
<i>Bulls</i>								<i>Heifers</i>				<i>Ref. Sires</i>			
H004	.29	H189	.49	H324	.63	H449	.21	H625	.83	H054	.319	A434	.J-3		
H008	.169	H190	.98	H326	.121	H451	.159	H630	.171	H057	.315	A773	.N-3		
H012	.181	H192	.233	H327	.66	H456	.84	H636	.215	H066	.311	B006	.R-1		
H013	.75	H194	.15	H329	.113	H458	.65	H651	.127	H082	.307	B032	.L-2		
H016	.73	H196	.161	H330	.155	H463	.176	H652	.236	H134	.306	B549	.A-2		
H017	.122	H198	.62	H331	.162	H465	.16	H659	.184	H187	.309	B553	.A-3		
H025	.240	H200	.39	H334	.17	H471	.175	H661	.207	H195	.310	B571	.J-1		
H027	.134	H207	.58	H336	.118	H472	.205	H663	.153	H224	.313	C209	.N-4		
H028	.112	H210	.79	H342	.64	H474	.178	H667	.91	H241	.314	C463	.B-1		
H032	.196	H212	.36	H345	.226	H481	.42	H669	.192	H266	.320	C477	.H-1		
H039	.244	H216	.12	H346	.33	H486	.238	H672	.170	H287	.318	C557	.A-4		
H041	.85	H223	.20	H347	.126	H488	.183	H677	.47	H305	.305	D001	.E-1		
H052	.160	H226	.27	H349	.86	H489	.143	H680	.158	H306	.308	D254	.D-2		
H055	.135	H227	.55	H351	.107	H493	.68	H681	.193	H378	.317	D432	.L-3		
H060	.38	H228	.164	H353	.141	H494	.186	H687	.224	H466	.312	D495	.D-3		
H065	.80	H229	.150	H355	.51	H495	.133	H693	.190	H469	.304	E172	.A-5		
H079	.70	H231	.156	H359	.96	H498	.69	H695	.154	H487	.303	E175	.S-1		
H084	.108	H234	.195	H360	.216	H501	.78	H696	.209	H499	.301	E391	.L-4		
H086	.95	H237	.180	H362	.128	H508	.52	H699	.45	H522	.316	E423	.J-4		
H090	.93	H238	.168	H366	.104	H519	.198	H700	.230	H585	.302	E673	.C-1		
H091	.125	H246	.5	H371	.123	H521	.188	H701	.206			E693	.D-4		
H095	.60	H247	.115	H372	.194	H524	.87	H706	.221			EH835	.O-1		
H098	.157	H249	.130	H374	.106	H527	.50	H709	.81			ERH11	.O-2		
H100	.142	H252	.92	H377	.53	H529	.199	H711	.166			ES142	.O-3		
H103	.197	H254	.119	H381	.67	H531	.94	H712	.223			F067	.J-5		
H106	.10	H258	.57	H383	.89	H536	.111	H715	.217			F076	.B-2		
H107	.132	H263	.117	H384	.8	H537	.245	H719	.214			F172	.S-2		
H109	.101	H267	.173	H386	.120	H540	.225	H724	.220			F175	.C-2		
H110	.146	H273	.102	H391	.24	H545	.219	H741	.82			F194	.A-6		
H112	.22	H274	.74	H393	.4	H547	.31	H769	.232			F207	.D-5		
H115	.151	H275	.211	H395	.37	H548	.243	H776	.212			F237	.L-5		
H120	.229	H277	.191	H397	.6	H552	.149	H791	.204			F242	.L-6		
H123	.43	H278	.163	H398	.203	H560	.137	H809	.129			F279	.E-2		
H124	.100	H279	.71	H399	.152	H561	.139	HC161	.167			F287	.L-7		
H125	.234	H286	.76	H400	.34	H567	.30	HC162	.7			F520	.L-8		
H127	.147	H288	.99	H402	.28	H568	.189	HC166	.105			F615	.H-2		
H135	.136	H289	.48	H403	.138	H572	.145	HC169	.201			F682	.L-9		
H136	.14	H290	.208	H407	.179	H573	.231	HC175	.218			F816	.L-10		
H141	.90	H293	.174	H409	.2	H577	.124					P707	.N-1		
H142	.172	H295	.13	H411	.116	H579	.237					W180	.A-1		
H143	.182	H298	.114	H412	.3	H591	.222					Y052	.D-1		
H147	.46	H299	.110	H413	.227	H594	.185					Y124	.L-1		
H156	.9	H300	.61	H418	.213	H595	.200					Y194	.N-2		
H163	.44	H307	.140	H420	.11	H598	.72					Z382	.J-2		
H164	.40	H309	.32	H421	.131	H599	.235								
H165	.202	H313	.103	H422	.165	H603	.241								
H173	.35	H314	.1	H423	.23	H604	.242								
H180	.54	H317	.56	H425	.187	H610	.177								
H183	.26	H318	.59	H428	.41	H617	.148								
H185	.88	H320	.228	H438	.25	H618	.239								
H188	.144	H321	.97	H442	.18	H620	.19								
		H322	.109	H446	.77	H621	.210								

Family who help us in many ways over the course of the year



Stephen Forbes and Morgan Baldwin



Kate with Alison Brody and Don Bingham



*Julia Forbes and Ed Waddington
(with Tazmin and Flinder)*



Doug Foster and Sarah Forbes



*Elfie Forbes and Ruth Sylvester
(Ruth passed away in 2019)*



Sheila and Doug Bingham



Ellen Durkin with Julia and Sarah



*Jason Brown with Nolan and Shelley Forbes
with Emery*



*Tallie Forbes and Justin Lee
with Claire and Ryan*

Beckton Stock Farm

Cam Forbes
37 Beckton Drive
Sheridan, WY 82801

Tel.: 307.674.6095, 674.8162 (evening)

Email: becktonwyo@gmail.com

Web: www.BecktonRedAngus.com

Video of Sale Bulls available on our Website

FIRST CLASS

Industry leading genetics and the highest quality
Red Angus, with 76 years of Satisfied Customers



Superior Productions will provide internet and representative bidding services for buyers who can't make it to the sale. Please see page 3 for more information.

Free Delivery
anywhere in the Continental US