

# 77th Anniversary Production Sale

Tuesday April 12th, 2022

Industry Leader for  
Low Maintenance, Maternal Traits



YEARS

**1** **Beckton**  
**Red Angus**

*Foundation Herd of the Red Angus Breed*

# 1 Beckton Red Angus

37 Beckton Drive • Sheridan, WY 82801 • [becktonwyo@gmail.com](mailto:becktonwyo@gmail.com)  
Office: 307.674.6095 • Evenings: 674.8162 • Fax: 672.7281

Dear Friends and Cattlemen,

It is a little hard to imagine what it was like 77 years ago when my parents Sal and Waldo Forbes started the nation's first herd of Red Angus cattle, and whether they might have imagined that 77 years later it would be a leading herd providing quality genetics to the entire beef industry. This is our 77th Anniversary sale, and we welcome all of you to join us.

We have a really nice uniform set of bulls, and a select group of yearling heifers from the very top of our herd. We believe this is a set of bulls that truly meet the needs of the commercial cattle industry. We have long bred our cattle for "balanced" traits, and have never chased growth at the sacrifice of any maternal traits. We think these are the best possible bulls for producing replacement females and for building a strong cowherd. Beckton's herd has long been known for its strong reputation females, females that build a base for many possible breeding programs.

If you are new to our program, you will see two measures of beef Tenderness provided for the sale bulls. In 2007 we started using DNA technology to select for Tenderness in our breeding program. It is well known from scientific research that the Calpain and Calpastatin enzymes are important to the Tenderness and eating quality of beef. Neogen Corp uses DNA technology to measure these enzymes, plus myostatin, in individual animals. Neogen rates bulls on a simple 1 to 10 scale, with 10 being the best. Since we started utilizing this technology 15 years ago, the results have been phenomenal. Today the preponderance of our herd sires measure 8, 9, or 10.

More recently we started using an Ultrasound technology to measure Tenderness in addition to DNA. The Ultrasound scans and measures the actual muscle fibers, to show beef Tenderness. Usually (but not 100%) this measure correlates with the DNA results. The Ultrasound scale goes from 1 to 6, with 1 being the best. Our cattle also look excellent on this Ultrasound measure – with most in the 1 to 2.5 range (Tender to Highly Tender).

We started putting Tenderness data in our catalog a few years ago because we have many customers who use our bulls for local or private-label specialty beef marketing programs. Tenderness is extremely important to these small programs. Now it seems the entire high end commercial beef market is moving rapidly to branded beef products marketed by major packers and retailers. We believe Tenderness can become a premium factor for these products, and we hope with our 15 year head start our bulls will put you ahead and at the top of this market.

On behalf of everyone here at Beckton, we welcome you to join us for our 77th Anniversary Bull and Heifer Sale, and for an early dinner at the Ramada Plaza (which used to be the Holiday Inn) right after the sale and before you head home. We look forward to seeing you on Tuesday the 12th.

Sincerely,

*Cam Forbes*



**Cam and Trish Forbes**

Tenderness Scores	
DNA	Ultrasound
9-10 Outstanding	0.8-1.6 Tender+
7-8 Very Good	1.7-2.5 Tender
5-6 Average	2.6-4.0 Tender-
3-4 Poor	4.1-6.0 Fair to Tough
1-3 Very Poor	

**Beckton Red Angus • Since 1945**  
**The Foundation Herd of the Red Angus Breed**

# Sale Information

## Beckton Ranch

9½ miles West of Sheridan

Phone: 307.674.6095

Please join us for a complimentary dinner after the sale at the Ramada Plaza (formerly the Holiday Inn).

**Tuesday, April 12th, 2022**

1 o'clock pm (Lunch at noon)

**234 Bulls • 25 Heifers**

Selling in catalog order, heifers sell following the bulls



## Some Facts about the Beckton Herd

Beckton has long been one of America's premier breeders recognized for genetics which combine a genuine balance of desirable traits - calving ease, maternal traits, and rapid growth to yearling age. They are a leading choice for commercial replacement females and for building a great cow herd. And the lower birth weights make them a first choice for breeding heifers.

**MATERNAL FOCUS:** The HerdBuilder Index has been completely revised as of last fall, with a new formula which no longer includes post-weaning revenue traits like ADG, Yearling weight, or Marbling. Because the new HerdBuilder no longer tries to measure overall herd "profitability", it is not an Index that we would select for, or recommend our customers select for. However HerdBuilder does provide a barometer of some traditional "maternal" traits, and Beckton bloodlines still perform very well on it. **33 of the top 50 sires in the breed for HerdBuilder are Beckton sires or descended from Beckton sires.**

**MODERATE MATURE SIZE:** One characteristic of Beckton cattle which makes them ideal for producing replacement females and building a low cost, efficient cowherd, is the **moderate mature size**. We list the mature weight of the Dam of every Beckton sale bull. Page 5 shows the results of decades of genetic selection. We believe we have the best genetics for **Efficiency** that can be found anywhere.

**EASY CALVING:** The #1 Herd in the breed for easy calving. **47 of the top 50 sires in the Red Angus breed for Calving Ease are Beckton sires or descended from Beckton sires.** Producers all over the western United States use our bulls year after year for breeding their heifers. However unlike some heifer bulls that are simply sold off the low end, we have always selected for growth traits as well, so you can find a large number of calving ease bulls which offer more growth and marbling as well. If you are breeding heifers, these are your top choice.

## Sale Details

### Site-Unseen Purchase

If you are unable to attend the sale, we can help you select the bulls or heifers to fit your needs. Give us a call, letter, fax or email, and we can handle bidding for you according to your directions. Satisfaction is guaranteed on all animals purchased "sight-unseen". Over a quarter of our bulls sell this way, mostly to long-time and repeat customers. To provide adequate time to assist you, please contact us before actual sale day.

### Internet Bidding via Superior Productions

Internet bidding and phone bidding are now available with Superior Productions. See more information on page 3.

### Conference Call Bidding

Conference call bidding will be available with Bill Pelton, Pelton Livestock. See more information on page 3.

### Payments

Payments can be made with cash, check payable to Beckton Stock Farm, Inc. or Visa/Mastercard on sale day.

### All Bulls "Trich" Tested

In all the years we have been selling and delivering bulls, Beckton has never had a bull test positive for "trich". But because an increasing number of states require testing of yearling bulls, and to avoid any delay in delivery time, we will have all the sale bulls tested negative for "trich" prior to the sale. Customers from any state may also come to the sale with their trailer and load out directly after the sale.

### Free Delivery

We provide free delivery for all bulls throughout the continental U.S. If you bring a trailer to haul your own, \$200 will be deducted from the price of each bull. Heifers will be delivered free within 400 miles, and at cost for additional miles. Most of the sale cattle will be delivered from 1 to 3 weeks after the sale, although we will try to accommodate if you need your bulls right away. Although there occasionally are limitations, in most cases we can deliver the cattle directly to your ranch.

## Accommodations

### Ramada Plaza

307-672-8931, I-90, Exit 25  
Ask for special Beckton Sale rate of \$79 per room

### Best Western Sheridan Center

307-674-7421, 612 N. Main Street

### Days Inn

307-672-2888, 1104 Brundage Lane

### Super 8 Motel

307-672-9725, 2435 N. Main Street

## Transportation

### United / United Express

Daily CRJ200 flights between Denver and Sheridan  
www.united.com

### Avis Car Rental

307-672-2226, Sheridan Airport



**Auctioneer Roger Jacobs**  
406-698-7686



**Bob Hough**  
817-296-0976



**Alan Sears**  
Western Ag Reporter  
970-454-3986



**Curt Cox**  
Wyoming Livestock  
Roundup  
307-630-4604



**Matt Wznick**  
Tri-State Livestock  
406-489-2414



**Pete Crow**  
Western Livestock  
Journal  
303-722-7600



**Devin Murnin**  
Western Livestock  
Journal  
406-696-1502

## Additional Sale Information

- ▶ The animals sell in catalog order. We will have a conference call available for telephone bidding. You must register in advance, and conference number and instructions will be available then.
- ▶ All bulls have passed a rigorous fertility exam that included live semen evaluation, scrotal measurements, and reproductive tract examinations.
- ▶ Beckton has a comprehensive herd-wide health program which includes vaccinations for 7-Way, IBR, BVD, PI3, BRSV, Lepto, and ivermectin. The heifers are also vaccinated for bangs and vibrio.
- ▶ When a genetic test was developed by RAAA for osteopetrosis (OS), Beckton tested every sire in use in our program, as well as our major AI sires. Every Beckton bred sire (nearly 80 in total) tested OS Free.
- ▶ We plan to have semen collected on some of the bulls before the sale. We will also work with the buyer to collect bulls after the sale.
- ▶ Buyer receives full possession and one half semen interest in all the bulls in the catalog. Seller is retaining one half interest in all bulls in the catalog. This is done so we can use some of the bulls in herd and reserve the right to collect and market semen on these bulls. Any collection on our behalf would be at our expense and could be done during the off-season and at the convenience of the buyer. The buyer would have the option to share in the collection and retain semen for the buyer's use also. If semen is marketed by either party, Seller receives one half royalty interest on gross semen sales, and buyer receives one half interest. Regardless of semen collection and marketing, the buyer retains full possession, full pasture use rights, and full salvage value in these bulls.
- ▶ Payments can be made with cash, check payable to Beckton Stock Farm, Inc. or Visa/Mastercard on sale day.

### Table of Contents

The Beckton Program . . . . .	4
The Bulls . . . . .	10
The Yearling Heifers . . . . .	59
Reference Sires . . . . .	65
Ref. Sire Cross Reference . . . . .	74
Sale Terms & Conditions . . . . .	75
RAAA Herd EPD Tables . . . . .	76
Sire Bloodline Charts . . . . .	78
Lot-Tag Cross Reference . . . . .	80



**Serving our customers for 77 years with industry leading genetics and the highest quality cattle.**



## BECKTON BULL AND HEIFER WARRANTY

Optional protection against injury or death, plus Pregnancy coverage for heifers

**BULLS:** Injury or loss protection coverage - If your bull is permanently injured or dies any time up to 5 months after purchase, you will receive a credit toward purchase of another bull in the amount of the original purchase price minus salvage. The cost is 5% of the purchase price paid at settlement (eg. \$150 for a \$3,000 bull).

**HEIFERS:** Injury or loss protection plus Pregnancy Guarantee – likewise good for 5 months after purchase. If your heifer fails to become pregnant when exposed to a bull who settles 75% of the other heifers in the same pasture; or in the event your heifer is permanently injured or dies, you will receive a credit toward purchase of another heifer in the amount of the original purchase price minus any salvage. The cost is 10% of the purchase price paid at settlement (eg. \$200 for a \$2,000 heifer).

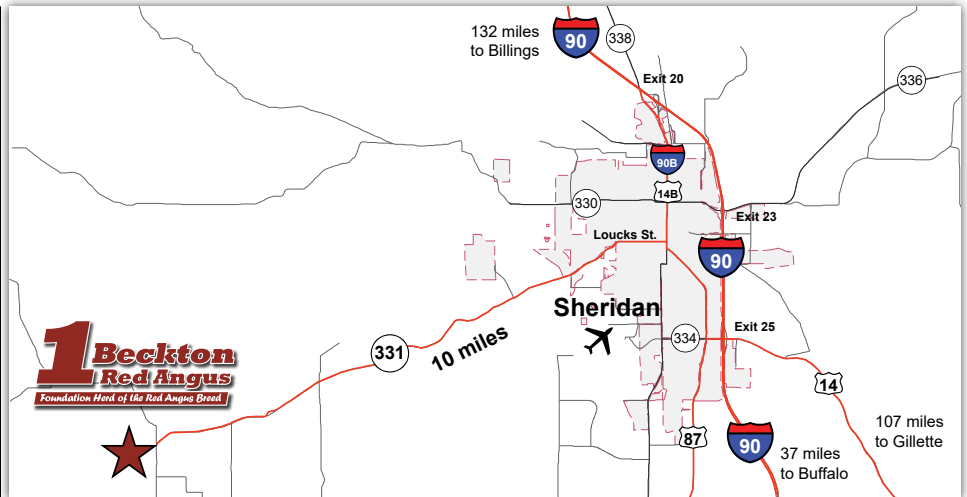

## How to Participate as an Absentee Bidder: 1, 2, or 3

### 1. Site-Unseen Purchase

If you are unable to attend the sale, we can help you select the bulls or heifers to fit your needs. Give us a call, letter, fax or email, and we can handle bidding for you according to your directions. Satisfaction is guaranteed on all animals purchased "sight-unseen". Over a quarter of our bulls sell this way, mostly to long-time and repeat customers. To provide adequate time to assist you, please contact us before actual sale day.

### 2. Superior Livestock Productions

**Turn in Bids Over the Phone.** To get started simply go online to [www.superiorlivestock.com](http://www.superiorlivestock.com) and click on the tab titled "Register for a Buyer Number". Select the registration form for Superior Productions and print the registration form, fill it out and fax it in to Superior Productions at (817) 378-3380 with a signature on it, or scan and email the form to [info@superiorauction.com](mailto:info@superiorauction.com). You can also mail it in to the address provided on the form. Upon receipt of this information Superior will call you with a buyer's number and the bid line phone number that you will use on sale day to place bids over the phone. **Important: If you plan to bid by phone through Superior Livestock or 'Click-to-Bid', you must register at [www.superiorlivestock.com](http://www.superiorlivestock.com) prior to bidding.**

**Click-To-Bid.** This is Superior's online bidding platform for cattle buying. Please note that high speed internet is required – this is not for dial-up or satellite internet. Registration is free, but you must become a member of [www.superiorclicktobid.com](http://www.superiorclicktobid.com) to sign up. Becoming a member is easy - just go to the homepage of [www.superiorclicktobid.com](http://www.superiorclicktobid.com) and follow the out-lined steps to get started. Input your information and select a username and password. You will receive an e-mail confirming you are a member. From that point forward you just have to sign in and select the sale you would like to register for and once approved you will receive an e-mail confirming which sale you are now registered for.



### 3. Sale Day Conference Call

Our goal is to have you in the seats but if you can't make it on sale day, we're fixin' to get you "on the line!"

Easy as 1~2~3  
Call BILL PELTON in Advance to...

1. Pre-Register for your buyer number
2. Receive the toll-free Call in Number & Pin
3. Get last minute instructions for the call

**Pelton Livestock**  
Marketing & Consulting  
www.billpelton.com | 406-671-5100

Buyers purchasing via Superior or Pelton Livestock can mail a check after the sale with brief delivery instructions and an approximate date you would like delivery by. If you would like to pay with a credit card, please call the office the day after the sale

# The Beckton Program

## Cow Size

The goal for Beckton's program has always been to develop breeding seedstock which offer increased levels of performance for the commercial cattleman. Increased performance does not mean maximizing weight and size, which have already reached the upper limit of economic value for the packer and consumer. It does, however, mean increasing performance related to calving percentage and weaning percentage; and increasing performance related to cow maintenance requirements and "pounds of calf per acre" efficiency.

### Size Matters

Beckton cattle are already big enough for the consumer and the packer. Using yearling weight EPD as the best available indicator of market size, the average for our sale bulls is +90, close to the same as the Red Angus breed average, so for market size our cattle are directly comparable.

The big difference with Beckton's program is that we select for additional weaning and yearling weight, but with the restriction that we have maintained the same cow size over time. In contrast, the industry has allowed cow size to increase at the same rate as calf size. Cow size is the largest factor determining maintenance requirements. Our goal has been to increase efficiency, not size. No other seedstock breeding program has had such a goal and maintained it for so long.

#### Beckton Cow Weight Average (lb.)

Year	1978	1986	1994	2002	2010	2018	2020
Weight	1,126	1,064	1,067	1,104	1,068	1,074	1,051

(mature lactating cows taken at weaning)

Cow weights vary from year to year depending on grass, weather or other short term factors. But overall our cow size has stayed fairly constant over time.

### The Industry Problem

As shown on the graph on the next page, industry-wide cow size has increased substantially, 31% since 1978. Hay use per cow has increased even more, from 1.43 tons per animal to 1.91 tons.

Why does hay use increase at a faster rate than cow size or production per cow? Hay and grain are supplements to the cow's main diet, which is grass, and grass supply is relatively fixed by environment. Each increase in cow feed requirement must be met entirely by supplements, or by a combination of supplement and reduced stocking rate. A small increase in cow feed requirement leads to a reduction in stocking rate or a large increase in higher-cost, supplemental feed needs.

Any gains achieved in the feedlot sector due to increased animal growth, have been overwhelmed by increased cost of production in the cow-calf sector.



Matt Zier



Allison Natzel

## The Beckton Crew...



Randy Zier



Alan Sanders



Roger Zier



Shelby MacMillan

## Efficiency

The graphic at right shows how, for the U.S. cattle industry overall, the increase in average calf weights, as measured by steer slaughter weights, has been directly matched by an increase in average cow weights. (Percentages are based on USDA slaughter weight data for steers and cows respectively, using 1978 as a base year. Data for heifers slaughtered shows an identical trend.) Over 40 years, there has been minimal change in overall cowherd efficiency.

This graph shows the failure of cross-breeding and composite breeding to do little more than simply increase general cattle size. In the promotion of composites, the impact of retained heterosis on mature weight is too often ignored. Crossbreeding and composites are sold as a free lunch, but they aren't free.

The graphic shows Beckton cowherd data over the same time period.

1. Beckton cow size has shown no significant change over the past 40 years, while the industry has experienced a substantial increase in cow size.

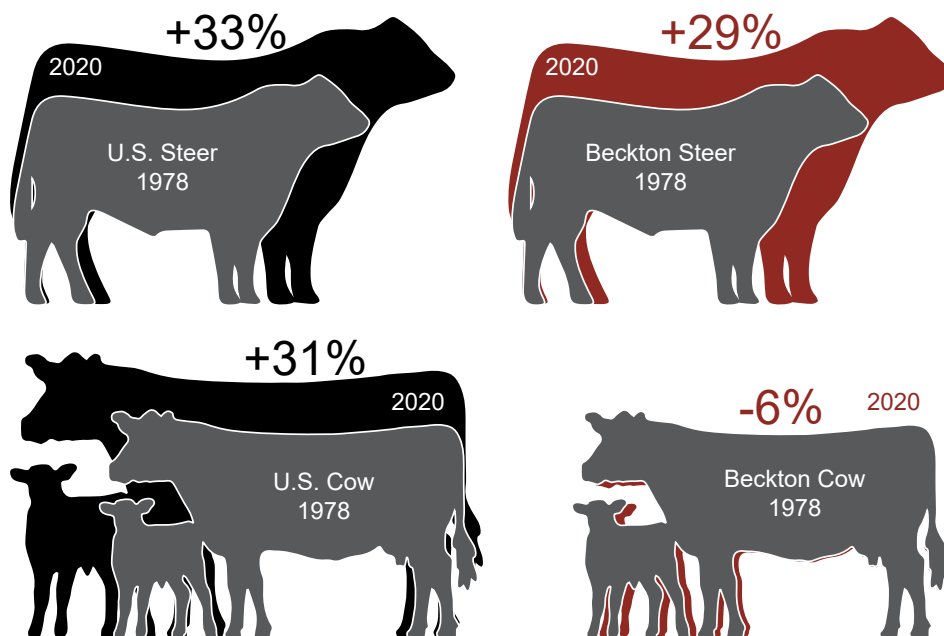

2. Even without increasing cow size, we have raised the rate of early growth in Beckton cattle, using intense genetic selection and generation turnover.
3. The net change in efficiency as measured simply by “calf weight divided by cow weight” is significantly higher with Beckton's genetic program, compared to mainstream cross-breeding based on retained heterosis.

We have accomplished this by selecting for growth, restricting birth weight and cow size creep, and multiplying each incremental change rapidly throughout our entire cowherd and all of our bloodlines. Usually this has meant working within our own bloodlines rather than introducing out-crosses, because the outside genetics for the direction we wanted to go haven't been available. The overall key to success is simply that we have been making small progress in multiple traits, but doing it consistently over a very long period of time.

## Cow Efficiency

We present two indicators of efficiency. The first is Weaning Percent, a simple percentage of calf 205 day weight divided by the dam's actual weight at weaning. The second is PRI Cow Efficiency. This also measures calf weaning weight, but relative to the cow's metabolic weight, and is expressed as an index above or below 100.

These efficiency measures are best used as indicators of where an animal is relative to others, rather than directly for selection. For example, if we see an animal with a low efficiency, we would look at the actual calf and cow weights to decide if the calf is too small, or the cow too big for the environment. That in turn will suggest corrective actions. In general, select for the traits you need to change to make cattle more efficient, and efficiency will be the result.

## Dam Information

A major difference with our catalog is the greater amount of information about the dams we provide. Weaning percent and Cow Efficiency are explained above. In addition, with each sale animal we give the dam's age when this calf was born, and the dam's actual weight when the calf was weaned the previous fall. We also provide her progeny averages – the average birth weight, weaning ratio, and yearling ratio – of her calves.

**Beckton has used performance tested selection since 1945, and we believe our cattle today are the most efficient in the industry.**

## Management

### One Bull – the Simple Solution is the Best Solution

Many cattlemen use Beckton bulls for their heifers because of their low birth weights and high calving ease. Our bulls are even better when used on cows, because replacement heifers tend to be selected from calves out of older cows. **Keeping replacement heifers sired by Beckton bulls is the quickest way to limit cow size creep and to moderate cow size for the future.** In our own program we use the same bulls on both heifers and cows. Every bull is used his first year with heifers to evaluate calving ease, and used in future years with older cows. We get calving ease, growth, and moderate-sized replacements, all with the same bull.

### Quietness and Ease of Handling

The necessity of record keeping means that our cattle will be handled much more than commercial cows. **This benefits our seedstock customers because our cattle will be quieter and easier to handle.** Good disposition is one of our most valued traits.

### Selection for Industry Requirements

In order to make selection decisions appropriate to the commercial beef industry, seedstock cattle need to be managed and measured under conditions which will approximate the commercial industry. **Our cows are run entirely on grass, with hay only if weather conditions require it, because that is how the commercial industry runs cows.** However, almost all commercial calves go into feedlots before slaughter, so feedlot performance and efficiency is an important trait for calves. **Simply put, a producer needs to know how his cows perform on grass, and how his calves perform with feed.**

Our bulls are run on a performance test designed to provide the fairest basis of comparison among them, and

this requires a compromise. Our bulls receive a “growing” ration high in roughage and protein and not as high in energy as a steer would receive. **We want to get a good measure of gainability with which to compare bulls, but we don’t want the bulls fat.**

### Mitch Ziebell, Craig Uden of Darr, NE

Since 1979 all of our bulls have been performance tested at a facility owned and managed by the Kugler family near Cozad, Nebraska. In the fall of 2005, Lane Kugler retired and the operation was bought by a neighboring operation – Darr Feeders. The overall operation is managed by Craig Uden, president of the NCBA, with the bulls under the daily management of Mitch Ziebell. **We have been very impressed with the conscientious care with which Mitch oversees all aspects of the bull management.**



*Mitch Ziebell, Darr Feeders*

## Contributing to the success of the Beckton Program...



*Sarah Schreiber  
Our vet*



*Janet Drake  
Health Permit Expert*



*Cody Cunningham  
Brand Inspector*



*Fracky & Howard  
Assistant Office Admins*



## Additional Facts about the Beckton Program

- Birth weight**
- ▶ Every sire entering our own program is used first on our own heifers, then on our cows.
  - ▶ We have never used high birth weight sires in any part of our program, so big birth weights are rare.
  - ▶ We get the pay weight, but with lower birth weights and greater calving ease.
  - ▶ Full production from heifers. We use the same bulls on heifers and cows.

- Growth**
- ▶ Weaning efficiency, and rate of gain to slaughter weight second to none.
  - ▶ Growth traits must be consistent with maintaining maternal qualities.
  - ▶ Beckton cattle are ideally sized for today's packer demand.

- Hardiness**
- ▶ Every cow in the herd has spent part of her life in the Big Horn Mountain summer range, at elevations from 7000 to 10,500 feet.
  - ▶ In 2001 we PAP tested all of our herd sires. The herd average PAP score was 32.5 at 4000', equivalent to a herd average PAP of 39 at 8000' (excellent scores).
  - ▶ By the time she is 5, our average cow will have been trailed over 80 miles, above and beyond normal pasture rotation.

- Efficiency**
- ▶ The typical dam of our bulls weans over 50% of her body weight in 205 days, under range conditions, with no creep-feeding.
  - ▶ The average dam produces over 100% of her own body weight in a year.

- Fertility**
- ▶ Every bull in our program is used in natural service, with 30-50 heifers/cows.
  - ▶ Every cow in our program must cycle naturally and breed early under range conditions.

- Value**
- ▶ Beckton Red Angus produce more growth without high birth weights.
  - ▶ They are the one-bull solution that can be used on both heifers and cows.
  - ▶ Carcass quality is an extra benefit.

- Reliability**
- ▶ Beckton has been genetically improving Red Angus since 1945, a 30-60 year lead time over other producers.
  - ▶ It is a complete, genetically sound breeding program, which demands whole-herd performance.



Chuck Overturf  
Friend and neighbor - in memorium



Sherry Kobielus  
Always here to help even after retirement



Cody and Chad Halfmann, Halfmann Red Angus

# Beckton History



*Young Sal Forbes up on the mountain.*



*Waldo Forbes - 1st President of the Red Angus Association.*



*Beckton house/office before being moved in 1905 to its current location. This house was built in the 1880s by George Beck, the original homesteader. The antlers are still on the porch, and it is one of the oldest buildings in Sheridan County.*



*The Waldo Forbes family in 1959:  
Ellen, Julia, Sal, Sarah, Cherry, Spike, and Cam & Elfie in front.*



*1960s Beckton Sale with Berdon's broadcast van.*



*Beckton Larkabeau O "220" in 1959 - the 1st Red Angus Bull at ABS*



*Mrs. Waldo (Sal) Forbes was honored as the first woman inducted into the Saddle and Sirloin Club's portrait gallery in Louisville, KY.*

## EPDs – Variability

In September 2018 the Red Angus Association adopted a new basic model (“BOLT”) to calculate EPD’s. Many of the EPD’s are now incorporating more genomic data, and RAAA has moved to “inter-breed” EPD’s by including data from other breeds of cattle. However, since the change, we, and other Red Angus breeders, have been observing higher variability in many of the EPD’s, readily noticeable by fluctuating percentile ranking and re-ranking of sires.

To better understand and explain this to our customers, we are including the following chart showing the average range of variation of percentile rank for 26 sires (see table).

The 26 sires are grouped into 3 categories – “Proven” sires with more than 100 calves (140 calves on average); “Yearling” sires born in 2017 that weaned their first calf crop in 2019; and the “Outcross (non-Beckton breeding)” also born in 2017 but purchased from other herds and selected specifically to have no Beckton breeding, or as little as possible, in their pedigrees.

The data was taken from 13 downloads of RAAA EPD’s between September 2018 and January 2022. A higher numerical value under any EPD means the sires in that group experienced, on average, a wider range of variation in their percentile ranking for that EPD over that time.

Three observations: 1) We would expect to see EPD variability in sires that began as yearlings, but are concerned with the variability occurring among “proven” sires with many calves; and 2) the variability in the non-Beckton “outcross” sires is coming primarily from pedigree influence occurring in the originating herds, which tells us that other Red Angus breeders are experiencing even greater variability than we are; and lastly) indexes such as ProS, HB and GM are calculated from these varying EPD’s, and will themselves vary over time.

We are presenting this information because we want our buyers to be aware that EPD’s and Index values can change significantly in the future.

**Average Range of Percentile Rank Variation for 26 sires**

	#Sires	#Clvs	BW	CED	WW	YW	ME	Milk	HPG	STAY	CEM	CW	Marb	REA	BFat	YG
Proven Sires	11	1532	10	19	14	26	34	38	41	42	44	36	28	28	19	16
Yearling Sires	12	287	12	17	30	36	40	34	46	36	32	32	22	27	17	16
Non-Beckton	3	82	41	45	60	54	53	62	49	40	35	26	27	28	32	38

(data from 13 EPD downloads between September 5, 2018 and January 1, 2022)

## Re-thinking Indexes

It often seems as if the entire beef industry has been in a race to create and implement new EPD’s and Indexes. When the Red Angus Association created its original HerdBuilder and GridMaster Indexes some years ago, they looked like a good idea to help producers assimilate and simplify the proliferation of new EPD’s. In the fall of 2020 RAA substantially changed the original HerdBuilder (HB) and GridMaster (GM), and created a new ProS Index which weights HB and GM equally and adds them together.

Unfortunately, these new indexes do not fit our goals in cattle selection. The new HerdBuilder (HB) has no post-weaning growth or carcass traits in it, so it runs contrary to our goal of balanced cattle performance. The new GridMaster (GM), which is a terminal cross index with no maternal traits at all, is even further from our goals. We could not use either index as a selection tool by itself. We have de-emphasized these Indexes in our catalog format.

The ProS Index combines HB and GM with equal weight. Unfortunately, carcass and growth traits make up a disproportionate amount of the ProS Index. This is contrary to what agricultural economists have been telling ranchers for decades – which is that growth and carcass traits are much less important to profitability than maternal traits.

ProS has a second problem – the positive weighting for growth traits (weaning weight, ADG and carcass weight) is much heavier than the negative weighting for mature weight. Selection for ProS will lead to steadily and rapidly increasing cow size. The costs associated with increasing cow size fall entirely on the cow-calf producer, but the overweighting of carcass traits gives a disproportionate amount of additional income to the packing industry. I do not foresee the highly concentrated and monopolistic packing industry giving more than a tiny share of any additional income back to the cow-calf producer in the form of higher grid premiums. Therefore I am concerned that selection for ProS over time will reduce cow-calf profitability, not increase it.

Lastly, the ProS Index suffers from the same weakness as that of any Index. An Index is a rigid “one size fits all” formula that may or may not fit your operation. For example, if you sell calves at weaning, ProS will over-select for carcass traits that you never get paid for. No one knows your operation better than you do. We think it is better to select for the specific traits that are most likely to benefit your specific operation.

# The Bulls

Our bulls are managed in a manner to gain important performance data and information, and equally importantly, to develop and provide our customers with many years of productive service. We have been testing breeding bulls over 50 years, longer than almost any other producer. Our own breeding is based primarily on natural service, not AI, so we see how our bulls work in the pasture. We use bulls raised and managed just this way, with our own cows and heifers, on every kind of terrain, and high in the Bighorn Mountains.

For the first twenty years our bulls were tested at home here in Wyoming. They received some grain, but otherwise grass pasture and dry hay. In 1979 we moved our test to a facility managed by the Kugler family in Cozad, Nebraska, where the bulls got a ration including silage, corn and protein. When we brought our first bulls home from Kuglers' and used them with our own cowherd, we discovered a dramatic increase in libido and breeding performance. The effect of proper nutrition was apparent, and the bulls would maintain condition and hold up better through the entire breeding season. We have continued managing our bulls at the same facility ever since (now managed by Craig Uden), and we continue to see the same benefits.



Lot 8

We have since used over 500 of these bulls natural service in our own breeding program, on dry range and in the mountains, and have never had a bull fall out of our program early due to his feeding or testing management. Beckton Julian B571, Lancer F442, Nebula M045, Nebula P707, and all of our other great sires were fed and managed in Cozad. Every year we see the results and success of our bull management program, and we serve many satisfied customers.



• Bulls •

**1** **BECKTON ACCENT J559 H5**  
1-A 100% # 4505509 Tat: BKT1 J559



Birth: 3-31-21

Beckton Accent Y260 L3  
**BECKTON ACCENT D326 N4**  
Ref. A-3  
Beckton Lydia S069 NB

Beckton Accent W180 C2  
Beckton Lana W463 L  
Beckton Nebula P P707  
Beckton Lydia P583 WR

Bieber H Hughes W109  
**BECKTON LARKEISA C393 H**  
Beckton Larkeisa Z396 D

Basin Hobo 0545  
Basin Rose 06T0  
Beckton Dominor W640 C5  
Beckton Larkeisa M138 JC

BWt	86
WR	127
YWt.	1080
YR	114
Feb.ADG	3.52
Feb.Scr.	35
Frame	6.0
Feet	Good

DAM										
Age	6	Calv.Ease	BW	WW	YW	Milk	HPG	Stay	Maint.En.	
Wt	1094	EPDs	12	-0.5	77	118	27	13	20	2.0
Prog. BW	73	Marb	+.45		REA	+.10		Bfat		+.03
WR	114	Beef Tenderness	→		DNA: 7 / Very Good	Scan: 2.4 / Tender				
YR	108	Wean Pct.	60%	Cow Eff.	126	HB	81	GM	26	ProS 107
Udder	Very Good									

★★★★★ for Growth, Gainability, Marbling, Superior Cow, High Cow Efficiency, Calving Ease.

**4** **BECKTON ACCENT J019 D4**  
1-A 100% # 4506165 Tat: BKT1 J019



Birth: 2-14-21

Beckton Accent B553 L2  
**BECKTON ACCENT G208 N3**  
Ref. A-7  
Beckton Sierra A836 N

Beckton Accent U777 C2  
Beckton Lana X839 L  
Beckton New Era Y194  
Beckton Sierra S847 WR

Beckton Dominor D254 N8  
**BECKTON TAMARA G192 D**  
Beckton Tamara B363 A

Beckton Dominor A378 W7  
Beckton Indigo W772 N  
Beckton Accent Y312 N3  
Beckton Tamara X447 J

BWt	70
WR	116
YWt.	1169
YR	121
Feb.ADG	4.26
Feb.Scr.	33
Frame	6.0
Feet	Good

DAM										
Age	2	Calv.Ease	BW	WW	YW	Milk	HPG	Stay	Maint.En.	
Wt	850	EPDs	14	-1.2	73	125	26	13	16	4.0
Prog. BW	70	Marb	+.39		REA	+.31		Bfat		+.04
WR	116	Beef Tenderness	→		DNA: 10 / Outstanding	Scan: 2.0 / Tender				
YR	121	Wean Pct.	63%	Cow Eff.	132	HB	55	GM	50	ProS 106
Udder	Good									

★★★★★ for Growth, Gainability, Marbling, Rib-eye area, Superior Cow, High Cow Efficiency, Calving Ease.

**2** **BECKTON LIKABLE J472 L5**  
1-A 100% # 4507267 Tat: BSF1 J472



Birth: 3-25-21

Beckton Likable Y124 L3  
**BECKTON LIKABLE E391 N4**  
Ref. L-4  
Beckton Lana X466 N

Beckton Likable U130 L2  
BKT Pine Marie S802 LO  
Beckton Nebula T398 V3  
Beckton Lana T226 NB

Beckton Loki X833 H4  
**BECKTON MINOLA Z715 L**  
Beckton Minola X585 E

Beckton Loki CL S284  
Beckton Vernice T447 HT  
Beckton Epic K6 S569  
Beckton Minola J409 LN

BWt	82
WR	119
YWt.	1206
YR	127
Feb.ADG	4.03
Feb.Scr.	40
Frame	6.0
Feet	Good

DAM										
Age	9	Calv.Ease	BW	WW	YW	Milk	HPG	Stay	Maint.En.	
Wt	850	EPDs	12	-0.7	78	126	28	8	19	2.0
Prog. BW	78	Marb	+.44		REA	-.01		Bfat		+.04
WR	110	Beef Tenderness	→		DNA: 9 / Outstanding	Scan: 2.9 / Tender				
YR	109	Wean Pct.	72%	Cow Eff.	152	HB	69	GM	52	ProS 121
Udder	Very Good									

★★★★★ for Growth, Gainability, Marbling, Superior Cow, High Cow Efficiency, Calving Ease.

**5** **BECKTON ACCENT J245 E4**  
1-A 100% # 4505401 Tat: BKT1 J245



Birth: 3-16-21

Beckton Accent W180 C2  
**BECKTON ACCENT E172 L3**  
Ref. A-4  
Beckton Indigo Y406 L

Beckton Cody K1 P014  
Beckton Christy R046 CQ  
Beckton Likable U130 L2  
Beckton Indigo R745 WR

Beckton Epic X464 L5  
**BECKTON INDIGO B204 E**  
Beckton Indigo P043 LO

Beckton Epic K6 S569  
Beckton Lana M393 LN  
Beckton Loki C M740  
Beckton Indigo M571 EP

BWt	63
WR	109
YWt.	1099
YR	116
Feb.ADG	4.21
Feb.Scr.	36
Frame	5.0
Feet	Good

DAM										
Age	7	Calv.Ease	BW	WW	YW	Milk	HPG	Stay	Maint.En.	
Wt	1090	EPDs	14	-2.8	68	113	29	12	19	3.0
Prog. BW	77	Marb	+.28		REA	+.20		Bfat		+.03
WR	114	Beef Tenderness	→		DNA: 10 / Outstanding	Scan: 2.5 / Tender				
YR	111	Wean Pct.	52%	Cow Eff.	109	HB	79	GM	37	ProS 115
Udder	Very Good									

★★★★★ for Growth, Gainability, Marbling, Rib-eye area, Superior Cow, Calving Ease.

**3** **BECKTON ACCENT J413 A5**  
1-A 100% # 4505589 Tat: BKT1 J413



Birth: 3-22-21

Beckton Accent Y260 L3  
**BECKTON ACCENT D326 N4**  
Ref. A-3  
Beckton Lydia S069 NB

Beckton Accent W180 C2  
Beckton Lana W463 L  
Beckton Nebula P P707  
Beckton Lydia P583 WR

Beckton Accent W180 C2  
**BECKTON COCA D239 A**  
Beckton Coca T454 NX

Beckton Cody K1 P014  
Beckton Christy R046 CQ  
Beckton Nexus L016  
Beckton Coca P597 CD

BWt	78
WR	110
YWt.	1158
YR	122
Feb.ADG	4.43
Feb.Scr.	35
Frame	5.5
Feet	Good

DAM										
Age	5	Calv.Ease	BW	WW	YW	Milk	HPG	Stay	Maint.En.	
Wt	972	EPDs	14	-2.0	74	125	30	13	21	-2.0
Prog. BW	68	Marb	+.47		REA	+.05		Bfat		+.04
WR	116	Beef Tenderness	→		DNA: 7 / Very Good	Scan: 2.1 / Tender				
YR	121	Wean Pct.	59%	Cow Eff.	124	HB	90	GM	47	ProS 136
Udder	Very Good									

★★★★★ for Low Maintenance, Growth, Gainability, Marbling, Superior Cow, High Cow Efficiency, Calving Ease.



Lot 5

• Bulls •

## 6 BECKTON HUSTLER J236 A2

1-A 100% # 4506907 Tat: BSF1 J236

Birth: 3-15-21

Beckton Hustler CN J102  
**BECKTON HALFMANHUSTLER R588**  
 Ref. H-1

Beckton Vernice F513 CL  
**BECKTON COCA E867 A**  
 Beckton Coca B405 E

Beckton Hustler C G407  
 Beckton Belga G355 NP  
 Beckton Clipper JIM A124  
 Beckton Vernice A663 PC  
 Beckton Accent U777 C2  
 Beckton Christy W779 C  
 Beckton Epic U749 D5  
 Beckton Coca W362 J

BWt	72
WR	123
YWt.	1083
YR	114
Feb.ADG	3.98
Feb.Scr.	34
Frame	5.5
Feet	Good

DAM	
Age	4
Wt	1184
Prog. BW	68
WR	115
YR	107
Udder	Very Good

Calv.Ease	BW	WW	YW	Milk	HPG	Stay	Maint.En.		
EPDs	16	-3.2	66	116	27	11	18	11.0	
Marb	+.48		REA	-.02		Bfat		+.03	
Beef Tenderness	→ DNA: 9 / Outstanding		Scan:		2.3 / Tender				
Wean Pct.	52%	Cow Eff.	110	HB	49	GM	49	ProS	98

★★★★★ for Growth, Gainability, Marbling, Superior Cow, Calving Ease.

## 8 BECKTON ACCENT J045 L4

1-A 100% # 4506319 Tat: BKT1 J045

Birth: 2-20-21

Beckton Accent B553 L2  
**BECKTON ACCENT G208 N3**  
 Ref. A-7

Beckton Sierra A836 N  
**BECKTON SIERRA G674 L**  
 Beckton Sierra W049 N

Beckton Accent U777 C2  
 Beckton Lana X839 L  
 Beckton New Era Y194  
 Beckton Sierra S847 WR  
 Beckton Likable X445 J3  
 Beckton Minola X107 L  
 Beckton Nebula T269 E2  
 Beckton Sierra T224 NB

BWt	68
WR	110
YWt.	1137
YR	118
Feb.ADG	3.92
Feb.Scr.	33
Frame	5.5
Feet	Good

DAM	
Age	2
Wt	902
Prog. BW	68
WR	110
YR	118
Udder	Very Good

Calv.Ease	BW	WW	YW	Milk	HPG	Stay	Maint.En.		
EPDs	13	-1.4	69	122	25	13	16	6.0	
Marb	+.38		REA	+.24		Bfat		+.03	
Beef Tenderness	→ DNA: 9 / Outstanding		Scan:		1.7 / Tender				
Wean Pct.	56%	Cow Eff.	117	HB	43	GM	54	ProS	97

★★★★★ for Growth, Gainability, Marbling, Rib-eye area, Superior Cow, High Cow Efficiency, Calving Ease.

## 7 BECKTON ACCENT J316 E4

1-A 100% # 4506631 Tat: BSF1 J316

Birth: 3-18-21

Beckton Accent W180 C2  
**BECKTON ACCENT E172 L3**  
 Ref. A-4

Beckton Indigo Y406 L  
**BECKTON MINOLA B063 E**  
 Beckton Minola Z752 N

Beckton Cody K1 P014  
 Beckton Christy R046 CQ  
 Beckton Likable U130 L2  
 Beckton Indigo R745 WR  
 Beckton Emperor T641 E2  
 Beckton Lana U789 NB  
 Beckton Nebula W130 D3  
 Beckton Minola N751 JL

BWt	88
WR	111
YWt.	1027
YR	108
Feb.ADG	3.47
Feb.Scr.	36
Frame	5.5
Feet	Good

DAM	
Age	7
Wt	942
Prog. BW	68
WR	105
YR	105
Udder	Very Good

Calv.Ease	BW	WW	YW	Milk	HPG	Stay	Maint.En.		
EPDs	13	-2.2	65	106	28	11	19	-2.0	
Marb	+.28		REA	+.03		Bfat		+.03	
Beef Tenderness	→ DNA: 9 / Outstanding		Scan:		2.3 / Tender				
Wean Pct.	61%	Cow Eff.	129	HB	79	GM	20	ProS	99

★★★★★ for Low Maintenance, Growth, Marbling, Superior Cow, High Cow Efficiency, Calving Ease.

## 9 BECKTON NEBULA J635 E5

1-A 100% # 4505525 Tat: BKT1 J635

Birth: 4-4-21

Beckton Nebula T398 V3  
**BECKTON NEBULA A773 L4**  
 Ref. N-2

Beckton Mona X022 L  
**BECKTON CHRISTY C559 E**  
 Beckton Christy Z125 J

Beckton Nebula L P093  
 Beckton Minerva J615 VG  
 Beckton Likable U130 L2  
 Beckton Mona U584 CD  
 Beckton Epic K6 S569  
 Beckton Lana M393 LN  
 Beckton Julian X721 E6  
 Beckton Christy X354 N

BWt	78
WR	113
YWt.	1062
YR	112
Feb.ADG	3.52
Feb.Scr.	33
Frame	5.5
Feet	Good

DAM	
Age	6
Wt	986
Prog. BW	73
WR	110
YR	108
Udder	Very Good

Calv.Ease	BW	WW	YW	Milk	HPG	Stay	Maint.En.		
EPDs	12	-1.4	69	111	32	13	23	2.0	
Marb	+.27		REA	+.08		Bfat		+.04	
Beef Tenderness	→ DNA: 10 / Outstanding		Scan:		2.9 / Tender				
Wean Pct.	60%	Cow Eff.	125	HB	102	GM	29	ProS	131

★★★★★ for Growth, Gainability, Marbling, Superior Cow, High Cow Efficiency, Calving Ease.



## 10 BECKTON ACCENT J306 A4

1-A 100% # 4505661 Tat: BKT1 J306

Birth: 3-18-21

Beckton Accent W180 C2  
**BECKTON ACCENT E172 L3**  
 Ref. A-4

Beckton Indigo Y406 L  
**BECKTON LANA D614 A**  
 Beckton Lana U025 LO

Beckton Cody K1 P014  
 Beckton Christy R046 CQ  
 Beckton Likable U130 L2  
 Beckton Indigo R745 WR  
 Beckton Accent Y260 L3  
 Beckton Lana W463 L  
 Beckton Loki CL S284  
 Beckton Lana S482 CT

BWt	84
WR	110
YWt.	1016
YR	107
Feb.ADG	3.75
Feb.Scr.	35
Frame	5.5
Feet	Good

DAM	
Age	5
Wt	1050
Prog. BW	72
WR	102
YR	102
Udder	Good

Calv.Ease	BW	WW	YW	Milk	HPG	Stay	Maint.En.		
EPDs	12	-1.4	66	102	26	10	22	1.0	
Marb	+.40		REA	+.08		Bfat		+.04	
Beef Tenderness	→ DNA: 9 / Outstanding		Scan:		2.0 / Tender				
Wean Pct.	55%	Cow Eff.	115	HB	82	GM	25	ProS	107

★★★★★ for Growth, Gainability, Marbling, Calving Ease.

• Bulls •

**11 BECKTON ACCNET J334 A4**  
1-A 100% # 4506661 Tat: BSF1 J334



Birth: 3-19-21

Beckton Accent W180 C2  
**BECKTON ACCENT B549 N3**  
 Ref. A-2 Beckton Minerva Y654 N

Beckton Cody K1 P014  
 Beckton Christy R046 CQ

BWt 73  
 WR 109  
 YWt. 1015  
 YR 107  
 Feb.ADG 3.92  
 Feb.Scr. 36  
 Frame 5.5  
 Feet Good

Beckton Accent W180 C2  
**BECKTON MINERVA B452 A**  
 Beckton Minerva Y520 J

Beckton Cody K1 P014  
 Beckton Christy R046 CQ  
 Beckton Julian U742 W5  
 Beckton Minerva U586 CT

DAM		Calv.Ease	BW	WW	YW	Milk	HPG	Stay	Maint.En.	
Age	7	EPDs	15	-2.8	66	108	24	12	20	5.0
Wt	860	Marb	+.40		REA	+.15		Bfat +.03		
Prog. BW	74	Beef Tenderness→ DNA: 10 / Outstanding		Scan: 2.0 / Tender						
WR	102	Wean Pct. 66%	Cow Eff. 139	HB 72	GM 31	ProS 103				
YR	104									
Udder	Very Good									

★★★★★ for Growth, Gainability, Marbling, Rib-eye area, High Cow Efficiency, Calving Ease.

**14 BECKTON HUGHES J401 A3**  
2 100% # 4505389 Tat: BKT1 J401



Birth: 3-22-21

Bieber H Hughes W109  
**BECKTON HUGHES C463 N2**  
 Ref. B-1 Beckton Lakme T689 NX

Basin Hobo 0545  
 Basin Rose 06T0

BWt 66  
 WR 110  
 YWt. 1062  
 YR 112  
 Feb.ADG 3.86  
 Feb.Scr. 32  
 Frame 5.0  
 Feet Good

Beckton Nexus L016  
 Beckton Lakme M669 EP  
 Beckton Accent W180 C2  
 Beckton Susan P857 JO

**BECKTON ANGEL B070 A**  
 Beckton Angel Z818 N

Beckton Nebula U206 V3  
 Beckton Angel T652 NB

DAM		Calv.Ease	BW	WW	YW	Milk	HPG	Stay	Maint.En.	
Age	7	EPDs	16	-4.4	65	107	25	13	22	4.0
Wt	1048	Marb	+.38		REA	+.09		Bfat +.04		
Prog. BW	61	Beef Tenderness→ DNA: 5 / Average		Scan: 2.4 / Tender						
WR	99	Wean Pct. 55%	Cow Eff. 115	HB 100	GM 33	ProS 133				
YR	103									
Udder	Good									

★★★★★ for Growth, Gainability, Marbling, Calving Ease.

**12 BECKTON ACCENT J455 N5**  
1-A 100% # 4505517 Tat: BKT1 J455



Birth: 3-24-21

Beckton Accent Y260 L3  
**BECKTON ACCENT D326 N4**  
 Ref. A-3 Beckton Lydia S069 NB

Beckton Accent W180 C2  
 Beckton Lana W463 L

BWt 65  
 WR 113  
 YWt. 1060  
 YR 112  
 Feb.ADG 3.35  
 Feb.Scr. 36  
 Frame 5.0  
 Feet Good

Beckton Nebula P P707  
 Beckton Lydia P583 WR

Beckton Nebula M045  
 Beckton Lana M809 EP  
 Beckton Warrior T248 L5  
 Beckton Emera P378 LN

**BECKTON EMERA C459 N**  
 Beckton Emera Y196 W

DAM		Calv.Ease	BW	WW	YW	Milk	HPG	Stay	Maint.En.	
Age	6	EPDs	15	-3.9	66	111	27	13	19	-2.0
Wt	1050	Marb	+.52		REA	-.09		Bfat +.04		
Prog. BW	62	Beef Tenderness→ DNA: 7 / Very Good		Scan: 2.0 / Tender						
WR	102	Wean Pct. 56%	Cow Eff. 117	HB 79	GM 45	ProS 123				
YR	104									
Udder	Fair									

★★★★★ for Low Maintenance, Growth, Marbling, High Cow Efficiency, Calving Ease.



Lot 14

**13 BECKTON HERITAGE J076 H6**  
1-A 100% # 4506155 Tat: BKT1 J076



Birth: 2-25-21

Beckton Heritage D195 L4  
**BECKTON HERITAGE G152 L5**  
 Ref. H-4 Beckton Belga B647 L

Beckton Heritage A767 C3  
 Beckton Susan W846 L

BWt 60  
 WR 118  
 YWt. 1095  
 YR 114  
 Feb.ADG 3.81  
 Feb.Scr. 34  
 Frame 5.5  
 Feet Good

Beckton Legend S670  
 Beckton Belga U103 JC  
 Beckton Hughes C350 N2  
 Beckton Rose C258 H

**BECKTON TAMARA G169 H**  
 Beckton Warrior C237 H6  
 Beckton Tamara C225 E

DAM		Calv.Ease	BW	WW	YW	Milk	HPG	Stay	Maint.En.	
Age	2	EPDs	17	-3.8	70	114	29	11	15	5.0
Wt	782	Marb	+.42		REA	+.10		Bfat +.03		
Prog. BW	60	Beef Tenderness→ DNA: 10 / Outstanding		Scan: 1.7 / Tender						
WR	118	Wean Pct. 70%	Cow Eff. 146	HB 51	GM 42	ProS 93				
YR	114									
Udder	Very Good									

★★★★★ for Growth, Gainability, Marbling, Superior Cow, High Cow Efficiency, Calving Ease.

**15 BECKTON DOMINOR J121 N10**  
1-A 100% # 4506147 Tat: BKT1 J121



Birth: 3-4-21

Beckton Dominor D254 N8  
**BECKTON DOMINOR G402 A9**  
 Ref. D-3 Beckton Lana D273 A

Beckton Dominor A378 W7  
 Beckton Indigo W772 N

BWt 49  
 WR 115  
 YWt. 1090  
 YR 113  
 Feb.ADG 4.55  
 Feb.Scr. 35  
 Frame 5.5  
 Feet Good

Beckton Accent B549 N3  
 Beckton Lana B666 S  
 Beckton Nebula P P707  
 Beckton Larkaba T813 JC

**BECKTON MAIATA G147 N**  
 Beckton Accent W180 C2  
 Beckton Maiata W189 J

DAM		Calv.Ease	BW	WW	YW	Milk	HPG	Stay	Maint.En.	
Age	2	EPDs	20	-7.1	57	97	30	12	18	3.0
Wt	730	Marb	+.46		REA	+.13		Bfat +.03		
Prog. BW	49	Beef Tenderness→ DNA: 10 / Outstanding		Scan: 2.7 / Tender						
WR	115	Wean Pct. 72%	Cow Eff. 151	HB 75	GM 42	ProS 117				
YR	113									
Udder	Very Good									

★★★★★ for Growth, Gainability, Marbling, Rib-eye area, Superior Cow, High Cow Efficiency, Calving Ease.

• Bulls •

**16 BECKTON NEBULA J242 N5**  
1-A 100% # 4506717 Tat: BSF1 J242



Birth: 3-15-21

Beckton Nebula B557 J3	Beckton Nebula P P707	BWt	89
Beckton Larkaba T813 JC	Beckton Larkaba T813 JC	WR	113
<b>BECKTON NEBULA F440 H4</b>	Beckton Hasten H S462	YWt.	1042
Ref. N-4	Beckton Minola N751 JL	YR	110
Beckton Nebula X096 N4	Beckton Nebula U206 V3	Feb.ADG	3.52
<b>BECKTON COCA C411 N</b>	Beckton Tamara U185 NB	Feb.Scr.	34
Beckton Coca Y399 L	Beckton Likable U120 L2	Frame	5.0
	Beckton Coca H051 CH	Feet	Good

<b>DAM</b>	Age	6	Calv.Ease	BW	WW	YW	Milk	HPG	Stay	Maint.En.		
	Wt	1024	EPDs	11	-1.3	60	94	30	10	19	3.0	
	Prog. BW	71	Marb	+.42		REA	-.10		Bfat +.02			
	WR	107	Beef Tenderness	→ DNA: 9 / Outstanding		Scan:	2.6 / Tender					
	YR	106	Wean Pct.	57%	Cow Eff.	120	HB	58	GM	29	ProS	87
	Udder	Good										

★★★★★ for Growth, Gainability, Marbling, Superior Cow, High Cow Efficiency.

**19 BSF LIKABLE J246 J4**  
1-B 99% # 4507243 Tat: BSF1 J246



Birth: 3-16-21

Beckton Likable U130 L2	Beckton Likable S633	BWt	78
Beckton Kit S478 LN	Beckton Kit S478 LN	WR	107
<b>BECKTON LIKABLE D432 N3</b>	Beckton Nebula T054 H3	YWt.	1032
Ref. L-3	Beckton Firefly T003 JC	YR	109
Beckton Julian X721 E6	Beckton Julian U699 L5	Feb.ADG	3.64
<b>BSF JUSTICIA Z119 J</b>	Beckton Lana U329 EP	Feb.Scr.	35
BSF Justicia X113 J	Beckton Jet U473 L2	Frame	5.0
	BSF Justicia U855 JC	Feet	Good

<b>DAM</b>	Age	9	Calv.Ease	BW	WW	YW	Milk	HPG	Stay	Maint.En.		
	Wt	990	EPDs	16	-2.4	60	97	30	13	19	-3.0	
	Prog. BW	69	Marb	+.33		REA	+.19		Bfat +.04			
	WR	113	Beef Tenderness	→ DNA: 7 / Very Good		Scan:	2.3 / Tender					
	YR	107	Wean Pct.	56%	Cow Eff.	118	HB	86	GM	29	ProS	116
	Udder	Very Good										

★★★★★ for Low Maintenance, Growth, Gainability, Marbling, Rib-eye area, Superior Cow, High Cow Efficiency, Calving Ease.

**17 BECKTON JULIAN J362 S8**  
1-A 100% # 4505407 Tat: BKT1 J362



Birth: 3-20-21

Beckton Julian D551 C6	Beckton Julian X465 J5	BWt	62
Beckton Tamara W550 A	Beckton Tamara W550 A	WR	106
<b>BECKTON JULIAN F067 L7</b>	Beckton Likable Z057 L4	YWt.	1086
Ref. J-5	Beckton Indigo Y026 N	YR	114
Beckton Scamp X494 E3	Beckton Scamp T A825	Feb.ADG	3.98
<b>BECKTON TAMARA B253 S</b>	Beckton Lana S074 EP	Feb.Scr.	37
Beckton Tamara X587 J	Beckton Julian U699 L5	Frame	5.5
	Beckton Tamara S432 DM	Feet	Good

<b>DAM</b>	Age	7	Calv.Ease	BW	WW	YW	Milk	HPG	Stay	Maint.En.		
	Wt	1042	EPDs	19	-5.2	57	108	29	13	15	2.0	
	Prog. BW	66	Marb	+.46		REA	+.02		Bfat +.04			
	WR	105	Beef Tenderness	→ DNA: 7 / Very Good		Scan:	2.7 / Tender					
	YR	104	Wean Pct.	53%	Cow Eff.	111	HB	47	GM	64	ProS	111
	Udder	Fair										

★★★★★ for Growth, Gainability, Marbling, Superior Cow, Calving Ease.

**20 BECKTON LIKABLE J079 A6**  
1-A 100% # 4506355 Tat: BKT1 J079



Birth: 2-25-21

Beckton Likable E391 N4	Beckton Likable Y124 L3	BWt	52
Beckton Lana X466 N	Beckton Lana X466 N	WR	101
<b>BECKTON LIKABLE G026 L5</b>	Beckton Likable C584 E4	YWt.	1035
Ref. L-7	Beckton Angel C816 L	YR	107
Beckton Accent W180 C2	Beckton Cody K1 P014	Feb.ADG	3.64
<b>BECKTON LARKABA G808 A</b>	Beckton Christy R046 CQ	Feb.Scr.	34
Beckton Larkaba A911 L	Beckton Legend U331 E2	Frame	5.5
	Beckton Larkaba T418 WA	Feet	Good

<b>DAM</b>	Age	2	Calv.Ease	BW	WW	YW	Milk	HPG	Stay	Maint.En.		
	Wt	862	EPDs	18	-5.8	62	103	26	11	20	3.0	
	Prog. BW	52	Marb	+.47		REA	+.06		Bfat +.04			
	WR	101	Beef Tenderness	→ DNA: 9 / Outstanding		Scan:	1.9 / Tender					
	YR	107	Wean Pct.	53%	Cow Eff.	111	HB	80	GM	47	ProS	127
	Udder	Very Good										

★★★★★ for Growth, Gainability, Marbling, Calving Ease.

**18 BSF CARDINAL J104 H3**  
1-B 99% # 4507065 Tat: BSF1 J104



Birth: 3-2-21

Beckton Cardinal E673 L	TR Double Eagle ZT220	BWt	64
Beckton Larkaba A911 L	Beckton Larkaba A911 L	WR	120
<b>BECKTON CARDINAL G043 C2</b>	TR Double Eagle ZT220	YWt.	1128
Ref. C-3	Beckton Minerva W901 J	YR	117
Beckton Heritage D195 L4	Beckton Heritage A767 C3	Feb.ADG	3.64
<b>BSF CHERISE G242 H</b>	Beckton Susan W846 L	Feb.Scr.	33
BSF Cherise T387 CQ	Beckton Cherokee N N479	Frame	5.5
	BSF Regus G191	Feet	Good

<b>DAM</b>	Age	2	Calv.Ease	BW	WW	YW	Milk	HPG	Stay	Maint.En.		
	Wt	808	EPDs	16	-2.5	76	126	31	13	15	5.0	
	Prog. BW	64	Marb	+.42		REA	+.33		Bfat +.03			
	WR	120	Beef Tenderness	→ DNA: 9 / Outstanding		Scan:	2.1 / Tender					
	YR	117	Wean Pct.	69%	Cow Eff.	145	HB	48	GM	48	ProS	97
	Udder	Very Good										

★★★★★ for Growth, Gainability, Marbling, Rib-eye area, Superior Cow, High Cow Efficiency, Calving Ease.



Lot 18



• Bulls •

**21** **BSF ACCENT J161 N4** 

1-B 99% # 4506733 Tat: BSF1 J161

Birth: 3-9-21

Beckton Accent W180 C2 < Beckton Cody K1 P014  
 Beckton Christy R046 CQ

**BECKTON ACCENT B549 N3**  
 Ref. A-2 < Beckton Nebula T398 V3  
 Beckton Minerva Y654 N < Beckton Minerva M369 LO

Beckton New Era A409 N2 < Beckton New Era Y194  
 Beckton Eola W796 N

**BSF HUSTLE C852 N**  
 BSF Hustle P748 < Beckton Hustler CN J102  
 WF Regus H107

BWt	67
WR	111
YWt.	1058
YR	111
Feb.ADG	3.64
Feb.Scr.	38
Frame	5.0
Feet	Good

DAM											
Age	6	Calv.Ease	BW	WW	YW	Milk	HPG	Stay	Maint.En.		
Wt	1214	EPDs	15	-3.1	70	118	28	12	17	9.0	
Prog. BW	69	Marb	+.32		REA	+.18		Bfat		+.03	
WR	110	Beef Tenderness→ DNA: 10 / Outstanding		Scan: 2.3 / Tender							
YR	107	Wean Pct.	47%	Cow Eff.	100	HB	52	GM	36	ProS	88
Udder	Very Good										

★★★★★ for Growth, Gainability, Marbling, Rib-eye area, Superior Cow, Calving Ease.

**23** **WCRA ACCENT J178** 

1-A 100% # 4522921 Tat: WCRA1 JC17

Birth: 3-9-21

Beckton Cody K1 P014 < Beckton Cody KH M390  
 Beckton Rose M126 WR

**BECKTON ACCENT W180 C2**  
 Ref. A-1 < Beckton Cherokee N N479  
 Beckton Christy R046 CQ < Beckton Christy N740 HR

Beckton Nebula P P707 < Beckton Nebula M045  
 Beckton Lana M809 EP

**WCRA SIRRA E120 N**  
 Beckton Sierra C254 W < Beckton Warrior Y108 E5  
 Beckton Sierra S065 LO

BWt	78
WR	109
YWt.	1026
YR	107
Feb.ADG	2.96
Feb.Scr.	37
Frame	5.5
Feet	Good

DAM											
Age	4	Calv.Ease	BW	WW	YW	Milk	HPG	Stay	Maint.En.		
Wt	1090	EPDs	19	-5.6	56	94	31	12	18	2.0	
Prog. BW	72	Marb	+.45		REA	-.09		Bfat		+.05	
WR	110	Beef Tenderness→ DNA: NA / NA		Scan: 2.8 / Tender							
YR	109	Wean Pct.	58%	Cow Eff.	105	HB	72	GM	30	ProS	102
Udder	Good										

★★★★★ for Growth, Marbling, Superior Cow, Calving Ease.

**22** **BSF LIKABLE J187 W6** 

1-B 99% # 4506843 Tat: BSF1 J187

Birth: 3-12-21

Beckton Likable E391 N4 < Beckton Likable Y124 L3  
 Beckton Lana X466 N

**BECKTON LIKABLE G026 L5**  
 Ref. L-7 < Beckton Likable C584 E4  
 Beckton Angel E130 L < Beckton Angel C816 L

Beckton Warrior C695 W6 < Beckton Warrior Y108 E5  
 Beckton Lana Y033 W

**BSF HUSTELLE E198 W**  
 BSF Hustelle C558 N < Beckton Nebula W778 J4  
 BSF Hustelle Z850 S

BWt	79
WR	124
YWt.	1128
YR	119
Feb.ADG	3.47
Feb.Scr.	31
Frame	5.5
Feet	Good

DAM											
Age	4	Calv.Ease	BW	WW	YW	Milk	HPG	Stay	Maint.En.		
Wt	820	EPDs	16	-3.8	70	114	29	11	15	5.0	
Prog. BW	67	Marb	+.46		REA	-.01		Bfat		+.04	
WR	115	Beef Tenderness→ DNA: 9 / Outstanding		Scan: 2.5 / Tender							
YR	116	Wean Pct.	76%	Cow Eff.	160	HB	46	GM	43	ProS	89
Udder	Good										

★★★★★ for Growth, Marbling, Superior Cow, High Cow Efficiency, Calving Ease.



Lot 24



Lot 22

**24** **WCRA LIKABLE J186** 

1-A 100% # 4522919 Tat: WCRA1 JC18

Birth: 3-16-21

Beckton Likable Z057 L4 < Beckton Likable X445 J3  
 Beckton Minola X107 L

**BECKTON LIKABLE B032 C5**  
 Ref. L-3 < Beckton Clifftop W577 E3  
 Beckton Mona Z270 C < Beckton Mona U584 CD

Beckton Julian A434 N6 < Beckton Julian X465 J5  
 Beckton Lakme T689 NX

**WCRA PINE MARIE E123 J**  
 Carpenter Pine Marie B003 N < Beckton Nebula P P707  
 BKT Pine Marie Z513 W

BWt	73
WR	94
YWt.	1029
YR	107
Feb.ADG	4.15
Feb.Scr.	33
Frame	5.5
Feet	Good

DAM											
Age	4	Calv.Ease	BW	WW	YW	Milk	HPG	Stay	Maint.En.		
Wt	1180	EPDs	17	-5.2	61	119	19	13	15	4.0	
Prog. BW	66	Marb	+.53		REA	+.00		Bfat		+.04	
WR	94	Beef Tenderness→ DNA: NA / NA		Scan: 1.8 / Tender							
YR	107	Wean Pct.	45%	Cow Eff.	96	HB	47	GM	78	ProS	125
Udder	Good										

★★★★★ for Growth, Gainability, Marbling, Calving Ease.

• Bulls •

## 25 WCRA LIKABLE J183

1-A 100% # 4522903 Tat: WCRA1 JC18

Birth: 3-13-21

Beckton Likable Z057 L4  
Beckton Minola X107 L

**BECKTON LIKABLE B032 C5**  
Ref. L-3

Beckton Mona Z270 C  
Beckton Clifftop W577 E3  
Beckton Mona U584 CD

Beckton Nebula W486 D3  
Beckton Belga R716 DM

**BECKTON INDIGO A143 N**  
Beckton Indigo T613 JT  
TR Julian LT151  
Beckton Indigo N467 LO

BWt	84
WR	95
YWt.	993
YR	104
Feb.ADG	3.75
Feb.Scr.	35
Frame	5.5
Feet	Good

DAM		Calv.Ease	BW	WW	YW	Milk	HPG	Stay	Maint.En.
Age	8								
Wt	1530	EPDs	14	-3.6	56	106	19	12	16 15.0
Prog. BW	78	Marb	+.45		REA	-.08		Bfat	+0.04
WR	100	Beef Tenderness→	DNA: NA / NA		Scan:	2.7 / Tender -			
YR	98	Wean Pct.	36%	Cow Eff.	100	HB	32	GM	60 ProS 92
Udder	Very Good								

★★★★★ for Gainability, Marbling, Calving Ease.

## 28 BECKTON NEBULA J592 A5

1-A 100% # 4505613 Tat: BKT1 J592

Birth: 4-1-21

Beckton Nebula B557 J3  
Beckton Larkaba T813 JC

**BECKTON NEBULA F440 H4**  
Ref. N-4

Beckton Minola X638 H  
Beckton Hasten H S462  
Beckton Minola N751 JL

Beckton Accent Y260 L3  
Beckton Lana W463 L

**BECKTON LYDIA D366 A**  
Beckton Lydia A246 L  
Beckton Likable Y362 L3  
Beckton Lydia Y236 W

BWt	82
WR	117
YWt.	1043
YR	110
Feb.ADG	3.52
Feb.Scr.	36
Frame	5.5
Feet	Good

DAM		Calv.Ease	BW	WW	YW	Milk	HPG	Stay	Maint.En.
Age	5								
Wt	912	EPDs	11	-1.8	64	99	29	11	18 4.0
Prog. BW	70	Marb	+.50		REA	-.03		Bfat	+0.04
WR	115	Beef Tenderness→	DNA: 9 / Outstanding		Scan:	2.6 / Tender -			
YR	107	Wean Pct.	67%	Cow Eff.	141	HB	56	GM	35 ProS 92
Udder	Very Good								

★★★★★ for Growth, Gainability, Marbling, Superior Cow, High Cow Efficiency.

## 26 WCRA LIKABLE J188

1-A 100% # 4522915 Tat: WCRA1 JC18

Birth: 3-21-21

Beckton Likable Z057 L4  
Beckton Minola X107 L

**BECKTON LIKABLE B032 C5**  
Ref. L-3

Beckton Mona Z270 C  
Beckton Clifftop W577 E3  
Beckton Mona U584 CD

Beckton Julian A434 N6  
Beckton Lakme T689 NX

**WCRA ROSE E119 J**  
Beckton Rose Z266 E  
Beckton Emcee W526 J2  
Beckton Rose T406 EP

BWt	82
WR	105
YWt.	1038
YR	108
Feb.ADG	3.52
Feb.Scr.	36
Frame	5.5
Feet	Good

DAM		Calv.Ease	BW	WW	YW	Milk	HPG	Stay	Maint.En.
Age	4								
Wt	1230	EPDs	17	-4.9	59	109	25	11	14 7.0
Prog. BW	70	Marb	+.42		REA	-.10		Bfat	+0.04
WR	110	Beef Tenderness→	DNA: NA / NA		Scan:	2.3 / Tender			
YR	108	Wean Pct.	48%	Cow Eff.	107	HB	30	GM	48 ProS 78
Udder	Very Good								

★★★★★ for Growth, Gainability, Marbling, Superior Cow, Calving Ease.

## 29 BECKTON NEBULA J620 S5

1-A 100% # 4505493 Tat: BKT1 J620

Birth: 4-3-21

Beckton Nebula T398 V3  
Beckton Minerva J615 VG

**BECKTON NEBULA A773 L4**  
Ref. N-2

Beckton Mona X022 L  
Beckton Likable U130 L2  
Beckton Mona U584 CD

Beckton Scamp X494 E3  
Beckton Scamp T A825  
Beckton Lana S074 EP

**BECKTON SERENA C296 S**  
Beckton Serena X287 W  
Beckton Warrior T248 L5  
Beckton Serena N088 WR

BWt	70
WR	117
YWt.	1016
YR	107
Feb.ADG	3.07
Feb.Scr.	38
Frame	5.5
Feet	Good

DAM		Calv.Ease	BW	WW	YW	Milk	HPG	Stay	Maint.En.
Age	6								
Wt	1006	EPDs	16	-3.9	56	88	30	13	21 -3.0
Prog. BW	66	Marb	+.32		REA	-.07		Bfat	+0.02
WR	109	Beef Tenderness→	DNA: 10 / Outstanding		Scan:	1.6 / Tender +			
YR	104	Wean Pct.	60%	Cow Eff.	127	HB	98	GM	25 ProS 124
Udder	Good								

★★★★★ for Low Maintenance, Growth, Marbling, Superior Cow, High Cow Efficiency, Calving Ease.

## 27 WCRA JULIAN J189

1-B 99% # 4522913 Tat: WCRA1 JC18

Birth: 3-30-21

Beckton Julian X465 J5  
Beckton Suffeina P643 JL

**BECKTON JULIAN A434 N6**  
Ref. J-4

Beckton Lakme T689 NX  
Beckton Nexus L016  
Beckton Lakme M669 EP

Beckton Scamp B720 L4  
Beckton Larkaba Y448 L

**BSF NEBULANN E272 S**  
BSF Nebulann Z012 L  
Beckton Loki X833 H4  
BSF Nebulann X393 N

BWt	85
WR	95
YWt.	985
YR	99
Feb.ADG	4.15
Feb.Scr.	32
Frame	5.5
Feet	Good

DAM		Calv.Ease	BW	WW	YW	Milk	HPG	Stay	Maint.En.
Age	4								
Wt	1350	EPDs	14	-2.2	63	107	22	10	15 11.0
Prog. BW	81	Marb	+.42		REA	+.01		Bfat	+0.02
WR	94	Beef Tenderness→	DNA: NA / NA		Scan:	1.7 / Tender			
YR	99	Wean Pct.	39%	Cow Eff.	97	HB	32	GM	47 ProS 79
Udder	Very Good								

★★★★★ for Gainability, Marbling, Calving Ease.



• Bulls •

## 30 BECKTON LIKABLE J113 W5

1-A 100% # 4506217 Tat: BKT1 J113

Birth: 3-3-21

**BECKTON LIKABLE G403 N4**  
Ref. L-9

**BECKTON LYDIA G330 W**

Beckton Likable U130 L2  
Beckton Tamara X447 J

Beckton Nebula T398 V3  
Beckton Minerva U310 LO

Beckton Warrior D359 L6  
Beckton Lydia D366 A

Beckton Warrior Y108 E5  
Beckton Lana W463 L

Beckton Accent Y260 L3  
Beckton Lydia A246 L

BWt 58  
WR 105  
YWt. 1066  
YR 111  
Feb.ADG 3.64  
Feb.Scr. 34  
Frame 5.5  
Feet Good

DAM		Calv.Ease	BW	WW	YW	Milk	HPG	Stay	Maint.En.	
Age	2									
Wt	850	EPDs	16	-3.9	61	99	31	10	19	-1.0
Prog. BW	58	Marb	+.36		REA	+.18		Bfat	+.04	
WR	105	Beef Tenderness → DNA: 10 / Outstanding Scan: 2.6 / Tender -								
YR	111	Wean Pct. 56% Cow Eff. 118 HB 73 GM 39 ProS 112								

## 32 BECKTON ORACLE J154 N2

1-A 100% # 4505685 Tat: BKT1 J154

Birth: 3-8-21

**SCHULER ORACLE-7142E**  
Ref. O-1

**BECKTON SERENA D835 N**

Schuler Sudden Impact 0004X  
Sor Marlee Cmmmtnt 0470X

Beckton Nebula X267 J3  
Beckton Serena X617 J

Red Crowfoot Ole's Oscar  
SOR Duchess TS 8915U

Brown Commitment S7206  
SOR Marlee Beef 4511P

Beckton Nebula T269 E2  
Beckton Indigo T613 JT

Beckton Julian G5 S107  
Beckton Serena R023 JC

BWt 63  
WR 98  
YWt. 978  
YR 103  
Feb.ADG 3.13  
Feb.Scr. 35  
Frame 5.0  
Feet Good

DAM		Calv.Ease	BW	WW	YW	Milk	HPG	Stay	Maint.En.	
Age	5									
Wt	1182	EPDs	19	-5.5	52	92	26	11	16	-2.0
Prog. BW	67	Marb	+.62		REA	+.03		Bfat	+.03	
WR	106	Beef Tenderness → DNA: 7 / Very Good Scan: 2.3 / Tender								
YR	108	Wean Pct. 43% Cow Eff. 91 HB 63 GM 60 ProS 124								

★★★★★ for Low Maintenance, Growth, Gainability, Marbling, Rib-eye area, Superior Cow, High Cow Efficiency, Calving Ease.

★★★★★ for Low Maintenance, Marbling, Superior Cow, Calving Ease.



## 33 BECKTON ACCENT J479 N4

1-A 100% # 4505507 Tat: BKT1 J479

Birth: 3-25-21

**BECKTON ACCENT B549 N3**  
Ref. A-2

**BECKTON MINERVA C388 N**

Beckton Accent W180 C2  
Beckton Minerva Y654 N

Beckton New Era Y194  
Beckton Minerva W901 J

Beckton Cody K1 P014  
Beckton Christy R046 CQ

Beckton Nebula T398 V3  
Beckton Minerva M369 LO

Beckton Nebula P P707  
BKT Larkeisa T310 JC

Beckton Julian G3 P608  
Beckton Minerva L344 CH

BWt 71  
WR 104  
YWt. 1060  
YR 112  
Feb.ADG 4.03  
Feb.Scr. 33  
Frame 5.5  
Feet Good

DAM		Calv.Ease	BW	WW	YW	Milk	HPG	Stay	Maint.En.	
Age	6									
Wt	1062	EPDs	16	-3.9	62	108	26	12	19	3.0
Prog. BW	59	Marb	+.40		REA	+.07		Bfat	+.03	
WR	98	Beef Tenderness → DNA: 9 / Outstanding Scan: 2.4 / Tender								
YR	102	Wean Pct. 51% Cow Eff. 107 HB 65 GM 41 ProS 106								

★★★★★ for Growth, Gainability, Marbling, Calving Ease.

## 31 BECKTON HERITAGE J181 E6

1-A 100% # 4505791 Tat: BKT1 J181

Birth: 3-12-21

**BECKTON HERITAGE F615 L5**  
Ref. H-3

**BECKTON MONA E562 E**

Beckton Heritage B612 J4  
Beckton Mona X022 L

Beckton Epic B483 N6  
Beckton Mona W093 N

Beckton Heritage X403 L3  
Beckton Lana N291 JC

Beckton Likable U130 L2  
Beckton Mona U584 CD

Beckton Epic U749 D5  
BKT Pine Marie X339 N

Beckton Nebula T398 V3  
Beckton Mona T809 NB

BWt 80  
WR 105  
YWt. 1047  
YR 110  
Feb.ADG 3.58  
Feb.Scr. 34  
Frame 5.5  
Feet Good

DAM		Calv.Ease	BW	WW	YW	Milk	HPG	Stay	Maint.En.	
Age	4									
Wt	1298	EPDs	9	-1.7	62	100	28	10	17	2.0
Prog. BW	68	Marb	+.43		REA	+.03		Bfat	+.05	
WR	105	Beef Tenderness → DNA: 10 / Outstanding Scan: 2.1 / Tender								
YR	110	Wean Pct. 41% Cow Eff. 86 HB 51 GM 38 ProS 89								

★★★★★ for Growth, Gainability, Marbling, Superior Cow.

## 34 BECKTON ACCENT J211 C3

1-A 100% # 4506727 Tat: BSF1 J211

Birth: 3-14-21

**BECKTON ACCENT W180 C2**  
Ref. A-1

**BECKTON LANA C739 C**

Beckton Cody K1 P014  
Beckton Christy R046 CQ

Beckton Clifftop Y012 C4  
Beckton Lana W314 J

Beckton Cody KH M390  
Beckton Rose M126 WR

Beckton Cherokee N N479  
Beckton Christy N740 HR

Beckton Clifftop W692 E3  
Beckton Lana W240 C

Beckton Jet L P491  
Beckton Lana S866 CH

BWt 68  
WR 100  
YWt. 955  
YR 101  
Feb.ADG 3.81  
Feb.Scr. 34  
Frame 5.0  
Feet Good

DAM		Calv.Ease	BW	WW	YW	Milk	HPG	Stay	Maint.En.	
Age	6									
Wt	1098	EPDs	18	-4.7	54	84	29	11	19	-5.0
Prog. BW	66	Marb	+.34		REA	-.07		Bfat	+.03	
WR	112	Beef Tenderness → DNA: 9 / Outstanding Scan: 1.4 / Tender +								
YR	103	Wean Pct. 47% Cow Eff. 99 HB 84 GM 14 ProS 99								

★★★★★ for Low Maintenance, Gainability, Marbling, Calving Ease.

• Bulls •

**35 BECKTON JET J768 E3** 1-A 100% # 4506175 Tat: BKT1 J768 

Birth: 4-18-21

Beckton Jet L P491  
**BECKTON JET G441 N2** Ref. J-6  
 Beckton Susan B246 N

Beckton Epic B310 J6  
**BECKTON LANA G211 E**  
 Beckton Lana D222 L

TR Julian Lt151  
 Beckton Minerva L278 LN  
 Beckton New Era Y194  
 Beckton Susan R022 CQ  
 Beckton Epic X464 L5  
 Beckton Minerva Y116 J  
 Beckton Legend S670  
 Beckton Lana T348 NB

BWt	82
WR	135
YWt.	1097
YR	114
Feb.ADG	3.24
Feb.Scr.	34
Frame	6.0
Feet	Good

DAM											
Age	2	Calv.Ease	BW	WW	YW	Milk	HPG	Stay	Maint.En.		
Wt	814	EPDs	13	-1.3	72	107	32	13	17	3.0	
Prog. BW	82	Marb	+.45		REA	+.14		Bfat	+.03		
WR	135	Beef Tenderness→ DNA:	10 / Outstanding		Scan:	2.9 / Tender					
YR	114	Wean Pct.	77%	Cow Eff.	163	HB	67	GM	23	ProS	90
Udder	Very Good										

★★★★★ for Growth, Marbling, Rib-eye area, Superior Cow, High Cow Efficiency, Calving Ease.

**38 BECKTON ROOSEVELT J297 L3** 1-A 100% # 4505585 Tat: BKT1 J297 

Birth: 3-18-21

Bieber Roosevelt W384  
**BECKTON ROOSEVELT D305 C2** Ref. B-2  
 Beckton Lana W277 A

Beckton Legend S670  
**BECKTON LANA D222 L**  
 Beckton Lana T348 NB

Bieber Rough Rider 10712  
 Bieber Sheba 9602  
 Beckton Cody K1 P014  
 Beckton Lana N869 LO  
 Beckton Lancer F442 T  
 Beckton Kit F468 JL  
 Beckton Nebula E P084  
 Beckton Lana M167 LN

BWt	87
WR	110
YWt.	1029
YR	108
Feb.ADG	3.86
Feb.Scr.	32
Frame	5.5
Feet	Good

DAM											
Age	5	Calv.Ease	BW	WW	YW	Milk	HPG	Stay	Maint.En.		
Wt	964	EPDs	12	-0.1	65	98	28	11	19	1.0	
Prog. BW	71	Marb	+.39		REA	+.15		Bfat	+.04		
WR	108	Beef Tenderness→ DNA:	7 / Very Good		Scan:	1.7 / Tender					
YR	109	Wean Pct.	59%	Cow Eff.	124	HB	72	GM	25	ProS	97
Udder	Very Good										

★★★★★ for Growth, Gainability, Marbling, Rib-eye area, Superior Cow, High Cow Efficiency, Calving Ease.

**36 BECKTON JET J093 S3** 1-A 100% # 4506079 Tat: BKT1 J093 

Birth: 3-1-21

Beckton Jet L P491  
**BECKTON JET G441 N2** Ref. J-6  
 Beckton Susan B246 N

Beckton Scamp E175 N5  
**BECKTON LANA G029 S**  
 Beckton Lana E722 A

TR Julian Lt151  
 Beckton Minerva L278 LN  
 Beckton New Era Y194  
 Beckton Susan R022 CQ  
 Beckton Scamp B720 L4  
 Beckton Belga W103 N  
 Beckton Accent A485 C3  
 Beckton Lana X839 L

BWt	68
WR	110
YWt.	1032
YR	107
Feb.ADG	3.75
Feb.Scr.	35
Frame	5.5
Feet	Good

DAM											
Age	2	Calv.Ease	BW	WW	YW	Milk	HPG	Stay	Maint.En.		
Wt	718	EPDs	15	-4.4	61	98	28	10	18	3.0	
Prog. BW	68	Marb	+.45		REA	+.07		Bfat	+.03		
WR	110	Beef Tenderness→ DNA:	10 / Outstanding		Scan:	2.2 / Tender					
YR	107	Wean Pct.	70%	Cow Eff.	146	HB	57	GM	33	ProS	90
Udder	Good										

★★★★★ for Growth, Gainability, Marbling, Superior Cow, High Cow Efficiency, Calving Ease.

**39 BSF HUGHES J569 D3** 1-B 99% # 4506681 Tat: BSF1 J569 

Birth: 3-31-21

Bieber H Hughes W109  
**BECKTON HUGHES C463 N2** Ref. B-1  
 Beckton Lakme T689 NX

Beckton Dominor W640 C5  
**BSF CODETTE B734 D**  
 BSF Codette X219 N

Basin Hobo 0545  
 Basin Rose 06T0  
 Beckton Nexus L016  
 Beckton Lakme M669 EP  
 Beckton Dominor Z1 R610  
 Beckton Mona R166 CQ  
 Beckton Nebula T398 V3  
 BSF Codette S162 CD

BWt	64
WR	105
YWt.	1072
YR	113
Feb.ADG	4.21
Feb.Scr.	34
Frame	5.0
Feet	Good

DAM											
Age	7	Calv.Ease	BW	WW	YW	Milk	HPG	Stay	Maint.En.		
Wt	1208	EPDs	18	-5.0	65	106	24	13	21	-1.0	
Prog. BW	66	Marb	+.33		REA	+.12		Bfat	+.04		
WR	97	Beef Tenderness→ DNA:	10 / Outstanding		Scan:	1.0 / Tender +					
YR	100	Wean Pct.	45%	Cow Eff.	95	HB	106	GM	34	ProS	140
Udder	Very Good										

★★★★★ for Low Maintenance, Growth, Gainability, Marbling, Calving Ease.

**37 BECKTON LIKABLE J683 C7** 1-A 100% # 4506391 Tat: BKT1 J683 

Birth: 4-8-21

Beckton Likable B032 C5  
**BECKTON LIKABLE F287 J6** Ref. L-6  
 Beckton Larkaba X064 J

Beckton Cody K1 P014  
**BECKTON TAMARA W550 A**  
 Beckton Tamara R175 CQ

Beckton Likable Z057 L4  
 Beckton Mona Z270 C  
 Beckton Julian U699 L5  
 Beckton Larkaba U475 CT  
 Beckton Cody KH M390  
 Beckton Rose M126 WR  
 Beckton Cherokee N N479  
 Beckton Tamara N765 CO

BWt	64
WR	119
YWt.	1100
YR	112
Feb.ADG	3.69
Feb.Scr.	34
Frame	5.5
Feet	Good

DAM											
Age	12	Calv.Ease	BW	WW	YW	Milk	HPG	Stay	Maint.En.		
Wt	1245	EPDs	19	-6.1	56	96	27	13	18	0.0	
Prog. BW	70	Marb	+.48		REA	-.12		Bfat	+.06		
WR	111	Beef Tenderness→ DNA:	7 / Very Good		Scan:	2.2 / Tender					
YR	109	Wean Pct.	44%	Cow Eff.	93	HB	72	GM	37	ProS	110
Udder	Fair										

★★★★★ for Low Maintenance, Growth, Gainability, Marbling, Superior Cow, Calving Ease.



Lot 39

• Bulls •

## 40 BECKTON JULIAN J448 L8

1-A 100% # 4506665 Tat: BSF1 J448

Birth: 3-23-21

Beckton Julian D551 C6  
Beckton Julian X465 J5  
Beckton Tamara W550 A

**BECKTON JULIAN F067 L7**  
Ref. J-5  
Beckton Indigo D786 L  
Beckton Likable Z057 L4  
Beckton Indigo Y026 N

Beckton Legend S670  
Beckton Lancer F442 T  
Beckton Kit F468 JL

**BECKTON TAMARA B547 L**  
Beckton Tamara U244 NB  
Beckton Nebula L P093  
Beckton Tamara R200 HU

BWt	76
WR	96
YWt	1081
YR	114
Feb.ADG	4.55
Feb.Scr.	34
Frame	5.0
Feet	Good

DAM		Calv.Ease	BW	WW	YW	Milk	HPG	Stay	Maint.En.		
Age	7	EPDs	16	-2.5	64	118	28	12	17	6.0	
Wt	1032	Marb	+.42		REA	+.14		Bfat	+.03		
Prog. BW	66	Beef Tenderness→ DNA: 9 / Outstanding		Scan: 2.1 / Tender							
WR	104	Wean Pct.	48%	Cow Eff.	101	HB	56	GM	67	ProS	123
YR	104										
Udder	Very Good										

★★★★★ for Growth, Gainability, Marbling, Rib-eye area, Superior Cow, Calving Ease.



Lot 40

## 42 BSF HERITAGE J046 N6

1-B 99% # 4507061 Tat: BSF1 J046

Birth: 2-20-21

Beckton Heritage D195 L4  
Beckton Susan W846 L

**BECKTON HERITAGE G152 L5**  
Ref. H-4  
Beckton Belga B647 L  
Beckton Legend S670  
Beckton Belga U103 JC

Beckton Nebula B557 J3  
Beckton Nebula P P707  
Beckton Larkaba T813 JC

**BSF ERICA G235 N**  
BSF Erica B207 L  
Beckton Legend S670  
BSF Erica W053 R

BWt	58
WR	105
YWt	1025
YR	106
Feb.ADG	3.64
Feb.Scr.	32
Frame	5.5
Feet	Good

DAM		Calv.Ease	BW	WW	YW	Milk	HPG	Stay	Maint.En.		
Age	2	EPDs	16	-4.2	59	99	29	11	16	1.0	
Wt	974	Marb	+.51		REA	+.04		Bfat	+.02		
Prog. BW	58	Beef Tenderness→ DNA: 9 / Outstanding		Scan: 2.0 / Tender							
WR	105	Wean Pct.	49%	Cow Eff.	103	HB	53	GM	50	ProS	103
YR	106										
Udder	Good										

★★★★★ for Growth, Gainability, Marbling, Superior Cow, Calving Ease.

## 43 BECKTON ACCENT J219 N4

1-A 100% # 4507169 Tat: BSF1 J219

Birth: 3-14-21

Beckton Accent W180 C2  
Beckton Cody K1 P014  
Beckton Christy R046 CQ

**BECKTON ACCENT B549 N3**  
Ref. A-2  
Beckton Minerva Y654 N  
Beckton Minerva M369 LO

Beckton Nebula T252 L3  
Beckton Nebula L P093  
Beckton Vernice L382 LN

**BECKTON LANA W113 N**  
Beckton Lana T226 NB  
Beckton Nebula E P084  
Beckton Lana P026 DM

BWt	55
WR	94
YWt	1019
YR	107
Feb.ADG	3.98
Feb.Scr.	35
Frame	5.0
Feet	Good

DAM		Calv.Ease	BW	WW	YW	Milk	HPG	Stay	Maint.En.		
Age	12	EPDs	16	-4.9	58	106	21	12	21	4.0	
Wt	1056	Marb	+.34		REA	+.02		Bfat	+.03		
Prog. BW	68	Beef Tenderness→ DNA: 10 / Outstanding		Scan: 2.3 / Tender							
WR	94	Wean Pct.	44%	Cow Eff.	93	HB	85	GM	42	ProS	126
YR	102										
Udder	Very Good										

★★★★★ for Growth, Gainability, Marbling, Calving Ease.



Lot 41

## 41 BECKTON LIKABLE J445 W5

1-A 100% # 4505381 Tat: BKT1 J445

Birth: 3-23-21

Beckton Likable Y124 L3  
Beckton Likable U130 L2  
BKT Pine Marie S802 LO

**BECKTON LIKABLE F242 D4**  
Ref. L-5  
Beckton Firefly A022 D  
Beckton Dominor W640 C5  
Beckton Firefly U801 NB

Beckton Warrior Y108 E5  
Beckton Warrior W534 N4  
Beckton Susan W058 E

**BECKTON MINOLA A873 W**  
Beckton Minola Y687 N  
Beckton Nebula U206 V3  
Beckton Minola R720 JJ

BWt	49
WR	103
YWt	1063
YR	108
Feb.ADG	3.41
Feb.Scr.	34
Frame	5.0
Feet	Good

DAM		Calv.Ease	BW	WW	YW	Milk	HPG	Stay	Maint.En.		
Age	8	EPDs	24	-10.0	49	81	28	12	16	-2.0	
Wt	1052	Marb	+.29		REA	-.11		Bfat	+.04		
Prog. BW	62	Beef Tenderness→ DNA: 9 / Outstanding		Scan: 2.1 / Tender							
WR	105	Wean Pct.	47%	Cow Eff.	98	HB	65	GM	29	ProS	94
YR	105										
Udder	Fair										

★★★★★ for Low Maintenance, Growth, Marbling, Superior Cow, Calving Ease.

• Bulls •

**44 BSF HERITAGE J386 R5** 

1-B 99% # 4507177 Tat: BSF1 J386  
 Birth: 3-21-21  
 Beckton Heritage X403 L3  
**BECKTON HERITAGE C477 J4**  
 Ref. H-2 Beckton Ruth Z858 J  
 Beckton Roman J S158  
**BSF JOANIE W756 J**  
 BSF Regus L009 JL  
 Beckton Heritage T270 J2  
 Beckton Indigo H150 LN  
 Beckton Julian U699 L5  
 Beckton Ruth U557 JT  
 TR Romeo NT379  
 Beckton Belga K285 JL  
 Beckton Julian G1 J526  
 BSF Regus J082

DAM		Calv.Ease	BW	WW	YW	Milk	HPG	Stay	Maint.En.	
Age	12	EPDs	13	-1.2	63	98	32	10	17	-1.0
Wt	1180	Marb	+.34		REA	+.12		Bfat	+.04	
Prog. BW	74	Beef Tenderness	→ DNA: 8 / Very Good		Scan:	2.1 / Tender				
WR	111	Wean Pct.	46%		Cow Eff.	98		HB	59	
YR	106							GM	26	
Udder	Poor							ProS	84	

★★★★★ for Low Maintenance, Growth, Marbling, Superior Cow, Calving Ease.

**46 BSF LIKABLE J270 S4** 

1-B 99% # 4506709 Tat: BSF1 J270  
 Birth: 3-17-21  
 Beckton Likable U130 L2  
**BECKTON LIKABLE D432 N3**  
 Ref. L-3 Beckton Firefly W013 N  
 Beckton Scamp X458 H3  
**BSF WARRITA C219 S**  
 BSF Warrita W536 C  
 Beckton Likable S633  
 Beckton Kit S478 LN  
 Beckton Nebula T054 H3  
 Beckton Firefly T003 JC  
 Beckton Scamp T A825  
 BKT Pine Marie R401 HU  
 BKT Clifftop TP R288  
 BSF Warrita S236 WR

DAM		Calv.Ease	BW	WW	YW	Milk	HPG	Stay	Maint.En.	
Age	6	EPDs	18	-4.1	51	82	29	10	16	-6.0
Wt	926	Marb	+.33		REA	+.18		Bfat	+.03	
Prog. BW	65	Beef Tenderness	→ DNA: NA / NA		Scan:	3.0 / Tender				
WR	105	Wean Pct.	58%		Cow Eff.	122		HB	65	
YR	100							GM	27	
Udder	Good							ProS	92	

★★★★★ for Low Maintenance, Growth, Gainability, Marbling, Rib-eye area, High Cow Efficiency, Calving Ease.



**47 BSF LIKABLE J137 E6** 

1-B 99% # 4507057 Tat: BSF1 J137  
 Birth: 3-6-21  
 Beckton Likable Z057 L4  
**BECKTON LIKABLE G289 J5**  
 Ref. L-8 Beckton Coca B785 J  
 Beckton Epic B310 J6  
**BSF JEWEL G202 E**  
 BSF Jewel Z159 E  
 Beckton Likable X445 J3  
 Beckton Minola X107 L  
 Beckton Julian GG B571  
 Beckton Coca X787 N  
 Beckton Epic X464 L5  
 Beckton Minerva Y116 J  
 Beckton Epic X330 L6  
 BSF Jewel X572 L

DAM		Calv.Ease	BW	WW	YW	Milk	HPG	Stay	Maint.En.	
Age	2	EPDs	13	-2.2	65	103	30	13	13	3.0
Wt	814	Marb	+.44		REA	+.08		Bfat	+.03	
Prog. BW	65	Beef Tenderness	→ DNA: 7 / Very Good		Scan:	2.4 / Tender				
WR	116	Wean Pct.	66%		Cow Eff.	138		HB	36	
YR	109							GM	35	
Udder	Very Good							ProS	71	

★★★★★ for Growth, Gainability, Marbling, Superior Cow, High Cow Efficiency, Calving Ease.

**45 BECKTON PRESIDENT J481 H2** 

1-A 100% # 4505793 Tat: BKT1 J481  
 Birth: 3-25-21  
 LSF SRR Commander 5906C  
**LSF SRR PRESIDENT 8177F**  
 Ref. O-2 LSF SRR Flo-Marie 961 D6451  
 Beckton Heritage C477 J4  
**BECKTON ROSE E571 H**  
 Beckton Rose C547 J  
 HXC Conquest 4405P  
 LSF Crystal R5145 X0414  
 Messmer Packer S008  
 LSF Della P4078 U8051  
 Beckton Heritage X403 L3  
 Beckton Ruth Z858 J  
 Beckton Jet L P491  
 Beckton Rose L311 LN

DAM		Calv.Ease	BW	WW	YW	Milk	HPG	Stay	Maint.En.	
Age	4	EPDs	14	-3.5	65	104	29	14	17	-2.0
Wt	982	Marb	+.65		REA	+.29		Bfat	+.03	
Prog. BW	63	Beef Tenderness	→ DNA: 7 / Very Good		Scan:	3.5 / Tender				
WR	106	Wean Pct.	53%		Cow Eff.	112		HB	80	
YR	108							GM	59	
Udder	Good							ProS	139	

★★★★★ for Low Maintenance, Growth, Marbling, Rib-eye area, Superior Cow, Calving Ease.

**48 BSF ACCENT J292 A5** 

1-B 99% # 4507215 Tat: BSF1 J292  
 Birth: 3-17-21  
 Beckton Accent Y260 L3  
**BECKTON ACCENT D326 N4**  
 Ref. A-3 Beckton Lydia S069 NB  
 Beckton Accent W180 C2  
**BSF DOMINIQUE Y109 A**  
 BSF Dominique W352 J  
 Beckton Accent W180 C2  
 Beckton Lana W463 L  
 Beckton Nebula P P707  
 Beckton Lydia P583 WR  
 Beckton Cody K1 P014  
 Beckton Christy R046 CQ  
 Beckton Juno N493  
 BSF Dominique R653 DM

DAM		Calv.Ease	BW	WW	YW	Milk	HPG	Stay	Maint.En.	
Age	10	EPDs	12	-1.0	69	107	23	12	22	3.0
Wt	1154	Marb	+.50		REA	-.08		Bfat	+.04	
Prog. BW	75	Beef Tenderness	→ DNA: 10 / Outstanding		Scan:	1.9 / Tender				
WR	105	Wean Pct.	44%		Cow Eff.	93		HB	79	
YR	107							GM	29	
Udder	Very Good							ProS	108	

★★★★★ for Gainability, Marbling, Superior Cow, Calving Ease.

• Bulls •

**49 BECKTON LIKABLE J545 J5**  
1-A 100% # 4505645 Tat: BKT1 J545



Birth: 3-30-21

Beckton Likable U130 L2  
BKT Pine Marie S802 LO

**BECKTON LIKABLE E391 N4**  
Ref. L-4

Beckton Nebula T398 V3  
Beckton Lana T226 NB

Beckton Julian X465 J5  
Beckton Julian G5 S107  
Beckton Suffeina P643 JL

**BECKTON COCA D537 J**  
Beckton Coca Z356 A  
Beckton Accent U777 C2  
Beckton Coca P602 JL

BWt	70
WR	118
YWt.	1015
YR	107
Feb.ADG	3.07
Feb.Scr.	36
Frame	5.0
Feet	Good

DAM										
Age	5	Calv.Ease	BW	WW	YW	Milk	HPG	Stay	Maint.En.	
Wt	1064	EPDs	15	-3.4	66	99	30	13	18	4.0
Prog. BW	62	Marb	+.50		REA	-.15		Bfat		+0.04
WR	115	Beef Tenderness	→		DNA: 5 / Average	Scan: 2.8 / Tender -				
YR	101	Wean Pct.	58%	Cow Eff.	121	HB	59	GM	31	ProS 91
Udder	Very Good									

★★★★★ for Growth, Marbling, High Cow Efficiency, Calving Ease.

**52 BECKTON ORACLE J323 A2**  
1-A 100% # 4505631 Tat: BKT1 J323



Birth: 3-18-21

Schuler Sudden Impact 0004X  
Red Crowfoot Ole's Oscar  
SOR Duchess TS 8915U

**SCHULER ORACLE-7142E**  
Ref. O-1

Sor Marlee Cmmtmnt 0470X  
Brown Commitment S7206  
SOR Marlee Beef 4511P

Beckton Accent Y260 L3  
Beckton Accent W180 C2  
Beckton Lana W463 L

**BECKTON ROSE D464 A**  
Beckton Rose Z078 J  
Beckton Janus X799 L2  
Beckton Rose X573 N

BWt	76
WR	100
YWt.	1006
YR	106
Feb.ADG	3.92
Feb.Scr.	31
Frame	5.0
Feet	Good

DAM										
Age	5	Calv.Ease	BW	WW	YW	Milk	HPG	Stay	Maint.En.	
Wt	1084	EPDs	16	-2.4	61	106	25	9	19	0.0
Prog. BW	69	Marb	+.68		REA	+.15		Bfat		+0.03
WR	100	Beef Tenderness	→		DNA: 10 / Outstanding	Scan: 2.6 / Tender -				
YR	101	Wean Pct.	48%	Cow Eff.	101	HB	72	GM	70	ProS 142
Udder	Very Good									

★★★★★ for Low Maintenance, Growth, Gainability, Marbling, Rib-eye area, Calving Ease.

**50 BECKTON JULIAN J361 C8**  
1-A 100% # 4506719 Tat: BSF1 J361



Birth: 3-20-21

Beckton Julian X721 E6  
Beckton Julian U699 L5  
Beckton Lana U329 EP

**BECKTON JULIAN Z382 J7**  
Ref. J-3

Beckton Larkaba X064 J  
Beckton Julian U699 L5  
Beckton Larkaba U475 CT

Beckton Clifftop Y012 C4  
Beckton Clifftop W692 E3  
Beckton Lana W240 C

**BECKTON LANA C551 C**  
Beckton Lana X767 C  
Beckton Cherokee T450 L3  
Beckton Lana T674 JL

BWt	60
WR	103
YWt.	1006
YR	106
Feb.ADG	3.47
Feb.Scr.	34
Frame	5.0
Feet	Good

DAM										
Age	6	Calv.Ease	BW	WW	YW	Milk	HPG	Stay	Maint.En.	
Wt	1026	EPDs	22	-7.6	56	91	31	11	18	-10.0
Prog. BW	60	Marb	+.24		REA	-.14		Bfat		+0.05
WR	101	Beef Tenderness	→		DNA: 8 / Very Good	Scan: 2.1 / Tender				
YR	103	Wean Pct.	52%	Cow Eff.	110	HB	90	GM	15	ProS 105
Udder	Very Good									

★★★★★ for Low Maintenance, Growth, Marbling, Calving Ease.



Lot 52

**51 BECKTON ACCENT J020 L4**  
1-A 100% # 4506157 Tat: BKT1 J020



Birth: 2-14-21

Beckton Accent B553 L2  
Beckton Accent U777 C2  
Beckton Lana X839 L

**BECKTON ACCENT G260 N3**  
Ref. A-8

Beckton Tamara B394 N  
Beckton New Era Y194  
Beckton Tamara Y612 L

Beckton Likable X057 L4  
Beckton Likable X445 J3  
Beckton Minola X107 L

**BECKTON MARTA G177 L**  
Beckton Marta B806 N  
Beckton New Era Y194  
Beckton Marta X704 H

BWt	49
WR	98
YWt.	1001
YR	104
Feb.ADG	3.75
Feb.Scr.	32
Frame	5.0
Feet	Good

DAM										
Age	2	Calv.Ease	BW	WW	YW	Milk	HPG	Stay	Maint.En.	
Wt	622	EPDs	19	-7.0	49	85	26	12	16	0.0
Prog. BW	49	Marb	+.49		REA	+.07		Bfat		+0.03
WR	98	Beef Tenderness	→		DNA: 9 / Outstanding	Scan: 2.6 / Tender -				
YR	104	Wean Pct.	71%	Cow Eff.	149	HB	49	GM	48	ProS 97
Udder	Very Good									

★★★★★ for Low Maintenance, Gainability, Marbling, High Cow Efficiency, Calving Ease.

**53 BECKTON ACCENT J069 R4**  
1-A 100% # 4506187 Tat: BKT1 J069



Birth: 2-22-21

Beckton Accent B553 L2  
Beckton Accent U777 C2  
Beckton Lana X839 L

**BECKTON ACCENT G260 N3**  
Ref. A-8

Beckton Tamara B394 N  
Beckton New Era Y194  
Beckton Tamara Y612 L

Beckton Ranger B006 D5  
Beckton Ranger Z225 J4  
Beckton Suffeina Z731 D

**BECKTON LARKABA G241 R**  
Beckton Larkaba X549 L  
Beckton Loki CL S284  
Beckton Larkaba R615 JE

BWt	56
WR	107
YWt.	998
YR	104
Feb.ADG	3.52
Feb.Scr.	35
Frame	5.5
Feet	Good

DAM										
Age	2	Calv.Ease	BW	WW	YW	Milk	HPG	Stay	Maint.En.	
Wt	834	EPDs	18	-4.9	56	92	26	11	16	4.0
Prog. BW	56	Marb	+.45		REA	+.04		Bfat		+0.03
WR	107	Beef Tenderness	→		DNA: 9 / Outstanding	Scan: 2.2 / Tender				
YR	104	Wean Pct.	58%	Cow Eff.	122	HB	52	GM	38	ProS 90
Udder	Very Good									

★★★★★ for Gainability, Marbling, Superior Cow, High Cow Efficiency, Calving Ease.

• Bulls •

**54 BECKTON LIKABLE J727 C7**  
1-A 100% # 4507251 Tat: BSF1 J727 

Birth: 4-15-21

Beckton Likable B032 C5  
**BECKTON LIKABLE F287 J6**  
Ref. L-6  
Beckton Larkaba X064 J

Beckton Likable Z057 L4  
Beckton Mona Z270 C  
Beckton Julian U699 L5  
Beckton Larkaba U475 CT

BWT 84  
WR 114  
YWt. 1062  
YR 112  
Feb.ADG 3.58  
Feb.Scr. 34  
Frame 5.5  
Feet Good

Beckton Clifftop W577 E3  
**BECKTON BARMAID Z227 C**  
Beckton Barmaid P323 HR

BKT Clifftop TP R288  
BKT Pine Marie R213 EP  
Beckton Herald FV J537  
Beckton Barmaid J012 CO

DAM												
Age	9	Calv.Ease	BW	WW	YW	Milk	HPG	Stay	Maint.En.			
Wt	948	EPDs	14	-2.7	59	101	25	14	19	2.0		
Prog. BW	75	Marb	+.50		REA	-.12		Bfat	+.05			
WR	108	Beef Tenderness	→ DNA: 7 / Very Good			Scan:	NA / NA					
YR	104	Wean Pct.	63%		Cow Eff.	132	HB	67	GM	42	ProS	109
Udder	Good											

★★★★★ for Growth, Gainability, Marbling, Superior Cow, High Cow Efficiency, Calving Ease.

**56 BECKTON ACCENT J173 J5**  
1-A 100% # 4506447 Tat: BKT1 J173 

Birth: 3-11-21

Beckton Accent Y260 L3  
**BECKTON ACCENT D326 N4**  
Ref. A-3  
Beckton Lydia S069 NB

Beckton Accent W180 C2  
Beckton Lana W463 L  
Beckton Nebula P P707  
Beckton Lydia P583 WR

BWT 86  
WR 109  
YWt. 1016  
YR 107  
Feb.ADG 3.98  
Feb.Scr. 34  
Frame 5.0  
Feet Good

Beckton Janus X799 L2  
**BECKTON ROSE Z078 J**  
Beckton Rose X573 N

Beckton Roman J S158  
Beckton Sierra K557 LO  
Beckton Nebula T054 H3  
Beckton Rose T142 HI

DAM												
Age	9	Calv.Ease	BW	WW	YW	Milk	HPG	Stay	Maint.En.			
Wt	968	EPDs	12	0.2	68	110	26	10	18	0.0		
Prog. BW	80	Marb	+.45		REA	-.05		Bfat	+.03			
WR	107	Beef Tenderness	→ DNA: 8 / Very Good			Scan:	2.2 / Tender					
YR	103	Wean Pct.	59%		Cow Eff.	123	HB	48	GM	31	ProS	79
Udder	Very Good											

★★★★★ for Low Maintenance, Growth, Gainability, Marbling, High Cow Efficiency, Calving Ease.

**55 BECKTON ACCENT J581 E4**  
1-A 100% # 4505461 Tat: BKT1 J581 

Birth: 4-1-21

Beckton Accent W180 C2  
**BECKTON ACCENT E172 L3**  
Ref. A-4  
Beckton Indigo Y406 L

Beckton Cody K1 P014  
Beckton Christy R046 CQ  
Beckton Likable U130 L2  
Beckton Indigo R745 WR

BWT 65  
WR 108  
YWt. 1032  
YR 109  
Feb.ADG 3.47  
Feb.Scr. 34  
Frame 5.0  
Feet Good

Beckton Epic A286 E7  
**BECKTON EMERA C066 E**  
Beckton Emera A029 D

Beckton Epic Y484 N6  
Beckton Larkaba Y648 E  
Beckton Dominor Y005 V6  
Beckton Emera Y009 D

DAM												
Age	6	Calv.Ease	BW	WW	YW	Milk	HPG	Stay	Maint.En.			
Wt	1196	EPDs	19	-5.2	58	96	27	11	20	-2.0		
Prog. BW	63	Marb	+.37		REA	+.15		Bfat	+.04			
WR	98	Beef Tenderness	→ DNA: 7 / Very Good			Scan:	3.0 / Tender -					
YR	102	Wean Pct.	47%		Cow Eff.	98	HB	91	GM	36	ProS	127
Udder	Very Good											

★★★★★ for Low Maintenance, Growth, Marbling, Rib-eye area, Calving Ease.

**57 BECKTON LIKABLE J343 A5**  
1-A 100% # 4505887 Tat: BKT1 J343 

Birth: 3-19-21

Beckton Likable Y124 L3  
**BECKTON LIKABLE E391 N4**  
Ref. L-4  
Beckton Lana X466 N

Beckton Likable U130 L2  
BKT Pine Marie S802 LO  
Beckton Nebula T398 V3  
Beckton Lana T226 NB

BWT 64  
WR 122  
YWt. 1027  
YR 112  
Feb.ADG 3.58  
Feb.Scr. 34  
Frame 5.5  
Feet Good

Beckton Accent W180 C2  
**BECKTON LANA F171 A**  
Beckton Lana C178 E

Beckton Cody K1 P014  
Beckton Christy R046 CQ  
Beckton Epic X330 L6  
Beckton Lana U025 LO

DAM												
Age	3	Calv.Ease	BW	WW	YW	Milk	HPG	Stay	Maint.En.			
Wt	850	EPDs	14	-2.5	74	115	27	10	20	5.0		
Prog. BW	64	Marb	+.45		REA	+.01		Bfat	+.03			
WR	112	Beef Tenderness	→ DNA: 9 / Outstanding			Scan:	1.7 / Tender					
YR	102	Wean Pct.	65%		Cow Eff.	136	HB	75	GM	35	ProS	110
Udder	Very Good											

★★★★★ for Growth, Gainability, Marbling, High Cow Efficiency, Calving Ease.



**58 BECKTON ORACLE J359 A3**  
2 100% # 4505727 Tat: BKT1 J359 

Birth: 3-16-21

Schuler Oracle-7142E  
**BECKTON ORACLE G222 J2**  
Ref. O-3  
Beckton Rose E470 J

Schuler Sudden Impact 0004X  
Sor Marlee Cnmtrnt 0470X  
Beckton Julian GG B571  
Beckton Rose W346 E

BWT 64  
WR 106  
YWt. 1026  
YR 108  
Feb.ADG 3.52  
Feb.Scr. 34  
Frame 5.0  
Feet Good

Beckton Accent W180 C2  
**BECKTON LARKEISA E225 A**  
BKT Larkeisa R676 DM

Beckton Cody K1 P014  
Beckton Christy R046 CQ  
Beckton Dominor ZC M919  
BKT Larkeisa M816 EP

DAM												
Age	4	Calv.Ease	BW	WW	YW	Milk	HPG	Stay	Maint.En.			
Wt	1140	EPDs	20	-5.7	55	95	28	10	17	3.0		
Prog. BW	63	Marb	+.58		REA	+.13		Bfat	+.04			
WR	106	Beef Tenderness	→ DNA: 10 / Outstanding			Scan:	2.0 / Tender					
YR	106	Wean Pct.	47%		Cow Eff.	98	HB	66	GM	66	ProS	132
Udder	NA											

★★★★★ for Growth, Gainability, Marbling, Rib-eye area, Superior Cow, Calving Ease.



• Bulls •

**59 BECKTON ACCENT J097 A4** 

1-A 100% # 4507163 Tat: BSF1 J097  
 Birth: 3-1-21  
 Beckton Accent B553 L2  
**BECKTON ACCENT G208 N3**  
 Ref. A-7 Beckton Sierra A836 N  
 Beckton New Era Y194  
 Beckton Sierra S847 WR  
 Beckton Accent W180 C2  
 Beckton Minerva Y654 N  
**BECKTON SIERRA G809 A**  
 Beckton Sierra Y058 J  
 Beckton Julian W841 J5  
 Beckton Sierra W503 J

DAM		Calv.Ease	BW	WW	YW	Milk	HPG	Stay	Maint.En.	
Age	2	EPDs	12	-0.7	73	121	23	13	16	8.0
Wt	682	Marb	+0.37		REA +0.18		Bfat +0.04			
Prog. BW	66	Beef Tenderness → DNA: 10 / Outstanding Scan: 2.1 / Tender								
WR	108	Wean Pct. 72% Cow Eff. 152 HB 45 GM 37 ProS 83								
YR	111									
Udder	Fair									

★★★★★ for Growth, Gainability, Marbling, Rib-eye area, Superior Cow, High Cow Efficiency, Calving Ease.

**61 BECKTON HERITAGE J010 E6** 

1-A 100% # 4506261 Tat: BKT1 J010  
 Birth: 2-10-21  
 Beckton Heritage D195 L4  
**BECKTON HERITAGE G152 L5**  
 Ref. H-4 Beckton Belga B647 L  
 Beckton Legend S670  
 Beckton Belga U103 JC  
 Beckton Epic X464 L5  
 Beckton Minerva Y116 J  
**BECKTON KIT G443 E**  
 Beckton Epic B310 J6  
 Beckton Kit D126 A  
 Beckton Accent U777 C2  
 Beckton Kit Z049 N

DAM		Calv.Ease	BW	WW	YW	Milk	HPG	Stay	Maint.En.	
Age	2	EPDs	18	-5.0	59	96	30	13	15	1.0
Wt	740	Marb	+0.42		REA +0.07		Bfat +0.03			
Prog. BW	57	Beef Tenderness → DNA: 10 / Outstanding Scan: 1.6 / Tender +								
WR	108	Wean Pct. 66% Cow Eff. 139 HB 54 GM 37 ProS 91								
YR	104									
Udder	Good									

★★★★★ for Marbling, Superior Cow, High Cow Efficiency, Calving Ease.



Lot 60

**62 BECKTON CARDINAL J220 W3** 

1-A 100% # 4506069 Tat: BKT1 J220  
 Birth: 3-14-21  
 Beckton Cardinal E673 L  
**BECKTON CARDINAL G043 C2**  
 Ref. C-3 Beckton Minerva E181 D  
 TR Double Eagle ZT220  
 Beckton Larkaba A911 L  
 Beckton Minerva W901 J  
 Beckton Warrior E215 E7  
 Beckton Warrior C695 W6  
 Beckton Suffeina C124 E  
**BECKTON PINE MARIE G001 W**  
 Beckton Pine Marie E003 N  
 Beckton Nebula C067 N5  
 Beckton Pine Marie C072 N

DAM		Calv.Ease	BW	WW	YW	Milk	HPG	Stay	Maint.En.	
Age	2	EPDs	17	-4.5	63	105	29	12	18	2.0
Wt	736	Marb	+0.44		REA +0.24		Bfat +0.04			
Prog. BW	68	Beef Tenderness → DNA: 10 / Outstanding Scan: 3.3 / Tender -								
WR	111	Wean Pct. 69% Cow Eff. 144 HB 73 GM 42 ProS 115								
YR	107									
Udder	Good									

★★★★★ for Growth, Gainability, Marbling, Rib-eye area, Superior Cow, High Cow Efficiency, Calving Ease.

**60 BECKTON ACCENT J397 N4** 

1-A 100% # 4505419 Tat: BKT1 J397  
 Birth: 3-21-21  
 Beckton Accent W180 C2  
**BECKTON ACCENT E172 L3**  
 Ref. A-4 Beckton Indigo Y406 L  
 Beckton Likable U130 L2  
 Beckton Indigo R745 WR  
 Beckton Nebula M045  
 Beckton Lana M809 EP  
**BECKTON CHRISTY B401 N**  
 Beckton Nebula P P707  
 Beckton Christy T444 JL  
 Beckton Julian G2 M345  
 Beckton Christy L654 JL

DAM		Calv.Ease	BW	WW	YW	Milk	HPG	Stay	Maint.En.	
Age	7	EPDs	15	-3.9	59	97	25	13	20	-6.0
Wt	1016	Marb	+0.39		REA +0.00		Bfat +0.03			
Prog. BW	65	Beef Tenderness → DNA: 9 / Outstanding Scan: 1.8 / Tender								
WR	99	Wean Pct. 52% Cow Eff. 110 HB 88 GM 32 ProS 121								
YR	102									
Udder	Very Good									

★★★★★ for Low Maintenance, Marbling, Calving Ease.

**63 BECKTON ACCENT J389 L5** 

1-A 100% # 4505495 Tat: BKT1 J389  
 Birth: 3-21-21  
 Beckton Accent Y260 L3  
**BECKTON ACCENT D326 N4**  
 Ref. A-3 Beckton Lydia S069 NB  
 Beckton Accent W180 C2  
 Beckton Lana W463 L  
 Beckton Nebula P P707  
 Beckton Lydia P583 WR  
 Mushrush Lunesta A007  
 Mushrush Candice JL X212  
**BECKTON SIERRA C324 L**  
 Beckton Sierra A245 L  
 Beckton Likable Y124 L3  
 Beckton Sierra Y188 N

DAM		Calv.Ease	BW	WW	YW	Milk	HPG	Stay	Maint.En.	
Age	6	EPDs	14	-2.8	62	99	30	10	20	1.0
Wt	1066	Marb	+0.53		REA -0.08		Bfat +0.04			
Prog. BW	64	Beef Tenderness → DNA: 6 / Average Scan: 2.5 / Tender								
WR	102	Wean Pct. 51% Cow Eff. 107 HB 71 GM 36 ProS 107								
YR	103									
Udder	Very Good									

★★★★★ for Marbling, Calving Ease.

• Bulls •

**64 BECKTON SCAMP J053 A7** 1-A 100% # 4506357 Tat: BKT1 J053 

Birth: 2-20-21

Beckton Scamp E175 N5  
**BECKTON SCAMP G006 C6**  
 Ref. S-2 Beckton Firefly E769 C

Beckton Scamp B720 L4  
 Beckton Belga W103 N

Beckton Cardinal B074 N  
 Beckton Firefly B052 W

Beckton Accent B553 L2  
**BECKTON ROSE G830 A**  
 Beckton Rose C034 E

Beckton Accent U777 C2  
 Beckton Lana X839 L

Beckton Epic A286 E7  
 Beckton Rose A417 C

BWt	52
WR	108
YWt.	974
YR	101
Feb.ADG	3.24
Feb.Scr.	34
Frame	5.0
Feet	Good

DAM										
Age	2	Calv.Ease	BW	WW	YW	Milk	HPG	Stay	Maint.En.	
Wt	668	EPDs	18	-5.8	51	93	26	10	15	7.0
Prog. BW	52	Marb	+.40		REA	+.04		Bfat	+.03	
WR	108	Beef Tenderness	→ DNA: 10 / Outstanding		Scan:	1.9 / Tender				
YR	101	Wean Pct.	73%		Cow Eff.	155		HB	39	
Udder	Good				GM	46		ProS	85	

★★★★★ for Marbling, High Cow Efficiency, Calving Ease.

**67 BECKTON LIKABLE J256 A4** 1-A 100% # 4505547 Tat: BKT1 J256 

Birth: 3-16-21

Beckton Likable U130 L2  
**BECKTON LIKABLE D432 N3**  
 Ref. L-3 Beckton Firefly W013 N

Beckton Likable S633  
 Beckton Kit S478 LN

Beckton Nebula T054 H3  
 Beckton Firefly T003 JC

Beckton Cody K1 P014  
**BECKTON KIT C839 A**  
 Beckton Kit Z181 D

Beckton Christy R046 CQ  
 Beckton Dominor W640 C5  
 Beckton Kit R503 LN

BWt	67
WR	101
YWt.	910
YR	96
Feb.ADG	3.07
Feb.Scr.	32
Frame	5.0
Feet	Good

DAM										
Age	6	Calv.Ease	BW	WW	YW	Milk	HPG	Stay	Maint.En.	
Wt	1112	EPDs	19	-4.9	51	79	25	11	20	-8.0
Prog. BW	63	Marb	+.37		REA	+.13		Bfat	+.04	
WR	101	Beef Tenderness	→ DNA: 7 / Very Good		Scan:	1.8 / Tender				
YR	100	Wean Pct.	47%		Cow Eff.	99		HB	98	
Udder	NA				GM	26		ProS	124	

★★★★★ for Low Maintenance, Marbling, Rib-eye area, Calving Ease.

**65 BECKTON LIKABLE J449 N4** 1-A 100% # 4507211 Tat: BSF1 J449 

Birth: 3-23-21

Beckton Likable U130 L2  
**BECKTON LIKABLE D432 N3**  
 Ref. L-3 Beckton Firefly W013 N

Beckton Likable S633  
 Beckton Kit S478 LN

Beckton Nebula T054 H3  
 Beckton Firefly T003 JC

Beckton Nebula L P093  
**BECKTON ENCINO X785 N**  
 Beckton Encino S456 JC

Beckton Minerva J615 VG  
 Beckton Justice G302  
 Beckton Encino J431 DM

BWt	77
WR	105
YWt.	984
YR	104
Feb.ADG	3.30
Feb.Scr.	34
Frame	5.0
Feet	Good

DAM										
Age	11	Calv.Ease	BW	WW	YW	Milk	HPG	Stay	Maint.En.	
Wt	1168	EPDs	14	-1.8	58	94	24	12	20	-6.0
Prog. BW	74	Marb	+.36		REA	+.11		Bfat	+.03	
WR	108	Beef Tenderness	→ DNA: 7 / Very Good		Scan:	2.1 / Tender				
YR	108	Wean Pct.	45%		Cow Eff.	95		HB	85	
Udder	Good				GM	34		ProS	119	

★★★★★ for Low Maintenance, Marbling, Superior Cow, Calving Ease.



**66 BECKTON ACCENT J228 L5** 1-A 100% # 4506729 Tat: BSF1 J228 

Birth: 3-15-21

Beckton Accent Y260 L3  
**BECKTON ACCENT D326 N4**  
 Ref. A-3 Beckton Lydia S069 NB

Beckton Accent W180 C2  
 Beckton Lana W463 L

Beckton Nebula P P707  
 Beckton Lydia P583 WR

Beckton Likable U130 L2  
**BECKTON ANGEL C816 L**  
 Beckton Angel X450 N

Beckton Tamara M515 LN  
 Beckton Nebula T398 V3  
 Beckton Angel T004 CT

BWt	63
WR	101
YWt.	942
YR	99
Feb.ADG	3.58
Feb.Scr.	34
Frame	5.0
Feet	Good

DAM										
Age	6	Calv.Ease	BW	WW	YW	Milk	HPG	Stay	Maint.En.	
Wt	1022	EPDs	16	-4.3	57	88	27	10	19	-5.0
Prog. BW	62	Marb	+.51		REA	-.09		Bfat	+.04	
WR	98	Beef Tenderness	→ DNA: 9 / Outstanding		Scan:	2.1 / Tender				
YR	97	Wean Pct.	51%		Cow Eff.	108		HB	69	
Udder	Very Good				GM	29		ProS	98	

★★★★★ for Low Maintenance, Gainability, Marbling, Calving Ease.

**68 BECKTON JULIAN J396 L2** 1-A 100% # 4505623 Tat: BKT1 J396 

Birth: 3-21-21

Beckton Julian GG B571  
**BECKTON JULIAN G3 P608**  
 Ref. J-2 Bkt Suffeina A828 DM

Beckton Julian 7526G  
 Bkt Marta 9A13 JL

Beckton Dominor 9455  
 Bkt Suffeina 9493 TT

Beckton Likable U130 L2  
**BECKTON LANA D429 L**  
 Beckton Lana Y726 N

Beckton Likable S633  
 Beckton Kit S478 LN

Beckton Nebula T398 V3  
 Beckton Lana T348 NB

BWt	66
WR	104
YWt.	945
YR	100
Feb.ADG	2.67
Feb.Scr.	37
Frame	5.0
Feet	Good

DAM										
Age	5	Calv.Ease	BW	WW	YW	Milk	HPG	Stay	Maint.En.	
Wt	1004	EPDs	18	-5.6	49	77	27	12	17	-9.0
Prog. BW	65	Marb	+.55		REA	+.02		Bfat	+.02	
WR	106	Beef Tenderness	→ DNA: 5 / Average		Scan:	1.9 / Tender				
YR	106	Wean Pct.	54%		Cow Eff.	113		HB	63	
Udder	Very Good				GM	38		ProS	102	

★★★★★ for Low Maintenance, Marbling, Superior Cow, Calving Ease.

• Bulls •

**69 BECKTON ORACLE J133 D3**  
1-A 100% # 4506289 Tat: BKT1 J133



Birth: 3-6-21

Schuler Oracle-7142E < Schuler Sudden Impact 0004X  
Sor Marlee Cmmtmnt 0470X

**BECKTON ORACLE G434 A2**  
Ref. O-4 Beckton Larkaba D449 A < Beckton Accent U777 C2  
Beckton Larkaba U475 CT

Beckton Dominor A378 W7 < Beckton Dominor Y005 V6  
Beckton Lana Y541 W

**BECKTON PINE MARIE G541 D**  
BKT Pine Marie W102 C < BKT Clifftop TP R288  
BKT Pine Marie M119 EP

BWt	58
WR	107
YWt.	1047
YR	109
Feb.ADG	3.98
Feb.Scr.	35
Frame	5.0
Feet	Good

DAM	
Age	2
Wt	670
Prog. BW	58
WR	107
YR	109
Udder	Good

Calv.Ease	BW	WW	YW	Milk	HPG	Stay	Maint.En.		
EPDs	20	-6.4	50	89	30	13	18	0.0	
Marb	+.50		REA +.08		Bfat +.04				
Beef Tenderness	→ DNA: 9 / Outstanding		Scan: 1.9 / Tender						
Wean Pct.	72%	Cow Eff.	152	HB	74	GM	54	ProS	128

★★★★★ for Low Maintenance, Growth, Gainability, Marbling, Superior Cow, High Cow Efficiency, Calving Ease.



Lot 69

**71 BECKTON ORACLE J146 C2**  
1-A 100% # 4505479 Tat: BKT1 J146



Birth: 3-7-21

Schuler Sudden Impact 0004X < Red Crowfoot Ole's Oscar  
SOR Duchess TS 8915U

**SCHULER ORACLE-7142E**  
Ref. O-1 Sor Marlee Cmmtmnt 0470X < Brown Commitment S7206  
SOR Marlee Beef 4511P

Beckton Clifftop Y012 C4 < Beckton Clifftop W692 E3  
Beckton Lana W240 C

**BECKTON ROSE C206 C**  
Beckton Rose W402 N < Beckton Nebula L P093  
Beckton Rose L311 LN

BWt	55
WR	103
YWt.	941
YR	102
Feb.ADG	3.47
Feb.Scr.	35
Frame	5.0
Feet	Good

DAM	
Age	6
Wt	NA
Prog. BW	60
WR	106
YR	108
Udder	Very Good

Calv.Ease	BW	WW	YW	Milk	HPG	Stay	Maint.En.		
EPDs	16	-2.9	64	104	28	10	18	1.0	
Marb	+.71		REA +.19		Bfat +.03				
Beef Tenderness	→ DNA: 9 / Outstanding		Scan: 2.8 / Tender						
Wean Pct.	NA%	Cow Eff.	NA	HB	71	GM	66	ProS	137

★★★★★ for Marbling, Rib-eye area, Superior Cow, Calving Ease.

**72 BECKTON ORACLE J075 C3**  
1-A 100% # 4506243 Tat: BKT1 J075



Birth: 2-25-21

Schuler Oracle-7142E < Schuler Sudden Impact 0004X  
Sor Marlee Cmmtmnt 0470X

**BECKTON ORACLE G222 J2**  
Ref. O-3 Beckton Rose E470 J < Beckton Julian GG B571  
Beckton Rose W346 E

Beckton Clifftop C572 N5 < Beckton Clifftop Y012 C4  
BKT Pine Marie U454 NB

**BECKTON KIT G378 C**  
Beckton Kit C839 A < Beckton Accent W180 C2  
Beckton Kit Z181 D

BWt	55
WR	108
YWt.	969
YR	101
Feb.ADG	3.13
Feb.Scr.	32
Frame	5.5
Feet	Good

DAM	
Age	2
Wt	790
Prog. BW	55
WR	108
YR	101
Udder	Very Good

Calv.Ease	BW	WW	YW	Milk	HPG	Stay	Maint.En.		
EPDs	20	-6.3	53	87	29	11	17	0.0	
Marb	+.55		REA +.04		Bfat +.04				
Beef Tenderness	→ DNA: 7 / Very Good		Scan: 2.4 / Tender						
Wean Pct.	62%	Cow Eff.	131	HB	73	GM	47	ProS	119

★★★★★ for Low Maintenance, Marbling, High Cow Efficiency, Calving Ease.

**70 BECKTON ACCENT J423 E4**  
1-A 100% # 4507265 Tat: BSF1 J423



Birth: 3-22-21

Beckton Accent W180 C2 < Beckton Cody K1 P014  
Beckton Christy R046 CQ

**BECKTON ACCENT E172 L3**  
Ref. A-4 Beckton Indigo Y406 L < Beckton Likable U130 L2  
Beckton Indigo R745 WR

Beckton Emcee W526 J2 < Beckton Emcee S466  
Beckton Larkaba P645 JL

**BECKTON LARKABA Z603 E**  
Beckton Larkaba U274 JL < Beckton Julian G3 P608  
Beckton Larkaba N708 HR

BWt	69
WR	105
YWt.	985
YR	104
Feb.ADG	2.90
Feb.Scr.	37
Frame	5.0
Feet	Good

DAM	
Age	9
Wt	1264
Prog. BW	67
WR	103
YR	101
Udder	Very Good

Calv.Ease	BW	WW	YW	Milk	HPG	Stay	Maint.En.		
EPDs	15	-4.6	57	86	28	11	18	-4.0	
Marb	+.37		REA +.03		Bfat +.02				
Beef Tenderness	→ DNA: 10 / Outstanding		Scan: 1.9 / Tender						
Wean Pct.	43%	Cow Eff.	91	HB	65	GM	22	ProS	87

★★★★★ for Low Maintenance, Marbling, Calving Ease.

**73 BECKTON DOMINOR J519 S9**  
1-A 100% # 4505455 Tat: BKT1 J519



Birth: 3-28-21

Beckton Dominor A378 W7 < Beckton Dominor Y005 V6  
Beckton Lana Y541 W

**BECKTON DOMINOR D254 N8**  
Ref. D-1 Beckton Indigo W772 N < Beckton Nebula T398 V3  
Beckton Indigo T613 JT

Beckton Scamp A626 H3 < Beckton Scamp T A825  
Beckton Rose T770 HI

**BECKTON SUSAN C047 S**  
Beckton Susan A112 S < Beckton Scamp X494 E3  
Beckton Susan T199 CT

BWt	68
WR	110
YWt.	981
YR	103
Feb.ADG	3.69
Feb.Scr.	34
Frame	5.0
Feet	Good

DAM	
Age	6
Wt	930
Prog. BW	63
WR	106
YR	103
Udder	Very Good

Calv.Ease	BW	WW	YW	Milk	HPG	Stay	Maint.En.		
EPDs	20	-5.4	51	81	33	11	17	1.0	
Marb	+.39		REA +.03		Bfat +.04				
Beef Tenderness	→ DNA: 10 / Outstanding		Scan: 2.2 / Tender						
Wean Pct.	62%	Cow Eff.	130	HB	72	GM	26	ProS	98



★★★★★ for Gainability, Marbling, Superior Cow, High Cow Efficiency, Calving Ease.

• Bulls •







**76 BECKTON DOMINOR J400 L9**  
1-A 100% # 4506679 Tat: BSF1 J400 



Birth: 3-22-21

Beckton Dominor A378 W7  Beckton Dominor Y005 V6  
Beckton Lana Y541 W 

**BECKTON DOMINOR D254 N8**  
Ref. D-1

Beckton Nebula T398 V3  Beckton Indigo T613 JT  
Beckton Indigo W772 N 

Beckton Likable U130 L2  Beckton Likable S633  
Beckton Kit S478 LN 

**BECKTON MONA B719 L**  
Beckton Mona X022 L  Beckton Likable U130 L2  
Beckton Mona U584 CD 



DAM	
Age	7
Wt	1162
Prog. BW	61
WR	90
YR	95
Udder	Very Good

Calv.Ease	BW	WW	YW	Milk	HPG	Stay	Maint.En.
EPDs	19	-5.7	53	86	31	12	20
Marb	+0.39		REA +0.27		Bfat +0.04		
Beef Tenderness	→ DNA: 10 / Outstanding		Scan: 1.8 / Tender				
Wean Pct.	43%	Cow Eff.	91	HB	97	GM	41
ProS	138						



★★★★★ for Low Maintenance, Marbling, Rib-eye area, Calving Ease.



**74 BSF LIKABLE J247 N4**  
1-B 99% # 4506601 Tat: BSF1 J247 



Birth: 3-16-21

Beckton Likable U130 L2  Beckton Likable S633  
Beckton Kit S478 LN 

**BECKTON LIKABLE D432 N3**  
Ref. L-3

Beckton Nebula T054 H3  Beckton Firefly T003 JC  
Beckton Firefly W013 N 

Beckton Nebula Y002 C5  Beckton Nebula W778 J4  
BKT Pine Marie W102 C 

**BSF DOMINIQUE A092 N**  
BSF Dominique Y109 A  Beckton Accent W180 C2  
BSF Dominique W352 J 



DAM	
Age	8
Wt	996
Prog. BW	66
WR	95
YR	98
Udder	Very Good

Calv.Ease	BW	WW	YW	Milk	HPG	Stay	Maint.En.
EPDs	18	-4.2	59	94	21	11	21
Marb	+0.38		REA +0.08		Bfat +0.04		
Beef Tenderness	→ DNA: NA / NA		Scan: 2.5 / Tender				
Wean Pct.	50%	Cow Eff.	106	HB	94	GM	33
ProS	127						



★★★★★ for Low Maintenance, Gainability, Marbling, Calving Ease.



**77 BECKTON SCAMP J474 L6**  
1-A 100% # 4506871 Tat: BSF1 J474 



Birth: 3-25-21

Beckton Scamp B720 L4  Beckton Scamp X458 H3  
Beckton Larkaba Y448 L 

**BECKTON SCAMP E175 N5**  
Ref. S-1

Beckton Nebula T398 V3  Beckton Belga T551 EP  
Beckton Belga W103 N 

Beckton Likable Z057 L4  Beckton Likable X445 J3  
Beckton Minola X107 L 

**BECKTON ANGEL E537 L**  
Beckton Angel A489 C  Beckton Clifftop W692 E3  
Beckton Angel K360 CO 



DAM	
Age	4
Wt	1028
Prog. BW	61
WR	94
YR	108
Udder	Very Good

Calv.Ease	BW	WW	YW	Milk	HPG	Stay	Maint.En.
EPDs	17	-4.7	59	112	24	7	15
Marb	+0.38		REA +0.07		Bfat +0.03		
Beef Tenderness	→ DNA: 10 / Outstanding		Scan: 1.4 / Tender +				
Wean Pct.	51%	Cow Eff.	107	HB	39	GM	61
ProS	100						



★★★★★ for Growth, Gainability, Marbling, Calving Ease.



**75 BSF LIKABLE J298 A7**  
1-B 99% # 4506867 Tat: BSF1 J298 



Birth: 3-18-21

Beckton Likable B032 C5  Beckton Likable Z057 L4  
Beckton Mona Z270 C 

**BECKTON LIKABLE F287 J6**  
Ref. L-6

Beckton Julian U699 L5  Beckton Larkaba U475 CT  
Beckton Larkaba X064 J 

Beckton Accent A175 O3  Beckton Lana R214 RA  
Beckton Loki CL S284 

**BSF HUSTELLE E515 A**  
BSF Hustelle U113 LO  BSF Hustelle S375 HU 



DAM	
Age	4
Wt	1194
Prog. BW	65
WR	94
YR	103
Udder	Poor

Calv.Ease	BW	WW	YW	Milk	HPG	Stay	Maint.En.
EPDs	18	-4.9	58	103	22	12	17
Marb	+0.47		REA -0.03		Bfat +0.05		
Beef Tenderness	→ DNA: 9 / Outstanding		Scan: 2.4 / Tender				
Wean Pct.	40%	Cow Eff.	84	HB	58	GM	52
ProS	110						



★★★★★ for Growth, Gainability, Marbling, Calving Ease.



**78 BSF LIKABLE J280 E6**  
1-B 99% # 4507103 Tat: BSF1 J280 



Birth: 3-17-21

Beckton Likable E391 N4  Beckton Likable Y124 L3  
Beckton Lana X466 N 

**BECKTON LIKABLE G026 L5**  
Ref. L-7

Beckton Likable C584 E4  Beckton Angel C816 L  
Beckton Angel E130 L 

Beckton Epic Z674 E6  Beckton Indigo U504 EP  
Beckton U749 D5 

**BSF HUSTELLE G487 E**  
BSF Hustelle D768 W  Beckton Warrior Y108 E5  
BSF Hustelle A370 L 

DAM	
Age	2
Wt	806
Prog. BW	54
WR	110
YR	107
Udder	Good

Calv.Ease	BW	WW	YW	Milk	HPG	Stay	Maint.En.
EPDs	16	-4.1	61	100	28	9	13
Marb	+0.44		REA -0.06		Bfat +0.04		
Beef Tenderness	→ DNA: 10 / Outstanding		Scan: 2.6 / Tender -				
Wean Pct.	62%	Cow Eff.	131	HB	31	GM	37
ProS	68						

★★★★★ for Growth, Gainability, Marbling, Superior Cow, High Cow Efficiency, Calving Ease.

• Bulls •

**79 BECKTON ACCENT J178 C5** 1-A 100% # 4505953 Tat: BKT1 J178 

Birth: 3-11-21

Beckton Accent Y260 L3  
**BECKTON ACCENT D326 N4** Ref. A-3  
 Beckton Lydia S069 NB

Beckton Accent W180 C2  
 Beckton Lana W463 L  
 Beckton Nebula P P707  
 Beckton Lydia P583 WR

TR Double Eagle ZT220  
**BECKTON PINE MARIE F390 D**  
 Beckton Pine Marie A446 L

TR Ricardo DOS  
 Beckton Lana U182 JC  
 Beckton Likable U120 L2  
 BKT Pine Marie U481 NM

BWt	61
WR	107
YWt.	918
YR	100
Feb.ADG	3.30
Feb.Scr.	34
Frame	5.5
Feet	Good

DAM											
Age	3	Calv.Ease	BW	WW	YW	Milk	HPG	Stay	Maint.En.		
Wt	914	EPDs	16	-4.0	58	91	29	10	19	-1.0	
Prog. BW	57	Marb	+.39		REA	+.07		Bfat	+.02		
WR	106	Beef Tenderness→ DNA:	10 / Outstanding		Scan:	1.9 / Tender					
YR	102	Wean Pct.	52%	Cow Eff.	110	HB	72	GM	23	ProS	95
Udder	Very Good										

★★★★★ for Low Maintenance, Marbling, Calving Ease.

**81 BECKTON LIKABLE J469 A5** 1-A 100% # 4505855 Tat: BKT1 J469 

Birth: 3-25-21

Beckton Likable Y124 L3  
**BECKTON LIKABLE E391 N4** Ref. L-4  
 Beckton Lana X466 N

Beckton Likable U130 L2  
 BKT Pine Marie S802 LO  
 Beckton Nebula T398 V3  
 Beckton Lana T226 NB

Beckton Accent D174 N3  
**BECKTON COCA F035 A**  
 Beckton Coca D139 A

Beckton Accent U777 C2  
 BKT Larkeisa S055 NB  
 Beckton Accent U777 C2  
 Beckton Coca Z529 A

BWt	64
WR	106
YWt.	1046
YR	114
Feb.ADG	4.32
Feb.Scr.	34
Frame	5.0
Feet	Good

DAM											
Age	3	Calv.Ease	BW	WW	YW	Milk	HPG	Stay	Maint.En.		
Wt	916	EPDs	14	-3.5	67	107	29	12	23	3.0	
Prog. BW	61	Marb	+.45		REA	-.06		Bfat	+.05		
WR	111	Beef Tenderness→ DNA:	7 / Very Good		Scan:	2.4 / Tender					
YR	110	Wean Pct.	52%	Cow Eff.	109	HB	96	GM	40	ProS	136
Udder	Very Good										

★★★★★ for Growth, Gainability, Marbling, Superior Cow, Calving Ease.

**80 BECKTON SCAMP J239 L7** 1-A 100% # 4506335 Tat: BKT1 J239 

Birth: 3-15-21

Beckton Scamp E175 N5  
**BECKTON SCAMP G006 C6** Ref. S-2  
 Beckton Firefly E769 C

Beckton Scamp B720 L4  
 Beckton Belga W103 N  
 Beckton Cardinal B074 N  
 Beckton Firefly B052 W

Redhill 9B Lancer 11E  
**BECKTON FIREFLY G730 L**  
 Beckton Firefly E679 E

Redhill U199 Lancer 9B  
 Redhill T189 Barmaid 190W  
 Beckton Emperor A165 W4  
 Beckton Firefly B511 A

BWt	56
WR	101
YWt.	1119
YR	116
Feb.ADG	4.55
Feb.Scr.	34
Frame	5.5
Feet	Good

DAM											
Age	2	Calv.Ease	BW	WW	YW	Milk	HPG	Stay	Maint.En.		
Wt	722	EPDs	17	-4.6	62	106	28	11	16	10.0	
Prog. BW	56	Marb	+.41		REA	+.03		Bfat	+.03		
WR	101	Beef Tenderness→ DNA:	NA / NA		Scan:	2.3 / Tender					
YR	116	Wean Pct.	63%	Cow Eff.	132	HB	50	GM	40	ProS	90
Udder	Good										

★★★★★ for Growth, Gainability, Marbling, High Cow Efficiency, Calving Ease.

**82 BSF RANGER J191 C7** 1-B 99% # 4507149 Tat: BSF1 J191 

Birth: 3-12-21

Beckton Ranger B006 D5  
**BECKTON RANGER G299 N6** Ref. R-1  
 Beckton Indigo C018 N

Beckton Ranger Z225 J4  
 Beckton Suffeina Z731 D  
 Beckton Nebula A773 L4  
 Beckton Indigo A849 N

Beckton Cardinal B074 N  
**BSF JULIA G725 C**  
 BSF Julia T623 JO

TR Double Eagle ZT220  
 BKT Pine Marie Z250 N  
 Beckton Julio L233  
 BSF Regus M006 NP

BWt	57
WR	94
YWt.	1043
YR	108
Feb.ADG	4.15
Feb.Scr.	36
Frame	5.5
Feet	Good

DAM											
Age	2	Calv.Ease	BW	WW	YW	Milk	HPG	Stay	Maint.En.		
Wt	894	EPDs	16	-3.5	57	106	26	12	18	0.0	
Prog. BW	57	Marb	+.39		REA	+.09		Bfat	+.04		
WR	94	Beef Tenderness→ DNA:	10 / Outstanding		Scan:	1.6 / Tender +					
YR	108	Wean Pct.	47%	Cow Eff.	99	HB	70	GM	55	ProS	125
Udder	Good										

★★★★★ for Low Maintenance, Growth, Gainability, Marbling, Calving Ease.



Lot 80

**83 BECKTON HUSTLER J375 L2** 1-A 100% # 4505831 Tat: BKT1 J375 

Birth: 3-21-21

Beckton Hustler CN J102  
**BECKTON HALFMANNHUSTLER R588** Ref. H-1  
 Beckton Vernice F513 CL

Beckton Hustler C G407  
 Beckton Belga G355 NP  
 Beckton Clipper JM A124  
 Beckton Vernice A663 PC

Beckton Legend Z689 J3  
**BECKTON LARKABA E803 L**  
 Beckton Larkaba B651 E

Beckton Legend X561 J2  
 Beckton Larkaba W868 J  
 Beckton Emcee W526 J2  
 Beckton Larkaba W050 E

BWt	64
WR	89
YWt.	1069
YR	113
Feb.ADG	4.21
Feb.Scr.	35
Frame	5.0
Feet	Good

DAM											
Age	4	Calv.Ease	BW	WW	YW	Milk	HPG	Stay	Maint.En.		
Wt	1086	EPDs	16	-4.6	56	103	23	10	17	4.0	
Prog. BW	64	Marb	+.39		REA	-.07		Bfat	+.03		
WR	99	Beef Tenderness→ DNA:	10 / Outstanding		Scan:	2.1 / Tender					
YR	109	Wean Pct.	41%	Cow Eff.	86	HB	57	GM	51	ProS	109
Udder	Very Good										

★★★★★ for Growth, Gainability, Marbling, Calving Ease.

• Bulls •

**84 BECKTON LIKABLE J796 C4** 1-A 100% # 4506495 Tat: BKT1 J796 

Birth: 4-21-21  
 Beckton Likable U130 L2 < Beckton Likable S633  
 Beckton Kit S478 LN  
**BECKTON LIKABLE C229 R3**  
 Ref. L-2 Beckton Tamara X447 J < Beckton Roman J S158  
 Beckton Tamara R834 JC  
 Beckton Clifftop W577 E3 < BKT Clifftop TP R288  
 BKT Pine Marie R213 EP  
**BECKTON EMERA Z775 C**  
 Beckton Emera P378 LN < Beckton Lancer T4 J536  
 Beckton Emera L405 WR

DAM		Calv.Ease	BW	WW	YW	Milk	HPG	Stay	Maint.En.		
Age	9	EPDs	12	-0.3	63	105	23	11	19	0.0	
Wt	1180	Marb	+0.34		REA +0.10		Bfat +0.03				
Prog. BW	71	Beef Tenderness→	DNA: 7 / Very Good		Scan: 2.0 / Tender						
WR	97	Wean Pct.	46%	Cow Eff.	97	HB	73	GM	32	ProS	104
YR	100	Udder	Good								

★★★★★ for Low Maintenance, Growth, Gainability, Marbling, Calving Ease.

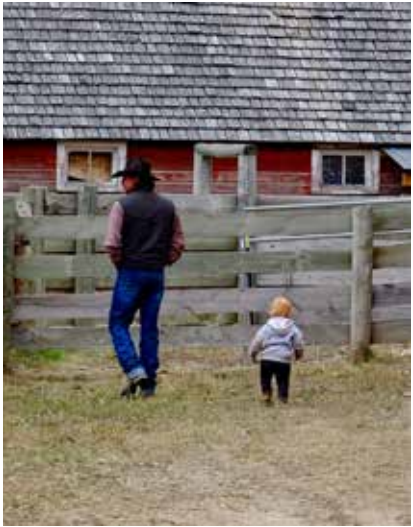

**85 BECKTON RANGER J690 N7** 1-A 100% # 4505787 Tat: BKT1 J690 

Birth: 4-9-21  
 Beckton Ranger B006 D5 < Beckton Ranger Z225 J4  
 Beckton Suffeina Z731 D  
**BECKTON RANGER G299 N6**  
 Ref. R-1 Beckton Nebula A773 L4  
 Beckton Indigo C018 N < Beckton Indigo A849 N  
 Beckton Nebula A773 L4 < Beckton Nebula T398 V3  
 Beckton Mona X022 L  
**BECKTON MONA E546 N**  
 Beckton Mona A918 L < Beckton Likable U120 L2  
 Beckton Mona W093 N

DAM		Calv.Ease	BW	WW	YW	Milk	HPG	Stay	Maint.En.		
Age	4	EPDs	19	-6.3	53	93	29	9	21	-5.0	
Wt	950	Marb	+0.42		REA +0.04		Bfat +0.04				
Prog. BW	58	Beef Tenderness→	DNA: 5 / Average		Scan: 2.5 / Tender						
WR	108	Wean Pct.	51%	Cow Eff.	106	HB	97	GM	56	ProS	153
YR	110	Udder	Very Good								

★★★★★ for Low Maintenance, Growth, Gainability, Marbling, Superior Cow, Calving Ease.

**87 BECKTON ACCENT J578 W6** 1-A 100% # 4507207 Tat: BSF1 J578 

Birth: 4-1-21  
 Beckton Accent B150 N4 < Beckton Accent Y260 L3  
 BKT Larkeisa S055 NB  
**BECKTON ACCENT F177 L5**  
 Ref. A-5 Beckton Vernice C782 L < Beckton Likable Y124 L3  
 Beckton Vernice X754 L  
 Beckton Warrior T248 L5 < Beckton Warrior N645 T1  
 Beckton Kit R503 LN  
**BECKTON ENCINO X642 W**  
 Beckton Encino S090 JT < Beckton Jet L P491  
 Beckton Encino P300 LN

DAM		Calv.Ease	BW	WW	YW	Milk	HPG	Stay	Maint.En.		
Age	11	EPDs	18	-5.9	48	76	25	14	19	-5.0	
Wt	1054	Marb	+0.52		REA -0.05		Bfat +0.04				
Prog. BW	62	Beef Tenderness→	DNA: 9 / Outstanding		Scan: 2.4 / Tender						
WR	98	Wean Pct.	45%	Cow Eff.	95	HB	86	GM	41	ProS	127
YR	97	Udder	Poor								

★★★★★ for Low Maintenance, Gainability, Marbling, Calving Ease.

**86 BSF ACCENT J204 A4** 1-B 99% # 4506933 Tat: BSF1 J204 

Birth: 3-13-21  
 Beckton Accent B553 L2 < Beckton Accent U777 C2  
 Beckton Lana X839 L  
**BECKTON ACCENT G208 N3**  
 Ref. A-7 Beckton Sierra A836 N < Beckton New Era Y194  
 Beckton Sierra S847 WR  
 Beckton Accent W180 C2 < Beckton Cody K1 P014  
 Beckton Christy R046 CQ  
**BSF LANETTE F229 A**  
 BSF Lanette U463 CQ < Beckton Cherokee N N479  
 BSF Lanette R748 LN

DAM		Calv.Ease	BW	WW	YW	Milk	HPG	Stay	Maint.En.		
Age	3	EPDs	9	2.1	75	117	24	12	19	5.0	
Wt	930	Marb	+0.35		REA +0.22		Bfat +0.03				
Prog. BW	72	Beef Tenderness→	DNA: 10 / Outstanding		Scan: 3.3 / Tender						
WR	114	Wean Pct.	55%	Cow Eff.	116	HB	59	GM	26	ProS	85
YR	108	Udder	Good								

★★★★★ for Growth, Marbling, Rib-eye area, Superior Cow, High Cow Efficiency.

**88 BECKTON ORACLE J385 O3** 1-A 100% # 4507091 Tat: BSF1 J385 

Birth: 3-21-21  
 Schuler Oracle-7142E < Schuler Sudden Impact 0004X  
 Sor Marlee Cmmmtmnt 0470X  
**BECKTON ORACLE G222 J2**  
 Ref. O-3 Beckton Rose E470 J < Beckton Julian GG B571  
 Beckton Rose W346 E  
 Schuler Oracle-7142E < Schuler Sudden Impact 0004X  
 Sor Marlee Cmmmtmnt 0470X  
**BECKTON ENCINO G382 O**  
 Beckton Encino D840 W < Beckton Warrior Y108 E5  
 Beckton Encino U680 CD

DAM		Calv.Ease	BW	WW	YW	Milk	HPG	Stay	Maint.En.		
Age	2	EPDs	20	-5.6	56	99	26	12	15	4.0	
Wt	688	Marb	+0.62		REA +0.16		Bfat +0.03				
Prog. BW	59	Beef Tenderness→	DNA: 10 / Outstanding		Scan: 2.1 / Tender						
WR	95	Wean Pct.	62%	Cow Eff.	131	HB	57	GM	71	ProS	128
YR	106	Udder	Good								

★★★★★ for Growth, Gainability, Marbling, Rib-eye area, High Cow Efficiency, Calving Ease.

• Bulls •



**91 BECKTON ORACLE J218 N2**  
1-A 100% # 4505983 Tat: BKT1 J218

Birth: 3-14-21

SCHULER ORACLE-7142E  
Ref. O-1

BECKTON LANA F475 N

**DAM**

Age	3	Calv.Ease	BW	WW	YW	Milk	HPG	Stay	Maint.En.		
Wt	874	EPDs	18	-5.4	54	94	26	8	19	2.0	
Prog. BW	59	Marb	+.63		REA	+.18		Bfat +.02			
WR	104	Beef Tenderness	→ DNA: 7 / Very Good		Scan: 2.1 / Tender						
YR	106	Wean Pct.	54%	Cow Eff.	113	HB	79	GM	65	ProS	143
Udder	Very Good										

★★★★★ for Growth, Gainability, Marbling, Rib-eye area, Superior Cow, Calving Ease.

**89 BECKTON ROOSEVELT J716 A3**  
1-A 100% # 4506849 Tat: BKT1 J716

Birth: 4-13-21

BECKTON ROOSEVELT D305 C2  
Ref. B-2

BECKTON LANA E218 A

**DAM**

Age	4	Calv.Ease	BW	WW	YW	Milk	HPG	Stay	Maint.En.		
Wt	1078	EPDs	16	-3.8	54	86	27	9	19	-1.0	
Prog. BW	61	Marb	+.32		REA	-.14		Bfat +.05			
WR	98	Beef Tenderness	→ DNA: 7 / Very Good		Scan: 2.9 / Tender						
YR	102	Wean Pct.	48%	Cow Eff.	100	HB	81	GM	14	ProS	95
Udder	Very Good										

★★★★★ for Low Maintenance, Growth, Marbling, Calving Ease.

**92 BSF SCAMP J098 A7**  
1-B 99% # 4507145 Tat: BSF1 J098

Birth: 3-1-21

BECKTON SCAMP G236 L6  
Ref. S-3

BSF WENDIE G680 A

**DAM**

Age	2	Calv.Ease	BW	WW	YW	Milk	HPG	Stay	Maint.En.		
Wt	696	EPDs	21	-7.2	59	94	30	11	16	0.0	
Prog. BW	40	Marb	+.35		REA	+.17		Bfat +.03			
WR	103	Beef Tenderness	→ DNA: 9 / Outstanding		Scan: 2.0 / Tender						
YR	105	Wean Pct.	67%	Cow Eff.	142	HB	63	GM	26	ProS	89
Udder	Very Good										

★★★★★ for Low Maintenance, Growth, Gainability, Marbling, Rib-eye area, Superior Cow, High Cow Efficiency, Calving Ease.

**90 BECKTON ORACLE J180 N2**  
1-A 100% # 4505975 Tat: BKT1 J180

Birth: 3-11-21

SCHULER ORACLE-7142E  
Ref. O-1

BECKTON LYDIA F439 N

**DAM**

Age	3	Calv.Ease	BW	WW	YW	Milk	HPG	Stay	Maint.En.		
Wt	814	EPDs	17	-4.2	57	103	25	9	15	4.0	
Prog. BW	57	Marb	+.67		REA	+.14		Bfat +.03			
WR	105	Beef Tenderness	→ DNA: 7 / Very Good		Scan: 2.0 / Tender						
YR	106	Wean Pct.	55%	Cow Eff.	115	HB	53	GM	73	ProS	126
Udder	Fair										

★★★★★ for Growth, Gainability, Marbling, Rib-eye area, Superior Cow, Calving Ease.

**93 BECKTON ACCENT J059 L4**  
1-A 100% # 4507123 Tat: BSF1 J059

Birth: 2-21-21

BECKTON ACCENT G260 N3  
Ref. A-8

BECKTON LANA G572 L

**DAM**

Age	2	Calv.Ease	BW	WW	YW	Milk	HPG	Stay	Maint.En.		
Wt	916	EPDs	18	-5.4	56	99	24	12	16	5.0	
Prog. BW	49	Marb	+.47		REA	+.06		Bfat +.03			
WR	99	Beef Tenderness	→ DNA: 10 / Outstanding		Scan: 1.6 / Tender						
YR	106	Wean Pct.	49%	Cow Eff.	102	HB	47	GM	48	ProS	96
Udder	Very Good										

★★★★★ for Growth, Marbling, Calving Ease.

• Bulls •

**94 BECKTON SCAMP J482 N6**  
1-A 100% # 4507209 Tat: BSF1 J482



Birth: 3-25-21

Beckton Scamp B720 L4  
Beckton Larkaba Y448 L

**BECKTON SCAMP E175 N5**  
Ref. S-1

Beckton Nebula T398 V3  
Beckton Belga T551 EP

**BECKTON BARMAID X654 N**  
Beckton Nebula T398 V3  
Beckton Barmaid S758 DM

Beckton Nebula L P093  
Beckton Minerva J615 VG  
Beckton Dominor ZC M919  
Beckton Barmaid K080 CH

BWt	78
WR	103
YWt.	973
YR	103
Feb.ADG	3.47
Feb.Scr.	34
Frame	5.0
Feet	Good

DAM											
Age	11	Calv.Ease	BW	WW	YW	Milk	HPG	Stay	Maint.En.		
Wt	1092	EPDs	16	-4.0	52	93	28	8	21	6.0	
Prog. BW	68	Marb	+.37		REA	+.01		Bfat	+.03		
WR	99	Beef Tenderness→ DNA:	10 / Outstanding		Scan:	2.1 / Tender					
YR	102	Wean Pct.	47%	Cow Eff.	99	HB	67	GM	49	ProS	116
Udder	Good										

★★★★★ for Marbling, Calving Ease.

**96 BECKTON HUSTLER J230 E2**  
1-A 100% # 4506817 Tat: BSF1 J230



Birth: 3-15-21

Beckton Hustler CN J102  
Beckton Belga G355 NP

**BECKTON HALFMANNHUSTLER R588**  
Ref. H-1

Beckton Vernice F513 CL  
Beckton Clipper JM A124  
Beckton Vernice A663 PC

**BECKTON LANA D890 E**  
Beckton Epic Y484 N6  
Beckton Lana W113 N

Beckton Epic U749 D5  
Beckton Lydia S069 NB  
Beckton Nebula T252 L3  
Beckton Lana T226 NB

BWt	61
WR	92
YWt.	993
YR	105
Feb.ADG	3.81
Feb.Scr.	30
Frame	5.0
Feet	Good

DAM											
Age	5	Calv.Ease	BW	WW	YW	Milk	HPG	Stay	Maint.En.		
Wt	982	EPDs	17	-5.8	53	100	18	10	18	5.0	
Prog. BW	62	Marb	+.37		REA	-.12		Bfat	+.03		
WR	91	Beef Tenderness→ DNA:	7 / Very Good		Scan:	1.5 / Tender +					
YR	97	Wean Pct.	48%	Cow Eff.	102	HB	62	GM	47	ProS	109
Udder	NA										

★★★★★ for Gainability, Marbling, Calving Ease.



Lot 94

**97 BECKTON NEBULA J333 L5**  
1-A 100% # 4505553 Tat: BKT1 J333



Birth: 3-19-21

Beckton Nebula B557 J3  
Beckton Larkaba T813 JC

**BECKTON NEBULA F440 H4**  
Ref. N-4

Beckton Minola X638 H  
Beckton Minola N751 JL

**BECKTON COCA D036 L**  
Beckton Likable B509 J3  
Beckton Coca B118 C

Beckton Likable U130 L2  
Beckton Coca T363 JL  
Beckton Clifftop Z824 C4  
Beckton Coca Z545 H

BWt	69
WR	99
YWt.	1015
YR	103
Feb.ADG	3.41
Feb.Scr.	34
Frame	5.0
Feet	Good

DAM											
Age	5	Calv.Ease	BW	WW	YW	Milk	HPG	Stay	Maint.En.		
Wt	990	EPDs	15	-3.8	52	86	26	11	16	-1.0	
Prog. BW	67	Marb	+.40		REA	-.04		Bfat	+.03		
WR	101	Beef Tenderness→ DNA:	6 / Average		Scan:	2.9 / Tender -					
YR	104	Wean Pct.	48%	Cow Eff.	100	HB	52	GM	37	ProS	89
Udder	Very Good										

★★★★★ for Low Maintenance, Marbling, Calving Ease.

**95 BECKTON LIKABLE J675 E7**  
1-A 100% # 4506487 Tat: BKT1 J675



Birth: 4-7-21

Beckton Likable B032 C5  
Beckton Likable Z057 L4  
Beckton Mona Z270 C

**BECKTON LIKABLE F287 J6**  
Ref. L-6

Beckton Larkaba X064 J  
Beckton Julian U699 L5  
Beckton Larkaba U475 CT

**BECKTON LARKEISA Z556 E**  
Beckton Epic X330 L6  
Beckton Kit R503 LN

Beckton Legend U331 E2  
BKT Larkeisa U066 LO

BWt	64
WR	107
YWt.	1051
YR	111
Feb.ADG	3.86
Feb.Scr.	37
Frame	5.5
Feet	Good

DAM											
Age	9	Calv.Ease	BW	WW	YW	Milk	HPG	Stay	Maint.En.		
Wt	1044	EPDs	18	-5.9	57	101	24	12	14	2.0	
Prog. BW	64	Marb	+.51		REA	+.01		Bfat	+.05		
WR	105	Beef Tenderness→ DNA:	10 / Outstanding		Scan:	1.8 / Tender					
YR	109	Wean Pct.	53%	Cow Eff.	112	HB	43	GM	51	ProS	94
Udder	Fair										

★★★★★ for Growth, Gainability, Marbling, Superior Cow, Calving Ease.





• Bulls •

**98 BECKTON LIKABLE J082 A5** 1-A 100% # 4506111 Tat: BKT1 J082 

Birth: 2-26-21

Beckton Likable C229 R3 < Beckton Likable U130 L2  
Beckton Tamara X447 J

**BECKTON LIKABLE G403 N4** Ref. L-9 < Beckton Nebula T398 V3  
Beckton Minerva Y385 N < Beckton Minerva U310 LO

Beckton Accent E492 N4 < Beckton Accent B740 W3  
BKT Pine Marie Z177 N

**BECKTON MONA G098 A** < Beckton Nebula A773 L4  
Beckton Mona E546 N < Beckton Mona A918 L

BWt	54
WR	101
YWt.	973
YR	101
Feb.ADG	3.58
Feb.Scr.	37
Frame	5.0
Feet	Good

DAM	
Age	2
Wt	955
Prog. BW	54
WR	101
YR	101
Udder	NA

Calv.Ease	BW	WW	YW	Milk	HPG	Stay	Maint.En.		
EPDs	19	-5.6	58	92	30	9	22	-1.0	
Marb	+.37		REA +.18		Bfat +.04				
Beef Tenderness	→ DNA: 7 / Very Good		Scan: 1.7 / Tender						
Wean Pct.	48%	Cow Eff.	101	HB	93	GM	35	ProS	127

★★★★★ for Low Maintenance, Gainability, Marbling, Rib-eye area, Calving Ease.

**100 BSF DOMINOR J308 J10** 1-B 99% # 4506639 Tat: BSF1 J308 

Birth: 3-18-21

Beckton Dominor D254 N8 < Beckton Dominor A378 W7  
Beckton Indigo W772 N

**BECKTON DOMINOR G402 A9** Ref. D-3 < Beckton Accent B549 N3  
Beckton Lana D273 A < Beckton Lana B666 S

Beckton Julian Z382 J7 < Beckton Julian X721 E6  
Beckton Larkaba X064 J

**BSF LAUREL B171 J** < Beckton Clifftop W692 E3  
BSF Laurel Z303 C < BSF Laurel U629 WR

BWt	66
WR	101
YWt.	939
YR	99
Feb.ADG	3.07
Feb.Scr.	37
Frame	5.0
Feet	Good

DAM	
Age	7
Wt	1148
Prog. BW	67
WR	106
YR	103
Udder	Good

Calv.Ease	BW	WW	YW	Milk	HPG	Stay	Maint.En.		
EPDs	19	-6.1	54	86	28	12	18	4.0	
Marb	+.37		REA +.00		Bfat +.04				
Beef Tenderness	→ DNA: 10 / Outstanding		Scan: 2.5 / Tender						
Wean Pct.	46%	Cow Eff.	96	HB	69	GM	23	ProS	93

★★★★★ for Marbling, Superior Cow, Calving Ease.



Lot 98

**101 BECKTON HERITAGE J394 J5** 1-A 100% # 4506771 Tat: BSF1 J394 

Birth: 3-21-21

Beckton Heritage X403 L3 < Beckton Heritage T270 J2  
Beckton Indigo H150 LN

**BECKTON HERITAGE C477 J4** Ref. H-2 < Beckton Julian U699 L5  
Beckton Ruth Z858 J < Beckton Ruth U557 JT

Beckton Julian Z382 J7 < Beckton Julian X721 E6  
Beckton Larkaba X064 J

**BECKTON BELGA D455 J** < Beckton Epic K1 K863  
Beckton Belga M050 EP < Beckton Belga K588 HD

BWt	65
WR	94
YWt.	987
YR	104
Feb.ADG	3.52
Feb.Scr.	35
Frame	5.0
Feet	Good

DAM	
Age	5
Wt	912
Prog. BW	68
WR	104
YR	105
Udder	Very Good

Calv.Ease	BW	WW	YW	Milk	HPG	Stay	Maint.En.		
EPDs	18	-5.5	53	87	30	13	18	-5.0	
Marb	+.40		REA +.05		Bfat +.04				
Beef Tenderness	→ DNA: 10 / Outstanding		Scan: 2.3 / Tender						
Wean Pct.	54%	Cow Eff.	113	HB	86	GM	43	ProS	129

★★★★★ for Low Maintenance, Gainability, Marbling, Superior Cow, Calving Ease.

**99 BECKTON SCAMP J067 L7** 1-A 100% # 4506249 Tat: BKT1 J067 

Birth: 2-22-21

Beckton Scamp E175 N5 < Beckton Scamp B720 L4  
Beckton Belga W103 N

**BECKTON SCAMP G006 C6** Ref. S-2 < Beckton Cardinal B074 N  
Beckton Firefly E769 C < Beckton Firefly B052 W

Beckton Legend Z689 J3 < Beckton Legend X561 J2  
Beckton Larkaba W868 J

**BECKTON LANA G406 L** < Beckton Dominor Z1 R610  
Beckton Lana W748 D < Beckton Lana S858 JL

BWt	55
WR	101
YWt.	993
YR	103
Feb.ADG	3.86
Feb.Scr.	32
Frame	5.0
Feet	Good

DAM	
Age	2
Wt	838
Prog. BW	55
WR	101
YR	103
Udder	Very Good

Calv.Ease	BW	WW	YW	Milk	HPG	Stay	Maint.En.		
EPDs	18	-5.3	54	94	27	12	16	3.0	
Marb	+.40		REA +.02		Bfat +.03				
Beef Tenderness	→ DNA: 9 / Outstanding		Scan: 2.2 / Tender						
Wean Pct.	55%	Cow Eff.	115	HB	60	GM	39	ProS	99

★★★★★ for Gainability, Marbling, Calving Ease.



Lot 99

• Bulls •

**102 BSF CARDINAL J018 3** 

1-B 99% # 4506359 Tat: BKT1 J018

Birth: 2-14-21

BECKTON CARDINAL G043 C2  
Ref. C-3

Beckton Cardinal E673 L  
Beckton Minerva E181 D

TR Double Eagle ZT220  
Beckton Larkaba A911 L

TR Double Eagle ZT220  
Beckton Minerva W901 J

Red Angus multiple sire  
Red Angus dam

Beckton Nebula T398 V3  
BKT Pine Marie T593 HT

BWT 50  
WR 98  
YWt. 948  
YR 98  
Feb.ADG 3.75  
Feb.Scr. 34  
Frame 5.0  
Feet Good

DAM		Calv.Ease	BW	WW	YW	Milk	HPG	Stay	Maint.En.
Age	2	EPDs	18	-5.1	54	85	26	11	15 -8.0
Wt	596	Marb	+.40		REA	+.29		Bfat	+.02
Prog. BW	50	Beef Tenderness→ DNA: 9 / Outstanding		Scan: 1.9 / Tender					
WR	98	Wean Pct.	74%	Cow Eff.	156	HB	67	GM	47 ProS 113
YR	98								
Udder	NA								

★★★★★ for Low Maintenance, Gainability, Marbling, Rib-eye area, High Cow Efficiency, Calving Ease.

**105 BSF ACCENT J553 L6** 

1-B 99% # 4507281 Tat: BKB1 J553

Birth: 3-30-21

BECKTON ACCENT F177 L5  
Ref. A-5

Beckton Accent B150 N4  
Beckton Vernice C782 L

Beckton Accent Y260 L3  
BKT Larkeisa S055 NB

Beckton Likable Y124 L3  
Beckton Vernice X754 L

Beckton Loki X833 H4  
Beckton Vernice T447 HT

BSF Julia X752 L  
Beckton Laser N602  
BSF Julia T175 JO

BWT 65  
WR 106  
YWt. 1000  
YR 105  
Feb.ADG 3.64  
Feb.Scr. 36  
Frame 5.0  
Feet Good

DAM		Calv.Ease	BW	WW	YW	Milk	HPG	Stay	Maint.En.
Age	5	EPDs	17	-5.0	49	76	29	10	18 1.0
Wt	982	Marb	+.48		REA	-.05		Bfat	+.04
Prog. BW	70	Beef Tenderness→ DNA: 10 / Outstanding		Scan: 2.2 / Tender					
WR	104	Wean Pct.	56%	Cow Eff.	118	HB	64	GM	34 ProS 98
YR	113								
Udder	Good								

★★★★★ for Growth, Gainability, Marbling, Superior Cow, High Cow Efficiency, Calving Ease.

**103 BECKTON SCAMP J074 L7** 

1-A 100% # 4507053 Tat: BSF1 J074

Birth: 2-24-21

BECKTON SCAMP G236 L6  
Ref. S-3

Beckton Scamp D325 N5  
Beckton Indigo Y406 L

Beckton Scamp A627 J4  
Beckton Tamara Y039 N

Beckton Likable U130 L2  
Beckton Indigo R745 WR

Beckton Legend E032 E3  
Beckton Emera C066 E

BECKTON LANA G185 L  
Beckton Lana E827 N

Beckton Nebula Z111 N5  
Beckton Lana X767 C

BWT 63  
WR 102  
YWt. 948  
YR 98  
Feb.ADG 3.86  
Feb.Scr. 33  
Frame 5.0  
Feet Good

DAM		Calv.Ease	BW	WW	YW	Milk	HPG	Stay	Maint.En.
Age	2	EPDs	17	-4.4	60	91	27	12	17 -2.0
Wt	794	Marb	+.31		REA	+.07		Bfat	+.03
Prog. BW	63	Beef Tenderness→ DNA: 9 / Outstanding		Scan: 2.2 / Tender					
WR	102	Wean Pct.	58%	Cow Eff.	123	HB	66	GM	12 ProS 79
YR	98								
Udder	Good								

★★★★★ for Low Maintenance, Gainability, Marbling, High Cow Efficiency, Calving Ease.



**104 BSF HERITAGE J739 J5** 

1-B 99% # 4506649 Tat: BSF1 J739

Birth: 4-16-21

BECKTON HERITAGE C477 J4  
Ref. H-2

Beckton Heritage X403 L3  
Beckton Ruth Z858 J

Beckton Heritage T270 J2  
Beckton Indigo H150 LN

Beckton Julian U699 L5  
Beckton Ruth U557 JT

Beckton Julian X465 J5  
Beckton Suffeina P643 JL

BSF JUSTICIA B286  
BSF Justicia S777 JC

Beckton Justice CH M056  
BSF Regus L414 EP

BWT 83  
WR 119  
YWt. 1055  
YR 111  
Feb.ADG 2.84  
Feb.Scr. 37  
Frame 5.0  
Feet Good

DAM		Calv.Ease	BW	WW	YW	Milk	HPG	Stay	Maint.En.
Age	7	EPDs	12	-0.8	65	105	29	12	14 3.0
Wt	1010	Marb	+.44		REA	+.10		Bfat	+.04
Prog. BW	76	Beef Tenderness→ DNA: 7 / Very Good		Scan: 2.5 / Tender					
WR	112	Wean Pct.	61%	Cow Eff.	129	HB	35	GM	43 ProS 78
YR	108								
Udder	Very Good								

★★★★★ for Growth, Marbling, Superior Cow, High Cow Efficiency, Calving Ease.

**106 BECKTON HUGHES J206 A3** 

1-A 100% # 4505335 Tat: BKT1 J206

Birth: 3-13-21

BECKTON HUGHES C463 N2  
Ref. B-1

Bieber H Hughes W109  
Beckton Lakme T689 NX

Basin Hobo 0545  
Basin Rose 06T0

Beckton Nexus L016  
Beckton Lakme M669 EP

Beckton Accent W180 C2  
Beckton Belga W103 N

Beckton Cody K1 P014  
Beckton Christy R046 CQ

Beckton Nebula T398 V3  
Beckton Belga T551 EP

BWT 68  
WR 92  
YWt. 927  
YR 98  
Feb.ADG 3.41  
Feb.Scr. 33  
Frame 4.5  
Feet Good

DAM		Calv.Ease	BW	WW	YW	Milk	HPG	Stay	Maint.En.
Age	8	EPDs	18	-4.9	57	92	25	12	23 0.0
Wt	1148	Marb	+.32		REA	+.02		Bfat	+.04
Prog. BW	65	Beef Tenderness→ DNA: 7 / Very Good		Scan: 2.0 / Tender					
WR	96	Wean Pct.	41%	Cow Eff.	87	HB	106	GM	20 ProS 126
YR	107								
Udder	Fair								

★★★★★ for Low Maintenance, Marbling, Calving Ease.

• Bulls •

**107 BECKTON HERITAGE J793 H6** 1-A 100% # 4507205 Tat: BSF1 J793 

Birth: 4-21-21  
 Beckton Heritage B612 J4 < Beckton Heritage X403 L3  
 Beckton Lana N291 JC  
**BECKTON HERITAGE F615 L5**  
 Ref. H-3 < Beckton Likable U130 L2  
 Beckton Mona X022 L < Beckton Mona U584 CD  
 Beckton Hasten H S462 < Beckton Hasten P292  
**BECKTON MINOLA X638 H**  
 Beckton Minola N751 JL < Beckton Lakme G128 HD  
 Beckton Julian G1 J526  
 Beckton Minola J091 JL

DAM		Calv.Ease	BW	WW	YW	Milk	HPG	Stay	Maint.En.	
Age	11	EPDs	12	-3.2	64	94	24	10	17	-9.0
Wt	1138	Marb	+.33		REA	-.06		Bfat	+.03	
Prog. BW	71	Beef Tenderness→		DNA: 9 / Outstanding		Scan:		2.1 / Tender		
WR	101	Wean Pct.	49%		Cow Eff.	104		HB	63	
YR	104	GM	16		ProS	79				
Udder	Very Good									

★★★★★ for Low Maintenance, Growth, Marbling, Calving Ease.

**110 BECKTON NEBULA J551 C2** 1-A 100% # 4505733 Tat: BKT1 J551 

Birth: 3-30-21  
 Beckton Nebula E P084 < Beckton Nebula M045  
 BKT Pine Marie M119 EP  
**BECKTON NEBULA EN S347**  
 Ref. N-1 < Beckton Nebula M045  
 Beckton Eola P530 NB < Beckton Eola M663 EP  
 TR Double Eagle ZT220 < TR Ricardo DOS  
**BECKTON TAMARA E236 D**  
 Beckton Tamara A547 A < Beckton Lana U182 JC  
 Beckton Accent U777 C2  
 Beckton Tamara W204 E

DAM		Calv.Ease	BW	WW	YW	Milk	HPG	Stay	Maint.En.	
Age	4	EPDs	21	-7.1	49	74	37	13	20	-7.0
Wt	970	Marb	+.50		REA	-.12		Bfat	+.06	
Prog. BW	68	Beef Tenderness→		DNA: 7 / Very Good		Scan:		1.8 / Tender		
WR	106	Wean Pct.	55%		Cow Eff.	115		HB	94	
YR	104	GM	27		ProS	121				
Udder	Very Good									

★★★★★ for Low Maintenance, Marbling, Superior Cow, Calving Ease.

**108 BECKTON NEBULA J307 E2** 1-A 100% # 4506723 Tat: BSF1 J307 

Birth: 3-18-21  
 Beckton Nebula E P084 < Beckton Nebula M045  
 BKT Pine Marie M119 EP  
**BECKTON NEBULA EN S347**  
 Ref. N-1 < Beckton Nebula M045  
 Beckton Eola P530 NB < Beckton Eola M663 EP  
 Beckton Epic X464 L5 < Beckton Epic K6 S569  
**BECKTON MARTA C679 E**  
 Beckton Marta X010 N < Beckton Lana M393 LN  
 Beckton Nebula U031 D3  
 Beckton Marta U079 NB

DAM		Calv.Ease	BW	WW	YW	Milk	HPG	Stay	Maint.En.	
Age	6	EPDs	18	-5.9	49	73	36	12	18	-5.0
Wt	1006	Marb	+.47		REA	-.33		Bfat	+.05	
Prog. BW	73	Beef Tenderness→		DNA: 8 / Very Good		Scan:		1.7 / Tender		
WR	101	Wean Pct.	48%		Cow Eff.	102		HB	82	
YR	100	GM	28		ProS	110				
Udder	Fair									

★★★★★ for Low Maintenance, Marbling, Calving Ease.

**111 BECKTON SCAMP J531 L6** 1-A 100% # 4507263 Tat: BSF1 J531 

Birth: 3-28-21  
 Beckton Scamp B720 L4 < Beckton Scamp X458 H3  
 Beckton Larkaba Y448 L  
**BECKTON SCAMP E175 N5**  
 Ref. S-1 < Beckton Nebula T398 V3  
 Beckton Belga W103 N < Beckton Belga T551 EP  
 Beckton Legend X561 J2 < Beckton Legend S670  
**BECKTON ENCINO Z514 L**  
 Beckton Encino W287 N < Beckton Lana T279 JO  
 Beckton Nebula L P093  
 Beckton Encino S303 LO

DAM		Calv.Ease	BW	WW	YW	Milk	HPG	Stay	Maint.En.	
Age	9	EPDs	14	-1.8	58	97	28	10	19	12.0
Wt	1174	Marb	+.35		REA	+.03		Bfat	+.03	
Prog. BW	77	Beef Tenderness→		DNA: 9 / Outstanding		Scan:		2.5 / Tender		
WR	117	Wean Pct.	45%		Cow Eff.	94		HB	56	
YR	111	GM	33		ProS	89				
Udder	Poor									

★★★★★ for Marbling, Superior Cow, Calving Ease.

**109 BECKTON JULIAN J322 C2** 1-A 100% # 4505823 Tat: BKT1 J322 

Birth: 3-18-21  
 Beckton Julian 7526G < Beckton Julian 6592  
 Bkt Belga 6746 GS  
**BECKTON JULIAN GG B571**  
 Ref. J-1 < Beckton Julian 7526G  
 Bkt Marta 6498 XM  
 TR Ricardo DOS  
**BECKTON VERNICE E707 D**  
 TR Double Eagle ZT220 < Beckton Lana U182 JC  
 Beckton Vernice A176 A < Beckton Accent U777 C2  
 Beckton Vernice L382 LN

DAM		Calv.Ease	BW	WW	YW	Milk	HPG	Stay	Maint.En.	
Age	4	EPDs	21	-7.2	52	86	28	14	15	-4.0
Wt	992	Marb	+.43		REA	+.28		Bfat	+.02	
Prog. BW	48	Beef Tenderness→		DNA: 7 / Very Good		Scan:		2.9 / Tender		
WR	101	Wean Pct.	48%		Cow Eff.	101		HB	59	
YR	102	GM	47		ProS	106				
Udder	Good									

★★★★★ for Low Maintenance, Gainability, Marbling, Rib-eye area, Calving Ease.



• Bulls •

**112 BECKTON EPIC J827 N8** 1-A 100% # 4505535 Tat: BKT1 J827 

Birth: 4-26-21  
 Beckton Epic Z674 E6 < Beckton Epic U749 D5  
 Beckton Indigo U504 EP  
**BECKTON EPIC F279 A7** Ref. E-1 < Beckton Accent W180 C2  
 Beckton Firefly B511 A < Beckton Firefly X336 H  
 Beckton Nebula X096 N4 < Beckton Nebula U206 V3  
**BECKTON COCA C764 N** < Beckton Tamara U185 NB  
 Beckton Coca Y579 H < Beckton Hasten U108 J3  
 Beckton Coca T080 NB

DAM		Calv.Ease	BW	WW	YW	Milk	HPG	Stay	Maint.En.	
Age	6	EPDs	16	-3.9	62	101	28	10	18	0.0
Wt	1072	Marb	+.37		REA	-.08		Bfat	+.05	
Prog. BW	71	Beef Tenderness→ DNA: 9 / Outstanding Scan: 2.8 / Tender -								
WR	109	Wean Pct. 55% Cow Eff. 116 HB 65 GM 22 ProS 87								
YR	104									
Udder	Very Good									

★★★★★ for Low Maintenance, Growth, Marbling, Superior Cow, High Cow Efficiency, Calving Ease.

**115 BECKTON ORACLE J490 S2** 1-A 100% # 4505679 Tat: BKT1 J490 

Birth: 3-26-21  
 Schuler Sudden Impact 0004X < Red Crowfoot Ole's Oscar  
 SOR Duchess TS 8915U  
**SCHULER ORACLE-7142E** Ref. O-1 < Sor Marlee Cmmtmnt 0470X  
 SOR Marlee Beef 4511P  
 Beckton Scamp A627 J4 < Beckton Scamp X494 E3  
**BECKTON RUTH D728 S** < Beckton Serena R023 JC  
 Beckton Ruth A010 N < Beckton Nebula Y002 C5  
 Beckton Ruth Y047 N

DAM		Calv.Ease	BW	WW	YW	Milk	HPG	Stay	Maint.En.	
Age	5	EPDs	21	-6.8	48	87	24	11	17	-8.0
Wt	1018	Marb	+.60		REA	+.04		Bfat	+.02	
Prog. BW	60	Beef Tenderness→ DNA: 7 / Very Good Scan: 2.7 / Tender -								
WR	96	Wean Pct. 44% Cow Eff. 92 HB 79 GM 66 ProS 145								
YR	103									
Udder	NA									

★★★★★ for Low Maintenance, Gainability, Marbling, Calving Ease.

**113 BECKTON ACCENT J358 N5** 1-A 100% # 4507013 Tat: BSF1 J358 

Birth: 3-20-21  
 Beckton Accent Y260 L3 < Beckton Accent W180 C2  
 Beckton Lana W463 L  
**BECKTON ACCENT D326 N4** Ref. A-3 < Beckton Nebula P P707  
 Beckton Lydia S069 NB < Beckton Lydia P583 WR  
 Beckton Nebula X603 J4 < Beckton Nebula T398 V3  
**BECKTON ENCINO F751 N** < Beckton Firefly T003 JC  
 Beckton Encino A442 J < Beckton Julian W743 H5  
 Beckton Encino X075 C

DAM		Calv.Ease	BW	WW	YW	Milk	HPG	Stay	Maint.En.	
Age	3	EPDs	15	-3.2	63	107	28	12	18	-1.0
Wt	934	Marb	+.52		REA	+.01		Bfat	+.03	
Prog. BW	58	Beef Tenderness→ DNA: 9 / Outstanding Scan: 1.7 / Tender								
WR	109	Wean Pct. 50% Cow Eff. 106 HB 72 GM 41 ProS 113								
YR	116									
Udder	Good									

★★★★★ for Low Maintenance, Growth, Gainability, Marbling, Superior Cow, Calving Ease.

**116 BECKTON SCAMP J027 L6** 1-A 100% # 4506179 Tat: BKT1 J027 

Birth: 2-16-21  
 Beckton Likable E391 N4 < Beckton Likable Y124 L3  
 Beckton Lana X466 N  
**BECKTON LIKABLE G026 L5** Ref. L-7 < Beckton Likable C584 E4  
 Beckton Angel E130 L < Beckton Angel C816 L  
 Beckton Scamp D325 N5 < Beckton Scamp A627 J4  
**BECKTON LARKEISA G220 S** < Beckton Tamara Y039 N  
 Beckton Larkeisa D185 L < Beckton Legend S670  
 Beckton Larkeisa Z345 N

DAM		Calv.Ease	BW	WW	YW	Milk	HPG	Stay	Maint.En.	
Age	2	EPDs	18	-6.4	50	86	24	11	16	-3.0
Wt	736	Marb	+.40		REA	-.03		Bfat	+.03	
Prog. BW	54	Beef Tenderness→ DNA: 10 / Outstanding Scan: 2.3 / Tender								
WR	85	Wean Pct. 51% Cow Eff. 107 HB 63 GM 41 ProS 104								
YR	99									
Udder	Very Good									

★★★★★ for Low Maintenance, Gainability, Marbling, Calving Ease.

**114 BECKTON HERITAGE J486 C6** 1-A 100% # 4506917 Tat: BSF1 J486 

Birth: 3-26-21  
 Beckton Heritage B612 J4 < Beckton Heritage X403 L3  
 Beckton Lana N291 JC  
**BECKTON HERITAGE F615 L5** Ref. H-3 < Beckton Likable U130 L2  
 Beckton Mona X022 L < Beckton Mona U584 CD  
 Beckton Clifftop D059 C5 < Beckton Clifftop B848 J4  
**BECKTON LARKABEL F085 C** < Beckton Larkaba B565 C  
 Beckton Larkabel D267 S < Beckton Scamp A627 J4  
 Beckton Larkabel Y487 A

DAM		Calv.Ease	BW	WW	YW	Milk	HPG	Stay	Maint.En.	
Age	3	EPDs	12	-2.0	58	83	27	10	16	-7.0
Wt	804	Marb	+.38		REA	+.03		Bfat	+.03	
Prog. BW	63	Beef Tenderness→ DNA: 7 / Very Good Scan: 1.9 / Tender								
WR	99	Wean Pct. 60% Cow Eff. 125 HB 51 GM 15 ProS 82								
YR	102									
Udder	Very Good									

★★★★★ for Low Maintenance, Growth, Gainability, Marbling, High Cow Efficiency, Calving Ease.



Lot 116

• Bulls •

**117 BECKTON CARDINAL J196 J3**  
1-A 100% # 4505947 Tat: BKT1 J196



Birth: 3-12-21  
 Beckton Cardinal E673 L < TR Double Eagle ZT220  
 Beckton Larkaba A911 L  
**BECKTON CARDINAL G043 C2**  
 Ref. C-3 Beckton Minerva E181 D < TR Double Eagle ZT220  
 Beckton Minerva W901 J  
 Beckton Julian D551 C6 < Beckton Julian X465 J5  
 Beckton Tamara W550 A  
**BECKTON SUFFEINA F366 J**  
 Beckton Suffeina D277 A < Beckton Accent U777 C2  
 Beckton Suffeina Y273 N

BWt	63
WR	94
YWt.	962
YR	105
Feb.ADG	3.69
Feb.Scr.	33
Frame	5.0
Feet	Good

DAM											
Age	3	Calv.Ease	BW	WW	YW	Milk	HPG	Stay	Maint.En.		
Wt	856	EPDs	20	-4.8	62	110	27	13	14 5.0		
Prog. BW	60	Marb	+.50		REA	+.23		Bfat	+.04		
WR	94	Beef Tenderness	→ DNA: 9 / Outstanding		Scan:	2.2 / Tender					
YR	105	Wean Pct.	49%	Cow Eff.	102	HB	45	GM	59	ProS	104
Udder	Very Good										

★★★★★ for Growth, Gainability, Marbling, Rib-eye area, Calving Ease.

**119 BECKTON LIKABLE J112 A6**  
1-A 100% # 4506173 Tat: BKT1 J112



Birth: 3-3-21  
 Beckton Likable Z057 L4 < Beckton Likable X445 J3  
 Beckton Minola X107 L  
**BECKTON LIKABLE G289 J5**  
 Ref. L-8 Beckton Coca B785 J < Beckton Julian GG B571  
 Beckton Coca X787 N  
 Beckton Accent B553 L2 < Beckton Accent U777 C2  
 Beckton Lana X839 L  
**BECKTON ROSE G210 A**  
 Beckton Rose Y357 N < Beckton Nebula U206 V3  
 Beckton Rose U726 CT

BWt	62
WR	97
YWt.	947
YR	98
Feb.ADG	3.58
Feb.Scr.	33
Frame	5.5
Feet	Good

DAM											
Age	2	Calv.Ease	BW	WW	YW	Milk	HPG	Stay	Maint.En.		
Wt	982	EPDs	14	-3.4	51	86	24	12	17 -3.0		
Prog. BW	62	Marb	+.49		REA	+.00		Bfat	+.03		
WR	97	Beef Tenderness	→ DNA: 9 / Outstanding		Scan:	1.4 / Tender +					
YR	98	Wean Pct.	44%	Cow Eff.	93	HB	54	GM	46	ProS	101
Udder	NA										

★★★★★ for Low Maintenance, Gainability, Marbling, Calving Ease.

**118 BECKTON NEBULA J574 C5**  
1-A 100% # 4507261 Tat: BSF1 J574



Birth: 3-31-21  
 Beckton Nebula T398 V3 < Beckton Nebula L P093  
 Beckton Minerva J615 VG  
**BECKTON NEBULA A773 L4**  
 Ref. N-2 Beckton Mona X022 L < Beckton Likable U130 L2  
 Beckton Mona U584 CD  
 Beckton Clifftop W577 E3 < BKT Clifftop TP R288  
 BKT Pine Marie R213 EP  
**BECKTON MONA Z270 C**  
 Beckton Mona U584 CD < Beckton Cody K2 R168  
 Beckton Mona P539 CH

BWt	48
WR	96
YWt.	957
YR	98
Feb.ADG	3.24
Feb.Scr.	33
Frame	5.0
Feet	Good

DAM											
Age	9	Calv.Ease	BW	WW	YW	Milk	HPG	Stay	Maint.En.		
Wt	1052	EPDs	20	-7.0	49	82	27	13	22 3.0		
Prog. BW	56	Marb	+.35		REA	-.01		Bfat	+.04		
WR	99	Beef Tenderness	→ DNA: 9 / Outstanding		Scan:	2.6 / Tender -					
YR	102	Wean Pct.	44%	Cow Eff.	92	HB	100	GM	35	ProS	134
Udder	Very Good										

★★★★★ for Marbling, Calving Ease.

**120 BECKTON HUGHES J604 R3**  
1-A 100% # 4506957 Tat: BSF1 J604



Birth: 4-2-21  
 Bieber H Hughes W109 < Basin Hobo 0545  
 Basin Rose 06T0  
**BECKTON HUGHES C463 N2**  
 Ref. B-1 Beckton Lakme T689 NX < Beckton Nexus L016  
 Beckton Lakme M669 EP  
 Beckton Roosevelt D391 L2 < Bieber Roosevelt W384  
 Beckton Indigo Y406 L  
**BECKTON LARKABEL F335 R**  
 Beckton Larkabel D646 D < Beckton Dominor A378 W7  
 Beckton Larkabel A015 A

BWt	72
WR	104
YWt.	994
YR	109
Feb.ADG	3.92
Feb.Scr.	34
Frame	5.0
Feet	Good

DAM											
Age	3	Calv.Ease	BW	WW	YW	Milk	HPG	Stay	Maint.En.		
Wt	704	EPDs	15	-3.2	62	101	26	13	21 1.0		
Prog. BW	68	Marb	+.35		REA	+.27		Bfat	+.04		
WR	107	Beef Tenderness	→ DNA: 4 / Poor		Scan:	2.6 / Tender -					
YR	110	Wean Pct.	66%	Cow Eff.	139	HB	100	GM	36	ProS	136
Udder	Very Good										

★★★★★ for Growth, Gainability, Marbling, Rib-eye area, Superior Cow, High Cow Efficiency, Calving Ease.



**121 BECKTON LIKABLE J747 L7**  
1-A 100% # 4506469 Tat: BKT1 J747



Birth: 4-17-21  
 Beckton Likable B032 C5 < Beckton Likable Z057 L4  
 Beckton Mona Z270 C  
**BECKTON LIKABLE F287 J6**  
 Ref. L-6 Beckton Larkaba X064 J < Beckton Julian U699 L5  
 Beckton Larkaba U475 CT  
 Beckton Likable U120 L2 < Beckton Likable S633  
 Beckton Lana S718 LN  
**BECKTON ROSE Z290 L**  
 Beckton Rose U122 NB < Beckton Nebula PJ S543  
 Beckton Rose S106 HW

BWt	80
WR	104
YWt.	981
YR	103
Feb.ADG	3.30
Feb.Scr.	36
Frame	5.5
Feet	Good

DAM											
Age	9	Calv.Ease	BW	WW	YW	Milk	HPG	Stay	Maint.En.		
Wt	1276	EPDs	15	-2.7	59	99	19	12	18 2.0		
Prog. BW	75	Marb	+.52		REA	-.03		Bfat	+.03		
WR	99	Beef Tenderness	→ DNA: 10 / Outstanding		Scan:	1.9 / Tender					
YR	98	Wean Pct.	42%	Cow Eff.	89	HB	59	GM	42	ProS	102
Udder	Very Good										

★★★★★ for Marbling, Calving Ease.

• Bulls •

**122 BECKTON WARRIOR J052 A8** 1-A 100% # 4506281 Tat: BKT1 J052 

Birth: 2-20-21

Beckton Warrior D359 L6	Beckton Warrior Y108 E5	BWt	52
Beckton Lana W463 L	Beckton Lana W463 L	WR	94
<b>BECKTON WARRIOR G356 N7</b>	Beckton New Era Y194	YWt.	938
Ref. W-1	Beckton Larkaba U062 C8	YR	97
Beckton Larkaba B277 N	Beckton Accent U777 C2	Feb.ADG	3.47
Beckton Accent B553 L2	Beckton Lana X839 L	Feb.Scr.	32
<b>BECKTON COCA G515 A</b>	Beckton Clifftop Z824 C4	Frame	5.0
Beckton Coca B118 C	Beckton Coca Z545 H	Feet	Good

DAM		Calv.Ease	BW	WW	YW	Milk	HPG	Stay	Maint.En.		
Age	2	EPDs	17	-4.2	54	92	25	12	15	3.0	
Wt	726	Marb	+.39		REA	-.02		Bfat		+0.04	
Prog. BW	52	Beef Tenderness→ DNA: 10 / Outstanding		Scan: 1.9 / Tender							
WR	94	Wean Pct.	58%	Cow Eff.	122	HB	38	GM	38	ProS	76
YR	97										
Udder	NA										

★★★★★ for Marbling, High Cow Efficiency, Calving Ease.



**123 BECKTON HERITAGE J275 A6** 1-A 100% # 4506299 Tat: BKT1 J275 

Birth: 3-17-21

Beckton Heritage D195 L4	Beckton Heritage A767 C3	BWt	59
Beckton Susan W846 L	Beckton Susan W846 L	WR	102
<b>BECKTON HERITAGE G152 L5</b>	Beckton Legend S670	YWt.	1002
Ref. H-4	Beckton Belga U103 JC	YR	104
Beckton Belga B647 L	Beckton Accent W180 C2	Feb.ADG	3.52
Beckton Accent B549 N3	Beckton Minerva Y654 N	Feb.Scr.	32
<b>BECKTON EMERA G579 A</b>	Beckton Julian X465 J5	Frame	5.5
Beckton Emera C291 J	Beckton Emera Y009 D	Feet	Good

DAM		Calv.Ease	BW	WW	YW	Milk	HPG	Stay	Maint.En.		
Age	2	EPDs	17	-4.2	61	103	27	12	17	3.0	
Wt	798	Marb	+.48		REA	+.09		Bfat		+0.03	
Prog. BW	59	Beef Tenderness→ DNA: 5 / Average		Scan: 2.3 / Tender							
WR	102	Wean Pct.	58%	Cow Eff.	122	HB	54	GM	49	ProS	103
YR	104										
Udder	Very Good										

★★★★★ for Gainability, Marbling, High Cow Efficiency, Calving Ease.

**125 BECKTON ACCENT J110 C4** 1-A 100% # 4507051 Tat: BSF1 J110 

Birth: 3-2-21

Beckton Accent B553 L2	Beckton Accent U777 C2	BWt	64
Beckton Lana X839 L	Beckton Lana X839 L	WR	106
<b>BECKTON ACCENT G208 N3</b>	Beckton New Era Y194	YWt.	982
Ref. A-7	Beckton Sierra S847 WR	YR	102
Beckton Sierra A836 N	Beckton Clifftop C572 N5	Feb.ADG	3.64
Beckton Clifftop E077 L6	Beckton Larkaba C217 L	Feb.Scr.	31
<b>BECKTON BARMAID G161 C</b>	Beckton Epic C776 J6	Frame	5.5
Beckton Barmaid E190 E	Beckton Barmaid C194 N	Feet	Good

DAM		Calv.Ease	BW	WW	YW	Milk	HPG	Stay	Maint.En.		
Age	2	EPDs	12	-1.0	67	107	24	11	18	3.0	
Wt	668	Marb	+.36		REA	+.18		Bfat		+0.03	
Prog. BW	64	Beef Tenderness→ DNA: 7 / Very Good		Scan: 2.3 / Tender							
WR	106	Wean Pct.	72%	Cow Eff.	152	HB	58	GM	28	ProS	86
YR	102										
Udder	Very Good										

★★★★★ for Gainability, Marbling, Rib-eye area, High Cow Efficiency, Calving Ease.

**124 BECKTON LIKABLE J381 N5** 1-A 100% # 4506431 Tat: BKT1 J381 

Birth: 3-21-21

Beckton Likable Y124 L3	Beckton Likable U130 L2	BWt	54
BKT Pine Marie S802 L0	BKT Pine Marie S802 L0	WR	108
<b>BECKTON LIKABLE E391 N4</b>	Beckton Nebula T398 V3	YWt.	950
Ref. L-4	Beckton Lana T226 NB	YR	100
Beckton Lana X466 N	Beckton Nebula M045	Feb.ADG	3.01
Beckton Nebula P P707	Beckton Lana M809 EP	Feb.Scr.	32
<b>BECKTON BELGA Y254 N</b>	Beckton Epic K3 M606	Frame	5.0
Beckton Belga S747 EP	Beckton Belga K202 LN	Feet	Good

DAM		Calv.Ease	BW	WW	YW	Milk	HPG	Stay	Maint.En.		
Age	10	EPDs	17	-6.1	60	96	25	10	19	1.0	
Wt	980	Marb	+.44		REA	-.25		Bfat		+0.04	
Prog. BW	62	Beef Tenderness→ DNA: 10 / Outstanding		Scan: 1.8 / Tender							
WR	95	Wean Pct.	57%	Cow Eff.	120	HB	71	GM	33	ProS	104
YR	99										
Udder	Good										

★★★★★ for Marbling, High Cow Efficiency, Calving Ease.

**126 BECKTON DOMINOR J638 L9** 1-A 100% # 4506819 Tat: BSF1 J638 

Birth: 4-5-21

Beckton Dominor A378 W7	Beckton Dominor Y005 V6	BWt	70
Beckton Lana Y541 W	Beckton Lana Y541 W	WR	108
<b>BECKTON DOMINOR F263 N8</b>	Beckton Nebula EN S347	YWt.	943
Ref. D-2	Beckton Larkaba N643 HR	YR	99
Beckton Larkaba W272 N	Beckton Likable X445 J3	Feb.ADG	2.73
Beckton Likable Z057 L4	Beckton Minola X107 L	Feb.Scr.	35
<b>BECKTON MINERVA D903 L</b>	Beckton Nebula T398 V3	Frame	5.5
Beckton Minerva Y654 N	Beckton Minerva M369 LO	Feet	Good

DAM		Calv.Ease	BW	WW	YW	Milk	HPG	Stay	Maint.En.		
Age	5	EPDs	17	-3.6	59	97	28	14	17	4.0	
Wt	1130	Marb	+.45		REA	+.18		Bfat		+0.04	
Prog. BW	61	Beef Tenderness→ DNA: 10 / Outstanding		Scan: 2.3 / Tender							
WR	90	Wean Pct.	50%	Cow Eff.	105	HB	62	GM	42	ProS	104
YR	99										
Udder	Very Good										

★★★★★ for Marbling, Rib-eye area, Calving Ease.

• Bulls •

**127 BECKTON ACCENT J384 J6**  
1-A 100% # 4505491 Tat: BKT1 J384



Birth: 3-21-21  
 Beckton Accent B150 N4  
**BECKTON ACCENT F177 L5**  
 Ref. A-5  
 Beckton Vernice C782 L  
 Beckton Julian X465 J5  
**BECKTON EMERA C291 J**  
 Beckton Emera Y009 D  
 Beckton Accent Y260 L3  
 BKT Larkeisa S055 NB  
 Beckton Likable Y124 L3  
 Beckton Vernice X754 L  
 Beckton Julian G5 S107  
 Beckton Suffeina P643 JL  
 Beckton Dominor W640 C5  
 Beckton Emera W092 N

BWt 59  
 WR 101  
 YWt. 928  
 YR 98  
 Feb.ADG 3.01  
 Feb.Scr. 33  
 Frame 5.0  
 Feet Good

DAM		Calv.Ease	BW	WW	YW	Milk	HPG	Stay	Maint.En.
Age	6	EPDs	20	-6.7	48	74	28	12	19
Wt	938	Marb	+.55		REA	-.10		Bfat +.04	
Prog. BW	65	Beef Tenderness	→ DNA: 7 / Very Good		Scan: 2.1 / Tender				
WR	101	Wean Pct.	56%		Cow Eff.	118		HB	76
YR	97							GM	39
Udder	Very Good								ProS 115

★★★★★ for Low Maintenance, Marbling, High Cow Efficiency, Calving Ease.



**128 BECKTON LIKABLE J471 A5**  
1-A 100% # 4505639 Tat: BKT1 J471



Birth: 3-25-21  
 Beckton Likable Y124 L3  
**BECKTON LIKABLE E391 N4**  
 Ref. L-4  
 Beckton Lana X466 N  
 Beckton Accent U777 C2  
**BECKTON FIREFLY D489 A**  
 Beckton Firefly W021 H  
 Beckton Likable U130 L2  
 BKT Pine Marie S802 LO  
 Beckton Nebula T398 V3  
 Beckton Lana T226 NB  
 Beckton Cody K1 P014  
 Beckton Susan R022 CQ  
 Beckton Heritage T270 J2  
 Beckton Firefly T028 JR

BWt 89  
 WR 103  
 YWt. 867  
 YR 91  
 Feb.ADG 2.78  
 Feb.Scr. 31  
 Frame 5.5  
 Feet Good

DAM		Calv.Ease	BW	WW	YW	Milk	HPG	Stay	Maint.En.
Age	5	EPDs	10	-0.4	64	91	27	12	18
Wt	978	Marb	+.39		REA	-.11		Bfat +.04	
Prog. BW	75	Beef Tenderness	→ DNA: 8 / Very Good		Scan: 1.8 / Tender				
WR	100	Wean Pct.	55%		Cow Eff.	115		HB	63
YR	94								GM 16
Udder	Very Good								ProS 79

★★★★★ for Marbling.

**130 BECKTON ROOSEVELT J619 A3**  
1-A 100% # 4505655 Tat: BKT1 J619



Birth: 4-3-21  
 Bieber Roosevelt W384  
**BECKTON ROOSEVELT D305 C2**  
 Ref. B-2  
 Beckton Lana W277 A  
 Beckton Accent B643 H3  
**BECKTON TAMARA D574 A**  
 Beckton Tamara B510 D  
 Bieber Rough Rider 10712  
 Bieber Sheba 9602  
 Beckton Cody K1 P014  
 Beckton Lana N869 LO  
 Beckton Accent Y312 N3  
 BKT Larkeisa U535 HS  
 Beckton Dominor W640 C5  
 Beckton Tamara X358 CT

BWt 83  
 WR 109  
 YWt. 965  
 YR 102  
 Feb.ADG 3.35  
 Feb.Scr. 31  
 Frame 5.5  
 Feet Good

DAM		Calv.Ease	BW	WW	YW	Milk	HPG	Stay	Maint.En.
Age	5	EPDs	12	-0.7	60	91	27	12	16
Wt	962	Marb	+.37		REA	+.06		Bfat +.05	
Prog. BW	78	Beef Tenderness	→ DNA: 9 / Outstanding		Scan: 1.8 / Tender				
WR	107	Wean Pct.	59%		Cow Eff.	124		HB	58
YR	101								GM 22
Udder	Very Good								ProS 80

★★★★★ for Low Maintenance, Marbling, High Cow Efficiency, Calving Ease.

**129 BECKTON LIKABLE J048 C6**  
1-A 100% # 4506159 Tat: BKT1 J048



Birth: 2-20-21  
 Beckton Likable E391 N4  
**BECKTON LIKABLE G026 L5**  
 Ref. L-7  
 Beckton Angel E130 L  
 Beckton Clifftop C572 N5  
**BECKTON ROSE G180 C**  
 Beckton Rose D151 A  
 Beckton Likable Y124 L3  
 Beckton Lana X466 N  
 Beckton Likable C584 E4  
 Beckton Angel C816 L  
 Beckton Clifftop Y012 C4  
 BKT Pine Marie U454 NB  
 Beckton Accent W180 C2  
 Beckton Rose X573 N

BWt 59  
 WR 105  
 YWt. 1003  
 YR 104  
 Feb.ADG 3.75  
 Feb.Scr. 30  
 Frame 5.0  
 Feet Good

DAM		Calv.Ease	BW	WW	YW	Milk	HPG	Stay	Maint.En.
Age	2	EPDs	18	-5.5	58	95	27	9	18
Wt	716	Marb	+.45		REA	-.07		Bfat +.04	
Prog. BW	59	Beef Tenderness	→ DNA: 9 / Outstanding		Scan: 2.9 / Tender				
WR	105	Wean Pct.	67%		Cow Eff.	141		HB	63
YR	104								GM 38
Udder	Good								ProS 101

★★★★★ for Gainability, Marbling, Superior Cow, High Cow Efficiency, Calving Ease.

**131 BECKTON ACCENT J207 L4**  
1-A 100% # 4505549 Tat: BKT1 J207



Birth: 3-13-21  
 Beckton Accent W180 C2  
**BECKTON ACCENT B549 N3**  
 Ref. A-2  
 Beckton Minerva Y654 N  
 Beckton Likable Y124 L3  
**BECKTON COCA C840 L**  
 Beckton Coca Z239 N  
 Beckton Cody K1 P014  
 Beckton Christy R046 CQ  
 Beckton Nebula T398 V3  
 Beckton Minerva M369 LO  
 Beckton Likable U130 L2  
 BKT Pine Marie S802 LO  
 Beckton Nebula X603 J4  
 Beckton Coca X701 N

BWt 70  
 WR 108  
 YWt. 887  
 YR 94  
 Feb.ADG 3.01  
 Feb.Scr. 32  
 Frame 5.0  
 Feet Good

DAM		Calv.Ease	BW	WW	YW	Milk	HPG	Stay	Maint.En.
Age	6	EPDs	17	-4.3	57	85	26	12	21
Wt	1098	Marb	+.40		REA	+.00		Bfat +.04	
Prog. BW	63	Beef Tenderness	→ DNA: 10 / Outstanding		Scan: 1.9 / Tender				
WR	102	Wean Pct.	51%		Cow Eff.	108		HB	85
YR	91								GM 14
Udder	Fair								ProS 99

★★★★★ for Marbling, Calving Ease.

• Bulls •

**132 BECKTON CARDINAL J521 J2**  
1-A 100% # 4506713 Tat: BSF1 J521



Birth: 3-28-21

TR Double Eagle ZT220	TR Ricardo DOS	BWt	65
Beckton Lana U182 JC	Beckton Lana U182 JC	WR	115
Beckton Legend U331 E2	Beckton Legend U331 E2	YWt.	935
Beckton Larkaba A911 L	Beckton Larkaba T418 WA	YR	99
Beckton Roman J S158	Beckton Roman J S158	Feb.ADG	3.13
Beckton Sierra K557 LO	Beckton Sierra K557 LO	Feb.Scr.	31
Beckton Hasten H S462	Beckton Hasten H S462	Frame	5.0
Beckton Encino S090 JT	Beckton Encino S090 JT	Feet	Good

<b>DAM</b>		Age	6	Calv.Ease	BW	WW	YW	Milk	HPG	Stay	Maint.En.
Wt	1076	EPDs	20	-6.0	57	86	31	12	19	1.0	
Prog. BW	55	Marb	+.41		REA	+.17		Bfat	+.03		
WR	103	Beef Tenderness	→ DNA: 7 / Very Good		Scan	2.7 / Tender -					
YR	96	Wean Pct.	55%		Cow Eff.	116		HB	76		
Udder	Very Good				GM	17		ProS	93		

★★★★★ for Marbling, Rib-eye area, High Cow Efficiency, Calving Ease.

**135 BECKTON ACCENT J395 E4**  
1-A 100% # 4506657 Tat: BSF1 J395



Birth: 3-21-21

Beckton Accent W180 C2	Beckton Cody K1 P014	BWt	56
Beckton Christy R046 CQ	Beckton Christy R046 CQ	WR	101
Beckton Nebula T398 V3	Beckton Nebula T398 V3	YWt.	925
Beckton Minerva Y654 N	Beckton Minerva M369 LO	YR	97
Beckton Epic K4 N795	Beckton Epic K4 N795	Feb.ADG	3.18
Beckton Denise R308 DM	Beckton Denise R308 DM	Feb.Scr.	32
Beckton Justice C1 R483	Beckton Justice C1 R483	Frame	5.0
Beckton Coca P440 JL	Beckton Coca P440 JL	Feet	Good

<b>DAM</b>		Age	7	Calv.Ease	BW	WW	YW	Milk	HPG	Stay	Maint.En.
Wt	1148	EPDs	18	-5.1	54	92	29	11	17	13.0	
Prog. BW	60	Marb	+.41		REA	+.10		Bfat	+.04		
WR	106	Beef Tenderness	→ DNA: 10 / Outstanding		Scan	2.1 / Tender					
YR	102	Wean Pct.	45%		Cow Eff.	96		HB	42		
Udder	Good				GM	36		ProS	78		

★★★★★ for Marbling, Calving Ease.

**133 BECKTON DOMINOR J540 N9**  
1-A 100% # 4506387 Tat: BKT1 J540



Birth: 3-29-21

Beckton Dominor A378 W7	Beckton Dominor Y005 V6	BWt	74
Beckton Lana Y541 W	Beckton Lana Y541 W	WR	NA
Beckton Nebula T398 V3	Beckton Nebula T398 V3	YWt.	NA
Beckton Indigo W772 N	Beckton Indigo T613 JT	YR	NA
Beckton Nebula M045	Beckton Nebula M045	Feb.ADG	3.18
Beckton Marta M021 LN	Beckton Marta M021 LN	Feb.Scr.	35
Beckton Lancer F442 T	Beckton Lancer F442 T	Frame	5.5
Beckton Rose H292 HD	Beckton Rose H292 HD	Feet	Good

<b>DAM</b>		Age	12	Calv.Ease	BW	WW	YW	Milk	HPG	Stay	Maint.En.
Wt	1220	EPDs	15	-2.6	57	94	29	14	20	3.0	
Prog. BW	77	Marb	+.41		REA	+.17		Bfat	+.03		
WR	109	Beef Tenderness	→ DNA: 8 / Very Good		Scan	2.5 / Tender					
YR	106	Wean Pct.	NA%		Cow Eff.	NA		HB	83		
Udder	Very Good				GM	44		ProS	127		

★★★★★ for Marbling, Rib-eye area, Superior Cow, Calving Ease.



Lot 135

**134 BECKTON ACCENT J641 E6**  
1-A 100% # 4505901 Tat: BKT1 J641



Birth: 4-5-21

Beckton Accent B150 N4	Beckton Accent Y260 L3	BWt	66
BKT Larkeisa S055 NB	BKT Larkeisa S055 NB	WR	124
Beckton Likable Y124 L3	Beckton Likable Y124 L3	YWt.	965
Beckton Vernice X754 L	Beckton Vernice X754 L	YR	106
Beckton Epic K F075	Beckton Epic K F075	Feb.ADG	2.84
Beckton Minerva F495 CH	Beckton Minerva F495 CH	Feb.Scr.	32
Beckton Accent W180 C2	Beckton Accent W180 C2	Frame	5.5
Beckton Minerva L324 LN	Beckton Minerva L324 LN	Feet	Good

<b>DAM</b>		Age	3	Calv.Ease	BW	WW	YW	Milk	HPG	Stay	Maint.En.
Wt	1006	EPDs	16	-4.4	58	86	32	10	20	5.0	
Prog. BW	56	Marb	+.41		REA	-.19		Bfat	+.05		
WR	114	Beef Tenderness	→ DNA: 10 / Outstanding		Scan	2.0 / Tender					
YR	105	Wean Pct.	56%		Cow Eff.	118		HB	75		
Udder	Very Good				GM	13		ProS	88		

★★★★★ for Growth, Marbling, Superior Cow, High Cow Efficiency, Calving Ease.

**136 BECKTON LIKABLE J668 L7**  
1-A 100% # 4505751 Tat: BKT1 J668



Birth: 4-7-21

Beckton Likable B032 C5	Beckton Likable Z057 L4	BWt	73
Beckton Mona Z270 C	Beckton Mona Z270 C	WR	116
Beckton Julian U699 L5	Beckton Julian U699 L5	YWt.	961
Beckton Larkaba U475 CT	Beckton Larkaba U475 CT	YR	101
Beckton Legend X561 J2	Beckton Legend X561 J2	Feb.ADG	2.84
Beckton Larkaba W868 J	Beckton Larkaba W868 J	Feb.Scr.	32
Beckton Accent U777 C2	Beckton Accent U777 C2	Frame	5.0
Beckton Larkaba U498 EP	Beckton Larkaba U498 EP	Feet	Good

<b>DAM</b>		Age	4	Calv.Ease	BW	WW	YW	Milk	HPG	Stay	Maint.En.
Wt	1160	EPDs	14	-2.9	65	107	26	13	18	6.0	
Prog. BW	73	Marb	+.54		REA	+.03		Bfat	+.05		
WR	116	Beef Tenderness	→ DNA: 10 / Outstanding		Scan	NA / NA					
YR	106	Wean Pct.	50%		Cow Eff.	106		HB	66		
Udder	Good				GM	41		ProS	107		

★★★★★ for Marbling, Superior Cow, Calving Ease.



• Bulls •

## 137 BECKTON HUGHES J593 A3

1-A 100% # 4506721 Tat: BSF1 J593

Birth: 4-1-21

**BECKTON HUGHES C463 N2**  
Ref. B-1

**BECKTON FIREFLY C599 A**

**DAM**

Age	6	Calv.Ease	BW	WW	YW	Milk	HPG	Stay	Maint.En.			
Wt	1076	EPDs	17	-4.0	59	88	24	12	21	1.0		
Prog. BW	68	Marb	+.34		REA	-.02		Bfat	+.04			
WR	99	Beef Tenderness	→ DNA: 9 / Outstanding		Scan:	2.4 / Tender						
YR	102	Wean Pct.	49%		Cow Eff.	103	HB	96	GM	8	ProS	104
Udder	Very Good											



★★★★★ for Marbling, Calving Ease.

## 139 BECKTON DOMINOR J470 C9

1-A 100% # 4506489 Tat: BKT1 J470

Birth: 3-25-21

**BECKTON DOMINOR F263 N8**  
Ref. D-2

**BECKTON CHRISTY Z587 C**

**DAM**

Age	9	Calv.Ease	BW	WW	YW	Milk	HPG	Stay	Maint.En.			
Wt	1224	EPDs	18	-4.3	52	89	32	10	13	-2.0		
Prog. BW	70	Marb	+.36		REA	+.01		Bfat	+.05			
WR	104	Beef Tenderness	→ DNA: 9 / Outstanding		Scan:	1.2 / Tender +						
YR	104	Wean Pct.	42%		Cow Eff.	88	HB	40	GM	36	ProS	75
Udder	Very Good											



★★★★★ for Low Maintenance, Marbling, Superior Cow, Calving Ease.

## 138 BECKTON JULIAN J465 A2

1-A 100% # 4506815 Tat: BSF1 J465

Birth: 3-25-21

**BECKTON JULIAN G3 P608**  
Ref. J-2

**BECKTON BELGA D833 A**

**DAM**

Age	5	Calv.Ease	BW	WW	YW	Milk	HPG	Stay	Maint.En.			
Wt	992	EPDs	19	-5.4	49	77	26	12	17	-7.0		
Prog. BW	66	Marb	+.62		REA	-.20		Bfat	+.02			
WR	100	Beef Tenderness	→ DNA: 8 / Very Good		Scan:	1.4 / Tender +						
YR	100	Wean Pct.	52%		Cow Eff.	110	HB	60	GM	40	ProS	100
Udder	Very Good											



★★★★★ for Low Maintenance, Gainability, Marbling, Calving Ease.

## 140 BECKTON JULIAN J854 N8

1-A 100% # 4506461 Tat: BKT1 J854

Birth: 5-1-21

**BECKTON JULIAN F067 L7**  
Ref. J-5

**BECKTON CHRISTY Z229 N**

**DAM**

Age	9	Calv.Ease	BW	WW	YW	Milk	HPG	Stay	Maint.En.			
Wt	964	EPDs	17	-3.1	64	115	27	12	16	4.0		
Prog. BW	71	Marb	+.43		REA	+.07		Bfat	+.04			
WR	108	Beef Tenderness	→ DNA: 9 / Outstanding		Scan:	2.6 / Tender -						
YR	103	Wean Pct.	61%		Cow Eff.	129	HB	47	GM	52	ProS	98
Udder	Very Good											



★★★★★ for Growth, Gainability, Marbling, High Cow Efficiency, Calving Ease.



Lot 138



• Bulls •

## 141 BECKTON ROOSEVELT J594 L3

1-A 100% # 4505355 Tat: BKT1 J594



Birth: 4-1-21

**BECKTON ROOSEVELT D305 C2**  
Ref. B-2

**BECKTON FREYJA A425 L**

**DAM**

Age	8	Calv.Ease	BW	WW	YW	Milk	HPG	Stay	Maint.En.		
Wt	1068	EPDs	13	-0.9	54	81	25	13	19	-4.0	
Prog. BW	65	Marb	+0.35		REA	+0.05		Bfat	+0.03		
WR	98	Beef Tenderness	→		DNA: 6 / Average	Scan: 2.3 / Tender					
YR	101	Wean Pct.	48%	Cow Eff.	102	HB	87	GM	20	ProS	107
Udder	Fair										

★★★★★ for Low Maintenance, Marbling, Calving Ease.



Lot 141

## 143 BECKTON ACCENT J203 W5

1-A 100% # 4507139 Tat: BSF1 J203



Birth: 3-13-21

**BECKTON ACCENT G107 C4**  
Ref. A-6

**BECKTON MONA G662 W**

**DAM**

Age	2	Calv.Ease	BW	WW	YW	Milk	HPG	Stay	Maint.En.		
Wt	810	EPDs	20	-5.9	61	95	31	11	18	-2.0	
Prog. BW	48	Marb	+0.31		REA	+0.26		Bfat	+0.03		
WR	107	Beef Tenderness	→		DNA: 9 / Outstanding	Scan: 2.6 / Tender					
YR	100	Wean Pct.	60%	Cow Eff.	127	HB	80	GM	24	ProS	103
Udder	Very Good										

★★★★★ for Low Maintenance, Marbling, Rib-eye area, High Cow Efficiency, Calving Ease.

## 144 BECKTON LIKABLE J442 E4

1-A 100% # 4506895 Tat: BSF1 J442



Birth: 3-23-21

**BECKTON LIKABLE Y124 L3**  
Ref. L

**BECKTON INDIGO E780 E**

**DAM**

Age	4	Calv.Ease	BW	WW	YW	Milk	HPG	Stay	Maint.En.		
Wt	882	EPDs	20	-6.2	45	72	27	11	18	-2.0	
Prog. BW	58	Marb	+0.42		REA	-0.17		Bfat	+0.06		
WR	97	Beef Tenderness	→		DNA: 10 / Outstanding	Scan: 2.3 / Tender					
YR	100	Wean Pct.	56%	Cow Eff.	118	HB	73	GM	27	ProS	100
Udder	Very Good										

★★★★★ for Low Maintenance, Marbling, High Cow Efficiency, Calving Ease.

## 142 BSF CARDINAL J302 A3

1-B 99% # 4506987 Tat: BSF1 J302



Birth: 3-18-21

**BECKTON CARDINAL G043 C2**  
Ref. C-3

**BSF JULIANNE F601 A**

**DAM**

Age	3	Calv.Ease	BW	WW	YW	Milk	HPG	Stay	Maint.En.		
Wt	930	EPDs	17	-2.8	64	105	28	13	15	4.0	
Prog. BW	76	Marb	+0.42		REA	+0.25		Bfat	+0.03		
WR	114	Beef Tenderness	→		DNA: 9 / Outstanding	Scan: 1.9 / Tender					
YR	107	Wean Pct.	55%	Cow Eff.	115	HB	49	GM	40	ProS	89
Udder	NA										

★★★★★ for Growth, Gainability, Marbling, Rib-eye area, Superior Cow, Calving Ease.

## 145 BECKTON ACCENT J116 N4

1-A 100% # 4506259 Tat: BKT1 J116



Birth: 3-3-21

**BECKTON ACCENT G260 N3**  
Ref. A-8

**BECKTON VERNICE G437 N**

**DAM**

Age	2	Calv.Ease	BW	WW	YW	Milk	HPG	Stay	Maint.En.		
Wt	834	EPDs	16	-4.8	56	91	28	12	15	6.0	
Prog. BW	59	Marb	+0.51		REA	+0.07		Bfat	+0.03		
WR	105	Beef Tenderness	→		DNA: 9 / Outstanding	Scan: 3.3 / Tender					
YR	99	Wean Pct.	57%	Cow Eff.	120	HB	46	GM	37	ProS	84
Udder	Good										

★★★★★ for Marbling, High Cow Efficiency, Calving Ease.

• Bulls •

**146 BECKTON CARDINAL J315 L2** 1-A 100% # 4506687 Tat: BSF1 J315 

Birth: 3-18-21

TR Double Eagle ZT220  
 TR Ricardo DOS  
 Beckton Lana U182 JC

**BECKTON CARDINAL B074 N**  
 Ref. C-1 BKT Pine Marie Z250 N  
 Beckton Nebula J R475  
 BKT Pine Marie U621 NB

Mushrush Lunesta A007  
 Mushrush Lunesta MD Y097  
 Mushrush Candice JL X212

**BECKTON BARMAID C005 L**  
 Beckton Barmaid A776 W  
 Beckton Warrior W534 N4  
 Beckton Barmaid X819 N

BWt	62
WR	102
YWt.	889
YR	96
Feb.ADG	3.30
Feb.Scr.	36
Frame	5.0
Feet	Good

DAM	
Age	6
Wt	1450
Prog. BW	66
WR	107
YR	95
Udder	NA

Calv.Ease	BW	WW	YW	Milk	HPG	Stay	Maint.En.
EPDs	20	-7.1	49	78	29	11	18 -1.0
Marb	+0.43		REA +0.00		Bfat +0.03		
Beef Tenderness	→ DNA: 9 / Outstanding		Scan: 2.3 / Tender				
Wean Pct.	33%	Cow Eff.	70	HB	71	GM	31 ProS 102

★★★★★ for Low Maintenance, Marbling, Calving Ease.

**148 BECKTON DOMINOR J537 E9** 1-A 100% # 4506605 Tat: BSF1 J537 

Birth: 3-29-21

Beckton Dominor A378 W7  
 Beckton Lana Y541 W

**BECKTON DOMINOR D254 N8**  
 Ref. D-1 Beckton Indigo W772 N  
 Beckton Nebula T398 V3  
 Beckton Indigo T613 JT

Beckton Epic Y484 N6  
 Beckton Epic U749 D5  
 Beckton Lydia S069 NB

**BECKTON CHRISTY A163 E**  
 Beckton Christy Y364 N  
 Beckton Nebula T269 E2  
 Beckton Christy S151 NB

BWt	67
WR	100
YWt.	945
YR	100
Feb.ADG	3.07
Feb.Scr.	35
Frame	5.0
Feet	Good

DAM	
Age	8
Wt	1042
Prog. BW	61
WR	101
YR	100
Udder	Very Good

Calv.Ease	BW	WW	YW	Milk	HPG	Stay	Maint.En.
EPDs	19	-5.3	48	81	31	12	16 1.0
Marb	+0.36		REA +0.09		Bfat +0.04		
Beef Tenderness	→ DNA: 10 / Outstanding		Scan: 2.2 / Tender				
Wean Pct.	50%	Cow Eff.	105	HB	63	GM	29 ProS 92

★★★★★ for Marbling, Calving Ease.



Lot 146

**149 BECKTON EPIC J613 N8** 1-A 100% # 4506659 Tat: BSF1 J613 

Birth: 4-2-21

Beckton Epic Z674 E6  
 Beckton Epic U749 D5  
 Beckton Indigo U504 EP

**BECKTON EPIC F279 A7**  
 Ref. E-1 Beckton Firefly B511 A  
 Beckton Accent W180 C2  
 Beckton Firefly X336 H

Beckton Nebula P P707  
 Beckton Nebula M045  
 Beckton Lana M809 EP

**BECKTON CHRISTY B411 N**  
 Beckton Christy X694 E  
 Beckton Epic T524 L5  
 Beckton Christy U702 RA

BWt	68
WR	102
YWt.	936
YR	99
Feb.ADG	3.41
Feb.Scr.	34
Frame	5.0
Feet	Good

DAM	
Age	7
Wt	1050
Prog. BW	67
WR	97
YR	98
Udder	Very Good

Calv.Ease	BW	WW	YW	Milk	HPG	Stay	Maint.En.
EPDs	17	-4.7	55	88	29	11	17 -2.0
Marb	+0.47		REA -0.11		Bfat +0.05		
Beef Tenderness	→ DNA: 10 / Outstanding		Scan: 1.8 / Tender				
Wean Pct.	51%	Cow Eff.	106	HB	60	GM	27 ProS 88

★★★★★ for Low Maintenance, Marbling, Calving Ease.

**147 BECKTON NEBULA J563 A6** 1-A 100% # 4507033 Tat: BSF1 J563 

Birth: 3-31-21

Beckton Nebula A773 L4  
 Beckton Nebula T398 V3  
 Beckton Mona X022 L

**BECKTON NEBULA C067 N5**  
 Ref. N-3 Beckton Marta A319 N  
 Beckton Nebula P P707  
 Beckton Marta X405 J

Beckton Accent B150 N4  
 Beckton Accent Y260 L3  
 BKT Larkeisa S055 NB

**BECKTON BELGA F897 J5**  
 Beckton Belga B852 J  
 Beckton Julian Z360 W4  
 Beckton Belga Z228 L

BWt	63
WR	112
YWt.	949
YR	104
Feb.ADG	3.58
Feb.Scr.	33
Frame	5.5
Feet	Good

DAM	
Age	3
Wt	856
Prog. BW	66
WR	112
YR	104
Udder	Very Good

Calv.Ease	BW	WW	YW	Milk	HPG	Stay	Maint.En.
EPDs	15	-3.4	63	100	27	13	19 2.0
Marb	+0.43		REA -0.04		Bfat +0.04		
Beef Tenderness	→ DNA: 10 / Outstanding		Scan: 2.0 / Tender				
Wean Pct.	59%	Cow Eff.	124	HB	71	GM	35 ProS 106

★★★★★ for Gainability, Marbling, Superior Cow, High Cow Efficiency, Calving Ease.



Lot 149

• Bulls •

**150 BECKTON ROOSEVELT J771 N3** 1-A 100% # 4506385 Tat: BKT1 J771



Birth: 4-18-21  
 Bieber Roosevelt W384  
**BECKTON ROOSEVELT D305 C2**  
 Ref. B-2  
 Beckton Lana W277 A  
 Bieber Rough Rider 10712  
 Bieber Sheba 9602  
 Beckton Cody K1 P014  
 Beckton Lana N869 LO  
 Beckton Nebula EN S347  
**BECKTON LARKABA W272 N**  
 Beckton Larkaba N643 HR  
 Beckton Nebula E P084  
 Beckton Eola P530 NB  
 Beckton Herald FJ J776  
 Beckton Larkaba J765 CH

BWt	67
WR	100
YWt.	980
YR	103
Feb.ADG	3.41
Feb.Scr.	35
Frame	5.0
Feet	Good

DAM		Calv.Ease	BW	WW	YW	Milk	HPG	Stay	Maint.En.	
Age	12	EPDs	18	-4.2	50	77	31	14	18	-7.0
Wt	888	Marb	+0.35		REA	-.04		Bfat	+0.05	
Prog. BW	62	Beef Tenderness	→ DNA: 9 / Outstanding		Scan:	2.3 / Tender				
WR	105	Wean Pct.	56%		Cow Eff.	119		HB	86	
YR	102							GM	28	
Udder	Very Good							ProS	114	

★★★★★ for Low Maintenance, Marbling, High Cow Efficiency, Calving Ease.

**153 BSF HUGHES J480 A3** 1-B 99% # 4507025 Tat: BSF1 J480



Birth: 3-25-21  
 Bieber H Hughes W109  
**BECKTON HUGHES C463 N2**  
 Ref. B-1  
 Beckton Lakme T689 NX  
 Basin Hobo 0545  
 Basin Rose 06T0  
 Beckton Nexus L016  
 Beckton Lakme M669 EP  
 Beckton Accent B150 N4  
**BSF WENDIE F848 A**  
 BSF Wendie C536 S  
 Beckton Accent Y260 L3  
 BKT Larkeisa S055 NB  
 Beckton Scamp X494 E3  
 BSF Wendie X068 N

BWt	58
WR	103
YWt.	958
YR	105
Feb.ADG	3.75
Feb.Scr.	33
Frame	5.0
Feet	Good

DAM		Calv.Ease	BW	WW	YW	Milk	HPG	Stay	Maint.En.	
Age	3	EPDs	15	-4.9	57	90	25	11	18	-3.0
Wt	700	Marb	+0.42		REA	+0.06		Bfat	+0.05	
Prog. BW	58	Beef Tenderness	→ DNA: 9 / Outstanding		Scan:	1.7 / Tender				
WR	102	Wean Pct.	65%		Cow Eff.	137		HB	85	
YR	103							GM	27	
Udder	Fair							ProS	112	

★★★★★ for Low Maintenance, Gainability, Marbling, High Cow Efficiency, Calving Ease.

**151 BECKTON LIKABLE J272 L5** 1-A 100% # 4506405 Tat: BKT1 J272



Birth: 3-17-21  
 Beckton Likable Y124 L3  
**BECKTON LIKABLE F242 D4**  
 Ref. L-5  
 Beckton Firefly A022 D  
 Beckton Likable U130 L2  
 BKT Pine Marie S802 LO  
 Beckton Dominor W640 C5  
 Beckton Firefly U801 NB  
 Beckton Likable U120 L2  
**BECKTON EOLA X216 L**  
 Beckton Eola U027 NB  
 Beckton Likable S633  
 Beckton Lana S718 LN  
 Beckton Nebula EN S347  
 Beckton Eola S317 LO

BWt	52
WR	90
YWt.	949
YR	100
Feb.ADG	4.09
Feb.Scr.	33
Frame	4.5
Feet	Good

DAM		Calv.Ease	BW	WW	YW	Milk	HPG	Stay	Maint.En.	
Age	11	EPDs	23	-8.5	45	72	32	10	16	-4.0
Wt	1164	Marb	+0.39		REA	-.04		Bfat	+0.04	
Prog. BW	68	Beef Tenderness	→ DNA: 10 / Outstanding		Scan:	1.7 / Tender				
WR	110	Wean Pct.	39%		Cow Eff.	81		HB	63	
YR	104							GM	30	
Udder	Good							ProS	93	

★★★★★ for Low Maintenance, Gainability, Marbling, Superior Cow, Calving Ease.

**154 BECKTON SCAMP J282 A7** 1-A 100% # 4506951 Tat: BSF1 J282



Birth: 3-17-21  
 Beckton Scamp D325 N5  
**BECKTON SCAMP G325 N6**  
 Ref. S-4  
 Beckton Barmaid C194 N  
 Beckton Scamp A627 J4  
 Beckton Tamara Y039 N  
 Beckton New Era Y194  
 Beckton Barmaid X654 N  
 Beckton Accent W180 C2  
**BECKTON MARTA F319 A**  
 Beckton Marta B193 L  
 Beckton Cody K1 P014  
 Beckton Christy R046 CQ  
 Beckton Legend Z689 J3  
 Beckton Marta Z075 S

BWt	51
WR	97
YWt.	953
YR	104
Feb.ADG	3.58
Feb.Scr.	32
Frame	5.0
Feet	Good

DAM		Calv.Ease	BW	WW	YW	Milk	HPG	Stay	Maint.En.	
Age	3	EPDs	17	-4.9	57	97	28	12	18	-2.0
Wt	840	Marb	+0.32		REA	+0.07		Bfat	+0.03	
Prog. BW	51	Beef Tenderness	→ DNA: 10 / Outstanding		Scan:	2.2 / Tender				
WR	97	Wean Pct.	51%		Cow Eff.	108		HB	73	
YR	104							GM	33	
Udder	Very Good							ProS	106	

★★★★★ for Low Maintenance, Gainability, Marbling, Calving Ease.

**152 BECKTON LIKABLE J428 E4** 1-A 100% # 4506677 Tat: BSF1 J428



Birth: 3-23-21  
 Beckton Likable U130 L2  
**BECKTON LIKABLE D432 N3**  
 Ref. L-3  
 Beckton Firefly W013 N  
 Beckton Likable S633  
 Beckton Kit S478 LN  
 Beckton Nebula T054 H3  
 Beckton Firefly T003 JC  
 Beckton Epic Y484 N6  
**BECKTON CHRISTY B701 E**  
 Beckton Christy X005 L  
 Beckton Epic U749 D5  
 Beckton Lydia S069 NB  
 Beckton Legend U331 E2  
 Beckton Christy U415 JL

BWt	58
WR	91
YWt.	928
YR	98
Feb.ADG	3.47
Feb.Scr.	33
Frame	5.0
Feet	Good

DAM		Calv.Ease	BW	WW	YW	Milk	HPG	Stay	Maint.En.	
Age	7	EPDs	19	-5.8	44	77	27	11	17	-8.0
Wt	940	Marb	+0.38		REA	+0.16		Bfat	+0.03	
Prog. BW	59	Beef Tenderness	→ DNA: 8 / Very Good		Scan:	2.6 / Tender				
WR	104	Wean Pct.	50%		Cow Eff.	106		HB	70	
YR	105							GM	37	
Udder	Very Good							ProS	108	

★★★★★ for Low Maintenance, Marbling, Rib-eye area, Superior Cow, Calving Ease.



Lot 154

• Bulls •

**155 BSF ACCENT J776 W6** 

1-B 99% # 4506859 Tat: BSF1 J776  
 Birth: 4-19-21  
**BECKTON ACCENT F177 L5**  
 Ref. A-5  
**BSF OLIVE E350 W**  
 Beckton Accent B150 N4  
 Beckton Vernice C782 L  
 Beckton Warrior Y108 E5  
 BSF Olive A863 C  
 Beckton Accent Y260 L3  
 BKT Larkeisa S055 NB  
 Beckton Likable Y124 L3  
 Beckton Vernice X754 L  
 Beckton Warrior W534 N4  
 Beckton Susan W058 E  
 Beckton Clifftop Y012 C4  
 BSF Olive Y105 L

DAM		Calv.Ease	BW	WW	YW	Milk	HPG	Stay	Maint.En.		
Age	4	EPDs	18	-5.3	52	82	31	12	16	3.0	
Wt	932	Marb	+.45		REA	-.11		Bfat +.05			
Prog. BW	57	Beef Tenderness→ DNA: 9 / Outstanding		Scan: 1.9 / Tender							
WR	107	Wean Pct.	58%	Cow Eff.	123	HB	58	GM	28	ProS	86
YR	105										
Udder	Very Good										

★★★★★ for Growth, Marbling, Superior Cow, High Cow Efficiency, Calving Ease.

**158 BECKTON CARDINAL J731 H3** 

1-A 100% # 4505997 Tat: BKT1 J731  
 Birth: 4-15-21  
**BECKTON CARDINAL G043 C2**  
 Ref. C-3  
**BECKTON TAMARA F552 H**  
 Beckton Cardinal E673 L  
 Beckton Minerva E181 D  
 Beckton Heritage B612 J4  
 Beckton Tamara B363 A  
 TR Double Eagle ZT220  
 Beckton Larkaba A911 L  
 TR Double Eagle ZT220  
 Beckton Minerva W901 J  
 Beckton Heritage X403 L3  
 Beckton Lana N291 JC  
 Beckton Accent Y312 N3  
 Beckton Tamara X447 J

DAM		Calv.Ease	BW	WW	YW	Milk	HPG	Stay	Maint.En.		
Age	3	EPDs	20	-5.7	64	103	30	13	15	1.0	
Wt	864	Marb	+.41		REA	+.33		Bfat +.04			
Prog. BW	52	Beef Tenderness→ DNA: 6 / Average		Scan: 2.7 / Tender -							
WR	115	Wean Pct.	60%	Cow Eff.	126	HB	54	GM	34	ProS	88
YR	114										
Udder	Very Good										

★★★★★ for Growth, Gainability, Marbling, Rib-eye area, Superior Cow, High Cow Efficiency, Calving Ease.

**156 BECKTON SCAMP J190 C7** 

1-A 100% # Tat: BKT1 J190  
 Birth: 3-12-21  
**BECKTON SCAMP G325 N6**  
 Ref. S-4  
**BECKTON COCA G754 C**  
 Beckton Scamp D325 N5  
 Beckton Barmaid C194 N  
 Beckton Clifftop E077 L6  
 Beckton Coca E640 L  
 Beckton Scamp A627 J4  
 Beckton Tamara Y039 N  
 Beckton New Era Y194  
 Beckton Barmaid X654 N  
 Beckton Clifftop C572 N5  
 Beckton Larkaba C217 L  
 Beckton Legend Z689 J3  
 Beckton Coca B118 C

DAM		Calv.Ease	BW	WW	YW	Milk	HPG	Stay	Maint.En.		
Age	2	EPDs	17	-4.0	54	91	24	11	18	-5.8	
Wt	NA	Marb	+.42		REA	+.03		Bfat +.05			
Prog. BW	61	Beef Tenderness→ DNA: 10 / Outstanding		Scan: NA / NA							
WR	97	Wean Pct.	NA%	Cow Eff.	NA	HB	NA	GM	NA	ProS	NA
YR	104										
Udder	NA										

★★★★★ for Low Maintenance, Gainability, Marbling, Calving Ease.

**159 BECKTON ROOSEVELT J753 A3** 

1-A 100% # 4505597 Tat: BKT1 J753  
 Birth: 4-17-21  
**BECKTON ROOSEVELT D305 C2**  
 Ref. B-2  
**BECKTON SUFFEINA D277 A**  
 Bieber Roosevelt W384  
 Beckton Lana W277 A  
 Beckton Accent U777 C2  
 Beckton Suffeina Y273 N  
 Bieber Rough Rider 10712  
 Bieber Sheba 9602  
 Beckton Cody K1 P014  
 Beckton Lana N869 LO  
 Beckton Cody K1 P014  
 Beckton Susan R022 CQ  
 Beckton Nebula W778 J4  
 Beckton Suffeina W489 W

DAM		Calv.Ease	BW	WW	YW	Milk	HPG	Stay	Maint.En.		
Age	5	EPDs	18	-4.7	51	84	27	12	17	-2.0	
Wt	988	Marb	+.41		REA	-.09		Bfat +.05			
Prog. BW	59	Beef Tenderness→ DNA: 9 / Outstanding		Scan: NA / NA							
WR	106	Wean Pct.	51%	Cow Eff.	108	HB	70	GM	31	ProS	101
YR	104										
Udder	Very Good										

★★★★★ for Low Maintenance, Marbling, Superior Cow, Calving Ease.

**157 BSF NEBULA J529 H5** 

1-B 99% # 4507097 Tat: BSF1 J529  
 Birth: 3-28-21  
**BECKTON NEBULA G249 N4**  
 Ref. N-5  
**BSF HUSTELLE G458 H**  
 Beckton Nebula B557 J3  
 Beckton Lana Y130 N  
 Beckton Hughes E261 S3  
 BSF Hustelle E607 E  
 Beckton Nebula P P707  
 Beckton Larkaba T813 JC  
 Beckton Nebula W022 D3  
 Beckton Lana W525 D  
 Beckton Hughes C463 N2  
 Beckton Lana C073 S  
 Beckton Epic B483 N6  
 BSF Hustelle B663 S

DAM		Calv.Ease	BW	WW	YW	Milk	HPG	Stay	Maint.En.		
Age	2	EPDs	15	-4.5	56	99	30	12	18	3.0	
Wt	642	Marb	+.48		REA	-.05		Bfat +.04			
Prog. BW	60	Beef Tenderness→ DNA: 10 / Outstanding		Scan: 1.9 / Tender							
WR	99	Wean Pct.	70%	Cow Eff.	146	HB	72	GM	54	ProS	126
YR	103										
Udder	Very Good										

★★★★★ for Gainability, Marbling, High Cow Efficiency, Calving Ease.



• Bulls •

**160 BSF ACCENT J261 S6** 1-B 99% # 4506795 Tat: BSF1 J261



Birth: 3-16-21  
 Beckton Accent B150 N4  
**BECKTON ACCENT F177 L5**  
 Ref. A-5  
 Beckton Vernice C782 L  
 Beckton Accent Y260 L3  
 BKT Larkeisa S055 NB  
 Beckton Likable Y124 L3  
 Beckton Vernice X754 L  
 Beckton Scamp B497 N4  
**BSF JUSTICIA D664 S**  
 BSF Justicia B020 W  
 Beckton Scamp X494 E3  
 Beckton Coca W061 N  
 Beckton Warrior Z936 N6  
 BSF Justicia Z009 N

BWt 62  
 WR 89  
 YWt. 887  
 YR 93  
 Feb.ADG 3.52  
 Feb.Scr. 34  
 Frame 5.0  
 Feet Good

DAM		Calv.Ease	BW	WW	YW	Milk	HPG	Stay	Maint.En.	
Age	5	EPDs	19	-6.5	43	66	30	13	17	-1.0
Wt	782	Marb	+.50		REA	-.18		Bfat +.04		
Prog. BW	55	Beef Tenderness	→		DNA: 6 / Average	Scan: 1.7 / Tender				
WR	101	Wean Pct.	59%		Cow Eff.	125		HB	66	
YR	101							GM	32	
Udder	Very Good							ProS	97	

★★★★★ for Low Maintenance, Gainability, Marbling, High Cow Efficiency, Calving Ease.

**163 BECKTON ORACLE J917 N2** 1-A 100% # 4505333 Tat: BKT1 J917



Birth: 5-11-21  
 Schuler Sudden Impact 0004X  
**SCHULER ORACLE-7142E**  
 Ref. O-1  
 Sor Marlee Cmmtmnt 0470X  
 Red Crowfoot Ole's Oscar  
 SOR Duchess TS 8915U  
 Brown Commitment S7206  
 SOR Marlee Beef 4511P  
 Beckton Nebula Y002 C5  
**BECKTON COCA A120 N**  
 Beckton Coca Y190 J  
 Beckton Nebula W778 J4  
 BKT Pine Marie W102 C  
 Beckton Julian W743 H5  
 Beckton Coca W512 N

BWt 70  
 WR 98  
 YWt. 1014  
 YR 107  
 Feb.ADG 4.09  
 Feb.Scr. 34  
 Frame 5.0  
 Feet Good

DAM		Calv.Ease	BW	WW	YW	Milk	HPG	Stay	Maint.En.	
Age	8	EPDs	20	-5.8	54	91	19	12	18	-4.0
Wt	960	Marb	+.66		REA	+.02		Bfat +.03		
Prog. BW	63	Beef Tenderness	→		DNA: 10 / Outstanding	Scan: 2.4 / Tender				
WR	93	Wean Pct.	53%		Cow Eff.	111		HB	77	
YR	99							GM	64	
Udder	Good							ProS	141	

★★★★★ for Low Maintenance, Growth, Gainability, Marbling, Calving Ease.

**161 BECKTON CARDINAL J702 N2** 1-A 100% # 4507191 Tat: BSF1 J702



Birth: 4-11-21  
 TR Double Eagle ZT220  
**BECKTON CARDINAL E673 L**  
 Ref. C-2  
 Beckton Larkaba A911 L  
 TR Ricardo DOS  
 Beckton Lana U182 JC  
 Beckton Legend U331 E2  
 Beckton Larkaba T418 WA  
 Beckton Nebula T269 E2  
**BECKTON BARMAID X231 N**  
 Beckton Barmaid G565 LN  
 Beckton Nebula M045  
 Beckton Ruth M967 EP  
 Beckton Lancer T A664  
 Bkt Barmaid 9517 RN

BWt 58  
 WR 105  
 YWt. 959  
 YR 101  
 Feb.ADG 3.13  
 Feb.Scr. 33  
 Frame 5.0  
 Feet Good

DAM		Calv.Ease	BW	WW	YW	Milk	HPG	Stay	Maint.En.	
Age	11	EPDs	22	-8.3	44	69	31	11	17	-4.0
Wt	992	Marb	+.51		REA	+.06		Bfat +.04		
Prog. BW	64	Beef Tenderness	→		DNA: 6 / Average	Scan: 2.2 / Tender				
WR	102	Wean Pct.	53%		Cow Eff.	111		HB	72	
YR	99							GM	31	
Udder	Good							ProS	103	

★★★★★ for Low Maintenance, Marbling, Calving Ease.



Lot 163

**162 BECKTON PRESIDENT J735 H2** 1-A 100% # 4505563 Tat: BKT1 J735



Birth: 4-16-21  
 LSF SRR Commander 5906C  
**LSF SRR PRESIDENT 8177F**  
 Ref. O-2  
 LSF SRR Flo-Marie 961 D6451  
 HXC Conquest 4405P  
 LSF Crystal R5145 X0414  
 Messmer Packer S008  
 LSF Della P4078 U8051  
 Beckton Heritage B612 J4  
**BECKTON LANA D088 H**  
 Beckton Lana B526 L  
 Beckton Heritage X403 L3  
 Beckton Lana N291 JC  
 Beckton Likable U130 L2  
 Beckton Lana Y193 N

BWt 70  
 WR 95  
 YWt. 979  
 YR 103  
 Feb.ADG 3.30  
 Feb.Scr. 33  
 Frame 5.0  
 Feet Good

DAM		Calv.Ease	BW	WW	YW	Milk	HPG	Stay	Maint.En.	
Age	5	EPDs	14	-4.0	67	102	25	13	18	0.0
Wt	1034	Marb	+.66		REA	+.24		Bfat +.04		
Prog. BW	70	Beef Tenderness	→		DNA: 6 / Average	Scan: 1.9 / Tender				
WR	102	Wean Pct.	48%		Cow Eff.	101		HB	78	
YR	97							GM	51	
Udder	Very Good							ProS	129	

★★★★★ for Low Maintenance, Marbling, Rib-eye area, Calving Ease.

**164 BECKTON JULIAN J900 N8** 1-A 100% # 4506891 Tat: BSF1 J900



Birth: 0-0-0  
 Beckton Julian D551 C6  
**BECKTON JULIAN F067 L7**  
 Ref. J-5  
 Beckton Indigo D786 L  
 Beckton Julian X465 J5  
 Beckton Tamara W550 A  
 Beckton Likable Z057 L4  
 Beckton Indigo Y026 N  
 Beckton Nebula X267 J3  
**BECKTON COCA E765 N**  
 Beckton Coca C518 L  
 Beckton Nebula T269 E2  
 Beckton Indigo T613 JT  
 Beckton Legend S670  
 Beckton Coca X734 C

BWt NA  
 WR NA  
 YWt. NA  
 YR NA  
 Feb.ADG 3.98  
 Feb.Scr. 42  
 Frame NA  
 Feet Good

DAM		Calv.Ease	BW	WW	YW	Milk	HPG	Stay	Maint.En.	
Age	4	EPDs	22	-7.2	48	88	28	13	14	1.0
Wt	682	Marb	+.60		REA	-.10		Bfat +.05		
Prog. BW	42	Beef Tenderness	→		DNA: 9 / Outstanding	Scan: NA / NA				
WR	97	Wean Pct.	NA%		Cow Eff.	NA		HB	41	
YR	95							GM	52	
Udder	Very Good							ProS	101	

★★★★★ for Gainability, Marbling, Calving Ease.

• Bulls •

**165 BECKTON LIKABLE J893 N4** 2 100% # 4505403 Tat: BKT1 J893 

Birth: 5-6-21  
 Beckton Likable U130 L2 < Beckton Likable S633  
 Beckton Kit S478 LN  
**BECKTON LIKABLE C229 R3**  
 Ref. L-2 Beckton Tamara X447 J < Beckton Roman J S158  
 Beckton Tamara R834 JC  
**BECKTON SUSAN B246 N**  
 Beckton New Era Y194 < Beckton Nebula P P707  
 BKT Larkeisa T310 JC  
 Beckton Susan R022 CQ < Beckton Cherokee N N479  
 Beckton Susan N023 JE

DAM		Calv.Ease	BW	WW	YW	Milk	HPG	Stay	Maint.En.	
Age	7	EPDs	18	-5.1	62	98	28	12	19	0.0
Wt	1148	Marb	+.38		REA	+.23		Bfat +.04		
Prog. BW	59	Beef Tenderness→ DNA: 10 / Outstanding Scan: 1.9 / Tender								
WR	99	Wean Pct. 53% Cow Eff. 111 HB 74 GM 29 ProS 103								
YR	108									
Udder	Very Good									

★★★★★ for Low Maintenance, Growth, Marbling, Rib-eye area, Calving Ease.

**167 BECKTON LIKABLE J919 A5** 1-A 100% # 4506857 Tat: BSF1 J919 

Birth: 5-11-21  
 Beckton Likable Y124 L3 < Beckton Likable U130 L2  
 BKT Pine Marie S802 LO  
**BECKTON LIKABLE E391 N4**  
 Ref. L-4 Beckton Lana X466 N < Beckton Nebula T398 V3  
 Beckton Lana T226 NB  
**BECKTON JANE E340 A**  
 Beckton Accent A175 O3 < Beckton Accent W180 C2  
 Beckton Lana R214 RA  
 Beckton Jane B220 L < Beckton Legend S670  
 Beckton Jane P410 NP

DAM		Calv.Ease	BW	WW	YW	Milk	HPG	Stay	Maint.En.	
Age	4	EPDs	13	-2.0	67	101	29	10	22	5.0
Wt	980	Marb	+.30		REA	+.01		Bfat +.03		
Prog. BW	78	Beef Tenderness→ DNA: 9 / Outstanding Scan: 1.4 / Tender +								
WR	112	Wean Pct. 58% Cow Eff. 123 HB 86 GM 13 ProS 99								
YR	110									
Udder	Very Good									

★★★★★ for Growth, Marbling, Superior Cow, High Cow Efficiency, Calving Ease.

**166 BECKTON ACCENT J902 E5** 1-A 100% # 4506745 Tat: BSF1 J902 

Birth: 5-8-21  
 Beckton Accent Y260 L3 < Beckton Accent W180 C2  
 Beckton Lana W463 L  
**BECKTON ACCENT D326 N4**  
 Ref. A-3 Beckton Nebula P P707  
 Beckton Lydia S069 NB < Beckton Lydia P583 WR  
**BECKTON ANGEL D155 E**  
 Beckton Emperor Y459 J3 < Beckton Emperor T641 E2  
 Beckton Indigo S354 JT  
 Beckton Angel U746 CD < Beckton Cody K1 P014  
 Beckton Angel H164 LO

DAM		Calv.Ease	BW	WW	YW	Milk	HPG	Stay	Maint.En.	
Age	5	EPDs	14	-2.6	66	105	26	11	18	6.0
Wt	914	Marb	+.48		REA	-.05		Bfat +.03		
Prog. BW	69	Beef Tenderness→ DNA: 10 / Outstanding Scan: 2.2 / Tender								
WR	105	Wean Pct. 62% Cow Eff. 131 HB 58 GM 22 ProS 80								
YR	97									
Udder	Very Good									

★★★★★ for Growth, Gainability, Marbling, High Cow Efficiency, Calving Ease.

**168 BECKTON LIKABLE J896 D4** 1-A 100% # 4505375 Tat: BKT1 J896 

Birth: 5-6-21  
 Beckton Likable U130 L2 < Beckton Likable S633  
 Beckton Kit S478 LN  
**BECKTON LIKABLE C229 R3**  
 Ref. L-2 Beckton Tamara X447 J < Beckton Roman J S158  
 Beckton Tamara R834 JC  
**BECKTON TAMARA A809 D**  
 Beckton Dominor W640 C5 < Beckton Dominor Z1 R610  
 Beckton Mona R166 CQ  
 Beckton Tamara W579 J < Beckton Justice T124 C1  
 Beckton Tamara S623 RA

DAM		Calv.Ease	BW	WW	YW	Milk	HPG	Stay	Maint.En.	
Age	8	EPDs	16	-2.8	57	99	30	11	16	-2.0
Wt	978	Marb	+.34		REA	+.26		Bfat +.04		
Prog. BW	71	Beef Tenderness→ DNA: 7 / Very Good Scan: 1.8 / Tender								
WR	107	Wean Pct. 51% Cow Eff. 107 HB 60 GM 44 ProS 104								
YR	107									
Udder	Good									

★★★★★ for Low Maintenance, Growth, Gainability, Marbling, Rib-eye area, Superior Cow, Calving Ease.



**169 BECKTON HERITAGE J817 A6** 1-A 100% # 4505881 Tat: BKT1 J817 

Birth: 4-25-21  
 Beckton Heritage B612 J4 < Beckton Heritage X403 L3  
 Beckton Lana N291 JC  
**BECKTON HERITAGE F615 L5**  
 Ref. H-3 Beckton Mona X022 L < Beckton Likable U130 L2  
 Beckton Mona U584 CD  
**BECKTON LARKEISA F132 A**  
 Beckton Accent W180 C2 < Beckton Cody K1 P014  
 Beckton Christy R046 CQ  
 Beckton Larkeisa W687 N < Beckton Nebula T398 V3  
 BKT Larkeisa T525 EP

DAM		Calv.Ease	BW	WW	YW	Milk	HPG	Stay	Maint.En.	
Age	3	EPDs	14	-3.0	64	96	27	9	19	-3.0
Wt	886	Marb	+.43		REA	+.05		Bfat +.04		
Prog. BW	58	Beef Tenderness→ DNA: 9 / Outstanding Scan: NA / NA								
WR	110	Wean Pct. 53% Cow Eff. 111 HB 80 GM 29 ProS 109								
YR	105									
Udder	Very Good									

★★★★★ for Low Maintenance, Growth, Marbling, Superior Cow, Calving Ease.

• Bulls •

**170 BECKTON JULIAN J584 N8**  
1-A 100% # 4505941 Tat: BKT1 J584



Birth: 4-1-21

Beckton Julian D551 C6	Beckton Julian X465 J5	BWt	51
Beckton Indigo D786 L	Beckton Tamara W550 A	WR	93
		YWt.	958
		YR	105
		Feb.ADG	3.92
		Feb.Scr.	31
		Frame	5.0
		Feet	Good

BECKTON JULIAN F067 L7  
Ref. J-5

BECKTON INDIGO F343 N

Beckton Nebula B557 J3	Beckton Nebula P P707	Age	3
Beckton Indigo A745 J	Beckton Larkaba T813 JC	Wt	698
	Beckton Julian X465 J5	Prog. BW	50
	Beckton Indigo W477 E	WR	96
		YR	105
		Udder	Good

Calv.Ease	BW	WW	YW	Milk	HPG	Stay	Maint.En.
EPDs 19	-5.5	56	112	27	11	14	6.0
Marb +.53		REA +.00				Bfat +.04	
Beef Tenderness→	DNA: 7 / Very Good					Scan: NA / NA	
Wean Pct. 59%	Cow Eff. 124	HB 34	GM 79	ProS 113			

★★★★★ for Gainability, Marbling, High Cow Efficiency, Calving Ease.

**173 BECKTON ACCENT J862 C4**  
1-A 100% # 4505775 Tat: BKT1 J862



Birth: 5-2-21

Beckton Accent W180 C2	Beckton Cody K1 P014	BWt	78
Beckton Minerva V654 N	Beckton Christy R046 CQ	WR	100
		YWt.	1038
		YR	109
		Feb.ADG	4.26
		Feb.Scr.	34
		Frame	5.5
		Feet	Good

BECKTON ACCENT B549 N3  
Ref. A-2

BECKTON PINE MARIE E424 C

Beckton Cardinal B074 N	TR Double Eagle ZT220	Age	4
Beckton Pine Marie A074 C	BKT Pine Marie Z250 N	Wt	916
	Beckton Cliffot W692 E3	Prog. BW	75
	BKT Pine Marie X596 N	WR	101
		YR	108
		Udder	Very Good

Calv.Ease	BW	WW	YW	Milk	HPG	Stay	Maint.En.
EPDs 15	-3.4	64	112	23	9	18	7.0
Marb +.39		REA +.21				Bfat +.03	
Beef Tenderness→	DNA: 9 / Outstanding					Scan: 1.8 / Tender	
Wean Pct. 54%	Cow Eff. 114	HB 55	GM 44	ProS 99			

★★★★★ for Growth, Gainability, Marbling, Rib-eye area, Calving Ease.

**171 BECKTON ROOSEVELT J606 E3**  
1-A 100% # 4506003 Tat: BKT1 J606



Birth: 4-2-21

Bieber Roosevelt W384	Bieber Rough Rider 10712	BWt	68
Beckton Lana W277 A	Bieber Sheba 9602	WR	97
		YWt.	950
		YR	104
		Feb.ADG	3.64
		Feb.Scr.	31
		Frame	5.0
		Feet	Good

BECKTON ROOSEVELT D305 C2  
Ref. B-2

BECKTON ROSE F600 E

Beckton Epic B545 N7	Beckton Cody K1 P014	Age	3
Beckton Rose Z419 J	Beckton Lana N869 LO	Wt	962
	Beckton Epic Y484 N6	Prog. BW	69
	Beckton Serena X338 N	WR	97
	Beckton Julian GG B571	YR	99
	Beckton Rose W833 N	Udder	Very Good

Calv.Ease	BW	WW	YW	Milk	HPG	Stay	Maint.En.
EPDs 13	-1.1	60	97	25	11	14	-1.0
Marb +.32		REA +.10				Bfat +.04	
Beef Tenderness→	DNA: 9 / Outstanding					Scan: NA / NA	
Wean Pct. 45%	Cow Eff. 94	HB 40	GM 27	ProS 66			

★★★★★ for Low Maintenance, Gainability, Marbling, Calving Ease.

**174 BECKTON CARDINAL J826 E2**  
1-A 100% # 4505967 Tat: BKT1 J826



Birth: 4-26-21

TR Double Eagle ZT220	TR Ricardo DOS	BWt	70
Beckton Larkaba A911 L	Beckton Lana U182 JC	WR	104
		YWt.	1033
		YR	113
		Feb.ADG	4.15
		Feb.Scr.	32
		Frame	5.0
		Feet	Good

BECKTON CARDINAL E673 L  
Ref. C-2

BECKTON MINERVA F424 E

Beckton Epic B483 N6	Beckton Legend U331 E2	Age	3
Beckton Minerva W901 J	Beckton Larkaba T418 WA	Wt	970
	Beckton Epic U749 D5	Prog. BW	64
	BKT Pine Marie X339 N	WR	108
	Beckton Julian G3 P608	YR	112
	Beckton Minerva L344 CH	Udder	Very Good

Calv.Ease	BW	WW	YW	Milk	HPG	Stay	Maint.En.
EPDs 18	-4.4	60	103	31	12	16	4.0
Marb +.51		REA +.25				Bfat +.03	
Beef Tenderness→	DNA: 9 / Outstanding					Scan: NA / NA	
Wean Pct. 48%	Cow Eff. 101	HB 59	GM 52	ProS 111			

★★★★★ for Growth, Gainability, Marbling, Rib-eye area, Superior Cow, Calving Ease.

**172 BECKTON LIKABLE J835 N4**  
1-A 100% # 4506929 Tat: BSF1 J835



Birth: 4-28-21

Beckton Likable U130 L2	Beckton Likable S633	BWt	87
Beckton Tamara X447 J	Beckton Kit S478 LN	WR	113
		YWt.	1002
		YR	110
		Feb.ADG	3.64
		Feb.Scr.	31
		Frame	5.0
		Feet	Good

BECKTON LIKABLE C229 R3  
Ref. L-2

BECKTON LANA F170 N

Beckton New Era D478 C2	Beckton Roman J S158	Age	3
Beckton Lana D689 L	Beckton Tamara R834 JC	Wt	918
	Beckton New Era Y194	Prog. BW	87
	Beckton Coca X734 C	WR	113
	Beckton Likable U130 L2	YR	110
	Beckton Lana X122 L	Udder	Very Good

Calv.Ease	BW	WW	YW	Milk	HPG	Stay	Maint.En.
EPDs 11	0.3	68	108	26	11	18	-2.0
Marb +.38		REA +.25				Bfat +.04	
Beef Tenderness→	DNA: 10 / Outstanding					Scan: NA / NA	
Wean Pct. 55%	Cow Eff. 116	HB 62	GM 32	ProS 94			

★★★★★ for Low Maintenance, Growth, Gainability, Marbling, Rib-eye area, Superior Cow, High Cow Efficiency.





• Bulls •

**175 BECKTON LIKABLE J243 N4** 1-A 100% # 4506427 Tat: BKT1 J243 

Birth: 3-16-21  
 Beckton Likable U130 L2  
**BECKTON LIKABLE D432 N3**  
 Ref. L-3 Beckton Firefly W013 N  
 Beckton Likable S633  
 Beckton Kit S478 LN  
 Beckton Nebula T054 H3  
 Beckton Firefly T003 JC  
 Beckton Nebula L P093  
 Beckton Minerva J615 VG  
 Beckton Nebula L P093  
 Beckton Belga P119 EP  
 Beckton Nebula T398 V3  
**BECKTON BELGA Y192 N**  
 Beckton Belga S026 NB

BWt	62
WR	94
YWt	895
YR	94
Feb.ADG	3.35
Feb.Scr.	35
Frame	4.5
Feet	Good

DAM	
Age	10
Wt	1134
Prog. BW	70
WR	97
YR	96
Udder	Very Good
Calv.Ease	17
BW	-4.4
WW	52
YW	80
Milk	24
HPG	11
Stay	23
Maint.En.	-7.0
EPDs	
Marb	+0.33
REA	+0.10
Bfat	+0.04
Beef Tenderness→ DNA:	10 / Outstanding
Scan:	2.3 / Tender
Wean Pct.	43%
Cow Eff.	91
HB	108
GM	26
ProS	134

★★★★★ for Low Maintenance, Marbling, Calving Ease.

**177 BECKTON NEBULA J705 L5** 1-A 100% # 4507301 Tat: BKB1 J705 

Birth: 4-11-21  
 Beckton Nebula T398 V3  
**BECKTON NEBULA A773 L4**  
 Ref. N-2 Beckton Mona X022 L  
 Beckton Nebula L P093  
 Beckton Minerva J615 VG  
 Beckton Likable U130 L2  
 Beckton Mona U584 CD  
 Beckton Likable S633  
 Beckton Kit S478 LN  
 Beckton Nebula L P093  
 Beckton Minerva J615 VG  
 Beckton Nebula L P093  
 Beckton Belga P119 EP  
 Beckton Nebula T398 V3  
**BECKTON INDIGO Y406 L**  
 Beckton Indigo R745 WR

BWt	62
WR	110
YWt	919
YR	97
Feb.ADG	3.18
Feb.Scr.	32
Frame	5.0
Feet	Good

DAM	
Age	10
Wt	1070
Prog. BW	65
WR	101
YR	107
Udder	Very Good
Calv.Ease	15
BW	-4.1
WW	58
YW	89
Milk	27
HPG	12
Stay	24
Maint.En.	-2.0
EPDs	
Marb	+0.31
REA	+0.23
Bfat	+0.03
Beef Tenderness→ DNA:	10 / Outstanding
Scan:	2.1 / Tender
Wean Pct.	53%
Cow Eff.	112
HB	110
GM	28
ProS	138

★★★★★ for Low Maintenance, Marbling, Rib-eye area, Calving Ease.



Lot 175

**178 BECKTON LIKABLE J648 N5** 1-A 100% # 4506433 Tat: BKT1 J648 

Birth: 4-5-21  
 Beckton Likable Y124 L3  
**BECKTON LIKABLE F242 D4**  
 Ref. L-5 Beckton Firefly A022 D  
 Beckton Likable U130 L2  
 BKT Pine Marie S802 LO  
 Beckton Dominor W640 C5  
 Beckton Firefly U801 NB  
 Beckton Nebula T398 V3  
 Beckton Nebula L P093  
 Beckton Minerva J615 VG  
 Beckton Minerva Y324 N  
 Beckton Colt K M609  
 Beckton Minerva T864 CK  
 Beckton Minerva M179 LN

BWt	63
WR	104
YWt	914
YR	96
Feb.ADG	2.61
Feb.Scr.	32
Frame	5.0
Feet	Good

DAM	
Age	10
Wt	968
Prog. BW	64
WR	110
YR	105
Udder	Good
Calv.Ease	21
BW	-7.6
WW	49
YW	74
Milk	31
HPG	12
Stay	20
Maint.En.	-3.0
EPDs	
Marb	+0.29
REA	-0.13
Bfat	+0.04
Beef Tenderness→ DNA:	8 / Very Good
Scan:	1.4 / Tender +
Wean Pct.	56%
Cow Eff.	117
HB	91
GM	14
ProS	105

★★★★★ for Low Maintenance, Marbling, Superior Cow, High Cow Efficiency, Calving Ease.

**176 BECKTON LIKABLE J083 L6** 1-A 100% # 4506221 Tat: BKT1 J083 

Birth: 2-26-21  
 Beckton Likable Z057 L4  
**BECKTON LIKABLE G289 J5**  
 Ref. L-8 Beckton Coca B785 J  
 Beckton Likable X445 J3  
 Beckton Minola X107 L  
 Beckton Julian GG B571  
 Beckton Coca X787 N  
 Beckton Likable Z057 L4  
 Beckton Mona Z270 C  
 Beckton Likable B032 C5  
 Beckton Accent Y260 L3  
 Beckton Lana G344 L  
 Beckton Lana C676 A  
 Beckton Lana Z724 A

BWt	58
WR	97
YWt	944
YR	98
Feb.ADG	3.24
Feb.Scr.	35
Frame	5.0
Feet	Good

DAM	
Age	2
Wt	700
Prog. BW	58
WR	97
YR	98
Udder	Very Good
Calv.Ease	16
BW	-4.9
WW	49
YW	86
Milk	24
HPG	13
Stay	17
Maint.En.	-2.0
EPDs	
Marb	+0.51
REA	-0.07
Bfat	+0.04
Beef Tenderness→ DNA:	10 / Outstanding
Scan:	1.7 / Tender
Wean Pct.	62%
Cow Eff.	131
HB	50
GM	47
ProS	97

★★★★★ for Low Maintenance, Marbling, High Cow Efficiency, Calving Ease.

**179 BECKTON SCAMP J703 L6** 1-A 100% # 4505591 Tat: BKT1 J703 

Birth: 4-11-21  
 Beckton Scamp B720 L4  
**BECKTON SCAMP E175 N5**  
 Ref. S-1 Beckton Belga W103 N  
 Beckton Scamp X458 H3  
 Beckton Larkaba Y448 L  
 Beckton Nebula T398 V3  
 Beckton Belga T551 EP  
 Beckton Likable Z057 L4  
 Beckton Likable X445 J3  
 Beckton Minola X107 L  
 Beckton Hasten H S462  
 BKT Larkeisa U535 HS  
 BKT Larkeisa S637 HS

BWt	60
WR	109
YWt	950
YR	100
Feb.ADG	3.07
Feb.Scr.	35
Frame	5.0
Feet	Good

DAM	
Age	5
Wt	1102
Prog. BW	61
WR	92
YR	96
Udder	Very Good
Calv.Ease	19
BW	-6.5
WW	55
YW	97
Milk	23
HPG	9
Stay	16
Maint.En.	6.0
EPDs	
Marb	+0.36
REA	+0.12
Bfat	+0.02
Beef Tenderness→ DNA:	10 / Outstanding
Scan:	1.5 / Tender +
Wean Pct.	51%
Cow Eff.	108
HB	47
GM	42
ProS	89

★★★★★ for Marbling, Calving Ease.

• Bulls •

**180 BECKTON ORACLE J451 L3**  
1-A 100% # 4506089 Tat: BKT1 J451



Birth: 3-23-21

**BECKTON ORACLE G434 A2**  
Ref. O-4

- Schuler Oracle-7142E
- Beckton Larkaba D449 A
- Schuler Sudden Impact 0004X
- Sor Marlee Cmmmtmt 0470X
- Beckton Accent U777 C2
- Beckton Larkaba U475 CT
- Beckton Legend Z689 J3
- Beckton Ucola X143 L
- Beckton Legend E464 L4
- Beckton Ucola X143 L
- Beckton Julian C226 E7
- Beckton Belga E574 J
- Beckton Belga C183 J

BWt	57
WR	107
YWt.	964
YR	100
Feb.ADG	3.30
Feb.Scr.	33
Frame	5.0
Feet	Good

DAM											
Age	2	Calv.Ease	BW	WW	YW	Milk	HPG	Stay	Maint.En.		
Wt	712	EPDs	19	-5.8	53	87	29	11	17	2.0	
Prog. BW	57	Marb	+.58		REA	-.02		Bfat	+.04		
WR	107	Beef Tenderness→ DNA:	10 / Outstanding		Scan:	1.8 / Tender					
YR	100	Wean Pct.	68%	Cow Eff.	143	HB	60	GM	41	ProS	101
Udder	Very Good										

★★★★★ for Marbling, High Cow Efficiency, Calving Ease.

**183 BECKTON LIKABLE J152 W6**  
1-A 100% # 4506275 Tat: BKT1 J152



Birth: 3-8-21

**BECKTON LIKABLE G026 L5**  
Ref. L-7

- Beckton Likable E391 N4
- Beckton Angel E130 L
- Beckton Lana X466 N
- Beckton Likable C584 E4
- Beckton Angel C816 L
- Beckton Warrior Y108 E5
- Beckton Lana W463 L
- Beckton Warrior D359 L6
- Beckton Rose C414 A
- Beckton Rose W656 E

BWt	59
WR	102
YWt.	962
YR	100
Feb.ADG	3.52
Feb.Scr.	31
Frame	5.5
Feet	Good

DAM											
Age	2	Calv.Ease	BW	WW	YW	Milk	HPG	Stay	Maint.En.		
Wt	822	EPDs	17	-4.8	59	96	29	10	16	5.0	
Prog. BW	59	Marb	+.40		REA	-.06		Bfat	+.04		
WR	102	Beef Tenderness→ DNA:	9 / Outstanding		Scan:	3.0 / Tender					
YR	100	Wean Pct.	56%	Cow Eff.	118	HB	47	GM	35	ProS	82
Udder	Good										

★★★★★ for Gainability, Marbling, High Cow Efficiency, Calving Ease.

**181 BECKTON LIKABLE J197 L5**  
1-A 100% # 4506017 Tat: BKT1 J197



Birth: 3-12-21

**BECKTON LIKABLE G403 N4**  
Ref. L-9

- Beckton Likable C229 R3
- Beckton Minerva Y385 N
- Beckton Likable U130 L2
- Beckton Tamara X447 J
- Beckton Nebula T398 V3
- Beckton Minerva U310 L0
- Beckton Likable U130 L2
- Beckton Minola X107 L
- Beckton Likable C643 L3
- Beckton Nebula P P707
- Beckton Kit A595 N
- Beckton Kit X237 L

BWt	57
WR	100
YWt.	949
YR	97
Feb.ADG	3.41
Feb.Scr.	32
Frame	5.0
Feet	Good

DAM											
Age	3	Calv.Ease	BW	WW	YW	Milk	HPG	Stay	Maint.En.		
Wt	836	EPDs	18	-5.3	49	80	30	10	21	-6.0	
Prog. BW	55	Marb	+.46		REA	+.18		Bfat	+.04		
WR	100	Beef Tenderness→ DNA:	9 / Outstanding		Scan:	2.0 / Tender					
YR	97	Wean Pct.	52%	Cow Eff.	109	HB	90	GM	41	ProS	131
Udder	NA										

★★★★★ for Low Maintenance, Marbling, Rib-eye area, Calving Ease.

**184 BECKTON HERITAGE J329 D5**  
1-A 100% # 4506619 Tat: BSF1 J329



Birth: 3-19-21

**BECKTON HERITAGE C477 J4**  
Ref. H-2

- Beckton Heritage X403 L3
- Beckton Ruth Z858 J
- Beckton Heritage T270 J2
- Beckton Indigo H150 LN
- Beckton Julian U699 L5
- Beckton Ruth U557 JT
- Beckton Dominor W640 C5
- Beckton Minerva U313 NB
- Beckton Dominor Z1 R610
- Beckton Mona R166 CQ
- Beckton Nebula PJ S543
- Beckton Minerva S839 HW

BWt	64
WR	98
YWt.	913
YR	96
Feb.ADG	2.84
Feb.Scr.	34
Frame	4.5
Feet	Good

DAM											
Age	8	Calv.Ease	BW	WW	YW	Milk	HPG	Stay	Maint.En.		
Wt	1208	EPDs	16	-3.4	55	86	27	13	16	2.0	
Prog. BW	69	Marb	+.41		REA	+.04		Bfat	+.04		
WR	102	Beef Tenderness→ DNA:	10 / Outstanding		Scan:	2.4 / Tender					
YR	99	Wean Pct.	42%	Cow Eff.	89	HB	62	GM	37	ProS	99
Udder	Very Good										

★★★★★ for Marbling, Calving Ease.

**182 BECKTON SCAMP J406 N6**  
1-A 100% # 4505483 Tat: BKT1 J406



Birth: 3-22-21

**BECKTON SCAMP E175 N5**  
Ref. S-1

- Beckton Scamp B720 L4
- Beckton Belga W103 N
- Beckton Scamp X458 H3
- Beckton Larkaba Y448 L
- Beckton Nebula T398 V3
- Beckton Belga T551 EP
- Beckton Nebula U206 V3
- Beckton Tamara U185 NB
- Beckton Nebula X096 N4
- Beckton Cherokee N N479
- Beckton Eola U562 CQ
- Beckton Eola R030 JJ

BWt	68
WR	92
YWt.	925
YR	98
Feb.ADG	3.35
Feb.Scr.	37
Frame	5.0
Feet	Good

DAM											
Age	6	Calv.Ease	BW	WW	YW	Milk	HPG	Stay	Maint.En.		
Wt	1126	EPDs	15	-4.6	51	88	26	11	19	2.0	
Prog. BW	66	Marb	+.32		REA	-.02		Bfat	+.03		
WR	100	Beef Tenderness→ DNA:	9 / Outstanding		Scan:	1.6 / Tender +					
YR	99	Wean Pct.	43%	Cow Eff.	90	HB	61	GM	32	ProS	93
Udder	Very Good										

★★★★★ for Marbling, Calving Ease.



Lot 182

• Bulls •

**185 BECKTON ORACLE J654 N2**  
1-A 100% # 4505485 Tat: BKT1 J654



Birth: 4-6-21  
 Schuler Sudden Impact 0004X < Red Crowfoot Ole's Oscar  
 SOR Duchess TS 8915U  
**SCHULER ORACLE-7142E**  
 Ref. O-1 Sor Marlee Cmmtmnt 0470X < Brown Commitment S7206  
 SOR Marlee Beef 4511P  
 Beckton Nebula A394 C5 < Beckton Nebula W778 J4  
 Beckton Lana T104 CT  
**BECKTON FIREFLY C265 N**  
 Beckton Firefly A402 D < Beckton Dominor Y052 N6  
 Beckton Firefly Y376 N

DAM		Calv.Ease	BW	WW	YW	Milk	HPG	Stay	Maint.En.	
Age	6	EPDs	19	-5.5	58	93	25	11	18	1.0
Wt	964	Marb	+.58		REA	+.19		Bfat		+.02
Prog. BW	60	Beef Tenderness → DNA: 9 / Outstanding Scan: 2.3 / Tender								
WR	108	Wean Pct. 56% Cow Eff. 118 HB 74 GM 51 ProS 125								
YR	101									
Udder	Good									

★★★★★ for Marbling, Rib-eye area, High Cow Efficiency, Calving Ease.

**187 BECKTON HERITAGE J369 A6**  
1-A 100% # 4506853 Tat: BSF1 J369



Birth: 3-20-21  
 Beckton Heritage B612 J4 < Beckton Heritage X403 L3  
 Beckton Lana N291 JC  
**BECKTON HERITAGE F615 L5**  
 Ref. H-3 Beckton Mona X022 L < Beckton Likable U130 L2  
 Beckton Mona U584 CD  
 Beckton Accent B653 C3 < Beckton Accent U777 C2  
 Beckton Christy W779 C  
**BECKTON LANA D309 A**  
 Beckton Lana W518 N < Beckton Nebula EN S347  
 Beckton Lana P073 EP

DAM		Calv.Ease	BW	WW	YW	Milk	HPG	Stay	Maint.En.	
Age	4	EPDs	13	-4.2	55	83	32	10	17	-3.0
Wt	858	Marb	+.46		REA	-.07		Bfat		+.04
Prog. BW	63	Beef Tenderness → DNA: 9 / Outstanding Scan: 2.3 / Tender								
WR	103	Wean Pct. 57% Cow Eff. 119 HB 64 GM 32 ProS 96								
YR	102									
Udder	Very Good									

★★★★★ for Low Maintenance, Marbling, High Cow Efficiency, Calving Ease.

**186 BECKTON DOMINOR J171 C10**  
1-A 100% # 4506991 Tat: BSF1 J171



Birth: 3-10-21  
 Beckton Dominor D254 N8 < Beckton Dominor A378 W7  
 Beckton Indigo W772 N  
**BECKTON DOMINOR G402 A9**  
 Ref. D-3 Beckton Lana D273 A < Beckton Accent B549 N3  
 Beckton Lana B666 S  
 Beckton Clifftop D059 C5 < Beckton Clifftop B848 J4  
 Beckton Larkaba B565 C  
**BECKTON BELGA F617 C**  
 Beckton Belga D833 A < Beckton Accent Y260 L3  
 Beckton Belga Z031 N

DAM		Calv.Ease	BW	WW	YW	Milk	HPG	Stay	Maint.En.	
Age	3	EPDs	18	-5.8	53	87	28	10	18	-1.0
Wt	874	Marb	+.43		REA	+.05		Bfat		+.04
Prog. BW	55	Beef Tenderness → DNA: 10 / Outstanding Scan: 1.7 / Tender								
WR	103	Wean Pct. 53% Cow Eff. 111 HB 65 GM 36 ProS 101								
YR	101									
Udder	Very Good									

★★★★★ for Low Maintenance, Marbling, Calving Ease.



Lot 187



Lot 186

**188 BECKTON DOMINOR J379 E9**  
1-A 100% # 4505845 Tat: BKT1 J379



Birth: 3-21-21  
 Beckton Dominor A378 W7 < Beckton Dominor Y005 V6  
 Beckton Lana Y541 W  
**BECKTON DOMINOR D254 N8**  
 Ref. D-1 Beckton Indigo W772 N < Beckton Nebula T398 V3  
 Beckton Indigo T613 JT  
 Beckton Epic D002 E8 < Beckton Epic B545 N7  
 Beckton Christy B701 E  
**BECKTON LANA F006 E**  
 Beckton Lana D003 R < Beckton Ranger B006 D5  
 Beckton Lana B028 R

DAM		Calv.Ease	BW	WW	YW	Milk	HPG	Stay	Maint.En.	
Age	3	EPDs	17	-3.4	53	93	32	11	17	3.0
Wt	802	Marb	+.43		REA	+.20		Bfat		+.04
Prog. BW	70	Beef Tenderness → DNA: 9 / Outstanding Scan: 1.6 / Tender +								
WR	104	Wean Pct. 55% Cow Eff. 115 HB 64 GM 46 ProS 109								
YR	106									
Udder	Very Good									

★★★★★ for Gainability, Marbling, Rib-eye area, Superior Cow, Calving Ease.

• Bulls •

**189 BSF CARDINAL J684 A2** 1-B 99% # 4506937 Tat: BSF1 J684 

Birth: 4-9-21

TR Double Eagle ZT220  
Beckton Lana U182 JC  
Beckton Legend U331 E2  
Beckton Larkaba T418 WA  
Beckton Cody K1 P014  
Beckton Christy R046 CQ  
Beckton Julian W743 H5  
BSF Lanette W106 N

**BECKTON CARDINAL E673 L**  
Ref. C-2  
Beckton Larkaba A911 L

**BSF LANETTE F260 A**  
Beckton Accent W180 C2  
BSF Lanette Y054 J

BWt	64
WR	112
YWt	972
YR	106
Feb.ADG	3.58
Feb.Scr.	32
Frame	5.0
Feet	Good

DAM										
Age	3	Calv.Ease	BW	WW	YW	Milk	HPG	Stay	Maint.En.	
Wt	864	EPDs	18	-4.4	68	108	29	12	20	5.0
Prog. BW	66	Marb	+.47		REA	+.32		Bfat		+.03
WR	114	Beef Tenderness	→		DNA: 6 / Average	Scan: 1.3 / Tender +				
YR	108	Wean Pct.	58%	Cow Eff.	122	HB	83	GM	44	ProS 128
Udder	Fair									

**191 BECKTON HERITAGE J524 D6** 1-A 100% # 4506039 Tat: BKT1 J524 

Birth: 3-28-21

Beckton Heritage B612 J4  
Beckton Lana N291 JC  
Beckton Likable U130 L2  
Beckton Mona X022 L  
Beckton Dominor D495 W8  
Beckton Encino X642 W  
Beckton Accent Y260 L3  
Beckton Susan Y223 A

**BECKTON HERITAGE F615 L5**  
Ref. H-3

**BECKTON SUSAN F762 D**  
Beckton Susan D408 A

BWt	63
WR	102
YWt	919
YR	101
Feb.ADG	3.47
Feb.Scr.	34
Frame	5.0
Feet	Good

DAM										
Age	3	Calv.Ease	BW	WW	YW	Milk	HPG	Stay	Maint.En.	
Wt	1084	EPDs	14	-3.7	58	89	27	10	19	-4.0
Prog. BW	56	Marb	+.50		REA	+.00		Bfat		+.04
WR	102	Beef Tenderness	→		DNA: 9 / Outstanding	Scan: 1.8 / Tender				
YR	102	Wean Pct.	42%	Cow Eff.	89	HB	79	GM	36	ProS 115
Udder	NA									

★★★★★ for Growth, Gainability, Marbling, Rib-eye area, Superior Cow, High Cow Efficiency, Calving Ease.

★★★★★ for Low Maintenance, Marbling, Calving Ease.

**190 BECKTON ORACLE J708 E3** 1-A 100% # 4506961 Tat: BSF1 J708 

Birth: 4-11-21

Schuler Oracle-7142E  
Sor Marlee Cmmtrnt 0470X  
Beckton Accent U777 C2  
Beckton Larkaba D449 A  
Beckton Larkaba U475 CT  
Beckton Epic U749 D5  
BKT Pine Marie X339 N  
Beckton Accent W180 C2  
Beckton Indigo W419 J

**BECKTON ORACLE G434 A2**  
Ref. O-4

**BECKTON INDIGO F449 E**  
Beckton Epic B483 N6  
Beckton Indigo Y041 A

BWt	62
WR	113
YWt	1002
YR	110
Feb.ADG	3.01
Feb.Scr.	35
Frame	5.0
Feet	Good

DAM										
Age	3	Calv.Ease	BW	WW	YW	Milk	HPG	Stay	Maint.En.	
Wt	884	EPDs	17	-5.9	54	96	31	12	16	6.0
Prog. BW	59	Marb	+.61		REA	+.01		Bfat		+.04
WR	113	Beef Tenderness	→		DNA: 10 / Outstanding	Scan: 1.5 / Tender +				
YR	110	Wean Pct.	58%	Cow Eff.	121	HB	55	GM	58	ProS 113
Udder	Very Good									

★★★★★ for Growth, Marbling, Superior Cow, High Cow Efficiency, Calving Ease.

**192 BSF DOMINOR J611 A9** 1-B 99% # 4506965 Tat: BSF1 J611 

Birth: 4-2-21

Beckton Dominor A378 W7  
Beckton Lana Y541 W  
Beckton Nebula T398 V3  
Beckton Indigo W772 N  
Beckton Indigo T613 JT  
Beckton Accent W180 C2  
Beckton Minerva Y654 N  
Beckton Lancer T1 H080  
BSF Regus B368

**BECKTON DOMINOR D254 N8**  
Ref. D-1

**BSF LANETTE F457 A**  
Beckton Accent B549 N3  
BSF Lanette P497

BWt	50
WR	103
YWt	964
YR	105
Feb.ADG	3.35
Feb.Scr.	34
Frame	5.0
Feet	Good

DAM										
Age	3	Calv.Ease	BW	WW	YW	Milk	HPG	Stay	Maint.En.	
Wt	866	EPDs	18	-4.8	56	98	29	12	18	5.0
Prog. BW	61	Marb	+.41		REA	+.11		Bfat		+.03
WR	97	Beef Tenderness	→		DNA: 7 / Very Good	Scan: 1.9 / Tender				
YR	102	Wean Pct.	53%	Cow Eff.	112	HB	55	GM	49	ProS 104
Udder	Very Good									

★★★★★ for Growth, Marbling, Calving Ease.



Lot 190

**193 BSF DOMINOR J119 C9** 1-B 99% # 4507297 Tat: BKB1 J119 

Birth: 3-4-21

Beckton Dominor A378 W7  
Beckton Lana Y541 W  
Beckton Nebula EN S347  
Beckton Rose W816 C  
Beckton Clifftop C572 N5  
Beckton Clifftop Y012 C4  
BKT Pine Marie U454 NB  
Beckton Likable U130 L2  
BSF Julianne Y053 L

**BECKTON DOMINOR G461 N8**  
Ref. D-4

**BSF JULIANNE G697 C**  
Beckton Clifftop C572 N5  
BSF Julianne B385 L

BWt	54
WR	88
YWt	922
YR	96
Feb.ADG	3.98
Feb.Scr.	32
Frame	5.0
Feet	Good

DAM										
Age	2	Calv.Ease	BW	WW	YW	Milk	HPG	Stay	Maint.En.	
Wt	715	EPDs	16	-3.3	53	87	30	11	15	-2.0
Prog. BW	54	Marb	+.44		REA	+.08		Bfat		+.04
WR	88	Beef Tenderness	→		DNA: 6 / Average	Scan: 2.2 / Tender				
YR	96	Wean Pct.	54%	Cow Eff.	114	HB	59	GM	39	ProS 98
Udder	Good									

★★★★★ for Low Maintenance, Gainability, Marbling, Calving Ease.

• Bulls •

**194 BECKTON ACCENT J542 H5**  
1-A 100% # 4506095 Tat: BKT1 J542



Birth: 3-29-21  
 Beckton Accent E172 L3  
**BECKTON ACCENT G107 C4**  
 Ref. A-6  
 Beckton Pine Marie E206 D  
 Beckton Hughes E090 H3  
**BECKTON LANA G052 H**  
 Beckton Lana E357 H

Beckton Accent W180 C2  
 Beckton Indigo Y406 L  
 TR Double Eagle ZT220  
 BKT Pine Marie W404 J  
 Beckton Hughes C350 N2  
 Beckton Rose C258 H  
 Beckton Heritage C477 J4  
 Beckton Lana C256 A

DAM		Calv.Ease	BW	WW	YW	Milk	HPG	Stay	Maint.En.
Age	2	EPDs	19	-4.7	61	99	27	11	19
Wt	682	Marb	+.34		REA	+.21		Bfat	+.04
Prog. BW	58	Beef Tenderness	→ DNA: 7 / Very Good		Scan:	2.1 / Tender			
WR	97	Wean Pct.	64%		Cow Eff.	134		HB	84
YR	104				GM	31		ProS	115
Udder	Very Good								

★★★★★ for Gainability, Marbling, Rib-eye area, High Cow Efficiency, Calving Ease.

**196 BECKTON CARDINAL J640 E2**  
1-A 100% # 4505915 Tat: BKT1 J640



Birth: 4-5-21  
 TR Double Eagle ZT220  
**BECKTON CARDINAL E673 L**  
 Ref. C-2  
 Beckton Larkaba A911 L  
 Beckton Epic B545 N7  
**BECKTON LANA F259 E**  
 Beckton Lana Y024 N

TR Ricardo DOS  
 Beckton Lana U182 JC  
 Beckton Legend U331 E2  
 Beckton Larkaba T418 WA  
 Beckton Epic Y484 N6  
 Beckton Serena X338 N  
 Beckton Nebula W065 C3  
 Beckton Lana W277 A

DAM		Calv.Ease	BW	WW	YW	Milk	HPG	Stay	Maint.En.
Age	3	EPDs	21	-5.7	60	96	32	12	17
Wt	972	Marb	+.41		REA	+.29		Bfat	+.02
Prog. BW	59	Beef Tenderness	→ DNA: 9 / Outstanding		Scan:	2.0 / Tender			
WR	109	Wean Pct.	51%		Cow Eff.	108		HB	63
YR	109				GM	35		ProS	98
Udder	Very Good								

★★★★★ for Marbling, Rib-eye area, Superior Cow, Calving Ease.

**195 BECKTON NEBULA J694 A5**  
1-A 100% # 4505559 Tat: BKT1 J694



Birth: 4-9-21  
 Beckton Nebula B557 J3  
**BECKTON NEBULA F440 H4**  
 Ref. N-4  
 Beckton Minola X638 H  
 Beckton Accent B653 C3  
**BECKTON TAMARA D073 A**  
 Beckton Tamara B592 J

Beckton Nebula P P707  
 Beckton Larkaba T813 JC  
 Beckton Hasten H S462  
 Beckton Minola N751 JL  
 Beckton Accent U777 C2  
 Beckton Christy W779 C  
 Beckton Julian GG B571  
 Beckton Tamara W232 J

DAM		Calv.Ease	BW	WW	YW	Milk	HPG	Stay	Maint.En.
Age	5	EPDs	15	-4.3	51	85	25	12	17
Wt	774	Marb	+.43		REA	-.07		Bfat	+.03
Prog. BW	64	Beef Tenderness	→ DNA: 9 / Outstanding		Scan:	2.1 / Tender			
WR	92	Wean Pct.	62%		Cow Eff.	130		HB	60
YR	96				GM	41		ProS	101
Udder	Very Good								

★★★★★ for Low Maintenance, Gainability, Marbling, High Cow Efficiency, Calving Ease.

**197 BECKTON ACCENT J321 A6**  
1-A 100% # 4506637 Tat: BSF1 J321



Birth: 3-18-21  
 Beckton Accent B150 N4  
**BECKTON ACCENT F177 L5**  
 Ref. A-5  
 Beckton Vernice C782 L  
 Beckton Accent W180 C2  
**BECKTON TARA B169 A**  
 Beckton Tara U666 CT

Beckton Accent Y260 L3  
 BKT Larkeisa S055 NB  
 Beckton Likable Y124 L3  
 Beckton Vernice X754 L  
 Beckton Cody K1 P014  
 Beckton Christy R046 CQ  
 BKT Clifftop TP R288  
 Beckton Tara R609 JC

DAM		Calv.Ease	BW	WW	YW	Milk	HPG	Stay	Maint.En.
Age	7	EPDs	21	-7.3	45	71	29	12	20
Wt	1170	Marb	+.48		REA	-.08		Bfat	+.05
Prog. BW	47	Beef Tenderness	→ DNA: 9 / Outstanding		Scan:	2.1 / Tender			
WR	95	Wean Pct.	38%		Cow Eff.	81		HB	85
YR	98				GM	31		ProS	116
Udder	NA								

★★★★★ for Low Maintenance, Marbling, Calving Ease.



Lot 195

**198 BECKTON NEBULA J408 D5**  
1-A 100% # 4505891 Tat: BKT1 J408



Birth: 3-22-21  
 Beckton Nebula B557 J3  
**BECKTON NEBULA G249 N4**  
 Ref. N-5  
 Beckton Lana Y130 N  
 Beckton Dominor D254 N8  
**BECKTON TAMARA F190 D**  
 Beckton Tamara D534 L

Beckton Nebula P P707  
 Beckton Larkaba T813 JC  
 Beckton Nebula W022 D3  
 Beckton Lana W525 D  
 Beckton Dominor A378 W7  
 Beckton Indigo W772 N  
 Beckton Likable Z057 L4  
 Beckton Tamara A428 N

DAM		Calv.Ease	BW	WW	YW	Milk	HPG	Stay	Maint.En.
Age	3	EPDs	19	-7.1	50	89	31	11	17
Wt	920	Marb	+.55		REA	+.04		Bfat	+.04
Prog. BW	47	Beef Tenderness	→ DNA: 9 / Outstanding		Scan:	2.0 / Tender			
WR	100	Wean Pct.	48%		Cow Eff.	101		HB	61
YR	102				GM	59		ProS	120
Udder	Good								

★★★★★ for Marbling, Calving Ease.

• Bulls •

**199 BECKTON ACCENT J429 E5** 1-A 100% # 4505885 Tat: BKT1 J429 

Birth: 3-23-21  
 Beckton Accent W180 C2  
 Beckton Lana W463 L  
**BECKTON ACCENT D326 N4**  
 Ref. A-3 Beckton Lydia S069 NB  
 Beckton Nebula P P707  
 Beckton Lydia P583 WR  
**BECKTON SCARLETT F167 E**  
 Beckton Epic D344 N7  
 Beckton Epic Z674 E6  
 Beckton Larkaba Y083 N  
 Beckton Epic Y484 N6  
 Beckton Scarlett W497 J

DAM		Calv.Ease	BW	WW	YW	Milk	HPG	Stay	Maint.En.	
Age	3	EPDs	14	-3.8	63	103	29	11	15	2.0
Wt	930	Marb	+.44		REA	-.03		Bfat +.04		
Prog. BW	60	Beef Tenderness→ DNA: 9 / Outstanding Scan: 2.6 / Tender -								
WR	105	Wean Pct. 52% Cow Eff. 109 HB 26 GM 29 ProS 55								
YR	106									
Udder	Very Good									

★★★★★ for Growth, Gainability, Marbling, Superior Cow, Calving Ease.

**201 BECKTON NEBULA J857 L5** 1-A 100% # 4505969 Tat: BKT1 J857 

Birth: 5-1-21  
 Beckton Nebula T398 V3  
 Beckton Minerva J615 VG  
**BECKTON NEBULA A773 L4**  
 Ref. N-2 Beckton Mona X022 L  
 Beckton Likable U130 L2  
 Beckton Mona U584 CD  
**BECKTON CHRISTY F429 L**  
 Beckton Likable B509 J3  
 Beckton Likable U130 L2  
 Beckton Coca T363 JL  
 Beckton Nebula P P707  
 Beckton Christy B401 N  
 Beckton Christy T444 JL

DAM		Calv.Ease	BW	WW	YW	Milk	HPG	Stay	Maint.En.	
Age	3	EPDs	12	-1.8	65	106	27	11	20	0.0
Wt	844	Marb	+.33		REA	+.12		Bfat +.03		
Prog. BW	66	Beef Tenderness→ DNA: 10 / Outstanding Scan: 3.0 / Tender -								
WR	97	Wean Pct. 52% Cow Eff. 109 HB 86 GM 42 ProS 128								
YR	102									
Udder	Very Good									

★★★★★ for Low Maintenance, Growth, Gainability, Marbling, Calving Ease.

**200 BECKTON ORACLE J615 A2** 1-A 100% # 4505337 Tat: BKT1 J615 

Birth: 4-3-21  
 Schuler Sudden Impact 0004X  
 Red Crowfoot Ole's Oscar  
 SOR Duchess TS 8915U  
**SCHULER ORACLE-7142E**  
 Ref. O-1 Sor Marlee Cmmmtmt 0470X  
 Brown Commitment S7206  
 SOR Marlee Beef 4511P  
**BECKTON VERNICE A176 A**  
 Beckton Accent U777 C2  
 Beckton Cody K1 P014  
 Beckton Susan R022 CQ  
 Beckton Lancer TZ D525  
 Beckton Vernice G373 WR

DAM		Calv.Ease	BW	WW	YW	Milk	HPG	Stay	Maint.En.	
Age	8	EPDs	22	-7.3	46	81	26	12	17	-2.0
Wt	928	Marb	+.56		REA	+.17		Bfat +.02		
Prog. BW	58	Beef Tenderness→ DNA: 10 / Outstanding Scan: 2.0 / Tender								
WR	98	Wean Pct. 51% Cow Eff. 107 HB 71 GM 60 ProS 131								
YR	101									
Udder	Good									

★★★★★ for Low Maintenance, Marbling, Rib-eye area, Calving Ease.

**202 BECKTON DOMINOR J879 E9** 1-A 100% # 4506787 Tat: BSF1 J879 

Birth: 5-4-21  
 Beckton Dominor A378 W7  
 Beckton Dominor Y005 V6  
 Beckton Lana Y541 W  
**BECKTON DOMINOR F263 N8**  
 Ref. D-2 Beckton Larkaba W272 N  
 Beckton Nebula EN S347  
 Beckton Larkaba N643 HR  
**BECKTON LARKABEL D573 E**  
 Beckton Epic Z674 E6  
 Beckton Epic U749 D5  
 Beckton Indigo U504 EP  
 Beckton New Era Y194  
 Beckton Larkabel A361 N  
 Beckton Larkabel X676 N

DAM		Calv.Ease	BW	WW	YW	Milk	HPG	Stay	Maint.En.	
Age	5	EPDs	16	-2.1	58	93	31	13	16	1.0
Wt	890	Marb	+.39		REA	+.04		Bfat +.04		
Prog. BW	64	Beef Tenderness→ DNA: 9 / Outstanding Scan: 2.6 / Tender -								
WR	104	Wean Pct. 59% Cow Eff. 123 HB 60 GM 29 ProS 88								
YR	104									
Udder	Good									

★★★★★ for Marbling, Superior Cow, High Cow Efficiency, Calving Ease.



**203 BECKTON ACCENT J850 E5** 1-A 100% # 4505741 Tat: BKT1 J850 

Birth: 4-30-21  
 Beckton Accent Y260 L3  
 Beckton Accent W180 C2  
 Beckton Lana W463 L  
**BECKTON ACCENT D326 N4**  
 Ref. A-3 Beckton Lydia S069 NB  
 Beckton Nebula P P707  
 Beckton Lydia P583 WR  
**BECKTON FIREFLY E275 E**  
 Beckton Epic B376 N6  
 Beckton Epic U749 D5  
 Beckton Tamara U185 NB  
 Beckton Nebula T054 H3  
 Beckton Firefly T003 JC

DAM		Calv.Ease	BW	WW	YW	Milk	HPG	Stay	Maint.En.	
Age	4	EPDs	17	-3.9	57	93	24	12	19	-5.0
Wt	934	Marb	+.43		REA	-.01		Bfat +.04		
Prog. BW	60	Beef Tenderness→ DNA: 7 / Very Good Scan: NA / NA								
WR	92	Wean Pct. 52% Cow Eff. 110 HB 70 GM 33 ProS 103								
YR	95									
Udder	Very Good									

★★★★★ for Low Maintenance, Marbling, Calving Ease.

• Bulls •

**204 BECKTON DOMINOR J769 E10** 1-A 100% # 4506061 Tat: BKT1 J769 

Birth: 4-18-21

Beckton Dominor D254 N8	Beckton Indigo W772 N	BWt	67
Beckton Dominor A378 W7	Beckton Accent B549 N3	WR	94
Beckton Lana D273 A	Beckton Lana B666 S	YWt.	941
	Beckton Epic B545 N7	YR	103
Beckton Epic D002 E8	Beckton Christy B701 E	Feb.ADG	3.92
Beckton COCA F901 E	Beckton Likable B509 J3	Feb.Scr.	32
Beckton Coca D036 L	Beckton Coca B118 C	Frame	5.0
		Feet	Good

<b>DAM</b>	Age	3	Calv.Ease	BW	WW	YW	Milk	HPG	Stay	Maint.En.		
	Wt	908	EPDs	16	-3.7	56	98	27	12	16	3.0	
	Prog. BW	67	Marb	+.37		REA	+.24		Bfat	+.03		
	WR	94	Beef Tenderness	→ DNA: 10 / Outstanding				Scan:	NA / NA			
	YR	103	Wean Pct.	46%	Cow Eff.	96	HB	59	GM	43	ProS	102
	Udder	Good										

★★★★★ for Gainability, Marbling, Rib-eye area, Calving Ease.

**207 BECKTON DOMINOR J911 L10** 1-A 100% # 4506805 Tat: BSF1 J911 

Birth: 5-10-21

Beckton Dominor D254 N8	Beckton Indigo W772 N	BWt	69
Beckton Dominor A378 W7	Beckton Accent B549 N3	WR	107
Beckton Lana D273 A	Beckton Lana B666 S	YWt.	953
	Beckton Epic B545 N7	YR	100
Beckton Likable Z057 L4	Beckton Likable X445 J3	Feb.ADG	3.13
Beckton INDIGO D691 L	Beckton Minola X107 L	Feb.Scr.	35
Beckton Indigo Y343 N	Beckton Nebula T398 V3	Frame	5.0
	Beckton Indigo H150 LN	Feet	Good

<b>DAM</b>	Age	5	Calv.Ease	BW	WW	YW	Milk	HPG	Stay	Maint.En.		
	Wt	1012	EPDs	18	-5.9	52	89	27	12	19	2.0	
	Prog. BW	63	Marb	+.39		REA	+.11		Bfat	+.03		
	WR	99	Beef Tenderness	→ DNA: 10 / Outstanding				Scan:	2.5 / Tender			
	YR	101	Wean Pct.	55%	Cow Eff.	115	HB	70	GM	38	ProS	108
	Udder	Very Good										

★★★★★ for Marbling, Calving Ease.

**205 BECKTON ORACLE J874 A2** 1-A 100% # 4505677 Tat: BKT1 J874 

Birth: 5-3-21

Schuler Sudden Impact 0004X	Red Crowfoot Ole's Oscar	BWt	66
SOR Duchess TS 8915U	Brown Commitment S7206	WR	101
Sor Marlee Cmmtmt 0470X	SOR Marlee Beef 4511P	YWt.	929
	Beckton Cody K1 P014	YR	98
Beckton Accent U777 C2	Beckton Susan R022 CQ	Feb.ADG	3.41
Beckton ANNIE D717 A	Beckton Justice C2 R695	Feb.Scr.	34
Beckton Annie T016 JC	Beckton Annie R650 DM	Frame	5.0
		Feet	Good

<b>DAM</b>	Age	5	Calv.Ease	BW	WW	YW	Milk	HPG	Stay	Maint.En.		
	Wt	1100	EPDs	20	-5.4	53	91	28	11	18	0.0	
	Prog. BW	72	Marb	+.65		REA	+.14		Bfat	+.02		
	WR	105	Beef Tenderness	→ DNA: 7 / Very Good				Scan:	2.4 / Tender			
	YR	109	Wean Pct.	48%	Cow Eff.	100	HB	76	GM	61	ProS	137
	Udder	Very Good										

★★★★★ for Low Maintenance, Marbling, Rib-eye area, Superior Cow, Calving Ease.

**208 BECKTON ROOSEVELT J868 A3** 1-A 100% # 4506429 Tat: BKT1 J868 

Birth: 5-2-21

Bieber Roosevelt W384	Bieber Rough Rider 10712	BWt	66
Bieber Sheba 9602	Beckton Cody K1 P014	WR	97
Beckton Lana W277 A	Beckton Lana N869 LO	YWt.	950
	Beckton Cody K1 P014	YR	97
Beckton Accent W180 C2	Beckton Christy R046 CQ	Feb.ADG	3.18
Beckton MAIATA Y201 A	Beckton Julian G3 P608	Feb.Scr.	31
Beckton Maiata W189 J	Beckton Maiata P892 JL	Frame	5.0
		Feet	Good

<b>DAM</b>	Age	10	Calv.Ease	BW	WW	YW	Milk	HPG	Stay	Maint.En.		
	Wt	900	EPDs	17	-3.4	52	76	28	12	19	-5.0	
	Prog. BW	66	Marb	+.39		REA	-.03		Bfat	+.04		
	WR	101	Beef Tenderness	→ DNA: 9 / Outstanding				Scan:	3.5 / Tender -			
	YR	99	Wean Pct.	51%	Cow Eff.	108	HB	85	GM	16	ProS	102
	Udder	Very Good										

★★★★★ for Low Maintenance, Marbling, Calving Ease.

**206 BSF ORACLE J582 A2** 1-B 99% # 4507391 Tat: BSF1 J582 

Birth: 4-1-21

Schuler Sudden Impact 0004X	Red Crowfoot Ole's Oscar	BWt	57
SOR Duchess TS 8915U	Brown Commitment S7206	WR	95
Sor Marlee Cmmtmt 0470X	SOR Marlee Beef 4511P	YWt.	954
	Beckton Accent W180 C2	YR	104
Beckton Accent D806 W3	Beckton Coca A907 W	Feb.ADG	3.58
BSF JUSTICIA F438 A	Beckton Likable Z057 L4	Feb.Scr.	30
BSF Justicia D627 L	BSF Justicia A684 N	Frame	5.0
		Feet	Good

<b>DAM</b>	Age	3	Calv.Ease	BW	WW	YW	Milk	HPG	Stay	Maint.En.		
	Wt	648	EPDs	18	-5.4	52	91	26	11	16	0.0	
	Prog. BW	56	Marb	+.64		REA	+.19		Bfat	+.03		
	WR	96	Beef Tenderness	→ DNA: 10 / Outstanding				Scan:	NA / NA			
	YR	100	Wean Pct.	65%	Cow Eff.	136	HB	65	GM	62	ProS	127
	Udder	Very Good										

★★★★★ for Low Maintenance, Gainability, Marbling, Rib-eye area, High Cow Efficiency, Calving Ease.

**209 BECKTON SCAMP J898 L6** 1-A 100% # 4506803 Tat: BSF1 J898 

Birth: 5-6-21

Beckton Scamp B720 L4	Beckton Scamp X458 H3	BWt	63
Beckton Scamp E175 N5	Beckton Larkaba Y448 L	WR	94
Beckton Belga W103 N	Beckton Nebula T398 V3	YWt.	927
	Beckton Belga T551 EP	YR	98
Beckton Likable U130 L2	Beckton Likable S633	Feb.ADG	3.30
Beckton LANA D689 L	Beckton Kit S478 LN	Feb.Scr.	35
Beckton Lana X122 L	Beckton Likable U130 L2	Frame	5.0
	Beckton Lana U748 JL	Feet	Good

<b>DAM</b>	Age	5	Calv.Ease	BW	WW	YW	Milk	HPG	Stay	Maint.En.		
	Wt	992	EPDs	19	-5.8	51	87	23	10	18	0.0	
	Prog. BW	61	Marb	+.37		REA	+.20		Bfat	+.03		
	WR	97	Beef Tenderness	→ DNA: 10 / Outstanding				Scan:	NA / NA			
	YR	98	Wean Pct.	49%	Cow Eff.	103	HB	67	GM	42	ProS	109
	Udder	Very Good										

★★★★★ for Low Maintenance, Marbling, Rib-eye area, Calving Ease.

• Bulls •

**210 BECKTON HERITAGE J891 L6** 1-A 100% # 4506975 Tat: BSF1 J891 

Birth: 5-5-21  
 Beckton Heritage B612 J4 < Beckton Heritage X403 L3  
 Beckton Lana N291 JC  
**BECKTON HERITAGE F615 L5**  
 Ref. H-3 < Beckton Likable U130 L2  
 Beckton Mona X022 L < Beckton Mona U584 CD  
 Beckton Likable B509 J3 < Beckton Likable U130 L2  
**BECKTON BARMAID F499 L**  
 Beckton Barmaid B744 W < Beckton Coca T363 JL  
 Beckton Warrior Z374 C6  
 Beckton Barmaid Z811 E

DAM		Calv.Ease	BW	WW	YW	Milk	HPG	Stay	Maint.En.	
Age	3	EPDs	11	-2.0	67	104	28	11	14	0.0
Wt	798	Marb	+0.40		REA	+0.24		Bfat	+0.02	
Prog. BW	64	Beef Tenderness → DNA: 10 / Outstanding Scan: 2.0 / Tender								
WR	110	Wean Pct. 68% Cow Eff. 144 HB 46 GM 38 ProS 84								
YR	105	Udder Good								

★★★★★ for Low Maintenance, Growth, Marbling, Rib-eye area, Superior Cow, High Cow Efficiency, Calving Ease.

**212 BECKTON ACCENT J837 A4** 1-A 100% # 4505577 Tat: BKT1 J837 

Birth: 4-28-21  
 Beckton Accent W180 C2 < Beckton Cody K1 P014  
 Beckton Christy R046 CQ  
**BECKTON ACCENT B549 N3**  
 Ref. A-2 < Beckton Nebula T398 V3  
 Beckton Minerva Y654 N < Beckton Minerva M369 LO  
 Beckton Accent W180 C2 < Beckton Cody K1 P014  
**BECKTON ROSE D151 A**  
 Beckton Rose X573 N < Beckton Christy R046 CQ  
 Beckton Nebula T054 H3  
 Beckton Rose T142 HI

DAM		Calv.Ease	BW	WW	YW	Milk	HPG	Stay	Maint.En.	
Age	5	EPDs	15	-2.7	60	100	23	10	21	4.0
Wt	970	Marb	+0.40		REA	+0.10		Bfat	+0.04	
Prog. BW	63	Beef Tenderness → DNA: 10 / Outstanding Scan: NA / NA								
WR	95	Wean Pct. 49% Cow Eff. 103 HB 73 GM 32 ProS 105								
YR	97	Udder Good								

★★★★★ for Gainability, Marbling, Calving Ease.

**211 BECKTON LIKABLE J653 A6** 1-A 100% # 4506077 Tat: BKT1 J653 

Birth: 4-6-21  
 Beckton Likable Z057 L4 < Beckton Likable X445 J3  
 Beckton Minola X107 L  
**BECKTON LIKABLE G289 J5**  
 Ref. L-8 < Beckton Julian GG B571  
 Beckton Coca B785 J < Beckton Coca X787 N  
 Beckton Accent E172 L3 < Beckton Accent W180 C2  
**BECKTON EMERA G015 A**  
 Beckton Emera E160 A < Beckton Indigo Y406 L  
 Beckton Accent W180 C2  
 Beckton Emera A029 D

DAM		Calv.Ease	BW	WW	YW	Milk	HPG	Stay	Maint.En.	
Age	2	EPDs	13	-2.3	54	86	25	13	19	-3.0
Wt	794	Marb	+0.39		REA	+0.05		Bfat	+0.03	
Prog. BW	74	Beef Tenderness → DNA: 9 / Outstanding Scan: NA / NA								
WR	95	Wean Pct. 54% Cow Eff. 113 HB 72 GM 30 ProS 102								
YR	94	Udder Very Good								

★★★★★ for Low Maintenance, Marbling, Calving Ease.

**213 BECKTON JULIAN J522 E8** 1-A 100% # 4505949 Tat: BKT1 J522 

Birth: 3-28-21  
 Beckton Julian D551 C6 < Beckton Julian X465 J5  
 Beckton Tamara W550 A  
**BECKTON JULIAN F067 L7**  
 Ref. J-5 < Beckton Likable Z057 L4  
 Beckton Indigo D786 L < Beckton Indigo Y026 N  
 Beckton Epic B310 J6 < Beckton Epic X464 L5  
**BECKTON MINERVA F368 E**  
 Beckton Minerva C549 W < Beckton Minerva Y116 J  
 Beckton Warrior Y108 E5  
 Beckton Minerva Y385 N

DAM		Calv.Ease	BW	WW	YW	Milk	HPG	Stay	Maint.En.	
Age	3	EPDs	19	-5.4	51	95	31	10	17	3.0
Wt	776	Marb	+0.43		REA	-0.01		Bfat	+0.04	
Prog. BW	55	Beef Tenderness → DNA: 9 / Outstanding Scan: NA / NA								
WR	98	Wean Pct. 54% Cow Eff. 113 HB 62 GM 57 ProS 118								
YR	100	Udder Good								

★★★★★ for Gainability, Marbling, Calving Ease.



**214 BECKTON ACCENT J403 C6** 1-A 100% # 4505939 Tat: BKT1 J403 

Birth: 3-22-21  
 Beckton Accent B150 N4 < Beckton Accent Y260 L3  
 BKT Larkeisa S055 NB  
**BECKTON ACCENT F177 L5**  
 Ref. A-5 < Beckton Likable Y124 L3  
 Beckton Vernice C782 L < Beckton Vernice X754 L  
 TR Ricardo DOS  
**BECKTON MAIATA F342 D**  
 Beckton Maiata Y201 A < Beckton Lana U182 JC  
 Beckton Accent W180 C2  
 Beckton Maiata W189 J

DAM		Calv.Ease	BW	WW	YW	Milk	HPG	Stay	Maint.En.	
Age	3	EPDs	20	-6.2	48	74	31	12	20	-1.0
Wt	740	Marb	+0.55		REA	+0.00		Bfat	+0.04	
Prog. BW	63	Beef Tenderness → DNA: 6 / Average Scan: 2.5 / Tender								
WR	107	Wean Pct. 60% Cow Eff. 127 HB 89 GM 36 ProS 124								
YR	102	Udder Very Good								

★★★★★ for Low Maintenance, Marbling, High Cow Efficiency, Calving Ease.



• Bulls •

**215 BECKTON LIKABLE J766 A5** 1-A 100% # 4505373 Tat: BKT1 J766 

Birth: 4-18-21

Beckton Likable U130 L2	Beckton Likable Y124 L3	Beckton Pine Marie S802 LO
Beckton Dominor W640 C5	Beckton Firefly A022 D	Beckton Firefly U801 NB
Beckton Cody K1 P014	Beckton Accent W180 C2	Beckton Christy R046 CQ
Beckton Warrior T248 L5	Beckton Serena X287 W	Beckton Serena N088 WR

BWt	57
WR	106
YWt.	929
YR	98
Feb.ADG	2.90
Feb.Scr.	33
Frame	4.5
Feet	Good

<b>DAM</b>	Age	8	Calv.Ease	BW	WW	YW	Milk	HPG	Stay	Maint.En.
	Wt	1308	EPDs	22	-7.8	53	82	26	12	18 -4.0
	Prog. BW	71	Marb	+.32		REA	-.09		Bfat	+0.03
	WR	105	Beef Tenderness→ DNA: 10 / Outstanding Scan: 1.3 / Tender +							
	YR	102	Wean Pct. 42% Cow Eff. 89 HB 82 GM 14 ProS 96							
	Udder	Good								

★★★★★ for Low Maintenance, Marbling, Calving Ease.

**218 BECKTON HUSTLER J344 N2** 1-A 100% # 4505533 Tat: BKT1 J344 

Birth: 3-19-21

Beckton Hustler C G407	Beckton Hustler CN J102	Beckton Belga G355 NP
Beckton Clipper JM A124	Beckton Vernice F513 CL	Beckton Vernice A663 PC
Beckton Nebula W778 J4	Beckton Nebula A394 C5	Beckton Lana T104 CT
Beckton Warrior W534 N4	Beckton Belga A812 W	Beckton Belga U057 EP

BWt	60
WR	86
YWt.	884
YR	93
Feb.ADG	3.24
Feb.Scr.	33
Frame	5.0
Feet	Good

<b>DAM</b>	Age	6	Calv.Ease	BW	WW	YW	Milk	HPG	Stay	Maint.En.
	Wt	1010	EPDs	18	-6.1	51	86	19	11	18 -1.0
	Prog. BW	66	Marb	+.41		REA	-.15		Bfat	+0.03
	WR	93	Beef Tenderness→ DNA: 10 / Outstanding Scan: 3.0 / Tender -							
	YR	96	Wean Pct. 44% Cow Eff. 93 HB 63 GM 37 ProS 100							
	Udder	Good								

★★★★★ for Low Maintenance, Marbling, Calving Ease.

**216 BECKTON ORACLE J415 J2** 1-A 100% # 4506479 Tat: BKT1 J415 

Birth: 3-22-21

Red Crowfoot Ole's Oscar	Schuler Sudden Impact 0004X	SOR Duchess TS 8915U
Brown Commitment S7206	Sor Marlee Cmmmtnt 0470X	SOR Marlee Beef 4511P
Beckton Julian 7526G	Beckton Julian GG B571	Bkt Marta 9A13 JL
Beckton Nebula G S237	Beckton Rose W833 N	Beckton Rose R579 JJ

BWt	53
WR	85
YWt.	883
YR	93
Feb.ADG	3.58
Feb.Scr.	33
Frame	4.5
Feet	Good

<b>DAM</b>	Age	9	Calv.Ease	BW	WW	YW	Milk	HPG	Stay	Maint.En.
	Wt	996	EPDs	22	-7.8	43	76	23	11	15 -7.0
	Prog. BW	62	Marb	+.64		REA	+.06		Bfat	+0.03
	WR	97	Beef Tenderness→ DNA: 8 / Very Good Scan: 2.5 / Tender							
	YR	100	Wean Pct. 44% Cow Eff. 93 HB 61 GM 60 ProS 121							
	Udder	NA								

★★★★★ for Low Maintenance, Gainability, Marbling, Calving Ease.



Cody Cunningham, brand inspector, and Sara Schreiber, veterinarian

**217 BECKTON ACCENT J347 C6** 1-A 100% # 4506485 Tat: BKT1 J347 

Birth: 3-19-21

Beckton Accent Y260 L3	Beckton Accent B150 N4	BKT Larkeisa S055 NB
Beckton Likable Y124 L3	Beckton Vernice C782 L	Beckton Vernice X754 L
BKT Clifftop TP R288	Beckton Clifftop W692 E3	Beckton Lydia S274 EP
Beckton Julian G1 J526	Beckton Kit L399 HR	Beckton Kit S271 JL

BWt	52
WR	88
YWt.	896
YR	91
Feb.ADG	2.90
Feb.Scr.	36
Frame	5.0
Feet	Good

<b>DAM</b>	Age	9	Calv.Ease	BW	WW	YW	Milk	HPG	Stay	Maint.En.
	Wt	1106	EPDs	21	-8.1	36	56	29	11	17 -7.0
	Prog. BW	62	Marb	+.49		REA	-.16		Bfat	+0.05
	WR	99	Beef Tenderness→ DNA: 10 / Outstanding Scan: 2.3 / Tender							
	YR	97	Wean Pct. 38% Cow Eff. 80 HB 63 GM 29 ProS 92							
	Udder	Very Good								

★★★★★ for Low Maintenance, Marbling, Calving Ease.

**219 BECKTON LIKABLE J728 L5** 1-A 100% # 4506073 Tat: BKT1 J728 

Birth: 4-15-21

Beckton Likable U130 L2	Beckton Likable C229 R3	Beckton Tamara X447 J
Beckton Nebula T398 V3	Beckton Minerva Y385 N	Beckton Minerva U310 LO
Beckton Legend Z689 J3	Beckton Legend E464 L4	Beckton Ucola X143 L
Beckton Accent B653 C3	Beckton Marta E301 A	Beckton Marta Z204 N

BWt	52
WR	107
YWt.	973
YR	101
Feb.ADG	3.35
Feb.Scr.	31
Frame	5.0
Feet	Good

<b>DAM</b>	Age	2	Calv.Ease	BW	WW	YW	Milk	HPG	Stay	Maint.En.
	Wt	724	EPDs	19	-5.1	56	92	29	10	20 1.0
	Prog. BW	52	Marb	+.39		REA	+.19		Bfat	+0.03
	WR	107	Beef Tenderness→ DNA: 9 / Outstanding Scan: 2.2 / Tender							
	YR	101	Wean Pct. 67% Cow Eff. 141 HB 79 GM 36 ProS 115							
	Udder	Very Good								

★★★★★ for Marbling, Rib-eye area, High Cow Efficiency, Calving Ease.

• Bulls •

**220 BECKTON ORACLE J698 E2** 1-A 100% # 4506807 Tat: BSF1 J698 

Birth: 4-10-21  
 Schuler Sudden Impact 0004X < Red Crowfoot Ole's Oscar  
 SOR Duchess TS 8915U  
**SCHULER ORACLE-7142E**  
 Ref. O-1 Sor Marlee Cmmtmnt 0470X < Brown Commitment S7206  
 SOR Marlee Beef 4511P  
 Beckton Epic Z674 E6 < Beckton Epic U749 D5  
 Beckton Indigo U504 EP  
**BECKTON PINE MARIE D694 E**  
 BKT Pine Marie X204 J < Beckton Jet L P491  
 BKT Pine Marie S802 LO

DAM		Age	Calv.Ease	BW	WW	YW	Milk	HPG	Stay	Maint.En.
Age	5	902	19	-5.2	51	90	26	9	16	-4.0
Wt	902	EPDs	19	-5.2	51	90	26	9	16	-4.0
Prog. BW	64	Marb	+.69		REA	+.06		Bfat	+.03	
WR	99	Beef Tenderness→ DNA:	10 / Outstanding		Scan:	2.6 / Tender				
YR	97	Wean Pct.	52%		Cow Eff.	109		HB	64	
Udder	Very Good				GM	66		ProS	130	

★★★★★ for Low Maintenance, Gainability, Marbling, Calving Ease.

**223 BECKTON WARRIOR J232 A8** 1-A 100% # 4506845 Tat: BSF1 J232 

Birth: 3-15-21  
 Beckton Warrior D359 L6 < Beckton Warrior Y108 E5  
 Beckton Lana W463 L  
**BECKTON WARRIOR G356 N7**  
 Ref. W-1 Beckton Larkaba B277 N < Beckton New Era Y194  
 Beckton Larkaba U062 CB  
 Beckton Accent W180 C2 < Beckton Cody K1 P014  
 Beckton Christy R046 CQ  
**BECKTON MAIATA E203 A**  
 Beckton Maiata A336 W < Beckton Warhawk N560  
 Beckton Maiata T806 DM

DAM		Age	Calv.Ease	BW	WW	YW	Milk	HPG	Stay	Maint.En.
Age	4	800	20	-6.5	47	75	27	12	20	-1.0
Wt	800	EPDs	20	-6.5	47	75	27	12	20	-1.0
Prog. BW	52	Marb	+.35		REA	-.08		Bfat	+.03	
WR	95	Beef Tenderness→ DNA:	9 / Outstanding		Scan:	2.9 / Tender				
YR	96	Wean Pct.	55%		Cow Eff.	117		HB	85	
Udder	Good				GM	27		ProS	112	

★★★★★ for Low Maintenance, Marbling, High Cow Efficiency, Calving Ease.

**221 BECKTON ACCENT J692 A6** 1-A 100% # 4505763 Tat: BKT1 J692 

Birth: 4-9-21  
 Beckton Accent B150 N4 < Beckton Accent Y260 L3  
 BKT Larkeisa S055 NB  
**BECKTON ACCENT F177 L5**  
 Ref. A-5 Beckton Vernice C782 L < Beckton Likable Y124 L3  
 Beckton Vernice X754 L  
 Beckton Accent W180 C2 < Beckton Cody K1 P014  
 Beckton Christy R046 CQ  
**BECKTON LARKABA E374 A**  
 Beckton Larkaba T813 JC < Beckton Justice CH M056  
 Beckton Larkaba P645 JL

DAM		Age	Calv.Ease	BW	WW	YW	Milk	HPG	Stay	Maint.En.
Age	4	960	18	-5.7	49	73	27	11	21	-1.0
Wt	960	EPDs	18	-5.7	49	73	27	11	21	-1.0
Prog. BW	63	Marb	+.50		REA	+.02		Bfat	+.04	
WR	98	Beef Tenderness→ DNA:	6 / Average		Scan:	2.1 / Tender				
YR	100	Wean Pct.	47%		Cow Eff.	100		HB	90	
Udder	Very Good				GM	28		ProS	118	

★★★★★ for Low Maintenance, Marbling, Calving Ease.

**224 BECKTON SCAMP J677 R6** 1-A 100% # 4506043 Tat: BKT1 J677 

Birth: 4-8-21  
 Beckton Scamp B720 L4 < Beckton Scamp X458 H3  
 Beckton Larkaba Y448 L  
**BECKTON SCAMP E175 N5**  
 Ref. S-1 Beckton Belga W103 N < Beckton Nebula T398 V3  
 Beckton Belga T551 EP  
 Beckton Ranger B006 D5 < Beckton Ranger Z225 J4  
 Beckton Suffeina Z731 D  
**BECKTON TAMARA F774 R**  
 Beckton Tamara R175 CQ < Beckton Cherokee N N479  
 Beckton Tamara N765 CO

DAM		Age	Calv.Ease	BW	WW	YW	Milk	HPG	Stay	Maint.En.
Age	3	868	19	-5.5	53	90	28	9	17	6.0
Wt	868	EPDs	19	-5.5	53	90	28	9	17	6.0
Prog. BW	61	Marb	+.41		REA	-.03		Bfat	+.05	
WR	110	Beef Tenderness→ DNA:	8 / Very Good		Scan:	1.9 / Tender				
YR	106	Wean Pct.	56%		Cow Eff.	117		HB	53	
Udder	Very Good				GM	32		ProS	84	

★★★★★ for Marbling, Superior Cow, High Cow Efficiency, Calving Ease.

**222 BSF ORACLE J746 W2** 1-B 99% # 4506981 Tat: BSF1 J746 

Birth: 4-17-21  
 Schuler Sudden Impact 0004X < Red Crowfoot Ole's Oscar  
 SOR Duchess TS 8915U  
**SCHULER ORACLE-7142E**  
 Ref. O-1 Sor Marlee Cmmtmnt 0470X < Brown Commitment S7206  
 SOR Marlee Beef 4511P  
 Beckton Warrior C237 H6 < Beckton Warrior Y108 E5  
 Beckton Christy T749 HT  
**BSF HELENA F532 W**  
 BSF Helena C180 A < Beckton Accent W180 C2  
 BSF Helena X529 N

DAM		Age	Calv.Ease	BW	WW	YW	Milk	HPG	Stay	Maint.En.
Age	3	772	17	-3.1	66	111	24	10	17	2.0
Wt	772	EPDs	17	-3.1	66	111	24	10	17	2.0
Prog. BW	66	Marb	+.58		REA	+.16		Bfat	+.01	
WR	114	Beef Tenderness→ DNA:	10 / Outstanding		Scan:	2.1 / Tender				
YR	113	Wean Pct.	62%		Cow Eff.	130		HB	69	
Udder	Very Good				GM	67		ProS	136	

★★★★★ for Growth, Gainability, Marbling, Rib-eye area, Superior Cow, High Cow Efficiency, Calving Ease.

**225 BECKTON ORACLE J373 R3** 1-A 100% # 4505897 Tat: BKT1 J373 

Birth: 3-20-21  
 Schuler Oracle-7142E < Schuler Sudden Impact 0004X  
 Sor Marlee Cmmtmnt 0470X  
**BECKTON ORACLE G434 A2**  
 Ref. O-4 Beckton Larkaba D449 A < Beckton Accent U777 C2  
 Beckton Larkaba U475 CT  
 Beckton Roosevelt D391 L2 < Bieber Roosevelt W384  
 Beckton Indigo Y406 L  
**BECKTON ROSE F211 R**  
 Beckton Rose C413 N < Beckton New Era Y194  
 Beckton Rose Y357 N

DAM		Age	Calv.Ease	BW	WW	YW	Milk	HPG	Stay	Maint.En.
Age	3	996	19	-6.1	52	88	27	12	20	-1.0
Wt	996	EPDs	19	-6.1	52	88	27	12	20	-1.0
Prog. BW	57	Marb	+.52		REA	+.05		Bfat	+.04	
WR	96	Beef Tenderness→ DNA:	9 / Outstanding		Scan:	2.0 / Tender				
YR	99	Wean Pct.	43%		Cow Eff.	90		HB	86	
Udder	NA				GM	50		ProS	136	

★★★★★ for Low Maintenance, Gainability, Marbling, Calving Ease.

• Bulls •

**226 BECKTON HUGHES J365 W3** 1-A 100% # 4505837 Tat: BKT1 J365 

Birth: 3-20-21  
 Bieber H Hughes W109 Basin Hobo 0545  
**BECKTON HUGHES C463 N2** Basin Rose 06T0  
 Ref. B-1 Beckton Lakme T689 NX Beckton Nexus L016  
 Beckton Lakme M669 EP Beckton Warrior Y108 E5  
**BECKTON LANA E830 W** Beckton Lana Y033 W  
 Beckton Lana C389 N Beckton New Era Y194  
 Beckton Lana Y420 W

BWt	53
WR	99
YWt	978
YR	100
Feb.ADG	2.96
Feb.Scr.	35
Frame	4.5
Feet	Good

DAM		Calv.Ease	BW	WW	YW	Milk	HPG	Stay	Maint.En.		
Age	4	EPDs	20	-7.2	53	84	29	13	17	0.0	
Wt	952	Marb	+.36		REA	-.02		Bfat		+0.04	
Prog. BW	52	Beef Tenderness	→ DNA: 6 / Average		Scan: 1.9 / Tender						
WR	105	Wean Pct.	47%	Cow Eff.	100	HB	73	GM	22	ProS	95
YR	105										
Udder	NA										

★★★★★ for Low Maintenance, Marbling, Superior Cow, Calving Ease.

**228 BECKTON SCAMP J432 N7** 1-A 100% # 4506903 Tat: BSF1 J432 

Birth: 3-23-21  
 Beckton Scamp D325 N5 Beckton Scamp A627 J4  
**BECKTON SCAMP G236 L6** Beckton Tamara Y039 N  
 Ref. S-3 Beckton Indigo Y406 L Beckton Likable U130 L2  
 Beckton Indigo R745 WR Beckton Indigo X096 N4  
**BECKTON LANA E827 N** Beckton Minola X670 N  
 Beckton Nebula Z111 N5 Beckton Cherokee T450 L3  
 Beckton Lana X767 C Beckton Lana T674 JL

BWt	56
WR	97
YWt	910
YR	96
Feb.ADG	3.58
Feb.Scr.	31
Frame	5.0
Feet	Good

DAM		Calv.Ease	BW	WW	YW	Milk	HPG	Stay	Maint.En.		
Age	4	EPDs	19	-7.0	54	84	29	12	16	-4.0	
Wt	774	Marb	+.31		REA	-.08		Bfat		+0.04	
Prog. BW	54	Beef Tenderness	→ DNA: 7 / Very Good		Scan: 1.9 / Tender						
WR	103	Wean Pct.	62%	Cow Eff.	131	HB	65	GM	13	ProS	78
YR	99										
Udder	Very Good										

★★★★★ for Low Maintenance, Gainability, Marbling, High Cow Efficiency, Calving Ease.



Lot 226

**229 BECKTON ORACLE J177 C3** 1-A 100% # 4507095 Tat: BSF1 J177 

Birth: 3-11-21  
 Schuler Oracle-7142E Schuler Sudden Impact 0004X  
**BECKTON ORACLE G434 A2** Sor Marlee Cmmtmnt 0470X  
 Ref. O-4 Beckton Larkaba D449 A Beckton Accent U777 C2  
 Beckton Larkaba U475 CT Beckton Cardinal B074 N  
**BECKTON SUFFEINA G418 C** Beckton Larkaba W868 J  
 Beckton Cardinal E381 J2 Beckton Likable Z057 L4  
 Beckton Suffeina D210 L Beckton Suffeina P671 LN

BWt	55
WR	101
YWt	932
YR	97
Feb.ADG	2.78
Feb.Scr.	33
Frame	5.0
Feet	Good

DAM		Calv.Ease	BW	WW	YW	Milk	HPG	Stay	Maint.En.		
Age	2	EPDs	18	-6.1	54	94	27	12	16	2.0	
Wt	800	Marb	+.52		REA	+.11		Bfat		+0.03	
Prog. BW	55	Beef Tenderness	→ DNA: 10 / Outstanding		Scan: 2.5 / Tender						
WR	101	Wean Pct.	57%	Cow Eff.	120	HB	54	GM	51	ProS	105
YR	97										
Udder	Very Good										

★★★★★ for Marbling, High Cow Efficiency, Calving Ease.

**227 BECKTON ACCENT J355 H5** 1-A 100% # 4506019 Tat: BKT1 J355 

Birth: 3-20-21  
 Beckton Accent Y260 L3 Beckton Accent W180 C2  
**BECKTON ACCENT D326 N4** Beckton Lana W463 L  
 Ref. A-3 Beckton Lydia S069 NB Beckton Nebula P P707  
 Beckton Lydia P583 WR Beckton Heritage X403 L3  
**BECKTON CHRISTY F670 H** Beckton Lana N291 JC  
 Beckton Heritage B612 J4 Beckton Nebula X603 J4  
 Beckton Christy Z229 N Beckton Christy X457 N

BWt	66
WR	109
YWt	922
YR	101
Feb.ADG	3.35
Feb.Scr.	34
Frame	5.0
Feet	Good

DAM		Calv.Ease	BW	WW	YW	Milk	HPG	Stay	Maint.En.		
Age	3	EPDs	12	-1.8	69	104	27	11	19	-2.0	
Wt	854	Marb	+.48		REA	-.04		Bfat		+0.03	
Prog. BW	62	Beef Tenderness	→ DNA: 7 / Very Good		Scan: 1.4 / Tender +						
WR	103	Wean Pct.	57%	Cow Eff.	120	HB	66	GM	16	ProS	82
YR	104										
Udder	Very Good										

★★★★★ for Low Maintenance, Marbling, High Cow Efficiency, Calving Ease.

**230 BSF LIKABLE J636 J5** 1-B 99% # 4507259 Tat: BSF1 J636 

Birth: 4-4-21  
 Beckton Likable Y124 L3 Beckton Likable U130 L2  
**BECKTON LIKABLE F242 D4** BKT Pine Marie S802 LO  
 Ref. L-5 Beckton Firefly A022 D Beckton Dominor W640 C5  
 Beckton Firefly U801 NB Beckton Julian G1 J526  
**BSF LAUREL Z268 J** Beckton Rose L311 LN  
 Beckton Julian U699 L5 Beckton Cherokee N N479  
 BSF Laurel U202 CQ BSF Laurel N839 LN

BWt	62
WR	104
YWt	893
YR	94
Feb.ADG	2.39
Feb.Scr.	34
Frame	5.0
Feet	Good

DAM		Calv.Ease	BW	WW	YW	Milk	HPG	Stay	Maint.En.		
Age	9	EPDs	21	-7.7	49	70	25	14	18	-7.0	
Wt	950	Marb	+.31		REA	-.04		Bfat		+0.04	
Prog. BW	67	Beef Tenderness	→ DNA: 9 / Outstanding		Scan: 2.1 / Tender						
WR	98	Wean Pct.	57%	Cow Eff.	120	HB	85	GM	9	ProS	94
YR	97										
Udder	Very Good										

★★★★★ for Low Maintenance, Marbling, High Cow Efficiency, Calving Ease.

• Bulls •

**231 BECKTON PRESIDENT J815 A2** 1-A 100% # 4505633 Tat: BKT1 J815 

Birth: 4-25-21

LSF SRR Commander 5906C < HXC Conquest 4405P  
 LSF Crystal R5145 X0414

**LSF SRR PRESIDENT 8177F**  
 Ref. O-2 < Messmer Packer S008  
 LSF SRR Flo-Marie 961 D6451 < LSF Della P4078 U8051

Beckton Accent W180 C2 < Beckton Cody K1 P014  
 Beckton Christy R046 CQ

**BECKTON TARA D477 A**  
 Beckton Tara T537 EP < Beckton Epic K3 M606  
 Beckton Tara M635 JL

BWt	82
WR	111
YWt.	1031
YR	109
Feb.ADG	3.58
Feb.Scr.	36
Frame	5.0
Feet	Good

DAM											
Age	5	Calv.Ease	BW	WW	YW	Milk	HPG	Stay	Maint.En.		
Wt	1042	EPDs	13	-2.8	68	105	30	12	17	3.0	
Prog. BW	72	Marb	+.61		REA	+.19		Bfat		+.04	
WR	118	Beef Tenderness	→		DNA:	7 / Very Good		Scan:		1.7 / Tender	
YR	110	Wean Pct.	55%	Cow Eff.	117	HB	67	GM	44	ProS	111
Udder	Very Good										

★★★★★ for Growth, Gainability, Marbling, Rib-eye area, Superior Cow, High Cow Efficiency, Calving Ease.

**233 BECKTON CARDINAL J425 N2** 1-A 100% # 4506465 Tat: BKT1 J425 

Birth: 3-23-21

TR Double Eagle ZT220 < TR Ricardo DOS  
 Beckton Lana U182 JC

**BECKTON CARDINAL E673 L**  
 Ref. C-2 < Beckton Legend U331 E2  
 Beckton Larkaba A911 L < Beckton Larkaba T418 WA

Beckton Nebula J R475 < Beckton Nebula M045  
 Beckton Larkeisa M138 JC

**BKT PINE MARIE Z250 N**  
 BKT Pine Marie U621 NB < Beckton Nebula P P707  
 BKT Pine Marie P475 LN

BWt	63
WR	100
YWt.	880
YR	93
Feb.ADG	2.84
Feb.Scr.	31
Frame	5.0
Feet	Good

DAM											
Age	9	Calv.Ease	BW	WW	YW	Milk	HPG	Stay	Maint.En.		
Wt	946	EPDs	21	-7.8	51	82	27	13	19	1.0	
Prog. BW	63	Marb	+.47		REA	+.05		Bfat		+.04	
WR	104	Beef Tenderness	→		DNA:	6 / Average		Scan:		2.3 / Tender	
YR	102	Wean Pct.	55%	Cow Eff.	115	HB	77	GM	30	ProS	107
Udder	Very Good										

★★★★★ for Marbling, Calving Ease.



Lot 231

**234 BECKTON HERITAGE J647 D5** 1-A 100% # 4505955 Tat: BKT1 J647 

Birth: 4-5-21

Beckton Heritage X403 L3 < Beckton Heritage T270 J2  
 Beckton Indigo H150 LN

**BECKTON HERITAGE C477 J4**  
 Ref. H-2 < Beckton Julian U699 L5  
 Beckton Ruth Z858 J < Beckton Ruth U557 JT

Beckton Dominor A378 W7 < Beckton Dominor Y005 V6  
 Beckton Lana Y541 W

**BECKTON EOLA F391 D**  
 Beckton Eola X216 L < Beckton Likable U120 L2  
 Beckton Eola U027 NB

BWt	64
WR	115
YWt.	936
YR	102
Feb.ADG	3.07
Feb.Scr.	33
Frame	5.0
Feet	Good

DAM											
Age	3	Calv.Ease	BW	WW	YW	Milk	HPG	Stay	Maint.En.		
Wt	946	EPDs	16	-3.0	58	95	33	12	16	3.0	
Prog. BW	60	Marb	+.45		REA	+.20		Bfat		+.04	
WR	115	Beef Tenderness	→		DNA:	9 / Outstanding		Scan:		1.3 / Tender +	
YR	102	Wean Pct.	55%	Cow Eff.	115	HB	57	GM	42	ProS	99
Udder	Very Good										

★★★★★ for Marbling, Rib-eye area, Calving Ease.

**232 BECKTON DOMINOR J122 L10** 1-A 100% # 4506093 Tat: BKT1 J122 

Birth: 3-4-21

Beckton Dominor D254 N8 < Beckton Dominor A378 W7  
 Beckton Indigo W772 N

**BECKTON DOMINOR G402 A9**  
 Ref. D-3 < Beckton Accent B549 N3  
 Beckton Lana D273 A < Beckton Lana B666 S

Beckton Legend E032 E3 < Beckton Legend C313 C2  
 Beckton Emera C066 E

**BECKTON COCA G051 L**  
 Beckton Coca E710 E < Beckton Epic Y484 N6  
 Beckton Coca Z529 A

BWt	58
WR	99
YWt.	873
YR	91
Feb.ADG	2.90
Feb.Scr.	33
Frame	5.0
Feet	Good

DAM											
Age	2	Calv.Ease	BW	WW	YW	Milk	HPG	Stay	Maint.En.		
Wt	844	EPDs	19	-5.7	52	81	25	12	17	4.0	
Prog. BW	58	Marb	+.34		REA	+.02		Bfat		+.04	
WR	99	Beef Tenderness	→		DNA:	9 / Outstanding		Scan:		3.0 / Tender -	
YR	91	Wean Pct.	53%	Cow Eff.	111	HB	63	GM	12	ProS	76
Udder	NA										

★★★★★ for Marbling, Calving Ease.



Lot 234

# The Yearling Heifers



Heifer pregnancy  
and loss warranty

**OPTIONAL  
WARRANTY**

See page 3 for  
more details.

Beckton females are nearly ideal for today's industry – moderately sized, efficient producers. They combine calving ease, growth, and desirable carcass traits. They are feminine, maternal and quiet, with nice udders and sound feet. All of our heifer calves trailed up with their mothers into the Bighorn Mountains to spend their first summer. They have learned the meaning of mothering ability. And they have the productive capacity to produce

the bulls that you see in our sale. The sale heifers are a select group from the top of our replacements.

If you wish, we can also keep any sale heifers through the summer and breed them in natural service to the same herd sires we use with our own replacements. There will be a charge of \$250 per heifer plus delivery at cost in the fall. Visit with Cam about this program.



Beckton is offering two straws of P707 semen or any other sire (for which we have adequate supply) to go with every heifer purchased. The buyer will only be responsible for shipping from Billings, MT and semen may be used on any animal the buyer would like.

• Heifers •

**301 BECKTON TARA J184 S**  
1-A 100% # 4506855 Tattoo: BSF1 J184

Birth: 3-12-21  
 Beckton Scamp D325 N5 < Beckton Scamp A627 J4  
 Beckton Tamara Y039 N  
**BECKTON SCAMP G236 L6**  
 Ref. S-3 Beckton Indigo Y406 L < Beckton Likable U130 L2  
 Beckton Indigo R745 WR  
 Beckton Nebula X603 J4 < Beckton Nebula T398 V3  
 Beckton Firefly T003 JC  
**BECKTON TARA E314 N**  
 Beckton Tara B169 A < Beckton Accent W180 C2  
 Beckton Tara U666 CT

DAM	
Age	4
Wt	1045
Prog.BW	76
WR	122
YR	116
Udder	Very Good

Calv.Ease	BW	WW	YW	Milk	HPG	Stay	Maint.En.	
EPDs	15	-2.9	70	109	30	12	18	-2.0
Marb	+0.36		REA	+0.17		Bfat		+0.02
Sire Tenderness: 10 / Outstanding								
Cow Eff.	114	CEM	7	HB	6%			

BWt 86  
WR 129  
YR 121  
Fr. Med

**304 BECKTON LANA J377 L**  
1-A 100% # 4506467 Tattoo: BKT1 J377

Birth: 3-21-21  
 Beckton Likable Y124 L3 < Beckton Likable U130 L2  
 BKT Pine Marie S802 LO  
**BECKTON LIKABLE E391 N4**  
 Ref. L-4 Beckton Lana X466 N < Beckton Nebula T398 V3  
 Beckton Lana T226 NB  
 Beckton Warrior W534 N4 < Beckton Warrior C1 S337  
 BKT Larkeisa S055 NB  
**BECKTON LANA Z276 W**  
 Beckton Lana U297 VA < Beckton Vega P079  
 Beckton Lana P317 JL

DAM	
Age	9
Wt	1130
Prog.BW	66
WR	111
YR	108
Udder	Good

Calv.Ease	BW	WW	YW	Milk	HPG	Stay	Maint.En.	
EPDs	17	-4.9	61	94	31	14	16	2.0
Marb	+0.44		REA	-0.03		Bfat		+0.04
Sire Tenderness: 8 / Very Good								
Cow Eff.	101	CEM	8	HB	27%			

BWt 61  
WR 120  
YR 122  
Fr. Med

★★★★★ for Low Maintenance, Growth, Marbling, Rib-eye area, Superior Cow, Calving Ease, Stayability.

★★★★★ for Growth, Marbling, Superior Cow, Calving Ease, Stayability.

**302 BECKTON MINERVA J166 A**  
1-A 100% # 4505523 Tattoo: BKT1 J166

Birth: 3-10-21  
 Beckton Accent W180 C2 < Beckton Cody K1 P014  
 Beckton Christy R046 CQ  
**BECKTON ACCENT B549 N3**  
 Ref. A-2 Beckton Minerva Y654 N < Beckton Nebula T398 V3  
 Beckton Minerva M369 LO  
 Beckton Warrior Y108 E5 < Beckton Warrior W534 N4  
 Beckton Susan W058 E  
**BECKTON MINERVA C549 W**  
 Beckton Minerva Y385 N < Beckton Nebula T398 V3  
 Beckton Minerva U310 LO

DAM	
Age	6
Wt	1120
Prog.BW	63
WR	109
YR	109
Udder	Very Good

Calv.Ease	BW	WW	YW	Milk	HPG	Stay	Maint.En.	
EPDs	16	-4.0	64	105	30	12	21	5.0
Marb	+0.34		REA	+0.12		Bfat		+0.04
Sire Tenderness: 9 / Outstanding								
Cow Eff.	102	CEM	7	HB	7%			

BWt 67  
WR 120  
YR 130  
Fr. Med



★★★★★ for Growth, Marbling, Superior Cow, Calving Ease, Stayability.

**303 BECKTON INDIGO J562 N**  
2 100% # 4506773 Tattoo: BKB1 J562

Birth: 3-31-21  
 Beckton Nebula T398 V3 < Beckton Nebula L P093  
 Beckton Minerva J615 VG  
**BECKTON NEBULA A773 L4**  
 Ref. N-2 Beckton Mona X022 L < Beckton Likable U130 L2  
 Beckton Mona U584 CD  
 Beckton Accent U777 C2 < Beckton Cody K1 P014  
 Beckton Susan R022 CQ  
**BECKTON INDIGO D465 A**  
 Beckton Indigo LC22 LO < Beckton Loki F251  
 Beckton Indigo E370 RN

DAM	
Age	5
Wt	1035
Prog.BW	76
WR	120
YR	122
Udder	Very Good

Calv.Ease	BW	WW	YW	Milk	HPG	Stay	Maint.En.	
EPDs	13	-1.9	64	100	32	12	22	3.0
Marb	+0.35		REA	+0.06		Bfat		+0.03
Sire Tenderness: 10 / Outstanding								
Cow Eff.	119	CEM	5	HB	4%			

BWt 82  
WR 129  
YR 133  
Fr. Med

**305 BECKTON BARMAID J426 A**  
1-A 100% # 4506603 Tattoo: BSF1 J426

Birth: 3-23-21  
 Beckton Accent W180 C2 < Beckton Cody K1 P014  
 Beckton Christy R046 CQ  
**BECKTON ACCENT E172 L3**  
 Ref. A-4 Beckton Indigo Y406 L < Beckton Likable U130 L2  
 Beckton Indigo R745 WR  
 Beckton Janus X799 L2 < Beckton Roman J S158  
 Beckton Sierra K557 LO  
**BECKTON BARMAID A123 O**  
 Beckton Barmaid X654 N < Beckton Nebula T398 V3  
 Beckton Barmaid S758 DM

DAM	
Age	8
Wt	1320
Prog.BW	68
WR	116
YR	108
Udder	Very Good

Calv.Ease	BW	WW	YW	Milk	HPG	Stay	Maint.En.	
EPDs	12	-1.3	68	107	31	10	21	10.0
Marb	+0.30		REA	+0.22		Bfat		+0.03
Sire Tenderness: 9 / Outstanding								
Cow Eff.	97	CEM	4	HB	22%			

BWt 80  
WR 134  
YR 117  
Fr. Med

★★★★★ for Growth, Marbling, Superior Cow, High Cow Efficiency, Calving Ease, Stayability.

★★★★★ for Growth, Marbling, Rib-eye area, Superior Cow, Calving Ease, Stayability.

• Heifers •

**306 BECKTON PINE MARIE J342 A**  
1-A 100% # 4505593 Tattoo: BKT1 J342

Birth: 3-19-21

Beckton Accent W180 C2  
Beckton Lana W463 L

**BECKTON ACCENT D326 N4**  
Ref. A-3

Beckton Lydia S069 NB

Beckton Accent W180 C2  
Beckton Lana W463 L

**BECKTON PINE MARIE D268 A**  
BKT Pine Marie U621 NB

BKT Pine Marie P475 LN

BWt	65
WR	113
YR	116
Fr.	Med

DAM	
Age	5
Wt	1350
Prog.BW	64
WR	99
YR	103
Udder	Good

Calv.Ease	BW	WW	YW	Milk	HPG	Stay	Maint.En.	
EPDs	13	-2.8	71	113	26	13	22	3.0
Marb	+.51		REA	-.06		Bfat		+0.04
Sire Tenderness: 9 / Outstanding								
Cow Eff.	80		CEM	4		HB		7%

★★★★★ for Growth, Marbling, Calving Ease, Stayability.

**308 BECKTON ROSE J357 L**  
1-A 100% # 4505515 Tattoo: BKT1 J357

Birth: 3-20-21

Beckton Likable B032 C5  
Beckton Mona Z270 C

**BECKTON LIKABLE F287 J6**  
Ref. L-6

Beckton Larkaba X064 J

Beckton Accent W180 C2  
Beckton Lana W463 L

**BECKTON ROSE C414 A**  
Beckton Rose W656 E

Beckton Epic K4 N795  
Beckton Rose S269 EP

BWt	70
WR	112
YR	118
Fr.	Med

DAM	
Age	6
Wt	1200
Prog.BW	59
WR	112
YR	110
Udder	Very Good

Calv.Ease	BW	WW	YW	Milk	HPG	Stay	Maint.En.	
EPDs	17	-4.8	61	108	27	12	19	7.0
Marb	+.48		REA	-.02		Bfat		+0.05
Sire Tenderness: 9 / Outstanding								
Cow Eff.	89		CEM	7		HB		30%

★★★★★ for Growth, Marbling, Superior Cow, Calving Ease, Stayability.

**307 BECKTON CHRISTY J285 H**  
1-A 100% # 4506635 Tattoo: BSF1 J285

Birth: 3-17-21

Bieber H Hughes W109  
Basin Rose 06T0

**BECKTON HUGHES C463 N2**  
Ref. B-1

Beckton Lakme T689 NX

Beckton Accent W180 C2  
Beckton Susan P857 JO

**BECKTON CHRISTY B147 A**  
Beckton Christy Z533 C

Beckton Clifftop W692 E3  
Beckton Christy S151 NB

BWt	59
WR	117
YR	116
Fr.	Med

DAM	
Age	7
Wt	1130
Prog.BW	69
WR	116
YR	106
Udder	Very Good

Calv.Ease	BW	WW	YW	Milk	HPG	Stay	Maint.En.	
EPDs	15	-4.1	63	94	33	12	19	2.0
Marb	+.34		REA	+.01		Bfat		+0.05
Sire Tenderness: 7 / Very Good								
Cow Eff.	98		CEM	6		HB		13%

★★★★★ for Growth, Marbling, Superior Cow, Calving Ease, Stayability.

**309 BECKTON JANE J518 L**  
1-A 100% # 4506693 Tattoo: BSF1 J518

Birth: 3-28-21

Beckton Likable B032 C5  
Beckton Mona Z270 C

**BECKTON LIKABLE F287 J6**  
Ref. L-6

Beckton Larkaba X064 J

Beckton Epic A286 E7  
Beckton Larkaba Y648 E

**BECKTON JANE C065 E**  
Beckton Jane A724 E

Beckton Epic U749 D5  
Beckton Jane X164 N

BWt	70
WR	130
YR	127
Fr.	Med

DAM	
Age	6
Wt	1210
Prog.BW	67
WR	119
YR	113
Udder	Fair

Calv.Ease	BW	WW	YW	Milk	HPG	Stay	Maint.En.	
EPDs	17	-4.4	64	112	30	12	15	8.0
Marb	+.49		REA	+.03		Bfat		+0.05
Sire Tenderness: 9 / Outstanding								
Cow Eff.	102		CEM	6		HB		81%

★★★★★ for Growth, Marbling, Superior Cow, Calving Ease, Stayability.



**310 BSF JUSTICIA J622 A**  
1-B 99% # 4507257 Tattoo: BSF1 J622

Birth: 4-3-21

Beckton Accent W180 C2  
Beckton Cody K1 P014

**BECKTON ACCENT B549 N3**  
Ref. A-2

Beckton Minerva Y654 N

Beckton Nebula T398 V3  
Beckton Minerva M369 LO

Beckton Nebula W040 E4  
BKT Suffeina T110 EM

**BSF JUSTICIA Z267 N**  
BSF Justicia U855 JC

Beckton Justice C1 R483  
BSF Regus M638 WR

BWt	74
WR	122
YR	125
Fr.	Med

DAM	
Age	9
Wt	1220
Prog.BW	68
WR	104
YR	105
Udder	Very Good

Calv.Ease	BW	WW	YW	Milk	HPG	Stay	Maint.En.	
EPDs	15	-2.7	65	108	26	13	17	8.0
Marb	+.35		REA	+.24		Bfat		+0.04
Sire Tenderness: 9 / Outstanding								
Cow Eff.	95		CEM	6		HB		43%

★★★★★ for Growth, Marbling, Rib-eye area, Superior Cow, Calving Ease, Stayability.

• Heifers •

**311 BECKTON BARMAID J300 A**  
1-A 100% # 4506751 Tattoo: BSF1 J300

Birth: 3-18-21

Beckton Accent W180 C2  
Beckton Lana W463 L

**BECKTON ACCENT D326 N4**  
Ref. A-3  
Beckton Lydia S069 NB

Beckton Accent W180 C2  
Beckton Lydia P583 WR

**BECKTON BARMAID D218 A**  
Beckton Accent Y260 L3  
Beckton Lana W463 L  
Beckton Herald FV J537  
Beckton Barmaid P323 HR  
Beckton Barmaid J012 CO

BWt **73**  
WR **115**  
YR **113**  
Fr. **Med**

DAM		Calv.Ease	BW	WW	YW	Milk	HPG	Stay	Maint.En.	
Age	5	EPDs	12	-1.8	64	99	29	12	21	-1.0
Wt	1080	Marb	+.57		REA	-.12		Bfat +.04		
Prog.BW	67	Sire Tenderness: <b>9 / Outstanding</b>								
WR	113	Cow Eff.	101		CEM	3		HB 8%		
YR	111									
Udder	Very Good									

**313 BECKTON PINE MARIE J182 H**  
1-A 100% # 4505835 Tattoo: BKT1 J182

Birth: 3-12-21

Beckton Hustler CN J102  
Beckton Hustler C G407  
Beckton Belga G355 NP

**BECKTON HALFMANNHUSTLER R588**  
Ref. H-1  
Beckton Vernice F513 CL  
Beckton Clipper JM A124  
Beckton Vernice A663 PC

TR Double Eagle ZT220  
TR Ricardo DOS  
Beckton Lana U182 JC

**BECKTON PINE MARIE E828 D**  
Beckton Nebula T269 E2  
BKT Pine Marie X339 N  
BKT Pine Marie S467 JE

BWt **68**  
WR **117**  
YR **110**  
Fr. **Med**

DAM		Calv.Ease	BW	WW	YW	Milk	HPG	Stay	Maint.En.	
Age	4	EPDs	14	-3.1	65	112	27	11	19	10.0
Wt	1130	Marb	+.36		REA	+.07		Bfat +.04		
Prog.BW	64	Sire Tenderness: <b>10 / Outstanding</b>								
WR	114	Cow Eff.	95		CEM	7		HB 28%		
YR	103									
Udder	Very Good									

★★★★★ for Low Maintenance, Growth, Marbling, Superior Cow, Calving Ease, Stayability.

★★★★★ for Growth, Marbling, Superior Cow, Calving Ease, Stayability.

**312 BECKTON PINE MARIE J130 A**  
1-A 100% # 4505567 Tattoo: BKT1 J130

Birth: 3-6-21

Beckton Accent W180 C2  
Beckton Cody K1 P014  
Beckton Christy R046 CQ

**BECKTON ACCENT B549 N3**  
Ref. A-2  
Beckton Minerva Y654 N  
Beckton Nebula T398 V3  
Beckton Minerva M369 LO

Beckton Epic B545 N7  
Beckton Epic Y484 N6  
Beckton Serena X338 N

**BECKTON PINE MARIE D098 E**  
Beckton Pine Marie B170 L  
Beckton Likable U130 L2  
BKT Pine Marie W102 C

BWt **61**  
WR **105**  
YR **109**  
Fr. **Med**

DAM		Calv.Ease	BW	WW	YW	Milk	HPG	Stay	Maint.En.	
Age	5	EPDs	15	-3.4	63	105	27	11	19	9.0
Wt	1010	Marb	+.37		REA	+.26		Bfat +.04		
Prog.BW	59	Sire Tenderness: <b>9 / Outstanding</b>								
WR	106	Cow Eff.	99		CEM	6		HB 28%		
YR	107									
Udder	Very Good									

**314 BECKTON LAKME J107 N**  
1-A 100% # 4506005 Tattoo: BKT1 J107

Birth: 3-2-21

Beckton Nebula B557 J3  
Beckton Nebula P P707  
Beckton Larkaba T813 JC

**BECKTON NEBULA G249 N4**  
Ref. N-5  
Beckton Lana Y130 N  
Beckton Nebula W022 D3  
Beckton Lana W525 D

Beckton Epic B310 J6  
Beckton Epic X464 L5  
Beckton Minerva Y116 J

**BECKTON LAKME F603 E**  
Beckton Lakme Y027 A  
Beckton Accent W180 C2  
Beckton Lakme W267 L

BWt **64**  
WR **108**  
YR **123**  
Fr. **Med**

DAM		Calv.Ease	BW	WW	YW	Milk	HPG	Stay	Maint.En.	
Age	3	EPDs	15	-3.9	53	89	30	14	17	1.0
Wt	1000	Marb	+.46		REA	-.08		Bfat +.03		
Prog.BW	64	Sire Tenderness: <b>9 / Outstanding</b>								
WR	108	Cow Eff.	86		CEM	8		HB 21%		
YR	123									
Udder	Good									

★★★★★ for Growth, Marbling, Rib-eye area, Superior Cow, Calving Ease, Stayability.

★★★★★ for Growth, Marbling, Superior Cow, Calving Ease, Stayability.



**315 BECKTON SUFFEINA J376 A**  
1-A 100% # 4505343 Tattoo: BKT1 J376

Birth: 3-21-21

Beckton Accent W180 C2  
Beckton Cody K1 P014  
Beckton Christy R046 CQ

**BECKTON ACCENT B549 N3**  
Ref. A-2  
Beckton Minerva Y654 N  
Beckton Nebula T398 V3  
Beckton Minerva M369 LO

Beckton Accent Y260 L3  
Beckton Accent W180 C2  
Beckton Lana W463 L

**BECKTON SUFFEINA A190 A**  
Beckton Nebula P P707  
BKT Suffeina T110 EM

BWt **76**  
WR **127**  
YR **119**  
Fr. **Med**

DAM		Calv.Ease	BW	WW	YW	Milk	HPG	Stay	Maint.En.	
Age	8	EPDs	11	-1.2	71	116	27	11	21	13.0
Wt	1280	Marb	+.49		REA	+.04		Bfat +.04		
Prog.BW	78	Sire Tenderness: <b>9 / Outstanding</b>								
WR	115	Cow Eff.	85		CEM	3		HB 28%		
YR	112									
Udder	NA									

★★★★★ for Growth, Marbling, Superior Cow, Stayability.



• Heifers •

**316 BECKTON ROSE J248 D**  
1-A 100% # 4505745 Tattoo: BKT1 J248

Birth: 3-16-21

Beckton Dominor A378 W7 < Beckton Dominor Y005 V6  
Beckton Lana Y541 W

**BECKTON DOMINOR F263 N8** Bwt **83**  
Ref. D-2 < Beckton Nebula EN S347  
Beckton Larkaba W272 N < Beckton Larkaba N643 HR WR **103**

Beckton Nebula A773 L4 < Beckton Nebula T398 V3  
Beckton Mona X022 L

**BECKTON ROSE E281 N** YR **109**  
< Beckton Nebula U206 V3  
Beckton Rose Y357 N < Beckton Rose U726 CT Fr. **Med**

DAM	
Age	4
Wt	1045
Prog.BW	62
WR	91
YR	109
Udder	Very Good

Calv.Ease	BW	WW	YW	Milk	HPG	Stay	Maint.En.	
EPDs	14	-1.5	58	95	29	12	21	1.0
Marb	+.48		REA +.03		Bfat +.05			
Sire Tenderness: 10 / Outstanding								
Cow Eff.	91	CEM 7	HB 3%					

★★★★★ for Growth, Marbling, Calving Ease, Stayability.

**318 BECKTON LARKABA J447 A**  
1-A 100% # 4505421 Tattoo: BKT1 J447

Birth: 3-23-21

Beckton Accent W180 C2 < Beckton Cody K1 P014  
Beckton Christy R046 CQ

**BECKTON ACCENT B549 N3** Bwt **74**  
Ref. A-2 < Beckton Nebula T398 V3  
Beckton Minerva Y654 N < Beckton Minerva M369 LO WR **115**

Beckton Likable U130 L2 < Beckton Likable S633  
Beckton Kit S478 LN

**BECKTON LARKABA B409 L** YR **108**  
< Beckton Accent U777 C2  
Beckton Larkaba Y454 A < Beckton Larkaba U498 EP Fr. **Med**

DAM	
Age	7
Wt	1075
Prog.BW	68
WR	112
YR	107
Udder	Very Good

Calv.Ease	BW	WW	YW	Milk	HPG	Stay	Maint.En.	
EPDs	12	-0.9	73	118	29	12	19	8.0
Marb	+.38		REA +.30		Bfat +.04			
Sire Tenderness: 9 / Outstanding								
Cow Eff.	102	CEM 5	HB 22%					

★★★★★ for Growth, Marbling, Rib-eye area, Superior Cow, Calving Ease, Stayability.

**317 BECKTON CHRISTY J199 A**  
1-A 100% # 4506451 Tattoo: BKT1 J199

Birth: 3-12-21

Beckton Accent W180 C2 < Beckton Cody K1 P014  
Beckton Christy R046 CQ

**BECKTON ACCENT B549 N3** Bwt **56**  
Ref. A-2 < Beckton Nebula T398 V3  
Beckton Minerva Y654 N < Beckton Minerva M369 LO WR **109**

Beckton Julian X721 E6 < Beckton Julian U699 L5  
Beckton Lana U329 EP

**BECKTON CHRISTY Z125 J** YR **102**  
< Beckton Nebula M045  
Beckton Christy X354 N < Beckton Christy T444 JL Fr. **Med**

DAM	
Age	9
Wt	1070
Prog.BW	69
WR	110
YR	107
Udder	Very Good

Calv.Ease	BW	WW	YW	Milk	HPG	Stay	Maint.En.	
EPDs	16	-4.1	65	108	28	13	19	7.0
Marb	+.29		REA +.06		Bfat +.05			
Sire Tenderness: 9 / Outstanding								
Cow Eff.	97	CEM 6	HB 16%					

★★★★★ for Marbling, Superior Cow, Calving Ease, Stayability.

**319 BECKTON CHRISTY J310 N**  
1-A 100% # 4505385 Tattoo: BKT1 J310

Birth: 3-18-21

Beckton Nebula E P084 < Beckton Nebula M045  
BKT Pine Marie M119 EP

**BECKTON NEBULA EN S347** Bwt **65**  
Ref. N-1 < Beckton Eola P530 NB < Beckton Eola M663 EP WR **113**

Beckton Warrior Z936 N6 < Beckton Warrior T248 L5  
Beckton Freyja W462 N

**BECKTON CHRISTY B003 W** YR **114**  
< Beckton Epic U749 D5  
Beckton Christy T592 NB Fr. **Med**

DAM	
Age	7
Wt	1300
Prog.BW	73
WR	111
YR	109
Udder	Very Good

Calv.Ease	BW	WW	YW	Milk	HPG	Stay	Maint.En.	
EPDs	17	-4.2	57	88	36	11	15	-3.0
Marb	+.58		REA -.19		Bfat +.05			
Sire Tenderness: 8 / Very Good								
Cow Eff.	75	CEM 7	HB 47%					

★★★★★ for Low Maintenance, Growth, Marbling, Superior Cow, Calving Ease, Stayability.



**320 BSF HUSTELLE J530 A**  
1-B 99% # 4506825 Tattoo: BSF1 J530

Birth: 3-28-21

Beckton Accent W180 C2 < Beckton Cody K1 P014  
Beckton Christy R046 CQ

**BECKTON ACCENT B549 N3** Bwt **70**  
Ref. A-2 < Beckton Nebula T398 V3  
Beckton Minerva Y654 N < Beckton Minerva M369 LO WR **115**

Beckton Hughes C463 N2 < Bieber H Hughes W109  
Beckton Lakme T689 NX

**BSF HUSTELLE E045 H** YR **116**  
< Beckton Julian A565 J4  
BSF Hustelle C233 J < BSF Hustelle A756 E Fr. **Med**

DAM	
Age	4
Wt	1015
Prog.BW	70
WR	118
YR	111
Udder	Very Good

Calv.Ease	BW	WW	YW	Milk	HPG	Stay	Maint.En.	
EPDs	14	-2.9	69	109	26	12	18	7.0
Marb	+.40		REA +.15		Bfat +.04			
Sire Tenderness: 9 / Outstanding								
Cow Eff.	104	CEM 5	HB 30%					

★★★★★ for Growth, Marbling, Rib-eye area, Superior Cow, Calving Ease, Stayability.

• Heifers •



Smores and Dragon

**323** **BECKTON ENCINO J335 H**  
 1-A 100% # 4506877 Tattoo: BSF1 J335  
 Birth: 3-19-21  
 Beckton Hustler CN J102 < Beckton Hustler C G407  
 Beckton Belga G355 NP  
**BECKTON HALFMANNHUSTLER R588**  
 Ref. H-1 Beckton Vernice F513 CL < Beckton Clipper JM A124  
 Beckton Vernice A663 PC  
 Beckton Epic A587 N7 < Beckton Epic X330 L6  
 Beckton Lana W113 N  
**BECKTON ENCINO E639 E**  
 Beckton New Era Y194  
 Beckton Encino B362 N < Beckton Encino X448 L

DAM		Calv.Ease	BW	WW	YW	Milk	HPG	Stay	Maint.En.	
Age	4	EPDs	14	-3.3	62	106	20	10	19	8.0
Wt	1025	Marb	+.34		REA	-.20		Bfat +.04		
Prog.BW	71	Sire Tenderness: 10 / Outstanding								
WR	108	Cow Eff. 98		CEM 7		HB 26%				
YR	109									
Udder	Very Good									

BWT 71  
WR 109  
YR 110  
Fr. Med

★★★★★ for Growth, Marbling, Superior Cow, Calving Ease, Stayability.

**321** **BECKTON MINERVA J309 A**  
 1-A 100% # 4505367 Tattoo: BKT1 J309  
 Birth: 3-18-21  
 Beckton Accent Y260 L3 < Beckton Accent W180 C2  
 Beckton Lana W463 L  
**BECKTON ACCENT D326 N4**  
 Ref. A-3 Beckton Lydia S069 NB < Beckton Nebula P P707  
 Beckton Lydia P583 WR  
 Beckton Accent W180 C2 < Beckton Cody K1 P014  
 Beckton Christy R046 CQ  
**BECKTON MINERVA A683 A**  
 Beckton Minerva L324 LN < Beckton Lancer T3 J396  
 Beckton Minerva J232 LN

DAM		Calv.Ease	BW	WW	YW	Milk	HPG	Stay	Maint.En.	
Age	8	EPDs	15	-3.2	63	98	30	11	21	2.0
Wt	1170	Marb	+.49		REA	-.08		Bfat +.03		
Prog.BW	66	Sire Tenderness: 9 / Outstanding								
WR	107	Cow Eff. 89		CEM 5		HB 9%				
YR	106									
Udder	Very Good									

BWT 60  
WR 109  
YR 106  
Fr. Med

★★★★★ for Growth, Marbling, Superior Cow, Calving Ease, Stayability.

**324** **BECKTON ROSE J318 A**  
 1-A 100% # 4505529 Tattoo: BKT1 J318  
 Birth: 3-18-21  
 Beckton Accent W180 C2 < Beckton Cody K1 P014  
 Beckton Christy R046 CQ  
**BECKTON ACCENT B549 N3**  
 Ref. A-2 Beckton Minerva Y654 N < Beckton Nebula T398 V3  
 Beckton Minerva M369 LO  
 Beckton Accent W180 C2 < Beckton Cody K1 P014  
 Beckton Lana W463 L  
**BECKTON ROSE C681 A**  
 Beckton Rose W283 J < Beckton Jet L P491  
 Beckton Rose P016 LN

DAM		Calv.Ease	BW	WW	YW	Milk	HPG	Stay	Maint.En.	
Age	6	EPDs	13	-2.3	64	104	26	11	20	6.0
Wt	1200	Marb	+.49		REA	-.02		Bfat +.04		
Prog.BW	69	Sire Tenderness: 9 / Outstanding								
WR	105	Cow Eff. 77		CEM 5		HB 15%				
YR	109									
Udder	Good									

BWT 63  
WR 97  
YR 104  
Fr. Med

★★★★★ for Marbling, Superior Cow, Calving Ease, Stayability.

**322** **BECKTON LANA J257 H**  
 1-A 100% # 4505743 Tattoo: BKT1 J257  
 Birth: 3-16-21  
 Beckton Hustler CN J102 < Beckton Hustler C G407  
 Beckton Belga G355 NP  
**BECKTON HALFMANNHUSTLER R588**  
 Ref. H-1 Beckton Vernice F513 CL < Beckton Clipper JM A124  
 Beckton Vernice A663 PC  
 Beckton Warrior Y108 E5 < Beckton Warrior W534 N4  
 Beckton Susan W058 E  
**BECKTON LANA E278 W**  
 Beckton Lana B028 R < Beckton Ranger Z225 J4  
 Beckton Lana Z730 J

DAM		Calv.Ease	BW	WW	YW	Milk	HPG	Stay	Maint.En.	
Age	4	EPDs	19	-6.5	50	86	24	11	15	4.0
Wt	845	Marb	+.41		REA	-.30		Bfat +.05		
Prog.BW	60	Sire Tenderness: 10 / Outstanding								
WR	103	Cow Eff. 118		CEM 10		HB 61%				
YR	105									
Udder	Very Good									

BWT 65  
WR 109  
YR 112  
Fr. Med

★★★★★ for Growth, Marbling, Superior Cow, High Cow Efficiency, Calving Ease, Stayability.

**325** **BECKTON MINERVA J557 R**  
 1-A 100% # 4505705 Tattoo: BKT1 J557  
 Birth: 3-30-21  
 Bieber Roosevelt W384 < Bieber Rough Rider 10712  
 Bieber Sheba 9602  
**BECKTON ROOSEVELT D305 C2**  
 Ref. B-2 Beckton Lana W277 A < Beckton Cody K1 P014  
 Beckton Lana N869 LO  
 Beckton Warrior C695 W6 < Beckton Warrior Y108 E5  
 Beckton Lana Y033 W  
**BECKTON MINERVA E078 W**  
 Beckton Minerva C549 W < Beckton Warrior Y108 E5  
 Beckton Minerva Y385 N

DAM		Calv.Ease	BW	WW	YW	Milk	HPG	Stay	Maint.En.	
Age	4	EPDs	18	-3.7	51	86	33	11	18	-2.0
Wt	760	Marb	+.49		REA	-.08		Bfat +.06		
Prog.BW	54	Sire Tenderness: 7 / Very Good								
WR	113	Cow Eff. 136		CEM 8		HB 12%				
YR	116									
Udder	Good									

BWT 63  
WR 112  
YR 110  
Fr. Med

★★★★★ for Low Maintenance, Growth, Marbling, Superior Cow, High Cow Efficiency, Calving Ease, Stayability.

# Reference Sires



Julian B571 (J-1)

The goal for Beckton's program has always been to develop breeding seedstock which offer increased levels of performance for the commercial cattleman. Increased performance does not mean maximizing weight and size, which have already reached the upper limit of economic value for the packer and consumer. It does, however, mean increasing performance related to calving percentage and weaning percentage; and increasing performance related to cow maintenance requirements and "pounds of calf per acre" efficiency.

**A-1 BECKTON ACCENT W180 C2**  
1-A 100% # 1331776 Tattoo: BKB9 W180

Birth: 3-12-09

Beckton Cody KH M390  
Beckton Cody K1 P014  
Ref. A  
Beckton Rose M126 WR

Beckton Cody K G701  
Beckton Tamara J124 HR  
Beckton Warrior T C371  
Beckton Rose D741 LN

Beckton Cherokee N N479  
Beckton CHRISTY R046 CQ  
Beckton Christy N740 HR

BFCK Cherokee Cryn 4912  
Beckton Dinah C440 NM  
Beckton Herald FJ J776  
Beckton Christy K141 VG

BWt	77
WR	116
ADG	4.23
YR	114
Scr.	39
Fr.	5.5

DAM	
Age	4
Wt	1140
Wean Pct.	57%
Cow Eff.	121

Calv.Ease	BW	WW	YW	Milk	HPG	Stay	Maint.En.	
EPDs	19	-4.8	61	95	27	14	24	-2.0
Acc.	(.65)	(.86)	(.83)	(.83)	(.71)	(.60)	(.54)	(.54)
Marb	+.37 (.51)		REA	+.06 (.53)		Bfat		+.04 (.37)

**A-3 BECKTON ACCENT D326 N4**  
1-A 100% # 3551708 Tattoo: BKT6 D326

Birth: 3-19-16

Beckton Accent W180 C2  
Beckton Cody K1 P014  
Beckton Christy R046 CQ  
Ref. A  
Beckton Lana W463 L

Beckton Loki CL S284  
Beckton Lana R327 EP  
Beckton Nebula P P707  
Beckton LYDIA S069 NB  
Beckton Lydia P583 WR

Beckton Nebula M045  
Beckton Lana M809 EP  
Beckton Warrior CL M686  
Beckton Lydia M121 WR

BWt	77
WR	111
ADG	4.22
YR	111
Scr.	39
Fr.	5.5

DAM	
Age	10
Wt	1005
Wean Pct.	60%
Cow Eff.	126

Calv.Ease	BW	WW	YW	Milk	HPG	Stay	Maint.En.	
EPDs	11	-1.0	72	115	27	13	20	-1.0
Acc.	(.40)	(.67)	(.61)	(.59)	(.24)	(.20)	(.26)	(.25)
Marb	+.56 (.26)		REA	-.06 (.39)		Bfat		+.04 (.21)

★★★★★ for Low Maintenance, Growth, Gainability, Marbling, High Cow Efficiency, Calving Ease.

★★★★★ for Low Maintenance, Growth, Gainability, Marbling, High Cow Efficiency.

**A-2 BECKTON ACCENT B549 N3**  
1-A 100% # 1705673 Tattoo: BKB4 B549

Birth: 3-31-14

Beckton Cody K1 P014  
Beckton ACCENT W180 C2  
Ref. A-1  
Beckton Christy R046 CQ

Beckton Cody KH M390  
Beckton Rose M126 WR  
Beckton Cherokee N N479  
Beckton Christy N740 HR

Beckton Nebula T398 V3  
Beckton MINERVA Y654 N  
Beckton Minerva M369 LO

Beckton Nebula L P093  
Beckton Minerva J615 VG  
Beckton Loki F251  
Beckton Minerva H403 LN

BWt	75
WR	119
ADG	4.77
YR	122
Scr.	39
Fr.	6.0

DAM	
Age	3
Wt	1046
Wean Pct.	54%
Cow Eff.	114

Calv.Ease	BW	WW	YW	Milk	HPG	Stay	Maint.En.	
EPDs	13	-2.4	72	121	24	12	19	15.0
Acc.	(.49)	(.75)	(.70)	(.70)	(.40)	(.19)	(.31)	(.32)
Marb	+.41 (.29)		REA	+.25 (.47)		Bfat		+.04 (.23)

★★★★★ for Growth, Gainability, Marbling, Rib-eye area, Calving Ease.

**A-4 BECKTON ACCENT E172 L3**  
1-A 100% # 3777901 Tattoo: BKB7 E172

Birth: 3-7-17

Beckton Cody K1 P014  
Beckton ACCENT W180 C2  
Ref. A-1  
Beckton Christy R046 CQ

Beckton Cody KH M390  
Beckton Rose M126 WR  
Beckton Cherokee N N479  
Beckton Christy N740 HR

Beckton Likable U130 L2  
Beckton INDIGO Y406 L  
Beckton Indigo R745 WR

Beckton Likable S633  
Beckton Kit S478 LN  
Beckton Warrior CL M686  
Beckton Indigo M514 CH

BWt	81
WR	112
ADG	3.67
YR	116
Scr.	39
Fr.	6.0

DAM	
Age	6
Wt	1095
Wean Pct.	58%
Cow Eff.	121

Calv.Ease	BW	WW	YW	Milk	HPG	Stay	Maint.En.	
EPDs	13	-2.7	63	97	27	13	22	-4.0
Acc.	(.37)	(.65)	(.59)	(.58)	(.28)	(.11)	(.21)	(.24)
Marb	+.29 (.26)		REA	+.24 (.36)		Bfat		+.03 (.20)

★★★★★ for Low Maintenance, Growth, Gainability, Marbling, Rib-eye area, High Cow Efficiency, Calving Ease.

• Reference Sires •

**A-5 BECKTON ACCENT F177 L5**  
1-A 100% # 3987894 Tattoo: BKT8 F177

Birth: 3-9-18

Beckton Accent Y260 L3 < Beckton Accent W180 C2  
Beckton Lana W463 L

**BECKTON ACCENT B150 N4**  
Ref. A < Beckton Nebula P P707  
< Beckton Larkeisa P688 CH

Beckton Likable Y124 L3 < Beckton Likable U130 L2  
< BKT Pine Marie S802 LO

**BECKTON VERNICE C782 L**  
< Beckton Legend S670  
< Beckton Vernice S713 JO

BWt	75
WR	126
ADG	3.17
YR	114
Scr.	37
Fr.	6.0

DAM	
Age	3
Wt	1100
Wean Pct.	57%
Cow Eff.	120

Calv.Ease	BW	WW	YW	Milk	HPG	Stay	Maint.En.	
EPDs	18	-5.7	47	74	27	13	20	0.0
Acc.	(.37)	(.62)	(.57)	(.55)	(.21)	(.07)	(.17)	(.22)
Marb	+0.59	(.18)	REA	-0.12	(.33)	Bfat	+0.05	(.16)

**A-8 BECKTON ACCENT G260 N3**  
1-A 100% # 4170530 Tattoo: BKT9 G260

Birth: 3-19-19

Beckton Accent U777 C2 < Beckton Cody K1 P014  
Beckton Susan R022 CQ

**BECKTON ACCENT B553 L2**  
Ref. A-3 < Beckton Legend S670  
< Beckton Lana S371 DM

Beckton New Era Y194 < Beckton Nebula P P707  
< BKT Larkeisa T310 JC

**BECKTON TAMARA B394 N**  
< Beckton Likable U130 L2  
< Beckton Tamara T201 CT

BWt	70
WR	101
ADG	4.13
YR	110
Scr.	36
Fr.	5.5

DAM	
Age	5
Wt	1140
Wean Pct.	48%
Cow Eff.	101

Calv.Ease	BW	WW	YW	Milk	HPG	Stay	Maint.En.	
EPDs	18	-5.3	54	91	26	12	17	2.0
Acc.	(.24)	(.49)	(.44)	(.43)	(.19)	(.05)	(.17)	(.16)
Marb	+0.50	(.20)	REA	+0.15	(.29)	Bfat	+0.03	(.19)

★★★★★ for Low Maintenance, Growth, Marbling, High Cow Efficiency, Calving Ease.

★★★★★ for Growth, Gainability, Marbling, Rib-eye area, Calving Ease.

**A-6 BECKTON ACCENT G107 C4**  
1-A 100% # 4170888 Tattoo: BKT9 G107

Birth: 3-8-19

Beckton Accent W180 C2 < Beckton Cody K1 P014  
Beckton Christy R046 CQ

**BECKTON ACCENT E172 L3**  
Ref. A-5 < Beckton Likable U130 L2  
< Beckton Indigo R745 WR

TR Double Eagle ZT220 < TR Ricardo DOS  
Beckton Lana U182 JC

**BECKTON PINE MARIE E206 D**  
< Beckton Jet L P491  
< BKT Pine Marie R056 CQ

BWt	59
WR	115
ADG	3.82
YR	116
Scr.	34
Fr.	5.0

DAM	
Age	2
Wt	885
Wean Pct.	51%
Cow Eff.	108

Calv.Ease	BW	WW	YW	Milk	HPG	Stay	Maint.En.	
EPDs	20	-5.9	62	97	30	11	20	-3.0
Acc.	(.30)	(.45)	(.44)	(.43)	(.16)	(.08)	(.15)	(.11)
Marb	+0.32	(.20)	REA	+0.37	(.31)	Bfat	+0.03	(.17)

★★★★★ for Low Maintenance, Growth, Gainability, Marbling, Rib-eye area, Calving Ease.

**B-1 BECKTON HUGHES C463 N2**  
1-A 100% # 3487375 Tattoo: BKT5 C463

Birth: 3-25-15

Basin Hobo 0545 < Basin Hobo 79E  
Basin Erica 330E

**BIEBER H HUGHES W109**  
Ref. B < Red Brylor New Trend 22  
< Basin Rose F521

Beckton Nexus L016 < Beckton Neptune R1 J245  
Beckton Coca J276 CL

**BECKTON LAKME T689 NX**  
< Beckton Epic K F075  
< Beckton Lakme F560 TP

BWt	80
WR	111
ADG	3.79
YR	106
Scr.	36
Fr.	5.0

DAM	
Age	8
Wt	1340
Wean Pct.	51%
Cow Eff.	108

Calv.Ease	BW	WW	YW	Milk	HPG	Stay	Maint.En.	
EPDs	16	-4.0	66	96	25	14	20	3.0
Acc.	(.34)	(.65)	(.60)	(.59)	(.28)	(.13)	(.25)	(.30)
Marb	+0.31	(.27)	REA	+0.11	(.38)	Bfat	+0.04	(.20)

★★★★★ for Growth, Gainability, Marbling, Calving Ease.

**A-7 BECKTON ACCENT G208 N3**  
1-A 100% # 4170384 Tattoo: BKT9 G208

Birth: 3-15-19

Beckton Accent U777 C2 < Beckton Cody K1 P014  
Beckton Susan R022 CQ

**BECKTON ACCENT B553 L2**  
Ref. A-3 < Beckton Legend S670  
< Beckton Lana S371 DM

Beckton New Era Y194 < Beckton Nebula P P707  
< BKT Larkeisa T310 JC

**BECKTON SIERRA A836 N**  
< Beckton Warrior T1 H281  
< Beckton Sierra N766 HR

BWt	90
WR	118
ADG	4.08
YR	119
Scr.	37
Fr.	5.5

DAM	
Age	6
Wt	1200
Wean Pct.	53%
Cow Eff.	112

Calv.Ease	BW	WW	YW	Milk	HPG	Stay	Maint.En.	
EPDs	9	2.0	79	132	20	13	16	2.0
Acc.	(.24)	(.48)	(.44)	(.43)	(.18)	(.05)	(.17)	(.16)
Marb	+0.36	(.20)	REA	+0.25	(.30)	Bfat	+0.03	(.17)

★★★★★ for Growth, Gainability, Marbling, Rib-eye area.

**B-2 BECKTON ROOSEVELT D305 C2**  
1-A 100% # 3551781 Tattoo: BKT6 D305

Birth: 3-18-16

Bieber Rough Rider 10712 < Basin Trend Setter 6074  
Bieber Adelle 8958

**BIEBER ROOSEVELT W384**  
Ref. B < C A Future Direction 5321  
< Bieber Sheba 5537

Beckton Cody K1 P014 < Beckton Cody KH M390  
Beckton Rose M126 WR

**BECKTON LANA W277 A**  
< Beckton Loki F251  
< Beckton Lana D232 HV

BWt	78
WR	112
ADG	4.11
YR	111
Scr.	36
Fr.	5.5

DAM	
Age	7
Wt	1080
Wean Pct.	58%
Cow Eff.	121

Calv.Ease	BW	WW	YW	Milk	HPG	Stay	Maint.En.	
EPDs	13	-0.4	61	96	27	12	17	-2.0
Acc.	(.35)	(.60)	(.54)	(.52)	(.28)	(.12)	(.25)	(.23)
Marb	+0.36	(.30)	REA	+0.04	(.37)	Bfat	+0.05	(.23)

★★★★★ for Low Maintenance, Growth, Gainability, Marbling, High Cow Efficiency, Calving Ease.

• Reference Sires •

### C-1 BECKTON CARDINAL B074 N

1-A 100% # 1706184 Tattoo: BKT4 B074

Birth: 2-24-14

TR DOUBLE EAGLE ZT220  
Ref. C

BKT PINE MARIE Z250 N

BFCK Cherokee Cnyn 4912  
TR Dyna LT111

Beckton Justice C1 R483  
Beckton Lana H544 WR

Beckton Nebula M045  
Beckton Larkeisa M138 JC

Beckton Nebula J R475  
BKT Pine Marie U621 NB

Beckton Nebula P P707  
BKT Pine Marie P475 LN

BWt	57
WR	102
ADG	4.38
YR	109
Scr.	36
Fr.	5.5

DAM	
Age	2
Wt	834
Wean Pct.	49%
Cow Eff.	103

Calv.Ease	BW	WW	YW	Milk	HPG	Stay	Maint.En.
EPDs	22	-9.2	45	81	26	13	0.0
Acc.	(.46)	(.66)	(.60)	(.61)	(.36)	(.08)	(.33)
Marb	+.35 (.27)		REA +.10 (.44)		Bfat +.03 (.22)		

### D-1 BECKTON DOMINOR D254 N8

1-A 100% # 3551799 Tattoo: BKT6 D254

Birth: 3-15-16

BECKTON DOMINOR A378 W7  
Ref. D

BECKTON INDIGO W772 N

Beckton Dominor Y005 V6  
Beckton Lana Y541 W

Beckton Dominor W640 C5  
Beckton Belga W108 V

Beckton Warrior T248 L5  
Beckton Lana S074 EP

Beckton Nebula T398 V3  
Beckton Indigo T613 JT

Beckton Nebula L P093  
Beckton Minerva J615 VG

TR Julian LT151  
Beckton Indigo N467 LO

BWt	67
WR	101
ADG	4.72
YR	110
Scr.	41
Fr.	5.5

DAM	
Age	7
Wt	1090
Wean Pct.	50%
Cow Eff.	106

Calv.Ease	BW	WW	YW	Milk	HPG	Stay	Maint.En.
EPDs	21	-6.4	46	81	34	13	20
Acc.	(.36)	(.70)	(.66)	(.66)	(.27)	(.15)	(.20)
Marb	+.44 (.28)		REA +.21 (.38)		Bfat +.04 (.20)		

★★★★★ for Low Maintenance, Growth, Gainability, Marbling, Calving Ease.

★★★★★ for Growth, Gainability, Marbling, Rib-eye area, Calving Ease.

### C-2 BECKTON CARDINAL E673 L

1-A 100% # 3776785 Tattoo: BKT7 E673

Birth: 4-12-17

TR DOUBLE EAGLE ZT220  
Ref. C

BECKTON LARKABA A911 L

TR Ricardo DOS  
Beckton Lana U182 JC

Beckton Legend U331 E2  
Beckton Larkaba T418 WA

BFCK Cherokee Cnyn 4912  
TR Dyna LT111

Beckton Justice C1 R483  
Beckton Lana H544 WR

Beckton Legend S670  
Beckton Lana S669 EP

Beckton Warhawk N560  
Beckton Larkaba P783 JL

BWt	51
WR	104
ADG	2.69
YR	97
Scr.	33
Fr.	5.0

DAM	
Age	4
Wt	1035
Wean Pct.	51%
Cow Eff.	108

Calv.Ease	BW	WW	YW	Milk	HPG	Stay	Maint.En.
EPDs	22	-7.4	63	101	31	12	19
Acc.	(.32)	(.66)	(.60)	(.60)	(.24)	(.06)	(.17)
Marb	+.57 (.20)		REA +.44 (.33)		Bfat +.04 (.20)		

★★★★★ for Low Maintenance, Marbling, Rib-eye area, Calving Ease.

### D-2 BECKTON DOMINOR F263 N8

1-A 100% # 3987796 Tattoo: BKT8 F263

Birth: 3-15-18

BECKTON DOMINOR A378 W7  
Ref. D

BECKTON LARKABA W272 N

Beckton Dominor Y005 V6  
Beckton Lana Y541 W

Beckton Dominor W640 C5  
Beckton Belga W108 V

Beckton Warrior T248 L5  
Beckton Lana S074 EP

Beckton Nebula EN S347  
Beckton Larkaba N643 HR

Beckton Nebula E P084  
Beckton Eola P530 NB

Beckton Herald FJ J776  
Beckton Larkaba J765 CH

BWt	72
WR	119
ADG	2.50
YR	107
Scr.	36
Fr.	5.5

DAM	
Age	9
Wt	980
Wean Pct.	65%
Cow Eff.	137

Calv.Ease	BW	WW	YW	Milk	HPG	Stay	Maint.En.
EPDs	19	-3.0	57	97	33	14	17
Acc.	(.35)	(.58)	(.53)	(.52)	(.23)	(.15)	(.24)
Marb	+.41 (.25)		REA +.18 (.32)		Bfat +.05 (.20)		

★★★★★ for Growth, Marbling, Rib-eye area, High Cow Efficiency, Calving Ease.

### C-3 BECKTON CARDINAL G043 C2

1-A 100% # 4170880 Tattoo: BKT9 G043

Birth: 2-24-19

BECKTON CARDINAL E673 L  
Ref. C-1

BECKTON MINERVA E181 D

TR Double Eagle ZT220  
Beckton Larkaba A911 L

TR Double Eagle ZT220  
Beckton Minerva W901 J

TR Ricardo DOS  
Beckton Lana U182 JC

Beckton Legend U331 E2  
Beckton Larkaba T418 WA

TR Ricardo DOS  
Beckton Lana U182 JC

Beckton Julian G3 P608  
Beckton Minerva L344 CH

BWt	59
WR	117
ADG	3.87
YR	119
Scr.	34
Fr.	5.5

DAM	
Age	2
Wt	725
Wean Pct.	61%
Cow Eff.	127

Calv.Ease	BW	WW	YW	Milk	HPG	Stay	Maint.En.
EPDs	20	-5.5	64	105	30	13	-3.0
Acc.	(.32)	(.52)	(.49)	(.47)	(.19)	(.06)	(.11)
Marb	+.44 (.20)		REA +.43 (.31)		Bfat +.03 (.18)		

★★★★★ for Low Maintenance, Growth, Gainability, Marbling, Rib-eye area, High Cow Efficiency, Calving Ease.

### D-3 BECKTON DOMINOR G402 A9

1-A 100% # 4170856 Tattoo: BKT9 G402

Birth: 3-26-19

BECKTON DOMINOR D254 N8  
Ref. D-2

BECKTON LANA D273 A

Beckton Dominor A378 W7  
Beckton Indigo W772 N

Beckton Dominor Y005 V6  
Beckton Lana Y541 W

Beckton Nebula T398 V3  
Beckton Indigo T613 JT

Beckton Accent B549 N3  
Beckton Lana B666 S

Beckton Accent W180 C2  
Beckton Minerva Y654 N

Beckton Scamp X494 E3  
Beckton Lana Y022 N

BWt	65
WR	117
ADG	3.98
YR	119
Scr.	36
Fr.	5.5

DAM	
Age	3
Wt	1120
Wean Pct.	47%
Cow Eff.	99

Calv.Ease	BW	WW	YW	Milk	HPG	Stay	Maint.En.
EPDs	20	-6.9	52	87	27	13	18
Acc.	(.23)	(.51)	(.45)	(.39)	(.17)	(.04)	(.13)
Marb	+.39 (.19)		REA +.16 (.30)		Bfat +.04 (.17)		

★★★★★ for Low Maintenance, Growth, Gainability, Marbling, Rib-eye area, Calving Ease.

• Reference Sires •

### D-4 BECKTON DOMINOR G461 N8

1-A 100% # 4170594 Tattoo: BKT9 G461

Birth: 3-28-19

Beckton Dominor Y005 V6 < Beckton Dominor W640 C5  
Beckton Belga W108 V

**BECKTON DOMINOR A378 W7**  
Ref. D < Beckton Warrior T248 L5  
Beckton Lana Y541 W < Beckton Lana S074 EP

Beckton Nebula EN S347 < Beckton Nebula E P084  
Beckton Eola P530 NB

**BECKTON ROSE C767 N**  
Beckton Rose W816 C < BKT Clifftop TP R288  
Beckton Rose S487 LN

BWt	70
WR	118
ADG	3.59
YR	114
Scr.	35
Fr.	5.5

DAM	
Age	4
Wt	1040
Wean Pct.	55%
Cow Eff.	116

Calv.Ease	BW	WW	YW	Milk	HPG	Stay	Maint.En.
EPDs	19	-3.5	55	93	33	13	-4.0
Acc.	(.26)	(.47)	(.42)	(.41)	(.23)	(.11)	(.17)
Marb	+.50 (.21)		REA +.18 (.28)		Bfat +.05 (.18)		

### H-2 BECKTON HERITAGE C477 J4

1-A 100% # 3487214 Tattoo: BKT5 C477

Birth: 3-28-15

Beckton Heritage T270 J2 < Beckton Heritage N013  
Beckton Coca P602 JL

**BECKTON HERITAGE X403 L3**  
Ref. H < Beckton Lancer TE F363  
Beckton Indigo H150 LN < Beckton Indigo F376 CT

Beckton Julian U699 L5 < Beckton Julian G1 J526  
Beckton Rose L311 LN

**BECKTON RUTH Z858 J**  
Beckton Ruth U557 JT < Beckton Jet L P491  
Beckton Ruth P591 LN

BWt	77
WR	103
ADG	4.25
YR	111
Scr.	41
Fr.	5.0

DAM	
Age	3
Wt	1025
Wean Pct.	54%
Cow Eff.	113

Calv.Ease	BW	WW	YW	Milk	HPG	Stay	Maint.En.
EPDs	13	-1.8	61	103	30	13	-1.0
Acc.	(.45)	(.68)	(.64)	(.64)	(.28)	(.17)	(.30)
Marb	+.38 (.30)		REA +.29 (.42)		Bfat +.04 (.26)		

★★★★★ for Low Maintenance, Growth, Gainability, Marbling, Rib-eye area, High Cow Efficiency, Calving Ease.

★★★★★ for Low Maintenance, Growth, Gainability, Marbling, Rib-eye area, Calving Ease.

### E-1 BECKTON EPIC F279 A7

1-A 100% # 3987780 Tattoo: BKT8 F279

Birth: 3-16-18

Beckton Epic U749 D5 < Beckton Epic K4 N795  
Beckton Denise R308 DM

**BECKTON EPIC Z674 E6**  
Ref. E < Beckton Epic K6 S569  
Beckton Indigo U504 EP < Beckton Indigo S016 NB

Beckton Accent W180 C2 < Beckton Cody K1 P014  
Beckton Christy R046 CQ

**BECKTON FIREFLY B511 A**  
Beckton Firefly X336 H < Beckton Hasten U108 J3  
Beckton Firefly U337 HH

BWt	80
WR	123
ADG	3.44
YR	119
Scr.	36
Fr.	6.0

DAM	
Age	4
Wt	1200
Wean Pct.	53%
Cow Eff.	112

Calv.Ease	BW	WW	YW	Milk	HPG	Stay	Maint.En.
EPDs	18	-3.4	63	104	30	10	4.0
Acc.	(.32)	(.57)	(.51)	(.50)	(.22)	(.07)	(.22)
Marb	+.39 (.21)		REA +.09 (.32)		Bfat +.05 (.19)		

★★★★★ for Growth, Marbling, Calving Ease.

### H-3 BECKTON HERITAGE F615 L5

1-A 100% # 3988420 Tattoo: BSF8 F615

Birth: 4-4-18

Beckton Heritage T270 J2 < Beckton Heritage X403 L3  
Beckton Indigo H150 LN

**BECKTON HERITAGE B612 J4**  
Ref. H < Beckton Justice G302  
Beckton Lana N291 JC < Beckton Lana H725 CH

Beckton Likable U130 L2 < Beckton Likable S633  
Beckton Kit S478 LN

**BECKTON MONA X022 L**  
Beckton Mona U584 CD < Beckton Cody K2 R168  
Beckton Mona P539 CH

BWt	76
WR	119
ADG	3.50
YR	114
Scr.	35
Fr.	5.5

DAM	
Age	8
Wt	1105
Wean Pct.	58%
Cow Eff.	121

Calv.Ease	BW	WW	YW	Milk	HPG	Stay	Maint.En.
EPDs	9	-2.5	62	85	25	12	-5.0
Acc.	(.36)	(.60)	(.53)	(.52)	(.23)	(.06)	(.18)
Marb	+.42 (.21)		REA +.05 (.35)		Bfat +.04 (.18)		

★★★★★ for Low Maintenance, Growth, Gainability, Marbling, High Cow Efficiency, Calving Ease.

### H-1 BECKTON HALFMANNHUSTLER R588

1-A 100% # 1042326 Tattoo: BKT5 R588

Birth: 4-1-05

Beckton Hustler C G407 < LCC Heaven or Bust 1000B  
Beckton Rose E032 CL

**BECKTON HUSTLER CN J102**  
Ref. < Beckton Neptune RR B284  
Beckton Belga G355 NP < Beckton Belga B061 ZN

Beckton Clipper JMA124 < Beckton Clipper J 9956  
Beckton Mona 9766 MJ

**BECKTON VERNICE F513 CL**  
Beckton Vernice A663 PC < Beckton Pacer 8940  
Bkt Vernice 8994 NM

BWt	67
WR	103
ADG	4.68
YR	111
Scr.	36
Fr.	6.0

DAM	
Age	10
Wt	1305
Wean Pct.	48%
Cow Eff.	100

Calv.Ease	BW	WW	YW	Milk	HPG	Stay	Maint.En.
EPDs	18	-6.6	56	104	17	10	13.0
Acc.	(.73)	(.88)	(.84)	(.85)	(.76)	(.77)	(.55)
Marb	+.46 (.54)		REA -.19 (.68)		Bfat +.04 (.47)		

★★★★★ for Growth, Gainability, Marbling, Calving Ease.

### H-4 BECKTON HERITAGE G152 L5

1-A 100% # 4171422 Tattoo: BSF9 G152

Birth: 3-11-19

Beckton Heritage A767 C3 < Beckton Heritage X356 E2  
Beckton Rose W816 C

**BECKTON HERITAGE D195 L4**  
Ref. H < Beckton Loki CL S284  
Beckton Susan W846 L < Beckton Susan S684 JJ

Beckton Legend S670 < Beckton Lancer F442 T  
Beckton Kit F468 JL

**BECKTON BELGA B647 L**  
Beckton Belga U103 JC < Beckton Justice C1 R483  
Beckton Belga M883 DM

BWt	67
WR	103
ADG	3.70
YR	104
Scr.	35
Fr.	5.0

DAM	
Age	5
Wt	1080
Wean Pct.	52%
Cow Eff.	109

Calv.Ease	BW	WW	YW	Milk	HPG	Stay	Maint.En.
EPDs	17	-4.9	60	99	28	12	15
Acc.	(.23)	(.45)	(.40)	(.39)	(.18)	(.10)	(.14)
Marb	+.50 (.20)		REA +.07 (.28)		Bfat +.02 (.16)		

★★★★★ for Low Maintenance, Gainability, Marbling, Calving Ease.

• Reference Sires •

**J-1 BECKTON JULIAN GG B571**  
1-A 100% # 387580 Tattoo: WF2 B571

Birth: 3-27-92

Beckton Julian 6592  
 Beckton Trojan 5253  
 Lchmn Christy 2339

**BECKTON JULIAN 7526G**  
Ref. Bkt Belga 6746 GS  
 Beckton Gisa 4454  
 Beckton Lalaxigu -2

**BKT MARTA 9A13 JL**  
Beckton Julian 7526G  
 Beckton Julian 6592  
 Bkt Belga 6746 GS  
 Beckton Xime 4736  
 Bkt Marta 6498 XM  
 Beckton Marwa -K

BWt	65
WR	113
ADG	3.18
YR	112
Scr.	NA
Fr.	5.0

DAM	
Age	3
Wt	1015
Wean Pct.	56%
Cow Eff.	118

Calv.Ease	BW	WW	YW	Milk	HPG	Stay	Maint.En.	
EPDs	20	-7.2	48	75	24	15	-7.0	
Acc.	(.88)	(.93)	(.92)	(.92)	(.89)	(.91)	(.58)	
Marb	+.46 (.82)		REA	+.09 (.83)		Bfat	+.04 (.76)	

★★★★★ for Low Maintenance, Growth, Marbling, High Cow Efficiency, Calving Ease.

**J-4 BECKTON JULIAN A434 N6**  
1-A 100% # 1626302 Tattoo: BKT3 A434

Birth: 3-27-13

Beckton Julian G5 S107  
 Beckton Julian GJ P535  
 Beckton Minola P826 DM

**BECKTON JULIAN X465 J5**  
Ref. J Beckton Suffeina P643 JL  
 Beckton Julian GG B571  
 Bkt Suffeina A828 DM

**BECKTON LAKME T689 NX**  
Beckton Nexus L016  
 Beckton Neptune R1 J245  
 Beckton Coca J276 CL  
 Beckton Epic K F075  
 Beckton Lakme M669 EP  
 Beckton Lakme F560 TP

BWt	75
WR	112
ADG	4.16
YR	112
Scr.	33
Fr.	6.0

DAM	
Age	6
Wt	1085
Wean Pct.	57%
Cow Eff.	121

Calv.Ease	BW	WW	YW	Milk	HPG	Stay	Maint.En.	
EPDs	12	-1.3	70	113	21	10	18	
Acc.	(.51)	(.57)	(.54)	(.53)	(.30)	(.26)	(.33)	
Marb	+.49 (.44)		REA	-.09 (.46)		Bfat	+.03 (.32)	

★★★★★ for Low Maintenance, Growth, Gainability, Marbling, High Cow Efficiency, Calving Ease.

**J-2 BECKTON JULIAN G3 P608**  
1-A 100% # 978932 Tattoo: WF4 P608

Birth: 3-27-04

Beckton Julian 7526G  
 Beckton Julian 6592  
 Bkt Belga 6746 GS

**BECKTON JULIAN GG B571**  
Ref. J-1 Bkt Marta 9A13 JL  
 Beckton Julian 7526G  
 Bkt Marta 6498 XM

**BKT SUFFEINA A828 DM**  
Beckton Dominor 9455  
 Beckton Dorado 8411V  
 Bkt Firefly 8734 DR  
 Beckton Titan 7965  
 Bkt Suffeina 9493 TT  
 Bch Rch Claudia 2140

BWt	72
WR	106
ADG	3.87
YR	111
Scr.	35
Fr.	5.0

DAM	
Age	13
Wt	NA
Wean Pct.	NA%
Cow Eff.	NA

Calv.Ease	BW	WW	YW	Milk	HPG	Stay	Maint.En.	
EPDs	22	-7.3	38	61	23	14	-13.0	
Acc.	(.57)	(.81)	(.76)	(.78)	(.66)	(.69)	(.52)	
Marb	+.44 (.23)		REA	-.04 (.25)		Bfat	+.01 (.22)	

★★★★★ for Low Maintenance, Growth, Gainability, Marbling, Calving Ease.

**J-5 BECKTON JULIAN F067 L7**  
1-A 100% # 3988836 Tattoo: BSF8 F067

Birth: 2-23-18

Beckton Julian X465 J5  
 Beckton Julian G5 S107  
 Beckton Suffeina P643 JL

**BECKTON JULIAN D551 C6**  
Ref. J Beckton Tamara W550 A  
 Beckton Cody K1 P014  
 Beckton Tamara R175 CQ

**BECKTON INDIGO D786 L**  
Beckton Likable Z057 L4  
 Beckton Likable X445 J3  
 Beckton Minola X107 L  
 Beckton Nebula W065 C3  
 Beckton Indigo Y026 N  
 Beckton Indigo W866 A

BWt	53
WR	113
ADG	4.28
YR	120
Scr.	34
Fr.	6.0

DAM	
Age	2
Wt	800
Wean Pct.	61%
Cow Eff.	128

Calv.Ease	BW	WW	YW	Milk	HPG	Stay	Maint.En.	
EPDs	21	-5.1	58	113	28	12	13.0	
Acc.	(.34)	(.60)	(.53)	(.50)	(.19)	(.07)	(.13)	
Marb	+.50 (.23)		REA	-.02 (.33)		Bfat	+.05 (.19)	

★★★★★ for Growth, Gainability, Marbling, High Cow Efficiency, Calving Ease.

**J-3 BECKTON JULIAN Z382 J7**  
1-A 100% # 1544962 Tattoo: BKT2 Z382

Birth: 3-20-12

Beckton Julian U699 L5  
 Beckton Julian G1 J526  
 Beckton Rose L311 LN

**BECKTON JULIAN X721 E6**  
Ref. J Beckton Lana U329 EP  
 Beckton Epic K6 S569  
 Beckton Lana S477 LN

**BECKTON LARKABA X064 J**  
Beckton Julian U699 L5  
 Beckton Julian G1 J526  
 Beckton Rose L311 LN  
 BKT Clifftop TP R288  
 Beckton Larkaba U475 CT  
 Beckton Larkaba R809 NB

BWt	47
WR	125
ADG	2.99
YR	113
Scr.	33
Fr.	5.0

DAM	
Age	2
Wt	755
Wean Pct.	80%
Cow Eff.	168

Calv.Ease	BW	WW	YW	Milk	HPG	Stay	Maint.En.	
EPDs	22	-8.7	57	88	28	13	-4.0	
Acc.	(.49)	(.71)	(.66)	(.67)	(.49)	(.37)	(.41)	
Marb	+.36 (.38)		REA	-.04 (.47)		Bfat	+.06 (.27)	

★★★★★ for Low Maintenance, Growth, Marbling, High Cow Efficiency, Calving Ease.

**J-6 BECKTON JET G441 N2**  
1-A 100% # 4170464 Tattoo: BKT9 G441

Birth: 3-27-19

TR Julian L151  
 BECKTON JULIAN GG B571  
 MS GEOMETRIC 917

**BECKTON JET L P491**  
Ref. J Beckton Minerva L278 LN  
 Beckton Lancer TS D390  
 Beckton Minerva F495 CH

**BECKTON SUSAN B246 N**  
Beckton New Era Y194  
 Beckton Nebula P P707  
 BKT Larkeisa T310 JC  
 Beckton Cherokee N N479  
 Beckton Susan R022 CQ  
 Beckton Susan N023 JE

BWt	66
WR	104
ADG	3.33
YR	108
Scr.	39
Fr.	5.0

DAM	
Age	5
Wt	1040
Wean Pct.	51%
Cow Eff.	106

Calv.Ease	BW	WW	YW	Milk	HPG	Stay	Maint.En.	
EPDs	20	-7.4	53	83	29	11	-6.0	
Acc.	(.25)	(.48)	(.44)	(.42)	(.26)	(.16)	(.18)	
Marb	+.50 (.24)		REA	-.01 (.30)		Bfat	+.03 (.21)	

★★★★★ for Low Maintenance, Growth, Marbling, Calving Ease.

• Reference Sires •

**L-1 BECKTON LIKABLE B032 C5**  
1-A 100% # 1705725 Tattoo: BKB4 B032

Birth: 2-17-14

Beckton Likable X445 J3 < Beckton Likable U130 L2  
Beckton Indigo U658 JL

**BECKTON LIKABLE Z057 L4**  
Ref. L < Beckton Likable U120 L2  
Beckton Minola X107 L < Beckton Minola U188 NB

Beckton Clifftop W577 E3 < BKT Clifftop TP R288  
BKT Pine Marie R213 EP

**BECKTON MONA Z270 C**  
Beckton Mona U584 CD < Beckton Cody K2 R168  
Beckton Mona P539 CH

BWt	63
WR	110
ADG	4.72
YR	119
Scr.	35
Fr.	6.0

DAM	
Age	2
Wt	884
Wean Pct.	50%
Cow Eff.	106

Calv.Ease	BW	WW	YW	Milk	HPG	Stay	Maint.En.	
EPDs	17	-5.8	52	110	17	14	15.0	
Acc.	(.54)	(.75)	(.72)	(.72)	(.40)	(.28)	(.35)	
Marb	+.54 (.27)		REA	+.04 (.47)		Bfat	+.03 (.25)	

★★★★★ for Growth, Gainability, Marbling, Calving Ease.

**L-4 BECKTON LIKABLE E391 N4**  
1-A 100% # 3777591 Tattoo: BKB7 E391

Birth: 3-23-17

Beckton Likable U130 L2 < Beckton Likable S633  
Beckton Kit S478 LN

**BECKTON LIKABLE Y124 L3**  
Ref. L-1 < BKT Pine Marie S802 LO  
Beckton Lasso P741 < BKT Pine Marie P475 LN

Beckton Nebula T398 V3 < Beckton Nebula L P093  
Beckton Minerva J615 VG

**BECKTON LANA X466 N**  
Beckton Lana T226 NB < Beckton Nebula E P084  
Beckton Lana P026 DM

BWt	83
WR	115
ADG	3.44
YR	115
Scr.	37
Fr.	6.0

DAM	
Age	7
Wt	1220
Wean Pct.	53%
Cow Eff.	111

Calv.Ease	BW	WW	YW	Milk	HPG	Stay	Maint.En.	
EPDs	12	-2.4	71	108	27	11	21	
Acc.	(.37)	(.68)	(.63)	(.62)	(.25)	(.08)	(.18)	
Marb	+.45 (.23)		REA	-.11 (.36)		Bfat	+.05 (.15)	

★★★★★ for Growth, Marbling, Calving Ease.

**L-2 BECKTON LIKABLE C229 R3**  
1-A 100% # 3487279 Tattoo: BKT5 C229

Birth: 3-16-15

Beckton Likable S633 < Beckton Lancer F442 T  
Beckton Kit F468 JL

**BECKTON LIKABLE U130 L2**  
Ref. L < Beckton Lancer F442 T  
Beckton Kit S478 LN < Beckton Kit F468 JL

Beckton Roman J S158 < TR Romeo NT379  
Beckton Belga K285 JL

**BECKTON TAMARA X447 J**  
Beckton Tamara R834 JC < Beckton Justice CH M056  
Beckton Tamara J229 NP

BWt	84
WR	119
ADG	3.91
YR	117
Scr.	37
Fr.	5.0

DAM	
Age	5
Wt	1240
Wean Pct.	57%
Cow Eff.	120

Calv.Ease	BW	WW	YW	Milk	HPG	Stay	Maint.En.	
EPDs	13	-1.1	67	103	27	10	17	
Acc.	(.41)	(.67)	(.62)	(.62)	(.32)	(.18)	(.28)	
Marb	+.34 (.28)		REA	+.36 (.43)		Bfat	+.04 (.28)	

★★★★★ for Growth, Gainability, Marbling, Rib-eye area, High Cow Efficiency, Calving Ease.

**L-5 BECKTON LIKABLE F242 D4**  
1-A 100% # 3987814 Tattoo: BKT8 F242

Birth: 3-14-18

Beckton Likable U130 L2 < Beckton Likable S633  
Beckton Kit S478 LN

**BECKTON LIKABLE Y124 L3**  
Ref. L-1 < BKT Pine Marie S802 LO  
Beckton Lasso P741 < BKT Pine Marie P475 LN

Beckton Dominor W640 C5 < Beckton Dominor Z1 R610  
Beckton Mona R166 CQ

**BECKTON FIREFLY A022 D**  
Beckton Firefly U801 NB < Beckton Nebula N R573  
Beckton Firefly K180 CH

BWt	52
WR	112
ADG	2.94
YR	106
Scr.	35
Fr.	5.0

DAM	
Age	5
Wt	1200
Wean Pct.	53%
Cow Eff.	112

Calv.Ease	BW	WW	YW	Milk	HPG	Stay	Maint.En.	
EPDs	24	-9.8	46	69	28	12	16	
Acc.	(.33)	(.57)	(.52)	(.51)	(.22)	(.08)	(.15)	
Marb	+.28 (.22)		REA	+.00 (.33)		Bfat	+.04 (.18)	

★★★★★ for Low Maintenance, Growth, Marbling, Calving Ease.

**L-3 BECKTON LIKABLE D432 N3**  
1-A 100% # 3551764 Tattoo: BKT6 D432

Birth: 3-23-16

Beckton Likable S633 < Beckton Lancer F442 T  
Beckton Kit F468 JL

**BECKTON LIKABLE U130 L2**  
Ref. L < Beckton Lancer F442 T  
Beckton Kit S478 LN < Beckton Kit F468 JL

Beckton Nebula T054 H3 < Beckton Nebula J R475  
BKT Pine Marie R401 HU

**BECKTON FIREFLY W013 N**  
Beckton Firefly T003 JC < Beckton Justice C1 R483  
Beckton Firefly R064 NW

BWt	75
WR	94
ADG	4.05
YR	105
Scr.	36
Fr.	5.5

DAM	
Age	7
Wt	890
Wean Pct.	59%
Cow Eff.	123

Calv.Ease	BW	WW	YW	Milk	HPG	Stay	Maint.En.	
EPDs	17	-3.3	55	91	23	11	18	
Acc.	(.41)	(.65)	(.61)	(.61)	(.33)	(.18)	(.29)	
Marb	+.34 (.27)		REA	+.33 (.43)		Bfat	+.03 (.25)	

★★★★★ for Low Maintenance, Gainability, Marbling, Rib-eye area, High Cow Efficiency, Calving Ease.

**L-6 BECKTON LIKABLE F287 J6**  
1-A 100% # 3987766 Tattoo: BKT8 F287

Birth: 3-16-18

Beckton Likable Z057 L4 < Beckton Likable X445 J3  
Beckton Minola X107 L

**BECKTON LIKABLE B032 C5**  
Ref. L-2 < Beckton Mona Z270 C  
Beckton Clifftop W577 E3 < Beckton Mona U584 CD

Beckton Julian U699 L5 < Beckton Julian G1 J526  
Beckton Rose L311 LN

**BECKTON LARKABA X064 J**  
Beckton Larkaba U475 CT < BKT Clifftop TP R288  
Beckton Larkaba R809 NB

BWt	56
WR	102
ADG	3.56
YR	108
Scr.	35
Fr.	5.5

DAM	
Age	8
Wt	915
Wean Pct.	60%
Cow Eff.	126

Calv.Ease	BW	WW	YW	Milk	HPG	Stay	Maint.En.	
EPDs	19	-7.5	54	101	20	14	18	
Acc.	(.32)	(.58)	(.54)	(.52)	(.23)	(.14)	(.19)	
Marb	+.58 (.20)		REA	-.09 (.32)		Bfat	+.05 (.18)	

★★★★★ for Growth, Gainability, Marbling, High Cow Efficiency, Calving Ease.



• Reference Sires •

**L-7 BECKTON LIKABLE G026 L5**  
1-A 100% # 4171840 Tattoo: BSF9 G026

Birth: 2-19-19

Beckton Likable Y124 L3 < Beckton Likable U130 L2  
BKT Pine Marie S802 LO

**BECKTON LIKABLE E391 N4**  
Ref. L-4 < Beckton Nebula T398 V3  
Beckton Lana X466 N < Beckton Lana T226 NB

Beckton Likable C584 E4 < Beckton Likable Y362 L3  
Beckton Susan T685 EP

**BECKTON ANGEL E130 L**  
Beckton Angel C816 L < Beckton Likable Y362 L3  
Beckton Angel X450 N

BWt	46
WR	115
ADG	3.87
YR	121
Scr.	31
Fr.	5.5

DAM	
Age	2
Wt	825
Wean Pct.	52%
Cow Eff.	109

Calv.Ease	BW	WW	YW	Milk	HPG	Stay	Maint.En.	
EPDs	17	-5.6	62	101	26	9	17	2.0
Acc.	(.33)	(.52)	(.49)	(.47)	(.20)	(.02)	(.15)	(.12)
Marb	+0.48	(.20)	REA	-0.06	(.32)	Bfat	+0.04	(.17)

★★★★★ for Growth, Gainability, Marbling, Calving Ease.

**N-1 BECKTON NEBULA EN S347**  
1-A 100% # 1118810 Tattoo: WF6 S347

Birth: 3-13-06

Beckton Nebula M045 < Beckton Neptune R2 K065  
Beckton Belga K285 JL

**BECKTON NEBULA E P084**  
Ref. N < Beckton Epic K F075  
Bkt Pine Marie D126 JL

Beckton Nebula M045 < Beckton Neptune R2 K065  
Beckton Belga K285 JL

**BECKTON EOALA P530 NB**  
Beckton Eola M663 EP < Beckton Epic K1 K863  
Beckton Eola K178 EP

BWt	55
WR	97
ADG	4.13
YR	97
Scr.	NA
Fr.	4.5

DAM	
Age	2
Wt	750
Wean Pct.	60%
Cow Eff.	127

Calv.Ease	BW	WW	YW	Milk	HPG	Stay	Maint.En.	
EPDs	21	-8.3	47	66	41	12	17	-12.0
Acc.	(.51)	(.74)	(.70)	(.71)	(.54)	(.53)	(.38)	(.48)
Marb	+0.58	(.38)	REA	-0.50	(.51)	Bfat	+0.07	(.33)

★★★★★ for Low Maintenance, Gainability, Marbling, High Cow Efficiency, Calving Ease.

**L-8 BECKTON LIKABLE G289 J5**  
1-A 100% # 4170516 Tattoo: BKT9 G289

Birth: 3-20-19

Beckton Likable X445 J3 < Beckton Likable U130 L2  
Beckton Indigo U658 JL

**BECKTON LIKABLE Z057 L4**  
Ref. L < Beckton Likable U120 L2  
Beckton Minola X107 L < Beckton Minola U188 NB

Beckton Julian GG B571 < Beckton Julian 7526G  
Bkt Marta 9A13 JL

**BECKTON COCA B785 J**  
Beckton Coca X787 N < Beckton Nebula T398 V3  
Beckton Coca P602 JL

BWt	78
WR	109
ADG	3.91
YR	114
Scr.	38
Fr.	5.5

DAM	
Age	5
Wt	985
Wean Pct.	56%
Cow Eff.	118

Calv.Ease	BW	WW	YW	Milk	HPG	Stay	Maint.En.	
EPDs	13	-3.2	57	102	25	13	16	-4.0
Acc.	(.32)	(.51)	(.48)	(.47)	(.29)	(.10)	(.23)	(.18)
Marb	+0.51	(.29)	REA	+0.13	(.36)	Bfat	+0.03	(.26)

★★★★★ for Low Maintenance, Growth, Gainability, Marbling, Rib-eye area, High Cow Efficiency, Calving Ease.

**N-2 BECKTON NEBULA A773 L4**  
1-A 100% # 1625980 Tattoo: BKB3 A773

Birth: 4-13-13

Beckton Nebula L P093 < Beckton Nebula M045  
Beckton Marta M021 LN

**BECKTON NEBULA T398 V3**  
Ref. N < Beckton Vegas PK F485  
Beckton Minerva J615 VG < Beckton Minerva F433 VG

Beckton Likable U130 L2 < Beckton Likable S633  
Beckton Kit S478 LN

**BECKTON MONA X022 L**  
Beckton Mona U584 CD < Beckton Cody K2 R168  
Beckton Mona P539 CH

BWt	66
WR	118
ADG	3.54
YR	109
Scr.	36
Fr.	5.5

DAM	
Age	3
Wt	955
Wean Pct.	61%
Cow Eff.	128

Calv.Ease	BW	WW	YW	Milk	HPG	Stay	Maint.En.	
EPDs	13	-2.5	66	99	30	12	26	3.0
Acc.	(.42)	(.70)	(.65)	(.66)	(.38)	(.11)	(.31)	(.33)
Marb	+0.32	(.30)	REA	+0.12	(.44)	Bfat	+0.03	(.23)

★★★★★ for Growth, Gainability, Marbling, High Cow Efficiency, Calving Ease.

**L-9 BECKTON LIKABLE G403 N4**  
1-A 100% # 4170280 Tattoo: BKT9 G403

Birth: 3-26-19

Beckton Likable U130 L2 < Beckton Likable S633  
Beckton Kit S478 LN

**BECKTON LIKABLE C229 R3**  
Ref. L < Beckton Roman J S158  
Beckton Tamara X447 J < Beckton Tamara R834 JC

Beckton Nebula T398 V3 < Beckton Nebula L P093  
Beckton Minerva J615 VG

**BECKTON MINERVA Y385 N**  
Beckton Minerva U310 LO < Beckton Loki CL S284  
Beckton Minerva S283 HU

BWt	72
WR	112
ADG	4.08
YR	110
Scr.	36
Fr.	5.5

DAM	
Age	8
Wt	1050
Wean Pct.	58%
Cow Eff.	122

Calv.Ease	BW	WW	YW	Milk	HPG	Stay	Maint.En.	
EPDs	18	-4.7	58	91	29	9	23	-5.0
Acc.	(.25)	(.46)	(.44)	(.43)	(.21)	(.07)	(.16)	(.16)
Marb	+0.31	(.20)	REA	+0.28	(.28)	Bfat	+0.04	(.18)

★★★★★ for Low Maintenance, Growth, Gainability, Marbling, Rib-eye area, High Cow Efficiency, Calving Ease.

**N-3 BECKTON NEBULA C067 N5**  
1-A 100% # 3487987 Tattoo: BKB5 C067

Birth: 2-24-15

Beckton Nebula T398 V3 < Beckton Nebula L P093  
Beckton Minerva J615 VG

**BECKTON NEBULA A773 L4**  
Ref. N-3 < Beckton Likable U130 L2  
Beckton Mona U584 CD

Beckton Nebula P P707 < Beckton Nebula M045  
Beckton Lana M809 EP

**BECKTON MARTA A319 N**  
Beckton Marta X405 J < Beckton Julian G5 S107  
Beckton Marta S441 RN

BWt	61
WR	114
ADG	3.56
YR	112
Scr.	37
Fr.	5.5

DAM	
Age	2
Wt	860
Wean Pct.	62%
Cow Eff.	131

Calv.Ease	BW	WW	YW	Milk	HPG	Stay	Maint.En.	
EPDs	16	-3.8	60	100	27	16	21	2.0
Acc.	(.38)	(.54)	(.52)	(.52)	(.27)	(.06)	(.23)	(.26)
Marb	+0.35	(.24)	REA	+0.01	(.39)	Bfat	+0.05	(.19)

★★★★★ for Growth, Gainability, Marbling, High Cow Efficiency, Calving Ease.

• Reference Sires •

**N-4 BECKTON NEBULA F440 H4**  
1-A 100% # 3988546 Tattoo: BSF8 F440

Birth: 3-23-18

Beckton Nebula P P707 < Beckton Nebula M045  
Beckton Lana M809 EP

**BECKTON NEBULA B557 J3**  
Ref. N < Beckton Justice CH M056  
Beckton Larkaba T813 JC < Beckton Larkaba P645 JL

Beckton Hasten H S462 < Beckton Hasten P292  
Beckton Lakme G128 HD

**BECKTON MINOLA X638 H**  
Beckton Julian G1 J526  
Beckton Minola N751 JL < Beckton Minola J091 JL

BWt	84
WR	116
ADG	3.28
YR	116
Scr.	37
Fr.	5.5

DAM		Calv.Ease	BW	WW	YW	Milk	HPG	Stay	Maint.En.	
Age	8	EPDs	14	-3.9	54	87	26	12	17	0.0
Wt	1140	Acc.	(.33)	(.60)	(.54)	(.52)	(.24)	(.07)	(.20)	(.21)
Wean Pct.	55%	Marb	+.46 (.21)		REA	-.17 (.33)		Bfat	+.03 (.19)	
Cow Eff.	115									

★★★★★ for Low Maintenance, Growth, Marbling, Calving Ease.

**O-2 LSF SRR PRESIDENT 8177F**  
1-A 100% # 3925037 Tattoo: LSF8 FL177

Birth: 2-16-18

HXC Conquest 4405P < Beckton Julian GG B571  
HXC Ellie May MA638

**LSF SRR COMMANDER 5906C**  
Ref. < Messmer Packer S008  
LSF Crystal R5145 X0414 < LSF Crystal LA394 R5145

Messmer Packer S008 < Messmer Joshua 019P  
Messmer Millie 124P

**LSF SRR FLO-MARIE 961 D6451**  
LSF Della P4078 U8051 < Feddes Big Sky R9  
LSF Della G1372 P4078

BWt	67
WR	103
ADG	NA
YR	106
Scr.	NA
Fr.	NA

DAM		Calv.Ease	BW	WW	YW	Milk	HPG	Stay	Maint.En.	
Age	2	EPDs	14	-4.7	73	109	27	15	18	-1.0
Wt	NA	Acc.	(.70)	(.85)	(.81)	(.74)	(.24)	(.21)	(.28)	(.24)
Wean Pct.	NA%	Marb	+.88 (.49)		REA	+.38 (.53)		Bfat	+.04 (.34)	
Cow Eff.	NA									

★★★★★ for Low Maintenance, Growth, Marbling, Rib-eye area, Calving Ease.

**N-5 BECKTON NEBULA G249 N4**  
1-A 100% # 4171298 Tattoo: BSF9 G249

Birth: 3-18-19

Beckton Nebula P P707 < Beckton Nebula M045  
Beckton Lana M809 EP

**BECKTON NEBULA B557 J3**  
Ref. N < Beckton Justice CH M056  
Beckton Larkaba T813 JC < Beckton Larkaba P645 JL

Beckton Nebula W022 D3 < Beckton Nebula T269 E2  
Beckton Eola T070 DM

**BECKTON LANA Y130 N**  
Beckton Lana W525 D < Beckton Dominor Z1 R610  
Beckton Lana S520 JO

BWt	75
WR	121
ADG	4.02
YR	120
Scr.	38
Fr.	5.5

DAM		Calv.Ease	BW	WW	YW	Milk	HPG	Stay	Maint.En.	
Age	8	EPDs	16	-5.2	50	91	31	13	19	3.0
Wt	1120	Acc.	(.30)	(.48)	(.46)	(.45)	(.24)	(.07)	(.18)	(.17)
Wean Pct.	55%	Marb	+.56 (.21)		REA	-.16 (.31)		Bfat	+.04 (.19)	
Cow Eff.	115									

★★★★★ for Growth, Gainability, Marbling, Calving Ease.

**O-3 BECKTON ORACLE G222 J2**  
1-A 100% # 4170878 Tattoo: BKT9 G222

Birth: 3-16-19

Schuler Sudden Impact 0004X < Red Crowfoot Ole's Oscar  
SOR Duchess TS 8915U

**SCHULER ORACLE-7142E**  
Ref. O-3 < Brown Commitment S7206  
Sor Marlee Cmmtmnt 0470X < SOR Marlee Beef 4511P

Beckton Julian GG B571 < Beckton Julian 7526G  
Bkt Marta 9A13 JL

**BECKTON ROSE E470 J**  
Beckton Rose W346 E < Beckton Emcee S466  
Beckton Rose L083 LN

BWt	59
WR	121
ADG	3.28
YR	114
Scr.	33
Fr.	5.0

DAM		Calv.Ease	BW	WW	YW	Milk	HPG	Stay	Maint.En.	
Age	2	EPDs	22	-7.5	55	91	28	12	17	1.0
Wt	770	Acc.	(.30)	(.50)	(.48)	(.45)	(.18)	(.11)	(.18)	(.13)
Wean Pct.	59%	Marb	+.67 (.24)		REA	+.16 (.32)		Bfat	+.03 (.20)	
Cow Eff.	124									

★★★★★ for Growth, Marbling, Rib-eye area, High Cow Efficiency, Calving Ease.

**O-1 SCHULER ORACLE-7142E**  
1-A 100% # 3778379 Tattoo: BKB7 ES142

Birth: 3-10-17

Red Crowfoot Ole's Oscar < Milk Crk Cub 722  
Red Crowfoot Omega 9179J

**SCHULER SUDDEN IMPACT 0004X**  
Ref. E < Basin Trend Setter 6074  
SOR Duchess TS 8915U < SOR Duchess BC 4425P

Brown Commitment S7206 < LJC Lancer 806  
Brown MS Shazzam P7940

**SOR MARLEE CMMTMNT 0470X**  
SOR Marlee Beef 4511P < Lonerock Beefstake 0024  
Sor Marlee Bur 0019K

BWt	76
WR	98
ADG	NA
YR	98
Scr.	37
Fr.	5.5

DAM		Calv.Ease	BW	WW	YW	Milk	HPG	Stay	Maint.En.	
Age	5	EPDs	21	-5.6	56	98	25	9	18	2.0
Wt	NA	Acc.	(.39)	(.70)	(.66)	(.66)	(.27)	(.21)	(.16)	(.25)
Wean Pct.	NA%	Marb	+.87 (.36)		REA	+.32 (.40)		Bfat	+.01 (.24)	
Cow Eff.	NA									

★★★★★ for Marbling, Rib-eye area, Calving Ease.

**O-4 BECKTON ORACLE G434 A2**  
1-A 100% # 4170778 Tattoo: BKT9 G434

Birth: 3-27-19

Schuler Sudden Impact 0004X < Red Crowfoot Ole's Oscar  
SOR Duchess TS 8915U

**SCHULER ORACLE-7142E**  
Ref. O-3 < Brown Commitment S7206  
Sor Marlee Cmmtmnt 0470X < SOR Marlee Beef 4511P

Beckton Accent U777 C2 < Beckton Cody K1 P014  
Beckton Susan R022 CQ

**BECKTON LARKABA D449 A**  
Beckton Larkaba U475 CT < BKT Clifftop TP R288  
Beckton Larkaba R809 NB

BWt	62
WR	102
ADG	3.28
YR	100
Scr.	37
Fr.	5.0

DAM		Calv.Ease	BW	WW	YW	Milk	HPG	Stay	Maint.En.	
Age	3	EPDs	22	-8.2	49	84	29	12	19	-3.0
Wt	815	Acc.	(.21)	(.46)	(.42)	(.41)	(.15)	(.10)	(.11)	(.13)
Wean Pct.	59%	Marb	+.63 (.21)		REA	+.05 (.27)		Bfat	+.03 (.18)	
Cow Eff.	123									

★★★★★ for Low Maintenance, Marbling, High Cow Efficiency, Calving Ease.

• Reference Sires •

**R-1 BECKTON RANGER G299 N6**  
1-A 100% # 4170624 Tattoo: BKT9 G299

Birth: 3-20-19

Beckton Ranger Z225 J4 < Beckton Ranger T603 H3  
Beckton Ranger B006 D5 < Beckton Mona U564 JT  
Ref. R-1 < Beckton Dominor W640 C5  
Beckton Suffeina Z731 D < Beckton Suffeina W471 W

Beckton Nebula A773 L4 < Beckton Nebula T398 V3  
Beckton Indigo C018 N < Beckton Mona X022 L  
Beckton Indigo A849 N < Beckton Nebula T398 V3  
Beckton Indigo U465 EP

BWt	74
WR	106
ADG	3.98
YR	109
Scr.	36
Fr.	5.5

DAM	
Age	4
Wt	1030
Wean Pct.	50%
Cow Eff.	105

Calv.Ease	BW	WW	YW	Milk	HPG	Stay	Maint.En.
EPDs	17	-3.8	58	99	27	10	2.0
Acc.	(.25)	(.47)	(.46)	(.45)	(.20)	(.02)	(.15)
Marb	+.46 (.19)		REA +.07 (.28)		Bfat +.04 (.14)		

★★★★★ for Growth, Gainability, Marbling, Calving Ease.

**S-3 BECKTON SCAMP G236 L6**  
1-A 100% # 4165160 Tattoo: BKB9 G236

Birth: 3-17-19

Beckton Scamp A627 J4 < Beckton Scamp X494 E3  
Beckton Scamp D325 N5 < Beckton Serena R023 JC  
Ref. S < Beckton Nebula W065 C3  
Beckton Tamara Y039 N < Beckton Tamara W232 J

Beckton Likable U130 L2 < Beckton Likable S633  
Beckton Indigo Y406 L < Beckton Kit S478 LN  
Beckton Indigo R745 WR < Beckton Warrior CL M686  
Beckton Indigo M514 CH

BWt	67
WR	105
ADG	4.08
YR	113
Scr.	35
Fr.	5.5

DAM	
Age	8
Wt	1045
Wean Pct.	55%
Cow Eff.	116

Calv.Ease	BW	WW	YW	Milk	HPG	Stay	Maint.En.
EPDs	18	-5.0	65	102	28	12	-3.0
Acc.	(.26)	(.51)	(.46)	(.42)	(.21)	(.02)	(.16)
Marb	+.26 (.20)		REA +.24 (.29)		Bfat +.02 (.17)		

★★★★★ for Low Maintenance, Growth, Gainability, Marbling, Rib-eye area, Calving Ease.

**S-1 BECKTON SCAMP E175 N5**  
1-A 100% # 3776509 Tattoo: BKT7 E175

Birth: 3-7-17

Beckton Scamp X458 H3 < Beckton Scamp T A825  
Beckton SCAMP B720 L4 < BKT Pine Marie R401 HU  
Ref. S < Beckton Likable U130 L2  
Beckton Larkaba Y448 L < Beckton Larkaba T655 NB

Beckton Nebula T398 V3 < Beckton Nebula L P093  
Beckton BELGA W103 N < Beckton Minerva J615 VG  
Beckton Belga T551 EP < Beckton Epic K3 M606  
Beckton Belga K285 JL

BWt	78
WR	106
ADG	4.06
YR	114
Scr.	41
Fr.	5.5

DAM	
Age	8
Wt	1015
Wean Pct.	55%
Cow Eff.	116

Calv.Ease	BW	WW	YW	Milk	HPG	Stay	Maint.En.
EPDs	21	-7.1	50	103	23	7	0.0
Acc.	(.40)	(.71)	(.66)	(.66)	(.22)	(.09)	(.17)
Marb	+.33 (.24)		REA +.09 (.37)		Bfat +.03 (.20)		

★★★★★ for Low Maintenance, Growth, Gainability, Marbling, High Cow Efficiency, Calving Ease.

**S-4 BECKTON SCAMP G325 N6**  
1-A 100% # 4171516 Tattoo: BSF9 G325

Birth: 3-22-19

Beckton Scamp A627 J4 < Beckton Scamp X494 E3  
Beckton SCAMP D325 N5 < Beckton Serena R023 JC  
Ref. S < Beckton Nebula W065 C3  
Beckton Tamara Y039 N < Beckton Tamara W232 J

Beckton New Era Y194 < Beckton Nebula P P707  
Beckton BARMAID C194 N < BKT Larkeisa T310 JC  
Beckton Barmaid X654 N < Beckton Nebula T398 V3  
Beckton Barmaid S758 DM

BWt	76
WR	104
ADG	4.25
YR	115
Scr.	36
Fr.	5.5

DAM	
Age	4
Wt	1075
Wean Pct.	47%
Cow Eff.	99

Calv.Ease	BW	WW	YW	Milk	HPG	Stay	Maint.En.
EPDs	16	-4.2	58	101	30	11	-3.0
Acc.	(.25)	(.47)	(.44)	(.42)	(.21)	(.03)	(.14)
Marb	+.29 (.19)		REA +.08 (.29)		Bfat +.03 (.17)		

★★★★★ for Low Maintenance, Growth, Gainability, Marbling, Calving Ease.

**S-2 BECKTON SCAMP G006 C6**  
1-A 100% # 4171814 Tattoo: BSF9 G006

Birth: 2-12-19

Beckton Scamp B720 L4 < Beckton Scamp X458 H3  
Beckton SCAMP E175 N5 < Beckton Larkaba Y448 L  
Ref. S-1 < Beckton Nebula T398 V3  
Beckton Belga W103 N < Beckton Belga T551 EP

Beckton Cardinal B074 N < TR Double Eagle ZT220  
Beckton FIREFLY E769 C < BKT Pine Marie Z250 N  
Beckton Firefly B052 W < Beckton Warrior Z936 N6  
Beckton Firefly Z663 N

BWt	54
WR	110
ADG	4.36
YR	122
Scr.	36
Fr.	5.5

DAM	
Age	2
Wt	720
Wean Pct.	60%
Cow Eff.	126

Calv.Ease	BW	WW	YW	Milk	HPG	Stay	Maint.En.
EPDs	21	-8.1	48	98	27	10	-2.0
Acc.	(.26)	(.47)	(.43)	(.41)	(.17)	(.02)	(.11)
Marb	+.38 (.18)		REA +.07 (.29)		Bfat +.03 (.17)		

★★★★★ for Low Maintenance, Growth, Gainability, Marbling, High Cow Efficiency, Calving Ease.

**W-1 BECKTON WARRIOR G356 N7**  
1-A 100% # 4171420 Tattoo: BSF9 G356

Birth: 3-23-19

Beckton Warrior Y108 E5 < Beckton Warrior W534 N4  
Beckton WARRIOR D359 L6 < Beckton Susan W058 E  
Ref. W < Beckton Nebula CL S284  
Beckton Lana W463 L < Beckton Lana R327 EP

Beckton New Era Y194 < Beckton Nebula P P707  
Beckton LARKABA B277 N < BKT Larkeisa T310 JC  
Beckton Larkaba U062 CB < Beckton Cobalt S029  
Beckton Larkaba S374 NB

BWt	80
WR	120
ADG	4.78
YR	129
Scr.	38
Fr.	5.5

DAM	
Age	5
Wt	1125
Wean Pct.	54%
Cow Eff.	113

Calv.Ease	BW	WW	YW	Milk	HPG	Stay	Maint.En.
EPDs	16	-3.5	67	113	29	12	-3.0
Acc.	(.24)	(.47)	(.45)	(.43)	(.20)	(.06)	(.16)
Marb	+.35 (.19)		REA +.07 (.29)		Bfat +.04 (.17)		

★★★★★ for Low Maintenance, Growth, Gainability, Marbling, Calving Ease.

# Reference Sire Lot Index

<u>Lot</u>	<u>ID</u>	<u>Lot</u>	<u>ID</u>	<u>Lot</u>	<u>ID</u>	<u>Lot</u>	<u>ID</u>	<u>Lot</u>	<u>ID</u>	<u>Lot</u>	<u>ID</u>		
<u>Accent W180 (A-1)</u>		<u>Accent F177 (A-5)</u>		<u>Cardinal E673 (C-2)</u>		<u>Heritage C477 (H-2)</u>		<u>Likable D432 (L-3)</u>		<u>Nebula S347 (N-1)</u>		<u>President FL177 (O-2)</u>	
23. . . .	JC178	87. . . . .	J578	132. . . . .	J521	44. . . . .	J386	19. . . . .	J246	108. . . . .	J307	45. . . . .	J481
34. . . . .	J211	105. . . . .	J553	161. . . . .	J702	101. . . . .	J394	46. . . . .	J270	110. . . . .	J551	162. . . . .	J735
<u>Accent B549 (A-2)</u>		127. . . . .	J384	174. . . . .	J826	104. . . . .	J739	65. . . . .	J449	319. . . . .	J310(H)	231. . . . .	J815
11. . . . .	J334	134. . . . .	J641	189. . . . .	J684	184. . . . .	J329	67. . . . .	J256	<u>Nebula A773 (N-2)</u>		<u>Ranger G299 (R-1)</u>	
21. . . . .	J161	155. . . . .	J776	196. . . . .	J640	234. . . . .	J647	74. . . . .	J247	9. . . . .	J635	82. . . . .	J191
33. . . . .	J479	160. . . . .	J261	233. . . . .	J425	<u>Heritage F615 (H-3)</u>		152. . . . .	J428	29. . . . .	J620	85. . . . .	J690
43. . . . .	J219	197. . . . .	J321	<u>Cardinal G043 (C-3)</u>		31. . . . .	J181	175. . . . .	J243	118. . . . .	J574	<u>Scamp E175 (S-1)</u>	
131. . . . .	J207	214. . . . .	J403	18. . . . .	J104	107. . . . .	J793	<u>Likable E391 (L-4)</u>		177. . . . .	J705	77. . . . .	J474
135. . . . .	J395	217. . . . .	J347	62. . . . .	J220	114. . . . .	J486	2. . . . .	J472	201. . . . .	J857	94. . . . .	J482
173. . . . .	J862	221. . . . .	J692	102. . . . .	J018	169. . . . .	J817	49. . . . .	J545	303. . . . .	J562(H)	111. . . . .	J531
212. . . . .	J837	<u>Accent G107 (A-6)</u>		117. . . . .	J196	187. . . . .	J369	57. . . . .	J343	<u>Nebula C067 (N-3)</u>		179. . . . .	J703
302. . . . .	J166(H)	143. . . . .	J203	142. . . . .	J302	191. . . . .	J524	81. . . . .	J469	147. . . . .	J563	182. . . . .	J406
310. . . . .	J622(H)	194. . . . .	J542	158. . . . .	J731	210. . . . .	J891	124. . . . .	J381	<u>Nebula F440 (N-4)</u>		209. . . . .	J898
312. . . . .	J130(H)	<u>Accent G208 (A-7)</u>		<u>Dominor D254 (D-1)</u>		<u>Heritage G152 (H-4)</u>		128. . . . .	J471	16. . . . .	J242	224. . . . .	J677
315. . . . .	J376(H)	4. . . . .	J019	73. . . . .	J519	13. . . . .	J076	167. . . . .	J919	28. . . . .	J592	<u>Scamp G006 (S-2)</u>	
317. . . . .	J199(H)	8. . . . .	J045	76. . . . .	J400	42. . . . .	J046	304. . . . .	J377(H)	97. . . . .	J333	64. . . . .	J053
318. . . . .	J447(H)	59. . . . .	J097	133. . . . .	J540	61. . . . .	J010	<u>Likable F242 (L-5)</u>		195. . . . .	J694	80. . . . .	J239
320. . . . .	J530(H)	86. . . . .	J204	148. . . . .	J537	123. . . . .	J275	41. . . . .	J445	<u>Nebula G249 (N-5)</u>		99. . . . .	J067
324. . . . .	J318(H)	125. . . . .	J110	188. . . . .	J379	<u>Julian B571 (J-1)</u>		151. . . . .	J272	157. . . . .	J529	<u>Scamp G236 (S-3)</u>	
<u>Accent D326 (A-3)</u>		<u>Accent G260 (A-8)</u>		192. . . . .	J611	109. . . . .	J322	178. . . . .	J648	198. . . . .	J408	103. . . . .	J074
1. . . . .	J559	51. . . . .	J020	<u>Dominor F263 (D-2)</u>		<u>Julian P608 (J-2)</u>		215. . . . .	J766	314. . . . .	J107(H)	228. . . . .	J432
3. . . . .	J413	53. . . . .	J069	126. . . . .	J638	68. . . . .	J396	230. . . . .	J636	<u>Oracle ES142 (O-1)</u>		301. . . . .	J184(H)
12. . . . .	J455	93. . . . .	J059	139. . . . .	J470	138. . . . .	J465	<u>Likable F287 (L-6)</u>		32. . . . .	J154	<u>Scamp G325 (S-4)</u>	
48. . . . .	J292	145. . . . .	J116	202. . . . .	J879	<u>Julian Z382 (J-3)</u>		37. . . . .	J683	52. . . . .	J323	154. . . . .	J282
56. . . . .	J173	<u>Hughes C463 (B-1)</u>		316. . . . .	J248(H)	<u>Julian A434 (J-4)</u>		54. . . . .	J727	71. . . . .	J146	156. . . . .	J190
63. . . . .	J389	14. . . . .	J401	<u>Dominor G402 (D-3)</u>		<u>Julian F067 (J-5)</u>		75. . . . .	J298	90. . . . .	J180	<u>Warrior G356 (W-1)</u>	
66. . . . .	J228	39. . . . .	J569	15. . . . .	J121	27. . . . .	JC189	95. . . . .	J675	91. . . . .	J218	122. . . . .	J052
79. . . . .	J178	106. . . . .	J206	100. . . . .	J308	<u>Julian A434 (J-4)</u>		121. . . . .	J747	115. . . . .	J490	223. . . . .	J232
113. . . . .	J358	120. . . . .	J604	186. . . . .	J171	<u>Julian F067 (J-5)</u>		136. . . . .	J668	163. . . . .	J917		
166. . . . .	J902	137. . . . .	J593	204. . . . .	J769	17. . . . .	J362	308. . . . .	J357(H)	185. . . . .	J654		
199. . . . .	J429	153. . . . .	J480	207. . . . .	J911	40. . . . .	J448	309. . . . .	J518(H)	200. . . . .	J615		
203. . . . .	J850	226. . . . .	J365	232. . . . .	J122	140. . . . .	J854	<u>Likable G026 (L-7)</u>		205. . . . .	J874		
227. . . . .	J355	307. . . . .	J285(H)	<u>Dominor G461 (D-4)</u>		164. . . . .	J900	20. . . . .	J079	206. . . . .	J582		
306. . . . .	J342(H)	<u>Roosevelt D305 (B-2)</u>		193. . . . .	J119	170. . . . .	J584	22. . . . .	J187	216. . . . .	J415		
311. . . . .	J300(H)	38. . . . .	J297	<u>Epic F279 (E-1)</u>		213. . . . .	J522	78. . . . .	J280	220. . . . .	J698		
321. . . . .	J309(H)	89. . . . .	J716	112. . . . .	J827	<u>Jet G441 (J-6)</u>		116. . . . .	J027	222. . . . .	J746		
<u>Accent E172 (A-4)</u>		130. . . . .	J619	149. . . . .	J613	35. . . . .	J768	129. . . . .	J048	<u>Oracle G222 (O-3)</u>			
5. . . . .	J245	141. . . . .	J594	<u>Halfmann Hustler</u>		36. . . . .	J093	183. . . . .	J152	58. . . . .	J359		
7. . . . .	J316	150. . . . .	J771	<u>R588 (H-1)</u>		<u>Likable Y124 (L)</u>		<u>Likable G289 (L-8)</u>		72. . . . .	J075		
10. . . . .	J306	159. . . . .	J753	6. . . . .	J236	144. . . . .	J442	47. . . . .	J137	88. . . . .	J385		
55. . . . .	J581	171. . . . .	J606	83. . . . .	J375	<u>Likable B032 (L-1)</u>		119. . . . .	J112	<u>Oracle G434 (O-4)</u>			
60. . . . .	J397	208. . . . .	J868	96. . . . .	J230	24. . . . .	JC186	176. . . . .	J083	69. . . . .	J133		
70. . . . .	J423	325. . . . .	J557(H)	218. . . . .	J344	25. . . . .	JC183	211. . . . .	J653	180. . . . .	J451		
305. . . . .	J426(H)	<u>Cardinal B074 (C-1)</u>		313. . . . .	J182(H)	26. . . . .	JC188	<u>Likable G403 (L-9)</u>		190. . . . .	J708		
		146. . . . .	J315	322. . . . .	J257(H)	<u>Likable C229 (L-2)</u>		30. . . . .	J113	225. . . . .	J373		
				323. . . . .	J335(H)	84. . . . .	J796	98. . . . .	J082	229. . . . .	J177		
						165. . . . .	J893	181. . . . .	J197				
						168. . . . .	J896	219. . . . .	J728				
						172. . . . .	J835						

# Sale Terms and Conditions

Except for those stated in the terms and conditions below, there are no warranties, either expressed or implied, as to the merchantability or fitness for a particular purpose with respect to the cattle being sold at this auction. The warranties and guarantees set forth in the "Terms and Conditions" are in lieu of all other warranties, either expressed or implied, and the remedies provided therein shall be the sole and exclusive remedy for the Buyer, or any party claiming through Buyer, for any breach of warranty or guarantee therein provided, and all other obligations or liabilities.

The information in the catalog is believed to be accurate, and the information seller believes to be most representative. It is the nature of seller's business that the seller engages in a continual process of collecting new data and information. Therefore, any information presented at the time of sale is always subject to revision, correction or update.

## I. BIDDING

The Auctioneer in charge will settle any disputes as to bids, and his decision on such matters shall be final.

## II. TERMS

Terms of sale are cash or personal check unless satisfactory credit arrangements have been made with vendor prior to sale.

## III. PURCHASER'S RISK

Each animal becomes the risk of the purchaser as soon as sold, but it shall be the obligation of the Seller to see that animals are fed and cared for free of charge to purchaser, until loaded for shipment or until the expiration of 48 hours after the sale, whichever occurs sooner.

## IV. DELIVERY

For any animals for which seller's arrange delivery, the following terms shall apply. Each animal becomes the risk of the purchaser as soon as sold, and through the time of delivery. The seller will arrange transportation and delivery schedules, and may combine animals from one or more purchasers for convenience and to reduce costs. If delivery is arranged, seller assumes no other liability. Once the purchaser has been notified of the date and approximate time of delivery (morning, afternoon, evening, etc.), it is the responsibility of the purchaser to arrange adequate and agreeable location and facilities for unloading each animal. When unloaded at the agreed upon location, all care and management of the animal is the responsibility of the purchaser.

## V. CERTIFICATE OF REGISTRY

A transferred certificate of registry will be furnished to the purchaser for each animal for which a Registration number is listed.

## VI. HEALTH

All animals are eligible for interstate shipment, except as otherwise announced. Interstate health papers will be furnished for each animal requiring T.B, Bang's, and trich tests in accordance with federal and state regulations.

## VII. DIVISIBILITY

The percentage of ownership interest received by the buyer, whether it is 100% or 2/3 or otherwise as defined in the catalog or by the auctioneer, may not be subsequently divided without the express written consent of the seller.

## VIII. ANNOUNCEMENTS

Any changes from information of any kind in this catalog will be announced from the auction box and such announcements shall take precedence.

## IX. BREEDING GUARANTEE

Any female that has had a calf prior to the date of sale shall be considered a breeder without further guarantee. All females sold as 'bred' or 'pregnant' have been pregnancy checked by a licensed veterinarian and are guaranteed bred on the day of sale. The purchaser may elect to have any female so listed rechecked at their cost within 30 days of delivery by a licensed veterinarian of their choice. Any such female determined open by this recheck may be returned to the seller for a full refund. Due to conditions out of seller's control, once a female leaves seller's possession, this is the only guarantee offered.

All bulls are sold as guaranteed breeders. Each bull has been officially fertility tested as "Satisfactory Breeder" prior to the sale. However, seller cannot guarantee against physical injury or illness following the sale. But if within 8 months following the sale, the buyer has evidence that the animal is not a breeder, the buyer may obtain a statement signed by a licensed veterinarian to that effect, such statement also indicating that there has been no injury or illness to the animal following the sale, and return the bull to the farm of the seller for adjustment. If the seller cannot then prove the animal to be a breeder, an adjustment will be made by the seller, either by substituting an animal of equal value, or by the refund of the full purchase price. Such adjustment shall be considered full settlement and satisfaction of all claims. No guarantees apply to animals which are shown following the sale.

## X. GENETIC DEFECT GUARANTEE AND PARENTAGE

All parentage and pedigrees presented in the catalog are believed accurate based upon the breeding and DNA information we have available. However, parentage and pedigree information cannot be guaranteed 100%, because it is always possible that new information or new DNA technology and testing might show that there have been inadvertent errors.

Osteopetrosis: The Red Angus Association along with animal scientists have developed a DNA marker test for osteopetrosis (OS), a genetic disorder which in rare instances can cause the loss of a calf at birth. Since the test was developed, Beckton has tested every sire being used in our breeding program. Only one sire, from outside our program, tested positive as a carrier of the gene. Every sire bred and raised at Beckton has tested 'Free'. All of our major semen sires have also been tested 'Free'. We guarantee every sale animal to be OS Free, and if you have a concern, we will have any sale animal tested on request. If an animal were to test positive, we would replace the animal or refund the purchase price. The testing we have done shows no incidence of occurrence in any Beckton bloodlines for the past 30 years, and so we believe there is no safer herd than ours.

## XI. RETAINED INTEREST AND SEMEN RIGHTS:

Beckton is selling full possession and one half semen interest in all the bulls in the catalog. Seller is retaining one half interest in all bulls in the catalog. This is done so we can use some of the bulls in herd and reserve the right to collect and market semen on these bulls. Any collection on our behalf would be at our expense and could be done during the off-season and at the convenience of the buyer. The buyer would have the option to share in the collection and retain semen for the buyer's use also. If semen is marketed by either party, Seller receives one half royalty interest on gross semen sales, and buyer receives one half interest. Regardless of semen collection and marketing, the buyer retains full possession, full pasture use rights, and full salvage value in these bulls.

## XII. RIGHTS AND OBLIGATIONS

A. The above terms and conditions of sale shall constitute a contract between the Buyer and Seller of each animal and shall be equally binding upon both. Each sale or resale of an animal constitutes a separate transaction.

B. Neither the sale manager, the owner, nor any other person connected with the management of the sale, assumes any liability, legal or otherwise.

# RAAA Herd EPD Tables

## Proven and Genetic Opportunity Sires (Spring 2022)

	ProS	HB	GM	CED	BW	WW	YW	ADG	DMI	MILK	ME	HPG	CEM	STAY	MARB	YG	CW	REA	FAT
Min.	-157	-157	-94	-2	-12.9	-15	-43	-.17	-0.65	1	-35	-5	-9	-3	-.63	-1.09	-70	-1.11	-.22
<b>Avg.</b>	<b>86</b>	<b>51</b>	<b>36</b>	<b>13</b>	<b>-1.7</b>	<b>61</b>	<b>99</b>	<b>.23</b>	<b>1.44</b>	<b>25</b>	<b>3</b>	<b>11</b>	<b>7</b>	<b>15</b>	<b>.42</b>	<b>.06</b>	<b>23</b>	<b>.13</b>	<b>.02</b>
Max.	227	147	149	25	9.9	116	203	.56	3.60	46	37	25	18	28	1.59	.46	112	2.13	.12
1%	156	103	90	20	-6.9	90	146	.37	0.33	36	-23	18	12	22	.92	-.34	58	.88	-.07
2%	149	97	82	19	-6.4	86	141	.36	0.46	34	-17	17	12	21	.87	-.21	52	.72	-.04
3%	143	93	78	19	-6.0	84	137	.35	0.56	34	-14	17	11	21	.83	-.15	49	.65	-.02
4%	139	90	75	18	-5.6	82	134	.34	0.62	33	-12	16	11	20	.80	-.11	47	.59	-.02
5%	135	87	72	18	-5.5	81	132	.33	0.69	33	-11	16	11	20	.78	-.09	45	.55	-.01
<b>10%</b>	<b>123</b>	<b>79</b>	<b>64</b>	<b>17</b>	<b>-4.6</b>	<b>76</b>	<b>124</b>	<b>.31</b>	<b>0.87</b>	<b>31</b>	<b>-7</b>	<b>15</b>	<b>10</b>	<b>19</b>	<b>.68</b>	<b>-.04</b>	<b>40</b>	<b>.43</b>	<b>-.01</b>
15%	116	74	58	16	-4.1	73	119	.29	0.99	30	-5	14	9	18	.63	-.02	36	.35	.00
20%	110	69	53	15	-3.6	71	114	.28	1.07	29	-3	14	9	18	.58	.00	33	.30	.00
25%	106	66	49	15	-3.2	69	111	.27	1.15	28	-1	13	8	17	.53	.02	31	.25	.01
30%	101	62	46	14	-2.9	67	108	.26	1.22	27	0	13	8	17	.51	.03	29	.22	.01
35%	97	59	43	14	-2.6	65	106	.25	1.29	27	1	12	8	16	.48	.04	27	.19	.01
40%	93	56	40	13	-2.3	64	103	.25	1.35	26	2	12	7	16	.45	.06	26	.16	.02
45%	89	54	37	13	-2.0	62	101	.24	1.40	26	3	12	7	15	.42	.07	24	.13	.02
<b>50%</b>	<b>86</b>	<b>51</b>	<b>34</b>	<b>12</b>	<b>-1.7</b>	<b>61</b>	<b>98</b>	<b>.23</b>	<b>1.46</b>	<b>25</b>	<b>4</b>	<b>11</b>	<b>7</b>	<b>15</b>	<b>.39</b>	<b>.08</b>	<b>22</b>	<b>.10</b>	<b>.02</b>
55%	82	48	31	12	-1.3	60	96	.22	1.51	25	4	11	7	15	.37	.08	21	.08	.02
60%	79	45	29	12	-1.1	58	93	.22	1.57	24	5	11	6	14	.35	.09	19	.05	.03
65%	75	42	26	11	-0.8	57	90	.21	1.63	23	6	10	6	14	.33	.11	17	.02	.03
70%	71	39	23	11	-0.5	55	88	.20	1.69	23	7	10	6	13	.31	.12	16	-.01	.03
75%	66	36	20	10	-0.2	54	85	.19	1.75	22	8	9	5	13	.28	.13	14	-.04	.03
80%	61	31	17	10	0.3	52	82	.18	1.83	21	9	9	5	12	.25	.14	12	-.07	.04
85%	56	26	13	9	0.7	49	78	.17	1.92	20	11	9	4	11	.22	.16	9	-.11	.04
<b>90%</b>	<b>48</b>	<b>19</b>	<b>8</b>	<b>8</b>	<b>1.2</b>	<b>46</b>	<b>73</b>	<b>.15</b>	<b>2.03</b>	<b>19</b>	<b>13</b>	<b>8</b>	<b>4</b>	<b>10</b>	<b>.18</b>	<b>.18</b>	<b>7</b>	<b>-.16</b>	<b>.05</b>
95%	35	9	1	7	2.2	41	64	.13	2.21	16	15	7	3	9	.11	.22	2	-.24	.05

## Active Cows (Spring 2022)

	ProS	HB	GM	CED	BW	WW	YW	ADG	DMI	MILK	ME	HPG	CEM	STAY	MARB	YG	CW	REA	FAT
Min.	-123	-102	-48	-4	-12.1	0	0	-.02	-0.47	-3	-40	-1	-8	0	-.32	-.89	-28	-.79	-.19
<b>Avg.</b>	<b>87</b>	<b>56</b>	<b>31</b>	<b>12</b>	<b>-1.6</b>	<b>58</b>	<b>92</b>	<b>.21</b>	<b>1.36</b>	<b>25</b>	<b>2</b>	<b>11</b>	<b>7</b>	<b>16</b>	<b>.39</b>	<b>.06</b>	<b>20</b>	<b>.08</b>	<b>.02</b>
Max.	197	162	119	26	8.3	102	167	.46	3.33	55	61	24	16	30	1.36	.42	77	1.66	.10
1%	142	105	72	19	-6.4	80	130	.33	0.43	36	-16	17	11	23	.80	-.13	44	.56	-.02
2%	136	100	68	18	-5.9	77	126	.32	0.53	35	-13	17	11	22	.76	-.10	42	.50	-.02
3%	132	97	65	17	-5.5	76	123	.31	0.59	34	-12	16	10	22	.72	-.08	40	.45	-.01
4%	130	94	62	17	-5.3	75	121	.30	0.65	34	-11	16	10	21	.70	-.07	38	.43	-.01
5%	127	91	60	17	-5.1	74	120	.30	0.69	33	-10	15	10	21	.68	-.06	37	.39	-.01
<b>10%</b>	<b>118</b>	<b>83</b>	<b>53</b>	<b>16</b>	<b>-4.3</b>	<b>70</b>	<b>113</b>	<b>.28</b>	<b>0.85</b>	<b>31</b>	<b>-7</b>	<b>14</b>	<b>9</b>	<b>20</b>	<b>.61</b>	<b>-.02</b>	<b>33</b>	<b>.31</b>	<b>.00</b>
15%	112	78	49	15	-3.7	68	109	.27	0.95	30	-5	14	9	19	.55	-.01	30	.26	.00
20%	107	74	45	14	-3.3	66	106	.26	1.04	29	-3	13	8	19	.52	.01	28	.22	.00
25%	103	70	42	14	-2.9	64	103	.25	1.11	28	-2	13	8	18	.49	.02	26	.18	.01
30%	99	67	39	13	-2.6	63	101	.24	1.17	28	-1	12	8	18	.45	.03	25	.15	.01
35%	96	64	36	13	-2.2	62	98	.23	1.23	27	0	12	8	17	.43	.04	23	.13	.01
40%	92	61	34	13	-2.0	60	96	.22	1.28	26	1	11	7	17	.41	.05	22	.11	.01
45%	89	59	31	12	-1.8	59	94	.22	1.33	26	2	11	7	16	.39	.06	21	.08	.01
<b>50%</b>	<b>86</b>	<b>56</b>	<b>29</b>	<b>12</b>	<b>-1.5</b>	<b>58</b>	<b>92</b>	<b>.21</b>	<b>1.38</b>	<b>25</b>	<b>3</b>	<b>11</b>	<b>7</b>	<b>16</b>	<b>.37</b>	<b>.07</b>	<b>19</b>	<b>.06</b>	<b>.02</b>
55%	83	53	27	12	-1.2	57	90	.21	1.43	24	4	11	7	16	.35	.07	18	.04	.02
60%	80	51	25	11	-1.0	55	87	.20	1.48	24	4	10	6	15	.33	.08	17	.02	.02
65%	77	48	22	11	-0.7	54	85	.19	1.53	23	5	10	6	15	.31	.09	15	-.01	.02
70%	74	45	20	11	-0.4	53	83	.18	1.58	22	6	10	6	14	.29	.10	14	-.02	.03
75%	70	42	18	10	-0.1	51	80	.18	1.64	22	7	9	6	14	.27	.11	12	-.05	.03
80%	66	38	15	10	0.3	49	77	.17	1.70	21	8	9	5	13	.25	.12	10	-.09	.03
85%	60	33	12	9	0.6	47	73	.16	1.78	20	9	8	5	13	.23	.14	8	-.11	.03
<b>90%</b>	<b>54</b>	<b>27</b>	<b>9</b>	<b>8</b>	<b>1.2</b>	<b>44</b>	<b>68</b>	<b>.14</b>	<b>1.87</b>	<b>18</b>	<b>11</b>	<b>8</b>	<b>4</b>	<b>12</b>	<b>.20</b>	<b>.16</b>	<b>6</b>	<b>-.16</b>	<b>.04</b>
95%	44	19	3	7	2.1	40	61	.12	2.02	16	14	7	3	10	.16	.19	2	-.22	.05

## Non-Parents (Spring 2022)

	ProS	HB	GM	CED	BW	WW	YW	ADG	DMI	MILK	ME	HPG	CEM	STAY	MARB	YG	CW	REA	FAT
Min.	-80	-85	-47	-5	-12.1	0	0	-.01	-0.39	0	-40	-3	-7	-1	-.37	-.80	-29	-.70	-.18
<b>Avg.</b>	<b>89</b>	<b>53</b>	<b>37</b>	<b>13</b>	<b>-1.8</b>	<b>59</b>	<b>95</b>	<b>.22</b>	<b>1.38</b>	<b>25</b>	<b>2</b>	<b>11</b>	<b>7</b>	<b>15</b>	<b>.42</b>	<b>.06</b>	<b>23</b>	<b>.13</b>	<b>.02</b>
Max.	218	164	129	26	11.1	115	177	.50	3.30	42	35	38	17	28	1.38	.41	80	1.54	.11
1%	142	95	77	19	-6.5	82	135	.34	0.38	34	-19	17	11	21	.82	-.14	46	.60	-.02
2%	137	91	72	18	-5.9	80	131	.33	0.49	33	-17	16	11	21	.77	-.10	44	.53	-.02
3%	133	88	69	18	-5.6	78	128	.32	0.56	32	-16	15	10	20	.75	-.08	42	.49	-.01
4%	130	85	67	17	-5.3	77	125	.31	0.62	32	-15	15	10	20	.72	-.07	40	.46	-.01
5%	127	83	65	17	-5.1	76	124	.31	0.66	31	-14	15	10	20	.70	-.06	39	.44	-.01
<b>10%</b>	<b>118</b>	<b>76</b>	<b>58</b>	<b>16</b>	<b>-4.4</b>	<b>72</b>	<b>117</b>	<b>.29</b>	<b>0.83</b>	<b>30</b>	<b>-10</b>	<b>14</b>	<b>9</b>	<b>19</b>	<b>.63</b>	<b>-.03</b>	<b>35</b>	<b>.35</b>	<b>.00</b>
15%	113	72	54	15	-3.8	70	113	.28	0.95	29	-6	13	9	18	.58	-.01	33	.30	.00
20%	108	68	50	15	-3.4	68	110	.27	1.04	28	-4	13	8	18	.55	.01	31	.26	.00
25%	104	65	47	14	-3.1	66	107	.26	1.13	28	-2	12	8	17	.52	.02	29	.23	.01
30%	100	62	45	14	-2.8	65	105	.25	1.20	27	-1	12	8	17	.49	.03	27	.21	.01
35%	97	60	42	14	-2.5	63	102	.24	1.26	27	0	12	8	16	.46	.04	26	.18	.01
40%	94	57	40	13	-2.3	62	100	.24	1.32	26	1	11	7	16	.44	.05	25	.16	.01
45%	91	55	38	13	-2.0	61	98	.23	1.37	26	2	11	7	16	.42	.06	24	.14	.02
<b>50%</b>	<b>88</b>	<b>52</b>	<b>36</b>	<b>13</b>	<b>-1.8</b>	<b>60</b>	<b>96</b>	<b>.23</b>	<b>1.42</b>	<b>25</b>	<b>3</b>	<b>11</b>	<b>7</b>	<b>15</b>	<b>.40</b>	<b>.07</b>	<b>22</b>	<b>.11</b>	<b>.02</b>
55%	85	50	34	12	-1.5	58	93	.22	1.47	25	4	11	7	15	.38	.07	21	.09	.02
60%	83	48	32	12	-1.3	57	91	.21	1.52	24	5	10	6	15	.36	.08	20	.07	.02
65%	80	45	30	12	-1.0	56	89	.20	1.57	24	5	10	6	14	.34	.09	19	.05	.02
70%	77	42	27	11	-0.8	54	86	.20	1.62	23	6	10	6	14	.33	.10	17	.03	.03
75%	74	40	25	11	-0.5	53	83	.19	1.67	22	7	10	6	13	.31	.11	16	.01	.03
80%	70	37	22	10	-0.1	51	80	.18	1.74	22	8	9	5	13	.29	.12	14	-.02	.03
85%	66	33	19	10	0.2	48	76	.16	1.81	21	9	9	5	12	.27	.13	12	-.05	.04
<b>90%</b>	<b>61</b>	<b>28</b>	<b>15</b>	<b>9</b>	<b>0.7</b>	<b>45</b>	<b>70</b>	<b>.15</b>	<b>1.90</b>	<b>20</b>	<b>11</b>	<b>8</b>	<b>4</b>	<b>11</b>	<b>.24</b>	<b>.15</b>	<b>10</b>	<b>-.09</b>	<b>.04</b>
95%	52	21	9	8	1.5	41	61	.12	2.05	18	13	8	4	10	.18	.18	6	-.15	.05

## EPD Accuracies and Possible Change

EPDs are predictions, not true values, and we can therefore expect that EPDs will change from sire evaluation, as more information (i.e. progeny data) is included. A possible change value is an estimate of the amount of change (in trait units) that can be expected for a given EPD.

Technically, there is a 68% chance that the real genetic value (an EPD with a accuracy of 1.0) for any trait lies between its EPD plus its possible change value and its EPD minus its possible change value. For example, if a sire has a weaning EPD of +25 lb. and a possible change value of 10 lb., we can expect the true genetic value to be between +15 lb. (25 - 10) and +35 lb. (25 + 10) 68% of the time. We should not be surprised if his EPD in next year's evaluation is as high as +35 or as low as +15. If next year's EPD should happen to be slightly outside of this

range, keep in mind there is nearly a one-in-three chance of that happening; however, significantly larger deviations can occur.

Possible change is simply another way of expressing accuracy of an EPD. High accuracy sires will have small possible changes and vice versa. Many breeders feel that possible change values complement accuracies and help them determine just how thoroughly an animal has been evaluated. The accuracy/possible change chart lists possible changes in EPDs that can be expected with different levels of accuracy for the various traits.

For more information on possible change values, please see the article by Dr. Bob Hough titled "Understanding EPD Accuracies and Possible Change". This article can be downloaded from the Red Angus Association of America website at [www.redangus.org](http://www.redangus.org).

Accuracy	CED	BW	WW	YW	DMI	MILK	ME	HPG	CEM	STAY	MARB	YG	CW	REA	FAT
<b>0.0</b>	7.8	3.0	16.3	25.7	.92	11.9	3	11	7.9	7.1	.26	.20	19.3	.43	.04
<b>0.1</b>	7.0	2.7	14.7	23.1	.82	10.7	2	10	7.1	6.4	.23	.18	17.4	.39	.04
<b>0.2</b>	6.2	2.4	13.0	20.6	.73	9.5	2	9	6.3	5.7	.21	.16	15.4	.34	.03
<b>0.3</b>	5.4	2.1	11.4	18.0	.64	8.3	2	8	5.5	4.9	.18	.14	13.5	.30	.03
<b>0.4</b>	4.7	1.8	9.8	15.5	.55	7.1	2	7	4.7	4.2	.16	.12	11.6	.26	.02
<b>0.5</b>	3.9	1.5	8.2	12.9	.46	6.0	1	6	3.9	3.5	.13	.10	9.7	.22	.02
<b>0.6</b>	3.1	1.2	6.5	10.3	.37	4.8	1	4	3.1	2.8	.10	.08	7.7	.17	.02
<b>0.7</b>	2.3	0.9	4.9	7.7	.27	3.6	1	3	2.4	2.1	.08	.06	5.8	.13	.01
<b>0.8</b>	1.6	0.6	3.3	5.1	.18	2.4	1	2	1.6	1.4	.05	.04	3.9	.09	.01
<b>0.9</b>	0.8	0.3	1.6	2.6	.09	1.2	0	1	0.8	0.7	.03	.02	1.9	.04	.00
<b>1.0</b>	0.0	0.0	0.0	0.0	.00	0.0	0	0	0.0	0.0	.00	.00	0.0	.00	.00

# Sire Bloodline Charts

Name Family

- Accent A
- Allegiant O
- Cadinal C
- Cherokee C
- Clifftop C
- Clipper A
- Cody A
- Dominor D
- Epic E
- Hasten H
- Herald H
- Heritage H
- Hughes B
- Hustler H
- Javelin J
- Jet J
- Julian J
- Lancer L
- RH Lancer O
- Legend L
- Likable L
- Nebula N
- New Era N
- Nomad V
- Oracle O
- President O
- Ranger R
- Roosevelt B
- Scamp S
- Warrior W

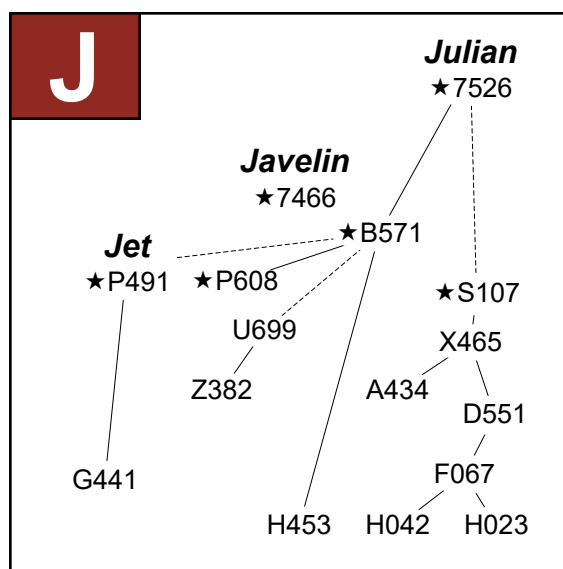
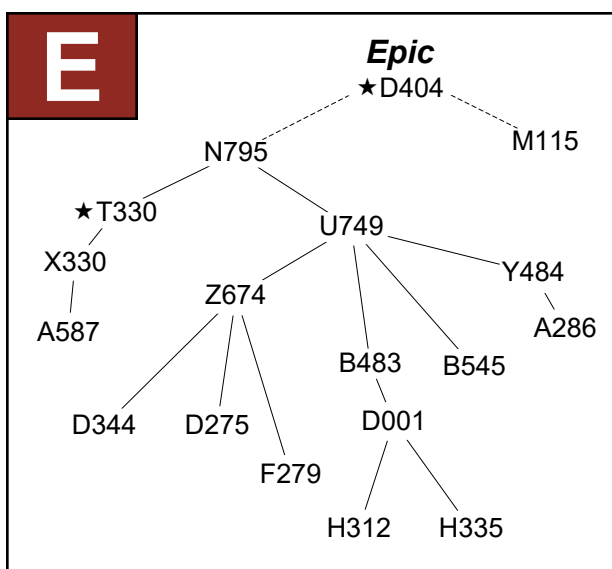
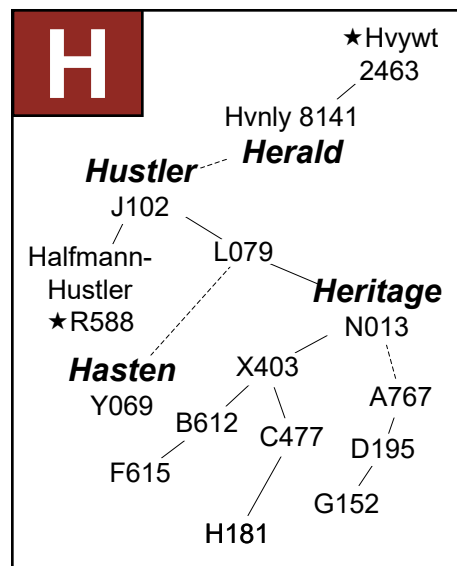
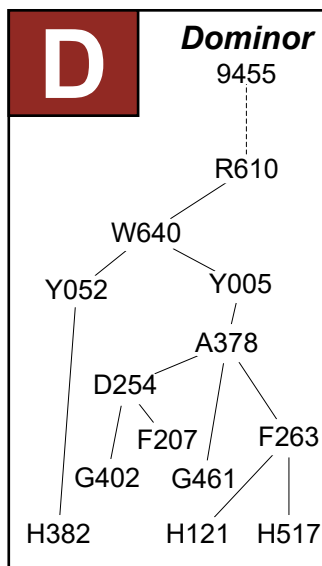
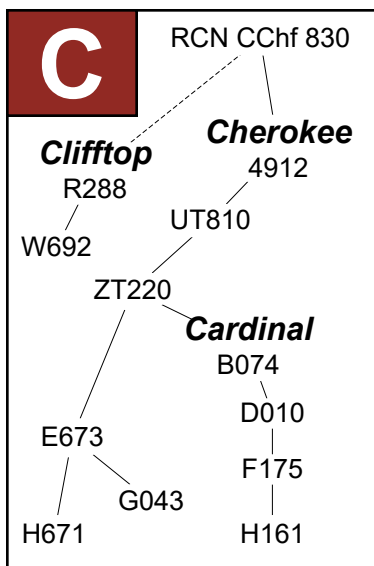
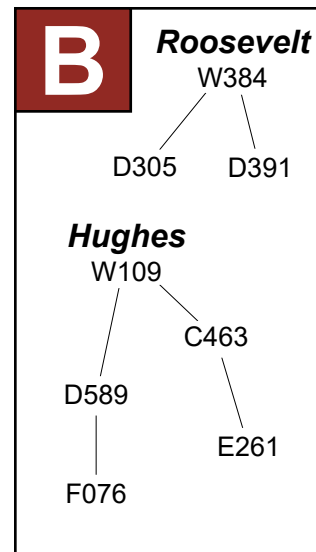
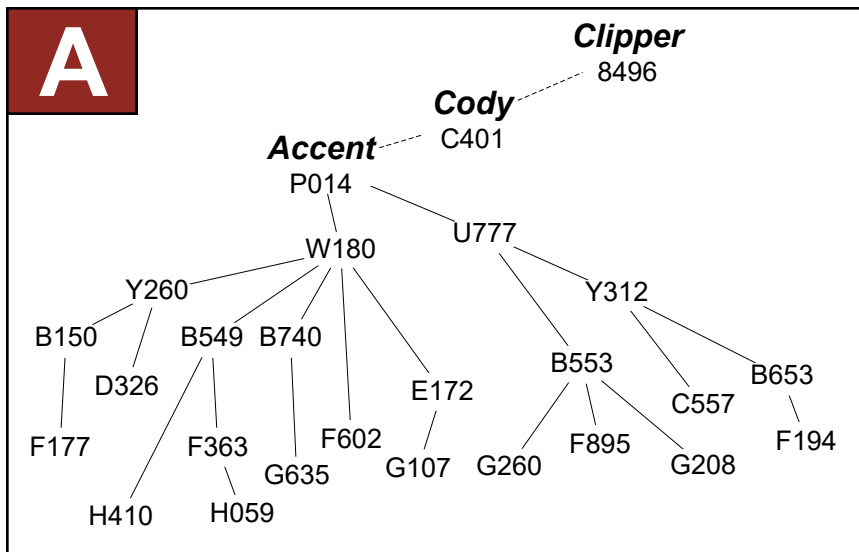

★ Red Angus Trait Leader



# L

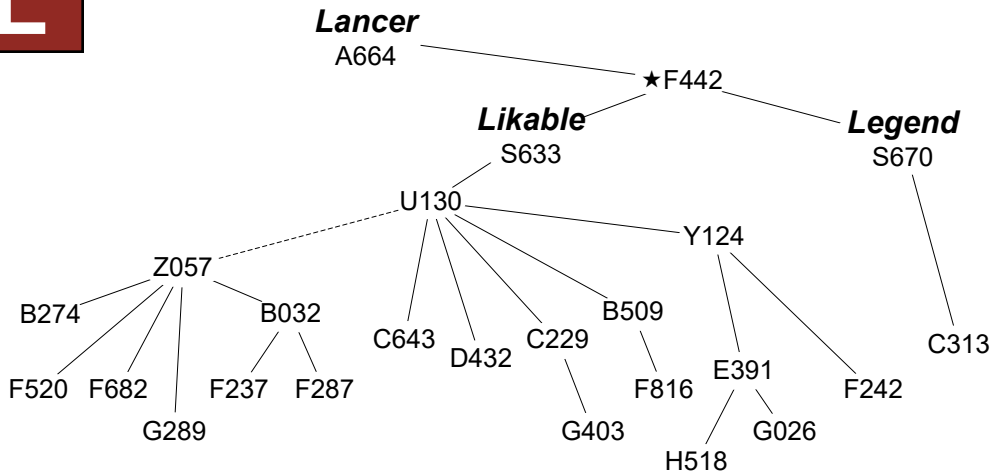

Name	Tag	Family
Julian	A434	J-4
Nebula	A773	N-2
Likable	B032	L-1
Cardinal	B074	C-1
Accent	B549	A-2
Julian	B571	J-1
Nebula	C067	N-3
Likable	C229	L-2
Hughes	C463	B-1
Heritage	C477	H-2
Dominor	D254	D-1
Roosevelt	D305	B-2
Accent	D326	A-3
Likable	D432	L-3
Accent	E172	A-4
Scamp	E175	S-1
Likable	E391	L-4
Cardinal	E673	C-2
Oracle	ES142	O-1
Julian	F067	J-5
Accent	F177	A-5
Likable	F242	L-5
Dominor	F263	D-2
Epic	F279	E-1
Likable	F287	L-6
Nebula	F440	N-4
Heritage	F615	H-3
President	FL177	O-2
Scamp	G006	S-2
Likable	G026	L-7
Cardinal	G043	C-3
Accent	G107	A-6
Heritage	G152	H-4
Accent	G208	A-7
Oracle	G222	O-3
Scamp	G236	S-3
Nebula	G249	N-5
Accent	G260	A-8
Likable	G289	L-8
Ranger	G299	R-1
Scamp	G325	S-4
Warrior	G356	W-1
Dominor	G402	D-3
Likable	G403	L-9
Oracle	G434	O-4
Jet	G441	J-6
Dominor	G461	D-4
Julian	P608	J-2
Hlfmn Hstr	R588	H-1
Nebula	S347	N-1
Accent	W180	A-1
Julian	Z382	J-3

# N

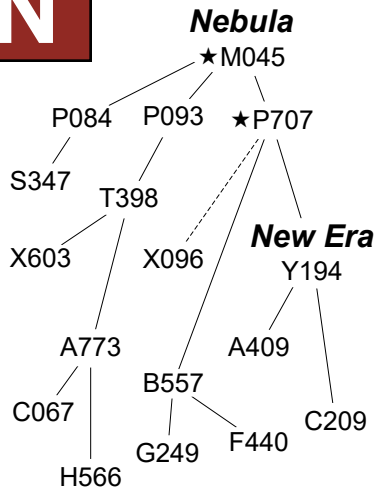

# O

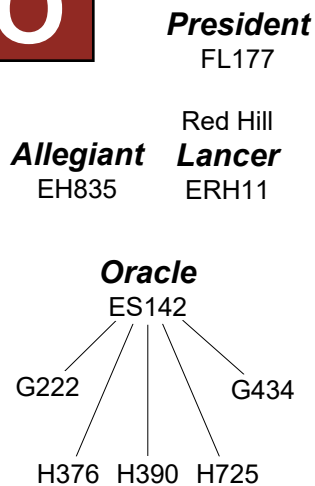

# R

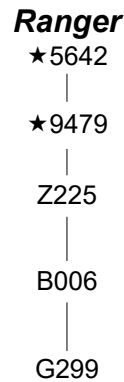

# S

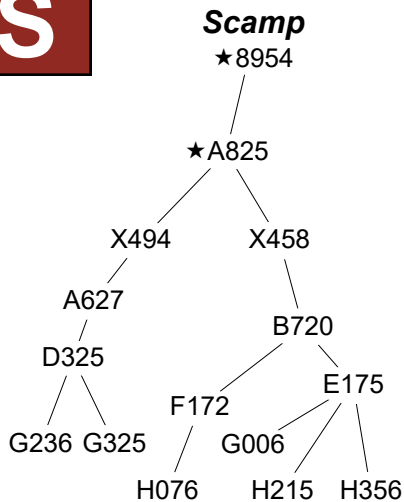

# V

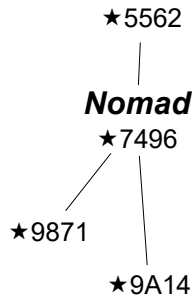

# W

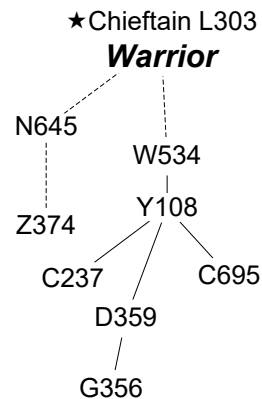

# Lot-Tag Cross Reference

ID	Lot	ID	Lot	ID	Lot	ID	Lot	ID	Lot	ID	Lot	ID	Lot
<b>Bulls</b>								<b>Heifers</b>				<b>Ref. Sires</b>	
J010	.61	J218	.91	J394	.101	J584	.170	J835	.172	J107	.314	A434	J-4
J018	.102	J219	.43	J395	.135	J592	.28	J837	.212	J130	.312	A773	N-2
J019	.4	J220	.62	J396	.68	J593	.137	J850	.203	J166	.302	B032	L-1
J020	.51	J228	.66	J397	.60	J594	.141	J854	.140	J182	.313	B074	C-1
J027	.116	J230	.96	J400	.76	J604	.120	J857	.201	J184	.301	B549	A-2
J045	.8	J232	.223	J401	.14	J606	.171	J862	.173	J199	.317	B571	J-1
J046	.42	J236	.6	J403	.214	J611	.192	J868	.208	J248	.316	C067	N-3
J048	.129	J239	.80	J406	.182	J613	.149	J874	.205	J257	.322	C229	L-2
J052	.122	J242	.16	J408	.198	J615	.200	J879	.202	J285	.307	C463	B-1
J053	.64	J243	.175	J413	.3	J619	.130	J891	.210	J300	.311	C477	H-2
J059	.93	J245	.5	J415	.216	J620	.29	J893	.165	J309	.321	D254	D-1
J067	.99	J246	.19	J423	.70	J635	.9	J896	.168	J310	.319	D305	B-2
J069	.53	J247	.74	J425	.233	J636	.230	J898	.209	J318	.324	D326	A-3
J074	.103	J256	.67	J428	.152	J638	.126	J900	.164	J335	.323	D432	L-3
J075	.72	J261	.160	J429	.199	J640	.196	J902	.166	J342	.306	E172	A-4
J076	.13	J270	.46	J432	.228	J641	.134	J911	.207	J357	.308	E175	S-1
J079	.20	J272	.151	J442	.144	J647	.234	J917	.163	J376	.315	E391	L-4
J082	.98	J275	.123	J445	.41	J648	.178	J919	.167	J377	.304	E673	C-2
J083	.176	J280	.78	J448	.40	J653	.211	JC178	.23	J426	.305	ES142	O-1
J093	.36	J282	.154	J449	.65	J654	.185	JC183	.25	J447	.318	F067	J-5
J097	.59	J292	.48	J451	.180	J668	.136	JC186	.24	J518	.309	F177	A-5
J098	.92	J297	.38	J455	.12	J675	.95	JC188	.26	J530	.320	F242	L-5
J104	.18	J298	.75	J465	.138	J677	.224	JC189	.27	J557	.325	F263	D-2
J110	.125	J302	.142	J469	.81	J683	.37			J562	.303	F279	E-1
J112	.119	J306	.10	J470	.139	J684	.189			J622	.310	F287	L-6
J113	.30	J307	.108	J471	.128	J690	.85					F440	N-4
J116	.145	J308	.100	J472	.2	J692	.221					F615	H-3
J119	.193	J315	.146	J474	.77	J694	.195					FL177	O-2
J121	.15	J316	.7	J479	.33	J698	.220					G006	S-2
J122	.232	J321	.197	J480	.153	J702	.161					G026	L-7
J133	.69	J322	.109	J481	.45	J703	.179					G043	C-3
J137	.47	J323	.52	J482	.94	J705	.177					G107	A-6
J146	.71	J329	.184	J486	.114	J708	.190					G152	H-4
J152	.183	J333	.97	J490	.115	J716	.89					G208	A-7
J154	.32	J334	.11	J519	.73	J727	.54					G222	O-3
J161	.21	J343	.57	J521	.132	J728	.219					G236	S-3
J171	.186	J344	.218	J522	.213	J731	.158					G249	N-5
J173	.56	J347	.217	J524	.191	J735	.162					G260	A-8
J177	.229	J355	.227	J529	.157	J739	.104					G289	L-8
J178	.79	J358	.113	J531	.111	J746	.222					G299	R-1
J180	.90	J359	.58	J537	.148	J747	.121					G325	S-4
J181	.31	J361	.50	J540	.133	J753	.159					G356	W-1
J187	.22	J362	.17	J542	.194	J766	.215					G402	D-3
J190	.156	J365	.226	J545	.49	J768	.35					G403	L-9
J191	.82	J369	.187	J551	.110	J769	.204					G434	O-4
J196	.117	J373	.225	J553	.105	J771	.150					G441	J-6
J197	.181	J375	.83	J559	.1	J776	.155					G461	D-4
J203	.143	J379	.188	J563	.147	J793	.107					P608	J-2
J204	.86	J381	.124	J569	.39	J796	.84					R588	H-1
J206	.106	J384	.127	J574	.118	J815	.231					S347	N-1
J207	.131	J385	.88	J578	.87	J817	.169					W180	A-1
J211	.34	J386	.44	J581	.55	J826	.174					Z382	J-3
		J389	.63	J582	.206	J827	.112						

# Family who help us in many ways over the course of the year



*Shelley Forbes and Jason Brown  
with Nolan and Emery*



*Tallie Forbes and Justin Lee  
with Claire and Ryan*



*Don Bingham and Alison Brody with Kate*



*Stephen Forbes and Morgan Baldwin*



*Cam and Trish Forbes  
wrangling grandkids Nolan, Claire, Ryan, and Emery*



*Doug Foster and Sarah Forbes*



*Julia Forbes & Ed Waddington  
(with Tazmin and Flinder)*



*Keenan Forbes and Onn Bunmat, Ellen Durkin, Jo and Spike Forbes,  
and Julia and Sarah Durkin*



*Sheila and Doug Bingham*



*Elfie Forbes*

# Beckton Stock Farm

Cam Forbes  
37 Beckton Drive  
Sheridan, WY 82801

Tel.: 307.674.6095, 674.8162 (evening)

Email: [becktonwyo@gmail.com](mailto:becktonwyo@gmail.com)

Web: [www.BecktonRedAngus.com](http://www.BecktonRedAngus.com)

Video of Sale Bulls available on our Website

## FIRST CLASS

Industry leading genetics and the highest quality  
Red Angus, with 77 years of Satisfied Customers



Superior Productions will provide internet and representative bidding services for buyers who can't make it to the sale. Please see page 3 for more information.

**Free Delivery**  
anywhere in the Continental US