

1 **Beckton** **Red Angus**

Foundation Herd of the Red Angus Breed

December 5th, 2023
Fall Production Sale

55 Reg. Cows and Heifers
160 Commercial Cows
60 Bulls

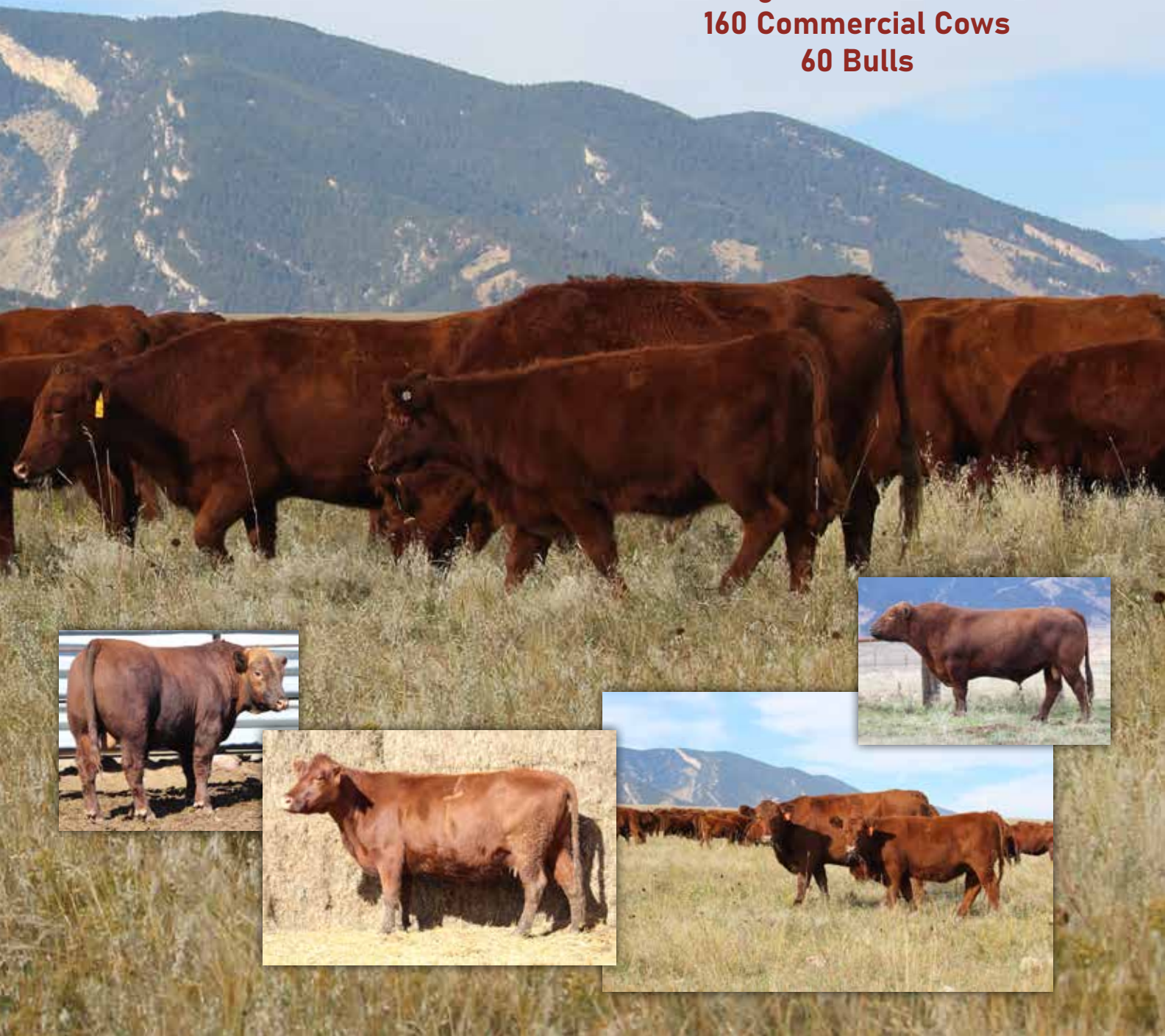

1 Beckton Red Angus

37 Beckton Drive • Sheridan, WY 82801 • becktonwyo@gmail.com
 Office: 307.674.6095 • Evenings: 674.8162 • Fax: 672.7281

Dear Friends and Cattlemen,

On behalf of my family and all of us here at Beckton, we want to welcome you to Beckton's first fall production sale in many years. Several factors came together to prompt this sale, but they add up to 'we have too many good cows'.

To start with we haven't sold our top-producing, prime age cows in many years. Every year we add replacement heifers that move our genetics forward, but at some point females have to go. Now we simply have too many prime and proven age Registered cows with great production records, and that still have good years of production left. Our cows can produce to fifteen or sixteen years of age or more. We hope to find good homes for these ladies where they can still keep producing calves, as these are elite cows and donor prospects. We have 75 of these girls and have them grouped in 35 lots, and we are letting you pick.

The same thing has happened on the bull side. We breed almost entirely natural service, so we use a lot of bulls, and we add 15 or more yearling bulls every year to use with our replacement heifers. We turn our bull genetics very rapidly to keep moving our herd forward, and don't necessarily want them going back on their own daughters. These are herd sire caliber bulls that we originally selected for our own replacements. They are young, starting at just three years old, and have many years of good service still ahead.

Finally, we have younger bulls from our 2022 crop that are now 18 months of age, going to be two next spring, and ready to go to work. All of the USDA and Cattlefax inventory numbers say the cow and calf numbers are going to be lower next year, and bull sale supplies are likely lower also. Getting bulls now for 2024 needs is probably the best investment any market offers.

Once again we welcome you to our sale. You will be able to bid through Superior Livestock, but if you can come in person we would like very much to have you.

Sincerely,

Cam Forbes

Tenderness Scores	
DNA	Ultrasound
9-10 Outstanding	0.8-1.6 Tender+
7-8 Very Good	1.7-2.5 Tender
5-6 Average	2.6-4.0 Tender-
3-4 Poor	4.1-6.0 Fair to Tough
1-3 Very Poor	



• Since 1945
 Red Angus Breed

Beckton Fall Production Sale



Some Facts about the Beckton Herd

Beckton has long been one of America's premier breeders recognized for genetics which combine a genuine balance of desirable traits - calving ease, maternal traits, and rapid growth to yearling age. They are a leading choice for commercial replacement females and for building a great cow herd. And the lower birth weights make them a first choice for breeding heifers.

HERD STAYABILITY: Beckton is the #1 Herd in the Red Angus breed for Stayability, and has been for many years. 15 of the top 20 highest ranking sires in the breed for **Stayability EPD** are Beckton sires or descended from Beckton sires.

EASY CALVING: Beckton has long been the choice for easy calving sires that still have gain and growth. **9 of the top 10** highest ranking sires in the breed for **Calving Ease EPD** (and 44 of the top 50 sires) are Beckton sires or descended from Beckton sires.

CARCASS QUALITY: For **Marbling EPD**, **8 of the top 10 highest ranking sires** (and 44 of the top 50 sires) are Beckton sires or descended from Beckton sires. Beckton genetics are very popular for grass fed and natural beef programs. Raised and developed on our short grass and mountain pastures here in northern Wyoming, and upgraded from Angus origins, they are a natural source for these private beef marketing programs. We have regular bull customers from California to Texas to Maine and most states in between, who want our genetics for **easy marbling, early maturity, ability to gain on grass and roughage, and high scoring beef tenderness.**

MODERATE MATURE SIZE: One characteristic of Beckton cattle which makes them ideal for producing replacement females and building a low cost, efficient cowherd, is the **moderate mature size**. Page 5 shows the results of decades of genetic selection. We believe we have the best genetics for **Efficiency** that can be found anywhere.

Beckton Ranch

37 Beckton Drive

9½ miles West of Sheridan, Wyo.

Phone: 307.674.6095

Tuesday, December 5th, 2023

1:00 pm (Lunch at noon)

Lots A & B: First choice and runner up for buyers choice Beckton registered bred heifers

Lot C-1 to C-4: 160 head of young commercial Red Angus cows with Beckton breeding

Lots 1 - 35: Buyer's choices of 75 prime age & proven, elite producing, Beckton Registered Red Angus females

Lots 51 - 67: Young and prime age, high performance Herd Sires

Lots 102 - 149: 18-month age-ready bulls

Catalog Table of Contents

Sale Information.....	2
The Beckton Program.....	4
Beckton History.....	6
Buyer's Choice - Yearling Heifers.....	8
Commercial Cows.....	9
Prime Age & Proven Registered Cows..	10
Young & Prime Age Herd Bulls.....	25
Age-Ready 18-month Bulls.....	30
Sale Terms and Conditions.....	41
Sire Bloodline Charts.....	42
Lot-Tag Cross Reference.....	44

Sale Information

Details

Health Program: Beckton has a comprehensive herd-wide health program which includes vaccinations for 7-Way, IBR, BVD, PI3, BRSV, Lepto, and ivermectin. The heifers are also vaccinated for bangs and vibrio.

Fertility Tested: All bulls have passed a rigorous fertility exam that included live semen evaluation, scrotal measurements, and reproductive tract examinations.

All Bulls "Trich" Tested: In all the years we have been selling and delivering bulls, Beckton has never had a bull test positive for "trich". But because an increasing number of states require testing of yearling bulls, and to avoid any delay in delivery time, we will have all the sale bulls tested negative for "trich" prior to the sale. Customers from any state may also come to the sale with their trailer and load out directly after the sale.

Osteopetrosis Tested: When a genetic test was developed by RAAA for osteopetrosis (OS), Beckton tested every sire in use in our program, as well as our major AI sires. Every Beckton bred sire (nearly 80 in total) tested OS Free.

Semen Interest Retention: Buyer receives full possession and one half semen interest in all the bulls in the catalog. Seller is retaining one half interest in all bulls in the catalog. This is done so we can use some of the bulls in herd and reserve the right to collect and market semen on these bulls. Any collection on our behalf would be at our expense and could be done during the off-season and at the convenience of the buyer. The buyer would have the option to share in the collection and retain semen for the buyer's use also. If semen is marketed by either party, Seller receives one half royalty interest on gross semen sales, and buyer receives one half interest. Regardless of semen collection and marketing, the buyer retains full possession, full pasture use rights, and full salvage value in these bulls.

Free Delivery: Four or more Registered females will receive 1000 miles free delivery, with additional distance at cost. All other sale animals are delivered at cost.

Payment: Payments can be made with cash, check payable to Beckton Stock Farm, Inc. or Visa/Mastercard on sale day.



Auctioneer Roger Jacobs
406-698-7686



Pete Crow
Western Livestock Journal
303-722-7600



Matt Wznick
Western Ag Reporter
406-489-2414

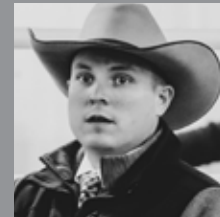

Devin Murnin
Western Livestock Journal
406-696-1502

Accommodations

Ramada Plaza

307-672-8931, I-90, Exit 25

Best Western Sheridan Center

307-674-7421, 612 N. Main Street

Days Inn

307-672-2888, 1104 Brundage Lane

Super 8 Motel

307-672-9725, 2435 N. Main Street

Transportation

United Airlines

Daily flights to/from Denver
united.com

Avis Car Rental

307-672-2226, Sheridan Airport

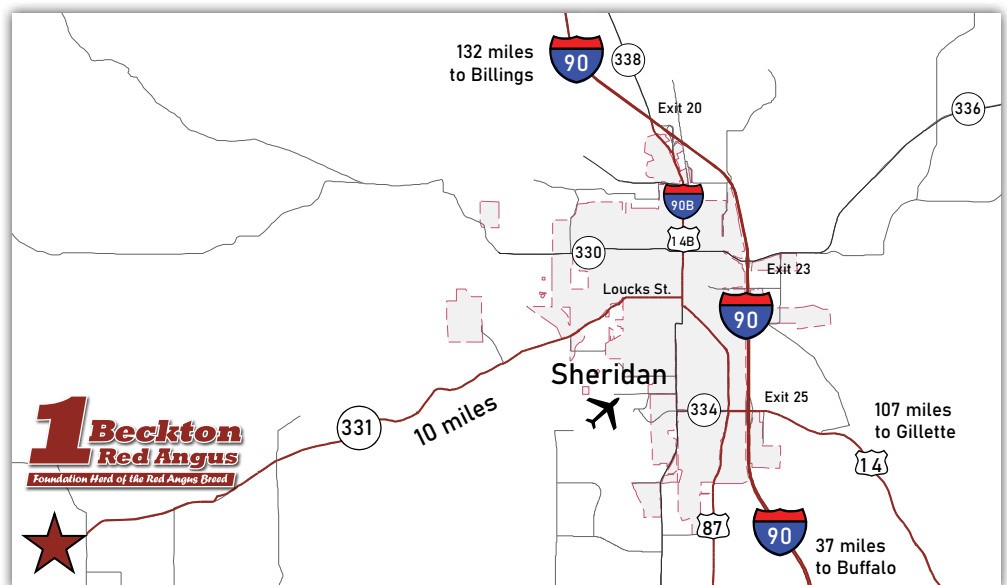

How to Participate as an Absentee Bidder

Buyers purchasing via Superior or Pelton Livestock can mail a check after the sale with brief delivery instructions and an approximate date you would like delivery by. If you would like to pay with a credit card, please call the office the day after the sale.

1. Site-Unseen Purchase

If you are unable to attend the sale, we can help you select the bulls or heifers to fit your needs. Give us a call, letter, fax or email, and we can handle bidding for you according to your directions. Satisfaction is guaranteed on all animals purchased "sight-unseen". Over a quarter of our bulls sell this way, mostly to long-time and repeat customers. To provide adequate time to assist you, please contact us before sale day.

2. Superior Livestock Productions: Two Options

Pre-register at www.superiorlivestock.com prior to the sale, and then select one of the following methods to bid:

Turn in Bids Over the Phone. To get started simply go online to www.superiorlivestock.com and click on the tab titled "Register for a Buyer Number". Select the registration form for Superior Productions and print the registration form, fill it out and fax it in to Superior Productions at 817-378-3380 with a signature on it, or scan and email the form to

info@superiorauction.com. You can also mail it in to the address provided on the form. Upon receipt of this information Superior will call you with a buyer's number and the bid line phone number that you will use on sale day to place bids over the phone.

OR

Online Click-To-Bid. This is Superior's online bidding platform for cattle buying. Please note that high speed internet is required - this is not for dial-up or satellite internet. Registration is free, but you must become a member of www.superiorclicktobid.com to sign up. Becoming a member is easy - just go to the homepage of www.superiorclicktobid.com and follow the out-lined steps to get started. Input your information and select a username and password. You will receive an e-mail confirming you are a member. From that point forward you just have to sign in and select the sale you would like to register for and once approved you will receive an e-mail confirming which sale you are now registered for.



The Beckton Crew today...



Randy Zier



Alan Sanders



Roger Zier

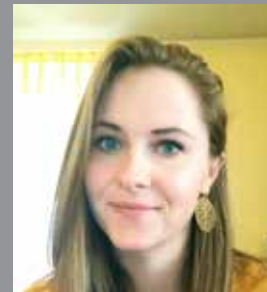

Shelby MacMillan



Allison Natzel



Matt Zier



Kyle Milliken



Serving our customers for 78 years with industry leading genetics and the highest quality cattle.



The Beckton Program



Beckton has used per
believe our catt

Beckton's Efficiency Gain

Over the past 45 years, Beckton has been selecting for increased early rate of growth (to slaughter age) while holding cow weights constant. We have accomplished this by selecting for growth, restricting birth weight and cow size creep, and using rapid generation turnover to multiply each incremental change rapidly throughout our entire cowherd and all of our bloodlines. We have seen a dramatic increase in economic efficiency. **Our average cow weighs about 96% of what she weighed in 1978, but our average yearling weight is 128% of what it was in 1978.**

The U.S. cattle industry has also been increasing average steer slaughter weights, but industry-wide there has been no effort to control cow size. It turns out that industry cow weights are increasing at about the same percentage as steer and heifer slaughter weights. (Industry-wide, cows weigh 129% and steers weigh 133%, compared to 1978 weights). **Over 45 years, there has been minimal improvement in overall cow herd efficiency.** The increase in growth and value of market animals is being largely offset by the increase in feed requirements and maintenance cost of the mother cow herd.

The accompanying graphic shows the increase in efficiency of Beckton cattle compared to the U.S. beef industry. In the promotion of composites, the impact of retained heterosis on mature weight is too often ignored. Cross-breeding and composite breeding have done little more than simply increase general cattle size. Crossbreeding and composites are sold as a free lunch, but they aren't free.

Cow Efficiency

We present two indicators of efficiency. The first is Weaning Percent, a simple percentage of calf 205 day weight divided by the dam's actual weight at weaning. The second is PRI Cow Efficiency. This also measures calf weaning weight, but relative to the cow's metabolic weight, and is expressed as an index above or below 100.

These efficiency measures are best used as indicators of where an animal is relative to others, rather than directly for selection. For example, if we see an animal with a low efficiency, we would look at the actual calf and cow weights to decide if the calf is too small, or the cow too big for the environment. That in turn will suggest corrective actions. In general, select for the traits you need to change to make cattle more efficient, and efficiency will be the result.



Performance tested selection since 1945, and we cattle today are the most efficient in the industry.

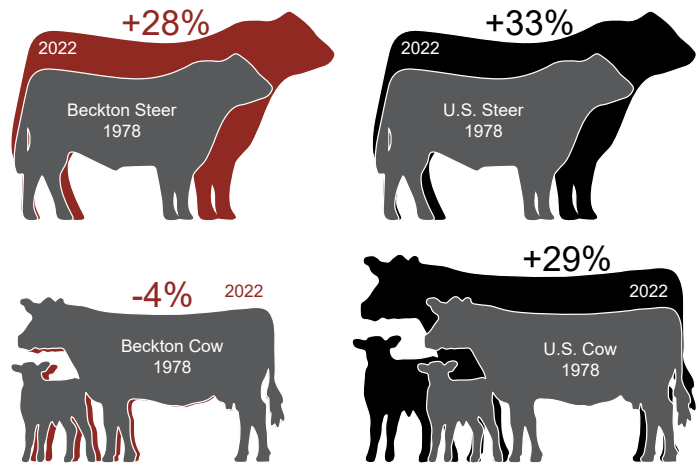

Dam Information

A major difference with our catalog is the greater amount of information about the dams we provide. Weaning percent and Cow Efficiency are explained above. In addition, with each sale animal we give the dam's age when this calf was born, and the dam's actual weight when the calf was weaned the previous fall. We also provide her progeny averages – the average birth weight, weaning ratio, and yearling ratio – of her calves.

Beckton Performance

- Birth weight**
 - ★ Every sire entering our own program is used first on our own heifers, then on our cows.
 - ★ We have never used high birth weight sires in any part of our program, so big birth weights are rare.
 - ★ We get the pay weight, but with lower birth weights and greater calving ease.
 - ★ Full production from heifers. We use the same bulls on heifers and cows.
- Growth**
 - ★ Weaning efficiency, and rate of gain to slaughter weight second to none.
 - ★ Growth traits must be consistent with maintaining maternal qualities.
 - ★ Beckton cattle are ideally sized for today's packer demand.
- Hardiness**
 - ★ Every cow in the herd has spent part of her life in the Big Horn Mountain summer range, at elevations from 7000 to 10,500 feet.
 - ★ In 2001 we PAP tested all of our herd sires. The herd average PAP score was 32.5 at 4000', equivalent to a herd average PAP of 39 at 8000' (excellent scores).
 - ★ By the time she is 5, our average cow will have been trailed over 80 miles, above and beyond normal pasture rotation.
- Efficiency**
 - ★ The typical dam of our bulls weans over 50% of her body weight in 205 days, under range conditions, with no creep-feeding.
 - ★ The average dam produces over 100% of her own body weight in a year.
- Fertility**
 - ★ Every bull in our program is used in natural service, with 30-50 heifers/cows.
 - ★ Every cow in our program must cycle naturally and breed early under range conditions.
- Value**
 - ★ Beckton Red Angus produce more growth without high birth weights.
 - ★ They are the one-bull solution that can be used on both heifers and cows.
 - ★ Carcass quality is an extra benefit.
- Reliability**
 - ★ Beckton has been genetically improving Red Angus since 1945, a 30-60 year lead time over other producers.
 - ★ It is a complete, genetically sound breeding program, which demands whole-herd performance.

Beckton History

Beckton is one of the oldest ranches in the Sheridan, Wyoming area. It came into Forbes family ownership in 1899, and has grown since then. The home ranch lies in the foothills of the Bighorn Mountains, near the original Bozeman Trail. The site of the current ranch headquarters once included a post office and flour mill, founded by George Beck, from whom came the name "Beckton". George Beck's house, built in 1887, now serves as the Beckton ranch office.

In 1936, Waldo Forbes took over management of the Forbes family ranch. Waldo was interested in applying to beef cattle the ideas of performance testing and genetic selection for economically important traits. Waldo married Sal in 1939, just before World War II, and the two of them embarked on the undertaking that would make a contribution to the future direction of the beef industry — the establishment of an entirely new breed of cattle to be based on selection by performance traits of economic importance.

They bought top red calves from 18 leading registered Black Angus herds across the United States, using these red cattle to build the foundation herd of a new breed that was independent of existing breed associations. During the next decade, Beckton added many more red bulls and females from registered Black Angus herds. From early on, Beckton was active with crossbreeding their new Red Angus sires into their existing commercial Hereford herd, to create dual herds — one purebred Red Angus, and the other high-percentage Red Angus from the Hereford base. Today the two herds run side-by-side, sharing the use of our Red Angus sires.

In 1954 this new breed was formally established when the Red Angus Association of America was founded with performance testing as the cornerstone of breed improvement. Waldo served as the first president of the association until his death at the end of 1955. Sal served as the association's first Executive Secretary.

Today Beckton is the oldest and one of the largest Red Angus herds in the country, running approximately 1050 mother cows, 350 replacement females, and 100+ bulls (as

well as several hundred deer and elk) on 15,000 deeded and State lease acres. Each year, much of the cowherd is moved to high mountain pastures in mid-summer. The ranch grows all its own hay, primarily as grass-alfalfa mixes.

The forage and other resources are managed as much for information as for production. Simply put, we don't manage the cattle to maximize weaning weights or even conception rates. Our business is maximizing information; therefore the cattle are pushed far beyond industry norms. For example, 90% of the main cowherd is bred in single sire pastures at a rate of 40-50 cows per bull. The other 10% of the cowherd is bred AI. Heifers are divided into groups of 20-30 per bull. All yearling bulls potentially

entering our program are used with a heifer group first, for comparative progeny testing and calving ease evaluation. Every bull in our program must be able to be used without difficulty on first-calf heifers as well as older cows.

Likewise, the stocking rate we use is higher than other purebred or commercial ranches would use in our area. The

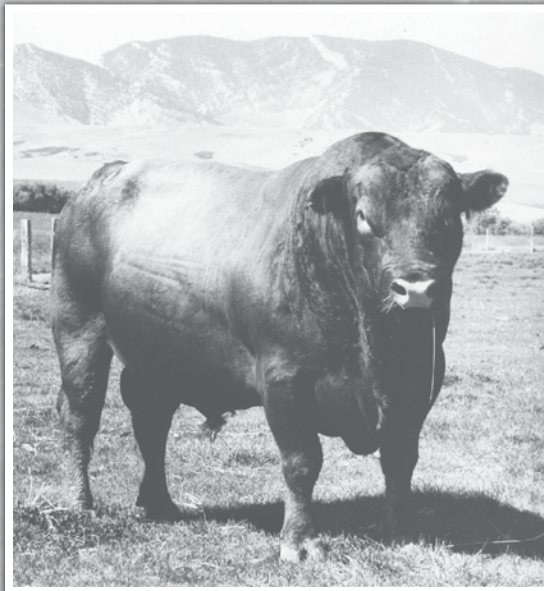

Beckton Larkabeau O "220" in 1959, the 1st Red Angus Bull at ABS.



high stocking rate plus the scattered nature of our pastures and the high mountain ground, means the cattle are moved frequently. We once calculated that by the time she is five, our average cow has been trailed (not trucked) over 100 miles.

Our product is a package of genetic improvements which contribute to the production efficiency of other growers, both commercial and purebred. The value of our product derives from the information we can provide about its likely performance, combined with the reliability and consistency of our quality control. We use random mating almost exclusively to get meaningful and statistically unbiased data.

We believe that the most important livestock component of a commercial ranch is its cowherd, the focus of nearly all ranch costs. The cow is a production unit, with a set of costs attached, so the data we collect has to relate to the economics of that unit. The overwhelming share of operating costs depends on the quantity of feed required, not on the number of cows being run. For example, the cost of building and maintaining fence depends on the size of the pasture, not on the number of cows within the pasture. A focus on production efficiency has kept our cow size quite stable over the years. Birth EPD's give us an effective selection tool for managing mature size. We have also steadily improved the post-calving, pre-slaughter growth rate.

In summary, we have four basic production goals; to maximize the validity, usefulness and repeatability of our genetic information; to maximize the health and lifetime production capabilities of the animals we sell; to maximize the sustainability of our own natural resources, and to do all these things in the most efficient and cost-effective way possible. Ultimately, our success is measured by the success of the commercial beef producers who use our genetics.



Beckton house/office in 1899. The antlers are still on the porch, and it is one of the oldest buildings in Sheridan County.



Sal and Waldo enjoyed square dancing.



Young Sal Forbes up on the mountain.



1960s Beckton Sale with Berdon's broadcast van.



Buyer's Choice of Yearling Heifers



LOTS A and B – Buyer's Choice of from one to twenty head from 180+ Beckton Registered bred 18 month old replacement heifers. This will be a private auction conducted by email directly with Beckton, commencing on the sale date Dec. 5 and continuing in the days thereafter until the First Choice and Runner-up buyers are determined.

LOT A

Winning Bidder Choice from 180+ Beckton Registered Red Angus 18 month old, replacement heifers. The winning bidder may select his or her choice of from one up to twenty head at the bid price.

LOT B

Runner-up Bidders' Choice from 180+ Beckton Registered Red Angus 18 month old, replacement heifers after LOT A selections have been made. A maximum total of 20 heifers will be sold in LOT A and LOT B.

LOT A / LOT B SELLING PROCEDURE

Prospective buyers should contact us directly and register on or before sale day (Dec. 5) to obtain a listing of the replacement heifers. Our replacement heifers will be available for direct viewing here at Beckton before, on and after our Dec. 5 sale date. At the sale more complete information will be provided to buyers who have registered, so that bidders may examine the performance records of the heifers while they are viewing. Prospective buyers who have registered but are not present at the sale may request this information via email.

Prospective buyers must submit an opening bid either in person or via email by the day of the sale in order to continue to bid. The subsequent bidding will be conducted via email and will be confidential with Beckton. Beckton will notify active bidders by email of the current high bid as it changes. Beckton will not disclose the names of any individuals bidding.

Bidding will continue until there is no increase in the bids for 72 hours. Beckton reserves the right to reject any and all bids.

Buyers do NOT need to indicate the number of heifers that they are interested in during the bidding process, as that may depend on final price. Once the winning bidder is determined, he or she may select from 1 to 20 specific heifers that they wish to purchase at that price. Once those heifers are selected, the remaining heifers, up to a total of 20 head, are available to the highest Runner-up bidder(s) bidding on LOT B. Remaining heifers, up to 20, will be selected by the Runner-up bidder(s) in order of bid price.

Bidders submit bids in person or by email to Beckton, and may bid on either, or both, of LOT A (guaranteed first choice of all heifers) or LOT B (runner-up selections of all heifers still available after the LOT A selections have been made). A buyer may submit bids for both LOT A and LOT B simultaneously and the bids can be different (eg. submit a higher bid for LOT A and a lower bid for LOT B).

Commercial Cows



Lots C-1 through C-4 are High Percentage Red Angus sired by Beckton Registered Red Angus sires. Every cow had a calf last spring. They are bred and pregnancy tested, pasture exposed to Beckton Red Angus sires. The high bidder for each group may select a gate cut of 6 or more head from that group. Bring your trailer, or several trailers!

LOT C-1	# Head 49	Age 2-4 year olds	Approx. Calving Start April 15	Genetics High % Red Angus	Bred to Beckton RA sires
----------------	---------------------	-----------------------------	--	-------------------------------------	------------------------------------

LOT C-2	# Head 70	Age 2-4 year olds	Approx. Calving Start March 5	Genetics High % Red Angus	Bred to Beckton RA sires
----------------	---------------------	-----------------------------	---	-------------------------------------	------------------------------------

LOT C-3	# Head 30	Age 5-6 year olds	Approx. Calving Start March 5	Genetics High % Red Angus	Bred to Beckton RA sires
----------------	---------------------	-----------------------------	---	-------------------------------------	------------------------------------

LOT C-4	# Head 12	Age 5-6 year olds	Approx. Calving Start April 15	Genetics High % Red Angus	Bred to Beckton RA sires
----------------	---------------------	-----------------------------	--	-------------------------------------	------------------------------------

Prime and Proven Registered Cows



These are the grand producers of our herd. A total of 75 prime and older proven producers with an incredible 105 average calf weaning ratio, 104 average calf yearling ratio, and 67 pound average calf birth weight. We haven't been able to part with these cows, but now we just have too many.

All 75 will be paired up into the following 35 lots. Each lot sells separately, and each buyer get his or her pick of the lot.

Four or more Registered females will receive 1000 miles free delivery, with additional distance at cost.

1-A Beckton Pine Marie D563 E

1-A 100% # 3551837 Tattoo: BKT6 D563

Birth: 3-29-16

OWN PROG AVG	
BWt	59
WW R	106
YW R	101

OWN DATA

Est Cvg	March
Feet	Good
Dolcility	Good
Udder	Good
BWt	83
Curr Wt	1250
Hip Ht	52
Sire Tndr	10

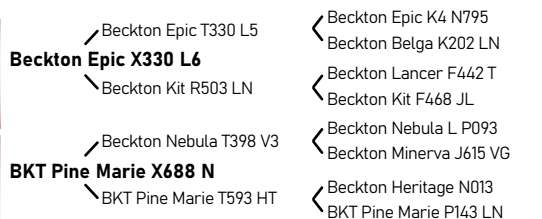

CE	BW	WW	YW	Milk	HPG	Stay	ME	Marb	REA	Bfat	HB	GM
16	-5.0	58	92	29	9	13	0.0	+37	+00	+04	35	27

This Epic daughter is only but has three daughters producing in our herd. Her most recent heifer calf was the second high seller in our sale last spring.

2-A Beckton Christy D793 A

1-A 100% # 3551281 Tattoo: BSF6 D793

Birth: 4-21-16

OWN PROG AVG	
BWt	67
WW R	106
YW R	100

OWN DATA

Est Cvg	March
Feet	Good
Dolcility	Good
Udder	Good
BWt	68
Curr Wt	1205
Hip Ht	52
Sire Tndr	9

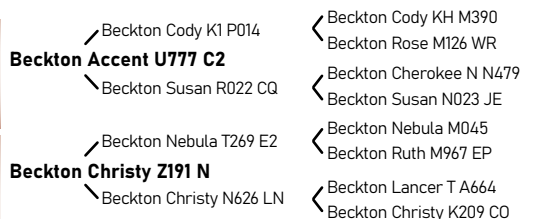

CE	BW	WW	YW	Milk	HPG	Stay	ME	Marb	REA	Bfat	HB	GM
17	-5.5	48	78	32	13	17	-2.0	+35	-13	+05	60	18

Take a look at this solid dam with CED and BW percentiles in the single digits. Her dam produced for us for nine years and was sold to continue in the George Redman herd.

1-B Beckton Indigo D691 L

1-A 100% # 3551253 Tattoo: BSF6 D691

Birth: 4-9-16

OWN PROG AVG	
BWt	65
WW R	104
YW R	100

OWN DATA

Est Cvg	March
Feet	Good
Dolcility	Good
Udder	Good
BWt	64
Curr Wt	1150
Hip Ht	49
Sire Tndr	9



CE	BW	WW	YW	Milk	HPG	Stay	ME	Marb	REA	Bfat	HB	GM
17	-6.3	45	79	31	14	19	-1.0	+41	-11	+03	71	38

D691 had a fantastic heifer calf this year after a string of raising solid bull calves.

2-B Beckton Tamara D313 L

1-A 100% # 3551826 Tattoo: BKT6 D313

Birth: 3-18-16

OWN PROG AVG	
BWt	66
WW R	107
YW R	106

OWN DATA

Est Cvg	April
Feet	Good
Dolcility	Good
Udder	Good
BWt	74
Curr Wt	1210
Hip Ht	52
Sire Tndr	10

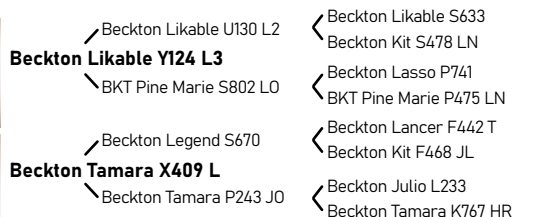

CE	BW	WW	YW	Milk	HPG	Stay	ME	Marb	REA	Bfat	HB	GM
17	-3.8	46	71	34	13	20	-4.0	+44	-02	+04	93	30

D313, just like her Tamara dam, has been an easy keeping dam who raises big calves. A high producer for both weaning and yearling weight.

1-C Beckton Annie D717 A

1-A 100% # 3551717 Tattoo: BKT6 D717

Birth: 4-12-16

OWN PROG AVG	
BWt	71
WW R	108
YW R	109

OWN DATA

Est Cvg	April
Feet	Good
Dolcility	Good
Udder	Good
BWt	71
Curr Wt	1155
Hip Ht	52
Sire Tndr	9

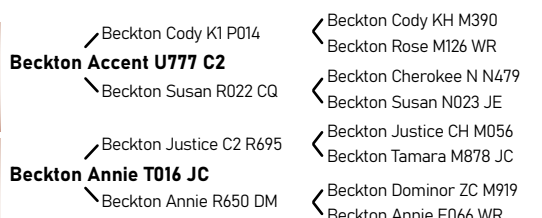

CE	BW	WW	YW	Milk	HPG	Stay	ME	Marb	REA	Bfat	HB	GM
19	-4.6	52	88	32	12	17	-3.0	+43	-06	+03	67	35

Look how many of these proven producers are sired by Accent U777, a half brother to W180. Annie gets it from her mother too - her dam was an above-average producer for us for 14 years.

2-C Beckton Tamara D574 A

1-A 100% # 3551632 Tattoo: BKT6 D574

Birth: 3-30-16

OWN PROG AVG	
BWt	82
WW R	106
YW R	101

OWN DATA

Est Cvg	March
Feet	Good
Dolcility	Good
Udder	Good
BWt	67
Curr Wt	1150
Hip Ht	49
Sire Tndr	10

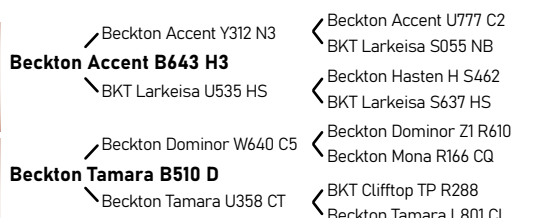

CE	BW	WW	YW	Milk	HPG	Stay	ME	Marb	REA	Bfat	HB	GM
13	-2.7	55	87	26	12	14	0.0	+35	+10	+04	31	32

Tamara's paternal granddam produced well for us for 13 years. Tamara also goes back to Accent U777.



Lot 2-C

3-C

Beckton Lana D614 A

1-A 100% # 3551737

Tattoo: BKT6 D614

Birth: 4-2-16

OWN PROG AVG	
BWt	73
WW R	102
YW R	102

OWN DATA

Est Cvg	March
Feet	Good
Dolcility	Good
Udder	Good
BWt	73
Curr Wt	1270
Hip Ht	49
Sire Tndr	10

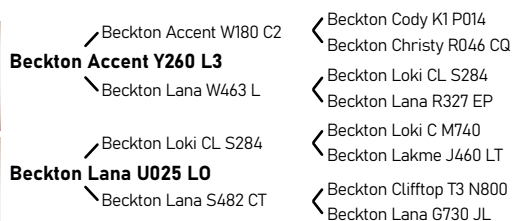

CE	BW	WW	YW	Milk	HPG	Stay	ME	Marb	REA	Bfat	HB	GM
13	-2.1	57	88	25	10	20	4.0	+5.0	-2.1	+0.5	65	27

D614 has calved six straight years between the 13th and 22nd of March !! She's on track to do the same thing this year.

3-A

BSF Erica D089 N

1-B 99% # 3551032

Tattoo: BSF6 D089

Birth: 2-25-16

OWN PROG AVG	
BWt	58
WW R	104
YW R	100

OWN DATA

Est Cvg	March
Feet	Good
Dolcility	Good
Udder	Good
BWt	50
Curr Wt	885
Hip Ht	48
Sire Tndr	6

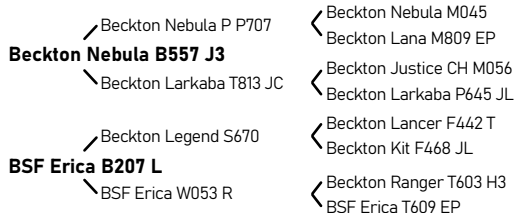

CE	BW	WW	YW	Milk	HPG	Stay	ME	Marb	REA	Bfat	HB	GM
19	-8.2	44	73	31	13	17	-8.0	+5.4	+0.1	+0.3	76	44

D089 is a Nebula daughter who's fantastic 2023 bull calf came in this fall with a very impressive weaning ratio of 123! She put in the work and came through it looking great.

4-A

Beckton Larkeisa D242 L

1-A 100% # 3551753

Tattoo: BKT6 D242

Birth: 3-14-16

OWN PROG AVG	
BWt	66
WW R	100
YW R	100

OWN DATA

Est Cvg	March
Feet	Good
Dolcility	Good
Udder	Good
BWt	77
Curr Wt	1075
Hip Ht	52
Sire Tndr	9



CE	BW	WW	YW	Milk	HPG	Stay	ME	Marb	REA	Bfat	HB	GM
15	-4.3	57	96	25	12	14	-1.0	+4.0	+1.2	+0.2	61	42

Larkeisa's las two calves were near the very top of their calf crop. Her dam - Larkeisa U535 - is the grandam of Lot 2-C, who we mentioned produced for us for 13 years.

3-B

Beckton Coca D139 A

1-A 100% # 3551920

Tattoo: BKT6 D139

Birth: 3-3-16

OWN PROG AVG	
BWt	72
WW R	108
YW R	104

OWN DATA

Est Cvg	May
Feet	Good
Dolcility	Good
Udder	Good
BWt	71
Curr Wt	1240
Hip Ht	54
Sire Tndr	9

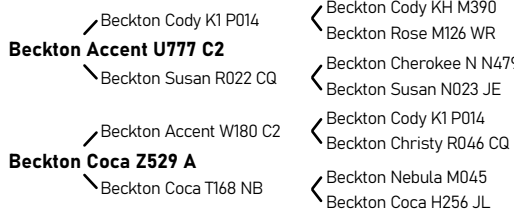

CE	BW	WW	YW	Milk	HPG	Stay	ME	Marb	REA	Bfat	HB	GM
17	-4.8	58	90	31	16	22	5.0	+3.8	-1.5	+0.5	95	12

D139 has 5 EPD percentiles in the single digits and is a double bred Accent daughter.

4-B

Beckton Kit D126 A

1-A 100% # 3551891

Tattoo: BKT6 D126

Birth: 3-1-16

OWN PROG AVG	
BWt	61
WW R	102
YW R	98

OWN DATA

Est Cvg	March
Feet	Good
Dolcility	Good
Udder	Good
BWt	54
Curr Wt	1010
Hip Ht	50
Sire Tndr	9

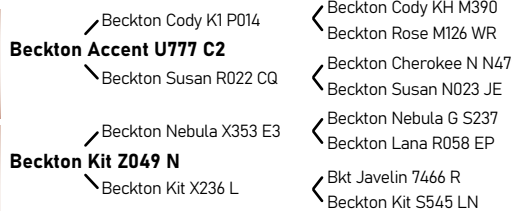

CE	BW	WW	YW	Milk	HPG	Stay	ME	Marb	REA	Bfat	HB	GM
21	-7.5	44	73	31	12	17	-1.0	+3.3	-0.5	+0.3	61	21

Yet another daughter of Accent U777 who rise to the top and stay in the herd. She had heifer calves in 2019 and 2020 that are both still in the herd.

4-C BSF Nebulann D682 E

1-B 99% # 3550984 Tattoo: BSF6 D682

Birth: 4-8-16

OWN PROG AVG	
BWt	70
WW R	106
YW R	108

OWN DATA	
Est Cvg	April
Feet	Good
Docity	Good
Udder	NA
BWt	69

CE	15	BW	-3.3	WW	57	YW	95	Milk	25	HPG	12	Stay	16	ME	2.0	Marb	+3.4	REA	-1.4	Bfat	+0.4	HB	52	GM	34
----	----	----	------	----	----	----	----	------	----	-----	----	------	----	----	-----	------	------	-----	------	------	------	----	----	----	----

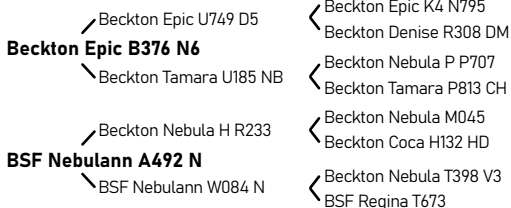

Here's an Epic daughter who raised nice, high caliber bulls for our spring sale in her first three years of service, and nice replacement females for us her latest three years.

5-B Beckton Larkaba D449 A

1-A 100% # 3551748 Tattoo: BKT6 D449

Birth: 3-24-16

OWN PROG AVG	
BWt	55
WW R	104
YW R	99

OWN DATA	
Est Cvg	March
Feet	Good
Docity	Good
Udder	Good
BWt	49

CE	24	BW	-11.1	WW	35	YW	59	Milk	34	HPG	14	Stay	20	ME	-8.0	Marb	+4.2	REA	-2.8	Bfat	+0.5	HB	90	GM	19
----	----	----	-------	----	----	----	----	------	----	-----	----	------	----	----	------	------	------	-----	------	------	------	----	----	----	----

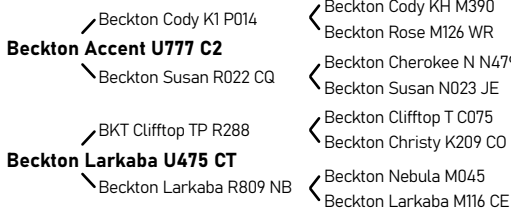

D449 is a very moderate sized cow if you are looking to down-size. But every calf has weaned in the top half of the herd. The queen of efficiency.

5-A Beckton Christy D394 N

1-A 100% # 3551627 Tattoo: BKT6 D394

Birth: 3-21-16

OWN PROG AVG	
BWt	67
WW R	102
YW R	100

OWN DATA	
Est Cvg	April
Feet	Good
Docity	Good
Udder	Good
BWt	64

CE	15	BW	-4.8	WW	54	YW	96	Milk	31	HPG	14	Stay	20	ME	-3.0	Marb	+3.8	REA	-1.6	Bfat	+0.4	HB	87	GM	42
----	----	----	------	----	----	----	----	------	----	-----	----	------	----	----	------	------	------	-----	------	------	------	----	----	----	----

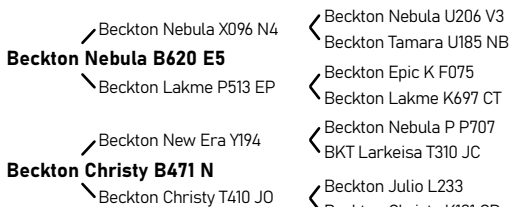

Almost half of this Nebula daughters EPD's are in the top 25% percentile! Christy's first calf in 2018 was a heifer whose four calves averaged a 111 weaning ratio.

5-C BSF Cherise D053 C

1-B 99% # 3551044 Tattoo: BSF6 D053

Birth: 2-18-16

OWN PROG AVG	
BWt	60
WW R	105
YW R	105

OWN DATA	
Est Cvg	May
Feet	Good
Docity	Good
Udder	Good
BWt	47

CE	21	BW	-8.0	WW	48	YW	81	Milk	31	HPG	13	Stay	19	ME	-3.0	Marb	+3.6	REA	+1.2	Bfat	+0.3	HB	79	GM	35
----	----	----	------	----	----	----	----	------	----	-----	----	------	----	----	------	------	------	-----	------	------	------	----	----	----	----

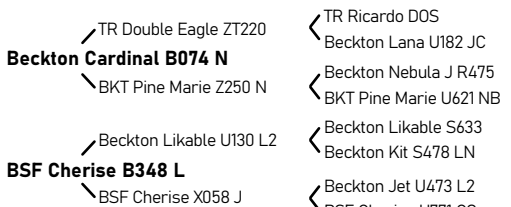

Possibly the best efficiency spread in the entire offering - average progeny weaning ration of 105; average yearling ratio of 105; with an average calf birth weight of just 60 pounds.



Lot 5-A

6-A Beckton Lana C003 S

1-A 100% # 3487951 Tattoo: BSF5 C003

Birth: 2-16-15

OWN PROG AVG	
BWt	73
WW R	106
YW R	108

OWN DATA	
Est Cvg	March
Feet	Good
Docity	Good
Udder	Good
BWt	52

CE	17	BW	-3.1	WW	55	YW	92	Milk	27	HPG	11	Stay	11	ME	-11.0	Marb	+3.1	REA	-1.3	Bfat	+0.3	HB	42	GM	16
----	----	----	------	----	----	----	----	------	----	-----	----	------	----	----	-------	------	------	-----	------	------	------	----	----	----	----

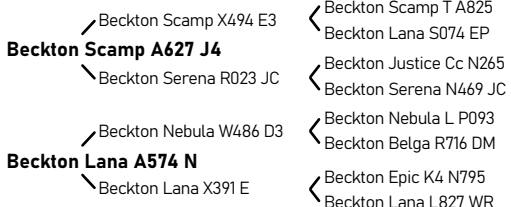

C003 descends from one of our longest running and most successful historical cow lines - the Lana family.

6-B Beckton Rose C414 A

1-A 100% # 3487313 Tattoo: BKT5 C414

Birth: 3-25-15

OWN PROG AVG	
BWt	62
WW R	110
YW R	110

OWN DATA	
Est Cvg	April
Feet	Good
Docility	Good
Udder	Good
BWt	71
Curr Wt	1320
Hip Ht	51
Sire Tndr	9

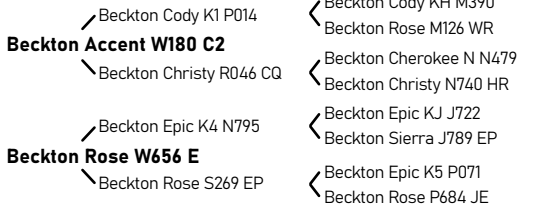

CE	BW	WW	YW	Milk	HPG	Stay	ME	Marb	REA	Bfat	HB	GM
17	-4.3	60	102	32	10	16	7.0	+38	+0.6	+0.5	45	34

This Accent W180 daughter knows how to work - C414 has never missed a calving opportunity and her calves finish near the top of their contemporary groups every time.

8-A Beckton Larkaba C061 N

1-A 100% # 3487457 Tattoo: BKT5 C061

Birth: 2-24-15

OWN PROG AVG	
BWt	59
WW R	106
YW R	104

OWN DATA	
Est Cvg	March
Feet	Good
Docility	Good
Udder	Good
BWt	49
Curr Wt	1060
Hip Ht	49
Sire Tndr	7



CE	BW	WW	YW	Milk	HPG	Stay	ME	Marb	REA	Bfat	HB	GM
16	-4.4	52	86	33	14	19	1.0	+46	+0.1	+0.5	73	36

Great progeny averages. An eight year old cow and all seven of her calves have been in the top half of the herd. Both of her daughters are also producing in our herd.

7-A Beckton Maiata C031 L

1-A 100% # 3487204 Tattoo: BKT5 C031

Birth: 2-22-15

OWN PROG AVG	
BWt	68
WW R	107
YW R	109

OWN DATA	
Est Cvg	April
Feet	Good
Docility	Good
Udder	NA
BWt	64
Curr Wt	1320
Hip Ht	52
Sire Tndr	9

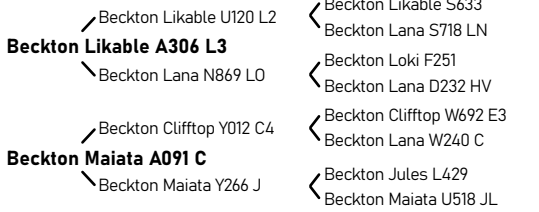

CE	BW	WW	YW	Milk	HPG	Stay	ME	Marb	REA	Bfat	HB	GM
16	-3.6	53	87	36	10	14	6.0	+41	-0.4	+0.3	29	37

C031 is a nice moderate sized, easy fleshing Likable daughter. We retained one of her sons as a herd sire and one of his sons as a herd sire as well!

8-B Beckton Emera C066 E

1-A 100% # 3487634 Tattoo: BKT5 C066

Birth: 2-24-15

OWN PROG AVG	
BWt	67
WW R	100
YW R	102

OWN DATA	
Est Cvg	March
Feet	Good
Docility	Good
Udder	Good
BWt	46
Curr Wt	1200
Hip Ht	51
Sire Tndr	10

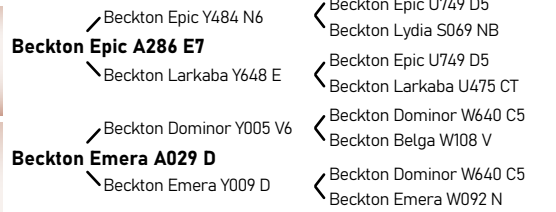

CE	BW	WW	YW	Milk	HPG	Stay	ME	Marb	REA	Bfat	HB	GM
22	-6.8	46	78	26	12	14	-2.0	+42	-0.4	+0.5	53	41

A good Epic daughter in the top 1% for BW and CED EPD's!

7-B Beckton Pine Marie C072 N

1-A 100% # 3487496 Tattoo: BKT5 C072

Birth: 2-25-15

OWN PROG AVG	
BWt	66
WW R	106
YW R	105

OWN DATA	
Est Cvg	March
Feet	Good
Docility	Good
Udder	Good
BWt	58
Curr Wt	1070
Hip Ht	49
Sire Tndr	10

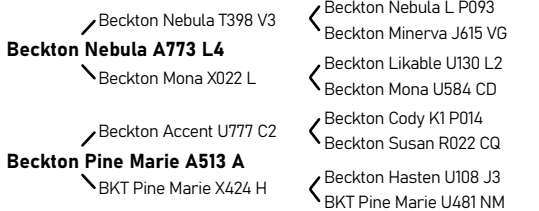

CE	BW	WW	YW	Milk	HPG	Stay	ME	Marb	REA	Bfat	HB	GM
13	-3.3	55	91	28	14	23	-3.0	+24	-1.3	+0.3	106	22

If you're looking for Herdbuilder, look no further. Its in the top 1% of the breed. Every calf has been in the top half of the herd at both weaning and yearling.



Lot 8-B

9-A Beckton Angel C791 J

1-A 100% # 3487377 Tattoo: BKT5 C791

Birth: 4-26-15

OWN PROG AVG	
BWt	63
WW R	102
YW R	105

OWN DATA

Est Cvg	March
Feet	Good
Dolcility	Good
Udder	Good
BWt	71
Curr Wt	1060
Hip Ht	50
Sire Tndr	8



CE	BW	WW	YW	Milk	HPG	Stay	ME	Marb	REA	Bfat	HB	GM
17	-4.2	60	99	26	16	17	-6.0	+3.6	+1.8	+0.3	78	42

A VERY RARE JULIAN B571 DAUGHTER !!! An efficiency leader - high progeny weaning and yearling averages with low birth weights.

10-B Beckton Emera C291 J

1-A 100% # 3487591 Tattoo: BKT5 C291

Birth: 3-20-15

OWN PROG AVG	
BWt	61
WW R	101
YW R	99

OWN DATA

Est Cvg	March
Feet	Good
Dolcility	Good
Udder	Good
BWt	44
Curr Wt	1130
Hip Ht	52
Sire Tndr	8

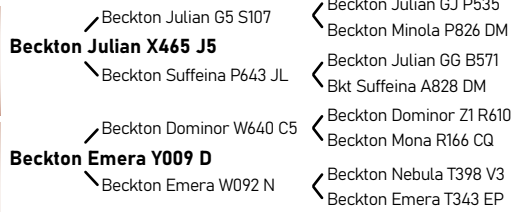

CE	BW	WW	YW	Milk	HPG	Stay	ME	Marb	REA	Bfat	HB	GM
21	-6.8	46	73	27	12	17	-2.0	+5.2	-1.0	+0.4	66	40

This Emera cow, her dam, and her maternal granddam have combined to produce for 26 years in our herd. Great productivity and longevity.

9-B Beckton Susan C047 S

1-A 100% # 3487626 Tattoo: BKT5 C047

Birth: 2-23-15

OWN PROG AVG	
BWt	62
WW R	103
YW R	102

OWN DATA

Est Cvg	March
Feet	Good
Dolcility	Good
Udder	Good
BWt	51
Curr Wt	975
Hip Ht	49
Sire Tndr	10

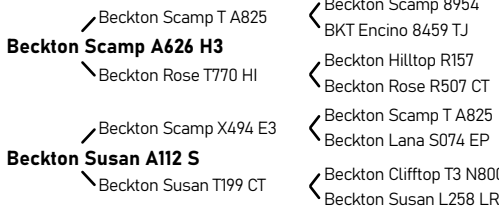

CE	BW	WW	YW	Milk	HPG	Stay	ME	Marb	REA	Bfat	HB	GM
18	-5.1	45	68	32	10	12	-3.0	+3.1	-1.0	+0.3	44	8

Another efficiency leader with low birth weights and high weaning and yearling rations on her calve. She's never missed, and of all her daughters are active in our herd.

11-A Beckton Rose C767 N

1-A 100% # 3487306 Tattoo: BKT5 C767

Birth: 4-21-15

OWN PROG AVG	
BWt	67
WW R	105
YW R	98

OWN DATA

Est Cvg	April
Feet	Good
Dolcility	Good
Udder	Good
BWt	72
Curr Wt	1045
Hip Ht	48
Sire Tndr	8

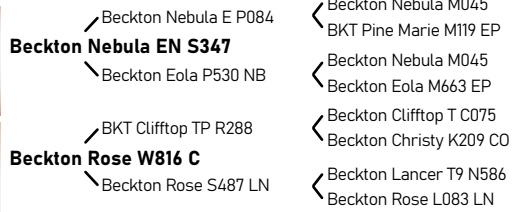

CE	BW	WW	YW	Milk	HPG	Stay	ME	Marb	REA	Bfat	HB	GM
16	-4.4	50	75	34	13	18	-11.0	+4.2	-1.8	+0.5	84	26

Rose C767, her dam, and her maternal granddam have combined to produce calves for 31 years in our herd. That's over 10 years per.

10-A Beckton Serena C296 S

1-A 100% # 3487287 Tattoo: BKT5 C296

Birth: 3-20-15

OWN PROG AVG	
BWt	66
WW R	109
YW R	104

OWN DATA

Est Cvg	April
Feet	Good
Dolcility	Good
Udder	Good
BWt	63
Curr Wt	1220
Hip Ht	50
Sire Tndr	9

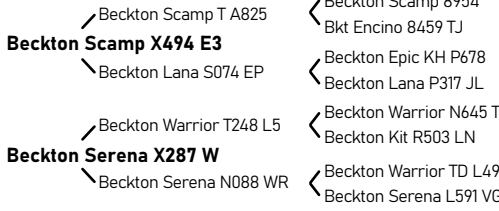

CE	BW	WW	YW	Milk	HPG	Stay	ME	Marb	REA	Bfat	HB	GM
18	-5.6	34	60	31	14	14	-11.0	+3.0	-3.7	+0.3	69	21

Super efficiency - calves with very moderate birth weights and very high weaning and yearling ratios in the upper end of the herd.

11-B Beckton Firefly C265 N

1-A 100% # 3487513 Tattoo: BKT5 C265

Birth: 3-18-15

OWN PROG AVG	
BWt	63
WW R	100
YW R	98

OWN DATA

Est Cvg	March
Feet	Good
Dolcility	Good
Udder	NA
BWt	61
Curr Wt	1280
Hip Ht	51
Sire Tndr	9

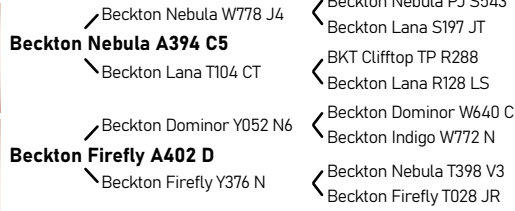

CE	BW	WW	YW	Milk	HPG	Stay	ME	Marb	REA	Bfat	HB	GM
16	-5.0	60	91	23	13	18	-2.0	+2.8	+0.3	+0.3	68	18

Both of her daughters, and her granddaughter, are all producing in our herd.

12-A

BSF Epiquette C255 N

1-B 99% # 3487678 Tattoo: BSF5 C255

Birth: 3-18-15

OWN PROG AVG	
BWt	78
WW R	116
YW R	107

OWN DATA

Est Cvg	March
Feet	Good
Docility	Good
Udder	Good
BWt	53
Curr Wt	1220
Hip Ht	54
Sire Tndr	10

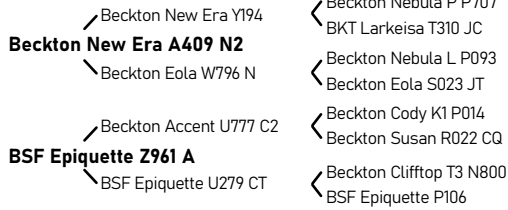

CE	BW	WW	YW	Milk	HPG	Stay	ME	Marb	REA	Bfat	HB	GM
12	-0.7	63	103	39	12	19	7.0	+29	-08	+03	62	29

It's no surprise this New Era daughter has the highest progeny average weaning ratio in this great cow line up, just look at her sire.

13-B

Beckton Rose B251 N

1-A 100% # 1705989 Tattoo: BKT4 B251

Birth: 3-18-14

OWN PROG AVG	
BWt	65
WW R	105
YW R	105

OWN DATA

Est Cvg	March
Feet	Good
Docility	Good
Udder	NA
BWt	75
Curr Wt	1250
Hip Ht	52
Sire Tndr	10

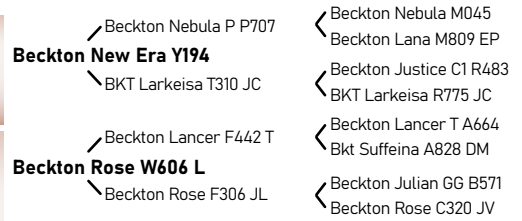

CE	BW	WW	YW	Milk	HPG	Stay	ME	Marb	REA	Bfat	HB	GM
14	-3.0	61	92	27	12	17	-4.0	+32	+03	+01	61	29

B251 is a well balanced New Era daughter who's first calf sold for \$16,000, impressive right from the start.

12-B

Beckton Belga C585 L

1-A 100% # 3487437 Tattoo: BKT5 C585

Birth: 4-2-15

OWN PROG AVG	
BWt	72
WW R	102
YW R	97

OWN DATA

Est Cvg	March
Feet	Good
Docility	Good
Udder	Good
BWt	64
Curr Wt	1040
Hip Ht	50
Sire Tndr	7

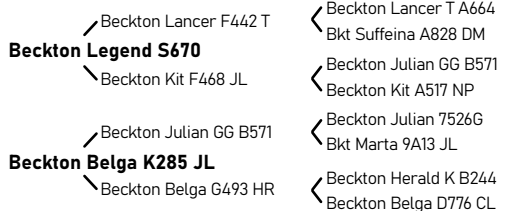

CE	BW	WW	YW	Milk	HPG	Stay	ME	Marb	REA	Bfat	HB	GM
17	-3.6	49	67	25	14	22	-6.0	+48	+02	+03	102	21

C585 is on track to be just like her Belga mom, she had C585 at 15 and went on to keep producing until she was 19.

14-A

Beckton Larkaba B352 A

1-A 100% # 1705646 Tattoo: BSF4 B352

Birth: 3-23-14

OWN PROG AVG	
BWt	72
WW R	111
YW R	112

OWN DATA

Est Cvg	March
Feet	Good
Docility	Good
Udder	Good
BWt	57
Curr Wt	1250
Hip Ht	52
Sire Tndr	10

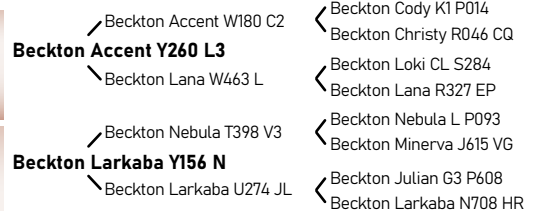

CE	BW	WW	YW	Milk	HPG	Stay	ME	Marb	REA	Bfat	HB	GM
14	-2.6	65	102	33	14	25	9.0	+44	-06	+05	102	31

With an impressive progeny average weaning ration of 111, we kept one of her sons as a herd bull. RAAA Herd Builder Index in the top 2% of the breed.

13-A

Beckton Tamara B700 E

1-A 100% # 1706138 Tattoo: BKT4 B700

Birth: 4-7-14

OWN PROG AVG	
BWt	65
WW R	109
YW R	106

OWN DATA

Est Cvg	April
Feet	Good
Docility	Good
Udder	Good
BWt	60
Curr Wt	1030
Hip Ht	50
Sire Tndr	10

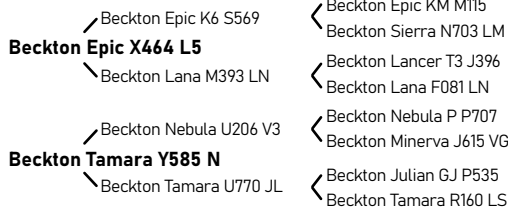

CE	BW	WW	YW	Milk	HPG	Stay	ME	Marb	REA	Bfat	HB	GM
16	-4.3	50	83	31	13	14	-5.0	+40	-09	+04	62	35

We liked B700 enough to keep one of her sons as a heavy hitting herd bull in our own herd sire lineup. We used him every year until he got hurt this fall.



Lot 13-A

14-B Beckton Belga B556 A

1-A 100% # 1705506 Tattoo: BSF4 B556

Birth: 4-1-14

OWN PROG AVG	
BWt	71
WW R	110
YW R	107

OWN DATA

Est Cvg	March
Feet	Good
Docility	Good
Udder	Good
BWt	63
Curr Wt	1130
Hip Ht	52
Sire Tndr	9

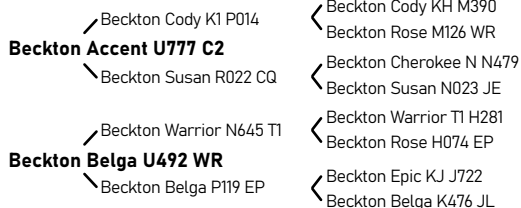

CE	BW	WW	YW	Milk	HPG	Stay	ME	Marb	REA	Bfat	HB	GM
15	-3.4	58	96	30	13	15	0.0	+38	-0.6	+0.4	57	26

Take a look at this moderate framed Accent U777 girl who's never missed a calving opportunity, earned a top progeny performance record, and this year produced one of the very highest heifers in our 2023 calf crop!

16-A Beckton Larkaba B704 C

1-A 100% # 1705924 Tattoo: BKT4 B704

Birth: 4-12-14

OWN PROG AVG	
BWt	80
WW R	107
YW R	103

OWN DATA

Est Cvg	May
Feet	Good
Docility	Good
Udder	Good
BWt	79
Curr Wt	1310
Hip Ht	52
Sire Tndr	9

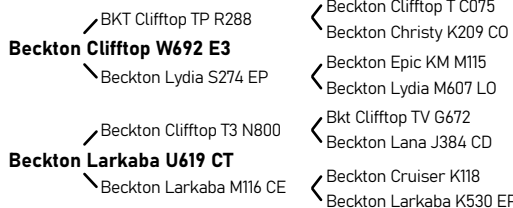

CE	BW	WW	YW	Milk	HPG	Stay	ME	Marb	REA	Bfat	HB	GM
10	-0.2	59	101	25	5	12	1.0	+37	-2.9	+0.5	13	32

These cows that produce great calves just keep going and going. Our cows would go to fifteen and older except that we try to find them homes with more grass before then.

15-A Beckton Tamara B547 L

1-A 100% # 1705493 Tattoo: BSF4 B547

Birth: 3-31-14

OWN PROG AVG	
BWt	63
WW R	104
YW R	104

OWN DATA

Est Cvg	April
Feet	Good
Docility	Good
Udder	NA
BWt	91
Curr Wt	1525
Hip Ht	54
Sire Tndr	7

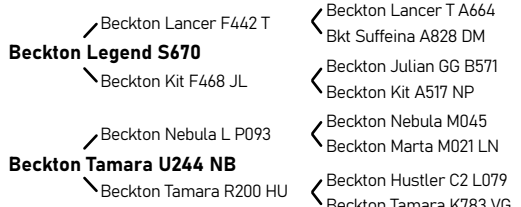

CE	BW	WW	YW	Milk	HPG	Stay	ME	Marb	REA	Bfat	HB	GM
15	-2.0	62	94	28	12	20	1.0	+33	+1.0	+0.2	83	25

Tamara B547 produces one of the highest spread between low birth weight and high weaning and yearling weight as one could expect to find.

16-B BSF Erica B207 L

1-B 99% # 1705524 Tattoo: BSF4 B207

Birth: 3-13-14

OWN PROG AVG	
BWt	64
WW R	107
YW R	104

OWN DATA

Est Cvg	March
Feet	Good
Docility	Good
Udder	Good
BWt	69
Curr Wt	1030
Hip Ht	51
Sire Tndr	7

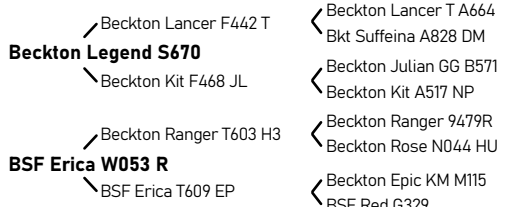

CE	BW	WW	YW	Milk	HPG	Stay	ME	Marb	REA	Bfat	HB	GM
18	-5.2	49	72	31	10	15	-10.0	+4.0	-0.5	+0.2	60	29

Erica B207's has never missed and her last five calves were born in an 8 day window between March 14 and March 22. A good udder and a moderate frame.

15-B Beckton Jane B220 L

1-A 100% # 1705446 Tattoo: BSF4 B220

Birth: 3-15-14

OWN PROG AVG	
BWt	74
WW R	107
YW R	107

OWN DATA

Est Cvg	March
Feet	Good
Docility	Good
Udder	NA
BWt	82
Curr Wt	1440
Hip Ht	53
Sire Tndr	7

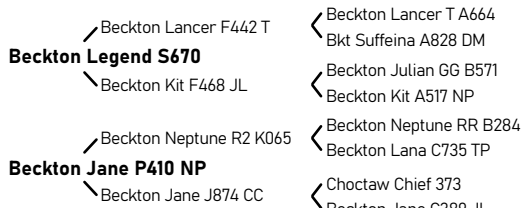

CE	BW	WW	YW	Milk	HPG	Stay	ME	Marb	REA	Bfat	HB	GM
13	-1.1	54	75	32	14	21	-2.0	+3.7	+1.1	+0.2	96	9

B220's dam was 10 years old when she had B220, and now B220 is going strong at 9. Great progeny performance is the reason.



Lot 16-B

17-A

Beckton Sierra A245 L

1-A 100% # 1626595 Tattoo: BKT3 A245

Birth: 3-21-13

OWN PROG AVG	
BWt	62
WW R	110
YW R	106

OWN DATA

Est Cvg	April
Feet	Good
Dolcility	Good
Udder	Good
BWt	55
Curr Wt	1160
Hip Ht	52
Sire Tndr	10

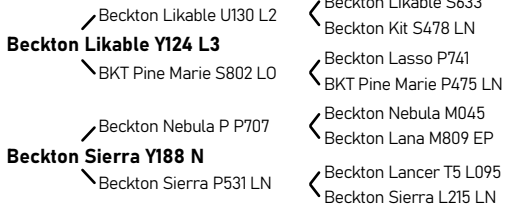

CE	BW	WW	YW	Milk	HPG	Stay	ME	Marb	REA	Bfat	HB	GM
19	-5.8	51	80	36	12	18	2.0	+0.40	-0.30	+0.03	79	23

Sierra A245 hits home runs time and again. She has raised calves weaning 118%, 113%, 113%, 113%, and 112%.

18-B

Beckton Pine Marie A446 L

1-A 100% # 1626347 Tattoo: BKT3 A446

Birth: 3-28-13

OWN PROG AVG	
BWt	72
WW R	106
YW R	106

OWN DATA

Est Cvg	April
Feet	Good
Dolcility	Good
Udder	Good
BWt	70
Curr Wt	1150
Hip Ht	51
Sire Tndr	10



CE	BW	WW	YW	Milk	HPG	Stay	ME	Marb	REA	Bfat	HB	GM
18	-4.0	49	75	26	12	17	-6.0	+0.31	-0.14	+0.01	63	21

Take a look at the rare bloodlines on the maternal side of A446, there's a reason her 1984 born grandsire is kept in use despite very limited semen.

17-B

Beckton Indigo A048 L

1-A 100% # 1626111 Tattoo: BSF3 A048

Birth: 3-9-13

OWN PROG AVG	
BWt	64
WW R	111
YW R	98

OWN DATA

Est Cvg	March
Feet	Good
Dolcility	Good
Udder	Good
BWt	45
Curr Wt	1000
Hip Ht	48
Sire Tndr	10

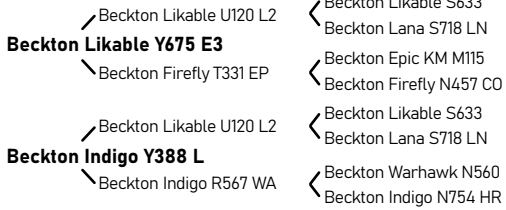

CE	BW	WW	YW	Milk	HPG	Stay	ME	Marb	REA	Bfat	HB	GM
20	-6.1	45	73	28	10	18	-9.0	+0.34	+0.04	+0.02	75	19

A048 is a nice Likable daughter who raised a beautiful heifer calf this year that was near the top of her contemporaries this fall with an impressive weaning ratio of 114. You'll want to keep her daughters!

19-A

Beckton Minerva A885 E

1-A 100% # 1626621 Tattoo: BKT3 A885

Birth: 5-1-13

OWN PROG AVG	
BWt	64
WW R	109
YW R	105

OWN DATA

Est Cvg	March
Feet	Good
Dolcility	Good
Udder	Good
BWt	61
Curr Wt	1080
Hip Ht	51
Sire Tndr	10



CE	BW	WW	YW	Milk	HPG	Stay	ME	Marb	REA	Bfat	HB	GM
17	-3.8	58	97	33	13	17	-2.0	+0.22	+0.18	+0.03	71	22

This lady has bred up on time, every time and boasts an impressive progeny average weaning ratio of 109!

18-A

Beckton Barmaid A123 O

1-A 100% # 1626062 Tattoo: BSF3 A123

Birth: 3-15-13

OWN PROG AVG	
BWt	65
WW R	116
YW R	108

OWN DATA

Est Cvg	March
Feet	Good
Dolcility	Good
Udder	NA
BWt	57
Curr Wt	1510
Hip Ht	56
Sire Tndr	8

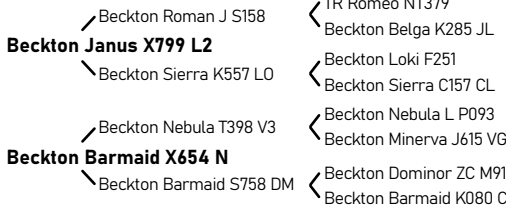

CE	BW	WW	YW	Milk	HPG	Stay	ME	Marb	REA	Bfat	HB	GM
14	-2.9	52	86	35	9	18	16.0	+0.33	-0.07	+0.04	34	21

One of the highest progeny performance record in this entire elite lineup. Here's a nice Barmaid dam earning a good reputation with an average progeny birth weight of 65 and a hefty average progeny weaning ratio of 116!

19-B

Beckton Lana A172 A

1-A 100% # 1626298 Tattoo: BKT3 A172

Birth: 3-18-13

OWN PROG AVG	
BWt	73
WW R	102
YW R	104

OWN DATA

Est Cvg	March
Feet	Good
Dolcility	Good
Udder	Good
BWt	71
Curr Wt	1220
Hip Ht	52
Sire Tndr	9

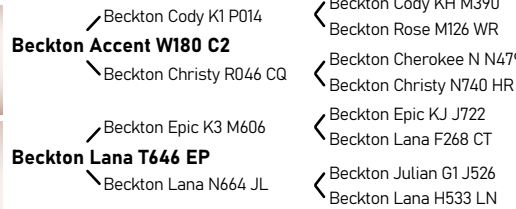

CE	BW	WW	YW	Milk	HPG	Stay	ME	Marb	REA	Bfat	HB	GM
13	-2.6	61	91	26	9	18	1.0	+0.30	+0.14	+0.04	57	9

Every heifer this Accent W180 daughter ever had is in production for us, there's a reason we held onto them, you'll want to too!

20-A Beckton Serena A761 A

1-A 100% # 1626512 Tattoo: BKT3 A761

Birth: 4-12-13

OWN PROG AVG	
BWt	68
WW R	102
YW R	102

OWN DATA	
Est Cvg	April
Feet	Good
Docility	Good
Udder	Good
BWt	49
Curr Wt	1170
Hip Ht	52
Sire Tndr	9

Beckton Accent W180 C2

- Beckton Cody K1 P014
- Beckton Christy R046 CQ
- Beckton Warrior T248 L5
- Beckton Serena X287 W
- Beckton Serena N088 WR

- Beckton Cody KH M390
- Beckton Rose M126 WR
- Beckton Cherokee N N479
- Beckton Christy N740 HR
- Beckton Warrior N645 T1
- Beckton Kit R503 LN
- Beckton Warrior TD L493
- Beckton Serena L591 VG

CE	BW	WW	YW	Milk	HPG	Stay	ME	Marb	REA	Bfat	HB	GM
19	-4.4	56	92	24	14	18	-5.0	+3.8	-11	+0.4	87	22

The Accent W180 and Accent U777 half brothers keep showing up again and again. Here's a nice W180 daughter out of an exceptionally efficient dam.

21-B Beckton Tara A278 N

1-A 100% # 1626374 Tattoo: BKT3 A278

Birth: 3-22-13

OWN PROG AVG	
BWt	66
WW R	99
YW R	104

OWN DATA	
Est Cvg	April
Feet	Good
Docility	Good
Udder	Good
BWt	61
Curr Wt	1225
Hip Ht	52
Sire Tndr	8

Beckton Nebula W486 D3

- Beckton Nebula L P093
- Beckton Belga R716 DM
- Beckton Nebula T054 H3
- Beckton Tara W011 N
- Beckton Tara T227 JC

- Beckton Nebula M045
- Beckton Marta M021 LN
- Beckton Dominor ZC M919
- Beckton Belga K285 JL
- Beckton Nebula J R475
- BKT Pine Marie R401 HU
- Beckton Justice C1 R483
- Beckton Tara R609 JC

CE	BW	WW	YW	Milk	HPG	Stay	ME	Marb	REA	Bfat	HB	GM
17	-3.6	54	89	30	13	19	3.0	+4.3	+1.3	+0.4	64	41

Not only does A278 have the great Nebula name on both sides of her pedigree, she puts it to good use by never having missed a calving opportunity. Good mom!

20-B Beckton Coca A517 A

1-A 100% # 1626287 Tattoo: BKT3 A517

Birth: 3-30-13

OWN PROG AVG	
BWt	66
WW R	102
YW R	100

OWN DATA	
Est Cvg	April
Feet	Good
Docility	Good
Udder	Good
BWt	61
Curr Wt	1230
Hip Ht	52
Sire Tndr	9

Beckton Accent W180 C2

- Beckton Cody K1 P014
- Beckton Christy R046 CQ
- Beckton Nexus L016
- Beckton Coca T454 NX
- Beckton Coca P597 CD

- Beckton Cody KH M390
- Beckton Rose M126 WR
- Beckton Cherokee N N479
- Beckton Christy N740 HR
- Beckton Neptune R1 J245
- Beckton Coca J276 CL
- Beckton Cody V E023
- Beckton Coca G112 NM

CE	BW	WW	YW	Milk	HPG	Stay	ME	Marb	REA	Bfat	HB	GM
17	-3.8	62	96	27	15	20	-2.0	+3.7	+0.4	+0.3	89	18

Here's another moderate framed, good udder, sound and feminine Accent W180 daughter from the Coca cow family. Every daughter she's had is in production for us.

22-A Beckton Rose Z078 J

1-A 100% # 1545269 Tattoo: BKT2 Z078

Birth: 2-21-12

OWN PROG AVG	
BWt	78
WW R	108
YW R	103

OWN DATA	
Est Cvg	March
Feet	Good
Docility	Good
Udder	Good
BWt	59
Curr Wt	1220
Hip Ht	54
Sire Tndr	8

Beckton Janus X799 L2

- Beckton Roman J S158
- Beckton Sierra K557 LO
- Beckton Nebula T054 H3
- Beckton Rose X573 N
- Beckton Rose T142 HI

- TR Romeo NT379
- Beckton Belga K285 JL
- Beckton Loki F251
- Beckton Sierra C157 CL
- Beckton Nebula J R475
- BKT Pine Marie R401 HU
- Beckton Hilltop R157
- Beckton Rose R579 JJ

CE	BW	WW	YW	Milk	HPG	Stay	ME	Marb	REA	Bfat	HB	GM
15	-1.0	55	93	26	8	14	-1.0	+3.4	-0.8	+0.4	29	26

Rose Z078 has a powerful progeny record and has calved 9 years out of 10 in the first couple of weeks of the calving season.

21-A Beckton Lana A083 A

1-A 100% # 1626085 Tattoo: BSF3 A083

Birth: 3-13-13

OWN PROG AVG	
BWt	70
WW R	103
YW R	97

OWN DATA	
Est Cvg	April
Feet	Good
Docility	Good
Udder	Good
BWt	65
Curr Wt	1110
Hip Ht	50
Sire Tndr	10

Beckton Accent Y260 L3

- Beckton Accent W180 C2
- Beckton Lana W463 L
- Beckton Nebula W022 D3
- Beckton Lana Y130 N
- Beckton Lana W525 D

- Beckton Cody K1 P014
- Beckton Christy R046 CQ
- Beckton Loki CL S284
- Beckton Lana R327 EP
- Beckton Nebula T269 E2
- Beckton Eola T070 DM
- Beckton Dominor Z1 R610
- Beckton Lana S520 JO

CE	BW	WW	YW	Milk	HPG	Stay	ME	Marb	REA	Bfat	HB	GM
14	-3.4	53	82	29	13	22	-4.0	+4.8	-1.5	+0.5	95	31

A083 is another strong producer from our great historical Lana cow family.



Lot 22-A

22-B

Beckton Barmaid Z227 C

1-A 100% # 1545070 Tattoo: BSF2 Z227

Birth: 3-12-12

OWN PROG AVG	
BWt	74
WW R	108
YW R	104

OWN DATA	
Est Cvg	March
Feet	Good
Dolcility	Good
Udder	Good
BWt	73
Curr Wt	1100
Hip Ht	50
Sire Tndr	9



CE	BW	WW	YW	Milk	HPG	Stay	ME	Marb	REA	Bfat	HB	GM
12	-1.7	48	78	33	12	19	-3.0	+3.4	-2.1	+0.5	66	19

Z227 is a great Clifftop daughter with powerful progeny performance and a nice udder who's never missed a calving opportunity.

24-A

Beckton Belga Z031 N

1-A 100% # 1544529 Tattoo: BSF2 Z031

Birth: 2-15-12

OWN PROG AVG	
BWt	64
WW R	102
YW R	99

OWN DATA	
Est Cvg	April
Feet	Good
Dolcility	Good
Udder	Good
BWt	60
Curr Wt	1080
Hip Ht	51
Sire Tndr	7



CE	BW	WW	YW	Milk	HPG	Stay	ME	Marb	REA	Bfat	HB	GM
18	-5.7	51	77	29	11	17	-2.0	+4.5	-1.8	+0.2	71	24

She never misses. Her sire is double-bred to one of the greatest sires in the RAAA breed - Beckton Nebula P707.

23-A

Beckton Coca Z639 D

1-A 100% # 1544668 Tattoo: BKT2 Z639

Birth: 3-31-12

OWN PROG AVG	
BWt	68
WW R	103
YW R	106

OWN DATA	
Est Cvg	April
Feet	Good
Dolcility	Good
Udder	Good
BWt	60
Curr Wt	1130
Hip Ht	53
Sire Tndr	9



CE	BW	WW	YW	Milk	HPG	Stay	ME	Marb	REA	Bfat	HB	GM
22	-7.1	47	81	23	13	14	-7.0	+4.7	-2.2	+0.5	61	43

Here's a Dominor daughter who's bull calves in our spring sale averaged over \$9,000 - and she's never missed a calving opportunity.

24-B

Beckton Christy Z125 J

1-A 100% # 1545010 Tattoo: BKT2 Z125

Birth: 2-28-12

OWN PROG AVG	
BWt	69
WW R	109
YW R	107

OWN DATA	
Est Cvg	May
Feet	Good
Dolcility	Good
Udder	Good
BWt	53
Curr Wt	1040
Hip Ht	51
Sire Tndr	8

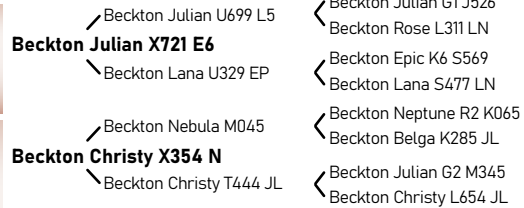

CE	BW	WW	YW	Milk	HPG	Stay	ME	Marb	REA	Bfat	HB	GM
16	-4.3	59	96	32	15	20	-2.0	+1.7	-1.4	+0.5	90	9

Christy Z125 has produced calves weaning 125%, 112%, 112%, 111%, 109% and others above herd average. RAAA Herd Builder Index in the top 6% of the breed.

23-B

Beckton Sierra Z059 N

1-A 100% # 1545295 Tattoo: BKT2 Z059

Birth: 2-19-12

OWN PROG AVG	
BWt	83
WW R	103
YW R	109

OWN DATA	
Est Cvg	March
Feet	Good
Dolcility	Good
Udder	NA
BWt	68
Curr Wt	1390
Hip Ht	53
Sire Tndr	7

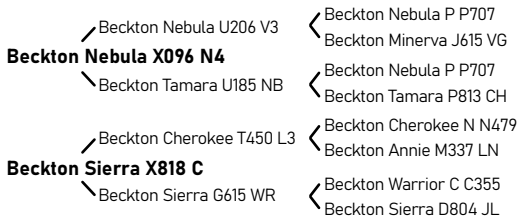

CE	BW	WW	YW	Milk	HPG	Stay	ME	Marb	REA	Bfat	HB	GM
9	2.8	74	125	22	13	17	14.0	+3.8	-0.8	+0.2	41	38

A half sister to Lot 24-A double-bred Nebula P707 on the sire side, Sierra Z059 produced calves weaning 120%, 117%, 114%, 112%, and others above herd average.

25-A

Beckton Christy Z587 C

1-A 100% # 1544648 Tattoo: BKT2 Z587

Birth: 3-29-12

OWN PROG AVG	
BWt	68
WW R	104
YW R	104

OWN DATA	
Est Cvg	April
Feet	Good
Dolcility	Good
Udder	Good
BWt	67
Curr Wt	1290
Hip Ht	52
Sire Tndr	9

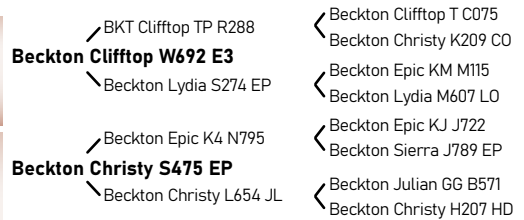

CE	BW	WW	YW	Milk	HPG	Stay	ME	Marb	REA	Bfat	HB	GM
14	-3.6	53	91	30	6	8	-4.0	+3.0	-1.5	+0.5	-8	26

Another Christy, Z587 has produced four bull calves that were sold for above sale average.

25-B Beckton Minola Z459 E

1-A 100% # 1544826 Tattoo: BKT2 Z459

Birth: 3-24-12

OWN PROG AVG	
BWt	64
WW R	103
YW R	102

OWN DATA	
Est Cvg	March
Feet	Good
Docility	Good
Udder	Good
BWt	49
Curr Wt	1065
Hip Ht	52
Sire Tndr	9

Beckton Epic K4 N795
Beckton Emcee S466
Beckton Larkaba H798 WR
Beckton Epic KJ J722
Beckton Sierra J789 EP
Beckton Warrior T C371
Beckton Larkaba E042 CD
Beckton Nebula L P093
Beckton Minerva J615 VG
Beckton Julian GG B571
Beckton Minola P391 LN

CE	BW	WW	YW	Milk	HPG	Stay	ME	Marb	REA	Bfat	HB	GM
19	-6.9	43	67	36	6	16	-6.0	+27	-08	+02	51	17

This young Minola girl has calving ease and low maintenance energy EPD's near the very top of the breed.



Lot 25-B

26-A Beckton Indigo Y041 A

1-A 100% # 1451077 Tattoo: BSF1 Y041

Birth: 3-1-11

OWN PROG AVG	
BWt	68
WW R	104
YW R	107

OWN DATA	
Est Cvg	March
Feet	Good
Docility	Good
Udder	Good
BWt	57
Curr Wt	1150
Hip Ht	50
Sire Tndr	9

Beckton Cody K1 P014
Beckton Accent W180 C2
Beckton Christy R046 CQ
Beckton Indigo W419 J
Beckton Indigo N754 HR
Beckton Cody KH M390
Beckton Rose M126 WR
Beckton Cherokee N N479
Beckton Christy N740 HR
Beckton Julian G1 J526
Beckton Barona J591 EP
Beckton Herald F1 L151
Beckton Indigo LC22 LO

CE	BW	WW	YW	Milk	HPG	Stay	ME	Marb	REA	Bfat	HB	GM
15	-3.1	57	93	25	14	16	0.0	+46	-11	+04	59	40

Here's a great Accent W180 daughter who's never missed a calving opportunity and has a very impressive Progeny Performance record. This is a solid dam!

27-A Beckton Minerva Y324 N

1-A 100% # 1451359 Tattoo: BKT1 Y324

Birth: 3-26-11

OWN PROG AVG	
BWt	63
WW R	107
YW R	105

OWN DATA	
Est Cvg	April
Feet	Good
Docility	Good
Udder	Good
BWt	53
Curr Wt	1055
Hip Ht	54
Sire Tndr	8

Beckton Nebula L P093
Beckton Minerva T398 V3
Beckton Minerva J615 VG
Beckton Nebula M045
Beckton Marta M021 LN
Beckton Vegas PK F485
Beckton Minerva F433 VG
Beckton Colt G552
Beckton Angel H164 LO
Beckton Minerva T864 CK
Beckton Minerva M179 LN
Beckton Lancer T3 J396
Beckton Minerva E932 JL

CE	BW	WW	YW	Milk	HPG	Stay	ME	Marb	REA	Bfat	HB	GM
20	-6.3	49	78	35	14	22	-3.0	+29	-22	+03	107	19

A Nebula dam who starts them off easy with an average birth weight of 63 and raises them up great with a average progeny weaning ratio of 107!

26-B Beckton Lana Y024 N

1-A 100% # 1451489 Tattoo: BKT1 Y024

Birth: 2-23-11

OWN PROG AVG	
BWt	60
WW R	106
YW R	103

OWN DATA	
Est Cvg	March
Feet	Good
Docility	Good
Udder	Good
BWt	56
Curr Wt	1050
Hip Ht	51
Sire Tndr	10

Beckton Nebula T269 E2
Beckton Nebula W065 C3
Beckton Lana T104 CT
Beckton Lana W277 A
Beckton Lana N869 LO
Beckton Cody K1 P014
Beckton Nebula M045
Beckton Ruth M967 EP
BKT Clifftop TP R288
Beckton Lana R128 LS
Beckton Cody KH M390
Beckton Rose M126 WR
Beckton Loki F251
Beckton Lana D232 HV

CE	BW	WW	YW	Milk	HPG	Stay	ME	Marb	REA	Bfat	HB	GM
20	-6.5	37	57	37	10	14	-8.0	+24	-20	+03	52	1

Lana Y024 has calved every year like a clock almost always in March and has a very impressive Progeny Performance record.

27-B Beckton Coca Y399 L

1-A 100% # 1451569 Tattoo: BSF1 Y399

Birth: 3-31-11

OWN PROG AVG	
BWt	66
WW R	104
YW R	102

OWN DATA	
Est Cvg	April
Feet	Good
Docility	Good
Udder	Good
BWt	63
Curr Wt	970
Hip Ht	49
Sire Tndr	10

Beckton Likable S633
Beckton Likable U120 L2
Beckton Lana S718 LN
Beckton Champ RH F275
Beckton Coca H051 CH
Beckton Coca F048 LN
Beckton Lancer F442 T
Beckton Kit F468 JL
Beckton Lancer F442 T
Beckton Lana F891 JL
Beckton Champ R A583
Beckton Minola B156 HV
Beckton Lancer TS D390
Beckton Coca D042 DM

CE	BW	WW	YW	Milk	HPG	Stay	ME	Marb	REA	Bfat	HB	GM
17	-3.4	42	63	31	7	21	-14.0	+35	+04	+00	84	23

Another queen of efficiency -- a very modestly sized cow that produces above herd average for both weaning and yearling weight of her calves.

28-A Beckton Larkaba Y454 A

1-A 100% # 1451408 Tattoo: BKT1 Y454

Birth: 4-4-11

OWN PROG AVG	
BWt	73
WW R	102
YW R	106

OWN DATA

Est Cvg	April
Feet	Good
Dolcility	Good
Udder	Good
BWt	60
Curr Wt	1080
Hip Ht	52
Sire Tndr	9

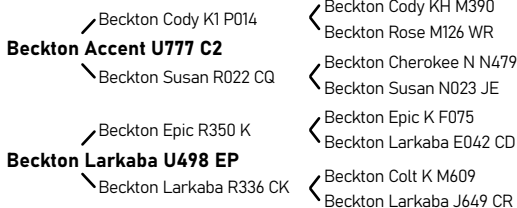

CE	BW	WW	YW	Milk	HPG	Stay	ME	Marb	REA	Bfat	HB	GM
12	-1.4	63	106	32	12	18	-2.0	+3.4	-0.9	+0.3	72	31

An own daughter of Accent U777. Easy calving meets growth in this Accent daughter, her progeny averages prove that, just take a look!

29-B Beckton Encino X785 N

1-A 100% # 1383006 Tattoo: BSF0 X785

Birth: 4-26-10

OWN PROG AVG	
BWt	72
WW R	101
YW R	105

OWN DATA

Est Cvg	March
Feet	Good
Dolcility	Good
Udder	Good
BWt	72
Curr Wt	1300
Hip Ht	51
Sire Tndr	8

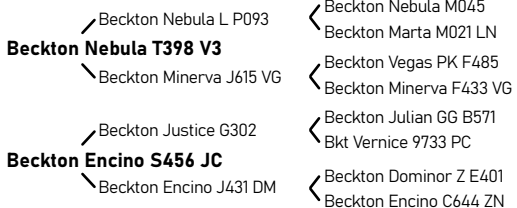

CE	BW	WW	YW	Milk	HPG	Stay	ME	Marb	REA	Bfat	HB	GM
13	-1.8	55	87	24	14	21	-4.0	+4.0	-2.2	+0.4	86	31

Encino X785 has calved in early to mid March the last 5 years running, and she looks to be that early for next year. RAAA Herd Builder Index in the top 7% of the breed.

28-B Beckton Lakme Y027 A

1-A 100% # 1451487 Tattoo: BKT1 Y027

Birth: 2-24-11

OWN PROG AVG	
BWt	61
WW R	97
YW R	98

OWN DATA

Est Cvg	March
Feet	Good
Dolcility	Good
Udder	Good
BWt	49
Curr Wt	1130
Hip Ht	51
Sire Tndr	9

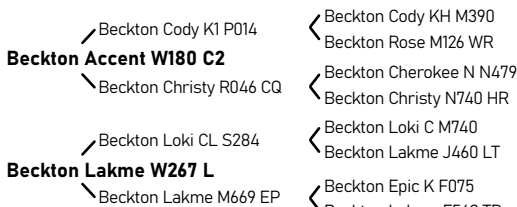

CE	BW	WW	YW	Milk	HPG	Stay	ME	Marb	REA	Bfat	HB	GM
21	-6.8	51	77	22	14	16	-4.0	+3.8	-0.2	+0.4	72	31

An own daughter of Accent W180. Accent W180 and Accent U777 are half brothers and have a disproportionate number of daughters among these Prime and Proven females.

30-A BSF Lanette X808 N

1-B 99% # 1383434 Tattoo: BKB0 X808

Birth: 5-2-10

OWN PROG AVG	
BWt	60
WW R	113
YW R	105

OWN DATA

Est Cvg	March
Feet	Good
Dolcility	Good
Udder	Good
BWt	51
Curr Wt	1020
Hip Ht	48
Sire Tndr	8

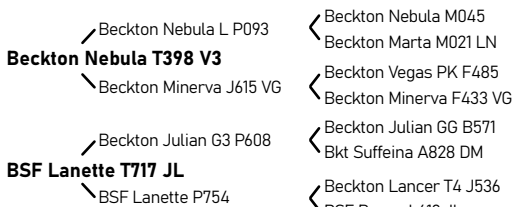

CE	BW	WW	YW	Milk	HPG	Stay	ME	Marb	REA	Bfat	HB	GM
20	-6.9	46	67	32	16	24	-15.0	+4.0	-2.5	+0.3	129	15

Every calf in March or the first four days of April, and she's due in March again. RAAA Herd Builder Index in the top 1% of the breed.

29-A BKT Pine Marie X339 N

1-A 100% # 1383148 Tattoo: BKT0 X339

Birth: 3-21-10

OWN PROG AVG	
BWt	72
WW R	108
YW R	108

OWN DATA

Est Cvg	April
Feet	Good
Dolcility	Good
Udder	Good
BWt	54
Curr Wt	1130
Hip Ht	50
Sire Tndr	10

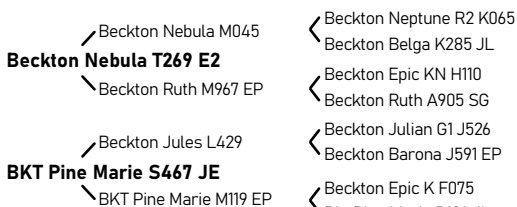

CE	BW	WW	YW	Milk	HPG	Stay	ME	Marb	REA	Bfat	HB	GM
11	-3.3	48	81	37	13	16	2.0	+3.0	-1.7	+0.5	52	19

Pine Marie has had calves weaning at 123%, 121%, 116%, 115%, 113%, 108%, 106%, 106%, 105% above herd average !!

30-B Beckton Angel X450 N

1-A 100% # 1383033 Tattoo: BSF0 X450

Birth: 3-26-10

OWN PROG AVG	
BWt	67
WW R	103
YW R	101

OWN DATA

Est Cvg	March
Feet	Good
Dolcility	Good
Udder	Good
BWt	54
Curr Wt	1160
Hip Ht	51
Sire Tndr	8

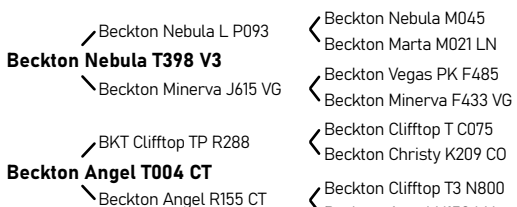

CE	BW	WW	YW	Milk	HPG	Stay	ME	Marb	REA	Bfat	HB	GM
19	-6.6	42	64	30	10	23	-6.0	+3.3	-3.7	+0.5	100	11

Seven times Angel has calved in the first week of the calving season, and she's due again in March. RAAA Herd Builder Index in the top 2% of the breed. And she looks like she has many years left.

31-A BSF Julianne X510 L

1-B 99% # 1382962 Tattoo: BSF0 X510

Birth: 3-29-10

OWN PROG AVG	
BWt	70
WW R	105
YW R	104

OWN DATA

Est Cvg	March
Feet	Good
Docity	Good
Udder	Good
BWt	64
Curr Wt	1090
Hip Ht	52
Sire Tndr	7

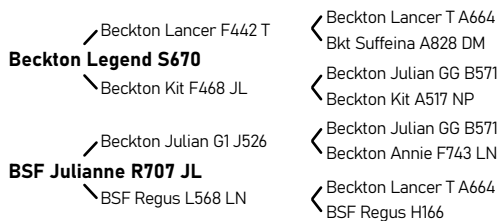

CE	BW	WW	YW	Milk	HPG	Stay	ME	Marb	REA	Bfat	HB	GM
18	-5.0	52	76	28	15	19	-4.0	+4.8	+1.8	+0.3	87	25

X 510 has great progeny performance averages, and an RAAA Herd Builder Index in the top 8% of the breed.

32-A Beckton Encino X642 W

1-A 100% # 1382979 Tattoo: BSF0 X642

Birth: 4-8-10

OWN PROG AVG	
BWt	61
WW R	97
YW R	97

OWN DATA

Est Cvg	March
Feet	Good
Docity	Good
Udder	Good
BWt	62
Curr Wt	1095
Hip Ht	52
Sire Tndr	10

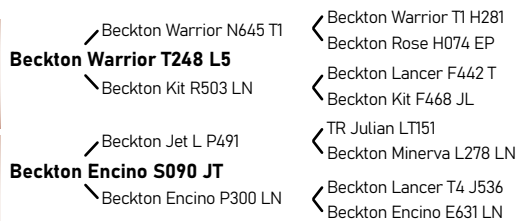

CE	BW	WW	YW	Milk	HPG	Stay	ME	Marb	REA	Bfat	HB	GM
20	-7.7	39	58	23	14	16	-10.0	+4.5	-0.5	+0.3	82	28

X642 has never missed a calf, her dam has never missed a calf, and her maternal granddam has never missed a calf.

31-B Beckton Coca X675 N

1-A 100% # 1383235 Tattoo: BKT0 X675

Birth: 4-12-10

OWN PROG AVG	
BWt	59
WW R	99
YW R	99

OWN DATA

Est Cvg	March
Feet	Good
Docity	Good
Udder	NA
BWt	58
Curr Wt	1250
Hip Ht	53
Sire Tndr	7

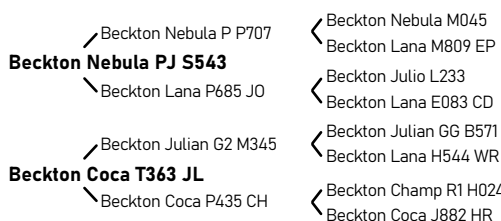

CE	BW	WW	YW	Milk	HPG	Stay	ME	Marb	REA	Bfat	HB	GM
18	-6.8	48	77	24	15	15	-7.0	+4.4	-2.2	+0.3	62	21

Coca and her dam have combined for 24 years of production, and average of 12 years apiece, and she's due in March.

32-B BSF Helena X529 N

1-B 99% # 1383036 Tattoo: BSF0 X529

Birth: 3-30-10

OWN PROG AVG	
BWt	72
WW R	97
YW R	99

OWN DATA

Est Cvg	April
Feet	Good
Docity	Good
Udder	NA
BWt	58
Curr Wt	1350
Hip Ht	52
Sire Tndr	8

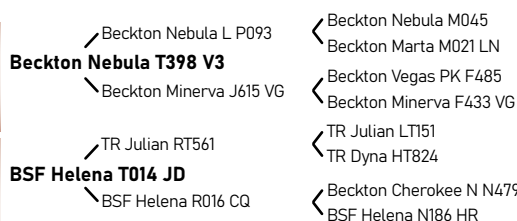

CE	BW	WW	YW	Milk	HPG	Stay	ME	Marb	REA	Bfat	HB	GM
16	-3.7	51	83	19	11	22	-4.0	+2.7	-2.2	+0.3	96	29

This Nebula daughter's last bull calf sold in the five digits and for good reason. Raaa Herd Builder Index in the top 3% of the breed.



Lot 30-B

33-A Beckton Tamara W550 A

1-A 100% # 1332164 Tattoo: BKT9 W550

Birth: 3-31-09

OWN PROG AVG	
BWt	72
WW R	111
YW R	108

OWN DATA

Est Cvg	March
Feet	Good
Docity	Good
Udder	NA
BWt	69
Curr Wt	1220
Hip Ht	51
Sire Tndr	9



CE	BW	WW	YW	Milk	HPG	Stay	ME	Marb	REA	Bfat	HB	GM
17	-4.3	53	84	32	13	19	-4.0	+3.3	-2.3	+0.6	77	14

Don't pass by an opportunity like this, MPPA of 110! Every calf well into the top half of the herd. Five of her calves were 114 to 123% above herd average.

33-B BSF Joanie W756 J

1-B 99% # 1331652 Tattoo: BSF9 W756

Birth: 4-18-09

OWN PROG AVG	
BWt	72
WW R	107
YW R	105

OWN DATA	
Est Cvg	March
Feet	Good
Docility	Good
Udder	Good
BWt	73

Curr Wt	1280
Hip Ht	52
Sire Tndr	7

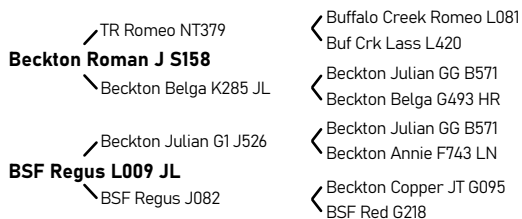

CE	BW	WW	YW	Milk	HPG	Stay	ME	Marb	REA	Bfat	HB	GM
13	-1.6	61	88	35	10	17	-2.0	+30	-0.2	+0.2	56	-2

Incredible production. She has had five calves that were 10% or higher above herd average. She calved on March 16 and she's due again in March.

34-B BSF Warrita W536 C

1-B 99% # 1331866 Tattoo: BSF9 W536

Birth: 3-31-09

OWN PROG AVG	
BWt	66
WW R	104
YW R	99

OWN DATA	
Est Cvg	March
Feet	Good
Docility	Good
Udder	NA
BWt	64

Curr Wt	1170
Hip Ht	51
Sire Tndr	9

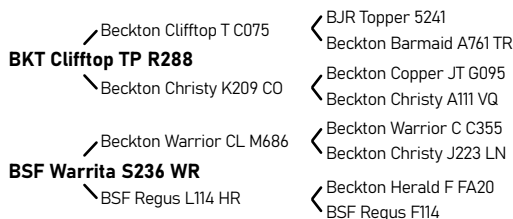

CE	BW	WW	YW	Milk	HPG	Stay	ME	Marb	REA	Bfat	HB	GM
17	-5.0	43	61	35	13	15	-9.0	+22	-0.7	+0.3	59	4

Fourteen years of production and she has had two bulls calves that weaned at 20% above herd average.

34-A Beckton Lana W748 D

1-A 100% # 1332310 Tattoo: BKT9 W748

Birth: 4-18-09

OWN PROG AVG	
BWt	58
WW R	101
YW R	100

OWN DATA	
Est Cvg	March
Feet	Good
Docility	Good
Udder	Good
BWt	53

Curr Wt	1170
Hip Ht	52
Sire Tndr	5



CE	BW	WW	YW	Milk	HPG	Stay	ME	Marb	REA	Bfat	HB	GM
22	-8.1	45	71	29	14	17	-14.0	+38	-1.6	+0.5	91	22

Another fabulous Lana line cow that has been a top line since the beginnings of our herd. Look at her and you won't believe she is fourteen. Top 4% on RAAA HerdBuilder Index.

35-A Beckton Lana W518 N

1-A 100% # 1331734 Tattoo: BSF9 W518

Birth: 3-29-09

OWN PROG AVG	
BWt	65
WW R	111
YW R	108

OWN DATA	
Est Cvg	April
Feet	Good
Docility	Good
Udder	Good
BWt	67

Curr Wt	1140
Hip Ht	52
Sire Tndr	8

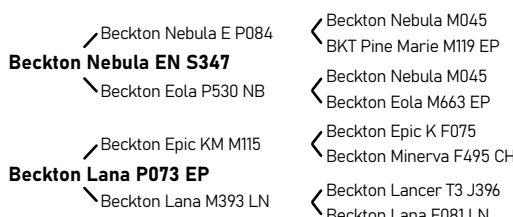

CE	BW	WW	YW	Milk	HPG	Stay	ME	Marb	REA	Bfat	HB	GM
18	-6.8	53	84	47	14	17	0.0	+43	-3.2	+0.5	85	26

Phenomenal !! Fourteen years of production and an average weaning ratio on her calves of 111 and birth weights under the herd average. From the great Lana cow line.



Lot 34-A

35-B BSF Laurel U202 CQ

1-B 99% # 1259234 Tattoo: BSF8 U202

Birth: 3-12-08

OWN PROG AVG	
BWt	68
WW R	95
YW R	98

OWN DATA	
Est Cvg	March
Feet	Good
Docility	Good
Udder	Good
BWt	67

Curr Wt	1000
Hip Ht	50
Sire Tndr	7

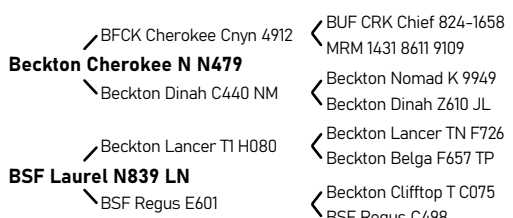

CE	BW	WW	YW	Milk	HPG	Stay	ME	Marb	REA	Bfat	HB	GM
17	-3.9	46	74	23	13	18	-9.0	+31	-1.0	+0.3	77	24

This great cow goes on forever. Almost every calf has been born in March or very early April, and she's due in March again.

High Performance Herd Sires



The next lots are high performance herd sires from our own herd bull battery. We breed almost entirely natural service, turn over our herd sires quickly, and replace them long before they need to be. Most of these bulls are just 3, 4 and 5 years old and have many years of breeding left. These are great for your older cows. These bulls were picked for our own replacement heifers and cowherd, and have performance data and genetic potential right at the top of our herd.

51

Beckton Scamp H076 E6

1-A 100% # 4377489 Tattoo: BKT0 H076

Birth: 2-27-20

OWN DATA	
BWt	72
WR	124
YWt.	1192
YR	118
ADG	4.16

DAM DATA

Age	2
Wt	860
Proj. BW	67
WR	108
YR	105
Udder	Good
Wean Pct.	64
Cow Eff.	135

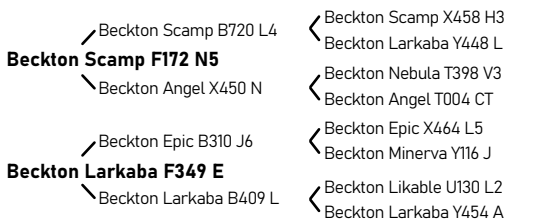

CE	BW	WW	YW	Milk	HPG	Stay	ME	Marb	REA	Bfat	HB	GM
18	-2.6	68	106	30	12	14	7.0	+0.27	+0.07	+0.02	53	22

★★★★★ for Marbling, Cow Efficiency, Calving Ease.

54

Beckton Likable H662 L4

1-A 100% # 4376813 Tattoo: BKT0 H662

Birth: 4-17-20

OWN DATA	
BWt	69
WR	114
YWt.	1092
YR	110
ADG	3.73

DAM DATA

Age	3
Wt	1050
Proj. BW	69
WR	114
YR	110
Udder	Good
Wean Pct.	50
Cow Eff.	105

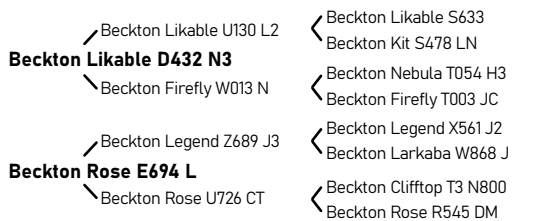

CE	BW	WW	YW	Milk	HPG	Stay	ME	Marb	REA	Bfat	HB	GM
16	-1.9	56	93	26	11	15	-8.0	+0.45	+0.23	+0.03	62	48

★★★★★ for Low Maintenance, Marbling, Rib-eye area, Calving Ease.

52

Beckton Scamp H215 L6

1-A 100% # 4377327 Tattoo: BKT0 H215

Birth: 3-17-20

OWN DATA	
BWt	70
WR	118
YWt.	1133
YR	111
ADG	3.54

DAM DATA

Age	8
Wt	1040
Proj. BW	71
WR	107
YR	106
Udder	Good
Wean Pct.	60
Cow Eff.	127

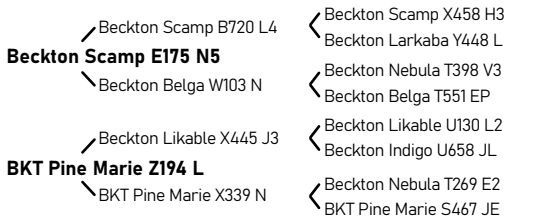

CE	BW	WW	YW	Milk	HPG	Stay	ME	Marb	REA	Bfat	HB	GM
14	-3.7	52	85	31	10	15	6.0	+0.43	-0.10	+0.04	37	27

★★★★★ for Marbling, Cow Efficiency, Calving Ease.

55

Beckton Oracle H725 S2

1-A 100% # 4376739 Tattoo: BKT0 H725

Birth: 4-28-20

OWN DATA	
BWt	56
WR	104
YWt.	1087
YR	110
ADG	4.08

DAM DATA

Age	3
Wt	830
Proj. BW	58
WR	103
YR	107
Udder	Good
Wean Pct.	58
Cow Eff.	121

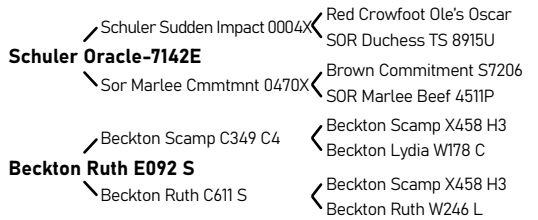

CE	BW	WW	YW	Milk	HPG	Stay	ME	Marb	REA	Bfat	HB	GM
17	-4.1	52	92	26	10	14	0.0	+0.51	+0.12	+0.02	51	57

★★★★★ for Low Maintenance, Marbling, Cow Efficiency, Calving Ease.

53

Beckton Julian H453 A4

1-A 100% # 4377045 Tattoo: BKT0 H453

Birth: 3-30-20

OWN DATA	
BWt	84
WR	106
YWt.	1155
YR	113
ADG	4.16

DAM DATA

Age	6
Wt	1390
Proj. BW	72
WR	112
YR	114
Udder	Good
Wean Pct.	41
Cow Eff.	86

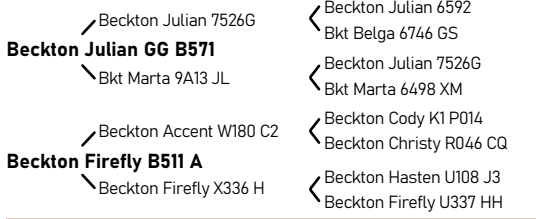

CE	BW	WW	YW	Milk	HPG	Stay	ME	Marb	REA	Bfat	HB	GM
16	-3.0	57	90	27	15	17	1.0	+0.40	+0.09	+0.04	64	27

★★★★★ for Marbling, Calving Ease.



Lot 55

56

Beckton Likable G401 J5

1-A 100% # 4170616 Tattoo: BKT9 G401

Birth: 3-26-19

OWN DATA	
BWt	62
WR	100
YWt.	1175
YR	113
ADG	4.46
DAM DATA	
Age	4
Wt	1030
Proj. BW	63
WR	102
YR	105
Udder	Good
Wean Pct.	51
Cow Eff.	107

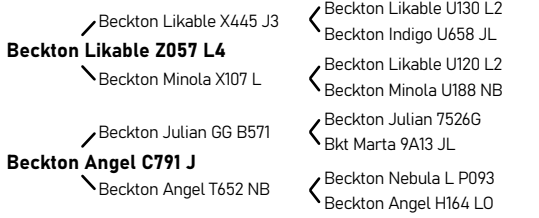

CE	BW	WW	YW	Milk	HPG	Stay	ME	Marb	REA	Bfat	HB	GM
17	-5.6	58	107	25	15	14	1.0	+0.47	+0.26	+0.03	40	69

★★★★★ for Marbling, Rib-eye area, Calving Ease.

58

Beckton Accent G635 E4

1-A 100% # 4170648 Tattoo: BKT9 G635

Birth: 4-11-19

OWN DATA	
BWt	78
WR	120
YWt.	1185
YR	121
ADG	4.08
DAM DATA	
Age	4
Wt	995
Proj. BW	71
WR	113
YR	109
Udder	Good
Wean Pct.	59
Cow Eff.	124

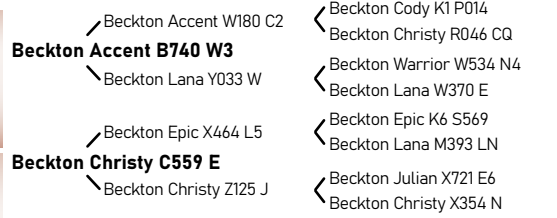

CE	BW	WW	YW	Milk	HPG	Stay	ME	Marb	REA	Bfat	HB	GM
16	-2.7	72	117	31	13	15	7.0	+0.33	+0.25	+0.04	56	30

★★★★★ for Marbling, Rib-eye area, Cow Efficiency, Calving Ease.



Lot 56

59

Beckton Likable F520 N5

1-A 100% # 3987476 Tattoo: BKT8 F520

Birth: 3-27-18

OWN DATA	
BWt	86
WR	118
YWt.	1241
YR	121
ADG	3.50
DAM DATA	
Age	5
Wt	1290
Proj. BW	72
WR	100
YR	114
Udder	NA
Wean Pct.	52
Cow Eff.	110



CE	BW	WW	YW	Milk	HPG	Stay	ME	Marb	REA	Bfat	HB	GM
3	0.8	80	137	21	14	14	7.0	+0.42	+0.20	+0.03	6	55

★★★★★ for Marbling, Rib-eye area.



Lot 59

57

Beckton Scamp G325 N6

1-A 100% # 4171516 Tattoo: BSF9 G325

Birth: 3-22-19

OWN DATA	
BWt	76
WR	104
YWt.	1119
YR	115
ADG	4.25
DAM DATA	
Age	4
Wt	1075
Proj. BW	72
WR	108
YR	112
Udder	NA
Wean Pct.	47
Cow Eff.	99

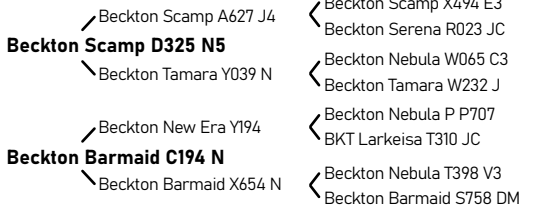

CE	BW	WW	YW	Milk	HPG	Stay	ME	Marb	REA	Bfat	HB	GM
16	-3.6	54	94	31	13	14	-7.0	+0.28	-0.04	+0.03	53	31

★★★★★ for Low Maintenance, Marbling, Calving Ease.

60

Beckton Likable F682 S5

1-A 100% # 3988358 Tattoo: BSF8 F682

Birth: 4-10-18

OWN DATA	
BWt	60
WR	114
YWt.	1104
YR	122
ADG	3.33

DAM DATA	
Age	3
Wt	850
Proj. BW	63
WR	102
YR	105
Udder	Good
Wean Pct.	60
Cow Eff.	126

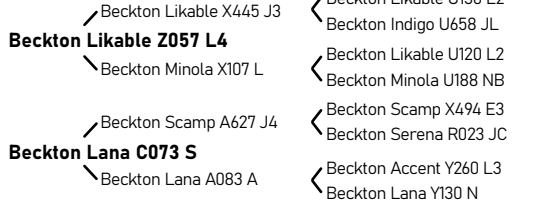

CE	BW	WW	YW	Milk	HPG	Stay	ME	Marb	REA	Bfat	HB	GM
18	-6.1	59	102	25	14	12	-4.0	+4.4	+1.0	+0.3	40	52

★★★★★ for Low Maintenance, Marbling, Cow Efficiency, Calving Ease.

62

Beckton Likable F242 D4

1-A 100% # 3987814 Tattoo: BKT8 F242

Birth: 3-14-18

OWN DATA	
BWt	52
WR	112
YWt.	1083
YR	106
ADG	2.94

DAM DATA	
Age	5
Wt	1200
Proj. BW	66
WR	98
YR	104
Udder	Good
Wean Pct.	53
Cow Eff.	112

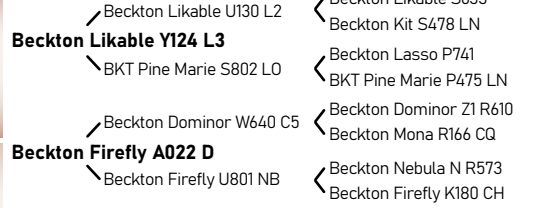

CE	BW	WW	YW	Milk	HPG	Stay	ME	Marb	REA	Bfat	HB	GM
23	-8.9	49	74	29	13	16	-5.0	+3.4	-0.6	+0.5	76	18

★★★★★ for Low Maintenance, Marbling, Calving Ease.

61

Beckton Heritage F615 L5

1-A 100% # 3988420 Tattoo: BSF8 F615

Birth: 4-4-18

OWN DATA	
BWt	76
WR	119
YWt.	1126
YR	114
ADG	3.50

DAM DATA	
Age	8
Wt	1105
Proj. BW	67
WR	103
YR	102
Udder	Good
Wean Pct.	58
Cow Eff.	121

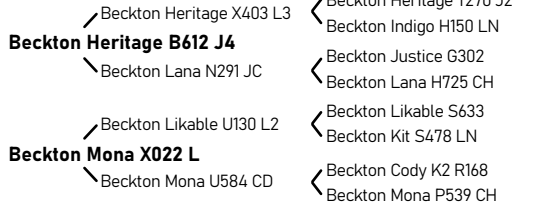

CE	BW	WW	YW	Milk	HPG	Stay	ME	Marb	REA	Bfat	HB	GM
11	-2.9	66	96	28	13	16	-6.0	+4.1	+0.7	+0.5	66	24

★★★★★ for Low Maintenance, Marbling, Cow Efficiency, Calving Ease.

63

Beckton Dominor F263 N8

1-A 100% # 3987796 Tattoo: BKT8 F263

Birth: 3-15-18

OWN DATA	
BWt	72
WR	119
YWt.	1060
YR	107
ADG	2.50

DAM DATA	
Age	9
Wt	980
Proj. BW	62
WR	105
YR	102
Udder	Good
Wean Pct.	65
Cow Eff.	137

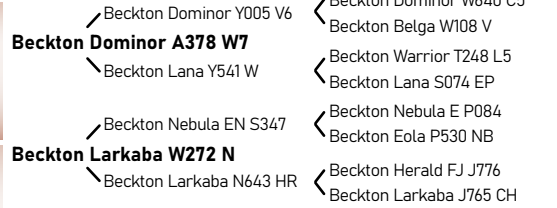

CE	BW	WW	YW	Milk	HPG	Stay	ME	Marb	REA	Bfat	HB	GM
18	-3.6	54	84	36	16	13	2.0	+4.8	+1.1	+0.5	54	34

★★★★★ for Marbling, Cow Efficiency, Calving Ease.



Lot 61



Lot 63

64

Beckton Roosevelt D367 A3

1-A 100% # 3987670 Tattoo: BKT8 F367

Birth: 3-20-18

OWN DATA	
BWt	68
WR	97
YWt.	990
YR	106
ADG	3.20

DAM DATA	
Age	2
Wt	875
Proj. BW	71
WR	108
YR	109
Udder	Good
Wean Pct.	NA
Cow Eff.	NA

<ul style="list-style-type: none"> Beckton Roosevelt D391 L2 Beckton Indigo Y406 L 	<ul style="list-style-type: none"> Bieber Roosevelt W384 Beckton Accent U777 C2 Beckton Annie D717 A Beckton Annie T016 JC 	<ul style="list-style-type: none"> Bieber Rough Rider 10712 Bieber Sheba 9602 Beckton Likable U130 L2 Beckton Indigo R745 WR Beckton Cody K1 P014 Beckton Susan R022 CQ Beckton Justice C2 R695 Beckton Annie R650 DM
--	--	---

CE	BW	WW	YW	Milk	HPG	Stay	ME	Marb	REA	Bfat	HB	GM
17	-3.3	54	90	29	13	18	0.0	+41	+09	+04	75	43

★★★★★ for Low Maintenance, Marbling, Calving Ease.



Not for sale

65

Beckton Nebula C067 N5

1-A 100% # 3487987 Tattoo: BKB5 C067

Birth: 2-24-15

OWN DATA	
BWt	61
WR	114
YWt.	1155
YR	112
ADG	3.56

DAM DATA	
Age	2
Wt	860
Proj. BW	66
WR	99
YR	105
Udder	NA
Wean Pct.	62
Cow Eff.	131

<ul style="list-style-type: none"> Beckton Nebula A773 L4 Beckton Mona X022 L 	<ul style="list-style-type: none"> Beckton Nebula T398 V3 Beckton Nebula P P707 Beckton Marta A319 N Beckton Marta X405 J 	<ul style="list-style-type: none"> Beckton Nebula L P093 Beckton Minerva J615 VG Beckton Likable U130 L2 Beckton Mona U584 CD Beckton Nebula M045 Beckton Lana M809 EP Beckton Julian G5 S107 Beckton Marta S441 RN
---	---	---

CE	BW	WW	YW	Milk	HPG	Stay	ME	Marb	REA	Bfat	HB	GM
16	-3.9	60	98	26	15	20	2.0	+35	-10	+05	91	30

★★★★★ for Marbling, Cow Efficiency, Calving Ease.

67

Beckton Accent E172 L3

1-A 100% # 3777901 Tattoo: BKB7 E172

Birth: 3-7-17

OWN DATA	
BWt	81
WR	112
YWt.	1208
YR	116
ADG	3.67

DAM DATA	
Age	6
Wt	1095
Proj. BW	63
WR	99
YR	105
Udder	Good
Wean Pct.	58
Cow Eff.	121

<ul style="list-style-type: none"> Beckton Accent W180 C2 Beckton Indigo Y406 L 	<ul style="list-style-type: none"> Beckton Cody K1 P014 Beckton Likable U130 L2 Beckton Indigo R745 WR 	<ul style="list-style-type: none"> Beckton Cody KH M390 Beckton Rose M126 WR Beckton Cherokee N N479 Beckton Christy N740 HR Beckton Likable S633 Beckton Kit S478 LN Beckton Warrior CL M686 Beckton Indigo M514 CH
---	---	--

CE	BW	WW	YW	Milk	HPG	Stay	ME	Marb	REA	Bfat	HB	GM
13	-2.5	62	98	30	14	19	-2.0	+32	+20	+02	82	24

★★★★★ for Low Maintenance, Marbling, Rib-eye area, Cow Efficiency, Calving Ease.

66

Beckton Scamp E175 N5

1-A 100% # 3776509 Tattoo: BKT7 E175

Birth: 3-7-17

OWN DATA	
BWt	78
WR	106
YWt.	1192
YR	114
ADG	4.06

DAM DATA	
Age	8
Wt	1015
Proj. BW	63
WR	98
YR	102
Udder	Good
Wean Pct.	55
Cow Eff.	116

<ul style="list-style-type: none"> Beckton Scamp B720 L4 Beckton Belga W103 N 	<ul style="list-style-type: none"> Beckton Scamp X458 H3 Beckton Nebula T398 V3 Beckton Belga T551 EP 	<ul style="list-style-type: none"> Beckton Scamp T A825 BKT Pine Marie R401 HU Beckton Likable U130 L2 Beckton Larkaba T655 NB Beckton Nebula L P093 Beckton Minerva J615 VG Beckton Epic K3 M606 Beckton Belga K285 JL
---	--	---

CE	BW	WW	YW	Milk	HPG	Stay	ME	Marb	REA	Bfat	HB	GM
19	-6.6	50	94	28	9	16	9.0	+42	+00	+03	42	55

★★★★★ for Marbling, Cow Efficiency, Calving Ease.



Lot 66

18-month Age-Ready Bulls

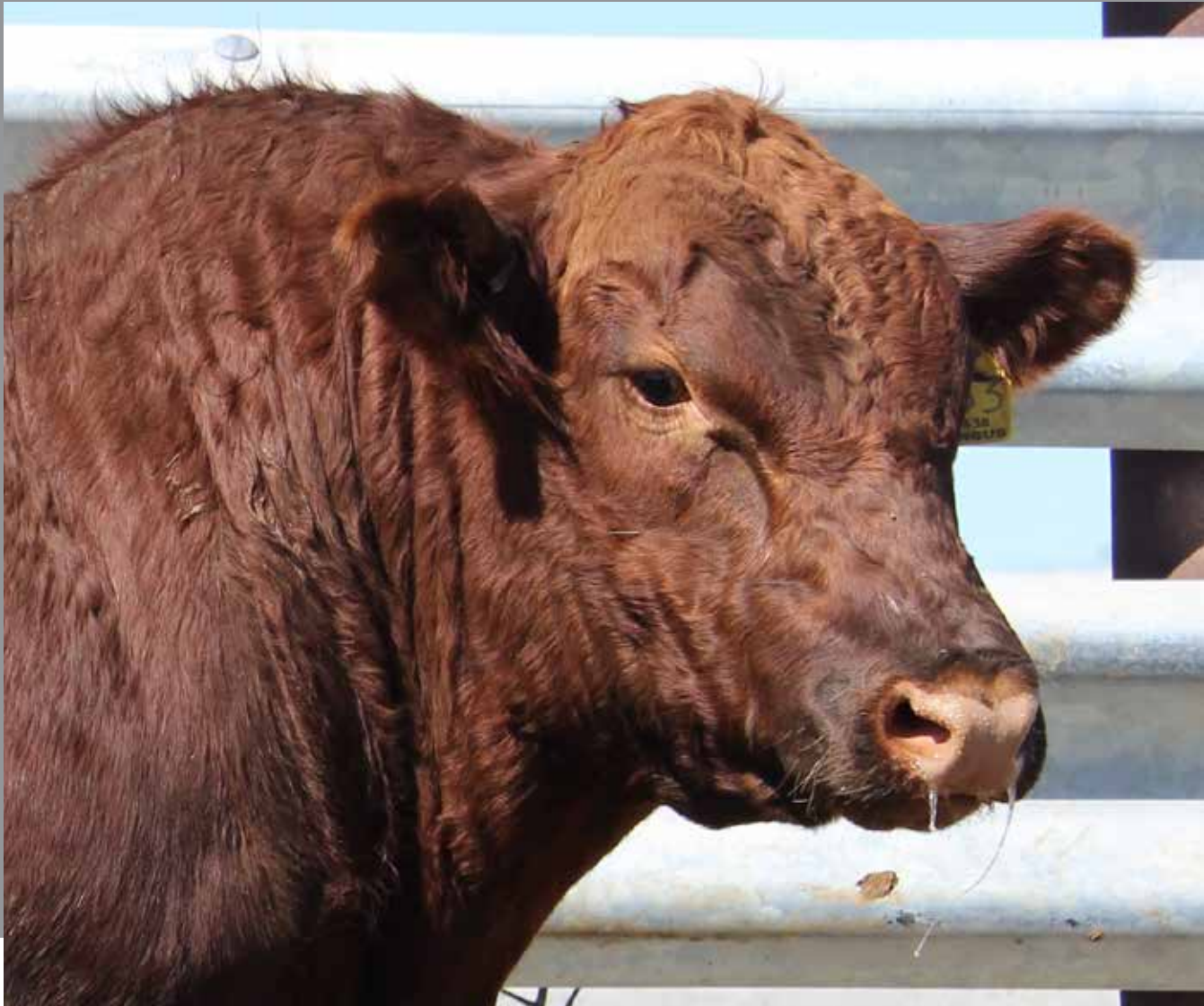

102 Beckton Accent K881 E4

1-A 100% # 4675863 Tattoo: BKT2 K881

Birth: 5-11-22

OWN DATA	
BWt	67
Scr.	34

DAM DATA	
Age	3
Wt	885
Proj. BW	67
WR	106
YR	103
Udder	NA
Wean Pct.	49
Cow Eff.	103



CE	BW	WW	YW	Milk	HPG	Stay	ME	Marb	REA	Bfat	HB	GM
13	-1.5	68	115	26	12	12	12.0	+52	+16	+05	16	44

★★★★★ for Marbling, Rib-eye area, Calving Ease.

106 Beckton Julian K422 E2

1-A 100% # 4675671 Tattoo: BKT2 K422

Birth: 3-28-22

OWN DATA	
BWt	56
Scr.	35

DAM DATA	
Age	4
Wt	1040
Proj. BW	51
WR	87
YR	97
Udder	Good
Wean Pct.	39
Cow Eff.	81



CE	BW	WW	YW	Milk	HPG	Stay	ME	Marb	REA	Bfat	HB	GM
21	-7.0	50	83	22	14	13	-7.0	+46	+09	+05	46	45

★★★★★ for Low Maintenance, Marbling, Calving Ease.

103 Beckton Julian K921 A8

1-A 100% # 4675393 Tattoo: BKT2 K921

Birth: 5-28-22

OWN DATA	
BWt	NA
Scr.	36

DAM DATA	
Age	6
Wt	945
Proj. BW	65
WR	101
YR	100
Udder	Good
Wean Pct.	46
Cow Eff.	97

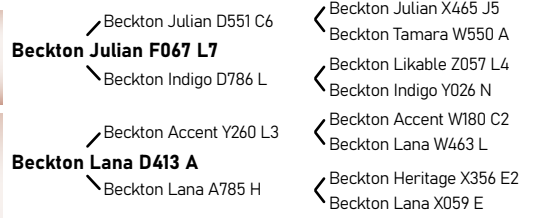

CE	BW	WW	YW	Milk	HPG	Stay	ME	Marb	REA	Bfat	HB	GM
19	-5.5	49	92	25	11	15	1.0	+54	-05	+04	42	64

★★★★★ for Marbling, Calving Ease.



Lot 106

104 Beckton Heritage K096 H6

1-A 100% # 4676025 Tattoo: BKT2 K096

Birth: 2-27-22

OWN DATA	
BWt	43
Scr.	35

DAM DATA	
Age	2
Wt	790
Proj. BW	54
WR	85
YR	95
Udder	NA
Wean Pct.	47
Cow Eff.	99

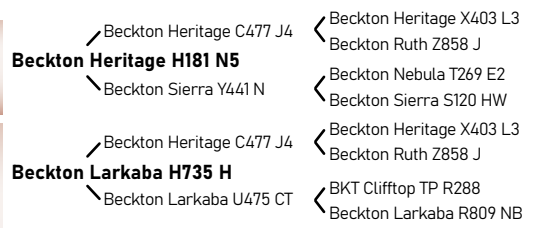

CE	BW	WW	YW	Milk	HPG	Stay	ME	Marb	REA	Bfat	HB	GM
18	-7.1	47	74	32	13	17	-5.0	+28	+01	+04	75	12

★★★★★ for Low Maintenance, Marbling, Calving Ease.

107 Beckton Hughes K960 L4

1-A 100% # 4675615 Tattoo: BKT2 K960

Birth: NA

OWN DATA	
BWt	NA
Scr.	36

DAM DATA	
Age	5
Wt	1130
Proj. BW	NA
WR	NA
YR	NA
Udder	Good
Wean Pct.	NA
Cow Eff.	NA

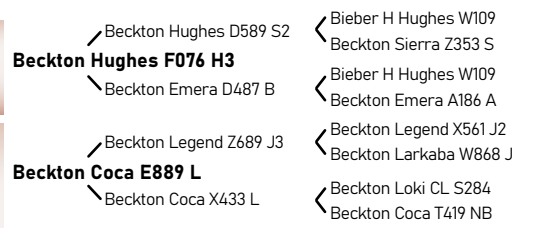

CE	BW	WW	YW	Milk	HPG	Stay	ME	Marb	REA	Bfat	HB	GM
17	-3.0	58	90	24	14	16	4.0	+32	-06	+04	67	21

★★★★★ for Marbling, Calving Ease.

108

BSF Warrior K600 A8

1-B 99% # 4676823 Tattoo: BSF2 K600

Birth: 4-7-22

OWN DATA	
BWt	62
Scr.	36

DAM DATA	
Age	3
Wt	810
Proj. BW	53
WR	93
YR	96

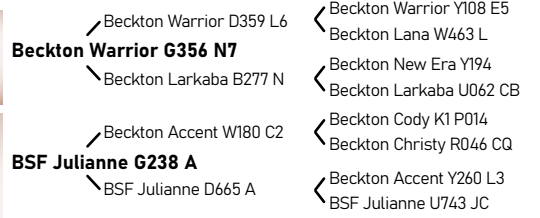

BSF Julianne G238 A													
CE	BW	WW	YW	Milk	HPG	Stay	ME	Marb	REA	Bfat	HB	GM	
17	-4.7	49	81	25	14	18	-2.0	+4.0	-1.0	+0.4	72	35	

★★★★★ for Low Maintenance, Marbling, Calving Ease.

Udder	NA
Wean Pct.	46
Cow Eff.	97

111

Beckton Likable K867 E4

1-A 100% # 4675893 Tattoo: BKT2 K867

Birth: 5-7-22

OWN DATA	
BWt	66
Scr.	36

DAM DATA	
Age	3
Wt	920
Proj. BW	68
WR	108
YR	100

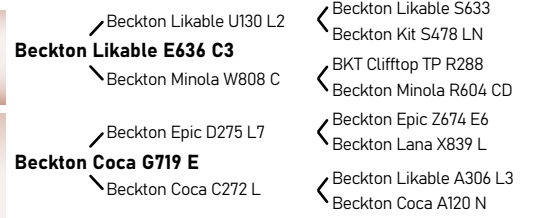

Beckton Coca G719 E													
CE	BW	WW	YW	Milk	HPG	Stay	ME	Marb	REA	Bfat	HB	GM	
16	-3.3	61	91	27	11	15	-2.0	+3.6	+1.5	+0.3	46	18	

★★★★★ for Low Maintenance, Marbling, Rib-eye area, Calving Ease.

Udder	Good
Wean Pct.	49
Cow Eff.	103

109

Beckton Cardinal K754 C2

1-A 100% # 4676335 Tattoo: BSF2 K754

Birth: 4-21-22

OWN DATA	
BWt	53
Scr.	35

DAM DATA	
Age	12
Wt	910
Proj. BW	63
WR	103
YR	104



Beckton Encino X075 C													
CE	BW	WW	YW	Milk	HPG	Stay	ME	Marb	REA	Bfat	HB	GM	
23	-8.9	45	72	29	13	17	1.0	+3.9	-0.3	+0.4	70	26	

★★★★★ for Marbling, Superior Cow, Calving Ease.

Udder	Good
Wean Pct.	48
Cow Eff.	102

112

Beckton New Era K644 L2

1-A 100% # 4675239 Tattoo: BKT2K 644

Birth: 4-11-22

OWN DATA	
BWt	73
Scr.	35

DAM DATA	
Age	9
Wt	975
Proj. BW	63
WR	95
YR	93

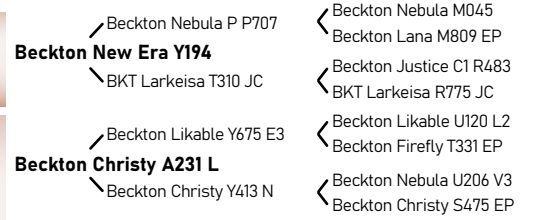

Beckton Christy A231 L													
CE	BW	WW	YW	Milk	HPG	Stay	ME	Marb	REA	Bfat	HB	GM	
15	-3.7	49	77	27	13	20	-5.0	+2.9	-0.5	+0.2	78	13	

★★★★★ for Low Maintenance, Marbling, Calving Ease.

Udder	Good
Wean Pct.	44
Cow Eff.	93

110

Beckton Jet K750 C3

1-A 100% # 4676743 Tattoo: BSF2 K750

Birth: 4-21-22

OWN DATA	
BWt	64
Scr.	38

DAM DATA	
Age	4
Wt	1030
Proj. BW	63
WR	100
YR	99

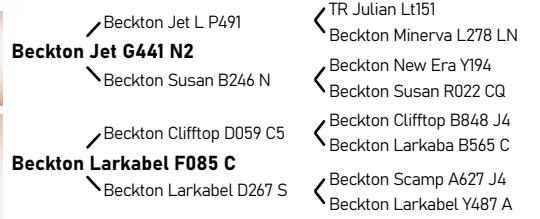

Beckton Larkabel F085 C													
CE	BW	WW	YW	Milk	HPG	Stay	ME	Marb	REA	Bfat	HB	GM	
20	-6.7	48	67	30	12	16	-5.0	+5.2	-0.2	+0.3	61	15	

★★★★★ for Low Maintenance, Marbling, Calving Ease.

Udder	Good
Wean Pct.	44
Cow Eff.	94



Lot 112

113 BSF Julian K125 A9

1-B 99% # 4676881 Tattoo: BSF2 K125

Birth: 3-3-22

OWN DATA	
BWt	49
Scr.	35

DAM DATA	
Age	2
Wt	725
Proj. BW	63
WR	106
YR	100

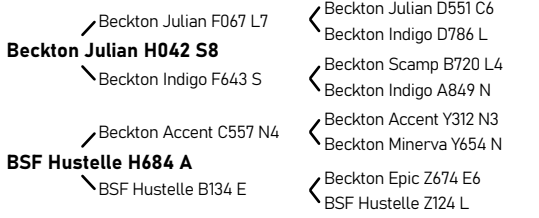

CE	BW	WW	YW	Milk	HPG	Stay	ME	Marb	REA	Bfat	HB	GM
20	-5.8	60	107	28	11	14	10.0	+56	+02	+05	42	61

Udder: **Good**
 Wean Pct.: **53**
 Cow Eff.: **112**
 ★★★★★ for Marbling, Calving Ease.

116 Beckton Likable K941 E5

1-A 100% # 4675633 Tattoo: BKT2 K941

Birth: 6-3-22

OWN DATA	
BWt	NA
Scr.	35

DAM DATA	
Age	4
Wt	825
Proj. BW	59
WR	100
YR	102

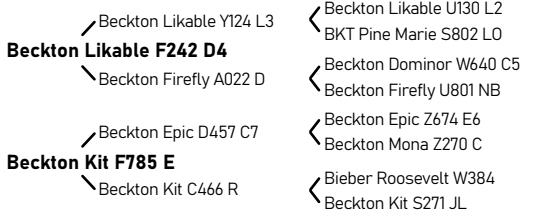

CE	BW	WW	YW	Milk	HPG	Stay	ME	Marb	REA	Bfat	HB	GM
21	-7.5	45	73	28	13	16	-2.0	+36	-.04	+05	69	25

Udder: **Good**
 Wean Pct.: **55**
 Cow Eff.: **117**
 ★★★★★ for Low Maintenance, Marbling, Cow Efficiency, Calving Ease.

115 Beckton Scamp K225 L6

1-A 100% # 4675255 Tattoo: BKT2 K225

Birth: 3-15-22

OWN DATA	
BWt	58
Scr.	39

DAM DATA	
Age	8
Wt	950
Proj. BW	59
WR	93
YR	96

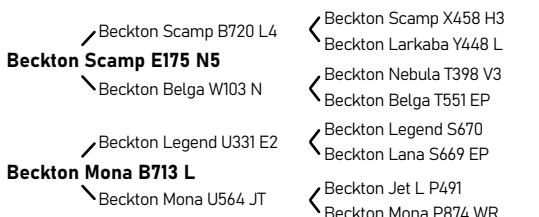

CE	BW	WW	YW	Milk	HPG	Stay	ME	Marb	REA	Bfat	HB	GM
20	-7.5	48	84	26	9	17	-4.0	+40	+09	+03	70	42

Udder: **Good**
 Wean Pct.: **49**
 Cow Eff.: **104**
 ★★★★★ for Low Maintenance, Marbling, Calving Ease.

117 Beckton Nebula K883 L5

1-A 100% # 4676681 Tattoo: BSF2 K883

Birth: 5-11-22

OWN DATA	
BWt	54
Scr.	37

DAM DATA	
Age	4
Wt	980
Proj. BW	64
WR	105
YR	102

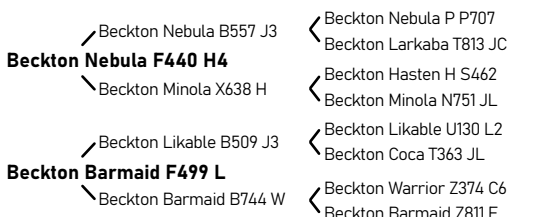

CE	BW	WW	YW	Milk	HPG	Stay	ME	Marb	REA	Bfat	HB	GM
17	-5.4	53	84	27	13	14	1.0	+45	+04	+03	69	41

Udder: **NA**
 Wean Pct.: **45**
 Cow Eff.: **96**
 ★★★★★ for Marbling, Calving Ease.



Lot 115

118 WCRA Likable K202

1-A 100% # 4659685 Tattoo: WCRA2 K202

Birth: 3-16-22

OWN DATA	
BWt	60
Scr.	NA

DAM DATA	
Age	2
Wt	NA
Proj. BW	NA
WR	NA
YR	NA

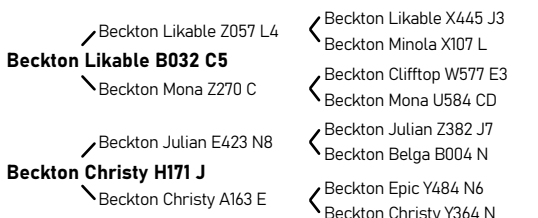

CE	BW	WW	YW	Milk	HPG	Stay	ME	Marb	REA	Bfat	HB	GM
15	-4.2	54	102	20	15	13	2.0	+56	-.22	+04	40	61

Udder: **NA**
 Wean Pct.: **NA**
 Cow Eff.: **NA**
 ★★★★★ for Marbling, Calving Ease.



Lot 118

121 Beckton Scamp K821 J6

1-A 100% # 4675337 Tattoo: BKT2 K821

Birth: 4-29-22

OWN DATA	
BWt	53
Scr.	36

DAM DATA	
Age	7
Wt	1045
Proj. BW	63
WR	102
YR	105

CE	BW	WW	YW	Milk	HPG	Stay	ME	Marb	REA	Bfat	HB	GM
20	-6.7	51	89	27	12	17	1.0	+42	+06	+03	62	49

Udder **Good** ★★★★★ for Marbling, Calving Ease.
Wean Pct. 43
Cow Eff. 91

- Beckton Scamp B720 L4
- Beckton Scamp E175 N5
- Beckton Belga W103 N
- Beckton Scamp X458 H3
- Beckton Larkaba Y448 L
- Beckton Nebula T398 V3
- Beckton Belga T551 EP
- Beckton Julian 7526G
- Bkt Marta 9A13 JL
- Beckton Nebula L P093
- Beckton Angel H164 LO

119 Beckton Warrior K454 L8

1-A 100% # 4676313 Tattoo: BSF2 K454

Birth: 3-30-22

OWN DATA	
BWt	59
Scr.	35

DAM DATA	
Age	12
Wt	1015
Proj. BW	67
WR	103
YR	102

CE	BW	WW	YW	Milk	HPG	Stay	ME	Marb	REA	Bfat	HB	GM
18	-5.2	41	70	28	14	18	1.0	+30	-18	+03	71	28

Udder **Good** ★★★★★ for Marbling, Calving Ease.
Wean Pct. 35
Cow Eff. 73

- Beckton Warrior D359 L6
- Beckton Warrior G356 N7
- Beckton Larkaba B277 N
- Beckton Likable U130 L2
- Beckton Mona X022 L
- Beckton Mona U584 CD
- Beckton Warrior Y108 E5
- Beckton Lana W463 L
- Beckton New Era Y194
- Beckton Larkaba U062 CB
- Beckton Likable S633
- Beckton Kit S478 LN
- Beckton Cody K2 R168
- Beckton Mona P539 CH



Lot 121

120 Beckton Hughes K627 N4

1-A 100% # 4675697 Tattoo: BKT2 K627

Birth: 4-9-22

OWN DATA	
BWt	64
Scr.	33

DAM DATA	
Age	4
Wt	NA
Proj. BW	62
WR	94
YR	97

CE	BW	WW	YW	Milk	HPG	Stay	ME	Marb	REA	Bfat	HB	GM
18	-6.0	47	79	25	15	17	0.0	+39	-03	+04	78	32

Udder **Good** ★★★★★ for Low Maintenance, Marbling, Calving Ease.
Wean Pct. NA
Cow Eff. NA

- Beckton Hughes D589 S2
- Beckton Hughes F076 H3
- Beckton Emera D487 B
- Beckton Nebula B557 J3
- Beckton Larkeisa F336 N
- Beckton Larkeisa Z345 N
- Bieber H Hughes W109
- Beckton Sierra Z353 S
- Bieber H Hughes W109
- Beckton Emera A186 A
- Beckton Nebula P P707
- Beckton Larkaba T813 JC
- Beckton Nebula X267 J3
- Beckton Larkeisa W671 L

122 Beckton Scamp K373 A6

1-A 100% # 4675581 Tattoo: BKT2 K373

Birth: 3-25-22

OWN DATA	
BWt	46
Scr.	39

DAM DATA	
Age	5
Wt	1000
Proj. BW	59
WR	96
YR	100

CE	BW	WW	YW	Milk	HPG	Stay	ME	Marb	REA	Bfat	HB	GM
21	-7.1	46	80	27	10	16	3.0	+43	-03	+03	54	36

Udder **Good** ★★★★★ for Marbling, Calving Ease.
Wean Pct. 44
Cow Eff. 92

- Beckton Scamp B720 L4
- Beckton Scamp E175 N5
- Beckton Belga W103 N
- Beckton Scamp X458 H3
- Beckton Larkaba Y448 L
- Beckton Nebula T398 V3
- Beckton Belga T551 EP
- Beckton Accent Y312 N3
- Beckton Minerva Y654 N
- Beckton Scamp X458 H3
- Beckton Susan Z427 L



Lot 123

125

Beckton Epic K834 E8

1-A 100% # 4675411 Tattoo: BKT2 K834

Birth: 5-1-22

OWN DATA	
BWt	67
Scr.	33

DAM DATA	
Age	6
Wt	1180
Proj. BW	59
WR	98
YR	99

CE	BW	WW	YW	Milk	HPG	Stay	ME	Marb	REA	Bfat	HB	GM
16	-3.8	57	91	28	14	13	0.0	+40	-0.6	+0.3	51	29

Udder **Good** ★★★★★ for Low Maintenance, Marbling, Calving Ease.
Wean Pct. 36
Cow Eff. 76

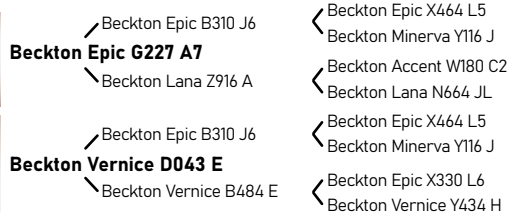

123

Beckton Jet K390 A3

1-A 100% # 4675765 Tattoo: BKT2 K390

Birth: 3-26-22

OWN DATA	
BWt	52
Scr.	34

DAM DATA	
Age	4
Wt	1085
Proj. BW	60
WR	104
YR	101

Udder	Good
Wean Pct.	35
Cow Eff.	73

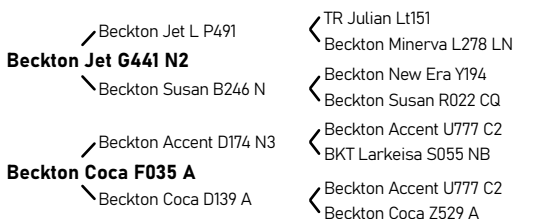

CE	BW	WW	YW	Milk	HPG	Stay	ME	Marb	REA	Bfat	HB	GM
21	-8.5	43	62	29	14	21	-2.0	+53	-2.5	+0.4	93	17

★★★★★ for Low Maintenance, Marbling, Calving Ease.

126

BSF Oracle K944 A3

1-B 99% # 4676891 Tattoo: BSF2 K944

Birth: 6-5-22

OWN DATA	
BWt	NA
Scr.	34

DAM DATA	
Age	2
Wt	700
Proj. BW	NA
WR	102
YR	99

Udder	NA
Wean Pct.	59
Cow Eff.	123

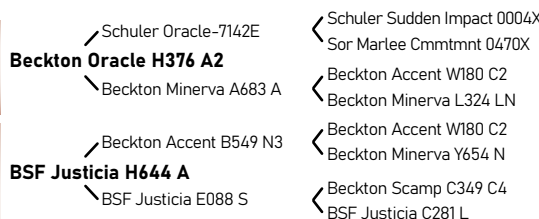

CE	BW	WW	YW	Milk	HPG	Stay	ME	Marb	REA	Bfat	HB	GM
15	-1.5	73	120	26	11	15	8.0	+56	+2.2	+0.3	53	54

★★★★★ for Marbling, Rib-eye area, Cow Efficiency, Calving Ease.

124

Beckton Cardinal K590 N3

1-A 100% # 4675345 Tattoo: BKT2 K590

Birth: 4-7-22

OWN DATA	
BWt	58
Scr.	NA

DAM DATA	
Age	7
Wt	1340
Proj. BW	63
WR	100
YR	98

Udder	NA
Wean Pct.	29
Cow Eff.	60

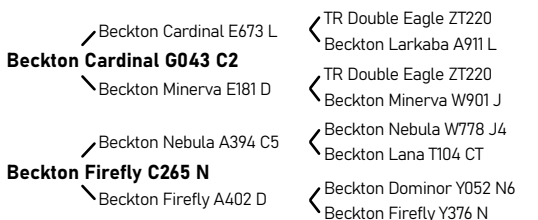

CE	BW	WW	YW	Milk	HPG	Stay	ME	Marb	REA	Bfat	HB	GM
20	-6.0	52	84	26	13	19	0.0	+34	+1.0	+0.3	76	29

★★★★★ for Low Maintenance, Marbling, Calving Ease.

127

Beckton Nebula K807 H5

1-A 100% # 4676319 Tattoo: BSF2 K807

Birth: 4-27-22

OWN DATA	
BWt	56
Scr.	36

DAM DATA	
Age	12
Wt	1110
Proj. BW	70
WR	100
YR	103

Udder	Good
Wean Pct.	37
Cow Eff.	77



CE	BW	WW	YW	Milk	HPG	Stay	ME	Marb	REA	Bfat	HB	GM
17	-6.3	45	75	26	13	17	-3.0	+45	-2.6	+0.4	65	32

★★★★★ for Low Maintenance, Marbling, Calving Ease.

128

Beckton Jet K606 R3

1-A 100% # 4675655 Tattoo: BKT2 K606

Birth: 4-8-22

OWN DATA	
BWt	56
Scr.	34

DAM DATA	
Age	4
Wt	790
Proj. BW	62
WR	95
YR	101

Udder	Good
Wean Pct.	46
Cow Eff.	97

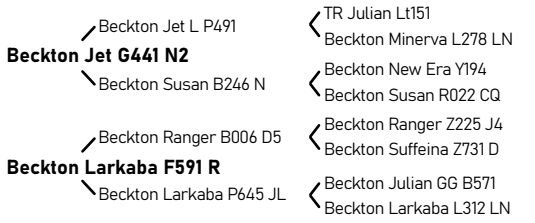

CE	BW	WW	YW	Milk	HPG	Stay	ME	Marb	REA	Bfat	HB	GM
21	-7.9	44	70	28	12	17	-4.0	+5.2	+0.4	+0.3	73	48

★★★★★ for Low Maintenance, Marbling, Calving Ease.

131

Beckton Hughes K820 C4

1-A 100% # 4675877 Tattoo: BKT2 K820

Birth: 4-29-22

OWN DATA	
BWt	70
Scr.	32

DAM DATA	
Age	3
Wt	1065
Proj. BW	66
WR	92
YR	98

Udder	NA
Wean Pct.	35
Cow Eff.	73

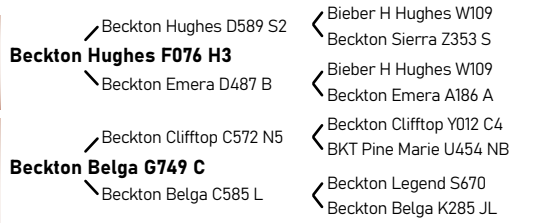

CE	BW	WW	YW	Milk	HPG	Stay	ME	Marb	REA	Bfat	HB	GM
16	-2.6	56	88	26	14	18	-2.0	+3.6	-.03	+0.4	84	29

★★★★★ for Low Maintenance, Marbling, Calving Ease.

129

Beckton Accent K611 C5

1-A 100% # 4675919 Tattoo: BKT2 K611

Birth: 4-8-22

OWN DATA	
BWt	47
Scr.	36

DAM DATA	
Age	3
Wt	810
Proj. BW	47
WR	77
YR	93

Udder	Good
Wean Pct.	45
Cow Eff.	95

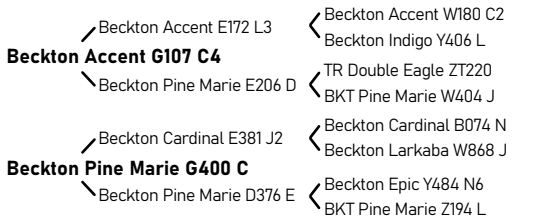

CE	BW	WW	YW	Milk	HPG	Stay	ME	Marb	REA	Bfat	HB	GM
20	-7.6	47	80	26	13	16	-2.0	+4.0	+0.8	+0.3	63	37

★★★★★ for Low Maintenance, Marbling, Calving Ease.

133

Beckton Oracle K260

1-A 100% # NA Tattoo: BKT2 K260

Birth: 3-17-22

OWN DATA	
BWt	67
Scr.	39

DAM DATA	
Age	NA
Wt	NA
Proj. BW	NA
WR	NA
YR	NA

Udder	NA
Wean Pct.	NA
Cow Eff.	NA

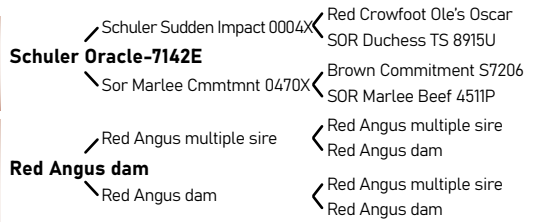

CE	BW	WW	YW	Milk	HPG	Stay	ME	Marb	REA	Bfat	HB	GM
NA	NA	NA	NA	NA	NA	NA	NA	NA	NA	NA	NA	NA

130

Beckton Scamp K355 N6

1-A 100% # 4676371 Tattoo: BSF2 K355

Birth: 3-24-22

OWN DATA	
BWt	54
Scr.	38

DAM DATA	
Age	10
Wt	1210
Proj. BW	64
WR	102
YR	99

Udder	Good
Wean Pct.	34
Cow Eff.	71



CE	BW	WW	YW	Milk	HPG	Stay	ME	Marb	REA	Bfat	HB	GM
20	-7.6	37	57	28	10	17	4.0	+4.3	-.24	+0.2	54	19

★★★★★ for Marbling, Calving Ease.



Lot 130

134 Beckton Likable K912 E5

1-A 100% # 4676695 Tattoo: BSF2 K912

Birth: 5-24-22

OWN DATA	
BWt	NA
Scr.	33

DAM DATA	
Age	4
Wt	900
Proj. BW	58
WR	105
YR	98
Udder	Good
Wean Pct.	51
Cow Eff.	107

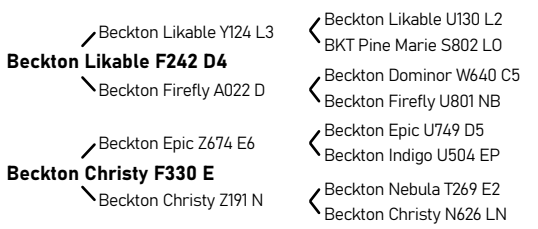

CE	BW	WW	YW	Milk	HPG	Stay	ME	Marb	REA	Bfat	HB	GM
19	-7.0	48	75	30	11	15	-4.0	+47	-06	+05	57	28

★★★★★ for Low Maintenance, Marbling, Calving Ease.



Lot 137

135 BSF Cardinal K262 C3

1-B 99% # 4677055 Tattoo: BSF2 K262

Birth: 3-18-22

OWN DATA	
BWt	45
Scr.	36

DAM DATA	
Age	2
Wt	800
Proj. BW	48
WR	92
YR	87
Udder	Good
Wean Pct.	48
Cow Eff.	101

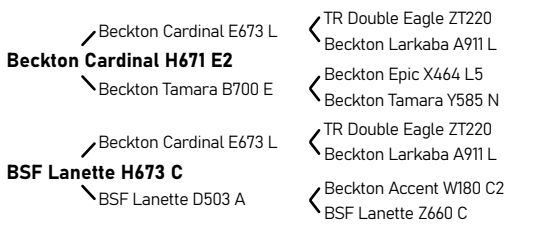

CE	BW	WW	YW	Milk	HPG	Stay	ME	Marb	REA	Bfat	HB	GM
22	-7.4	56	94	28	13	18	-2.0	+54	+17	+05	83	54

★★★★★ for Low Maintenance, Marbling, Rib-eye area, Calving Ease.

137 Beckton Accent K958 C5

1-A 100% # 4676463 Tattoo: BSF2 K958

Birth: NA

OWN DATA	
BWt	NA
Scr.	34

DAM DATA	
Age	7
Wt	910
Proj. BW	65
WR	100
YR	99
Udder	Good
Wean Pct.	NA
Cow Eff.	NA

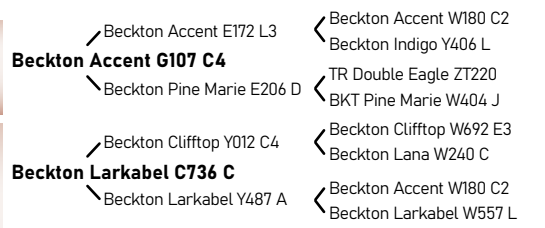

CE	BW	WW	YW	Milk	HPG	Stay	ME	Marb	REA	Bfat	HB	GM
21	-7.1	45	73	32	12	18	-5.0	+38	-13	+04	83	25

★★★★★ for Low Maintenance, Marbling, Calving Ease.

136 Beckton Accent K220 N5

1-A 100% # 4675113 Tattoo: BKT2 K220

Birth: 3-15-22

OWN DATA	
BWt	60
Scr.	34

DAM DATA	
Age	13
Wt	940
Proj. BW	64
WR	107
YR	104
Udder	Poor
Wean Pct.	38
Cow Eff.	80

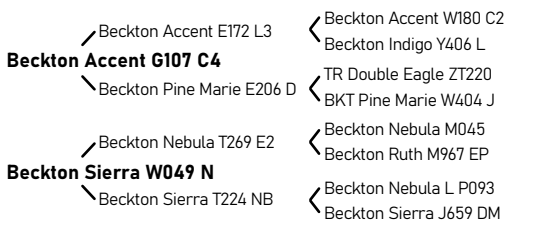

CE	BW	WW	YW	Milk	HPG	Stay	ME	Marb	REA	Bfat	HB	GM
20	-7.0	35	64	33	13	19	-1.0	+44	-16	+03	83	45

★★★★★ for Low Maintenance, Marbling, Superior Cow, Calving Ease.



Lot 136

138

WCRA Dominor K212

1-A 100% # 4659689 Tattoo: WCRA2 K212

Birth: 4-8-22

OWN DATA	
BWt	62
Scr.	NA

DAM DATA	
Age	2
Wt	NA
Proj. BW	NA
WR	NA
YR	NA
Udder	NA
Wean Pct.	NA
Cow Eff.	NA



CE	BW	WW	YW	Milk	HPG	Stay	ME	Marb	REA	Bfat	HB	GM
17	-5.7	53	92	38	13	16	5.0	+48	-.03	+04	59	40

★★★★★ for Marbling, Calving Ease.

142

BSF Epic K087 E9

1-B 99% # 4676895 Tattoo: BSF2 K087

Birth: 2-25-22

OWN DATA	
BWt	75
Scr.	34

DAM DATA	
Age	2
Wt	830
Proj. BW	67
WR	104
YR	102
Udder	NA
Wean Pct.	49
Cow Eff.	104

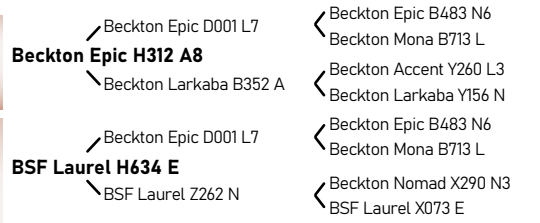

CE	BW	WW	YW	Milk	HPG	Stay	ME	Marb	REA	Bfat	HB	GM
12	-2.0	63	103	29	11	18	8.0	+43	+03	+04	53	36

★★★★★ for Marbling, Calving Ease.

139

BSF Likable K946 E5

1-B 99% # 4676819 Tattoo: BSF2 K946

Birth: 6-6-22

OWN DATA	
BWt	NA
Scr.	35

DAM DATA	
Age	3
Wt	850
Proj. BW	NA
WR	88
YR	93
Udder	Good
Wean Pct.	49
Cow Eff.	102

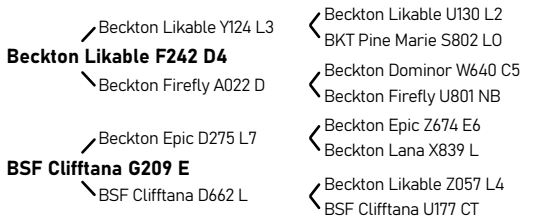

CE	BW	WW	YW	Milk	HPG	Stay	ME	Marb	REA	Bfat	HB	GM
20	-6.7	49	79	26	12	14	-6.0	+38	-.08	+04	51	27

★★★★★ for Low Maintenance, Marbling, Calving Ease.

143

Beckton Cardinal K403 A2

1-A 100% # 4675491 Tattoo: BKT2 K403

Birth: 3-27-22

OWN DATA	
BWt	70
Scr.	36

DAM DATA	
Age	5
Wt	1220
Proj. BW	65
WR	88
YR	101
Udder	NA
Wean Pct.	28
Cow Eff.	60

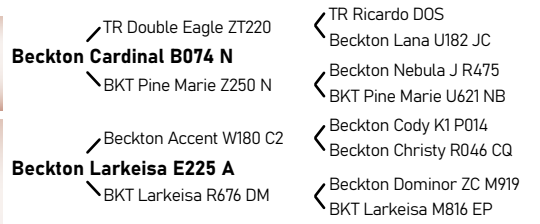

CE	BW	WW	YW	Milk	HPG	Stay	ME	Marb	REA	Bfat	HB	GM
18	-6.0	39	71	26	12	18	-3.0	+42	-.04	+05	71	47

★★★★★ for Low Maintenance, Marbling, Calving Ease.

140

Beckton Julian K857 N8

1-A 100% # 4675563 Tattoo: BKT2 K857

Birth: 5-5-22

OWN DATA	
BWt	61
Scr.	35

DAM DATA	
Age	5
Wt	915
Proj. BW	57
WR	99
YR	98
Udder	Good
Wean Pct.	43
Cow Eff.	91

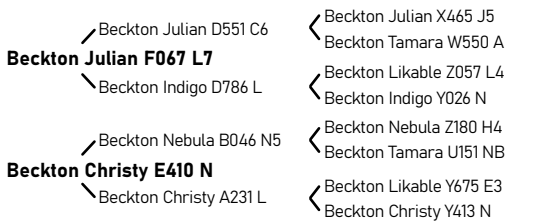

CE	BW	WW	YW	Milk	HPG	Stay	ME	Marb	REA	Bfat	HB	GM
20	-6.0	46	86	25	12	15	0.0	+42	-.07	+03	52	42

★★★★★ for Low Maintenance, Marbling, Calving Ease.



Lot 140

144 Beckton Scamp K732 S7

1-A 100% # 4675621 Tattoo: BKT2 K732

Birth: 4-19-22

OWN DATA	
BWt	58
Scr.	35

DAM DATA	
Age	4
Wt	940
Proj. BW	56
WR	94
YR	95

Udder	Fair
Wean Pct.	41
Cow Eff.	86

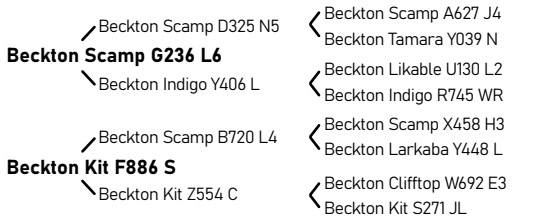

CE	BW	WW	YW	Milk	HPG	Stay	ME	Marb	REA	Bfat	HB	GM
20	-6.2	49	84	27	11	11	-7.0	+31	+17	+03	37	42

★★★★★ for Low Maintenance, Marbling, Rib-eye area, Calving Ease.

147 Beckton Hughes K903 L4

1-A 100% # 4675275 Tattoo: BKT2 K903

Birth: 5-21-22

OWN DATA	
BWt	NA
Scr.	37

DAM DATA	
Age	8
Wt	1045
Proj. BW	68
WR	111
YR	105

Udder	Good
Wean Pct.	49
Cow Eff.	103

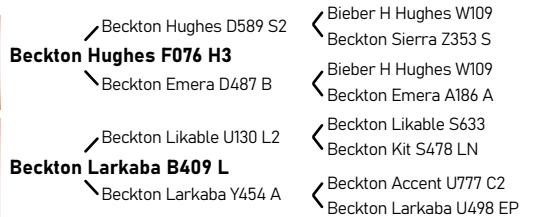

CE	BW	WW	YW	Milk	HPG	Stay	ME	Marb	REA	Bfat	HB	GM
16	-2.8	59	93	29	14	18	0.0	+32	+08	+03	86	25

★★★★★ for Low Maintenance, Marbling, Superior Cow, Calving Ease.



Lot 143

148 Beckton Scamp K742 S6

1-A 100% # 4676683 Tattoo: BSF2 K742

Birth: 4-20-22

OWN DATA	
BWt	45
Scr.	34

DAM DATA	
Age	4
Wt	825
Proj. BW	60
WR	101
YR	102

Udder	NA
Wean Pct.	47
Cow Eff.	98

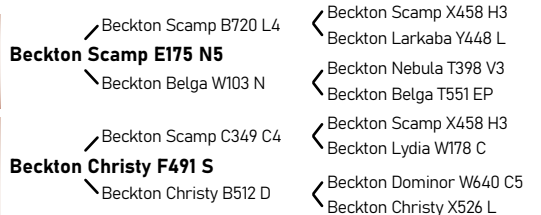

CE	BW	WW	YW	Milk	HPG	Stay	ME	Marb	REA	Bfat	HB	GM
22	-7.8	41	75	28	11	17	2.0	+29	-.08	+03	68	37

★★★★★ for Marbling, Calving Ease.

146 BSF Nebula K917 A5

1-B 99% # 4676549 Tattoo: BSF2 K917

Birth: 5-26-22

OWN DATA	
BWt	NA
Scr.	35

DAM DATA	
Age	6
Wt	1110
Proj. BW	64
WR	102
YR	102

Udder	Good
Wean Pct.	45
Cow Eff.	94

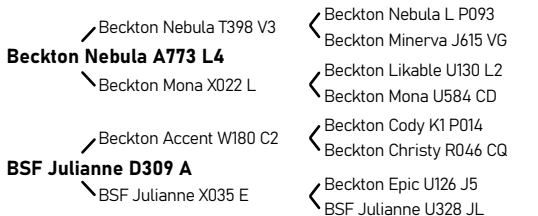

CE	BW	WW	YW	Milk	HPG	Stay	ME	Marb	REA	Bfat	HB	GM
15	-3.6	60	93	28	14	22	-2.0	+38	-.06	+03	96	31

★★★★★ for Low Maintenance, Marbling, Calving Ease.

149 Beckton Cardinal K895 L3

1-A 100% # 4676971 Tattoo: BSF2 K895

Birth: 5-16-22

OWN DATA	
BWt	NA
Scr.	35

DAM DATA	
Age	2
Wt	820
Proj. BW	NA
WR	93
YR	95

Udder	Good
Wean Pct.	43
Cow Eff.	91

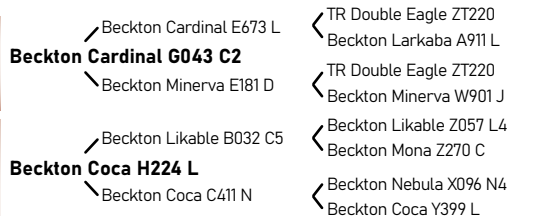

CE	BW	WW	YW	Milk	HPG	Stay	ME	Marb	REA	Bfat	HB	GM
18	-4.2	60	102	29	13	18	9.0	+44	+14	+03	62	46

★★★★★ for Marbling, Rib-eye area, Calving Ease.

Beckton Reference Sires

ID	Name	Reg. No.	Calv.Ease	BW	WW	YW	Milk	HPG	Stay	Maint.En.	Marb	REA	BFat
A-1	Beckton Accent W180 C2	1331776	18	-4.7	62	95	27	15	22	-2.0	+39	+14	+03
A-2	Beckton Accent B549 N3	1705673	13	-2.2	74	126	22	13	16	16.0	+49	+22	+04
A-3	Beckton Accent B740 W3	1705638	20	-6.0	66	103	26	12	13	2.0	+43	+33	+03
A-4	Beckton Accent F602 L3	3987378	18	-4.8	62	100	25	14	19	-5.0	+37	+35	+03
A-5	Beckton Accent G107 C4	4170888	22	-7.3	51	89	33	11	19	0.0	+43	+23	+03
A-6	Beckton Accent G208 N3	4170384	10	1.0	77	127	21	13	16	10.0	+30	+18	+03
A-7	Beckton Accent H059 N5	4378263	19	-4.9	64	119	27	12	16	11.0	+40	+17	+04
A-8	Beckton Accent H121 H5	4377431	18	-3.3	58	95	32	13	15	2.0	+45	+07	+05
A-9	Beckton Accent H410 A4	4378007	16	-4.1	66	108	28	13	17	6.0	+33	+35	+04
B-1	Beckton Hughes F076 H3	3987998	18	-3.9	58	93	26	16	18	3.0	+28	+00	+03
C-1	Beckton Cardinal E673 L	3776785	24	-8.1	64	104	29	13	19	6.0	+59	+36	+04
C-2	Beckton Cardinal G043 C2	4170880	21	-4.8	64	107	30	13	18	8.0	+36	+40	+03
C-3	Beckton Cardinal H671 E2	4376801	18	-4.5	67	114	30	12	17	1.0	+55	+25	+05
D-1	Beckton Dominor F263 N8	3987796	20	-3.8	54	87	36	16	15	2.0	+49	+14	+05
D-2	Beckton Dominor G402 A9	4170856	21	-7.0	48	81	25	13	16	2.0	+37	+13	+05
D-3	Beckton Dominor H382 N7	4377121	13	-3.4	69	119	26	15	15	13.0	+46	-.11	+05
D-4	Beckton Dominor H423 N9	4377997	19	-5.8	51	85	31	13	19	4.0	+43	+05	+04
E-1	Beckton Epic G227 A7	4170306	15	-2.5	67	101	28	14	17	2.0	+37	+01	+03
E-2	Beckton Epic H312 A8	4378077	14	-2.9	65	106	31	11	20	13.0	+41	+11	+05
E-3	Beckton Epic H335 A8	4377181	17	-5.4	64	114	30	12	18	10.0	+39	+15	+05
H-1	Beckton Heritage F615 L5	3988420	9	-2.5	66	97	28	13	16	-6.0	+41	+11	+04
H-2	Beckton Heritage H181 N5	4377359	13	-2.9	60	97	34	11	16	0.0	+29	+11	+04
J-1	Beckton Julian GG B571	387580	20	-7.3	48	75	24	17	14	-7.0	+48	+11	+04
J-2	Beckton Julian Z382 J7	1544962	23	-8.7	57	88	28	14	21	-5.0	+37	-.05	+06
J-3	Beckton Julian E423 N8	3777967	22	-8.3	53	84	27	13	17	1.0	+54	-.30	+05
J-4	Beckton Julian F067 L7	3988836	19	-3.9	60	125	24	13	12	18.0	+51	+05	+04
J-5	Beckton Jet G441 N2	4170464	22	-9.7	49	71	30	12	19	-2.0	+53	-.11	+03
J-6	Beckton Julian H023 E8	4378289	18	-3.4	62	118	28	11	11	8.0	+38	-.01	+03
J-7	Beckton Julian H042 S8	4377525	21	-4.5	65	124	26	14	14	19.0	+52	+10	+04
L-1	Beckton Likable B032 C5	1705725	18	-5.7	52	110	21	15	13	17.0	+58	-.04	+03
L-2	Beckton Likable C229 R3	3487279	10	0.9	77	119	26	11	15	2.0	+37	+42	+03
L-3	Beckton Likable E636 C3	3777515	14	-2.0	60	93	27	13	15	-3.0	+26	+38	+03
L-4	Beckton Likable F287 J6	3987766	18	-5.7	61	109	22	15	17	6.0	+55	-.09	+06
L-5	Beckton Likable G289 J5	4170516	14	-4.1	57	97	26	15	16	-1.0	+48	+09	+03
L-6	Beckton Likable G403 N4	4170280	20	-7.8	55	89	28	9	21	-3.0	+30	+14	+04
L-7	Beckton Likable H518 N5	4376971	11	0.0	73	114	25	12	21	4.0	+46	+01	+04
N-1	Beckton New Era Y194	1451309	15	-3.3	60	97	28	14	20	1.0	+36	-.13	+03
N-2	Beckton Nebula A773 L4	1625980	12	-2.5	65	100	30	14	27	4.0	+30	+01	+04
N-3	Beckton Nebula F440 H4	3988546	14	-3.8	58	91	25	13	16	2.0	+52	-.19	+04
N-4	Beckton Nebula G249 N4	4171298	16	-4.9	49	91	30	14	17	7.0	+58	-.13	+04
N-5	Beckton Nebula H566 L5	4376917	14	-2.3	61	100	33	11	21	10.0	+39	+05	+03
O-1	Redhill 9B Lancer 11E	3627551	8	-0.8	70	106	29	16	13	14.0	+51	-.20	+03
O-2	Schuler Oracle-7142E	3778379	19	-4.3	59	109	21	10	16	5.0	+90	+33	+02
O-3	LSF SRR President 8177F	3925037	15	-4.8	72	106	32	17	19	-9.0	+91	+33	+03
O-4	Beckton Oracle G222 J2	4170878	23	-8.1	55	92	26	12	15	6.0	+72	+15	+04
O-5	Beckton Oracle H390 L2	4377111	16	-1.8	74	128	25	11	18	10.0	+60	+33	+03
R-1	Beckton Ranger G299 N6	4170624	18	-4.8	58	101	30	10	17	2.0	+47	+04	+05
S-1	Beckton Scamp E175 N5	3776509	20	-6.6	50	93	27	9	16	9.0	+45	-.02	+03
S-2	Beckton Scamp G006 C6	4171814	22	-9.1	49	97	29	10	17	10.0	+40	-.02	+03
S-3	Beckton Scamp G236 L6	4165160	19	-5.7	58	97	30	12	12	-7.0	+29	+16	+01
S-4	Beckton Scamp H076 E6	4377489	18	-2.5	69	111	30	8	14	8.0	+29	+18	+02
W-1	Beckton Warrior G356 N7	4171420	16	-3.7	53	90	30	12	16	3.0	+30	-.09	+03

Sale Terms and Conditions

Except for those stated in the terms and conditions below, there are no warranties, either expressed or implied, as to the merchantability or fitness for a particular purpose with respect to the cattle being sold at this auction. The warranties and guarantees set forth in the "Terms and Conditions" are in lieu of all other warranties, either expressed or implied, and the remedies provided therein shall be the sole and exclusive remedy for the Buyer, or any party claiming through Buyer, for any breach of warranty or guarantee therein provided, and all other obligations or liabilities.

The information in the catalog is believed to be accurate, and the information seller believes to be most representative. It is the nature of seller's business that the seller engages in a continual process of collecting new data and information. Therefore, any information presented at the time of sale is always subject to revision, correction or update.

I. BIDDING

The Auctioneer in charge will settle any disputes as to bids, and his decision on such matters shall be final.

II. TERMS

Terms of sale are cash or personal check unless satisfactory credit arrangements have been made with vendor prior to sale.

III. PURCHASER'S RISK

Each animal becomes the risk of the purchaser as soon as sold, but it shall be the obligation of the Seller to see that animals are fed and cared for free of charge to purchaser, until loaded for shipment or until the expiration of 48 hours after the sale, whichever occurs sooner.

IV. DELIVERY

For any animals for which seller's arrange delivery, the following terms shall apply. Each animal becomes the risk of the purchaser as soon as sold, and through the time of delivery. The seller will arrange transportation and delivery schedules, and may combine animals from one or more purchasers for convenience and to reduce costs. If delivery is arranged, seller assumes no other liability. Once the purchaser has been notified of the date and approximate time of delivery (morning, afternoon, evening, etc.), it is the responsibility of the purchaser to arrange adequate and agreeable location and facilities for unloading each animal. When unloaded at the agreed upon location, all care and management of the animal is the responsibility of the purchaser.

V. CERTIFICATE OF REGISTRY

A transferred certificate of registry will be furnished to the purchaser for each animal for which a Registration number is listed.

VI. HEALTH

All animals are eligible for interstate shipment, except as otherwise announced. Interstate health papers will be furnished for each animal requiring T.B, Bang's, and trich tests in accordance with federal and state regulations.

VII. DIVISIBILITY

The percentage of ownership interest received by the buyer, whether it is 100% or 2/3 or otherwise as defined in the catalog or by the auctioneer, may not be subsequently divided without the express written consent of the seller.

VIII. ANNOUNCEMENTS

Any changes from information of any kind in this catalog will be announced from the auction box and such announcements shall take precedence.

IX. BREEDING GUARANTEE

Any female that has had a calf prior to the date of sale shall be considered a breeder without further guarantee. All females sold as 'bred' or 'pregnant' have been pregnancy checked by a licensed veterinarian and are guaranteed bred on the day of sale. The purchaser may elect to have any female so listed rechecked at their cost within 30 days of delivery by a licensed veterinarian of their choice. Any such female determined open by this recheck may be returned to the seller for a full refund. Due to conditions out of seller's control, once a female leaves seller's possession, this is the only guarantee offered.

All bulls are sold as guaranteed breeders. Each bull has been officially fertility tested as "Satisfactory Breeder" prior to the sale. However, seller cannot guarantee against physical injury or illness following the sale. But if within 8 months following the sale, the buyer has evidence that the animal is not a breeder, the buyer may obtain a statement signed by a licensed veterinarian to that effect, such statement also indicating that there has been no injury or illness to the animal following the sale, and return the bull to the farm of the seller for adjustment. If the seller cannot then prove the animal to be a breeder, an adjustment will be made by the seller, either by substituting an animal of equal value, or by the refund of the full purchase price. Such adjustment shall be considered full settlement and satisfaction of all claims. No guarantees apply to animals which are shown following the sale.

X. GENETIC DEFECT GUARANTEE AND PARENTAGE

All parentage and pedigrees presented in the catalog are believed accurate based upon the breeding and DNA information we have available. However, parentage and pedigree information cannot be guaranteed 100%, because it is always possible that new information or new DNA technology and testing might show that there have been inadvertent errors.

Osteopetrosis: The Red Angus Association along with animal scientists have developed a DNA marker test for osteopetrosis (OS), a genetic disorder which in rare instances can cause the loss of a calf at birth. Since the test was developed, Beckton has tested every sire being used in our breeding program. Only one sire, from outside our program, tested positive as a carrier of the gene. Every sire bred and raised at Beckton has tested 'Free'. All of our major semen sires have also been tested 'Free'. We guarantee every sale animal to be OS Free, and if you have a concern, we will have any sale animal tested on request. If an animal were to test positive, we would replace the animal or refund the purchase price. The testing we have done shows no incidence of occurrence in any Beckton bloodlines for the past 30 years, and so we believe there is no safer herd than ours.

XI. RETAINED INTEREST AND SEMEN RIGHTS:

Beckton is selling full possession and one half semen interest in all the bulls in the catalog. Seller is retaining one half interest in all bulls in the catalog. This is done so we can use some of the bulls in herd and reserve the right to collect and market semen on these bulls. Any collection on our behalf would be at our expense and could be done during the off-season and at the convenience of the buyer. The buyer would have the option to share in the collection and retain semen for the buyer's use also. If semen is marketed by either party, Seller receives one half royalty interest on gross semen sales, and buyer receives one half interest. Regardless of semen collection and marketing, the buyer retains full possession, full pasture use rights, and full salvage value in these bulls.

XII. RIGHTS AND OBLIGATIONS

A. The above terms and conditions of sale shall constitute a contract between the Buyer and Seller of each animal and shall be equally binding upon both. Each sale or resale of an animal constitutes a separate transaction.

B. Neither the sale manager, the owner, nor any other person connected with the management of the sale, assumes any liability, legal or otherwise.

Sire Bloodline Charts

Name Family

- Accent A
- Allegiant O
- Cadinal C
- Cherokee C
- Clifftop C
- Clipper A
- Cody A
- Dominor D
- Epic E
- Herald H
- Heritage H
- Hughes B
- Hustler H
- Javelin J
- Jet J
- Julian J
- Lancer L
- RH Lancer O
- Legend L
- Likable L
- Nebula N
- New Era N
- Oracle O
- President O
- Ranger R
- Roosevelt B
- Scamp S
- Warrior W

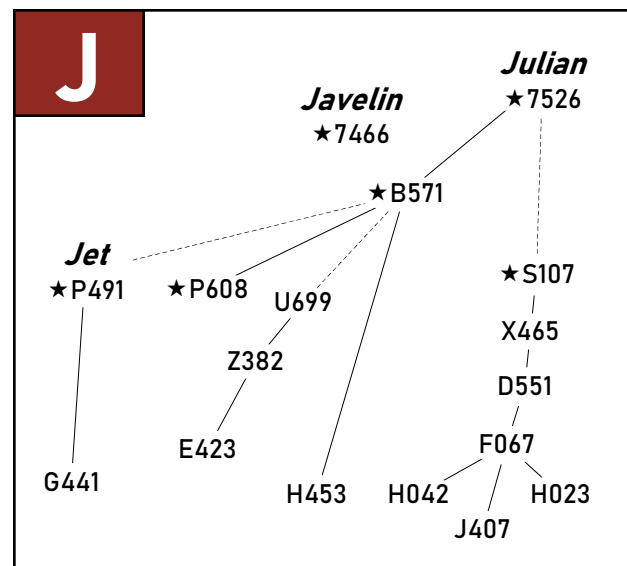
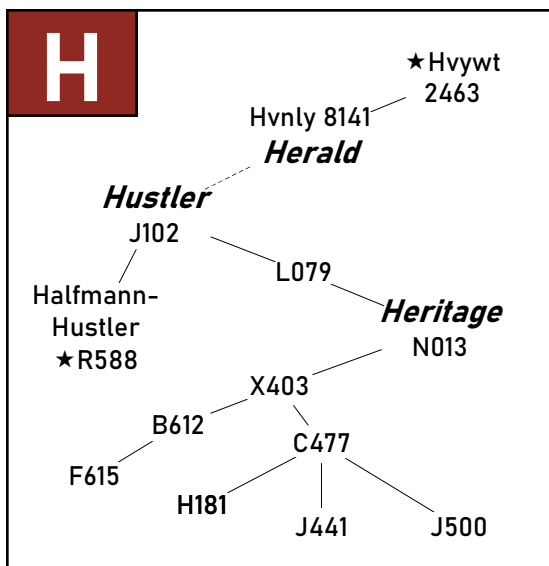
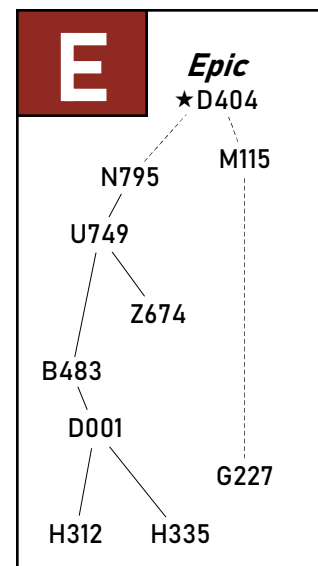
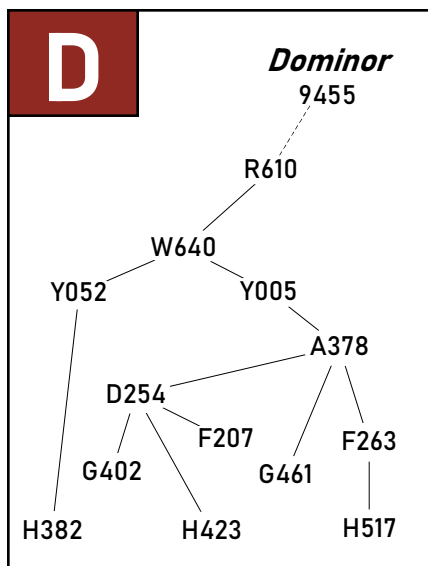
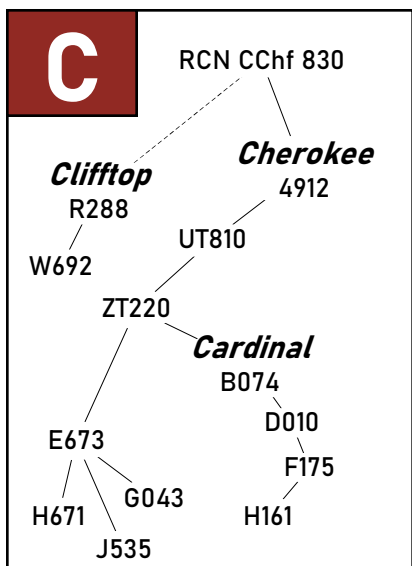
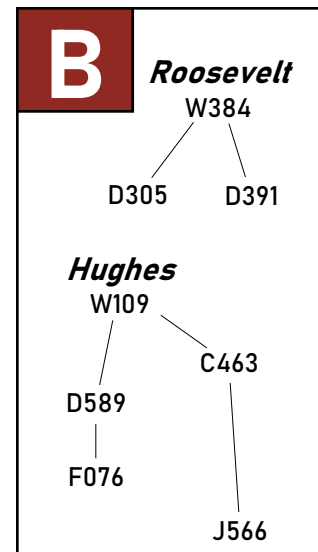
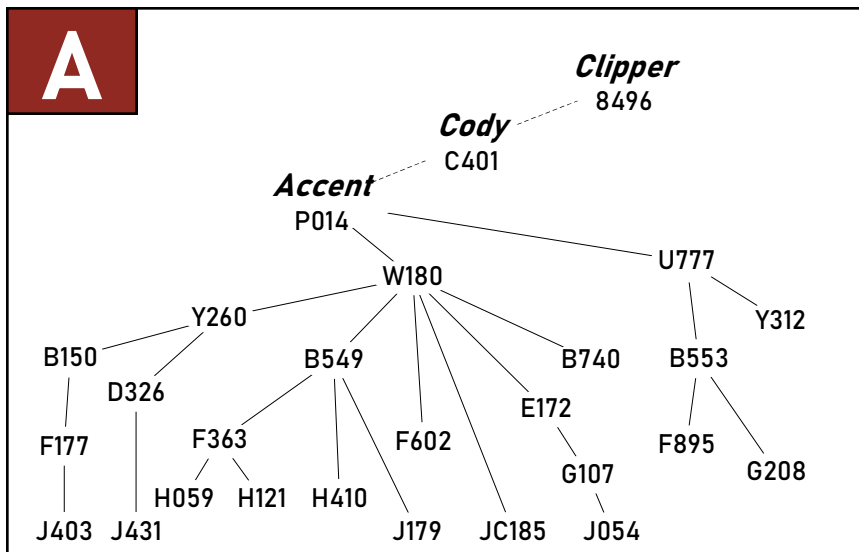

★ Red Angus Trait Leader

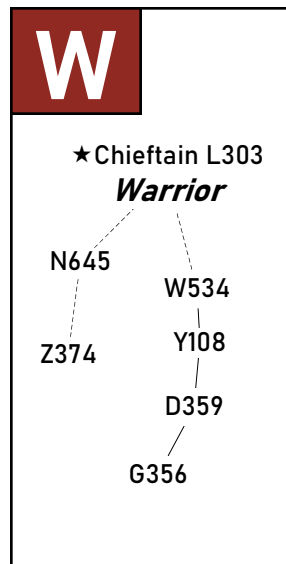
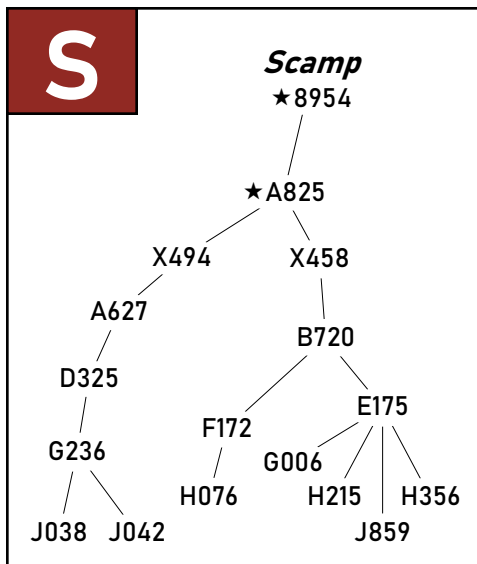
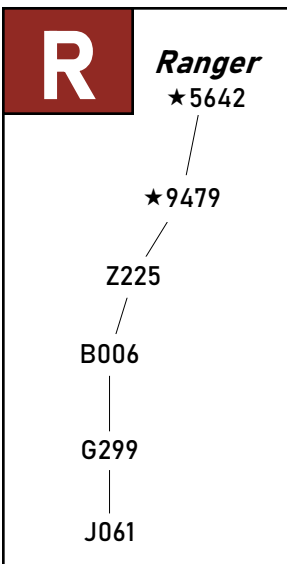
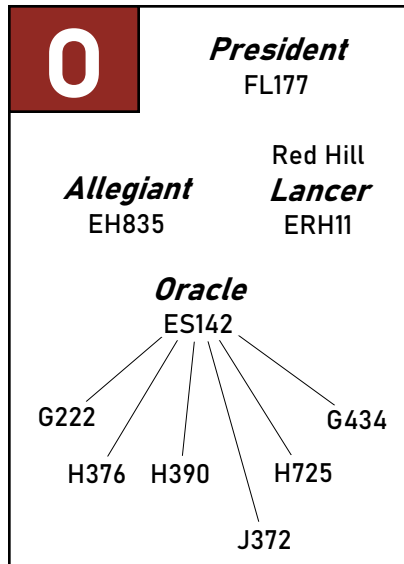
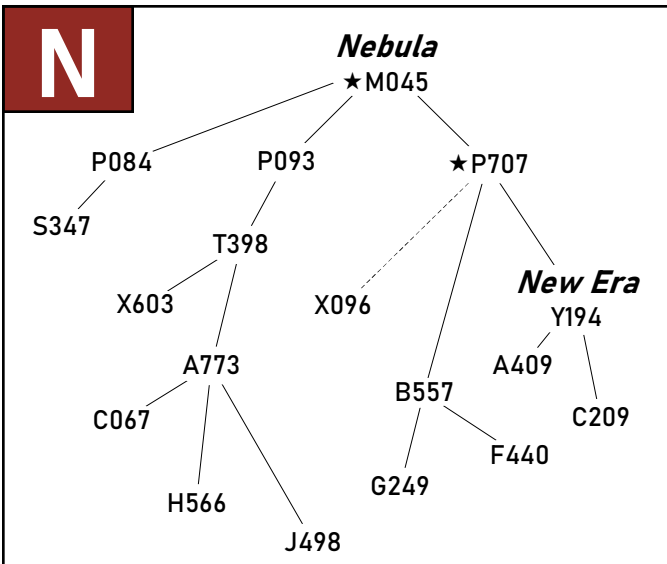
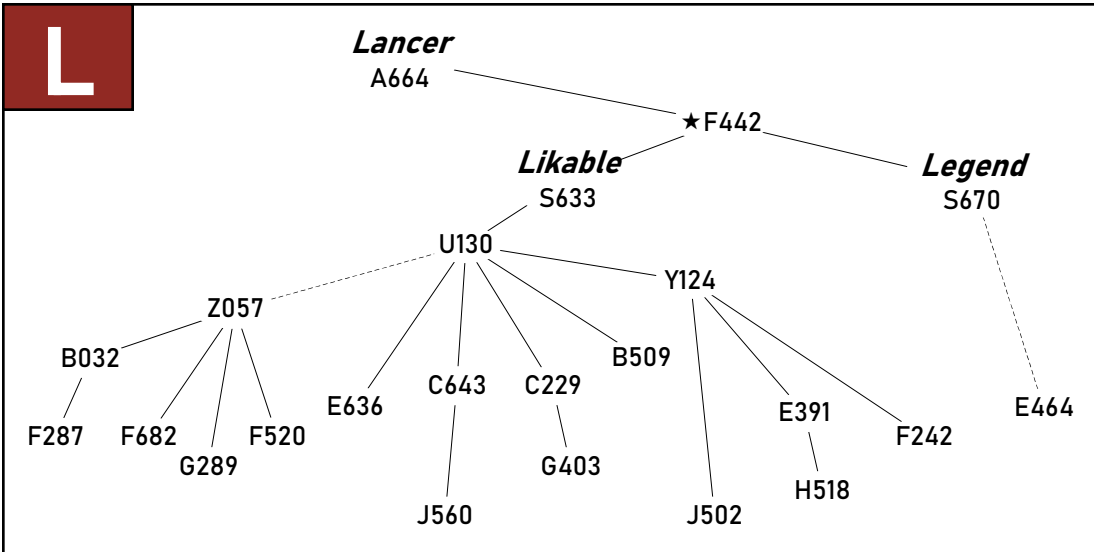

Name	Tag	Family
Nebula	A773	N-2
Likable	B032	L-1
Accent	B549	A-2
Julian	B571	J-1
Accent	B740	A-3
Likable	C229	L-2
Scamp	E175	S-1
Julian	E423	J-3
Likable	E636	L-3
Cardinal	E673	C-1
RH Lancer	ERH11	O-1
Oracle	ES142	O-2
Julian	F067	J-4
Hughes	F076	B-1
Dominor	F263	D-1
Likable	F287	L-4
Nebula	F440	N-3
Accent	F602	A-4
Heritage	F615	H-1
President	FL177	O-3
Scamp	G006	S-2
Cardinal	G043	C-2
Accent	G107	A-5
Accent	G208	A-6
Oracle	G222	O-4
Epic	G227	E-1
Scamp	G236	S-3
Nebula	G249	N-4
Likable	G289	L-5
Ranger	G299	R-1
Warrior	G356	W-1
Dominor	G402	D-2
Likable	G403	L-6
Jet	G441	J-5
Julian	H023	J-6
Julian	H042	J-7
Accent	H059	A-7
Scamp	H076	S-4
Accent	H121	A-8
Heritage	H181	H-2
Epic	H312	E-2
Epic	H335	E-3
Dominor	H382	D-3
Oracle	H390	O-5
Accent	H410	A-9
Dominor	H423	D-4
Likable	H518	L-7
Nebula	H566	N-5
Cardinal	H671	C-3
Accent	W180	A-1
New Erra	Y194	N-1
Julian	Z382	J-2

Lot-Tag Cross Reference

ID	Lot	ID	Lot	ID	Lot	ID	Lot	ID	Lot	ID	Lot	ID	Lot
Registered Cows				Young & Prime Age Herd Bulls				Age-Ready 18-month Bulls					
A048	17-B	C061	8-A	D691	1-B	Z031	24-A	C067	65	K087	142	K750	110
A083	21-A	C066	8-B	D717	1-C	Z059	23-B	E172	67	K096	104	K754	109
A123	18-A	C072	7-B	D793	2-A	Z078	22-A	E175	66	K125	113	K807	127
A172	19-B	C255	12-A	U202	35-B	Z125	24-B	F242	62	K220	136	K820	131
A245	17-A	C265	11-B	W518	35-A	Z227	22-B	F263	63	K225	115	K821	121
A278	21-B	C291	10-B	W536	34-B	Z459	25-B	F367	64	K260	133	K834	125
A446	18-B	C296	10-A	W550	33-A	Z587	25-A	F520	59	K262	135	K857	140
A517	20-B	C414	6-B	W748	34-A	Z639	23-A	F615	61	K355	130	K867	111
A761	20-A	C585	12-B	W756	33-B			F682	60	K373	122	K881	102
A885	19-A	C767	11-A	X339	29-A			G325	57	K390	123	K883	117
B207	16-B	C791	9-A	X450	30-B			G401	56	K403	143	K895	149
B220	15-B	D053	5-C	X510	31-A			G635	58	K422	106	K903	147
B251	13-B	D089	3-A	X529	32-B			H076	51	K454	119	K912	134
B352	14-A	D126	4-B	X642	32-A			H215	52	K590	124	K917	146
B547	15-A	D139	3-B	X675	31-B			H453	53	K600	108	K921	103
B556	14-B	D242	4-A	X785	29-B			H662	54	K606	128	K941	116
B700	13-A	D313	2-B	X808	30-A			H725	55	K611	129	K944	126
B704	16-A	D394	5-A	Y024	26-B					K627	120	K946	139
C003	6-A	D449	5-B	Y027	28-B					K644	112	K958	137
C031	7-A	D563	1-A	Y041	26-A					K732	144	K960	107
C047	9-B	D574	2-C	Y324	27-A					K742	148	KC202	118
		D614	3-C	Y399	27-B							KC212	138
		D682	4-C	Y454	28-A								



Family who help us in many ways over the course of the year



Shelley Forbes and Jason Brown
with Nolan and Emery



Tallie Forbes and Justin Lee
with Claire and Ryan



Don Bingham and Alison Brody with Kate



Morgan Baldwin and Stephen Forbes



Cam and Trish Forbes
wrangling grandkids Claire and Ryan



Doug Foster
and Sarah Forbes



Julia Forbes & Ed Waddington
(with Tazmin and Flinder)



Keenan Forbes and Onn Bunmat, Ellen Durkin,
Jo and Spike Forbes, and Julia and Sarah Durkin



Sheila and Doug Bingham



Elfie Forbes

Thank you!

Beckton Stock Farm

Cam Forbes

37 Beckton Drive

Sheridan, WY 82801

Tel.: 307.674.6095, 674.8162 (evening)

Email: becktonwyo@gmail.com

Web: www.BecktonRedAngus.com

FIRST CLASS

